



SAR TEST REPORT

No. I22Z61006-SEM10

For

BLU Products, Inc

Mobile Phone

Model Name: B200VL

With

Hardware Version: V1.0

Software Version:

BLU_B200VL_V11.0.02.05.02.02

FCC ID: YHLBLUB200VL

Issued Date: 2022-8-17

Note:

The test results in this test report relate only to the devices specified in this report. This report shall not be reproduced except in full without the written approval of CTTL.

Test Laboratory:

CTTL, Telecommunication Technology Labs, CAICT

No. 52, Huayuan North Road, Haidian District, Beijing, P. R. China 100191.

Tel:+86(0)10-62304633-2512, Fax:+86(0)10-62304633-2504

Email: ctl_terminals@caict.ac.cn, website: www.caict.ac.cn

**REPORT HISTORY**

Report Number	Revision	Issue Date	Description
I22Z61006-SEM10	Rev.0	2022-7-27	Initial creation of test report
I22Z61006-SEM10	Rev.1	2022-8-17	Update the low power for WCDMA band 4; Wi-Fi 2.4GHz & Bluetooth can not transmit simultaneously ; update the calibration date for 850MHz dipole

TABLE OF CONTENT

1 TEST LABORATORY	5
1.1 TESTING LOCATION	5
1.2 TESTING ENVIRONMENT.....	5
1.3 PROJECT DATA	5
1.4 SIGNATURE.....	5
2 STATEMENT OF COMPLIANCE	6
3 CLIENT INFORMATION	7
3.1 APPLICANT INFORMATION.....	7
3.2 MANUFACTURER INFORMATION	7
4 EQUIPMENT UNDER TEST (EUT) AND ANCILLARY EQUIPMENT (AE)	8
4.1 ABOUT EUT.....	8
4.2 INTERNAL IDENTIFICATION OF EUT USED DURING THE TEST	8
4.3 INTERNAL IDENTIFICATION OF AE USED DURING THE TEST	8
5 TEST METHODOLOGY	9
5.1 APPLICABLE LIMIT REGULATIONS.....	9
5.2 APPLICABLE MEASUREMENT STANDARDS	9
6 SPECIFIC ABSORPTION RATE (SAR)	10
6.1 INTRODUCTION.....	10
6.2 SAR DEFINITION.....	10
7 TISSUE SIMULATING LIQUIDS	11
7.1 TARGETS FOR TISSUE SIMULATING LIQUID.....	11
7.2 DIELECTRIC PERFORMANCE	11
8 SYSTEM VERIFICATION	15
8.1 SYSTEM SETUP.....	15
8.2 SYSTEM VERIFICATION.....	16
9 GENERAL MEASUREMENT PROCEDURE	17
9.1 <i>POWER REFERENCE MEASUREMENT</i>	17
9.2 <i>AREA SCAN</i>	17
9.3 <i>ZOOM SCAN</i>	18
9.4 <i>POWER DRIFT MEASUREMENT</i>	18
10 MEASUREMENT PROCEDURE FOR DIFFERENT TECHNOLOGIES	19
10.1 WCDMA MEASUREMENT PROCEDURES FOR SAR	19
10.2 LTE MEASUREMENT PROCEDURES FOR SAR.....	21
10.3 BLUETOOTH & WI-FI MEASUREMENT PROCEDURES FOR SAR	21
11 CONDUCTED OUTPUT POWER	22



11.1 WCDMA MEASUREMENT RESULT	22
11.2 LTE MEASUREMENT RESULT	24
11.3 WI-FI AND BT MEASUREMENT RESULT	40
12 ANTENNA LOCATION	42
12.1 TRANSMIT ANTENNA SEPARATION DISTANCES	42
12.2 SAR MEASUREMENT POSITIONS	42
13 SAR TEST RESULT	43
13.1 SAR RESULTS FOR CELLULAR	46
13.2 SAR RESULTS FOR WLAN/BT	48
14 SAR MEASUREMENT VARIABILITY	49
15 EVALUATION OF SIMULTANEOUS	50
15.1 INTRODUCTION	50
15.2 SIMULTANEOUS TRANSMISSION CAPABILITIES	51
15.3 SAR SIMULTANEOUS TRANSMISSION ANALYSIS	51
15.4 CONCLUSION	51
16 MEASUREMENT UNCERTAINTY	52
17 MAIN TEST INSTRUMENTS	52
APPENDIXES	53

1 Test Laboratory

1.1 Testing Location

Company Name:	CTTL
Address:	No. 51 Shouxiang Science Building, Xueyuan Road, Haidian District, Beijing, P. R. China100191

1.2 Testing Environment

Temperature:	18°C~25°C,
Relative humidity:	30%~ 70%
Ground system resistance:	< 0.5 Ω
Ambient noise & Reflection:	< 0.012 W/kg

1.3 Project Data

Project Leader:	Qi Dianyuan
Test Engineer:	Lin Xiaojun
Testing Start Date:	June 20, 2022
Testing End Date:	July 26, 2022

1.4 Signature



Lin Xiaojun

(Prepared this test report)

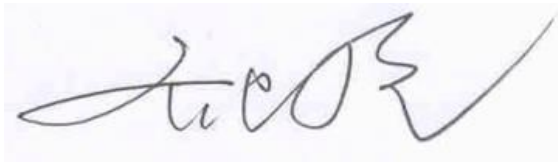

Qi Dianyuan

(Reviewed this test report)

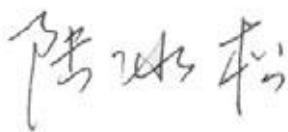

Lu Bingsong

Deputy Director of the laboratory

(Approved this test report)

2 Statement of Compliance

The maximum results of SAR found during testing for BLU Products, Inc. Mobile Phone B200VL is as follows:

Table 2.1: Highest Reported SAR -Standalone

Mode		Highest Reported SAR (1g)	
		1g SAR Head	1g SAR Body 15mm
WCDMA	UMTS FDD 2	0.51	1.34
	UMTS FDD 4	0.24	1.20
	UMTS FDD 5	0.57	0.60
LTE	LTE Band 2	0.83	1.27
	LTE Band 5	0.85	0.48
	LTE Band 12	0.38	0.33
	LTE Band 13	0.66	0.35
	LTE Band 66	0.39	0.97
WLAN 2.4 GHz		0.58	0.07
BT		<0.01	<0.01

The SAR values found for the Mobile Phone are below the maximum recommended levels of 1.6 W/kg as averaged over any 1g tissue according to the ANSI C95.1-1992.

For body operation, this device has been tested and meets FCC RF exposure guidelines when used with any accessory that contains no metal and which provides a minimum separation distance of 15mm for body worn between this device and the body of the user. Use of other accessories may not ensure compliance with FCC RF exposure guidelines.

The EUT battery must be fully charged and checked periodically during the test to ascertain uniform power output.

The measurement together with the test system set-up is described in annex C. A detailed description of the equipment under test can be found in chapter 4 of this test report.

Table 2.2: Highest Reported SAR -Simultaneous transmission

reported SAR 1g (W/kg)				
Head		LTEB5	WiFi2.4G	WWAN+WiFi2.4G
Right	Cheek	0.85	0.58	1.43
Body		WCDMA1900	WiFi2.4G	WWAN+WiFi2.4G
Close Rear	15mm	1.34	0.07	1.41

The detail for simultaneous transmission consideration is described in chapter 15.

The highest reported SAR for Head, Body Worn, and Simultaneous transmission exposure conditions are 0.85W/kg, 1.34W/kg and 1.43W/kg.



3 Client Information

3.1 Applicant Information

Company Name:	BLU Products,Inc.
Address /Post:	10814 NW 33rd St # 100 Doral, FL 33172,USA
Contact Person:	Zeng wei
E-mail:	zwei@ctasiasz.com
Telephone:	305.715.7171
Fax:	305.436.8819

3.2 Manufacturer Information

Company Name:	BLU Products,Inc.
Address /Post:	10814 NW 33rd St # 100 Doral, FL 33172,USA
Contact Person:	Zeng wei
E-mail:	zwei@ctasiasz.com
Telephone:	305.715.7171
Fax:	305.436.8819

4 Equipment Under Test (EUT) and Ancillary Equipment (AE)

4.1 About EUT

Description:	Mobile Phone
Model name:	B200VL
Operating mode(s):	WCDMA850/1700/1900,BT,Wi-Fi2.4G, LTE Band 2/5/12/13/66
Tested Tx Frequency:	824–849 MHz (WCDMA 850 Band V)
	1710 – 1755 MHz (WCDMA 1700 Band IV)
	1850–1910 MHz (WCDMA1900 Band II)
	1850 – 1910 MHz(LTE Band 2)
	824 – 849 MHz (LTE Band 5)
	699 – 716 MHz (LTE Band 12)
	779.5 – 784.5 MHz (LTE Band 13)
	1710.7 – 1779.3 MHz (LTE Band 66)
	2402 – 2480 MHz (Bluetooth)
2412 – 2462 MHz (Wi-Fi 2.4G)	
Antenna type:	Integrated antenna
Hotspot mode:	Not Support

4.2 Internal Identification of EUT used during the test

EUT ID*	IMEI	HW	SW Version
EUT1	357173130002730	V1.0	BLU_B200VL_V11.0.02.05.02.02
EUT2	357173130006194	V1.0	BLU_B200VL_V11.0.02.05.02.02
EUT3	357173130005832	V1.0	BLU_B200VL_V11.0.02.05.02.02

*EUT ID: is used to identify the test sample in the lab internally.

Note: It is performed to test SAR with the EUT1 and conducted power with the EUT2~3

4.3 Internal Identification of AE used during the test

AE ID*	Description	Model	SN	Manufacturer
AE1	Battery	LT25H426271B	\	GUANGDONG FENGHUA NEW ENERGY CO.,LTD.

*AE ID: is used to identify the test sample in the lab internally.

5 TEST METHODOLOGY

5.1 Applicable Limit Regulations

ANSI C95.1–1992:IEEE Standard for Safety Levels with Respect to Human Exposure to Radio Frequency Electromagnetic Fields, 3 kHz to 300 GHz.

It specifies the maximum exposure limit of **1.6 W/kg** as averaged over any 1 gram of tissue for portable devices being used within 20 cm of the user in the uncontrolled environment.

5.2 Applicable Measurement Standards

IEEE 1528–2013: Recommended Practice for Determining the Peak Spatial-Average Specific Absorption Rate (SAR) in the Human Head from Wireless Communications Devices: Measurement Techniques.

KDB447498 D01: General RF Exposure Guidance v06: Mobile and Portable Devices RF Exposure Procedures and Equipment Authorization Policies.

KDB648474 D04 Handset SAR v01r03: SAR Evaluation Considerations for Wireless Handsets.

KDB941225 D01 SAR test for 3G devices v03r01: SAR Measurement Procedures for 3G Devices

KDB941225 D05 SAR for LTE Devices v02r05: SAR Evaluation Considerations for LTE Devices

KDB248227 D01 802.11 Wi-Fi SAR v02r02: SAR GUIDANCE FOR IEEE 802.11 (Wi-Fi) TRANSMITTERS

KDB865664 D01 SAR measurement 100 MHz to 6 GHz v01r04: SAR Measurement Requirements for 100 MHz to 6 GHz.

KDB865664 D02 RF Exposure Reporting v01r02: RF Exposure Compliance Reporting and Documentation Considerations

6 Specific Absorption Rate (SAR)

6.1 Introduction

SAR is related to the rate at which energy is absorbed per unit mass in an object exposed to a radio field. The SAR distribution in a biological body is complicated and is usually carried out by experimental techniques or numerical modeling. The standard recommends limits for two tiers of groups, occupational/controlled and general population/uncontrolled, based on a person's awareness and ability to exercise control over his or her exposure. In general, occupational/controlled exposure limits are higher than the limits for general population/uncontrolled.

6.2 SAR Definition

The SAR definition is the time derivative (rate) of the incremental energy (dW) absorbed by (dissipated in) an incremental mass (dm) contained in a volume element (dv) of a given density (ρ). The equation description is as below:

$$SAR = \frac{d}{dt} \left(\frac{dW}{dm} \right) = \frac{d}{dt} \left(\frac{dW}{\rho dv} \right)$$

SAR is expressed in units of Watts per kilogram (W/kg)

SAR measurement can be either related to the temperature elevation in tissue by

$$SAR = c \left(\frac{\delta T}{\delta t} \right)$$

Where: C is the specific heat capacity, δT is the temperature rise and δt is the exposure duration, or related to the electrical field in the tissue by

$$SAR = \frac{\sigma |E|^2}{\rho}$$

Where: σ is the conductivity of the tissue, ρ is the mass density of tissue and E is the RMS electrical field strength.

However for evaluating SAR of low power transmitter, electrical field measurement is typically applied.

7 Tissue Simulating Liquids

The temperature of the tissue-equivalent medium used during measurement must also be within 18 °C to 25 °C and within ± 2 °C of the temperature when the tissue parameters are characterized. The dielectric parameters must be measured before the tissue-equivalent medium is used in a series of SAR measurements. The parameters should be re-measured after each 3 – 4 days of use; or earlier if the dielectric parameters can become out of tolerance; for example, when the parameters are marginal at the beginning of the measurement series.

The dielectric constant (ϵ_r) and conductivity (σ) of typical tissue-equivalent media recipes are expected to be within $\pm 5\%$ of the required target values; but for SAR measurement systems that have implemented the SAR error compensation algorithms documented in IEEE Std 1528-2013, to automatically compensate the measured SAR results for deviations between the measured and required tissue dielectric parameters, the tolerance for ϵ_r and σ may be relaxed to $\pm 10\%$. This is limited to frequencies ≤ 3 GHz.

7.1 Targets for tissue simulating liquid

Table 7.1: Targets for tissue simulating liquid

Frequency(MHz)	Liquid Type	Conductivity(σ)	$\pm 10\%$ Range	Permittivity(ϵ)	$\pm 10\%$ Range
750	Head	0.89	0.80~0.98	41.94	37.75~46.13
835	Head	0.90	0.81~0.99	41.5	37.35~45.65
1750	Head	1.37	1.26~1.54	40.0	36~44
1900	Head	1.40	1.26~1.54	40.0	36~44
2450	Head	1.80	1.62~1.98	39.2	35.28~43.12

7.2 Dielectric Performance

Table 7.2: Dielectric Performance of Tissue Simulating Liquid

Measurement Date (yyyy-mm-dd)	Type	Frequency	Permittivity ϵ	Drift (%)	Conductivity σ (S/m)	Drift (%)
2022/6/27	Head	750MHz	43.34	3.34%	0.8777	-1.38%
2022/7/1	Head	835 MHz	43.06	3.76%	0.9099	1.10%
2022/7/10	Head	1750MHz	41.07	2.47%	1.37	0.00%
2022/7/12	Head	1900 MHz	40.89	2.23%	1.466	4.71%
2022/7/5	Head	2450 MHz	40.08	2.24%	1.866	3.67%

Note: The liquid temperature is 22.0°C

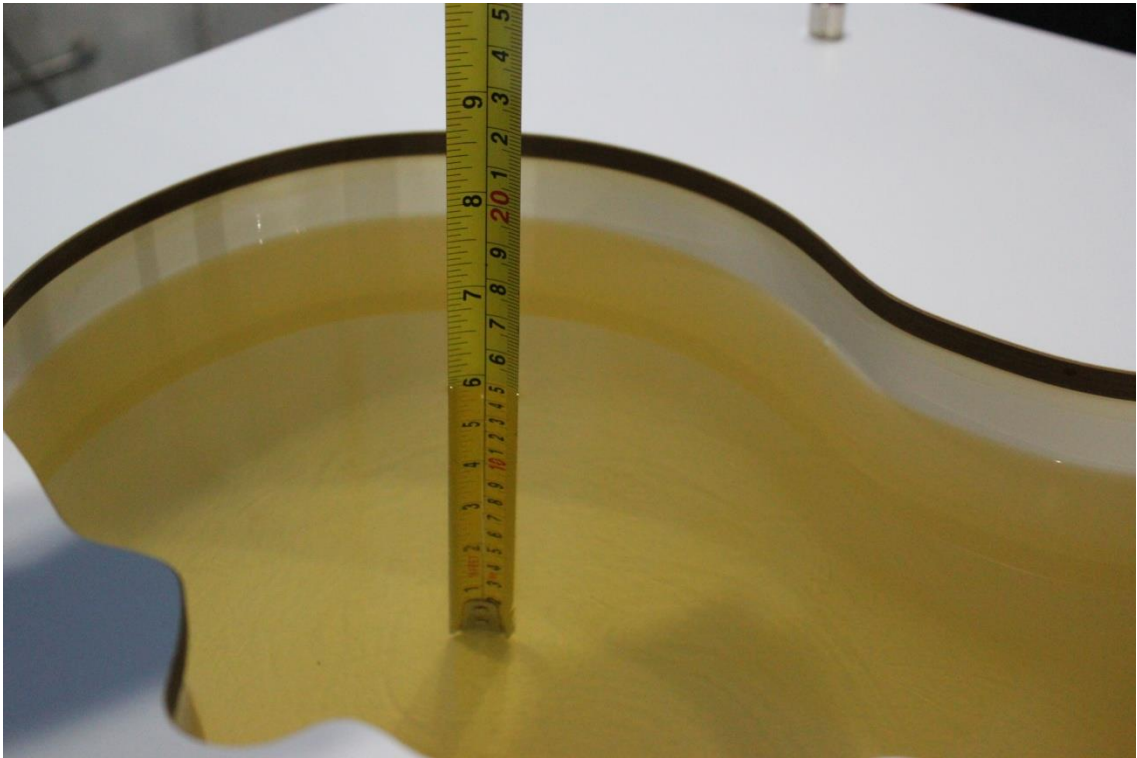

Picture 7-1 Liquid depth in the Head Phantom (750MHz)

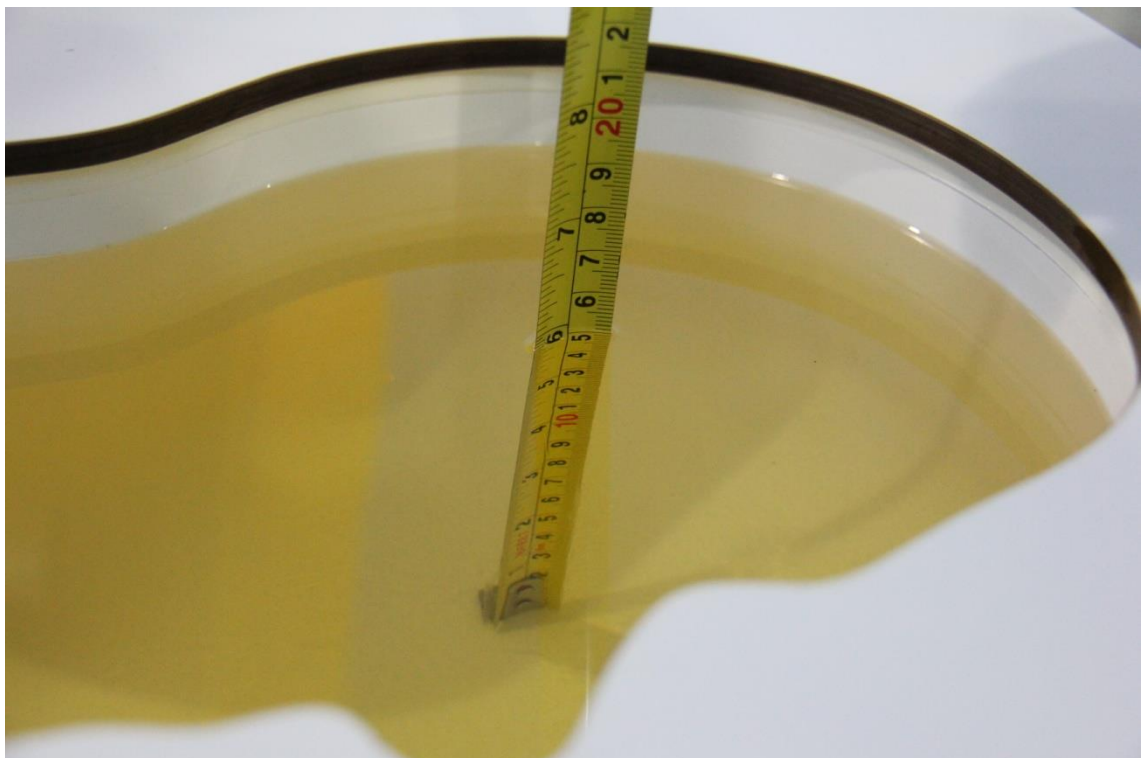

Picture 7-2 Liquid depth in the Head Phantom (835 MHz)

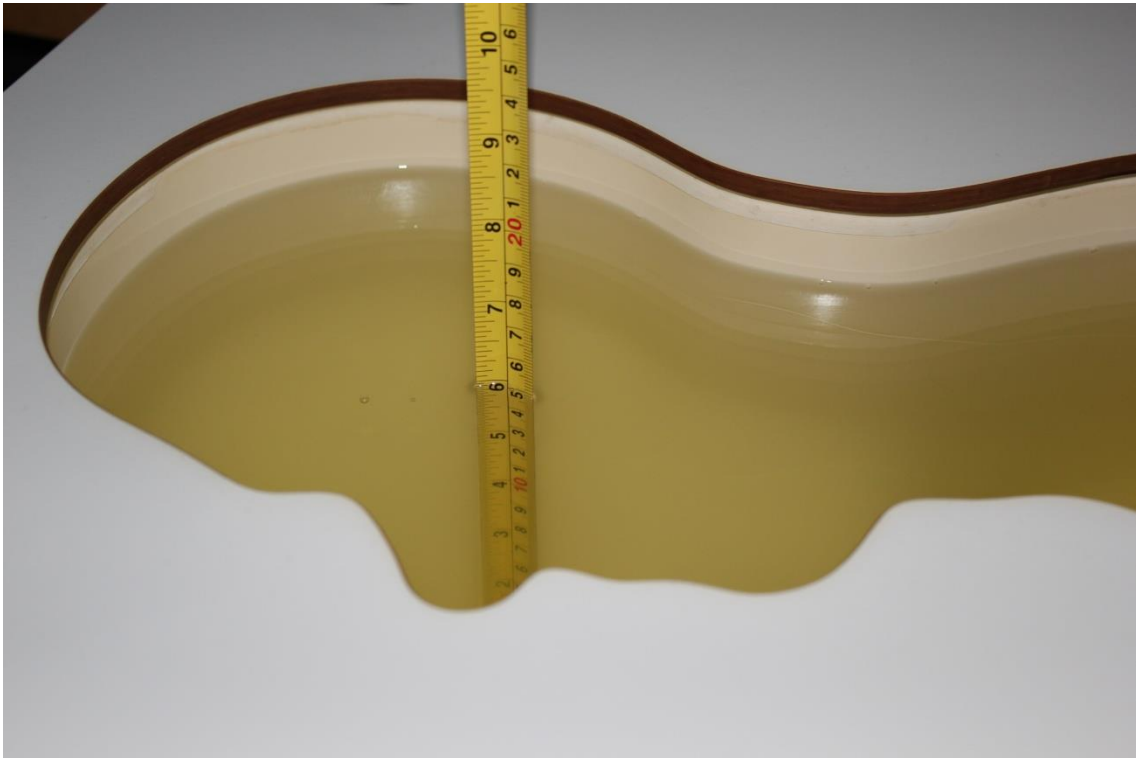

Picture 7-3 Liquid depth in the Head Phantom (1750 MHz)



Picture 7-4 Liquid depth in the Head Phantom (1900 MHz)

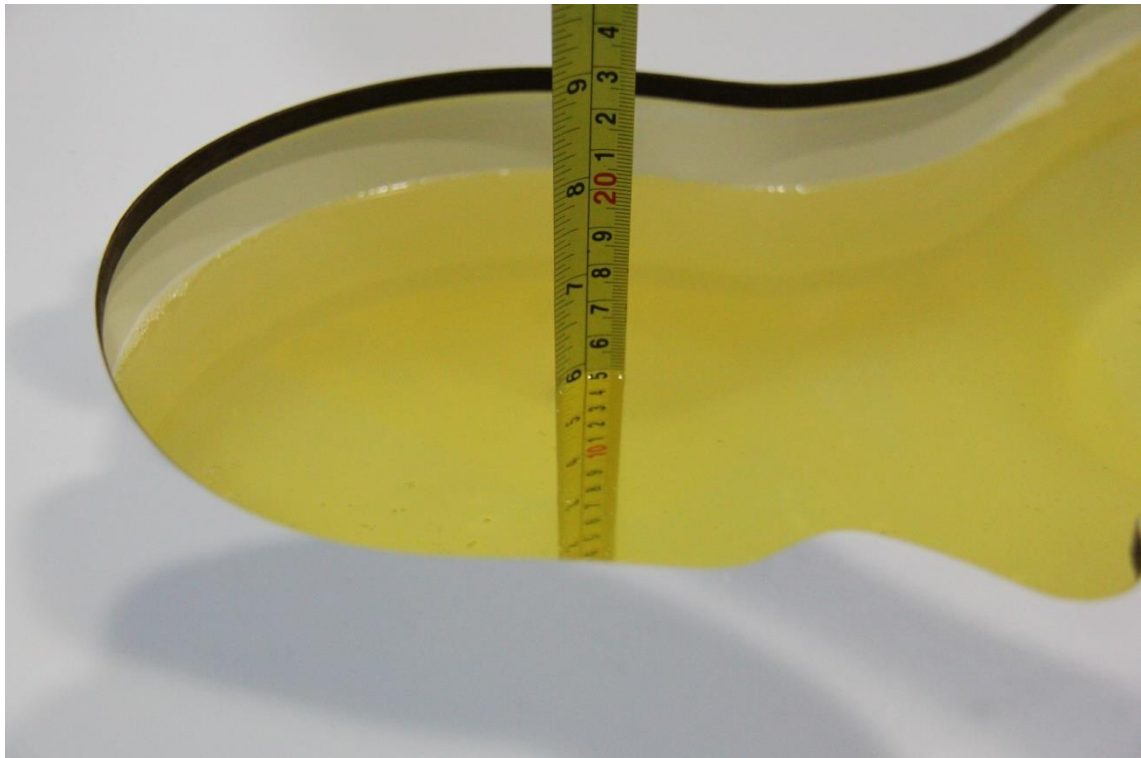

Picture 7-5 Liquid depth in the Head Phantom (2450MHz)

8 System verification

8.1 System Setup

In the simplified setup for system evaluation, the DUT is replaced by a calibrated dipole and the power source is replaced by a continuous wave that comes from a signal generator. The calibrated dipole must be placed beneath the flat phantom section of the SAM twin phantom with the correct distance holder. The distance holder should touch the phantom surface with a light pressure at the reference marking and be oriented parallel to the long side of the phantom. The equipment setup is shown below:

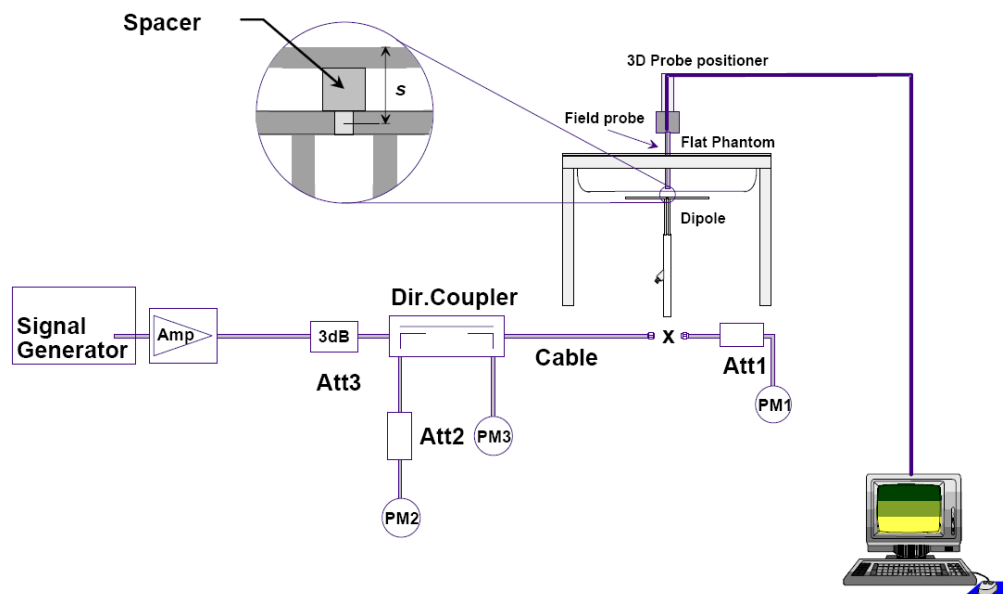

Picture 8.1 System Setup for System Evaluation



Picture 8.2 Photo of Dipole Setup

8.2 System Verification

SAR system verification is required to confirm measurement accuracy, according to the tissue dielectric media, probe calibration points and other system operating parameters required for measuring the SAR of a test device. The system verification must be performed for each frequency band and within the valid range of each probe calibration point required for testing the device.

Table 8.1: System Verification of Head

Measurement Date (yyyy-mm-dd)	Frequency	Target value (W/kg)	Measured value(W/kg)	Deviation
		1 g Average	1 g Average	1 g Average
2022/6/27	750 MHz	8.68	9.12	5.07%
2022/7/1	835 MHz	9.63	8.72	-9.45%
2022/7/10	1750 MHz	36.9	34.4	-6.67%
2022/7/12	1900 MHz	40.1	36.3	-9.53%
2022/7/5	2450 MHz	53.3	50.0	-6.19%

9 General Measurement Procedure

9.1 Power Reference Measurement

The Power Reference Measurement and Power Drift Measurements are for monitoring the power drift of the device under test in the batch process. The minimum distance of probe sensors to surface determines the closest measurement point to phantom surface. This distance cannot be smaller than the distance of sensor calibration points to probe tip as defined in the probe properties.

9.2 Area Scan

The area scan is used as a fast scan in two dimensions to find the area of high field values, before doing a fine measurement around the hot spot. The sophisticated interpolation routines implemented in DASY software can find the maximum found in the scanned area, within a range of the global maximum. The range (in dB) is specified in the standards for compliance testing. For example, a 2 dB range is required in IEEE standard 1528 and IEC 62209 standards, whereby 3 dB is a requirement when compliance is assessed in accordance with the ARIB standard (Japan), if only one zoom scan follows the area scan, then only the absolute maximum will be taken as reference. For cases where multiple maximums are detected, the number of zoom scans has to be increased accordingly.

Area scan parameters extracted from FCC KDB 865664 D01v01r04 SAR measurement 100 MHz to 6 GHz.

	≤ 3 GHz	> 3 GHz
Maximum distance from closest measurement point (geometric center of probe sensors) to phantom surface	5 ± 1 mm	$\frac{1}{2} \cdot \delta \cdot \ln(2) \pm 0.5$ mm
Maximum probe angle from probe axis to phantom surface normal at the measurement location	30° ± 1°	20° ± 1°
Maximum area scan spatial resolution: Δx_{Area} , Δy_{Area}	≤ 2 GHz: ≤ 15 mm 2 – 3 GHz: ≤ 12 mm	3 – 4 GHz: ≤ 12 mm 4 – 6 GHz: ≤ 10 mm
	When the x or y dimension of the test device, in the measurement plane orientation, is smaller than the above, the measurement resolution must be ≤ the corresponding x or y dimension of the test device with at least one measurement point on the test device.	

9.3 Zoom Scan

Zoom Scans are used to assess the peak spatial SAR values within a cubic averaging volume containing 1 g and 10g of simulated tissue. The Zoom Scan measures points (refer to table below) within a cube whose base faces are centered on the maxima found in a preceding area scan job within the same procedure. When the measurement is done, the Zoom Scan evaluates the averaged SAR for 1 g and 10 g and displays these values next to the job' s label.

Zoom Scan Parameters extracted from KDB 865664 D01 SAR Measurement 100 MHz to 6 GHz

Maximum zoom scan spatial resolution: $\Delta x_{Zoom}, \Delta y_{Zoom}$		≤ 2 GHz: ≤ 8 mm 2 – 3 GHz: ≤ 5 mm*	3 – 4 GHz: ≤ 5 mm* 4 – 6 GHz: ≤ 4 mm*
Maximum zoom scan spatial resolution, normal to phantom surface	uniform grid: $\Delta z_{Zoom}(n)$	≤ 5 mm	3 – 4 GHz: ≤ 4 mm 4 – 5 GHz: ≤ 3 mm 5 – 6 GHz: ≤ 2 mm
	graded grid	$\Delta z_{Zoom}(1)$: between 1 st two points closest to phantom surface	≤ 4 mm 3 – 4 GHz: ≤ 3 mm 4 – 5 GHz: ≤ 2.5 mm 5 – 6 GHz: ≤ 2 mm
		$\Delta z_{Zoom}(n>1)$: between subsequent points	$\leq 1.5 \cdot \Delta z_{Zoom}(n-1)$
Minimum zoom scan volume	x, y, z	≥ 30 mm	3 – 4 GHz: ≥ 28 mm 4 – 5 GHz: ≥ 25 mm 5 – 6 GHz: ≥ 22 mm
Note: δ is the penetration depth of a plane-wave at normal incidence to the tissue medium; see draft standard IEEE P1528-2011 for details. * When zoom scan is required and the <i>reported</i> SAR from the <i>area scan based 1-g SAR estimation</i> procedures of KDB 447498 is ≤ 1.4 W/kg, ≤ 8 mm, ≤ 7 mm and ≤ 5 mm zoom scan resolution may be applied, respectively, for 2 GHz to 3 GHz, 3 GHz to 4 GHz and 4 GHz to 6 GHz.			

9.4 Power drift measurement

The Power Drift Measurement measures the field at the same location as the most recent power reference measurement within the same procedure, and with the same settings. The Power Drift Measurement gives the field difference in dB from the reading conducted within the last Power Reference Measurement. This allows a user to monitor the power drift of the device under test within a batch process. The measurement procedure is the same as 9.1.

10 Measurement Procedure for different technologies

10.1 WCDMA Measurement Procedures for SAR

The following procedures are applicable to WCDMA handsets operating under 3GPP Release99, Release 5 and Release 6. The default test configuration is to measure SAR with an established radio link between the DUT and a communication test set using a 12.2kbps RMC (reference measurement channel) configured in Test Loop Mode 1. SAR is selectively confirmed for other physical channel configurations (DPCCH & DPDCH_n), HSDPA and HSPA (HSUPA/HSDPA) modes according to output power, exposure conditions and device operating capabilities. Both uplink and downlink should be configured with the same RMC or AMR, when required. SAR for Release 5 HSDPA and Release 6 HSPA are measured using the applicable FRC (fixed reference channel) and E-DCH reference channel configurations. Maximum output power is verified according to applicable versions of 3GPP TS 34.121 and SAR must be measured according to these maximum output conditions. When Maximum Power Reduction (MPR) is not implemented according to Cubic Metric (CM) requirements for Release 6 HSPA, the following procedures do not apply.

For Release 5 HSDPA Data Devices:

Sub-test	β_c	β_d	β_d (SF)	β_c / β_d	β_{hs}	CM/dB
1	2/15	15/15	64	2/15	4/15	0.0
2	12/15	15/15	64	12/15	24/25	1.0
3	15/15	8/15	64	15/8	30/15	1.5
4	15/15	4/15	64	15/4	30/15	1.5

For Release 6 HSPA Data Devices

Sub-test	β_c	β_d	β_d (SF)	β_c / β_d	β_{hs}	β_{ec}	β_{ed}	β_{ed} (SF)	β_{ed} (codes)	CM (dB)	MPR (dB)	AG Index	E-TFCI
1	11/15	15/15	64	11/15	22/15	209/225	1039/225	4	1	1.5	1.5	20	75
2	6/15	15/15	64	6/15	12/15	12/15	12/15	4	1	1.5	1.5	12	67
3	15/15	9/15	64	15/9	30/15	30/15	$\beta_{ed1}:47/15$ $\beta_{ed2}:47/15$	4	2	1.5	1.5	15	92
4	2/15	15/15	64	2/15	4/15	4/15	56/75	4	1	1.5	1.5	17	71
5	15/15	15/15	64	15/15	24/15	30/15	134/15	4	1	1.5	1.5	21	81

Rel.7 Release 7 HSPA+ Data Devices

Table C.11.1.4: β values for transmitter characteristics tests with HS-DPCCH and E-DCH with 16QAM

Sub-test	β_c (Note 3)	β_d	β_{HS} (Note 1)	β_{ec}	β_{ed} (2xSF2) (Note 4)	β_{ed} (2xSF4) (Note 4)	CM (dB) (Note 2)	MPR (dB) (Note 2)	AG Index (Note 4)	E-TFCI (Note 5)	E-TFCI (boost)
1	1	0	30/15	30/15	β_{ed1} : 30/15 β_{ed2} : 30/15	β_{ed3} : 24/15 β_{ed4} : 24/15	3.5	2.5	14	105	105

Note 1: Δ_{ACK} , Δ_{NACK} and $\Delta_{CQI} = 30/15$ with $\beta_{hs} = 30/15 * \beta_c$.

Note 2: CM = 3.5 and the MPR is based on the relative CM difference, MPR = MAX(CM-1,0).

Note 3: DPDCH is not configured, therefore the β_c is set to 1 and $\beta_d = 0$ by default.

Note 4: β_{ed} can not be set directly; it is set by Absolute Grant Value.

Note 5: All the sub-tests require the UE to transmit 2SF2+2SF4 16QAM EDCH and they apply for UE using E-DPDCH category 7. E-DCH TTI is set to 2ms TTI and E-DCH table index = 2. To support these E-DCH configurations DPDCH is not allocated. The UE is signalled to use the extrapolation algorithm.

Rel.8 DC-HSDPA (Cat 24)

SAR test exclusion for Rel.8 DC-HSDPA must satisfy the SAR test exclusion requirements of Rel.5 HSDPA. SAR test exclusion for DC-HSDPA devices is determined by power measurements according to the H-Set 12, Fixed Reference Channel (FRC) configuration in Table C.8.1.12 of 3GPP TS 34.121-1. A primary and a secondary serving HS-DSCH Cell are required to perform the power measurement and for the results to qualify for SAR test exclusion.

Table C.8.1.12: Fixed Reference Channel H-Set 12

Parameter	Unit	Value
Nominal Avg. Inf. Bit Rate	kbps	60
Inter-TTI Distance	TTI's	1
Number of HARQ Processes	Processes	6
Information Bit Payload (N_{INF})	Bits	120
Number Code Blocks	Blocks	1
Binary Channel Bits Per TTI	Bits	960
Total Available SML's in UE	SML's	19200
Number of SML's per HARQ Proc.	SML's	3200
Coding Rate		0.15
Number of Physical Channel Codes	Codes	1
Modulation		QPSK
Note 1:	The RMC is intended to be used for DC-HSDPA mode and both cells shall transmit with identical parameters as listed in the table.	
Note 2:	Maximum number of transmission is limited to 1, i.e., retransmission is not allowed. The redundancy and constellation version 0 shall be used.	

10.2 LTE Measurement Procedures for SAR

SAR tests for LTE are performed with a base station simulator, Rohde & Schwarz CMW500 or Anritsu MT8821C Closed loop power control was used so the UE transmits with maximum output power during SAR testing.

It is performed for conducted power and SAR based on the KDB941225 D05.

SAR is evaluated separately according to the following procedures for the different test positions in each exposure condition – head, body, body-worn accessories and other use conditions. The procedures in the following subsections are applied separately to test each LTE frequency band.

1) QPSK with 1 RB allocation

Start with the largest channel bandwidth and measure SAR for QPSK with 1 RB allocation, using the RB offset and required test channel combination with the highest maximum output power among RB offsets at the upper edge, middle and lower edge of each required test channel. When the reported SAR is ≤ 0.8 W/kg, testing of the remaining RB offset configurations and required test channels is not required for 1 RB allocation; otherwise, SAR is required for the remaining required test channels and only for the RB offset configuration with the highest output power for that channel. When the reported SAR of a required test channel is > 1.45 W/kg, SAR is required for all three RB offset configurations for that required test channel.

2) QPSK with 50% RB allocation

The procedures required for 1 RB allocation in 1) are applied to measure the SAR for QPSK with 50% RB allocation.

3) QPSK with 100% RB allocation

For QPSK with 100% RB allocation, SAR is not required when the highest maximum output power for 100 % RB allocation is less than the highest maximum output power in 50% and 1 RB allocations and the highest reported SAR for 1 RB and 50% RB allocation in 1) and 2) are ≤ 0.8 W/kg. Otherwise, SAR is measured for the highest output power channel; and if the reported SAR is > 1.45 W/kg, the remaining required test channels must also be tested.

10.3 Bluetooth & Wi-Fi Measurement Procedures for SAR

Normal network operating configurations are not suitable for measuring the SAR of 802.11 transmitters in general. Unpredictable fluctuations in network traffic and antenna diversity conditions can introduce undesirable variations in SAR results. The SAR for these devices should be measured using chipset based test mode software to ensure that the results are consistent and reliable.

Chipset based test mode software is hardware dependent and generally varies among manufacturers. The device operating parameters established in a test mode for SAR measurements must be identical to those programmed in production units, including output power levels, amplifier gain settings and other RF performance tuning parameters. The test frequencies should correspond to actual channel frequencies defined for domestic use. SAR for devices with switched diversity should be measured with only one antenna transmitting at a time during each SAR measurement, according to a fixed modulation and data rate. The same data pattern should be used for all measurements.

11 Conducted Output Power

This device has several different power modes for head, body; power selection is determined by the device's positioning and usage scenarios. The details of test scenarios categorization in the table below

Antenna	Head	Body Receiver off
Main antenna	normal	Low power

11.1 WCDMA Measurement result

WCDMA1900

Item	band	FDDII result			
	ARFCN	9538(1907.6MHz)	9400(1880MHz)	9262(1852.4MHz)	Tuneup
WCDMA	\	22.63	22.59	22.54	23.50
HSUPA	1	19.6	19.56	19.60	20.50
	2	19.5	19.48	19.40	20.50
	3	20.48	20.41	20.46	21.50
	4	18.93	18.95	18.95	20.50
	5	20.53	20.42	20.44	21.50
HSPA+		21.14	21.08	21.01	22.00
DC-HSDPA	1	21.63	21.59	21.58	22.50
	2	21.49	21.50	21.56	22.00
	3	20.31	20.22	20.24	22.00
	4	20.28	20.25	20.24	22.00

WCDMA1900 receive off

Item	band	FDDII result			
	ARFCN	9538(1907.6MHz)	9400(1880MHz)	9262(1852.4MHz)	Tuneup
WCDMA	\	21.05	20.95	20.91	22.00
HSUPA	1	18.02	17.97	17.97	19.00
	2	18.03	18.00	17.98	19.00
	3	18.03	18.37	18.26	20.00
	4	18.05	17.98	17.97	19.00
	5	18.05	18.19	18.00	20.00
HSPA+		19.57	19.56	19.51	20.50
DC-HSDPA	1	20.03	20.01	20.00	21.00
	2	20.01	19.94	19.95	20.50
	3	19.52	19.55	19.52	20.50
	4	19.52	19.60	19.48	20.50

WCDMA1700

Item	band	FDDIV result			
	ARFCN	1513 (1752.6MHz)	1412 (1732.4MHz)	1312 (1712.4MHz)	Tune up
WCDMA	\	22.12	22.06	22.01	23.50
HSUPA	1	19.45	19.55	19.48	20.50
	2	19.48	19.50	19.50	20.50
	3	20.52	20.47	20.49	21.50
	4	18.95	18.97	18.97	20.50
	5	20.4	20.45	20.50	21.50
HSPA+		21.01	21.18	21.03	22.00
DC-HSDPA	1	20.72	20.67	20.70	22.00
	2	20.58	20.56	20.66	22.00
	3	20.19	20.21	20.15	21.50
	4	20.19	20.16	20.17	21.50

WCDMA1700 receiver off

Item	band	FDDIV result			
	ARFCN	1513 (1752.6MHz)	1412 (1732.4MHz)	1312 (1712.4MHz)	Tune up
WCDMA	\	18.16	18.25	18.29	19.00
HSUPA	1	15.25	15.23	15.38	16.00
	2	15.41	15.42	15.43	16.00
	3	15.27	15.43	15.26	17.00
	4	15.28	15.35	15.34	16.00
	5	15.25	15.45	15.33	17.00
HSPA+		16.88	16.96	16.60	17.50
DC-HSDPA	1	17.35	17.29	17.36	17.50
	2	17.19	17.21	17.27	17.50
	3	16.72	16.80	16.73	17.00
	4	16.69	16.83	16.77	17.00

WCDMA850

Item	band	FDDV result			
	ARFCN	4233 (846.6MHz)	4183 (836.6MHz)	4132 (826.4MHz)	Tune up
WCDMA	\	22.57	22.61	22.57	24.00
HSUPA	1	19.49	19.53	19.48	21.00
	2	19.42	19.45	19.50	21.00
	3	20.53	20.57	20.46	22.00
	4	19.21	19.22	19.17	21.00
	5	20.53	20.49	20.51	22.00
HSPA+		21.14	21.16	21.15	22.50
	1	20.68	20.69	20.66	21.50

DC-HSDPA	2	20.67	20.65	20.68	21.50
	3	20.22	20.21	20.22	21.00
	4	20.21	20.24	20.17	21.00

11.2 LTE Measurement result

The maximum output power(Tune-up Limit)

BAND	Tune - up	
	normal	receiver off
LTE B2	24.5	23
LTE B5	25	25
LTE B12	24	24
LTE B13	25	25
LTE B4/66	24.5	21

LTE B2

Band 2						
Bandwidth (MHz)	RB allocation	Frequency (MHz)	Actual output power (dBm)			
	RB offset		QPSK	16QAM	64QAM	
1.4MHz	1RB-High (5)	1909.3	23.56	22.77	21.77	
		1880	23.57	22.89	21.79	
		1850.7	23.62	22.87	21.76	
	1RB-Middle (3)	1909.3	23.65	22.99	21.83	
		1880	23.65	22.97	21.97	
		1850.7	23.72	23.09	21.84	
	1RB-Low (0)	1909.3	23.57	22.90	21.89	
		1880	23.57	22.91	21.83	
		1850.7	23.56	22.85	21.84	
	3RB-High (3)	1909.3	23.67	22.69	21.75	
		1880	23.67	22.70	21.80	
		1850.7	23.68	22.71	21.82	
	3RB-Middle (1)	1909.3	23.71	22.66	21.84	
		1880	23.71	22.75	21.83	
		1850.7	23.75	22.78	21.86	
	3RB-Low (0)	1909.3	23.68	22.69	21.74	
		1880	23.65	22.71	21.84	
		1850.7	23.68	22.75	21.78	
	6RB (0)	1909.3	22.70	21.83	20.67	
		1880	22.70	21.84	21.42	
		1850.7	22.72	21.81	20.72	
	3MHz	1RB-High (14)	1908.5	24.15	23.01	21.91
			1880	23.69	23.02	21.95
			1851.5	23.68	22.99	21.91
1RB-Middle (7)		1908.5	23.89	23.12	21.97	
		1880	23.83	23.18	22.11	



	1RB-Low (0)	1851.5	23.89	23.22	22.09	
		1908.5	23.69	23.05	21.93	
		1880	23.70	23.05	21.91	
		1851.5	23.72	23.00	21.91	
	8RB-High (7)	1908.5	22.79	21.81	20.82	
		1880	22.74	21.81	20.80	
		1851.5	22.77	21.86	20.79	
	8RB-Middle (4)	1908.5	22.83	21.86	20.85	
		1880	22.81	21.87	20.82	
		1851.5	22.80	21.88	20.83	
	8RB-Low (0)	1908.5	22.78	21.87	20.78	
		1880	22.76	21.82	20.79	
		1851.5	22.78	21.86	20.80	
	15RB (0)	1908.5	22.79	21.78	20.79	
		1880	22.75	21.78	20.75	
1851.5		22.77	21.77	20.74		
5MHz	1RB-High (24)	1907.5	24.06	22.77	21.76	
		1880	23.55	22.99	21.83	
		1852.5	23.61	22.84	21.85	
	1RB-Middle (12)	1907.5	24.24	23.22	22.11	
		1880	23.87	23.24	22.14	
		1852.5	23.88	23.13	22.06	
	1RB-Low (0)	1907.5	23.59	22.98	21.81	
		1880	23.59	22.91	21.84	
		1852.5	23.59	22.84	21.84	
	12RB-High (13)	1907.5	22.75	21.73	20.76	
		1880	22.78	21.77	20.79	
		1852.5	22.80	21.81	20.81	
	12RB-Middle (6)	1907.5	22.85	21.84	20.87	
		1880	22.83	21.85	20.83	
		1852.5	22.83	21.83	20.87	
	12RB-Low (0)	1907.5	22.80	21.79	20.80	
		1880	22.75	21.76	20.80	
		1852.5	22.78	21.79	20.79	
	25RB (0)	1907.5	22.79	21.79	20.79	
		1880	22.76	21.78	20.77	
		1852.5	22.81	21.82	20.84	
	10MHz	1RB-High (49)	1905	24.16	23.01	21.92
			1880	23.66	23.04	21.86
			1855	23.68	22.99	21.87
1RB-Middle (24)		1905	24.31	23.12	22.03	
		1880	23.79	23.07	22.10	
		1855	23.81	23.13	22.11	
1RB-Low (0)		1905	24.18	22.96	21.88	
		1880	23.68	23.04	21.89	
		1855	23.70	23.09	21.96	
25RB-High (25)		1905	23.12	21.76	20.75	
		1880	22.81	21.83	20.91	
		1855	22.92	21.86	20.97	
25RB-Middle (12)		1905	22.92	21.82	20.92	
		1880	22.83	21.82	21.12	
		1855	22.92	21.85	20.94	
25RB-Low (0)		1905	23.08	21.85	21.07	



	50RB (0)	1880	22.80	21.82	20.84	
		1855	22.84	21.89	21.07	
		1905	22.94	21.81	21.00	
		1880	22.81	21.82	20.88	
		1855	22.98	21.89	20.87	
15MHz	1RB-High (74)	1902.5	24.11	23.38	22.32	
		1880	24.11	23.40	22.33	
		1857.5	24.10	23.42	22.35	
	1RB-Middle (37)	1902.5	24.25	23.42	22.42	
		1880	24.24	23.45	22.42	
		1857.5	24.25	23.42	22.44	
	1RB-Low (0)	1902.5	24.14	23.43	22.29	
		1880	24.14	23.44	22.35	
		1857.5	24.18	23.39	22.38	
	36RB-High (38)	1902.5	23.24	22.26	21.26	
		1880	23.26	22.28	21.29	
		1857.5	23.28	22.31	21.30	
	36RB-Middle (19)	1902.5	23.31	22.34	21.32	
		1880	23.28	22.32	21.29	
		1857.5	23.28	22.32	21.32	
	36RB-Low (0)	1902.5	23.30	22.32	21.33	
		1880	23.27	22.32	21.29	
		1857.5	23.29	22.33	21.31	
	75RB (0)	1902.5	23.28	22.31	21.28	
		1880	23.27	22.31	21.31	
		1857.5	23.27	22.31	21.28	
	20MHz	1RB-High (99)	1900	24.01	23.29	22.18
			1880	24.02	23.32	22.19
			1860	24.00	23.21	22.15
1RB-Middle (50)		1900	24.42	23.42	22.41	
		1880	24.39	23.43	22.44	
		1860	24.39	23.45	22.42	
1RB-Low (0)		1900	24.06	23.25	22.26	
		1880	24.06	23.22	22.24	
		1860	24.04	23.18	22.25	
50RB-High (50)		1900	23.26	22.28	21.26	
		1880	23.29	22.31	21.33	
		1860	23.29	22.29	21.29	
50RB-Middle (25)		1900	23.39	22.42	21.36	
		1880	23.35	22.40	21.36	
		1860	23.35	22.40	21.35	
50RB-Low (0)		1900	23.33	22.38	21.33	
		1880	23.33	22.39	21.34	
		1860	23.30	22.36	21.33	
100RB (0)		1900	23.28	22.33	21.29	
		1880	23.32	22.35	21.34	
		1860	23.28	22.31	21.31	

LTE B2 receiver off

Band 2					
Bandwidth (MHz)	RB allocation	Frequency (MHz)	Actual output power (dBm)		
	RB offset		QPSK	16QAM	64QAM
1.4MHz	1RB-High (5)	1909.3	22.32	21.05	20.50
		1880	22.05	21.39	20.56
		1850.7	22.24	21.68	20.60
	1RB-Middle (3)	1909.3	22.39	21.23	20.56
		1880	22.35	21.39	20.58
		1850.7	22.14	21.71	20.63
	1RB-Low (0)	1909.3	22.29	21.10	20.45
		1880	22.00	21.35	20.56
		1850.7	22.24	21.63	20.52
	3RB-High (3)	1909.3	22.03	20.98	20.42
		1880	21.97	20.99	20.47
		1850.7	22.45	21.38	20.55
	3RB-Middle (1)	1909.3	21.96	20.96	20.49
		1880	22.09	21.23	20.57
		1850.7	22.36	21.39	20.60
	3RB-Low (0)	1909.3	21.92	20.95	20.28
		1880	22.12	21.26	20.52
		1850.7	22.33	21.39	20.50
	6RB (0)	1909.3	21.13	20.07	19.38
		1880	20.96	20.41	19.40
		1850.7	21.44	20.48	19.45
3MHz	1RB-High (14)	1908.5	22.41	21.27	20.45
		1880	22.29	21.55	20.63
		1851.5	22.42	21.80	20.65
	1RB-Middle (7)	1908.5	22.58	21.43	20.79
		1880	22.57	21.73	20.84
		1851.5	22.49	21.84	20.75
	1RB-Low (0)	1908.5	22.42	21.24	20.56
		1880	22.03	21.48	20.61
		1851.5	22.41	21.77	20.63
	8RB-High (7)	1908.5	21.45	20.18	19.53
		1880	21.42	20.53	19.56
		1851.5	21.39	20.51	19.53
	8RB-Middle (4)	1908.5	21.47	20.22	19.55
		1880	21.50	20.55	19.56
		1851.5	21.42	20.56	19.60
	8RB-Low (0)	1908.5	21.48	20.26	19.57
		1880	21.45	20.57	19.52
		1851.5	21.45	20.59	19.56
	15RB (0)	1908.5	21.46	20.42	19.49
		1880	21.40	20.47	19.47
		1851.5	21.33	20.51	19.51
5MHz	1RB-High (24)	1907.5	22.30	21.28	20.59
		1880	22.16	21.28	20.47

	1RB-Middle (12)	1852.5	22.35	21.72	20.57	
		1907.5	22.56	21.38	20.74	
		1880	22.39	21.44	20.78	
	1RB-Low (0)	1852.5	22.44	21.97	20.83	
		1907.5	22.30	21.16	20.44	
		1880	21.90	21.17	20.54	
	12RB-High (13)	1852.5	22.22	21.47	20.55	
		1907.5	21.41	20.30	19.49	
		1880	21.40	20.47	19.53	
	12RB-Middle (6)	1852.5	21.45	20.49	19.51	
		1907.5	21.50	20.51	19.58	
		1880	21.52	20.51	19.58	
	12RB-Low (0)	1852.5	21.56	20.54	19.59	
		1907.5	21.48	20.48	19.53	
		1880	21.43	20.44	19.52	
	25RB (0)	1852.5	21.48	20.50	19.50	
		1907.5	21.41	20.26	19.50	
		1880	21.45	20.48	19.52	
10MHz	1RB-High (49)	1852.5	21.51	20.51	19.51	
		1905	22.39	21.35	20.53	
		1880	22.37	21.58	20.62	
	1RB-Middle (24)	1855	22.21	21.56	20.63	
		1905	22.53	21.38	20.67	
		1880	22.29	21.64	20.73	
	1RB-Low (0)	1855	22.54	21.84	20.75	
		1905	22.41	21.23	20.56	
		1880	22.10	21.35	20.56	
	25RB-High (25)	1855	22.17	21.57	20.63	
		1905	21.42	20.38	19.46	
		1880	21.50	20.51	19.54	
	25RB-Middle (12)	1855	21.54	20.55	19.49	
		1905	21.48	20.50	19.52	
		1880	21.48	20.49	19.52	
	25RB-Low (0)	1855	21.47	20.51	19.53	
		1905	21.54	20.54	19.56	
		1880	21.52	20.49	19.51	
50RB (0)	1855	21.53	20.50	19.50		
	1905	21.49	20.49	19.50		
	1880	21.49	20.48	19.52		
15MHz	1RB-High (74)	1855	21.52	20.53	19.48	
		1902.5	22.25	21.48	20.50	
		1880	22.31	21.61	20.53	
	1RB-Middle (37)	1857.5	22.33	21.71	20.47	
		1902.5	22.44	21.25	20.65	
		1880	22.43	21.70	20.61	
	1RB-Low (0)	1857.5	22.44	21.82	20.61	
		1902.5	22.33	21.16	20.52	
		1880	22.04	21.25	20.58	
	36RB-High (38)	1857.5	22.36	21.65	20.60	
		1902.5	21.42	20.40	19.47	
		1880	21.46	20.44	19.50	
	36RB-Middle (19)	1857.5	21.49	20.47	19.47	
		1902.5	21.47	20.46	19.50	
		1880	21.48	20.45	19.50	
			1857.5	21.53	20.48	19.52



	36RB-Low (0)	1902.5	21.51	20.46	19.52
		1880	21.48	20.45	19.51
		1857.5	21.47	20.46	19.50
	75RB (0)	1902.5	21.46	20.45	19.48
		1880	21.46	20.47	19.48
		1857.5	21.47	20.47	19.46
20MHz	1RB-High (99)	1900	22.12	21.49	20.27
		1880	22.14	21.50	20.38
		1860	22.15	21.46	20.29
	1RB-Middle (50)	1900	22.52	21.72	20.70
		1880	22.51	21.88	20.64
		1860	22.52	21.79	20.66
	1RB-Low (0)	1900	22.13	21.42	20.38
		1880	22.13	21.31	20.43
		1860	22.20	21.43	20.34
	50RB-High (50)	1900	21.36	20.38	19.41
		1880	21.44	20.44	19.50
		1860	21.42	20.43	19.40
	50RB-Middle (25)	1900	21.46	20.48	19.51
		1880	21.46	20.47	19.50
		1860	21.48	20.49	19.51
	50RB-Low (0)	1900	21.46	20.43	19.51
		1880	21.50	20.50	19.52
		1860	21.44	20.47	19.51
	100RB (0)	1900	21.41	20.40	19.45
		1880	21.45	20.45	19.48
		1860	21.43	20.42	19.44

LTE B5

Band 5					
Bandwidth (MHz)	RB allocation	Frequency (MHz)	Actual output power (dBm)		
	RB offset		QPSK	16QAM	64QAM
1.4MHz	1RB-High	848.3	24.14	22.89	21.90
		836.5	23.77	22.93	21.91
		824.7	23.72	22.96	21.90
	1RB-Middle (3)	848.3	23.77	23.06	21.93
		836.5	23.85	23.18	22.03
		824.7	23.88	23.05	21.87
	1RB-Low (0)	848.3	23.65	22.94	21.84
		836.5	23.75	22.91	21.89
		824.7	23.74	22.93	21.89
	3RB-High (3)	848.3	23.81	22.76	21.82
		836.5	23.89	22.82	21.91
		824.7	23.83	22.82	21.98
	3RB-Middle (1)	848.3	23.81	22.84	21.85
		836.5	23.89	22.83	21.97
		824.7	23.87	22.85	21.94
	3RB-Low (0)	848.3	23.81	22.74	21.83
		836.5	23.86	22.78	21.90
		824.7	23.84	22.81	21.86
	6RB (0)	848.3	22.79	21.84	20.78
		836.5	22.89	21.91	20.86
		824.7	22.86	21.89	20.86
3MHz	1RB-High (14)	847.5	24.17	22.91	21.86
		836.5	23.79	22.98	21.92
		825.5	23.76	22.96	21.89
	1RB-Middle (7)	847.5	23.93	23.09	22.05
		836.5	23.96	23.17	22.09
		825.5	23.92	23.09	22.04
	1RB-Low (0)	847.5	23.72	22.88	21.82
		836.5	23.80	23.07	21.86
		825.5	23.79	23.07	21.96
	8RB-High (7)	847.5	22.78	21.76	20.84
		836.5	22.79	21.84	20.87
		825.5	22.79	21.83	20.85
	8RB-Middle (4)	847.5	22.79	21.84	20.82
		836.5	22.85	21.85	20.88
		825.5	22.81	21.86	20.87
	8RB-Low (0)	847.5	22.77	21.83	20.83
		836.5	22.82	21.85	20.90
		825.5	22.83	21.84	20.89
15RB (0)	847.5	22.75	21.75	20.76	
	836.5	22.80	21.79	20.85	
	825.5	22.84	21.81	20.82	

5MHz	1RB-High (24)	846.5	24.07	22.88	21.80
		836.5	23.67	22.96	21.85
		826.5	23.65	22.92	21.85
	1RB-Middle (12)	846.5	23.93	23.17	22.04
		836.5	24.04	23.18	22.14
		826.5	23.93	23.14	22.12
	1RB-Low (0)	846.5	23.68	22.83	21.78
		836.5	23.70	22.90	21.86
		826.5	23.70	22.99	21.86
	12RB-High (13)	846.5	22.72	21.67	20.78
		836.5	22.80	21.77	20.82
		826.5	22.80	21.77	20.82
	12RB-Middle (6)	846.5	22.80	21.76	20.84
		836.5	22.87	21.82	20.89
		826.5	22.83	21.78	20.88
	12RB-Low (0)	846.5	22.79	21.74	20.82
		836.5	22.84	21.78	20.84
		826.5	22.81	21.78	20.81
	25RB (0)	846.5	22.76	21.77	20.79
		836.5	22.83	21.80	20.82
		826.5	22.79	21.81	20.82
10MHz	1RB-High (49)	844	23.75	23.08	21.88
		836.5	23.78	22.93	21.98
		829	23.77	23.02	21.85
	1RB-Middle (24)	844	23.87	23.09	22.06
		836.5	23.95	23.13	22.08
		829	23.85	23.16	22.00
	1RB-Low (0)	844	23.84	22.98	21.97
		836.5	23.79	22.98	21.90
		829	23.80	23.03	21.91
	25RB-High (25)	844	22.80	21.79	20.82
		836.5	22.86	21.85	21.48
		829	22.87	21.87	20.88
	25RB-Middle (12)	844	22.85	21.83	20.90
		836.5	22.90	21.88	21.47
		829	22.88	21.87	20.91
	25RB-Low (0)	844	22.91	21.85	20.92
		836.5	22.96	21.95	21.42
		829	22.87	21.85	20.88
	50RB (0)	844	22.86	21.86	20.89
		836.5	22.92	21.90	20.90
		829	22.86	21.83	20.87

LTE B12

Band 12			
Bandwidth (MHz)	RB allocation	Frequency (MHz)	Actual output power (dBm)

	RB offset		QPSK	16QAM	64QAM
1.4MHz	1RB-High	715.3	23.18	22.00	20.92
		707.5	22.77	22.17	20.95
		699.7	22.74	22.01	21.04
	1RB-Middle (3)	715.3	23.32	22.16	20.96
		707.5	22.91	22.20	21.12
		699.7	22.86	22.13	21.07
	1RB-Low (0)	715.3	23.17	21.92	20.91
		707.5	22.73	22.06	20.91
		699.7	22.73	22.11	20.91
	3RB-High (3)	715.3	22.80	21.79	20.87
		707.5	22.90	21.89	20.99
		699.7	22.84	21.92	20.95
	3RB-Middle (1)	715.3	22.85	21.87	20.95
		707.5	22.91	21.96	21.04
		699.7	22.89	21.91	21.03
	3RB-Low (0)	715.3	22.77	21.82	20.93
		707.5	22.88	21.92	20.96
		699.7	22.84	21.91	20.98
6RB (0)	715.3	21.81	20.89	19.75	
	707.5	21.86	20.91	19.89	
	699.7	21.87	20.96	19.89	
3MHz	1RB-High (14)	714.5	23.24	22.25	21.32
		707.5	23.29	22.59	21.52
		700.5	23.25	22.29	21.39
	1RB-Middle (7)	714.5	23.37	22.50	21.18
		707.5	23.39	22.66	21.58
		700.5	23.36	22.38	21.60
	1RB-Low (0)	714.5	23.24	22.37	20.98
		707.5	23.25	22.53	21.12
		700.5	23.08	22.20	21.33
	8RB-High (7)	714.5	22.30	21.16	20.14
		707.5	22.36	21.22	20.25
		700.5	22.21	21.10	20.37
	8RB-Middle (4)	714.5	22.32	21.17	20.26
		707.5	22.36	21.43	20.40
		700.5	22.36	21.27	20.39
	8RB-Low (0)	714.5	22.27	21.32	20.29
		707.5	22.37	21.43	20.38
		700.5	22.28	21.23	20.34
15RB (0)	714.5	22.28	21.23	20.17	
	707.5	22.33	21.23	20.28	
	700.5	22.32	21.23	20.30	
5MHz	1RB-High (24)	713.5	23.11	22.36	21.37
		707.5	23.17	22.46	21.39
		701.5	23.17	22.55	21.35
	1RB-Middle (12)	713.5	23.44	22.66	21.64
		707.5	23.44	22.75	21.64
		701.5	23.42	22.74	21.65

	1RB-Low (0)	713.5	23.19	22.52	21.46	
		707.5	23.16	22.49	21.38	
		701.5	23.17	22.49	21.35	
	12RB-High (13)	713.5	22.24	21.22	20.24	
		707.5	22.34	21.33	20.34	
		701.5	22.25	21.20	20.28	
	12RB-Middle (6)	713.5	22.35	21.33	20.36	
		707.5	22.44	21.43	20.41	
		701.5	22.38	21.38	20.39	
	12RB-Low (0)	713.5	22.34	21.34	20.35	
		707.5	22.32	21.34	20.33	
		701.5	22.30	21.25	20.28	
	25RB (0)	713.5	22.27	21.32	20.29	
		707.5	22.35	21.35	20.34	
		701.5	22.30	21.34	20.27	
	10MHz	1RB-High (49)	711	23.21	22.47	21.43
			707.5	23.22	22.63	21.53
			704	23.29	22.66	21.48
1RB-Middle (24)		711	23.48	22.80	21.60	
		707.5	23.43	22.60	21.58	
		704	23.41	22.78	21.59	
1RB-Low (0)		711	23.30	22.62	21.57	
		707.5	23.27	22.57	21.50	
		704	23.30	22.54	21.48	
25RB-High (25)		711	22.28	21.27	20.28	
		707.5	22.42	21.42	20.40	
		704	22.45	21.45	20.44	
25RB-Middle (12)		711	22.42	21.42	20.42	
		707.5	22.46	21.45	20.41	
		704	22.46	21.44	20.44	
25RB-Low (0)		711	22.42	21.44	20.43	
		707.5	22.51	21.49	20.50	
		704	22.46	21.44	20.45	
50RB (0)		711	22.33	21.32	20.36	
		707.5	22.47	21.46	20.46	
		704	22.43	21.44	20.42	

LTE B13

Band 13					
Bandwidth (MHz)	RB allocation	Frequency (MHz)	Actual output power (dBm)		
	RB offset		QPSK	16QAM	64QAM
5MHz	1RB-High (24)	784.5	23.58	22.85	21.75
		782	23.61	22.85	21.73
		779.5	23.62	22.79	21.80
	1RB-Middle (12)	784.5	23.85	23.25	22.07
		782	23.84	23.22	22.07

	1RB-Low (0)	779.5	23.87	23.03	21.96
		784.5	23.66	23.03	21.87
		782	23.63	22.82	21.79
		779.5	23.63	22.79	21.86
	12RB-High (13)	784.5	22.72	21.65	20.72
		782	22.73	21.69	20.76
		779.5	22.72	21.72	20.79
	12RB-Middle (6)	784.5	22.79	21.75	20.85
		782	22.79	21.76	20.83
		779.5	22.79	21.76	20.84
	12RB-Low (0)	784.5	22.73	21.73	20.81
		782	22.73	21.73	20.79
		779.5	22.66	21.64	20.68
	25RB (0)	784.5	22.73	21.72	20.75
		782	22.73	21.72	20.79
779.5		22.71	21.70	20.74	
10MHz	1RB-High (49)	782	23.70	22.96	21.85
	1RB-Middle (24)	782	23.85	23.05	21.99
	1RB-Low (0)	782	23.75	23.05	21.89
	25RB-High (25)	782	22.80	21.77	20.83
	25RB-Middle (12)	782	22.81	21.80	20.85
	25RB-Low (0)	782	22.78	21.77	20.82
	50RB (0)	782	22.79	21.78	20.83

LTE B66

Band 66					
Bandwidth (MHz)	RB allocation	Frequency (MHz)	Actual output power (dBm)		
	RB offset		QPSK	16QAM	64QAM
1.4MHz	1RB-High	1779.3	24.01	23.23	22.20
		1745	23.96	23.16	22.16
		1710.7	24.00	23.23	22.19
	1RB-Middle (3)	1779.3	24.12	23.33	22.26
		1745	24.12	23.30	22.26
		1710.7	24.11	23.28	22.43
	1RB-Low (0)	1779.3	23.99	23.14	22.22
		1745	23.95	23.21	22.15
		1710.7	24.00	23.22	22.22
	3RB-High (3)	1779.3	24.15	23.00	22.18
		1745	24.09	22.95	22.23
		1710.7	24.14	23.05	22.25
	3RB-Middle (1)	1779.3	24.18	23.10	22.23
		1745	24.14	23.10	22.22
		1710.7	24.16	23.13	22.32

	3RB-Low (0)	1779.3	24.14	23.04	22.16	
		1745	24.09	22.98	22.17	
		1710.7	24.13	23.07	22.27	
	6RB (0)	1779.3	23.13	22.21	21.17	
		1745	23.08	22.25	21.14	
		1710.7	23.13	22.25	21.15	
3MHz	1RB-High (14)	1778.5	24.05	23.22	22.20	
		1745	24.01	23.23	22.24	
		1711.5	24.09	23.29	22.21	
	1RB-Middle (7)	1778.5	24.27	23.36	22.38	
		1745	24.23	23.46	22.40	
		1711.5	24.27	23.41	22.42	
	1RB-Low (0)	1778.5	24.05	23.29	22.32	
		1745	24.02	23.20	22.17	
		1711.5	24.07	23.28	22.28	
	8RB-High (7)	1778.5	23.08	22.16	21.15	
		1745	23.03	22.17	21.14	
		1711.5	23.08	22.21	21.19	
	8RB-Middle (4)	1778.5	23.12	22.21	21.20	
		1745	23.06	22.20	21.18	
		1711.5	23.13	22.24	21.21	
	8RB-Low (0)	1778.5	23.10	22.20	21.17	
		1745	23.06	22.16	21.11	
		1711.5	23.09	22.22	21.18	
	15RB (0)	1778.5	23.09	22.15	21.10	
		1745	23.05	22.08	21.09	
		1711.5	23.11	22.13	21.13	
	5MHz	1RB-High (24)	1777.5	23.94	23.05	22.20
			1745	23.90	23.07	22.08
			1712.5	23.96	23.19	22.20
1RB-Middle (12)		1777.5	24.23	23.46	22.40	
		1745	24.22	23.34	22.42	
		1712.5	24.22	23.36	22.45	
1RB-Low (0)		1777.5	23.94	23.14	22.14	
		1745	23.89	23.09	22.22	
		1712.5	23.97	23.23	22.10	
12RB-High (13)		1777.5	23.09	22.09	21.15	
		1745	23.04	22.06	21.10	
		1712.5	23.11	22.14	21.17	
12RB-Middle (6)		1777.5	23.16	22.16	21.17	
		1745	23.08	22.13	21.16	
		1712.5	23.14	22.19	21.20	
12RB-Low (0)		1777.5	23.11	22.11	21.13	
		1745	23.05	22.09	21.14	
		1712.5	23.09	22.16	21.11	
25RB (0)		1777.5	23.12	22.15	21.17	
		1745	23.07	22.12	21.13	
		1712.5	23.11	22.19	21.15	
10MHz		1RB-High (49)	1775	24.05	23.27	22.19
			1745	24.01	23.28	22.23

	1RB-Middle (24)	1715	24.05	23.34	22.33
		1775	24.13	23.39	22.35
		1745	24.16	23.40	22.30
	1RB-Low (0)	1715	24.16	23.40	22.42
		1775	24.06	23.23	22.29
		1745	24.02	23.31	22.20
	25RB-High (25)	1715	24.07	23.25	22.23
		1775	23.18	22.22	21.20
		1745	23.14	22.20	21.19
	25RB-Middle (12)	1715	23.17	22.21	21.20
		1775	23.14	22.18	21.16
		1745	23.12	22.17	21.17
	25RB-Low (0)	1715	23.15	22.21	21.22
		1775	23.21	22.26	21.27
		1745	23.17	22.22	21.20
50RB (0)	1715	23.16	22.20	21.20	
	1775	23.20	22.25	21.24	
	1745	23.18	22.25	21.23	
15MHz	1RB-High (74)	1715	23.16	22.26	21.21
		1775	23.20	22.25	21.24
		1745	23.18	22.25	21.23
	1RB-Middle (37)	1715	23.16	22.26	21.21
		1772.5	23.96	23.18	22.23
		1745	23.92	23.14	22.20
	1RB-Low (0)	1717.5	23.97	23.16	22.21
		1772.5	24.04	23.28	22.31
		1745	24.04	23.33	22.24
	36RB-High (38)	1717.5	24.06	23.31	22.34
		1772.5	23.97	23.19	22.14
		1745	24.00	23.28	22.21
	36RB-Middle (19)	1717.5	23.99	23.20	22.20
		1772.5	23.14	22.15	21.18
		1745	23.15	22.14	21.16
36RB-Low (0)	1717.5	23.17	22.19	21.21	
	1772.5	23.16	22.19	21.18	
	1745	23.17	22.17	21.20	
75RB (0)	1717.5	23.16	22.18	21.18	
	1772.5	23.16	22.17	21.18	
	1745	23.18	22.16	21.20	
20MHz	1RB-High (99)	1717.5	23.15	22.19	21.22
		1770	23.16	22.22	21.20
		1745	23.14	22.18	21.19
	1RB-Middle (50)	1717.5	23.14	22.18	21.15
		1770	23.76	22.98	21.98
		1745	23.71	22.90	21.91
	1RB-Low (0)	1720	23.82	22.99	21.98
		1770	24.16	23.41	22.30
		1745	24.15	23.47	22.34
50RB-High	1720	24.15	23.47	22.34	
	1770	23.76	23.00	21.90	
	1745	23.78	23.01	22.02	
		1720	23.81	23.11	21.99
		1770	23.09	22.13	21.13

	(50)	1745	23.12	22.17	21.14
		1720	23.14	22.20	21.19
	50RB-Middle (25)	1770	23.15	22.21	21.20
		1745	23.15	22.20	21.21
		1720	23.14	22.18	21.20
	50RB-Low (0)	1770	23.14	22.16	21.19
		1745	23.19	22.23	21.24
		1720	23.12	22.15	21.15
	100RB (0)	1770	23.08	22.13	21.12
		1745	23.11	22.16	21.16
		1720	23.12	22.12	21.13

LTE B66 receiver off

Band 66					
Bandwidth (MHz)	RB allocation	Frequency (MHz)	Actual output power (dBm)		
	RB offset		QPSK	16QAM	64QAM
1.4MHz	1RB-High	1779.3	20.74	19.90	18.82
		1745	20.73	19.81	18.92
		1710.7	20.79	19.85	18.95
	1RB-Middle (3)	1779.3	20.87	19.99	18.91
		1745	20.82	19.98	18.86
		1710.7	20.92	19.93	18.99
	1RB-Low (0)	1779.3	20.76	19.82	18.93
		1745	20.70	19.98	18.93
		1710.7	20.80	19.90	18.93
	3RB-High (3)	1779.3	20.88	19.84	18.93
		1745	20.80	19.81	18.93
		1710.7	20.87	19.90	18.93
	3RB-Middle (1)	1779.3	20.94	19.92	18.94
		1745	20.84	19.89	18.93
		1710.7	20.92	19.88	18.97
	3RB-Low (0)	1779.3	20.85	19.83	18.93
		1745	20.82	19.84	18.88
		1710.7	20.88	19.86	18.97
	6RB (0)	1779.3	19.81	19.00	17.81
		1745	19.77	18.89	17.81
		1710.7	19.85	19.00	17.89
3MHz	1RB-High (14)	1778.5	20.80	19.98	19.00
		1745	20.74	19.83	18.94
		1711.5	20.80	19.82	18.75
	1RB-Middle (7)	1778.5	20.93	19.95	18.81
		1745	20.93	19.91	18.85
		1711.5	20.98	19.97	18.83
	1RB-Low (0)	1778.5	20.82	19.85	18.75
		1745	20.74	19.96	18.93
		1711.5	20.85	19.90	18.76

	8RB-High (7)	1778.5	19.80	18.90	17.84	
		1745	19.75	18.85	17.82	
		1711.5	19.84	18.97	17.93	
	8RB-Middle (4)	1778.5	19.83	18.95	17.89	
		1745	19.77	18.88	17.89	
		1711.5	19.86	18.95	17.93	
	8RB-Low (0)	1778.5	19.82	18.93	17.88	
		1745	19.77	18.87	17.83	
		1711.5	19.83	18.94	17.91	
	15RB (0)	1778.5	19.78	18.84	17.81	
		1745	19.73	18.82	17.74	
		1711.5	19.84	18.89	17.85	
5MHz	1RB-High (24)	1777.5	20.70	19.87	18.88	
		1745	20.63	19.86	18.76	
		1712.5	20.73	19.82	18.88	
	1RB-Middle (12)	1777.5	20.99	19.96	18.97	
		1745	20.90	19.93	18.94	
		1712.5	20.98	19.99	18.99	
	1RB-Low (0)	1777.5	20.69	19.94	18.86	
		1745	20.67	19.82	18.89	
		1712.5	20.75	19.94	18.94	
	12RB-High (13)	1777.5	19.79	18.84	17.86	
		1745	19.71	18.76	17.78	
		1712.5	19.80	18.85	17.87	
	12RB-Middle (6)	1777.5	19.86	18.89	17.90	
		1745	19.81	18.82	17.85	
		1712.5	19.89	18.93	17.94	
	12RB-Low (0)	1777.5	19.80	18.83	17.85	
		1745	19.75	18.83	17.81	
		1712.5	19.82	18.86	17.85	
	25RB (0)	1777.5	19.80	18.83	17.81	
		1745	19.73	18.79	17.79	
		1712.5	19.81	18.85	17.83	
	10MHz	1RB-High (49)	1775	20.77	19.83	18.91
			1745	20.76	19.94	18.82
			1715	20.84	19.90	18.84
1RB-Middle (24)		1775	20.92	19.97	18.89	
		1745	20.88	19.90	18.90	
		1715	20.94	19.99	18.96	
1RB-Low (0)		1775	20.81	19.97	18.87	
		1745	20.83	19.91	18.83	
		1715	20.87	19.87	18.82	
25RB-High (25)		1775	19.80	18.87	17.85	
		1745	19.84	18.87	17.83	
		1715	19.87	18.88	17.87	
25RB-Middle (12)		1775	19.81	18.87	17.88	
		1745	19.83	18.88	17.86	
		1715	19.88	18.93	17.92	
25RB-Low (0)		1775	19.88	18.91	17.92	
		1745	19.84	18.90	17.88	

		1715	19.85	18.87	17.88
	50RB (0)	1775	19.86	18.91	17.88
		1745	19.85	18.90	17.91
		1715	19.85	18.91	17.86
15MHz	1RB-High (74)	1772.5	20.74	19.97	18.94
		1745	20.68	19.81	18.83
		1717.5	20.75	19.86	18.95
	1RB-Middle (37)	1772.5	20.82	19.93	18.96
		1745	20.80	19.89	18.97
		1717.5	20.87	19.82	18.94
	1RB-Low (0)	1772.5	20.73	19.94	18.95
		1745	20.76	19.96	18.92
		1717.5	20.77	19.97	18.88
	36RB-High (38)	1772.5	19.83	18.85	17.84
		1745	19.84	18.87	17.84
		1717.5	19.87	18.90	17.91
	36RB-Middle (19)	1772.5	19.89	18.93	17.91
		1745	19.86	18.90	17.87
		1717.5	19.89	18.91	17.93
	36RB-Low (0)	1772.5	19.88	18.88	17.89
		1745	19.88	18.92	17.90
		1717.5	19.89	18.89	17.92
	75RB (0)	1772.5	19.87	18.89	17.87
		1745	19.88	18.88	17.88
		1717.5	19.85	18.89	17.86
20MHz	1RB-High (99)	1770	20.58	19.80	18.80
		1745	20.51	19.79	18.73
		1720	20.61	19.87	18.90
	1RB-Middle (50)	1770	20.89	19.87	18.88
		1745	20.91	19.93	18.65
		1720	20.97	19.82	18.71
	1RB-Low (0)	1770	20.55	19.78	18.70
		1745	20.55	19.91	18.74
		1720	20.60	19.86	18.85
	50RB-High (50)	1770	19.80	18.85	17.82
		1745	19.85	18.88	17.87
		1720	19.90	18.93	17.92
	50RB-Middle (25)	1770	19.88	18.91	17.91
		1745	19.88	18.93	17.92
		1720	19.88	18.92	17.89
	50RB-Low (0)	1770	19.89	18.93	17.90
		1745	19.94	18.99	17.99
		1720	19.90	18.93	17.91
	100RB (0)	1770	19.85	18.87	17.83
		1745	19.91	18.93	17.90
		1720	19.89	18.90	17.89

The following tests were conducted according to the test requirements outlined in section 6.2 of the 3GPP TS36.101 specification. UE Power Class: 3 (23 +/- 2dBm). The allowed Maximum Power Reduction (MPR) for the maximum output power due to higher order modulation and transmit bandwidth configuration (resource blocks) is specified in Table 6.2.3-1 of the 3GPP TS36.101.

Table 6.2.3-1: Maximum Power Reduction (MPR) for Power Class 1, 2 and 3

Modulation	Channel bandwidth / Transmission bandwidth (N_{RB})						MPR (dB)
	1.4 MHz	3.0 MHz	5 MHz	10 MHz	15 MHz	20 MHz	
QPSK	> 5	> 4	> 8	> 12	> 16	> 18	≤ 1
16 QAM	≤ 5	≤ 4	≤ 8	≤ 12	≤ 16	≤ 18	≤ 1
16 QAM	> 5	> 4	> 8	> 12	> 16	> 18	≤ 2
64 QAM	≤ 5	≤ 4	≤ 8	≤ 12	≤ 16	≤ 18	≤ 2
64 QAM	> 5	> 4	> 8	> 12	> 16	> 18	≤ 3
256 QAM	≥ 1						≤ 5

11.3 Wi-Fi and BT Measurement result

When the same transmission mode configurations have the same maximum output power on the same channel for the 802.11 a/n/ac/ax modes, the channel in the lower order/sequence 802.11 mode (i.e. a, n, ac then ax) is selected. Therefore the SAR measurements performed for the 802.11n/ac modes, as the lowest order modulation, cover 802.11ax modes.

When the specified maximum output power is the same for both UNII 1 and UNII 2A, begin SAR measurements in UNII 2A with the channel with the highest measured output power. If the reported SAR for UNII 2A is ≤ 1.2 W/kg, SAR is not required for UNII 1; otherwise treat the remaining bands separately and test them independently for SAR.

According to KDB 248227 D01, simultaneous SAR provisions in KDB 447498 D01 apply to determine simultaneous transmission SAR test exclusion for Wi-Fi MIMO. If the sum of 1-g single transmission chain SAR measurements is < 1.6 W/kg and/or the MIMO output power is equal or less than a single chain, then no additional SAR measurements for simultaneously at the specified maximum output power of MIMO operation.

When antennas are spatially separated to the extent that SAR distributions do not overlap and can be treated independently, SAR compliance for simultaneous transmission is determined separately for each individual antenna.

The average conducted power for Wi-Fi is as following:



FCC									
802.11b	Channel/d	1Mbps	2Mbps	5.5Mbps	11Mbps				
WLAN2450	11(2462M	18.83	/	/	/				
	6(2437(M	19.52							
	1(2412MH	19.57	/	/	/				
Tuneup		20.50	20.50	20.50	20.50				
802.11g	Channel/d	6Mbps	9Mbps	12Mbps	18Mbps	24Mbps	36Mbps	48Mbps	54Mbps
WLAN2450	11(2462M	16.81	/	/	/	/	/	/	/
	6(2437(M	17.52	/	/	/	/	/	/	/
	1(2412MH	18.12							
Tuneup		18.50	18.50	18.50	18.00	18.00	18.00	17.50	17.50
802.11n-20MHz	Channel/d	MCS0	MCS1	MCS2	MCS3	MCS4	MCS5	MCS6	MCS7
WLAN2450	11(2462M	16.65							
	6(2437(M	17.36							
	1(2412MH	17.37							
Tuneup		18.50	18.50	18.50	18.00	18.00	18.00	17.50	17.50

The average conducted power for BT is as following:

BR/EDR									
	GFSK			EDR2M-4_DQPSK			EDR3M-8DPSK		
	Ch0	Ch 39	Ch 78	Ch 0	Ch 39	Ch 78	Ch 0	Ch 39	Ch 78
Maximum Transmit Power(<20dBm)	10.42	10.18	10.51	9.93	9.85	9.78	9.61	9.49	9.46
Tune up	11	11	11	10.5	10.5	10.5	10.5	10.5	10.5

12 Antenna Location

12.1 Transmit Antenna Separation Distances

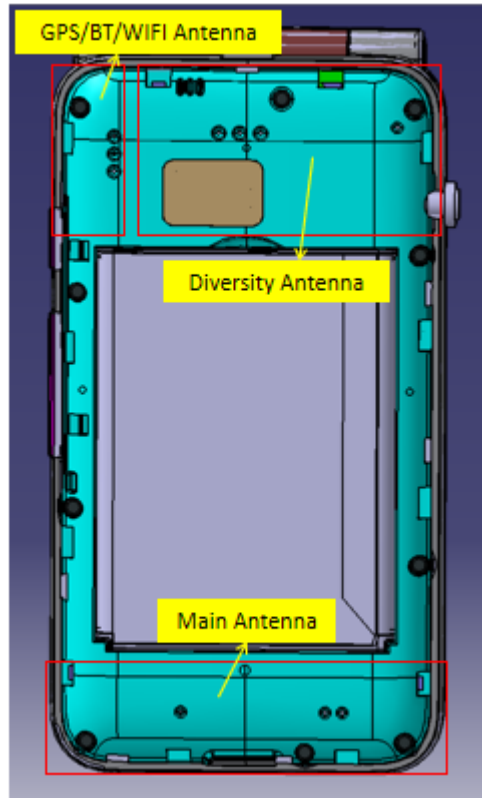

Antenna	TX Band
Main Antenna	3G: W2/4/5 4G: B2/4/5/12/13/66
GPS/BT/WIFI Antenna	GPS/BT/WIFI 2.4GHZ

12.2 SAR Measurement Positions

SAR measurement positions		
Mode	Front	Rear
Main Antenna	Yes	Yes
BT/WIFI Antenna	Yes	Yes

13 SAR Test Result

Note:

KDB 447498 D01 General RF Exposure Guidance:

For WWAN: Reported SAR(W/kg)= Measured SAR(W/kg)*Tune-up Scaling Factor

For BT/WLAN: Reported SAR(W/kg)= Measured SAR(W/kg)* Duty Cycle scaling factor * Tune-up scaling factor

Testing of other required channels within the operating mode of a frequency band is not required when the reported 1-g or 10-g SAR for the mid-band or highest output power channel is:

≤ 0.8 W/kg or 2.0 W/kg, for 1-g or 10-g respectively, when the transmission band is ≤ 100 MHz

≤ 0.6 W/kg or 1.5 W/kg, for 1-g or 10-g respectively, when the transmission band is between 100 MHz and 200 MHz

≤ 0.4 W/kg or 1.0 W/kg, for 1-g or 10-g respectively, when the transmission band is ≥ 200 MHz

KDB 648474 D04 Handset SAR:

With headset attached, when the reported SAR for body-worn accessory, measured without a headset connected to the handset, is > 1.2 W/kg, the highest reported SAR configuration for that wireless mode and frequency band should be repeated for that body-worn accessory with a headset attached to the handset.

KDB 941225 D01 SAR test for 3G devices:

When the maximum output power and tune-up tolerance specified for production units in a secondary mode is $\leq \frac{1}{4}$ dB higher than the primary mode or when the highest reported SAR of the primary mode is scaled by the ratio of specified maximum output power and tune-up tolerance of secondary to primary mode and the adjusted SAR is ≤ 1.2 W/kg, SAR measurement is not required for the secondary mode.

KDB 941225 D05 SAR for LTE Devices:

SAR test reduction is applied using the following criteria:

Start with the largest channel bandwidth and measure SAR for QPSK with 1 RB, and 50% RB allocation, using the RB offset and required test channel combination with the highest maximum output power among RB offsets at the upper edge, middle and lower edge of each required test channel.

When the reported SAR is > 0.8 W/kg, testing for other Channels is performed at the highest output power level for 1RB, and 50% RB configuration for that channel.

Testing for 100% RB configuration is performed at the highest output power level for 100% RB configuration across the Low, Mid and High Channel when the highest reported SAR for 1 RB and 50% RB are > 0.8 W/kg. Testing for the remaining required channels is not needed because the reported SAR for 100% RB Allocation < 1.45 W/kg.

Testing for 16-QAM modulation is not required because the reported SAR for QPSK is < 1.45 W/Kg and its output power is not more than 0.5 dB higher than that of QPSK.

Testing for the other channel bandwidths is not required because the reported SAR for the highest channel bandwidth is < 1.45 W/Kg and its output power is not more than 0.5 dB higher than that of the highest channel bandwidth.

For LTE bands that do not support at least three non-overlapping channels in certain channel bandwidths, test the available non-overlapping channels instead. When a device supports overlapping channel assignment in a channel bandwidth configuration, the middle channel of the

group of overlapping channels should be selected for testing; therefore, the requirement for H, M and L channels may not fully apply.

KDB 248227 D01 SAR meas for 802.11:

SAR test reduction for 802.11 Wi-Fi transmission mode configurations are considered separately for DSSS and OFDM. An initial test position is determined to reduce the number of tests required for certain exposure configurations with multiple test positions. An initial test configuration is determined for each frequency band and aggregated band according to maximum output power, channel bandwidth, wireless mode configurations and other operating parameters to streamline the measurement requirements. For 2.4 GHz DSSS, either the initial test position or DSSS procedure is applied to reduce the number of SAR tests; these are mutually exclusive. For OFDM, an initial test position is only applicable to next to the ear, UMPC mini-tablet and hotspot mode configurations, which is tested using the initial test configuration to facilitate test reduction. For other exposure conditions with a fixed test position, SAR test reduction is determined using only the initial test configuration.

To determine the initial test position, Area Scans were performed to determine the position with the Maximum Value of SAR (measured). The position that produced the highest Maximum Value of SAR is considered the worst case position; thus used as the initial test position.

The multiple test positions require SAR measurements in head, hotspot mode or UMPC mini-tablet configurations may be reduced according to the highest reported SAR determined using the initial test position(s) by applying the DSSS or OFDM SAR measurement procedures in the required wireless mode test configuration(s). The initial test position(s) is measured using the highest measured maximum output power channel in the required wireless mode test configuration(s).

When the reported SAR for the initial test position is:

≤ 0.4 W/kg, further SAR measurement is not required for the other test positions in that exposure configuration and wireless mode combination within the frequency band or aggregated band. DSSS and OFDM configurations are considered separately according to the required SAR procedures.

> 0.4 W/kg, SAR is repeated using the same wireless mode test configuration tested in the initial test position to measure the subsequent next closet/smallest test separation distance and maximum coupling test position, on the highest maximum output power channel, until the reported SAR is ≤ 0.8 W/kg or all required test positions are tested.

- For subsequent test positions with equivalent test separation distance or when exposure is dominated by coupling conditions, the position for maximum coupling condition should be tested.
- When it is unclear, all equivalent conditions must be tested.

For all positions/configurations tested using the initial test position and subsequent test positions, when the reported SAR is > 0.8 W/kg, measure the SAR for these positions/configurations on the subsequent next highest measured output power channel(s) until the reported SAR is ≤ 1.2 W/kg or all required test channels are considered.

- The additional power measurements required for this step should be limited to those necessary for identifying subsequent highest output power channels to apply the test reduction.

When the specified maximum output power is the same for both UNII 1 and UNII 2A, begin SAR measurements in UNII 2A with the channel with the highest measured output power. If the reported SAR for UNII 2A is ≤ 1.2 W/kg, SAR is not required for UNII 1; otherwise treat the remaining bands separately and test them independently for SAR.



When the specified maximum output power is different between UNII 1 and UNII 2A, begin SAR with the band that has the higher specified maximum output. If the highest reported SAR for the band with the highest specified power is ≤ 1.2 W/kg, testing for the band with the lower specified output power is not required; otherwise test the remaining bands independently for SAR.

Duty Cycle

Mode	Duty Cycle
WCDMA<E FDD	1:1

Ambient Temperature: 21.5-23.5 °C Liquid Temperature: 21.5-23.5 °C



13.1 SAR results for Cellular

Head

RF Exposure Conditions	Frequency Band	Channel Number	Frequency (MHz)	Mode/RB	Test Position	Distance	Figure No./Note	EUT Measured Power (dBm)	Tune up (dBm)	Measured SAR 1g (W/kg)	Reported SAR 1g (W/kg)	Measured SAR 10g (W/kg)	Reported SAR 10g (W/kg)	Power Drift
Head	WCDMA 1900	9400	1880	RMC	Cheek Left	0mm	\	22.59	23.5	0.346	0.43	0.181	0.22	0.09
Head	WCDMA 1900	9400	1880	RMC	Tilt Left	0mm	\	22.59	23.5	0.162	0.20	0.112	0.14	-0.17
Head	WCDMA 1900	9538	1907.6	RMC	Cheek Right	0mm	A.1	22.63	23.5	0.419	0.51	0.275	0.34	0.04
Head	WCDMA 1900	9400	1880	RMC	Cheek Right	0mm	\	22.59	23.5	0.376	0.46	0.261	0.32	0.06
Head	WCDMA 1900	9262	1852.4	RMC	Cheek Right	0mm	\	22.54	23.5	0.381	0.48	0.247	0.31	-0.17
Head	WCDMA 1900	9400	1880	RMC	Tilt Right	0mm	\	22.59	23.5	0.127	0.16	0.086	0.11	-0.12
Head	WCDMA 1700	1413	1732.6	RMC	Cheek Left	0mm	\	22.06	23.5	0.122	0.17	0.069	0.10	-0.11
Head	WCDMA 1700	1413	1732.6	RMC	Tilt Left	0mm	\	22.06	23.5	0.063	0.09	0.039	0.05	-0.11
Head	WCDMA 1700	1513	1752.6	RMC	Cheek Right	0mm	A.2	22.12	23.5	0.172	0.24	0.119	0.16	0.03
Head	WCDMA 1700	1413	1732.6	RMC	Cheek Right	0mm	\	22.06	23.5	0.152	0.21	0.1	0.14	-0.07
Head	WCDMA 1700	1312	1712.4	RMC	Cheek Right	0mm	\	22.01	23.5	0.12	0.17	0.076	0.11	-0.06
Head	WCDMA 1700	1413	1732.6	RMC	Tilt Right	0mm	\	22.06	23.5	0.064	0.09	0.045	0.06	0.19
Head	WCDMA 850	4233	846.6	RMC	Cheek Left	0mm	\	22.57	24	0.362	0.50	0.27	0.38	-0.03
Head	WCDMA 850	4183	836.6	RMC	Cheek Left	0mm	\	22.61	24	0.403	0.56	0.298	0.41	0.06
Head	WCDMA 850	4132	826.4	RMC	Cheek Left	0mm	A.3	22.57	24	0.409	0.57	0.302	0.42	0.02
Head	WCDMA 850	4183	836.6	RMC	Tilt Left	0mm	\	22.61	24	0.192	0.26	0.151	0.21	-0.11
Head	WCDMA 850	4183	836.6	RMC	Cheek Right	0mm	\	22.61	24	0.383	0.53	0.284	0.39	-0.09
Head	WCDMA 850	4183	836.6	RMC	Tilt Right	0mm	\	22.61	24	0.195	0.27	0.149	0.21	0.16
Head	LTE Band2	19100	1900	1RB-Mid	Cheek Left	0mm	A.4	24.42	24.5	0.815	0.83	0.528	0.54	-0.02
Head	LTE Band2	18900	1880	1RB-Mid	Cheek Left	0mm	\	24.39	24.5	0.778	0.80	0.496	0.51	-0.02
Head	LTE Band2	18700	1860	1RB-Mid	Cheek Left	0mm	\	24.39	24.5	0.742	0.76	0.464	0.48	-0.02
Head	LTE Band2	19100	1900	1RB-Mid	Tilt Left	0mm	\	24.42	24.5	0.283	0.29	0.207	0.21	0.13
Head	LTE Band2	19100	1900	1RB-Mid	Cheek Right	0mm	\	24.42	24.5	0.642	0.65	0.432	0.44	0.15
Head	LTE Band2	19100	1900	1RB-Mid	Tilt Right	0mm	\	24.42	24.5	0.183	0.19	0.131	0.13	-0.08
Head	LTE Band2	19100	1900	50RB-Mid	Cheek Left	0mm	\	23.39	23.5	0.634	0.65	0.4	0.41	-0.03
Head	LTE Band2	19100	1900	50RB-Mid	Tilt Left	0mm	\	23.39	23.5	0.215	0.22	0.155	0.16	0.13
Head	LTE Band2	19100	1900	50RB-Mid	Cheek Right	0mm	\	23.39	23.5	0.486	0.50	0.324	0.33	-0.01
Head	LTE Band2	19100	1900	50RB-Mid	Tilt Right	0mm	\	23.39	23.5	0.144	0.15	0.108	0.11	-0.15
Head	LTE Band2	19100	1900	100RB	Cheek Left	0mm	\	23.28	23.5	0.758	0.80	0.469	0.49	0.16
Head	LTE Band5	20525	836.5	1RB-Mid	Cheek Left	0mm	\	23.95	25	0.587	0.75	0.391	0.50	-0.03
Head	LTE Band5	20525	836.5	1RB-Mid	Tilt Left	0mm	\	23.95	25	0.295	0.38	0.207	0.26	-0.07
Head	LTE Band5	20600	844	1RB-Mid	Cheek Right	0mm	\	23.87	25	0.624	0.81	0.408	0.53	0.06
Head	LTE Band5	20525	836.5	1RB-Mid	Cheek Right	0mm	A.5	23.95	25	0.666	0.85	0.431	0.55	0.09
Head	LTE Band5	20450	829	1RB-Mid	Cheek Right	0mm	\	23.85	25	0.647	0.84	0.413	0.54	0.03
Head	LTE Band5	20525	836.5	1RB-Mid	Tilt Right	0mm	\	23.95	25	0.364	0.46	0.253	0.32	-0.04
Head	LTE Band5	20525	836.5	25RB-Low	Cheek Left	0mm	\	22.96	24	0.5	0.64	0.333	0.42	-0.06
Head	LTE Band5	20525	836.5	25RB-Low	Tilt Left	0mm	\	22.96	24	0.231	0.29	0.163	0.21	0.07
Head	LTE Band5	20525	836.5	25RB-Low	Cheek Right	0mm	\	22.96	24	0.543	0.69	0.352	0.45	0.10
Head	LTE Band5	20525	836.5	25RB-Low	Tilt Right	0mm	\	22.96	24	0.289	0.37	0.199	0.25	0.08
Head	LTE Band5	20525	836.5	100RB	Cheek Right	0mm	\	22.92	24	0.536	0.69	0.343	0.44	0.08
Head	LTE Band12	23130	711	1RB-Mid	Cheek Left	0mm	A.6	23.48	24	0.337	0.38	0.22	0.25	-0.18
Head	LTE Band12	23130	711	1RB-Mid	Tilt Left	0mm	\	23.48	24	0.093	0.10	0.066	0.07	-0.10
Head	LTE Band12	23130	711	1RB-Mid	Cheek Right	0mm	\	23.48	24	0.312	0.35	0.201	0.23	0.06
Head	LTE Band12	23130	711	1RB-Mid	Tilt Right	0mm	\	23.48	24	0.145	0.16	0.099	0.11	-0.05
Head	LTE Band12	23095	707.5	25RB-Low	Cheek Left	0mm	\	22.51	23	0.274	0.31	0.179	0.20	-0.03
Head	LTE Band12	23095	707.5	25RB-Low	Tilt Left	0mm	\	22.51	23	0.061	0.07	0.042	0.05	0.08
Head	LTE Band12	23095	707.5	25RB-Low	Cheek Right	0mm	\	22.51	23	0.189	0.21	0.122	0.14	-0.16
Head	LTE Band12	23095	707.5	25RB-Low	Tilt Right	0mm	\	22.51	23	0.112	0.13	0.077	0.09	-0.10
Head	LTE Band13	23230	782	1RB-Mid	Cheek Left	0mm	A.7	23.85	25	0.508	0.66	0.327	0.43	-0.13
Head	LTE Band13	23230	782	1RB-Mid	Tilt Left	0mm	\	23.85	25	0.279	0.36	0.191	0.25	0.08
Head	LTE Band13	23230	782	1RB-Mid	Cheek Right	0mm	\	23.85	25	0.463	0.60	0.295	0.38	0.13
Head	LTE Band13	23230	782	1RB-Mid	Tilt Right	0mm	\	23.85	25	0.3	0.39	0.202	0.26	-0.07
Head	LTE Band13	23230	782	25RB-Mid	Cheek Left	0mm	\	22.81	24	0.435	0.57	0.279	0.37	-0.19
Head	LTE Band13	23230	782	25RB-Mid	Tilt Left	0mm	\	22.81	24	0.21	0.28	0.145	0.19	0.13
Head	LTE Band13	23230	782	25RB-Mid	Cheek Right	0mm	\	22.81	24	0.405	0.53	0.257	0.34	0.04
Head	LTE Band13	23230	782	25RB-Mid	Tilt Right	0mm	\	22.81	24	0.242	0.32	0.163	0.21	0.13
Head	LTE Band66	132322	1745	1RB-Mid	Cheek Left	0mm	A.8	24.17	24.5	0.361	0.39	0.222	0.24	0.03
Head	LTE Band66	132322	1745	1RB-Mid	Tilt Left	0mm	\	24.17	24.5	0.104	0.11	0.081	0.09	-0.15
Head	LTE Band66	132322	1745	1RB-Mid	Cheek Right	0mm	\	24.17	24.5	0.252	0.27	0.175	0.19	0.02
Head	LTE Band66	132322	1745	1RB-Mid	Tilt Right	0mm	\	24.17	24.5	0.111	0.12	0.086	0.09	0.12
Head	LTE Band66	132322	1745	50RB-Low	Cheek Left	0mm	\	23.19	23.5	0.281	0.30	0.167	0.18	0.09
Head	LTE Band66	132322	1745	50RB-Low	Tilt Left	0mm	\	23.19	23.5	0.083	0.09	0.057	0.06	-0.03
Head	LTE Band66	132322	1745	50RB-Low	Cheek Right	0mm	\	23.19	23.5	0.204	0.22	0.141	0.15	0.06
Head	LTE Band66	132322	1745	50RB-Low	Tilt Right	0mm	\	23.19	23.5	0.087	0.09	0.06	0.06	-0.15



No.I22Z61006-SEM10

Body

H: Headset

RF Exposure Conditions	Frequency Band	Channel Number	Frequency (MHz)	Mode/RB	Test Position	Distance	Figure No./Note	EUT Measured Power (dBm)	Tune up (dBm)	Measured SAR 1g (W/kg)	Reported SAR 1g (W/kg)	Measured SAR 10g (W/kg)	Reported SAR 10g (W/kg)	Power Drift
Body	WCDMA 1900	9400	1880	RMC	Front	15mm	\	20.95	22	0.269	0.34	0.171	0.22	-0.03
Body	WCDMA 1900	9538	1907.6	RMC	Rear	15mm	\	21.05	22	1.035	1.29	0.595	0.74	0.04
Body	WCDMA 1900	9400	1880	RMC	Rear	15mm	A.9	20.95	22	1.05	1.34	0.611	0.78	0.08
Body	WCDMA 1900	9262	1852.4	RMC	Rear	15mm	\	20.91	22	1.04	1.34	0.621	0.80	0.01
Body	WCDMA 1900	9538	1907.6	RMC	Open Rear	15mm	\	21.05	22	0.884	1.10	0.527	0.66	-0.03
Body	WCDMA 1900	9400	1880	RMC	Open Rear	15mm	\	20.95	22	0.863	1.10	0.507	0.65	-0.17
Body	WCDMA 1900	9262	1852.4	RMC	Open Rear	15mm	\	20.91	22	0.851	1.09	0.514	0.66	0.08
Body	WCDMA 1900	9400	1880	RMC	Rear	15mm	H1	20.95	22	0.84	1.07	0.483	0.62	0.09
Body	WCDMA 1700	1413	1732.6	RMC	Front	15mm	\	18.25	19	0.072	0.09	0.045	0.05	0.12
Body	WCDMA 1700	1513	1752.6	RMC	Rear	15mm	\	18.16	19	0.796	0.97	0.435	0.53	0.11
Body	WCDMA 1700	1413	1732.6	RMC	Rear	15mm	A.10	18.25	19	1.01	1.20	0.553	0.66	0.04
Body	WCDMA 1700	1312	1712.4	RMC	Rear	15mm	\	18.29	19	0.62	0.73	0.342	0.40	0.17
Body	WCDMA 1700	1513	1752.6	RMC	Open Rear	15mm	\	18.16	19	0.548	0.66	0.310	0.38	0.05
Body	WCDMA 1700	1413	1732.6	RMC	Open Rear	15mm	\	18.25	19	0.708	0.84	0.396	0.47	-0.17
Body	WCDMA 1700	1312	1712.4	RMC	Open Rear	15mm	\	18.29	19	0.893	1.05	0.498	0.59	0.12
Body	WCDMA 850	4183	836.6	RMC	Front	15mm	\	22.61	24	0.084	0.12	0.065	0.09	0.01
Body	WCDMA 850	4233	846.6	RMC	Rear	15mm	\	22.57	24	0.348	0.48	0.242	0.34	0.05
Body	WCDMA 850	4183	836.6	RMC	Rear	15mm	\	22.61	24	0.388	0.53	0.275	0.38	-0.13
Body	WCDMA 850	4132	826.4	RMC	Rear	15mm	A.11	22.57	24	0.434	0.60	0.307	0.43	0.08
Body	WCDMA 850	4183	836.6	RMC	Open Rear	15mm	\	22.61	24	0.229	0.32	0.156	0.21	-0.07
Body	LTE Band2	19100	1900	1RB-Mid	Front	15mm	\	22.54	23	0.225	0.25	0.141	0.16	-0.09
Body	LTE Band2	19100	1900	1RB-Mid	Rear	15mm	\	22.54	23	1.138	1.27	0.632	0.70	0.09
Body	LTE Band2	18900	1880	1RB-Mid	Rear	15mm	\	22.51	23	1.048	1.17	0.586	0.66	0.06
Body	LTE Band2	18700	1860	1RB-Mid	Rear	15mm	\	22.52	23	0.927	1.04	0.528	0.59	0.19
Body	LTE Band2	19100	1900	1RB-Mid	Open Rear	15mm	A.12	22.54	23	1.14	1.27	0.648	0.72	0.02
Body	LTE Band2	18900	1880	1RB-Mid	Open Rear	15mm	\	22.51	23	1.08	1.21	0.604	0.68	0.03
Body	LTE Band2	18700	1860	1RB-Mid	Open Rear	15mm	\	22.54	23	0.992	1.10	0.582	0.65	0.17
Body	LTE Band2	19100	1900	50RB-Low	Front	15mm	\	21.51	22	0.241	0.27	0.135	0.15	-0.11
Body	LTE Band2	19100	1900	50RB-Low	Rear	15mm	\	21.51	22	0.986	1.10	0.551	0.62	0.05
Body	LTE Band2	18900	1880	50RB-Low	Rear	15mm	\	21.50	22	0.917	1.03	0.536	0.60	0.01
Body	LTE Band2	18700	1860	50RB-Low	Rear	15mm	\	21.44	22	0.949	1.08	0.543	0.62	0.09
Body	LTE Band2	19100	1900	50RB-Low	Open Rear	15mm	\	21.51	22	0.886	0.99	0.502	0.56	0.01
Body	LTE Band2	18900	1880	50RB-Low	Open Rear	15mm	\	21.50	22	0.814	0.91	0.476	0.53	0.08
Body	LTE Band2	18700	1860	50RB-Low	Open Rear	15mm	\	21.44	22	0.823	0.94	0.481	0.55	0.09
Body	LTE Band2	18900	1880	100RB	Rear	15mm	\	21.45	22	0.882	1.00	0.497	0.56	0.13
Body	LTE Band2	18900	1880	100RB	Open Rear	15mm	\	21.45	22	0.764	0.87	0.481	0.55	0.13
Body	LTE Band5	20525	836.5	1RB-Mid	Front	15mm	\	23.95	25	0.097	0.12	0.076	0.10	-0.06
Body	LTE Band5	20525	836.5	1RB-Mid	Rear	15mm	A.13	23.95	25	0.374	0.48	0.27	0.34	-0.01
Body	LTE Band5	20525	836.5	1RB-Mid	Open Rear	15mm	\	23.95	25	0.244	0.31	0.184	0.23	0.08
Body	LTE Band5	20525	836.5	25RB-Low	Front	15mm	\	22.96	24	0.068	0.09	0.054	0.07	-0.12
Body	LTE Band5	20525	836.5	25RB-Low	Rear	15mm	\	22.96	24	0.301	0.38	0.214	0.27	-0.10
Body	LTE Band5	20525	836.5	25RB-Low	Open Rear	15mm	\	22.96	24	0.196	0.25	0.148	0.19	-0.16
Body	LTE Band12	23130	711	1RB-Mid	Front	15mm	\	23.48	24	0.052	0.06	0.04	0.05	-0.08
Body	LTE Band12	23130	711	1RB-Mid	Rear	15mm	\	23.48	24	0.145	0.16	0.103	0.12	0.10
Body	LTE Band12	23130	711	1RB-Mid	Open Rear	15mm	A.14	23.48	24	0.293	0.33	0.21	0.24	-0.09
Body	LTE Band12	23095	707.5	25RB-Low	Front	15mm	\	22.51	23	0.048	0.05	0.036	0.04	-0.04
Body	LTE Band12	23095	707.5	25RB-Low	Rear	15mm	\	22.51	23	0.116	0.13	0.083	0.09	-0.04
Body	LTE Band12	23095	707.5	25RB-Low	Open Rear	15mm	\	22.51	23	0.204	0.23	0.143	0.16	0.04
Body	LTE Band13	23230	782	1RB-Mid	Front	15mm	\	23.85	25	0.098	0.13	0.071	0.09	-0.05
Body	LTE Band13	23230	782	1RB-Mid	Rear	15mm	A.15	23.85	25	0.272	0.35	0.185	0.24	0.07
Body	LTE Band13	23230	782	1RB-Mid	Open Rear	15mm	\	23.85	25	0.195	0.25	0.132	0.17	-0.03
Body	LTE Band13	23230	782	25RB-Mid	Front	15mm	\	22.81	24	0.073	0.10	0.052	0.07	-0.10
Body	LTE Band13	23230	782	25RB-Mid	Rear	15mm	\	22.81	24	0.212	0.28	0.144	0.19	-0.07
Body	LTE Band13	23230	782	25RB-Mid	Open Rear	15mm	\	22.81	24	0.161	0.21	0.109	0.14	-0.18
Body	LTE Band66	132322	1745	1RB-Mid	Front	15mm	\	20.91	21	0.108	0.11	0.067	0.07	0.19
Body	LTE Band66	132322	1770	1RB-Mid	Rear	15mm	\	20.89	21	0.608	0.62	0.348	0.36	-0.09
Body	LTE Band66	132322	1745	1RB-Mid	Rear	15mm	\	20.91	21	0.76	0.78	0.423	0.43	0.14
Body	LTE Band66	132072	1720	1RB-Mid	Rear	15mm	A.16	20.97	21	0.962	0.97	0.527	0.53	0.02
Body	LTE Band66	132322	1745	1RB-Mid	Open Rear	15mm	\	20.91	21	0.707	0.72	0.394	0.40	-0.06
Body	LTE Band66	132322	1745	50RB-Low	Front	15mm	\	19.94	20	0.068	0.07	0.043	0.04	-0.05
Body	LTE Band66	132322	1745	50RB-Low	Rear	15mm	\	19.94	20	0.594	0.60	0.329	0.33	-0.15
Body	LTE Band66	132322	1745	50RB-Low	Open Rear	15mm	\	19.94	20	0.576	0.58	0.321	0.33	-0.10
Body	LTE Band66	132322	1745	100RB	Rear	15mm	\	19.91	20	0.596	0.61	0.331	0.34	-0.17

13.2 SAR results for WLAN/BT

The maximum output power specified for production units are determined for all applicable 802.11 transmission modes in each standalone and aggregated frequency band. Maximum output power is measured for the highest maximum output power configuration(s) in each frequency band according to the default power measurement procedures.

When the same transmission mode configurations have the same maximum output power on the same channel for the 802.11 a/g/n/ac/ax modes, the channel in the lower order/sequence 802.11 mode (i.e. a, g, n ac then ax) is selected.

SAR Test reduction was applied from KDB 248227 guidance, when the same maximum power is specified for multiple transmission modes in a frequency band, the largest channel bandwidth, lowest order modulation, lowest data rate and lowest order 802.11a/g/n/ac mode is used for SAR measurement, on the highest measured output power channel in the initial test configuration, for each frequency band. Additional output power measurements were not deemed necessary.

Duty factor plot

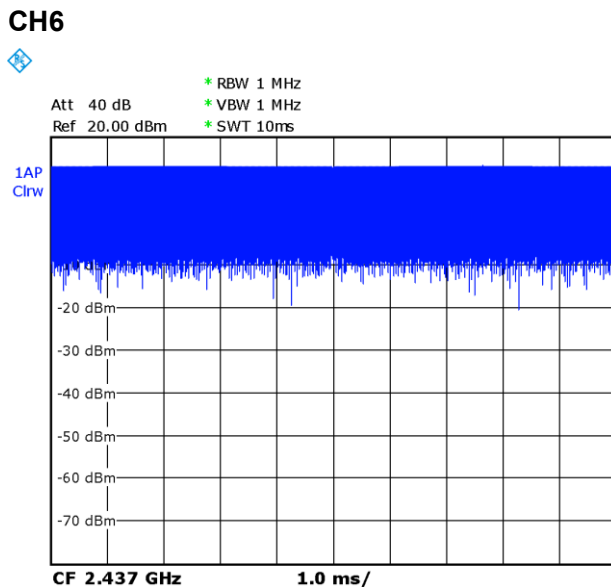

WLAN 2.4G SISO

Test Position	Frequency Band	Channel Number	Frequency (MHz)	Mode/RB	Test Position	Distance	Figure No./Note	EUT Measured Power (dBm)	Tune up (dBm)	Duty Cycle	Measured SAR 1g (W/kg)	Reported SAR 1g (W/kg)	Measured SAR 10g (W/kg)	Reported SAR 10g (W/kg)	Power Drift
Head	WLAN 2.4G	1	2412	11b	Cheek Left	0mm	\	19.57	20.5	100%	0.187	0.23	0.088	0.11	-0.18
Head	WLAN 2.4G	1	2412	11b	Tilt Left	0mm	\	19.57	20.5	100%	0.142	0.18	0.068	0.08	0.12
Head	WLAN 2.4G	1	2412	11b	Cheek Right	0mm	A.17	19.57	20.5	100%	0.470	0.58	0.233	0.29	0.05
Head	WLAN 2.4G	1	2412	11b	Tilt Right	0mm	\	19.57	20.5	100%	0.119	0.15	0.068	0.08	-0.16
Body	WLAN 2.4G	1	2412	11b	Front	15mm	\	19.57	20.5	100%	0.035	0.04	0.019	0.02	0.15
Body	WLAN 2.4G	1	2412	11b	Rear	15mm	A.18	19.57	20.5	100%	0.057	0.07	0.029	0.04	0.05
Body	WLAN 2.4G	1	2412	11b	Open Rear	15mm	\	19.57	20.5	100%	0.051	0.06	0.028	0.03	-0.08

BT

RF Exposure Conditions	Frequency Band	Channel Number	Frequency (MHz)	Mode/RB	Test Position	Distance	Figure No./Note	EUT Measured Power (dBm)	Tune up (dBm)	Measured SAR 1g (W/kg)	Reported SAR 1g (W/kg)	Measured SAR 10g (W/kg)	Reported SAR 10g (W/kg)	Power Drift
Head	BT	0	2437	GFSK	Cheek Left	0mm	\	10.42	11	<0.01	<0.01	<0.01	<0.01	\
Head	BT	0	2437	GFSK	Tilt Left	0mm	\	10.42	11	<0.01	<0.01	<0.01	<0.01	\
Head	BT	0	2437	GFSK	Cheek Right	0mm	\	10.42	11	<0.01	<0.01	<0.01	<0.01	\
Head	BT	0	2437	GFSK	Tilt Right	0mm	\	10.42	11	<0.01	<0.01	<0.01	<0.01	\
Body	BT	0	2437	GFSK	Front	15mm	\	10.42	11	<0.01	<0.01	<0.01	<0.01	\
Body	BT	0	2437	GFSK	Rear	15mm	\	10.42	11	<0.01	<0.01	<0.01	<0.01	\
Body	BT	0	2437	GFSK	Open Rear	15mm	\	10.42	11	<0.01	<0.01	<0.01	<0.01	\

14 SAR Measurement Variability

SAR measurement variability must be assessed for each frequency band, which is determined by the SAR probe calibration point and tissue-equivalent medium used for the device measurements. When both head and body tissue-equivalent media are required for SAR measurements in a frequency band, the variability measurement procedures should be applied to the tissue medium with the highest measured SAR, using the highest measured SAR configuration for that tissue-equivalent medium.

The following procedures are applied to determine if repeated measurements are required.

- 1) Repeated measurement is not required when the original highest measured SAR is < 0.80 W/kg; steps 2) through 4) do not apply.
- 2) When the original highest measured SAR is ≥ 0.80 W/kg, repeat that measurement once.
- 3) Perform a second repeated measurement only if the ratio of largest to smallest SAR for the original and first repeated measurements is > 1.20 or when the original or repeated measurement is ≥ 1.45 W/kg (~ 10% from the 1-g SAR limit).
- 4) Perform a third repeated measurement only if the original, first or second repeated measurement is ≥ 1.5 W/kg and the ratio of largest to smallest SAR for the original, first and second repeated measurements is > 1.20 .

Frequency Band	Channel Number	Frequency (MHz)	Mode/RB	Test Position	Distance	Highest Measured SAR (W/kg)	First Repeated SAR (W/kg)	The Ratio	Second Repeated SAR (W/kg)
WCDMA1900	9538	1907.6	RMC	Rear	15mm	1.14	1.08	1.06	/
WCDMA1900	9400	1880	RMC	Rear	15mm	1.11	1.04	1.07	/
WCDMA1900	9262	1852.4	RMC	Rear	15mm	1.098	0.994	1.10	/
WCDMA1900	9538	1907.6	RMC	Open Rear	15mm	0.902	0.871	1.04	/
WCDMA1900	9400	1880	RMC	Open Rear	15mm	0.941	0.913	1.03	/
WCDMA1900	9262	1852.4	RMC	Open Rear	15mm	0.886	0.857	1.03	/
WCDMA1700	1513	1752.6	RMC	Rear	15mm	0.839	0.816	1.03	/
WCDMA1700	1413	1732.6	RMC	Rear	15mm	1.002	0.985	1.02	/
WCDMA1700	1312	1712.4	RMC	Rear	15mm	1.13	1.08	1.05	/
WCDMA1700	1513	1752.6	RMC	Open Rear	15mm	0.808	0.785	1.03	/
WCDMA1700	1413	1732.6	RMC	Open Rear	15mm	0.907	0.883	1.03	/
WCDMA1700	1312	1712.4	RMC	Open Rear	15mm	0.856	0.827	1.04	/
LTE Band4	20300	1745	1RB-Mid	Rear	15mm	0.882	0.853	1.03	/
LTE Band4	20175	1732.5	1RB-Mid	Rear	15mm	0.984	0.977	1.01	/
LTE Band4	20050	1720	1RB-Mid	Rear	15mm	1.09	0.993	1.10	/
LTE Band4	20300	1745	50RB-Mid	Rear	15mm	0.802	0.793	1.01	/
LTE Band4	20175	1732.5	50RB-Mid	Rear	15mm	0.816	0.803	1.02	/
LTE Band4	20050	1720	50RB-Mid	Rear	15mm	0.849	0.822	1.03	/
LTE Band4	20050	1720	100RB	Rear	15mm	0.821	0.803	1.02	/

15 Evaluation of Simultaneous

15.1 Introduction

The following procedures adopted from “FCC SAR Considerations for Cell Phones with Multiple Transmitters” are applicable to handsets with built-in unlicensed transmitters such as WLAN and Bluetooth devices which may simultaneously transmit with the licensed transmitter. KDB 447498 D01 provides two procedures for determining simultaneous transmission SAR test exclusion: Sum of SAR and SAR to Peak Location Ratio (SPLSR)

15.1.1 Sum of SAR

To qualify for simultaneous transmission SAR test exclusion based upon Sum of SAR the sum of the reported standalone SARs for all simultaneously transmitting antennas shall be below the applicable standalone SAR limit. If the sum of the SARs is above the applicable limit then simultaneous transmission SAR test exclusion may still apply if the requirements of the SAR to Peak Location Ratio (SPLSR) evaluation are met.

15.1.2 SAR to Peak Location Ratio (SPLSR)

KDB 447498 D01 General RF Exposure Guidance explains how to calculate the SAR to Peak Location Ratio (SPLSR) between pairs of simultaneously transmitting antennas:

$$SPLSR = (SAR1 + SAR2)^{1.5} / Ri$$

Where:

SAR1 is the highest reported or estimated SAR for the first of a pair of simultaneous transmitting antennas, in a specific test operating mode and exposure condition.

SAR2 is the highest reported or estimated SAR for the second of a pair of simultaneous transmitting antennas, in the same test operating mode and exposure condition as the first .

Ri is the separation distance between the pair of simultaneous transmitting antennas. When the SAR is measured, for both antennas in the pair, it is determined by the actual x, y and z coordinates in the 1-g SAR for each SAR peak location, based on the extrapolated and interpolated result in the zoom scan measurement, using the formula of

$$[(x1-x2)^2 + (y1-y2)^2 + (z1-z2)^2]$$

In order for a pair of simultaneous transmitting antennas with the sum of 1-g SAR > 1.6 W/kg to qualify for exemption from Simultaneous Transmission SAR measurements, it has to satisfy the condition of:

$$(SAR1 + SAR2)^{1.5} / Ri \leq 0.04$$

When an individual antenna transmits at on two bands simultaneously, the sum of the highest reported SAR for the frequency bands should be used to determine *SAR1* or *SAR2*. When SPLSR is necessary, the smallest distance between the peak SAR locations for the antenna pair with respect to the peaks from each antenna should be used.

15.2 Simultaneous Transmission Capabilities

The simultaneous transmission possibilities for this device are listed as below:

Capable Transmit Configurations	Head	Body
Cellular+ BT	Yes	Yes
Cellular+ Wi-Fi 2.4G SISO	Yes	Yes

Note:

1. Wi-Fi 2.4GHz & Bluetooth can not transmit simultaneously.
2. WWAN cannot transmit simultaneously.
3. The reported SAR summation is calculated based on the same configuration and test position.
4. For the convenience of simultaneous transmission calculation, all SAR values less than 0.01 are uniformly written as 0.00

15.3 SAR Simultaneous Transmission Analysis

reported SAR 1g (W/kg)													
Head		WCDMA850	WCDMA1700	WCDMA1900	LTE Band2	LTE Band5	LTE Band12	LTE Band13	LTE Band66	2.4G	BT	+WiFi2.4G	+BT
Cheek	L	0.57	0.17	0.43	0.83	0.75	0.38	0.66	0.39	0.23	0	1.06	0.83
Tilt	L	0.26	0.09	0.2	0.29	0.38	0.1	0.36	0.11	0.18	0	0.56	0.38
Cheek	R	0.53	0.24	0.51	0.65	0.85	0.35	0.6	0.27	0.58	0	1.43	0.85
Tilt	R	0.27	0.09	0.16	0.19	0.46	0.16	0.39	0.12	0.15	0	0.61	0.46
Body		WCDMA850	WCDMA1700	WCDMA1900	LTE Band2	LTE Band5	LTE Band12	LTE Band13	LTE Band66	2.4G	BT	+WiFi2.4G	+BT
Front	15mm	0.12	0.09	0.34	0.25	0.12	0.06	0.13	0.11	0.04	0	0.38	0.34
Close Rear	15mm	0.6	1.2	1.34	1.27	0.48	0.16	0.35	0.97	0.07	0	1.41	1.34
Open Rear	15mm	0.32	1.05	1.1	1.27	0.31	0.33	0.25	0.72	0.06	0	1.33	1.27

15.4 Conclusion

According to the above tables, the highest simultaneous transmission reported SAR values is **1.43W/kg (1g)**. The sum of reported SAR values is <1.6W/kg. So the simultaneous transmission SAR with volume scans is not required.

16 Measurement Uncertainty

Per KDB 865664 D01 SAR Measurement 100 MHz to 6 GHz, when the highest measured 1-g SAR within a frequency band is < 1.5 W/kg and the measured 10-g SAR within a frequency band is < 3.75 W/kg. The expanded SAR measurement uncertainty must be $\leq 30\%$, for a confidence interval of $k = 2$. If these conditions are met, extensive SAR measurement uncertainty analysis described in IEEE Std 1528-2013 is not required in SAR reports submitted for equipment approval.

Therefore, the measurement uncertainty is not required.

17 MAIN TEST INSTRUMENTS

No.	Name	Type	Serial Number	Calibration Date	Valid Period
01	Network analyzer	E5071C	MY46110673	January 14, 2022	One year
02	Power meter	NRP2	106277	September 24, 2021	One year
03	Power sensor	NRP8S	104291		
04	Signal Generator	E4438C	MY49071430	January 13, 2022	One Year
05	Amplifier	60S1G4	0331848	No Calibration Requested	
06	BTS	CMW500	159850	January 24, 2022	One year
07	E-field Probe	SPEAG EX3DV4	7517	January 19, 2022	One year
08	DAE	SPEAG DAE4	1525	September 1, 2021	One year
09	Dipole Validation Kit	SPEAG D750V3	1017	July 12,2021	One year
10	Dipole Validation Kit	SPEAG D835V2	4d069	July 12,2021	One year
11	Dipole Validation Kit	SPEAG D1750V2	1003	July 12,2021	One year
12	Dipole Validation Kit	SPEAG D1900V2	5d101	July 15,2021	One year
13	Dipole Validation Kit	SPEAG D2450V2	853	July 26,2021	One year

END OF REPORT BODY



Appendixes

Refer to separated files for the following appendixes

ANNEX A Graph Results

ANNEX B System Verification Results

ANNEX C SAR Measurement Setup

ANNEX D Position of the wireless device in relation to the phantom

ANNEX E Equivalent Media Recipes

ANNEX F System Validation

ANNEX G Probe Calibration Certificate

ANNEX H Dipole Calibration Certificate

ANNEX I Accreditation Certificate

ANNEX A Graph Results

W1900 Head

Date/Time: 7/12/2022

Electronics: DAE4 Sn1525

Medium: H700-6000M

Medium parameters used (interpolated): $f = 1907.6$ MHz; $\sigma = 1.471$ S/m; $\epsilon_r = 40.877$; $\rho = 1000$ kg/m³

Ambient Temperature: 23.3°C Liquid Temperature: 22.5°C

Communication System: UID 0, WCDMA 1900 (0) Frequency: 1907.6 MHz Duty Cycle: 1:1

Probe: EX3DV4 - SN7517 ConvF(7.74, 7.74, 7.74); Calibrated: 1/19/2022

Area Scan (61x171x1): Interpolated grid: dx=1.500 mm, dy=1.500 mm

Maximum value of SAR (interpolated) = 0.589 W/kg

Zoom Scan (5x5x7)/Cube 0: Measurement grid: dx=8mm, dy=8mm, dz=5mm

Reference Value = 2.061 V/m; Power Drift = 0.04 dB

Peak SAR (extrapolated) = 0.625 W/kg

SAR(1 g) = 0.419 W/kg; SAR(10 g) = 0.275 W/kg

Maximum value of SAR (measured) = 0.542 W/kg

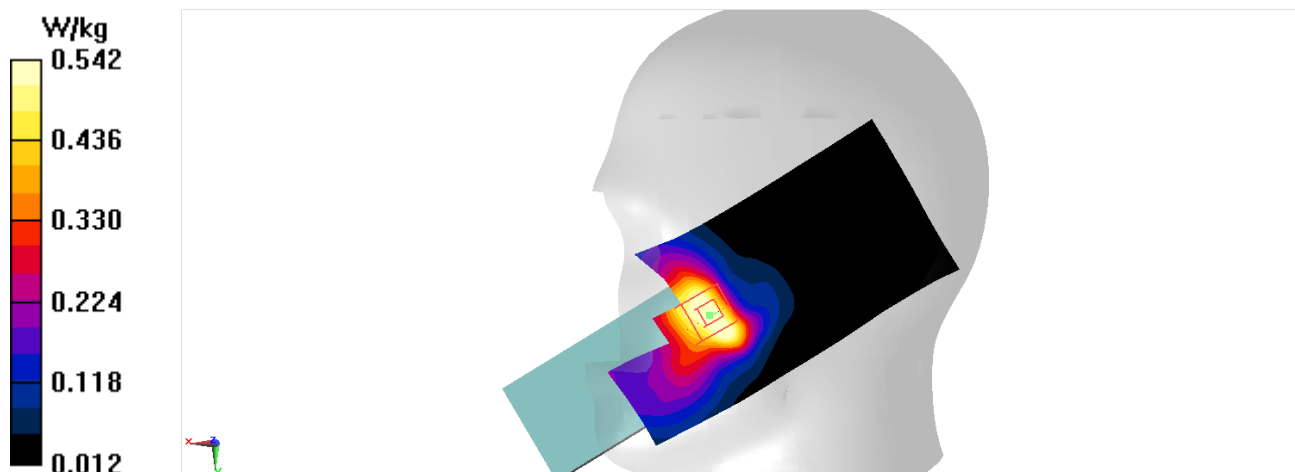

W1700 Head

Date/Time: 7/10/2022

Electronics: DAE4 Sn1525

Medium: H700-6000M

Medium parameters used (interpolated): $f = 1752.6$ MHz; $\sigma = 1.372$ S/m; $\epsilon_r = 41.065$; $\rho = 1000$ kg/m³

Ambient Temperature: 23.3°C Liquid Temperature: 22.5°C

Communication System: UID 0, WCDMA 1700 Band4 (0) Frequency: 1752.6 MHz Duty Cycle: 1:1

Probe: EX3DV4 - SN7517 ConvF(8.1, 8.1, 8.1); Calibrated: 1/19/2022

Area Scan (61x171x1): Interpolated grid: dx=1.500 mm, dy=1.500 mm

Maximum value of SAR (interpolated) = 0.243 W/kg

Zoom Scan (5x5x7)/Cube 0: Measurement grid: dx=8mm, dy=8mm, dz=5mm

Reference Value = 2.129 V/m; Power Drift = 0.03 dB

Peak SAR (extrapolated) = 0.240 W/kg

SAR(1 g) = 0.172 W/kg; SAR(10 g) = 0.119 W/kg

Maximum value of SAR (measured) = 0.212 W/kg

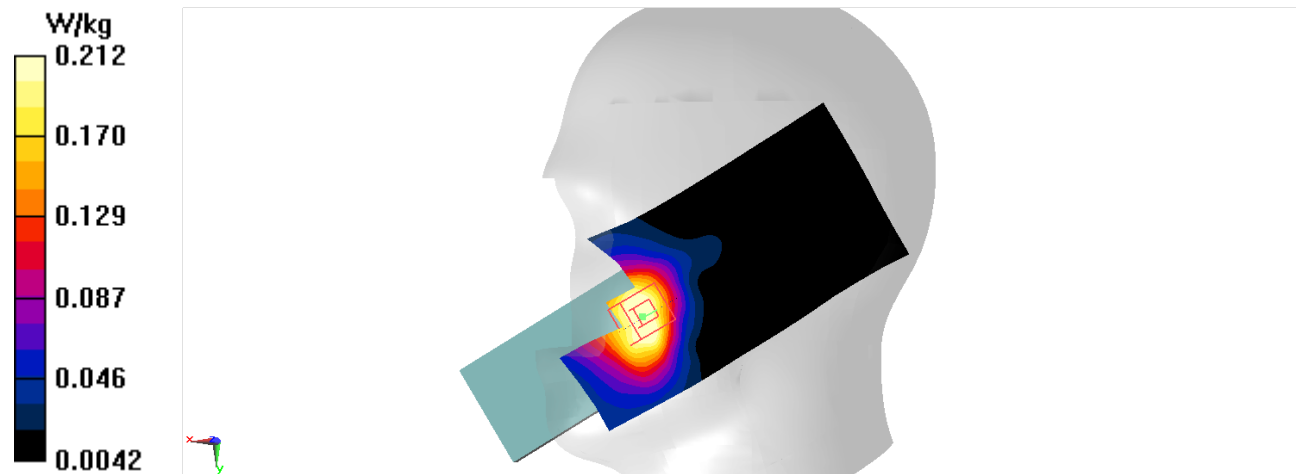

W850 Head

Date/Time: 7/1/2022

Electronics: DAE4 Sn1525

Medium: H700-6000M

Medium parameters used (interpolated): $f = 826.4$ MHz; $\sigma = 0.907$ S/m; $\epsilon_r = 43.09$; $\rho = 1000$ kg/m³

Ambient Temperature: 23.3°C Liquid Temperature: 22.5°C

Communication System: UID 0, WCDMA 850 (0) Frequency: 826.4 MHz Duty Cycle: 1:1

Probe: EX3DV4 - SN7517 ConvF(9.7, 9.7, 9.7); Calibrated: 1/19/2022

Area Scan (61x171x1): Interpolated grid: dx=1.500 mm, dy=1.500 mm

Maximum value of SAR (interpolated) = 0.529 W/kg

Zoom Scan (5x5x7)/Cube 0: Measurement grid: dx=8mm, dy=8mm, dz=5mm

Reference Value = 13.02 V/m; Power Drift = 0.02 dB

Peak SAR (extrapolated) = 0.560 W/kg

SAR(1 g) = 0.409 W/kg; SAR(10 g) = 0.302 W/kg

Maximum value of SAR (measured) = 0.494 W/kg

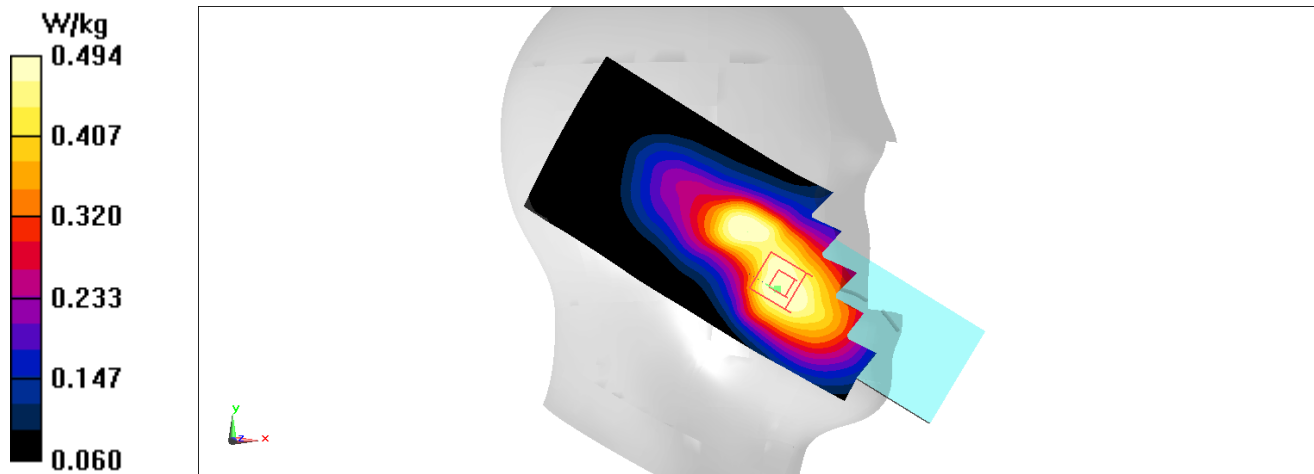

LTE B2 Head

Date/Time: 7/12/2022

Electronics: DAE4 Sn1525

Medium: H700-6000M

Medium parameters used: $f = 1900$ MHz; $\sigma = 1.466$ S/m; $\epsilon_r = 40.891$; $\rho = 1000$ kg/m³

Ambient Temperature: 23.3°C Liquid Temperature: 22.5°C

Communication System: UID 0, LTE Band2(20MB) (0) Frequency: 1900 MHz Duty Cycle: 1:1

Probe: EX3DV4 - SN7517 ConvF(7.74, 7.74, 7.74); Calibrated: 1/19/2022

Area Scan (61x171x1): Interpolated grid: dx=1.500 mm, dy=1.500 mm

Maximum value of SAR (interpolated) = 1.15 W/kg

Zoom Scan (5x5x7)/Cube 0: Measurement grid: dx=8mm, dy=8mm, dz=5mm

Reference Value = 3.179 V/m; Power Drift = -0.02 dB

Peak SAR (extrapolated) = 1.22 W/kg

SAR(1 g) = 0.815 W/kg; SAR(10 g) = 0.528 W/kg

Maximum value of SAR (measured) = 1.05 W/kg

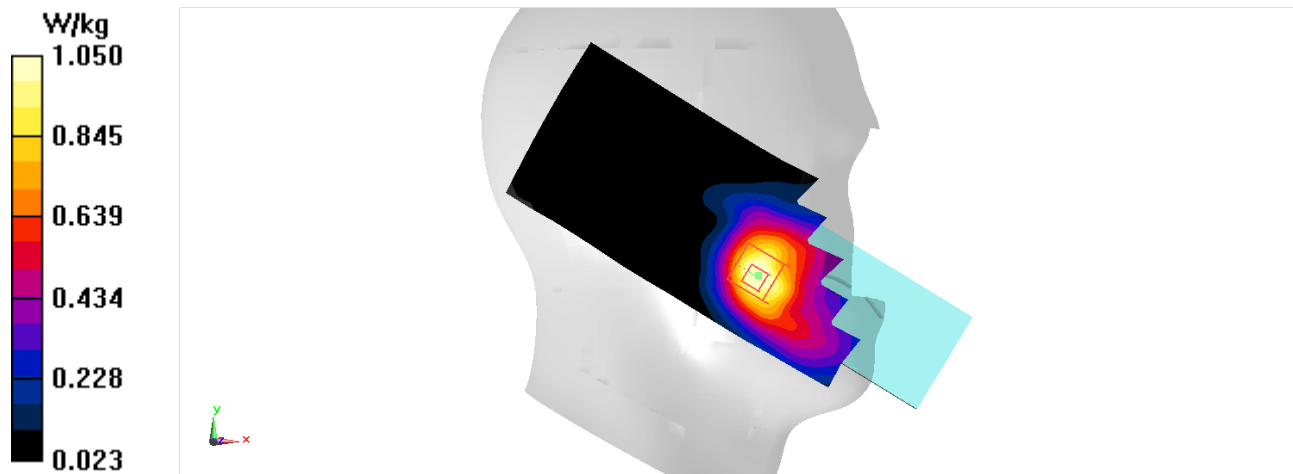

LTE B5 Head

Date/Time: 7/1/2022

Electronics: DAE4 Sn1525

Medium: H700-6000M

Medium parameters used (interpolated): $f = 836.5$ MHz; $\sigma = 0.911$ S/m; $\epsilon_r = 43.056$; $\rho = 1000$ kg/m³

Ambient Temperature: 23.3°C Liquid Temperature: 22.5°C

Communication System: UID 0, LTE Band5 (0) Frequency: 836.5 MHz Duty Cycle: 1:1

Probe: EX3DV4 - SN7517 ConvF(9.7, 9.7, 9.7); Calibrated: 1/19/2022

Area Scan (61x171x1): Interpolated grid: dx=1.500 mm, dy=1.500 mm

Maximum value of SAR (interpolated) = 0.851 W/kg

Zoom Scan (5x5x7)/Cube 0: Measurement grid: dx=8mm, dy=8mm, dz=5mm

Reference Value = 15.16 V/m; Power Drift = 0.09 dB

Peak SAR (extrapolated) = 1.43 W/kg

SAR(1 g) = 0.666 W/kg; SAR(10 g) = 0.431 W/kg

Maximum value of SAR (measured) = 1.05 W/kg

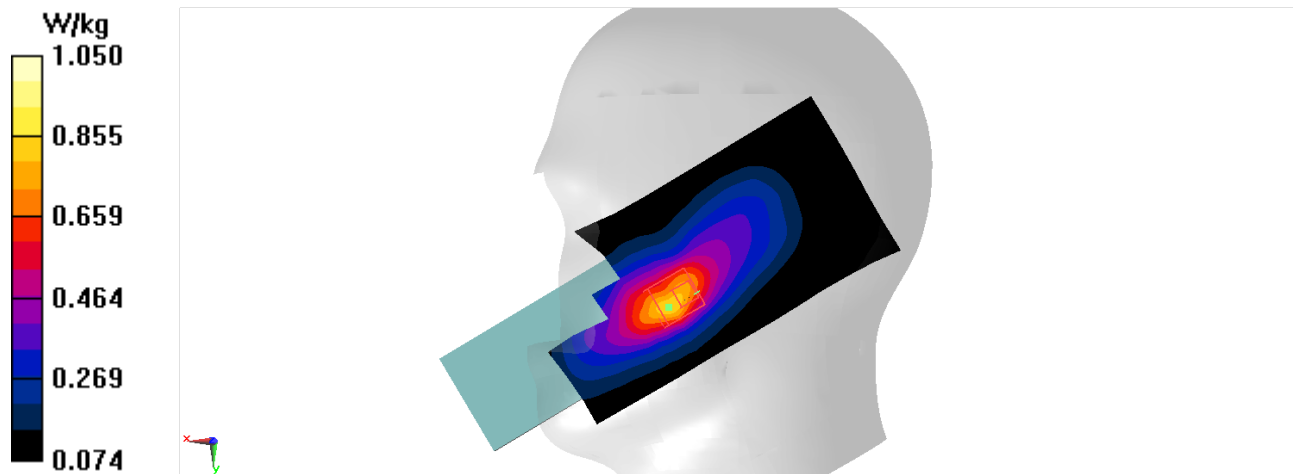

LTE B12 Head

Date/Time: 6/27/2022

Electronics: DAE4 Sn1525

Medium: H700-6000M

Medium parameters used (interpolated): $f = 711 \text{ MHz}$; $\sigma = 0.863 \text{ S/m}$; $\epsilon_r = 43.459$; $\rho = 1000 \text{ kg/m}^3$

Ambient Temperature: 23.3°C Liquid Temperature: 22.5°C

Communication System: UID 0, LTE Band12 (0) Frequency: 711 MHz Duty Cycle: 1:1

Probe: EX3DV4 - SN7517 ConvF(9.7, 9.7, 9.7); Calibrated: 1/19/2022

Area Scan (61x171x1): Interpolated grid: $dx=1.500 \text{ mm}$, $dy=1.500 \text{ mm}$

Maximum value of SAR (interpolated) = 0.460 W/kg

Zoom Scan (5x5x7)/Cube 0: Measurement grid: $dx=8\text{mm}$, $dy=8\text{mm}$, $dz=5\text{mm}$

Reference Value = 8.298 V/m ; Power Drift = -0.18 dB

Peak SAR (extrapolated) = 0.683 W/kg

SAR(1 g) = 0.337 W/kg ; SAR(10 g) = 0.220 W/kg

Maximum value of SAR (measured) = 0.494 W/kg

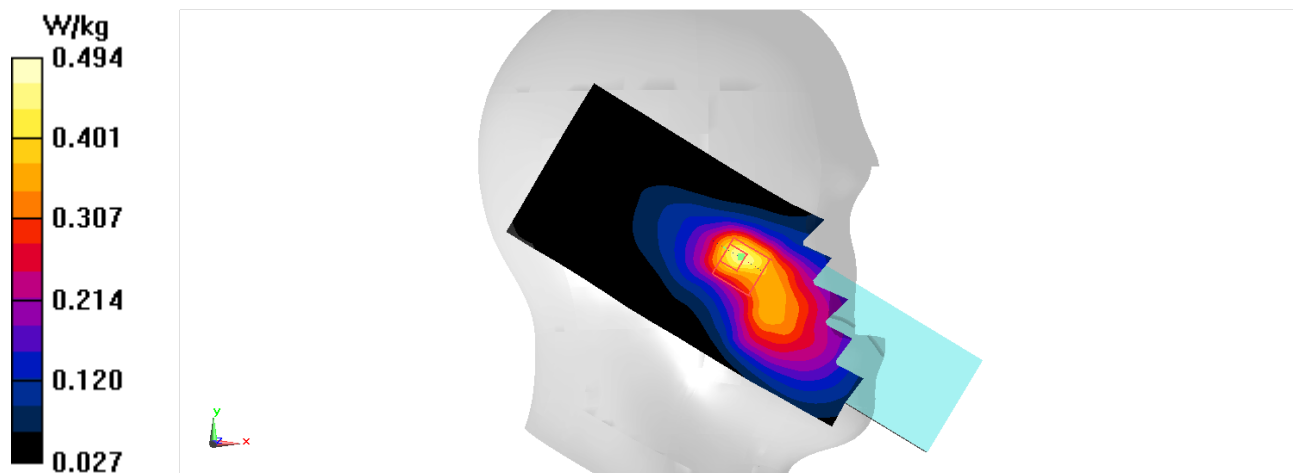

LTE B13 Head

Date/Time: 6/27/2022

Electronics: DAE4 Sn1525

Medium: H700-6000M

Medium parameters used (interpolated): $f = 782 \text{ MHz}$; $\sigma = 0.89 \text{ S/m}$; $\epsilon_r = 43.225$; $\rho = 1000 \text{ kg/m}^3$

Ambient Temperature: 23.3°C Liquid Temperature: 22.5°C

Communication System: UID 0, LTE Band13 (0) Frequency: 782 MHz Duty Cycle: 1:1

Probe: EX3DV4 - SN7517 ConvF(9.7, 9.7, 9.7); Calibrated: 1/19/2022

Area Scan (61x171x1): Interpolated grid: $dx=1.500 \text{ mm}$, $dy=1.500 \text{ mm}$

Maximum value of SAR (interpolated) = 0.639 W/kg

Zoom Scan (5x5x7)/Cube 0: Measurement grid: $dx=8\text{mm}$, $dy=8\text{mm}$, $dz=5\text{mm}$

Reference Value = 12.66 V/m ; Power Drift = -0.13 dB

Peak SAR (extrapolated) = 0.848 W/kg

SAR(1 g) = 0.508 W/kg ; SAR(10 g) = 0.327 W/kg

Maximum value of SAR (measured) = 0.714 W/kg

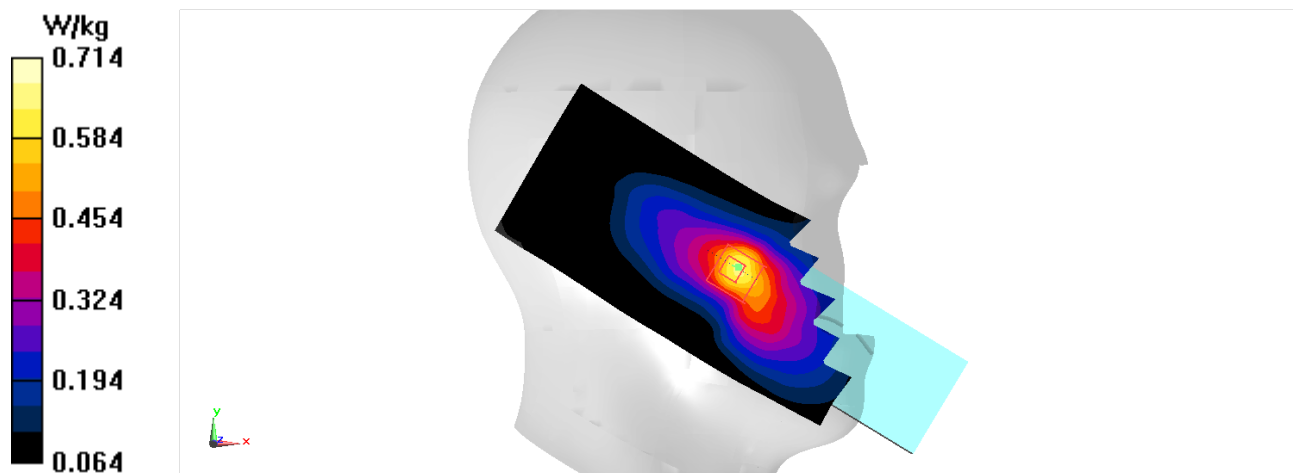

LTE B66 Head

Date/Time: 7/10/2022

Electronics: DAE4 Sn1525

Medium: H700-6000M

Medium parameters used: $f = 1745$ MHz; $\sigma = 1.368$ S/m; $\epsilon_r = 41.077$; $\rho = 1000$ kg/m³

Ambient Temperature: 23.3°C Liquid Temperature: 22.5°C

Communication System: UID 0, LTE Band66 (0) Frequency: 1745 MHz Duty Cycle: 1:1

Probe: EX3DV4 - SN7517 ConvF(8.1, 8.1, 8.1); Calibrated: 1/19/2022

Area Scan (61x171x1): Interpolated grid: dx=1.500 mm, dy=1.500 mm

Maximum value of SAR (interpolated) = 0.478 W/kg

Zoom Scan (5x5x7)/Cube 0: Measurement grid: dx=8mm, dy=8mm, dz=5mm

Reference Value = 1.927 V/m; Power Drift = 0.03 dB

Peak SAR (extrapolated) = 0.566 W/kg

SAR(1 g) = 0.361 W/kg; SAR(10 g) = 0.222 W/kg

Maximum value of SAR (measured) = 0.459 W/kg

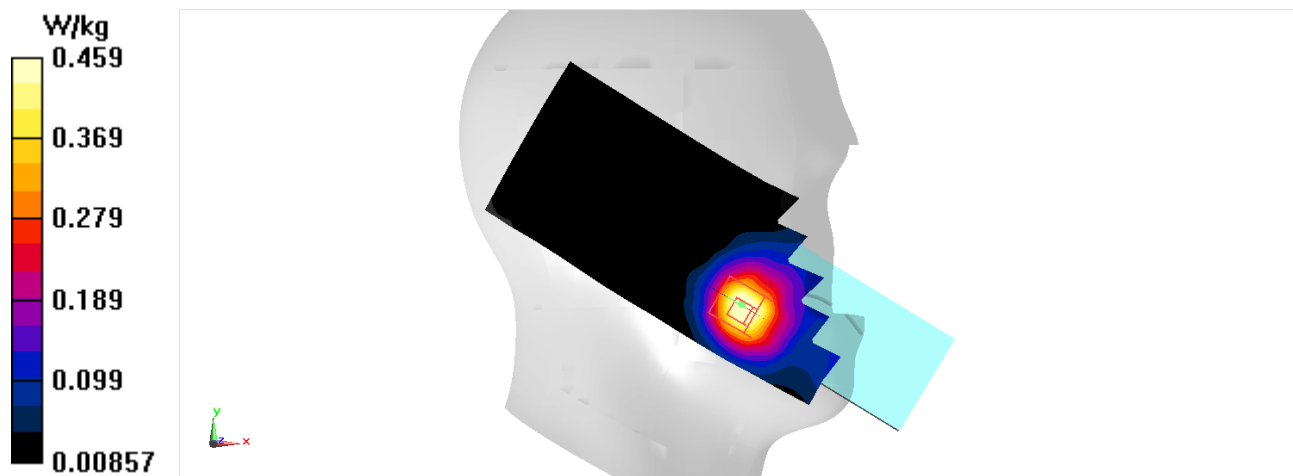

W1900 Body

Date/Time: 7/12/2022

Electronics: DAE4 Sn1525

Medium: H700-6000M

Medium parameters used: $f = 1880 \text{ MHz}$; $\sigma = 1.452 \text{ S/m}$; $\epsilon_r = 40.927$; $\rho = 1000 \text{ kg/m}^3$

Ambient Temperature: 23.3°C Liquid Temperature: 22.5°C

Communication System: UID 0, WCDMA 1900 (0) Frequency: 1880 MHz Duty Cycle: 1:1

Probe: EX3DV4 - SN7517 ConvF(7.74, 7.74, 7.74); Calibrated: 1/19/2022

Area Scan (81x101x1): Interpolated grid: $dx=1.500 \text{ mm}$, $dy=1.500 \text{ mm}$

Maximum value of SAR (interpolated) = 1.56 W/kg

Zoom Scan (7x8x7)/Cube 0: Measurement grid: $dx=8\text{mm}$, $dy=8\text{mm}$, $dz=5\text{mm}$

Reference Value = 11.76 V/m ; Power Drift = 0.08 dB

Peak SAR (extrapolated) = 1.86 W/kg

SAR(1 g) = 1.05 W/kg ; SAR(10 g) = 0.611 W/kg

Maximum value of SAR (measured) = 1.54 W/kg

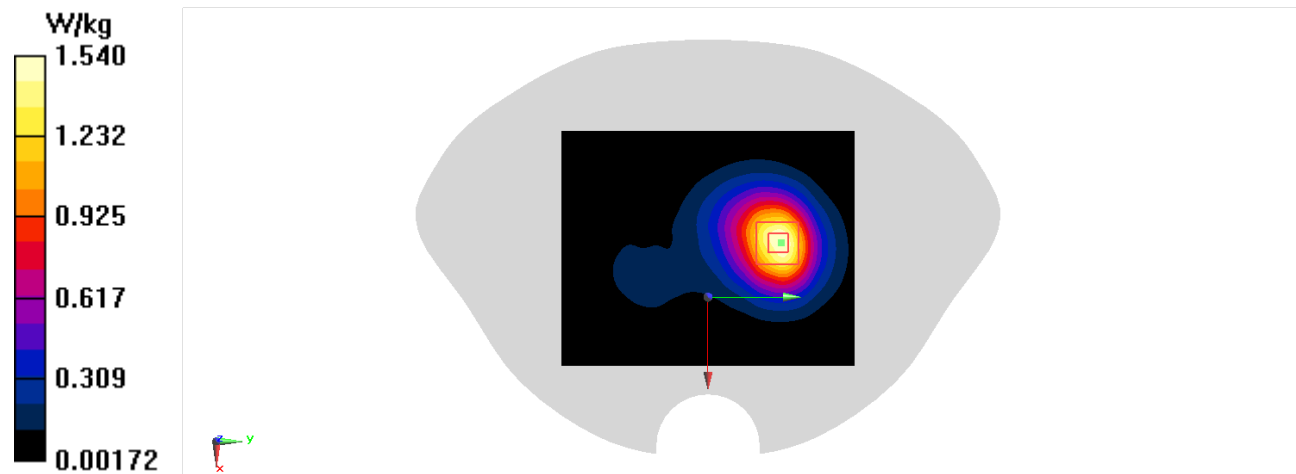

W1700 Body

Date/Time: 7/10/2022

Electronics: DAE4 Sn1525

Medium: H700-6000M

Medium parameters used (interpolated): $f = 1712.4$ MHz; $\sigma = 1.352$ S/m; $\epsilon_r = 41.153$; $\rho = 1000$ kg/m³

Ambient Temperature: 23.3°C Liquid Temperature: 22.5°C

Communication System: UID 0, WCDMA 1700 Band4 (0) Frequency: 1712.4 MHz Duty Cycle: 1:1

Probe: EX3DV4 - SN7517 ConvF(8.1, 8.1, 8.1); Calibrated: 1/19/2022

Area Scan (81x101x1): Interpolated grid: dx=1.500 mm, dy=1.500 mm

Maximum value of SAR (interpolated) = 1.54 W/kg

Zoom Scan (5x5x7)/Cube 0: Measurement grid: dx=8mm, dy=8mm, dz=5mm

Reference Value = 2.411 V/m; Power Drift = 0.04 dB

Peak SAR (extrapolated) = 1.80 W/kg

SAR(1 g) = 1.01 W/kg; SAR(10 g) = 0.553 W/kg

Maximum value of SAR (measured) = 1.48 W/kg

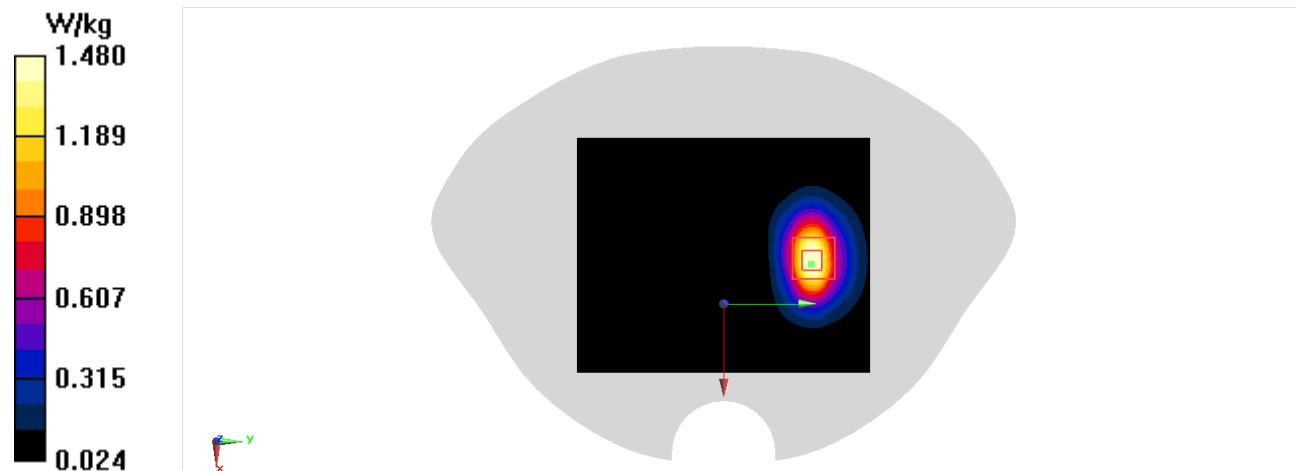

W850 Body

Date/Time: 7/1/2022

Electronics: DAE4 Sn1525

Medium: H700-6000M(All3) 2022-Jun-28

Medium parameters used (interpolated): $f = 826.4$ MHz; $\sigma = 0.907$ S/m; $\epsilon_r = 43.09$; $\rho = 1000$ kg/m³

Ambient Temperature: 23.3°C Liquid Temperature: 22.5°C

Communication System: UID 0, WCDMA 850 (0) Frequency: 826.4 MHz Duty Cycle: 1:1

Probe: EX3DV4 - SN7517 ConvF(9.7, 9.7, 9.7); Calibrated: 1/19/2022

Area Scan (81x101x1): Interpolated grid: dx=1.500 mm, dy=1.500 mm

Maximum value of SAR (interpolated) = 0.546 W/kg

Zoom Scan (7x8x7)/Cube 0: Measurement grid: dx=8mm, dy=8mm, dz=5mm

Reference Value = 21.02 V/m; Power Drift = 0.08 dB

Peak SAR (extrapolated) = 0.637 W/kg

SAR(1 g) = 0.434 W/kg; SAR(10 g) = 0.307 W/kg

Maximum value of SAR (measured) = 0.549 W/kg

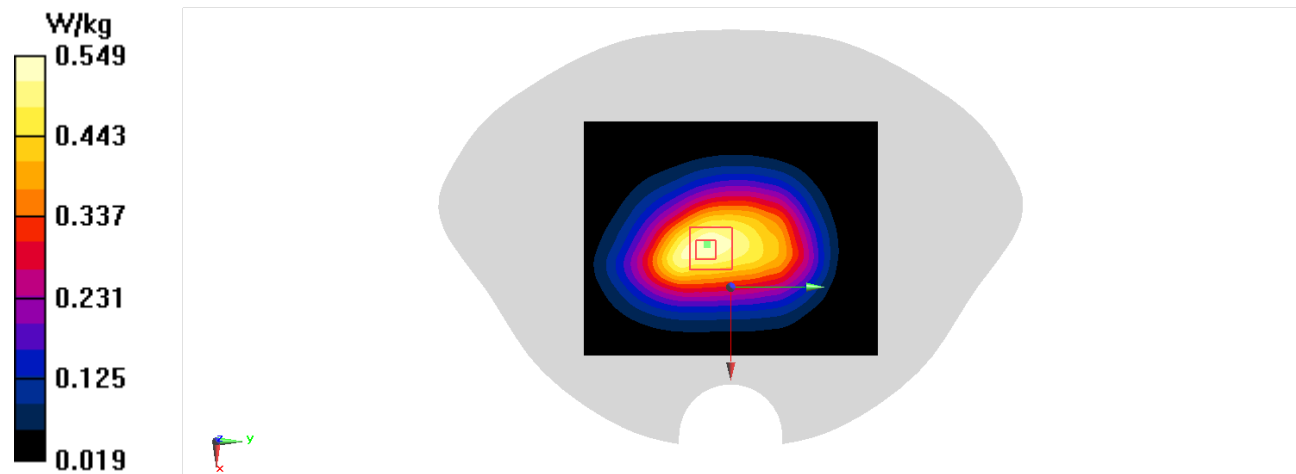

LTE B2 Body

Date/Time: 7/12/2022

Electronics: DAE4 Sn1525

Medium: H700-6000M

Medium parameters used: $f = 1900$ MHz; $\sigma = 1.466$ S/m; $\epsilon_r = 40.891$; $\rho = 1000$ kg/m³

Ambient Temperature: 23.3°C Liquid Temperature: 22.5°C

Communication System: UID 0, LTE Band2(20MB) (0) Frequency: 1900 MHz Duty Cycle: 1:1

Probe: EX3DV4 - SN7517 ConvF(7.74, 7.74, 7.74); Calibrated: 1/19/2022

Area Scan (81x101x1): Interpolated grid: dx=1.500 mm, dy=1.500 mm

Maximum value of SAR (interpolated) = 1.72 W/kg

Zoom Scan (5x5x7)/Cube 0: Measurement grid: dx=8mm, dy=8mm, dz=5mm

Reference Value = 12.75 V/m; Power Drift = 0.02 dB

Peak SAR (extrapolated) = 2.02 W/kg

SAR(1 g) = 1.14 W/kg; SAR(10 g) = 0.648 W/kg

Maximum value of SAR (measured) = 1.67 W/kg

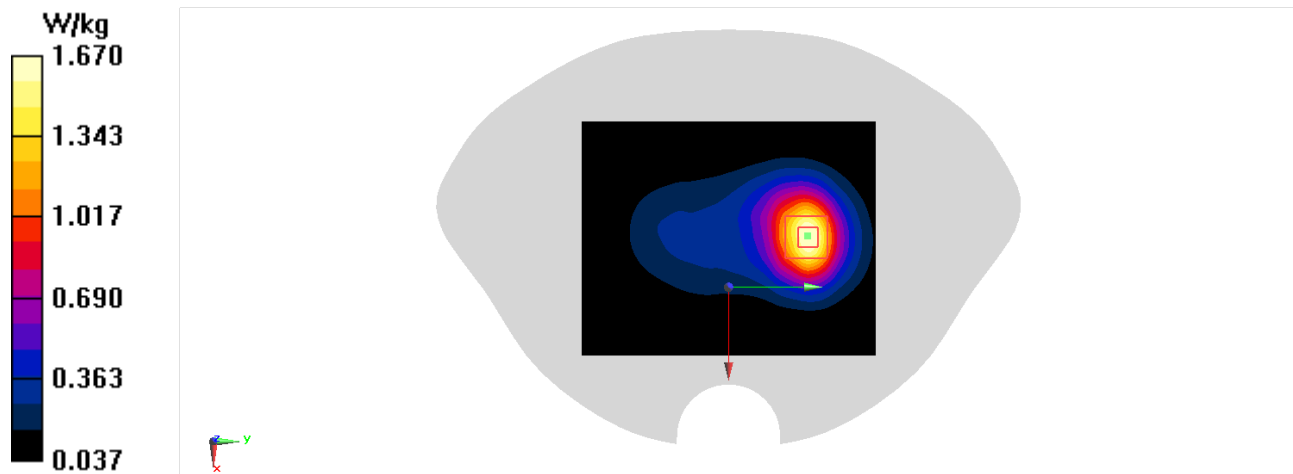

LTE B5 Body

Date/Time: 7/1/2022

Electronics: DAE4 Sn1525

Medium: H700-6000M

Medium parameters used (interpolated): $f = 836.5$ MHz; $\sigma = 0.911$ S/m; $\epsilon_r = 43.056$; $\rho = 1000$ kg/m³

Ambient Temperature: 23.3°C Liquid Temperature: 22.5°C

Communication System: UID 0, LTE Band5 (0) Frequency: 836.5 MHz Duty Cycle: 1:1

Probe: EX3DV4 - SN7517 ConvF(9.7, 9.7, 9.7); Calibrated: 1/19/2022

Area Scan (81x101x1): Interpolated grid: dx=1.500 mm, dy=1.500 mm

Maximum value of SAR (interpolated) = 0.491 W/kg

Zoom Scan (7x8x7)/Cube 0: Measurement grid: dx=8mm, dy=8mm, dz=5mm

Reference Value = 21.36 V/m; Power Drift = -0.01 dB

Peak SAR (extrapolated) = 0.561 W/kg

SAR(1 g) = 0.374 W/kg; SAR(10 g) = 0.270 W/kg

Maximum value of SAR (measured) = 0.493 W/kg

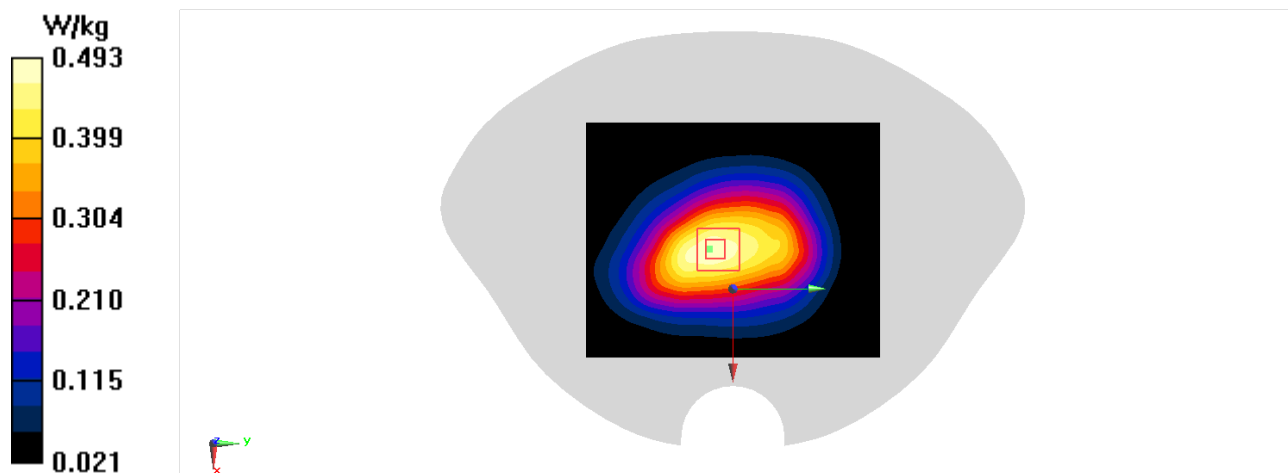

LTE B12 Body

Date/Time: 6/27/2022

Electronics: DAE4 Sn1525

Medium: H700-6000M

Medium parameters used (interpolated): $f = 711 \text{ MHz}$; $\sigma = 0.863 \text{ S/m}$; $\epsilon_r = 43.459$; $\rho = 1000 \text{ kg/m}^3$

Ambient Temperature: 23.3°C Liquid Temperature: 22.5°C

Communication System: UID 0, LTE Band12 (0) Frequency: 711 MHz Duty Cycle: 1:1

Probe: EX3DV4 - SN7517 ConvF(9.7, 9.7, 9.7); Calibrated: 1/19/2022

Area Scan (81x101x1): Interpolated grid: $dx=1.500 \text{ mm}$, $dy=1.500 \text{ mm}$

Maximum value of SAR (interpolated) = 0.382 W/kg

Zoom Scan (7x8x7)/Cube 0: Measurement grid: $dx=8\text{mm}$, $dy=8\text{mm}$, $dz=5\text{mm}$

Reference Value = 17.05 V/m ; Power Drift = -0.09 dB

Peak SAR (extrapolated) = 0.434 W/kg

SAR(1 g) = 0.293 W/kg ; SAR(10 g) = 0.210 W/kg

Maximum value of SAR (measured) = 0.379 W/kg

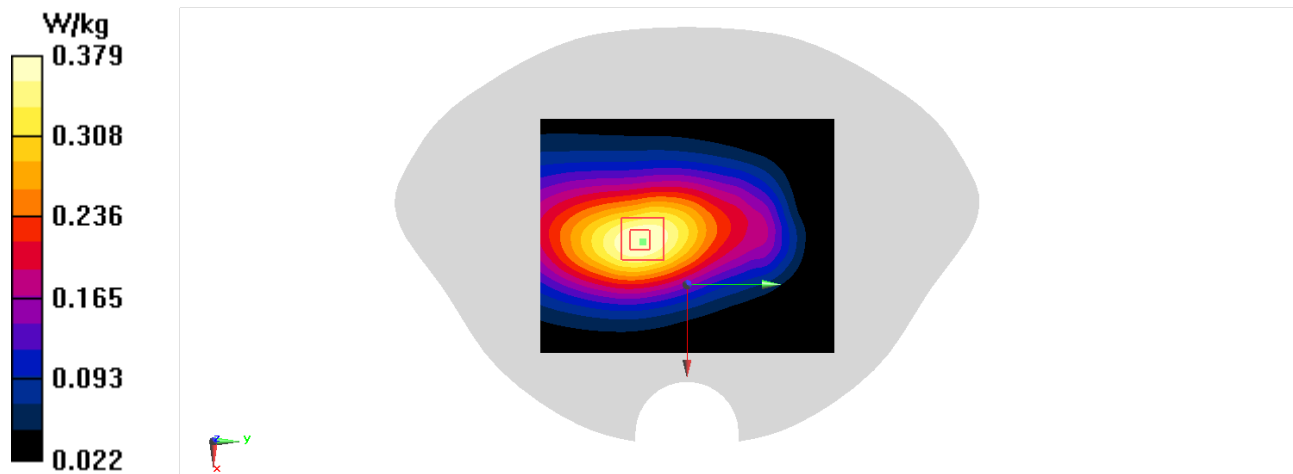

LTE B13 Body

Date/Time: 6/27/2022

Electronics: DAE4 Sn1525

Medium: H700-6000M

Medium parameters used (interpolated): $f = 782 \text{ MHz}$; $\sigma = 0.89 \text{ S/m}$; $\epsilon_r = 43.225$; $\rho = 1000 \text{ kg/m}^3$

Ambient Temperature: 23.3°C Liquid Temperature: 22.5°C

Communication System: UID 0, LTE Band13 (0) Frequency: 782 MHz Duty Cycle: 1:1

Probe: EX3DV4 - SN7517 ConvF(9.7, 9.7, 9.7); Calibrated: 1/19/2022

Area Scan (81x101x1): Interpolated grid: $dx=1.500 \text{ mm}$, $dy=1.500 \text{ mm}$

Maximum value of SAR (interpolated) = 0.327 W/kg

Zoom Scan (7x9x7)/Cube 0: Measurement grid: $dx=8\text{mm}$, $dy=8\text{mm}$, $dz=5\text{mm}$

Reference Value = 15.36 V/m ; Power Drift = 0.07 dB

Peak SAR (extrapolated) = 0.417 W/kg

SAR(1 g) = 0.272 W/kg ; SAR(10 g) = 0.185 W/kg

Maximum value of SAR (measured) = 0.364 W/kg

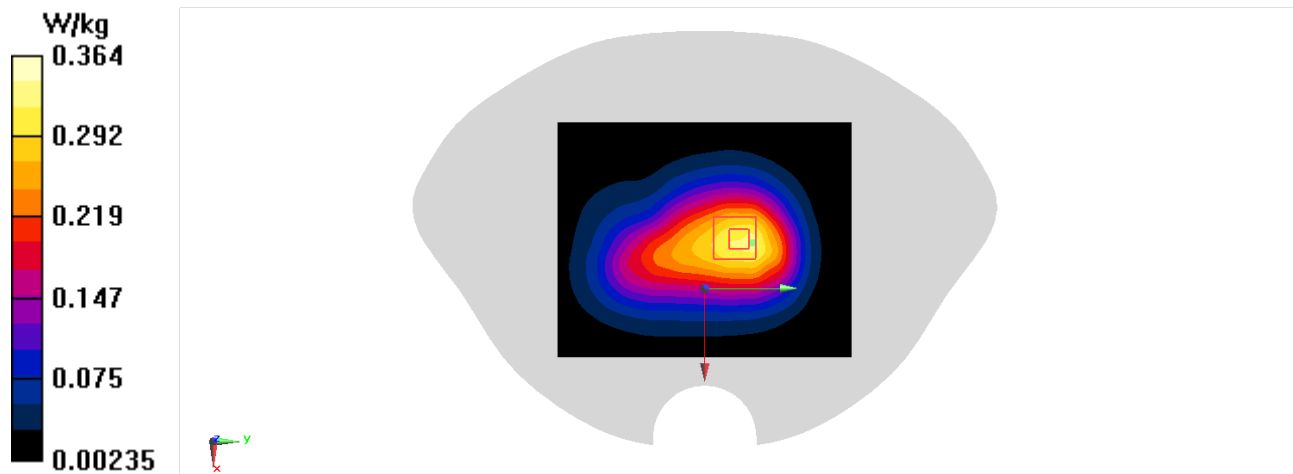

LTE B66 Body

Date/Time: 7/10/2022

Electronics: DAE4 Sn1525

Medium: H700-6000M

Medium parameters used: $f = 1720 \text{ MHz}$; $\sigma = 1.356 \text{ S/m}$; $\epsilon_r = 41.133$; $\rho = 1000 \text{ kg/m}^3$

Ambient Temperature: 23.3°C Liquid Temperature: 22.5°C

Communication System: UID 0, LTE Band66 (0) Frequency: 1720 MHz Duty Cycle: 1:1

Probe: EX3DV4 - SN7517 ConvF(8.1, 8.1, 8.1); Calibrated: 1/19/2022

Area Scan (81x101x1): Interpolated grid: $dx=1.500 \text{ mm}$, $dy=1.500 \text{ mm}$

Maximum value of SAR (interpolated) = 1.51 W/kg

Zoom Scan (7x8x7)/Cube 0: Measurement grid: $dx=8\text{mm}$, $dy=8\text{mm}$, $dz=5\text{mm}$

Reference Value = 2.711 V/m ; Power Drift = 0.02 dB

Peak SAR (extrapolated) = 1.71 W/kg

SAR(1 g) = 0.962 W/kg ; SAR(10 g) = 0.527 W/kg

Maximum value of SAR (measured) = 1.39 W/kg

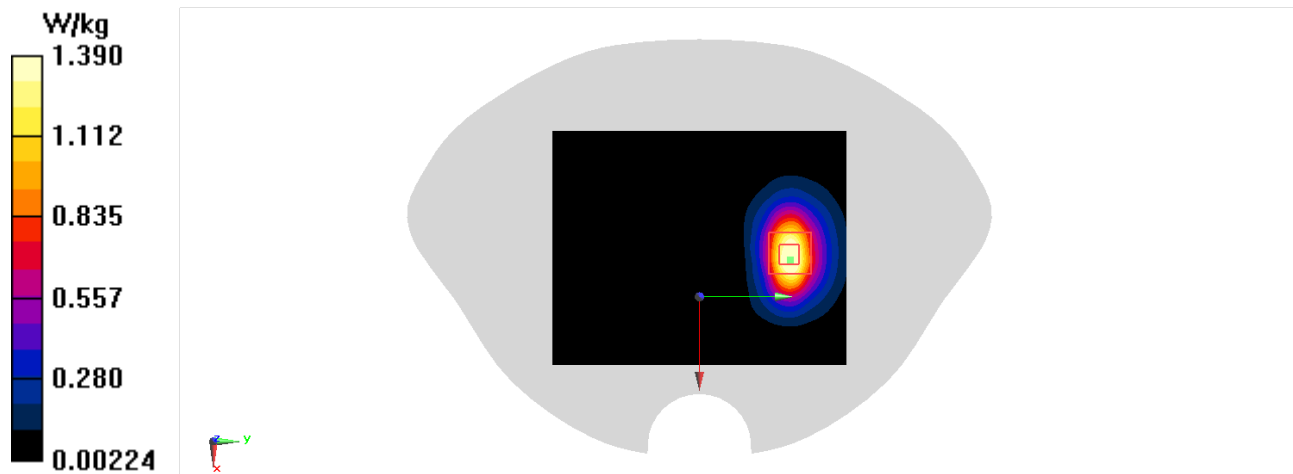

WLAN 2.4G Head

Date/Time: 7/5/2022

Electronics: DAE4 Sn1525

Medium: H700-6000M

Medium parameters used (interpolated): $f = 2412$ MHz; $\sigma = 1.836$ S/m; $\epsilon_r = 40.168$; $\rho = 1000$ kg/m³

Ambient Temperature: 23.3°C Liquid Temperature: 22.5°C

Communication System: UID 0, WLAN 2450 (0) Frequency: 2412 MHz Duty Cycle: 1:1

Probe: EX3DV4 - SN7517 ConvF(7.16, 7.16, 7.16); Calibrated: 1/19/2022

Area Scan (81x211x1): Interpolated grid: dx=1.200 mm, dy=1.200 mm

Maximum value of SAR (interpolated) = 0.799 W/kg

Zoom Scan (7x7x7)/Cube 0: Measurement grid: dx=5mm, dy=5mm, dz=5mm Reference

Value = 3.185 V/m; Power Drift = 0.05 dB

Peak SAR (extrapolated) = 0.972 W/kg

SAR(1 g) = 0.470 W/kg; SAR(10 g) = 0.233 W/kg

Maximum value of SAR (measured) = 0.758 W/kg

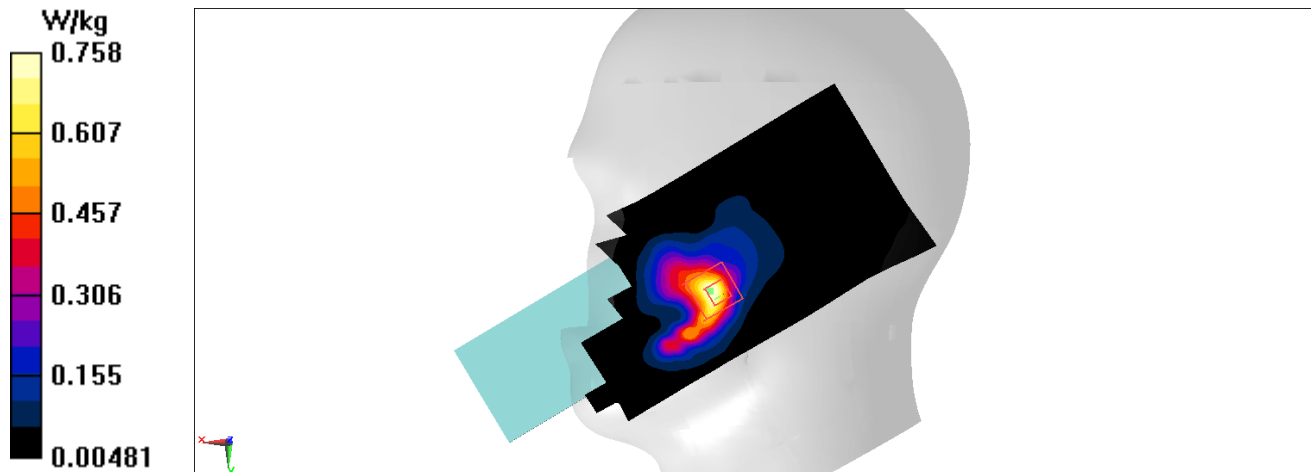

WiFi2.4G Body

Date/Time: 7/5/2022

Electronics: DAE4 Sn1525

Medium: H700-6000M

Medium parameters used (interpolated): $f = 2412 \text{ MHz}$; $\sigma = 1.836 \text{ S/m}$; $\epsilon_r = 40.168$; $\rho = 1000 \text{ kg/m}^3$

Ambient Temperature: 23.3°C Liquid Temperature: 22.5°C

Communication System: UID 0, WLAN 2450 (0) Frequency: 2412 MHz Duty Cycle: 1:1

Probe: EX3DV4 - SN7517 ConvF(7.16, 7.16, 7.16); Calibrated: 1/19/2022

Area Scan (101x141x1): Interpolated grid: $dx=1.000 \text{ mm}$, $dy=1.000 \text{ mm}$

Maximum value of SAR (interpolated) = 0.0953 W/kg

Zoom Scan (7x7x7)/Cube 0: Measurement grid: $dx=5\text{mm}$, $dy=5\text{mm}$, $dz=5\text{mm}$

Reference Value = 1.515 V/m ; Power Drift = 0.05 dB

Peak SAR (extrapolated) = 0.110 W/kg

SAR(1 g) = 0.057 W/kg ; SAR(10 g) = 0.029 W/kg

Maximum value of SAR (measured) = 0.0890 W/kg

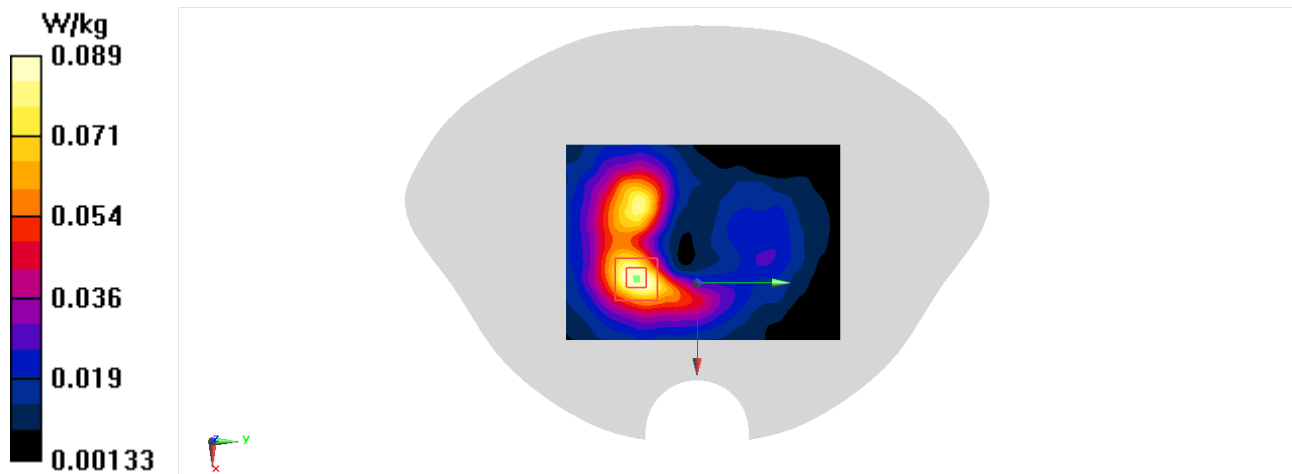

ANNEX B System Verification Results

SystemPerformanceCheck-D750-1017

Date/Time: 6/27/2022

Electronics: DAE4 Sn1525

Medium: H700-6000M

Medium parameters used: $f = 750 \text{ MHz}$; $\sigma = 0.878 \text{ S/m}$; $\epsilon_r = 43.336$; $\rho = 1000 \text{ kg/m}^3$

Ambient Temperature: 23.3°C Liquid Temperature: 22.5°C

Communication System: UID 0, CW (0) Frequency: 750 MHz Duty Cycle: 1:1

Probe: EX3DV4 - SN7517 ConvF(9.7, 9.7, 9.7); Calibrated: 1/19/2022

System Performance Check at Frequencies below 1 GHz/d=15mm, Pin=250 mW, dist=2.0mm

(EX-Probe)/Area Scan (61x141x1): Interpolated grid: dx=1.500 mm, dy=1.500 mm

Maximum value of SAR (interpolated) = 2.81 W/kg

System Performance Check at Frequencies below 1 GHz/d=15mm, Pin=250 mW, dist=2.0mm

(EX-Probe)/Zoom Scan (7x7x7) (7x7x7)/Cube 0: Measurement grid: dx=5mm, dy=5mm, dz=5mm

Reference Value = 56.99 V/m; Power Drift = -0.12 dB

Peak SAR (extrapolated) = 3.68 W/kg

SAR(1 g) = 2.28 W/kg; SAR(10 g) = 1.43 W/kg

Maximum value of SAR (measured) = 3.02 W/kg

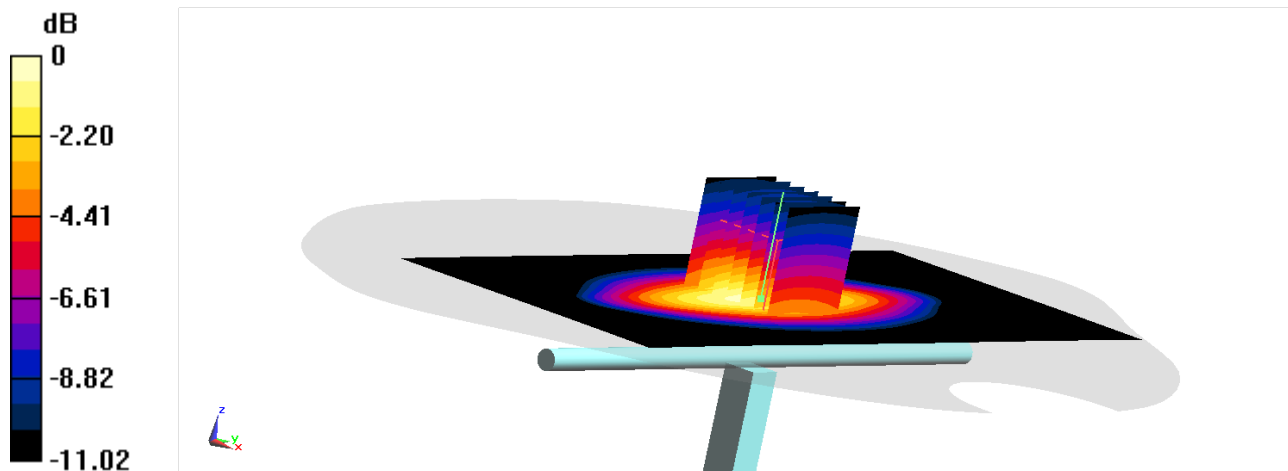

0 dB = 3.02 W/kg = 4.80 dBW/kg

SystemPerformanceCheck-D835_4d120

Date/Time: 7/1/2022

Electronics: DAE4 Sn1525

Medium: H700-6000M

Medium parameters used: $f = 835 \text{ MHz}$; $\sigma = 0.91 \text{ S/m}$; $\epsilon_r = 43.061$; $\rho = 1000 \text{ kg/m}^3$

Ambient Temperature: 23.3°C Liquid Temperature: 22.5°C

Communication System: UID 0, CW (0) Frequency: 835 MHz Duty Cycle: 1:1

Probe: EX3DV4 - SN7517 ConvF(9.7, 9.7, 9.7); Calibrated: 1/19/2022

System Performance Check at Frequencies below 1 GHz/d=15mm, Pin=250 mW, dist=2.0mm

(EX-Probe)/Area Scan (61x131x1): Interpolated grid: dx=1.500 mm, dy=1.500 mm

Maximum value of SAR (interpolated) = 2.70 W/kg

System Performance Check at Frequencies below 1 GHz/d=15mm, Pin=250 mW, dist=2.0mm

(EX-Probe)/Zoom Scan (7x7x7) (7x7x7)/Cube 0: Measurement grid: dx=5mm, dy=5mm, dz=5mm

Reference Value = 54.77 V/m; Power Drift = 0.08 dB

Peak SAR (extrapolated) = 3.27 W/kg

SAR(1 g) = 2.18 W/kg; SAR(10 g) = 1.43 W/kg

Maximum value of SAR (measured) = 2.75 W/kg

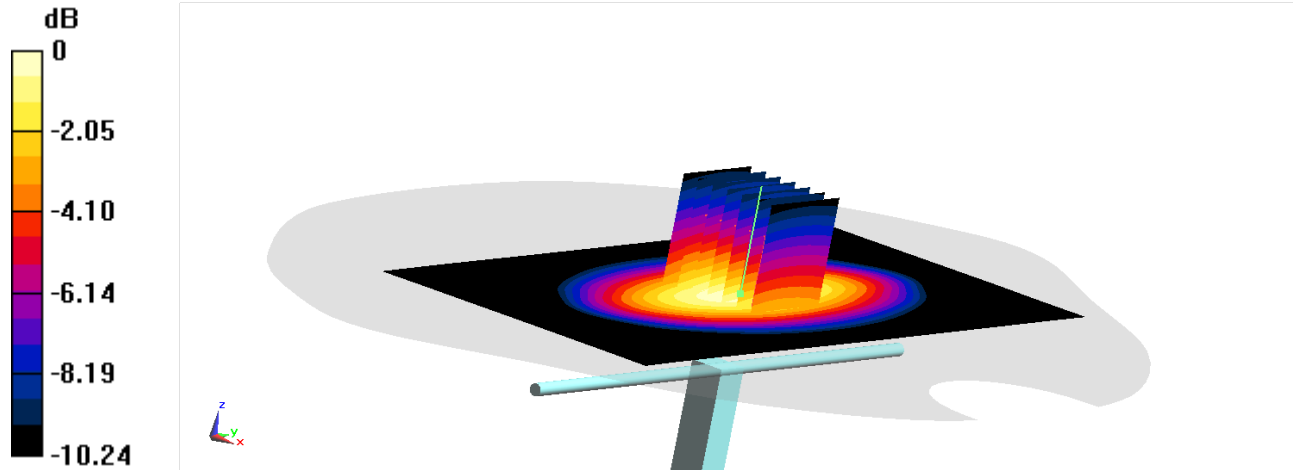

0 dB = 2.75 W/kg = 4.39 dBW/kg

SystemPerformanceCheck-D1750_1003

Date/Time: 7/10/2022

Electronics: DAE4 Sn1525

Medium: H700-6000M

Medium parameters used: $f = 1750$ MHz; $\sigma = 1.37$ S/m; $\epsilon_r = 41.069$; $\rho = 1000$ kg/m³

Ambient Temperature: 23.3°C Liquid Temperature: 22.5°C

Communication System: UID 0, CW Frequency: 1750 MHz Duty Cycle: 1:1

Probe: EX3DV4 - SN7517 ConvF(8.1, 8.1, 8.1); Calibrated: 1/19/2022

System Performance Check at Frequencies above 1 GHz/d=10mm, Pin=250 mW, dist=2.0mm

(EX-Probe)/Area Scan (61x81x1): Interpolated grid: dx=1.500 mm, dy=1.500 mm

Maximum value of SAR (interpolated) = 12.3 W/kg

System Performance Check at Frequencies above 1 GHz/d=10mm, Pin=250 mW, dist=2.0mm

(EX-Probe)/Zoom Scan (7x7x7) (7x7x7)/Cube 0: Measurement grid: dx=5mm, dy=5mm, dz=5mm

Reference Value = 93.28 V/m; Power Drift = -0.13 dB

Peak SAR (extrapolated) = 15.2 W/kg

SAR(1 g) = 8.61 W/kg; SAR(10 g) = 4.66 W/kg

Maximum value of SAR (measured) = 12.1 W/kg

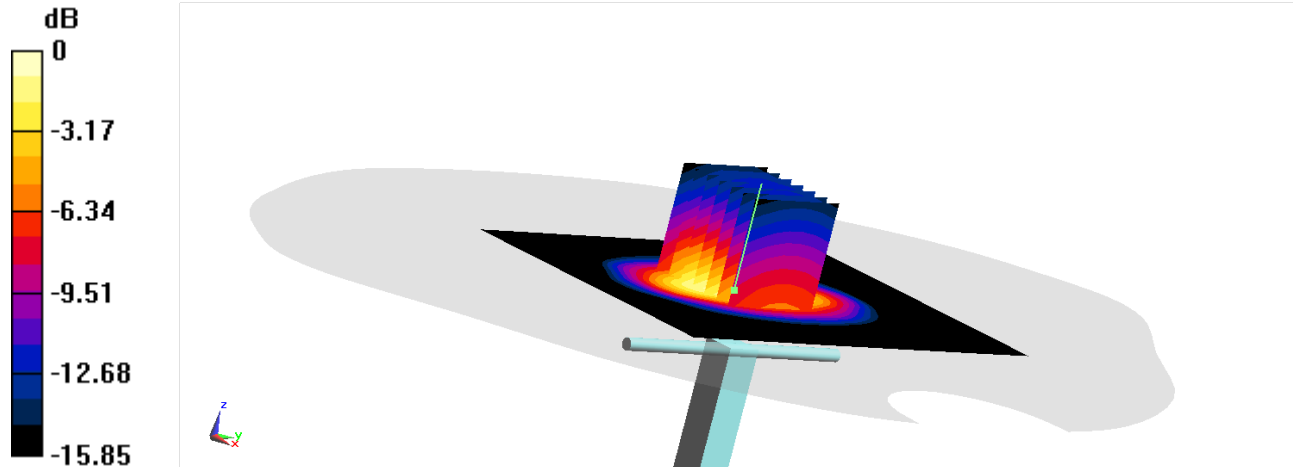

0 dB = 12.1 W/kg = 10.83 dBW/kg

SystemPerformanceCheck-D1900_5d101

Date/Time: 7/12/2022

Electronics: DAE4 Sn1525

Medium: H700-6000M

Medium parameters used: $f = 1900$ MHz; $\sigma = 1.466$ S/m; $\epsilon_r = 40.891$; $\rho = 1000$ kg/m³

Ambient Temperature: 23.3°C Liquid Temperature: 22.5°C

Communication System: UID 0, CW (0) Frequency: 1900 MHz Duty Cycle: 1:1

Probe: EX3DV4 - SN7517 ConvF(7.74, 7.74, 7.74); Calibrated: 1/19/2022

System Performance Check at Frequencies above 1 GHz/d=10mm, Pin=250 mW, dist=2.0mm

(EX-Probe)/Area Scan (61x81x1): Interpolated grid: dx=1.500 mm, dy=1.500 mm

Maximum value of SAR (interpolated) = 13.5 W/kg

System Performance Check at Frequencies above 1 GHz/d=10mm, Pin=250 mW, dist=2.0mm

(EX-Probe)/Zoom Scan (7x7x7) (7x7x7)/Cube 0: Measurement grid: dx=5mm, dy=5mm, dz=5mm

Reference Value = 93.00 V/m; Power Drift = -0.02 dB

Peak SAR (extrapolated) = 16.4 W/kg

SAR(1 g) = 9.07 W/kg; SAR(10 g) = 4.74 W/kg

Maximum value of SAR (measured) = 12.9 W/kg

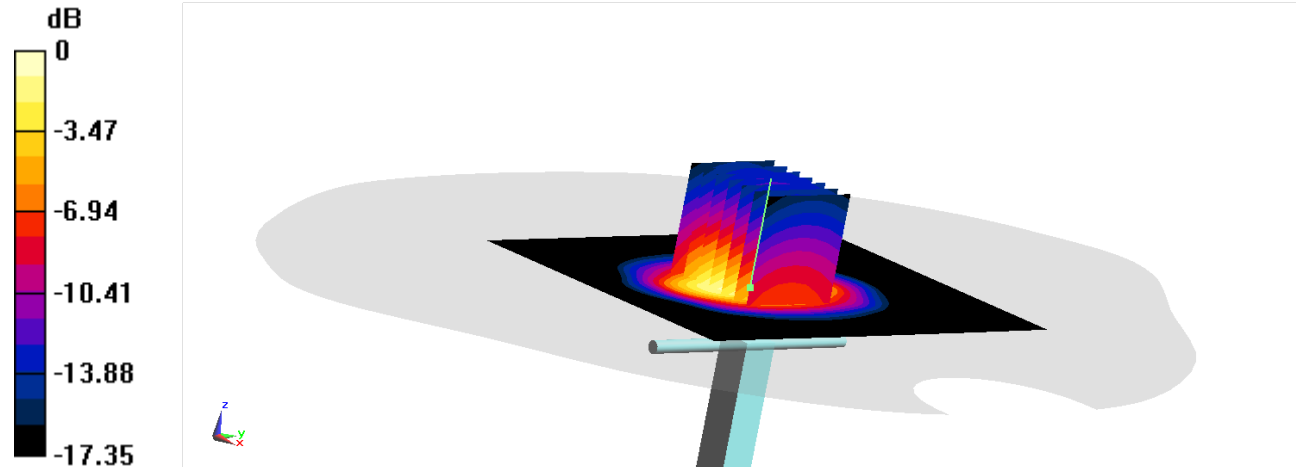

0 dB = 12.9 W/kg = 11.11 dBW/kg

SystemPerformanceCheck-D2450_869

Date/Time: 7/5/2022

Electronics: DAE4 Sn1525

Medium: H700-6000M

Medium parameters used: $f = 2450$ MHz; $\sigma = 1.866$ S/m; $\epsilon_r = 40.08$; $\rho = 1000$ kg/m³

Ambient Temperature: 23.3°C Liquid Temperature: 22.5°C

Communication System: UID 0, CW (0) Frequency: 2450 MHz Duty Cycle: 1:1

Probe: EX3DV4 - SN7517 ConvF(7.16, 7.16, 7.16); Calibrated: 1/19/2022

System Performance Check at Frequencies above 1 GHz/d=10mm, Pin=250mW, dist=2.0mm

(EX-Probe)/Area Scan (61x71x1): Interpolated grid: dx=1.200 mm, dy=1.200 mm

Maximum value of SAR (interpolated) = 20.4 W/kg

System Performance Check at Frequencies above 1 GHz/d=10mm, Pin=250mW, dist=2.0mm

(EX-Probe)/Zoom Scan (7x7x7) (7x7x7)/Cube 0: Measurement grid: dx=5mm, dy=5mm, dz=5mm

Reference Value = 102.9 V/m; Power Drift = -0.03 dB

Peak SAR (extrapolated) = 25.1 W/kg

SAR(1 g) = 12.5 W/kg; SAR(10 g) = 5.83 W/kg

Maximum value of SAR (measured) = 18.9 W/kg

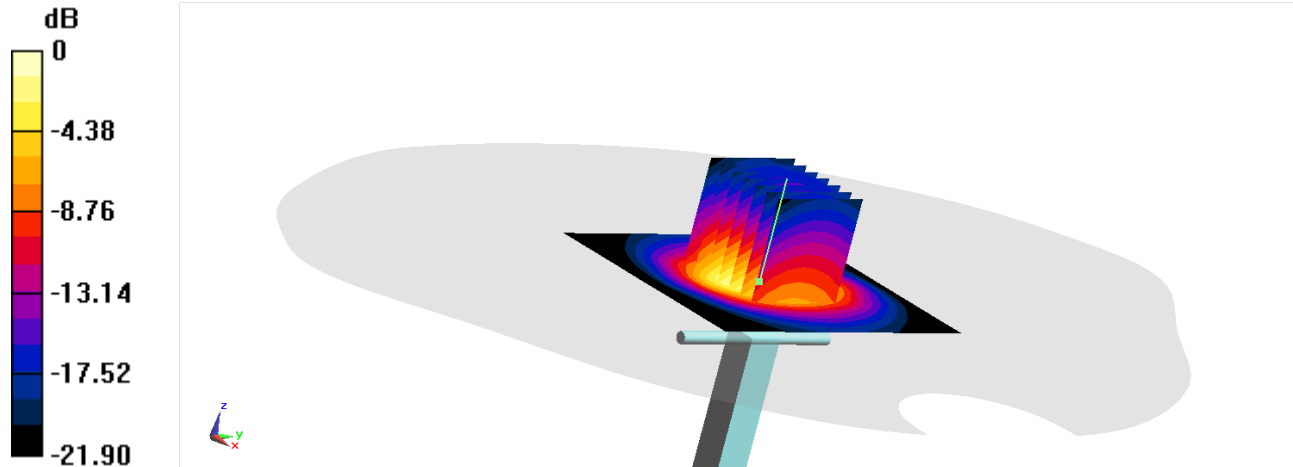

0 dB = 18.9 W/kg = 12.76 dBW/kg

ANNEX C SAR Measurement Setup

C.1 Measurement Set-up

The Dasy5 or DASY6 system for performing compliance tests is illustrated above graphically. This system consists of the following items:

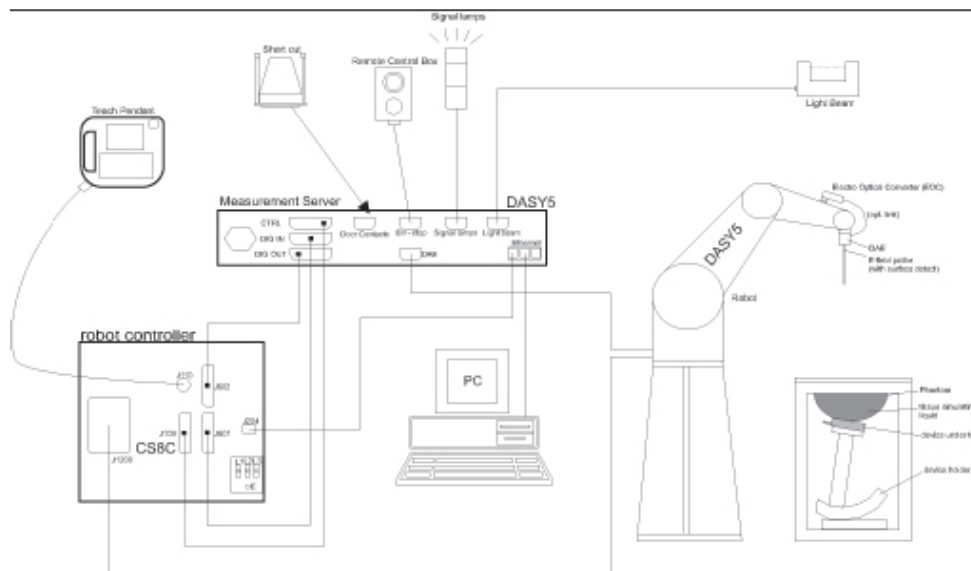

Picture C.1 SAR Lab Test Measurement Set-up

- A standard high precision 6-axis robot (StäubliTX=RX family) with controller, teach pendant and software. An arm extension for accommodating the data acquisition electronics (DAE).
- An isotropic field probe optimized and calibrated for the targeted measurement.
- A data acquisition electronics (DAE) which performs the signal amplification, signal multiplexing, AD-conversion, offset measurements, mechanical surface detection, collision detection, etc. The unit is battery powered with standard or rechargeable batteries. The signal is optically transmitted to the EOC.
- The Electro-optical converter (EOC) performs the conversion from optical to electrical signals for the digital communication to the DAE. To use optical surface detection, a special version of the EOC is required. The EOC signal is transmitted to the measurement server.
- The function of the measurement server is to perform the time critical tasks such as signal filtering, control of the robot operation and fast movement interrupts.
- The Light Beam used is for probe alignment. This improves the (absolute) accuracy of the probe positioning.
- A computer running WinXP and the DASY5 or DASY6 software.
- Remote control and teach pendant as well as additional circuitry for robot safety such as
- warning lamps, etc.
- The phantom, the device holder and other accessories according to the targeted measurement.

C.2 Dasy5 E-field Probe System

The SAR measurements were conducted with the dosimetric probe designed in the classical triangular configuration and optimized for dosimetric evaluation. The probe is constructed using the thick film technique; with printed resistive lines on ceramic substrates. The probe is equipped with an optical multifiber line ending at the front of the probe tip. It is connected to the EOC box on the robot arm and provides an automatic detection of the phantom surface. Half of the fibers are connected to a pulsed infrared transmitter, the other half to a synchronized receiver. As the probe approaches the surface, the reflection from the surface produces a coupling from the transmitting to the receiving fibers. This reflection increases first during the approach, reaches maximum and then decreases. If the probe is flatly touching the surface, the coupling is zero. The distance of the coupling maximum to the surface is independent of the surface reflectivity and largely independent of the surface to probe angle. The DASY5 or DASY6 software reads the reflection during a software approach and looks for the maximum using 2nd order curve fitting. The approach is stopped at reaching the maximum.

Probe Specifications:

Model:	ES3DV3, EX3DV4
Frequency	10MHz — 6.0GHz(EX3DV4)
Range:	10MHz — 4GHz(ES3DV3)
Calibration:	In head and body simulating tissue at Frequencies from 835 up to 5800MHz
Linearity:	± 0.2 dB(30 MHz to 6 GHz) for EX3DV4 ± 0.2 dB(30 MHz to 4 GHz) for ES3DV3
DynamicRange:	10 mW/kg — 100W/kg
Probe Length:	330 mm
Probe Tip	
Length:	20 mm
Body Diameter:	12 mm
Tip Diameter:	2.5 mm (3.9 mm for ES3DV3)
Tip-Center:	1 mm (2.0mm for ES3DV3)
Application:	SAR Dosimetry Testing Compliance tests of mobile phones Dosimetry in strong gradient fields



Picture C.2 Near-field Probe



Picture C.3 E-field Probe

C.3 E-field Probe Calibration

Each E-Probe/Probe Amplifier combination has unique calibration parameters. A TEM cell calibration procedure is conducted to determine the proper amplifier settings to enter in the probe parameters. The amplifier settings are determined for a given frequency by subjecting the probe to a known E-field density (1 mW/cm^2) using an RF Signal generator, TEM cell, and RF Power Meter.

The free space E-field from amplified probe outputs is determined in a test chamber. This calibration can be performed in a TEM cell if the frequency is below 1 GHz and in a waveguide or other methodologies above 1 GHz for free space. For the free space calibration, the probe is placed

©Copyright. All rights reserved by CTTL.

in the volumetric center of the cavity and at the proper orientation with the field. The probe is then rotated 360 degrees until the three channels show the maximum reading. The power density readings equates to 1 mW/cm².

E-field temperature correlation calibration is performed in a flat phantom filled with the appropriate simulated brain tissue. The E-field in the medium correlates with the temperature rise in the dielectric medium. For temperature correlation calibration a RF transparent thermistor-based temperature probe is used in conjunction with the E-field probe.

$$SAR = C \frac{\Delta T}{\Delta t}$$

Where:

Δt = Exposure time (30 seconds),

C = Heat capacity of tissue (brain or muscle),

ΔT = Temperature increase due to RF exposure.

$$SAR = \frac{|E|^2 \cdot \sigma}{\rho}$$

Where:

σ = Simulated tissue conductivity,

ρ = Tissue density (kg/m³).

C.4 Other Test Equipment

C.4.1 Data Acquisition Electronics(DAE)

The data acquisition electronics consist of a highly sensitive electrometer-grade preamplifier with auto-zeroing, a channel and gain-switching multiplexer, a fast 16 bit AD-converter and a command decoder with a control logic unit. Transmission to the measurement server is accomplished through an optical downlink for data and status information, as well as an optical uplink for commands and the clock.

The mechanical probe mounting device includes two different sensor systems for frontal and sideways probe contacts. They are used for mechanical surface detection and probe collision detection.

The input impedance of the DAE is 200 MOhm; the inputs are symmetrical and floating. Common mode rejection is above 80 dB.



PictureC.4: DAE

C.4.2 Robot

The SPEAG DASY system uses the high precision robots (DASY5: RX160L) type from Stäubli SA (France). For the 6-axis controller system, the robot controller version from Stäubli is used. The Stäubli robot series have many features that are important for our application:

- High precision (repeatability 0.02mm)
- High reliability (industrial design)
- Low maintenance costs (virtually maintenance free due to direct drive gears; no belt drives)
- Jerk-free straight movements (brushless synchron motors; no stepper motors)
- Low ELF interference (motor control fields shielded via the closed metallic construction shields)



Picture C.5 DASY 5

C.4.3 Measurement Server

The Measurement server is based on a PC/104 CPU board with CPU (DASY5: 400 MHz, Intel Celeron), chipdisk (DASY5: 128MB), RAM (DASY5: 128MB). The necessary circuits for communication with the DAE electronic box, as well as the 16 bit AD converter system for optical detection and digital I/O interface are contained on the DASY I/O board, which is directly connected to the PC/104 bus of the CPU board.

The measurement server performs all real-time data evaluation of field measurements and surface detection, controls robot movements and handles safety operation. The PC operating system cannot interfere with these time critical processes. All connections are supervised by a watchdog, and disconnection of any of the cables to the measurement server will automatically disarm the robot and disable all program-controlled robot movements. Furthermore, the measurement server is equipped with an expansion port which is reserved for future applications. Please note that this expansion port does not have a standardized pinout, and therefore only devices provided by SPEAG can be connected. Devices from any other supplier could seriously damage the measurement server.



Picture C.6 Server for DASY 5

C.4.4 Device Holder for Phantom

The SAR in the phantom is approximately inversely proportional to the square of the distance between the source and the liquid surface. For a source at 5mm distance, a positioning uncertainty of $\pm 0.5\text{mm}$ would produce a SAR uncertainty of $\pm 20\%$. Accurate device positioning is therefore crucial for accurate and repeatable measurements. The positions in which the devices must be measured are defined by the standards.

The DASY device holder is designed to cope with the different positions given in the standard. It has two scales for device rotation (with respect to the body axis) and device inclination (with respect to the line between the ear reference points). The rotation centers for both scales are the ear reference point (ERP). Thus the device needs no repositioning when changing the angles.

The DASY device holder is constructed of low-loss POM material having the following dielectric parameters: relative permittivity $\epsilon = 3$ and loss tangent $\delta = 0.02$. The amount of dielectric material has been reduced in the closest vicinity of the device, since measurements have suggested that the influence of the clamp on the test results could thus be lowered.

<Laptop Extension Kit>

The extension is lightweight and made of POM, acrylic glass and foam. It fits easily on the upper part of the Mounting Device in place of the phone positioner. The extension is fully compatible with the Twin-SAM and ELI phantoms.



Picture C7-1: Device Holder

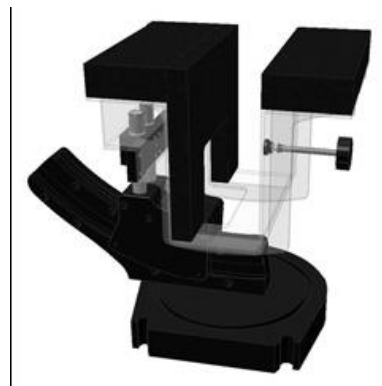

Picture C.7-2: Laptop Extension Kit

C.4.5 Phantom

The SAM Twin Phantom V4.0 is constructed of a fiberglass shell integrated in a table. The shape of the shell is based on data from an anatomical study designed to represent the 90th percentile of the population. The phantom enables the dissymmetric evaluation of SAR for both left and right handed handset usage, as well as body-worn usage using the flat phantom region. Reference markings on the Phantom allow the complete setup of all predefined phantom positions and measurement grids by manually teaching three points in the robot. The shell phantom has a 2mm shell thickness (except the ear region where shell thickness increases to 6 mm).

Shell Thickness: 2 ± 0.2 mm

Filling Volume: Approx. 25 liters

Dimensions: 810 x 1000 x 500 mm (H x L x W)

Available: Special

©Copyright. All rights reserved by CTTL.



Picture C.8: SAM Twin Phantom

ANNEX D Position of the wireless device in relation to the phantom

D.1 General considerations

This standard specifies two handset test positions against the head phantom – the “cheek” position and the “tilt” position.

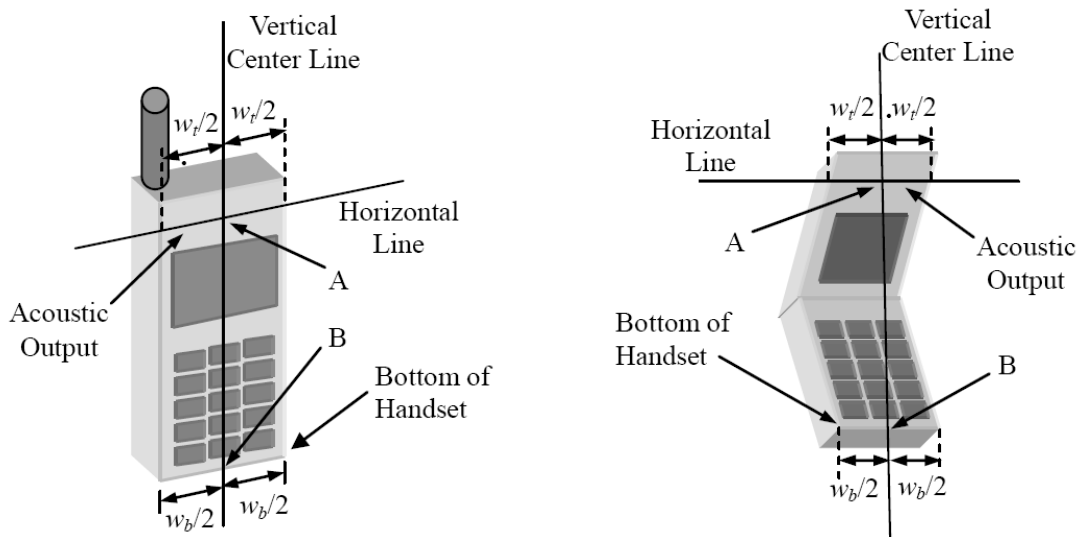

- w_t Width of the handset at the level of the acoustic
- w_b Width of the bottom of the handset
- A Midpoint of the width w_t of the handset at the level of the acoustic output
- B Midpoint of the width w_b of the bottom of the handset

Picture D.1-a Typical “fixed” case handset Picture D.1-b Typical “clam-shell” case handset

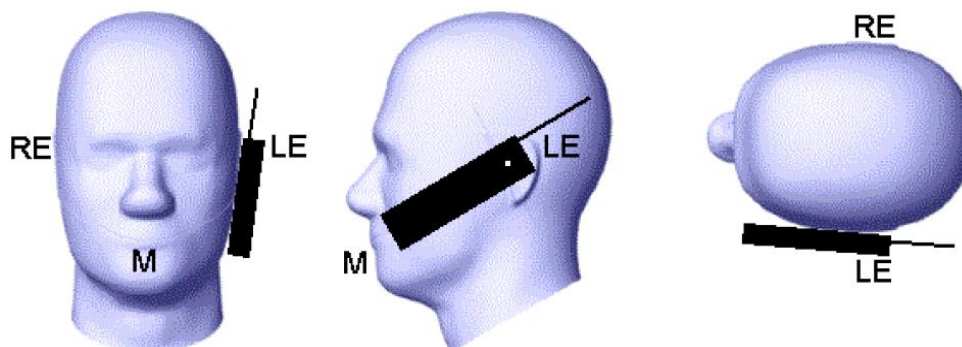

Picture D.2 Cheek position of the wireless device on the left side of SAM

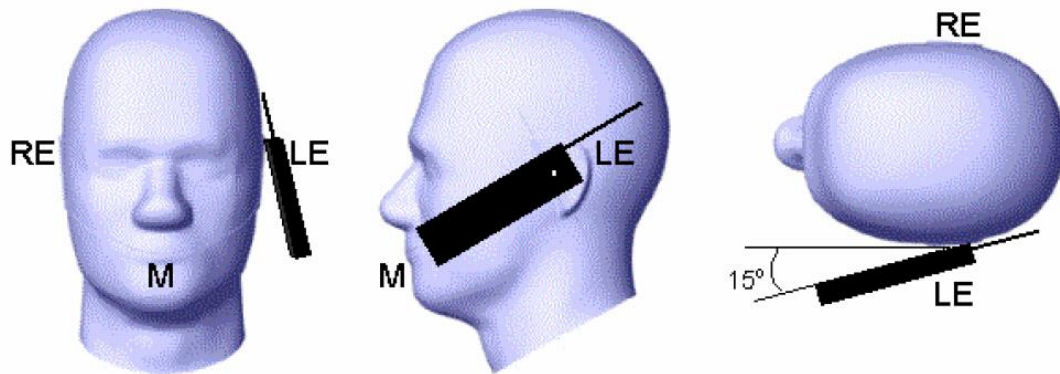

Picture D.3 Tilt position of the wireless device on the left side of SAM

D.2 Body-worn device

A typical example of a body-worn device is a mobile phone, wireless enabled PDA or other battery operated wireless device with the ability to transmit while mounted on a person's body using a carry accessory approved by the wireless device manufacturer.

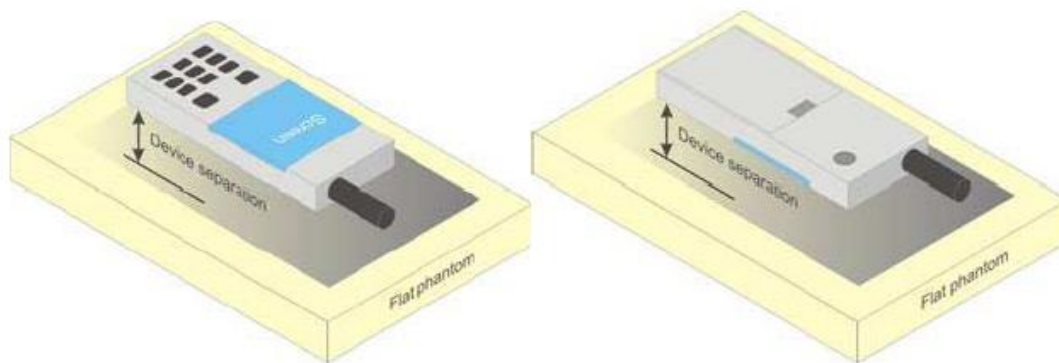

Picture D.4 Test positions for body-worn devices

D.3 Desktop device

A typical example of a desktop device is a wireless enabled desktop computer placed on a table or desk when used.

The DUT shall be positioned at the distance and in the orientation to the phantom that corresponds to the intended use as specified by the manufacturer in the user instructions. For devices that employ an external antenna with variable positions, tests shall be performed for all antenna positions specified. Picture 8.5 show positions for desktop device SAR tests. If the intended use is not specified, the device shall be tested directly against the flat phantom.

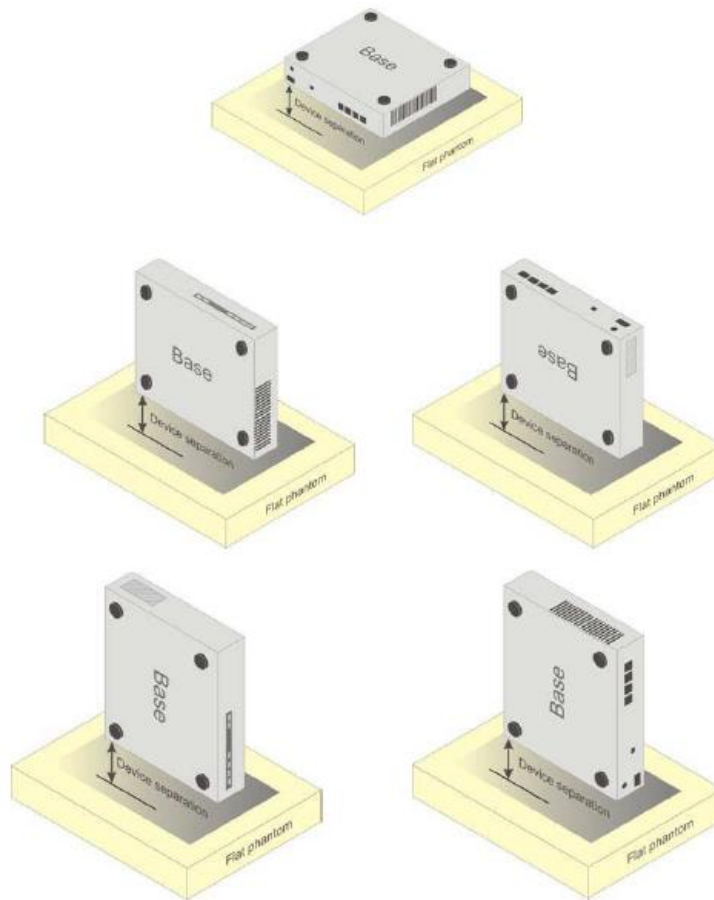

Picture D.5 Test positions for desktop devices

D.4 DUT Setup Photos



Picture D.6

ANNEX E Equivalent Media Recipes

The liquid used for the frequency range of 800-3000 MHz consisted of water, sugar, salt, preventol, glycol monobutyl and Cellulose. The liquid has been previously proven to be suited for worst-case. The Table E.1 shows the detail solution. It's satisfying the latest tissue dielectric parameters requirements proposed by the IEEE 1528 and IEC 62209.

TableE.1: Composition of the Tissue Equivalent Matter

Frequency (MHz)	835Head	835Body	1900 Head	1900 Body	2450 Head	2450 Body	5800 Head	5800 Body
Ingredients (% by weight)								
Water	41.45	52.5	55.242	69.91	58.79	72.60	65.53	65.53
Sugar	56.0	45.0	\	\	\	\	\	\
Salt	1.45	1.4	0.306	0.13	0.06	0.18	\	\
Preventol	0.1	0.1	\	\	\	\	\	\
Cellulose	1.0	1.0	\	\	\	\	\	\
Glycol Monobutyl	\	\	44.452	29.96	41.15	27.22	\	\
Diethyleneglycol monohexylether	\	\	\	\	\	\	17.24	17.24
Triton X-100	\	\	\	\	\	\	17.24	17.24
Dielectric Parameters Target Value	$\epsilon=41.5$ $\sigma=0.90$	$\epsilon=55.2$ $\sigma=0.97$	$\epsilon=40.0$ $\sigma=1.40$	$\epsilon=53.3$ $\sigma=1.52$	$\epsilon=39.2$ $\sigma=1.80$	$\epsilon=52.7$ $\sigma=1.95$	$\epsilon=35.3$ $\sigma=5.27$	$\epsilon=48.2$ $\sigma=6.00$

Note: There are a little adjustment respectively for 750, 1750, 2600, 5200, 5300 and 5600 based on the recipe of closest frequency in table E.1.

ANNEX F System Validation

The SAR system must be validated against its performance specifications before it is deployed. When SAR probes, system components or software are changed, upgraded or recalibrated, these must be validated with the SAR system(s) that operates with such components.

Table F.1: System Validation for 7517

Probe SN.	Liquid name	Validation date	Frequency point	Status (OK or Not)
7517	Head 750MHz	February.7,2022	750 MHz	OK
7517	Head 900MHz	February.7,2022	900 MHz	OK
7517	Head 1750MHz	February.7,2022	1750 MHz	OK
7517	Head 1900MHz	February.8,2022	1900 MHz	OK
7517	Head 2300MHz	February.8,2022	2300 MHz	OK
7517	Head 2450MHz	February.8,2022	2450 MHz	OK
7517	Head 2600MHz	February.8,2022	2600 MHz	OK
7517	Head 3300MHz	February.9,2022	3300 MHz	OK
7517	Head 3500MHz	February.9,2022	3500 MHz	OK
7517	Head 3700MHz	February.9,2022	3700 MHz	OK
7517	Head 5250MHz	February.10,2022	5250 MHz	OK
7517	Head 5600MHz	February.10,2022	5600 MHz	OK
7517	Head 5750MHz	February.10,2022	5750 MHz	OK



ANNEX G Probe Calibration Certificate

Probe 7517 Calibration Certificate



Add: No.52 HuaYuanBei Road, Haidian District, Beijing, 100191, China
 Tel: +86-10-62304633-2512 Fax: +86-10-62304633-2504
 E-mail: cttl@chinattl.com Http://www.chinattl.cn

Client **CTTL**

Certificate No: **Z21-60558**

CALIBRATION CERTIFICATE

Object **EX3DV4 - SN : 7517**

Calibration Procedure(s) **FF-Z11-004-02
Calibration Procedures for Dosimetric E-field Probes**

Calibration date: **January 19, 2022**

This calibration Certificate documents the traceability to national standards, which realize the physical units of measurements(SI). The measurements and the uncertainties with confidence probability are given on the following pages and are part of the certificate.

All calibrations have been conducted in the closed laboratory facility: environment temperature(22±3)°C and humidity<70%.

Calibration Equipment used (M&TE critical for calibration)

Primary Standards	ID #	Cal Date(Calibrated by, Certificate No.)	Scheduled Calibration
Power Meter NRP2	101919	15-Jun-21(CTTL, No.J21X04466)	Jun-22
Power sensor NRP-Z91	101547	15-Jun-21(CTTL, No.J21X04466)	Jun-22
Power sensor NRP-Z91	101548	15-Jun-21(CTTL, No.J21X04466)	Jun-22
Reference 10dBAttenuator	18N50W-10dB	10-Feb-20(CTTL, No.J20X00525)	Feb-22
Reference 20dBAttenuator	18N50W-20dB	10-Feb-20(CTTL, No.J20X00526)	Feb-22
Reference Probe EX3DV4	SN 3617	27-Jan-21(SPEAG, No.EX3-3617_Jan21)	Jan-22
DAE4	SN 1555	20-Aug-21(SPEAG, No.DAE4-1555_Aug21/2)	Aug-22
Secondary Standards	ID #	Cal Date(Calibrated by, Certificate No.)	Scheduled Calibration
SignalGenerator MG3700A	6201052605	16-Jun-21(CTTL, No.J21X04467)	Jun-22
Network Analyzer E5071C	MY46110673	14-Jan-22 (CTTL, No.J22X00406)	Jan -23

	Name	Function	Signature
Calibrated by:	Yu Zongying	SAR Test Engineer	
Reviewed by:	Lin Hao	SAR Test Engineer	
Approved by:	Qi Dianyuan	SAR Project Leader	

Issued: January 21, 2022

This calibration certificate shall not be reproduced except in full without written approval of the laboratory.

Certificate No: Z21-60558

Page 1 of 10



In Collaboration with
s p e a g
CALIBRATION LABORATORY



Add: No.52 HuaYuanBei Road, Haidian District, Beijing, 100191, China
Tel: +86-10-62304633-2512 Fax: +86-10-62304633-2504
E-mail: ctl@chinattl.com [Http://www.chinattl.cn](http://www.chinattl.cn)

Glossary:

TSL	tissue simulating liquid
NORM _{x,y,z}	sensitivity in free space
ConvF	sensitivity in TSL / NORM _{x,y,z}
DCP	diode compression point
CF	crest factor (1/duty_cycle) of the RF signal
A,B,C,D	modulation dependent linearization parameters
Polarization Φ	Φ rotation around probe axis
Polarization θ	θ rotation around an axis that is in the plane normal to probe axis (at measurement center), i $\theta=0$ is normal to probe axis

Connector Angle information used in DASY system to align probe sensor X to the robot coordinate system

Calibration is Performed According to the Following Standards:

- IEEE Std 1528-2013, "IEEE Recommended Practice for Determining the Peak Spatial-Averaged Specific Absorption Rate (SAR) in the Human Head from Wireless Communications Devices: Measurement Techniques", June 2013
- IEC 62209-1, "Measurement procedure for the assessment of Specific Absorption Rate (SAR) from hand-held and body-mounted devices used next to the ear (frequency range of 300 MHz to 6 GHz)", July 2016
- IEC 62209-2, "Procedure to determine the Specific Absorption Rate (SAR) for wireless communication devices used in close proximity to the human body (frequency range of 30 MHz to 6 GHz)", March 2010
- KDB 865664, "SAR Measurement Requirements for 100 MHz to 6 GHz"

Methods Applied and Interpretation of Parameters:

- NORM_{x,y,z}:** Assessed for E-field polarization $\theta=0$ ($f \leq 900\text{MHz}$ in TEM-cell; $f > 1800\text{MHz}$: waveguide). NORM_{x,y,z} are only intermediate values, i.e., the uncertainties of NORM_{x,y,z} does not effect the E^2 -field uncertainty inside TSL (see below ConvF).
- NORM(f)_{x,y,z} = NORM_{x,y,z} * frequency_response** (see Frequency Response Chart). This linearization is implemented in DASY4 software versions later than 4.2. The uncertainty of the frequency response is included in the stated uncertainty of ConvF.
- DCP_{x,y,z}:** DCP are numerical linearization parameters assessed based on the data of power sweep (no uncertainty required). DCP does not depend on frequency nor media.
- PAR:** PAR is the Peak to Average Ratio that is not calibrated but determined based on the signal characteristics.
- A_{x,y,z}; B_{x,y,z}; C_{x,y,z}; VR_{x,y,z}:** A,B,C are numerical linearization parameters assessed based on the data of power sweep for specific modulation signal. The parameters do not depend on frequency nor media. VR is the maximum calibration range expressed in RMS voltage across the diode.
- ConvF and Boundary Effect Parameters:** Assessed in flat phantom using E-field (or Temperature Transfer Standard for $f \leq 800\text{MHz}$) and inside waveguide using analytical field distributions based on power measurements for $f > 800\text{MHz}$. The same setups are used for assessment of the parameters applied for boundary compensation (alpha, depth) of which typical uncertainty valued are given. These parameters are used in DASY4 software to improve probe accuracy close to the boundary. The sensitivity in TSL corresponds to NORM_{x,y,z} * ConvF whereby the uncertainty corresponds to that given for ConvF. A frequency dependent ConvF is used in DASY version 4.4 and higher which allows extending the validity from $\pm 50\text{MHz}$ to $\pm 100\text{MHz}$.
- Spherical isotropy (3D deviation from isotropy):** in a field of low gradients realized using a flat phantom exposed by a patch antenna.
- Sensor Offset:** The sensor offset corresponds to the offset of virtual measurement center from the probe tip (on probe axis). No tolerance required.
- Connector Angle:** The angle is assessed using the information gained by determining the NORM_x (no uncertainty required).



Add: No.52 HuaYuanBei Road, Haidian District, Beijing, 100191, China
 Tel: +86-10-62304633-2512 Fax: +86-10-62304633-2504
 E-mail: ctl@chinattl.com [Http://www.chinattl.cn](http://www.chinattl.cn)

DASY/EASY – Parameters of Probe: EX3DV4 – SN:7517

Basic Calibration Parameters

	Sensor X	Sensor Y	Sensor Z	Unc (k=2)
Norm($\mu\text{V}/(\text{V}/\text{m})^2$) ^A	0.49	0.51	0.55	$\pm 10.0\%$
DCP(mV) ^B	101.9	101.5	100.9	

Modulation Calibration Parameters

UID	Communication System Name		A dB	B dB/ μV	C	D dB	VR mV	Unc ^E (k=2)
0	CW	X	0.0	0.0	1.0	0.00	168.0	$\pm 3.0\%$
		Y	0.0	0.0	1.0		172.3	
		Z	0.0	0.0	1.0		178.0	

The reported uncertainty of measurement is stated as the standard uncertainty of Measurement multiplied by the coverage factor $k=2$, which for a normal distribution corresponds to a coverage probability of approximately 95%.

^A The uncertainties of Norm X, Y, Z do not affect the E^2 -field uncertainty inside TSL (see Page 4 and Page 5).

^B Numerical linearization parameter: uncertainty not required.

^E Uncertainty is determined using the max. deviation from linear response applying rectangular distribution and is expressed for the square of the field value.