



FCC PART 15C TEST REPORT

No. I22Z61006-IOT02

for

BLU Products,Inc.

Mobile Phone

Model Name: B200VL

FCC ID: YHLBLUB200VL

with

Hardware Version: V1.0

Software Version: BLU_B200VL_V11.0.01.05.01.01

Issued Date: 2022-7-25

Note:

The test results in this test report relate only to the devices specified in this report. This report shall not be reproduced except in full without the written approval of CTTL.

The report must not be used by the client to claim product certification, approval, or endorsement by NVLAP, NIST, or any agency of the U.S. Government.

Test Laboratory:

CTTL, Telecommunication Technology Labs, CAICT

No.52, HuayuanNorth Road, Haidian District, Beijing, P. R. China 100191.

Tel:+86(0)10-62304633-2512,Fax:+86(0)10-62304633-2504

Email:cttl_terminals@caict.ac.cn, website: www.chinattl.com



REPORT HISTORY

| Report Number | Revision | Description | Issue Date |
|----------------------|-----------------|--------------------|-------------------|
| I22Z61006-IOT02 | Rev.0 | 1st edition | 2022-7-25 |

CONTENTS

| | |
|---|-----------|
| 1. TEST LABORATORY | 5 |
| 1.1. INTRODUCTION & ACCREDITATION | 5 |
| 1.2. TESTING LOCATION | 5 |
| 1.3. TESTING ENVIRONMENT..... | 6 |
| 1.4. PROJECT DATA | 6 |
| 1.5. SIGNATURE | 6 |
| 2. CLIENT INFORMATION..... | 7 |
| 2.1. APPLICANT INFORMATION | 7 |
| 2.2. MANUFACTURER INFORMATION | 7 |
| 3. EQUIPMENT UNDER TEST (EUT) AND ANCILLARY EQUIPMENT (AE) | 8 |
| 3.1. ABOUT EUT | 8 |
| 3.2. INTERNAL IDENTIFICATION OF EUT | 8 |
| 3.3. INTERNAL IDENTIFICATION OF AE..... | 8 |
| 3.4. NORMAL ACCESSORY SETTING..... | 9 |
| 3.5. GENERAL DESCRIPTION..... | 9 |
| 4. REFERENCE DOCUMENTS..... | 10 |
| 4.1. DOCUMENTS SUPPLIED BY APPLICANT | 10 |
| 4.2. REFERENCE DOCUMENTS FOR TESTING..... | 10 |
| 5. TEST RESULTS | 11 |
| 5.1. SUMMARY OF TEST RESULTS | 11 |
| 5.2. STATEMENTS..... | 11 |
| 6. TEST FACILITIES UTILIZED..... | 12 |
| 7. MEASUREMENT UNCERTAINTY | 13 |
| 7.1. PEAK OUTPUT POWER - CONDUCTED..... | 13 |
| 7.2. FREQUENCY BAND EDGES - CONDUCTED | 13 |
| 7.3. FREQUENCY BAND EDGES - RADIATED | 13 |
| 7.4. TRANSMITTER SPURIOUS EMISSION - CONDUCTED..... | 13 |
| 7.5. TRANSMITTER SPURIOUS EMISSION - RADIATED..... | 13 |
| 7.6. TIME OF OCCUPANCY (DWELL TIME) | 13 |
| 7.7. 20dB BANDWIDTH | 14 |
| 7.8. CARRIER FREQUENCY SEPARATION | 14 |
| 7.9. AC POWERLINE CONDUCTED EMISSION | 14 |
| ANNEX A: EUT PARAMETERS | 15 |
| ANNEX B: DETAILED TEST RESULTS..... | 16 |
| B.1. MEASUREMENT METHOD | 16 |
| B.2. PEAK OUTPUT POWER..... | 17 |



B.3. FREQUENCY BAND EDGES – CONDUCTED 19

B.4. FREQUENCY BAND EDGES –RADIATED..... 26

B.5. TRANSMITTER SPURIOUS EMISSION - CONDUCTED 32

B.6. TRANSMITTER SPURIOUS EMISSION - RADIATED 57

B.7. TIME OF OCCUPANCY (DWELL TIME)..... 66

B.8. 20DB BANDWIDTH..... 77

B.9. CARRIER FREQUENCY SEPARATION 83

B.10. NUMBER OF HOPPING CHANNELS 86

B.11. AC POWERLINE CONDUCTED EMISSION 90

ANNEX C: ACCREDITATION CERTIFICATE 96



1. Test Laboratory

1.1. Introduction & Accreditation

Telecommunication Technology Labs, CAICT is an ISO/IEC 17025:2017 accredited test laboratory under NATIONAL VOLUNTARY LABORATORY ACCREDITATION PROGRAM (NVLAP) with lab code 600118-0, and is also an FCC accredited test laboratory (CN5017), and ISED accredited test laboratory (ISED#: 24849). The detail accreditation scope can be found on NVLAP website.

1.2. Testing Location

Conducted testing Location: CTTL(huayuan North Road)

Address: No. 52, Huayuan North Road, Haidian District, Beijing,
P. R. China100191

Radiated testing Location: CTTL(huayuan North Road)

Address: No. 52, Huayuan North Road, Haidian District, Beijing,
P. R. China100191

1.3. Testing Environment

Normal Temperature: 20-27℃
Relative Humidity: 20-50%

1.4. Project data

Testing Start Date: 2022-5-2
Testing End Date: 2022-7-25

1.5. Signature

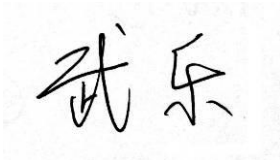

Wu Le
(Prepared this test report)



Sun Zhenyu
(Reviewed this test report)



Hu Xiaoyu
(Approved this test report)



2. Client Information

2.1. Applicant Information

Company Name: BLU Products,Inc.
Address /Post: 10814 NW 33rd St # 100 Doral, FL 33172,USA
City: /
Postal Code: /
Country: USA
Telephone: 305.715.7171
Fax: 305.436.8819

2.2. Manufacturer Information

Company Name: BLU Products,Inc.
Address /Post: 10814 NW 33rd St # 100 Doral, FL 33172,USA
City: /
Postal Code: /
Country: USA
Telephone: 305.715.7171
Fax: 305.436.8819

3. Equipment Under Test (EUT) and Ancillary Equipment (AE)

3.1. About EUT

| | |
|--------------------|-----------------------|
| Description | Mobile Phone |
| Model Name | B200VL |
| FCC ID | YHLBLUB200VL |
| Frequency Band | ISM 2400MHz~2483.5MHz |
| Type of Modulation | GFSK/π/4 DQPSK/8DPSK |
| Number of Channels | 79 |
| Power Supply | 3.8V DC by Battery |
| Antenna gain | 2.4dBi |

3.2. Internal Identification of EUT

| EUT ID* | SN or IMEI | HW Version | SW Version | Date of receipt |
|---------|-----------------|------------|----------------------------------|-----------------|
| UT51a | 357173130005915 | V1.0 | BLU_B200VL_V11.0.01.05.0 1.01 | 2022-06-17 |
| UT24a | 357173130002821 | V1.0 | BLU_B200VL_V11.0.01.05.0 1.01 | 2022-05-02 |

*EUT ID: is used to identify the test sample in the lab internally.

3.3. Internal Identification of AE

| AE ID* | Description | | |
|--------|-------------|--------------|---|
| AE1 | Battery | LT25H426271B | / |
| AE2 | Charger | TN-050120U9 | / |
| AE3 | Charger | TN-050120U8 | / |
| AE4 | USB Cable | 336275 | / |
| AE5 | USB Cable | T365-011B-1 | / |

AE1

| | |
|--------------|---------------------------------------|
| Model | LT25H426271B |
| Manufacturer | GUANGDONG FENGHUA NEW ENERGY CO.,LTD. |
| Capacity | 1450mAh |
| Voltage | 3.8V |

AE2

| | |
|--------------|---|
| Model | TN-050120U9 |
| Manufacturer | Chongqing Lianmao Electronics Co., Ltd. |

AE3

| | |
|--------------|--|
| Model | TN-050120U8 |
| Manufacturer | Guangdong Beicom Electronics Co., Ltd. |



AE4

| | |
|--------------|-----------------------------|
| Model | 336275 |
| Manufacturer | SUNTOPS ELECTRONICS CO.,LTD |

AE5

| | |
|--------------|---|
| Model | T365-011B-1 |
| Manufacturer | Shenzhen Yihuaxing Electronics Co. Ltd. |

*AE ID: is used to identify the test sample in the lab internally.

3.4. Normal Accessory setting

Fully charged battery should be used during the test.

3.5. General Description

The Equipment Under Test (EUT) is a model of Mobile Phone with integrated antenna. It consists of normal options: lithium battery, charger. Manual and specifications of the EUT were provided to fulfill the test. Samples undergoing test were selected by the Client.

4. Reference Documents

4.1. Documents supplied by applicant

EUT parameters, referring to Annex B for detailed information, is supplied by the client or manufacturer, which is the basis of testing.

4.2. Reference Documents for testing

The following documents listed in this section are referred for testing.

| Reference | Title | Version |
|-------------|--|-----------|
| FCC Part15 | FCC CFR 47, Part 15, Subpart C: 15.205 Restricted bands of operation; 15.209 Radiated emission limits, general requirements; 15.247 Operation within the bands 902–928MHz, 2400–2483.5 MHz, and 5725–5850 MHz. | 2019 |
| ANSI C63.10 | American National Standard of Procedures for Compliance Testing of Unlicensed Wireless Devices | June,2013 |

5. Test Results

5.1. Summary of Test Results

Abbreviations used in this clause:

- P** Pass, The EUT complies with the essential requirements in the standard.
- F** Fail, The EUT does not comply with the essential requirements in the standard
- NA** Not Applicable, The test was not applicable
- NP** Not Performed, The test was not performed by CTTL

| SUMMARY OF MEASUREMENT RESULTS | Sub-clause | Verdict |
|---|------------------------|-----------|
| Peak Output Power | 15.247 (b)(1) | P |
| Frequency Band Edges- Conducted | 15.247 (d) | P |
| Frequency Band Edges- Radiated | 15.247, 15.205, 15.209 | P |
| Transmitter Spurious Emission - Conducted | 15.247 (d) | P |
| Transmitter Spurious Emission - Radiated | 15.247, 15.205, 15.209 | P |
| Time of Occupancy (Dwell Time) | 15.247 (a) (1)(iii) | P |
| 20dB Bandwidth | 15.247 (a)(1) | NA |
| Carrier Frequency Separation | 15.247 (a)(1) | P |
| Number of hopping channels | 15.247 (a)(iii) | P |
| AC Powerline Conducted Emission | 15.107, 15.207 | P |

Please refer to **ANNEX A** for detail.

The measurement is made according to ANSI C63.10.

5.2. Statements

CTTL has evaluated the test cases requested by the applicant /manufacturer as listed in section 5.1 of this report for the EUT specified in section 3 according to the standards or reference documents listed in section 4.2

6. Test Facilities Utilized

Conducted test system

| No. | Equipment | Model | Serial Number | Manufacturer | Calibration Period | Calibration Due date |
|-----|------------------------|--------|---------------|--------------|--------------------|----------------------|
| 1 | Vector Signal Analyzer | FSQ26 | 100024 | R&S | 1 year | 2023-03-23 |
| 2 | Bluetooth Tester | CBT | 100315 | R&S | 1 year | 2023-01-22 |
| 3 | LISN | ENV216 | 101200 | R&S | 1 year | 2023-05-30 |
| 4 | Test Receiver | ESCI | 100344 | R&S | 1 year | 2023-02-21 |
| 5 | Bluetooth Tester | CBT | 101042 | R&S | 1 year | 2022-12-23 |
| 6 | Shielding Room | S81 | / | ETS-Lindgren | / | / |

Radiated emission test system

| No. | Equipment | Model | Serial Number | Manufacturer | Calibration Period | Calibration Due date |
|-----|-----------------------------------|----------|---------------|-----------------|--------------------|----------------------|
| 1 | Test Receiver | ESW44 | 103023 | Rohde & Schwarz | 1 year | 2022-10-28 |
| 2 | BiLog Antenna | VULB9163 | 302 | Schwarzbeck | 1 year | 2022-12-28 |
| 3 | Dual-Ridge Waveguide Horn Antenna | 3116 | 2663 | ETS-Lindgren | 1 year | 2022-08-11 |
| 4 | EMI Antenna | 3115 | 6914 | ETS-Lindgren | 1 year | 2023-01-20 |
| 5 | Bluetooth Tester | CBT | 101042 | Rohde & Schwarz | 1 year | 2022-12-23 |

7. Measurement Uncertainty

7.1. Peak Output Power - Conducted

Measurement Uncertainty:

| | |
|-------------------------------|--------|
| Measurement Uncertainty (k=2) | 0.66dB |
|-------------------------------|--------|

7.2. Frequency Band Edges - Conducted

Measurement Uncertainty:

| | |
|-------------------------------|--------|
| Measurement Uncertainty (k=2) | 0.66dB |
|-------------------------------|--------|

7.3. Frequency Band Edges - Radiated

Measurement Uncertainty:

| | |
|-------------------------------|---|
| Measurement Uncertainty (k=2) | / |
|-------------------------------|---|

7.4. Transmitter Spurious Emission - Conducted

Measurement Uncertainty:

| Frequency Range | Uncertainty (k=2) |
|-------------------|-------------------|
| 30 MHz ~ 8 GHz | 1.22dB |
| 8 GHz ~ 12.75 GHz | 1.51dB |
| 12.7GHz ~ 26 GHz | 1.51dB |

7.5. Transmitter Spurious Emission - Radiated

Measurement Uncertainty:

| Frequency Range | Uncertainty(dBm) (k=2) |
|---|------------------------|
| 9kHz-30MHz | 4.92 |
| $30\text{MHz} \leq f \leq 1\text{GHz}$ | 5.18 |
| $1\text{GHz} \leq f \leq 18\text{GHz}$ | 5.54 |
| $18\text{GHz} \leq f \leq 40\text{GHz}$ | 5.26 |

7.6. Time of Occupancy (Dwell Time)

Measurement Uncertainty:

| | |
|-------------------------------|--------|
| Measurement Uncertainty (k=2) | 0.88ms |
|-------------------------------|--------|

7.7. 20dB Bandwidth

Measurement Uncertainty:

| | |
|-------------------------------|----------|
| Measurement Uncertainty (k=2) | 61.936Hz |
|-------------------------------|----------|

7.8. Carrier Frequency Separation

Measurement Uncertainty:

| | |
|-------------------------------|----------|
| Measurement Uncertainty (k=2) | 61.936Hz |
|-------------------------------|----------|

7.9. AC Powerline Conducted Emission

Measurement Uncertainty:

| | |
|-------------------------------|--------|
| Measurement Uncertainty (k=2) | 3.08dB |
|-------------------------------|--------|



ANNEX A: EUT parameters

Disclaimer: The antenna gain provided by the client may affect the validity of the measurement results in this report, and the client shall bear the impact and consequences arising therefrom.

ANNEX B: Detailed Test Results

B.1. Measurement Method

B.1.1. Conducted Measurements

The measurement is made according to ANSI C63.10.

- 1). Connect the EUT to the test system correctly.
- 2). Set the EUT to the required work mode (Transmitter, receiver or transmitter & receiver).
- 3). Set the EUT to the required channel.
- 4). Set the EUT hopping mode (hopping or hopping off).
- 5). Set the spectrum analyzer to start measurement.
- 6). Record the values. Vector Signal Analyzer

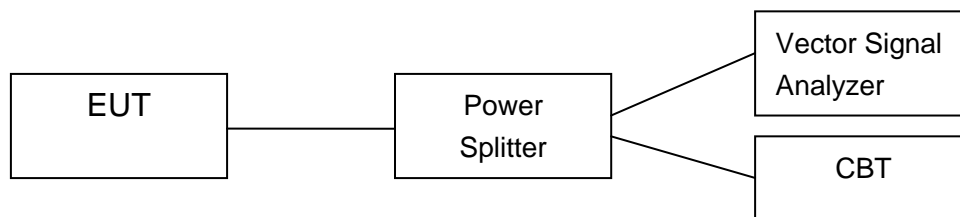

B.1.2. Radiated Emission Measurements

The measurement is made according to ANSI C63.10

The radiated emission test is performed in semi-anechoic chamber. The distance from the EUT to the reference point of measurement antenna is 3m. The test is carried out on both vertical and horizontal polarization and only maximization result of both polarizations is kept. During the test, the turntable is rotated 360° and the measurement antenna is moved from 1m to 4m to get the maximization result.

In the case of radiated emission, the used settings are as follows,

Sweep frequency from 30 MHz to 1GHz, RBW = 100 kHz, VBW = 300 kHz;

Sweep frequency from 1 GHz to 26GHz, RBW = 1MHz, VBW = 1MHz;

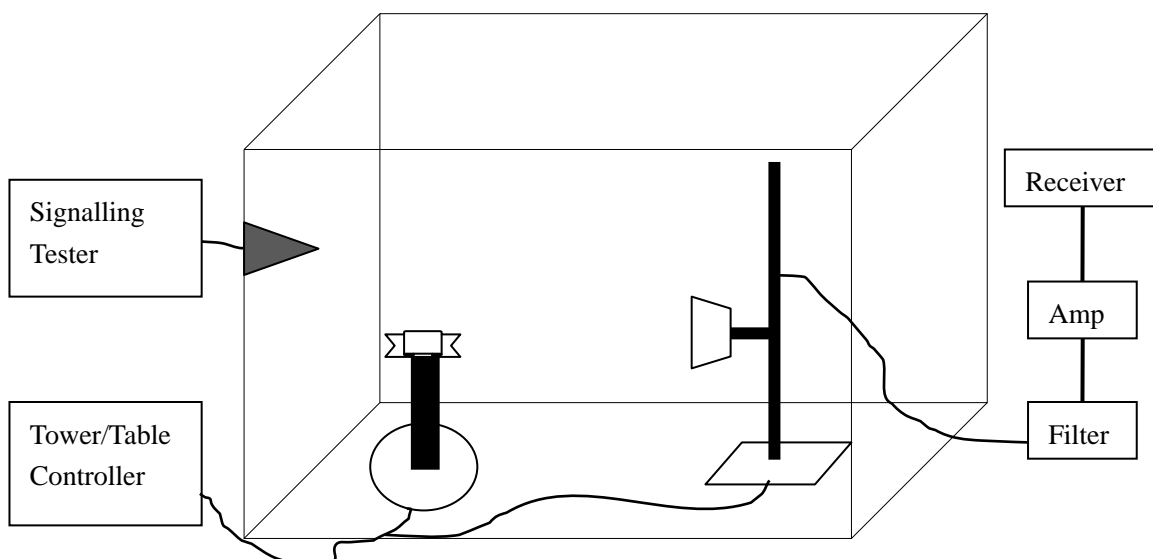

B.2. Peak Output Power

B.2.1. Peak Output Power – Conducted

Method of Measurement: See ANSI C63.10-clause 7.8.5

a) Use the following spectrum analyzer settings:

- Span: 6MHz
- RBW: 3MHz
- VBW: 3MHz
- Sweep time: 2.5ms
- Detector function: peak
- Trace: max hold

b) Allow trace to stabilize.

c) Use the marker-to-peak function to set the marker to the peak of the emission.

d) The indicated level is the peak output power.

Measurement Limit:

| Standard | Limits | |
|------------------------|-----------------------|---------------|
| FCC Part 15.247 (b)(1) | Bandwidth \leq 1MHz | 30dBm (1W) |
| | Bandwidth $>$ 1MHz | 21dBm (125mW) |

Measurement Results:

For GFSK

| Channel | Ch 0 2402 MHz | Ch 39 2441 MHz | Ch 78 2480 MHz | Conclusion |
|-----------------------------------|------------------|-------------------|-------------------|------------|
| Peak Conducted Output Power (dBm) | 10.67 | 10.61 | 10.80 | P |

For $\pi/4$ DQPSK

| Channel | Ch 0 2402 MHz | Ch 39 2441 MHz | Ch 78 2480 MHz | Conclusion |
|-----------------------------------|------------------|-------------------|-------------------|------------|
| Peak Conducted Output Power (dBm) | 10.18 | 10.00 | 9.89 | P |

For 8DPSK

| Channel | Ch 0 2402 MHz | Ch 39 2441 MHz | Ch 78 2480 MHz | Conclusion |
|-----------------------------------|------------------|-------------------|-------------------|------------|
| Peak Conducted Output Power (dBm) | 9.73 | 10.10 | 9.49 | P |

Conclusion: PASS

B.2.2. E.I.R.P.

The radiated E.I.R.P. is listed below:

Antenna gain = 2.4dBi

For GFSK

| Channel | Ch 0 2402 MHz | Ch 39 2441 MHz | Ch 78 2480 MHz | Conclusion |
|---------------|------------------|-------------------|-------------------|------------|
| E.I.R.P (dBm) | 13.07 | 13.01 | 13.20 | P |

For $\pi/4$ DQPSK

| Channel | Ch 0 2402 MHz | Ch 39 2441 MHz | Ch 78 2480 MHz | Conclusion |
|---------------|------------------|-------------------|-------------------|------------|
| E.I.R.P (dBm) | 12.58 | 12.40 | 12.29 | P |

For 8DPSK

| Channel | Ch 0 2402 MHz | Ch 39 2441 MHz | Ch 78 2480 MHz | Conclusion |
|---------------|------------------|-------------------|-------------------|------------|
| E.I.R.P (dBm) | 12.13 | 12.50 | 11.89 | P |

Note: E.I.R.P. are calculated with the antenna gain.

Conclusion: PASS

B.3. Frequency Band Edges – Conducted

Method of Measurement: See ANSI C63.10-clause 7.8.6

Connect the spectrum analyzer to the EUT using an appropriate RF cable connected to the EUT output. Configure the spectrum analyzer settings as described below (be sure to enter all losses between the unlicensed wireless device output and the spectrum analyzer).

- Span: 10 MHz
- Resolution Bandwidth: 100 kHz
- Video Bandwidth: 300 kHz
- Sweep Time:Auto
- Detector: Peak
- Trace: max hold

Place a marker at the end of the restricted band closest to the transmit frequency to show compliance. Also measure any emissions in the restricted bands. Save the spectrum analyzer plot. Repeat for each power and modulation for lowest and highest channel.

Observe the stored trace and measure the amplitude delta between the peak of the fundamental and the peak of the band-edge emission. This is not an absolute field strength measurement; it is only a relative measurement to determine the amount by which the emission drops at the band edge relative to the highest fundamental emission level.

Measurement Limit:

| Standard | Limit (dBc) |
|----------------------------|-------------|
| FCC 47 CFR Part 15.247 (d) | < -20 |

Measurement Result:

For GFSK

| Channel | Hopping | Band Edge Power (dBc) | | Conclusion |
|---------|-------------|------------------------|--------|------------|
| 0 | Hopping OFF | Fig.1 | -60.61 | P |
| | Hopping ON | Fig.2 | -63.51 | P |
| 78 | Hopping OFF | Fig.3 | -66.82 | P |
| | Hopping ON | Fig.4 | -67.31 | P |

For $\pi/4$ DQPSK

| Channel | Hopping | Band Edge Power (dBc) | | Conclusion |
|---------|-------------|------------------------|--------|------------|
| 0 | Hopping OFF | Fig.5 | -60.94 | P |
| | Hopping ON | Fig.6 | -61.30 | P |
| 78 | Hopping OFF | Fig.7 | -65.51 | P |
| | Hopping ON | Fig.8 | -64.28 | P |

For 8DPSK

| Channel | Hopping | Band Edge Power (dBc) | | Conclusion |
|---------|-------------|------------------------|--------|------------|
| 0 | Hopping OFF | Fig.9 | -59.67 | P |
| | Hopping ON | Fig.10 | -63.00 | P |

| | | | | |
|----|-------------|--------|--------|---|
| 78 | Hopping OFF | Fig.11 | -66.10 | P |
| | Hopping ON | Fig.12 | -66.88 | P |

Conclusion: PASS

Test graphs as below

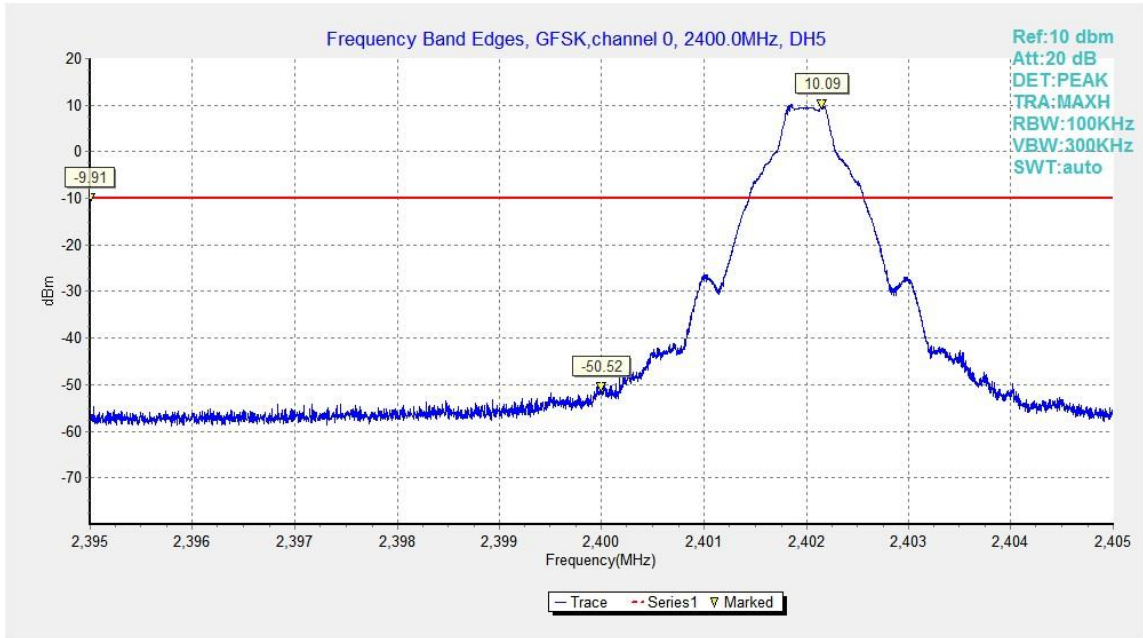

Fig.1. Frequency Band Edges: GFSK, Channel 0, Hopping Off

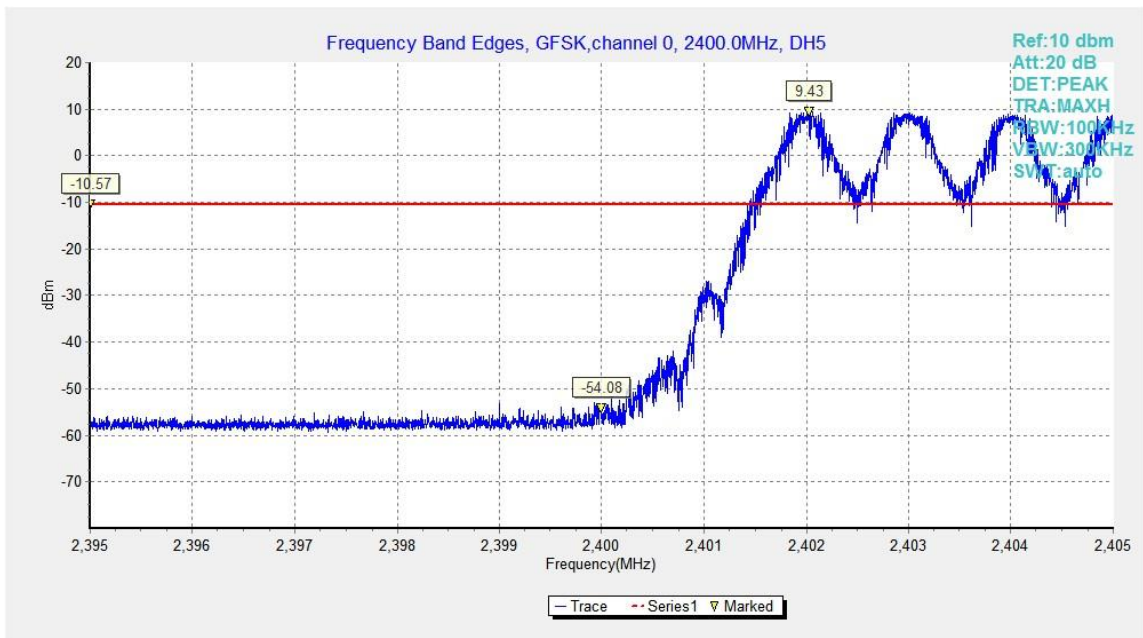

Fig.2. Frequency Band Edges: GFSK, Channel 0, Hopping On

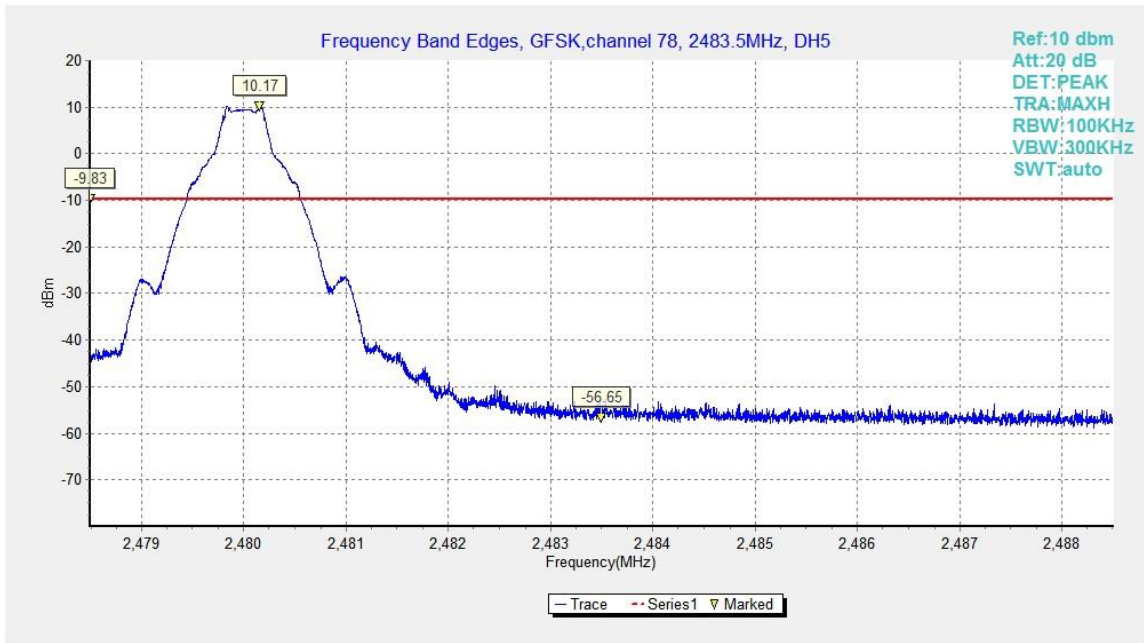

Fig.3. Frequency Band Edges: GFSK, Channel 78, Hopping Off

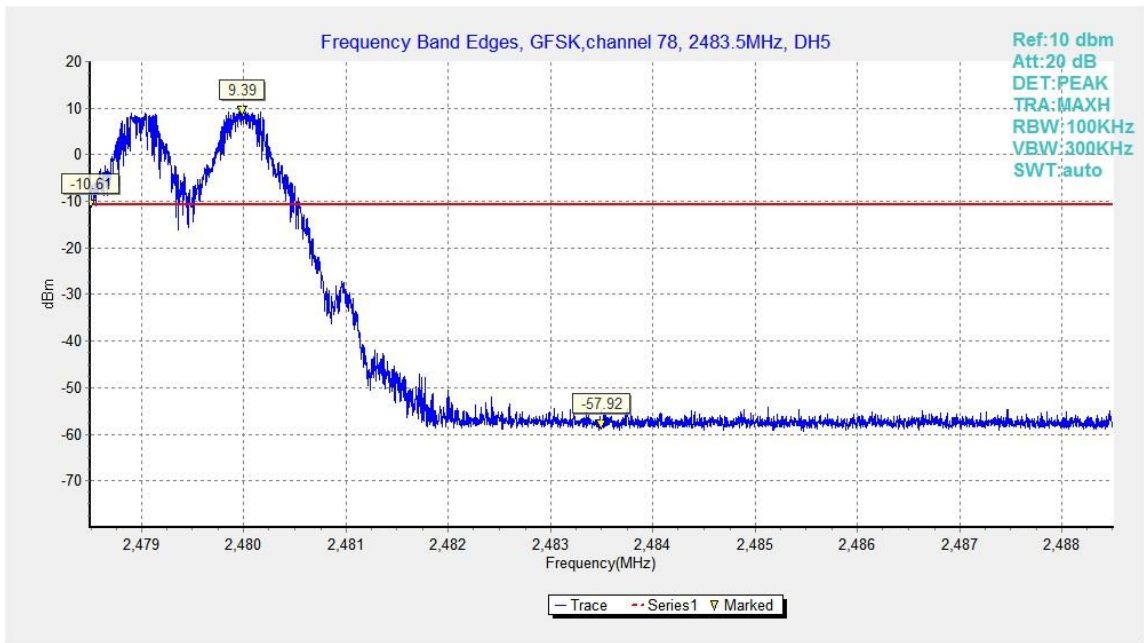

Fig.4. Frequency Band Edges: GFSK, Channel 78, Hopping On

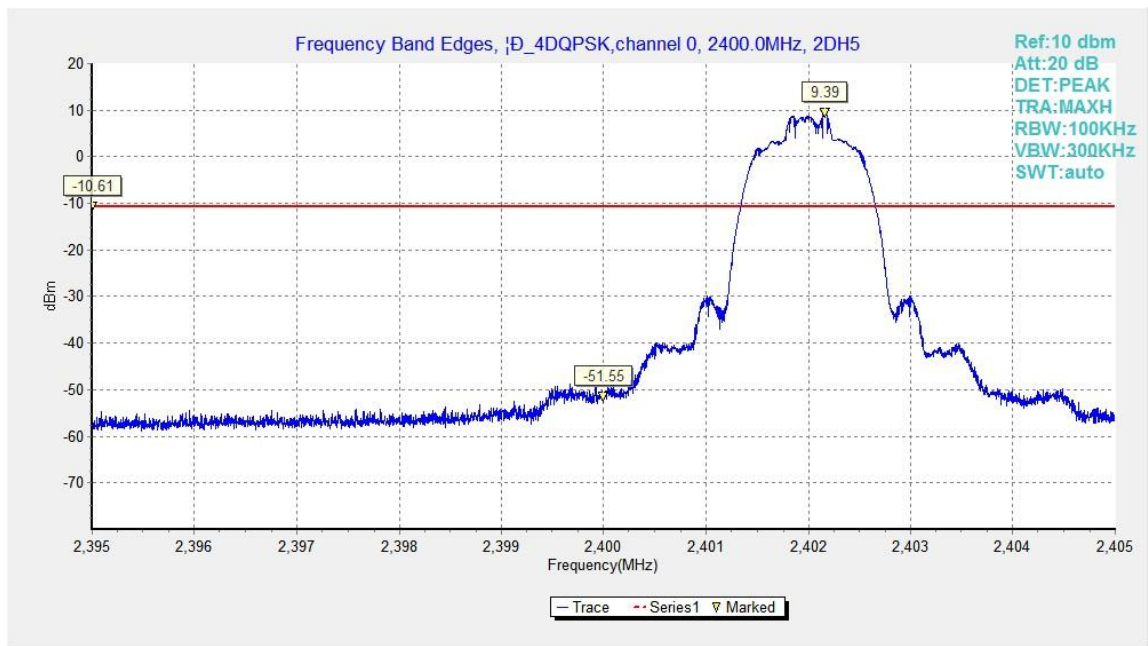

Fig.5. Frequency Band Edges: $\pi/4$ DQPSK, Channel 0, Hopping Off

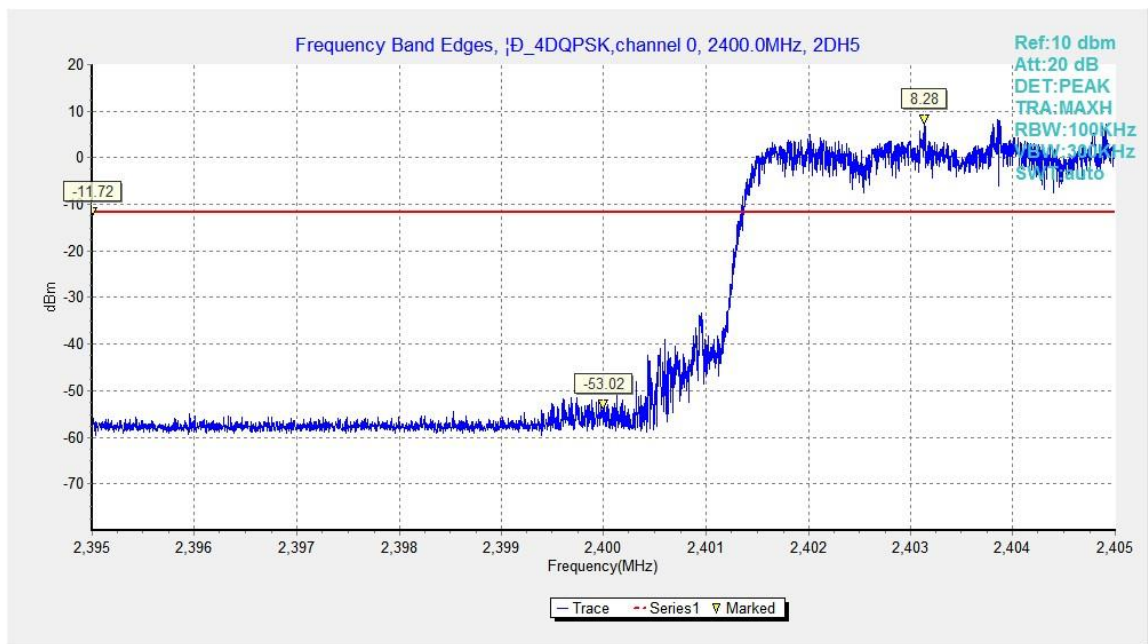

Fig.6. Frequency Band Edges: $\pi/4$ DQPSK, Channel 0, Hopping On

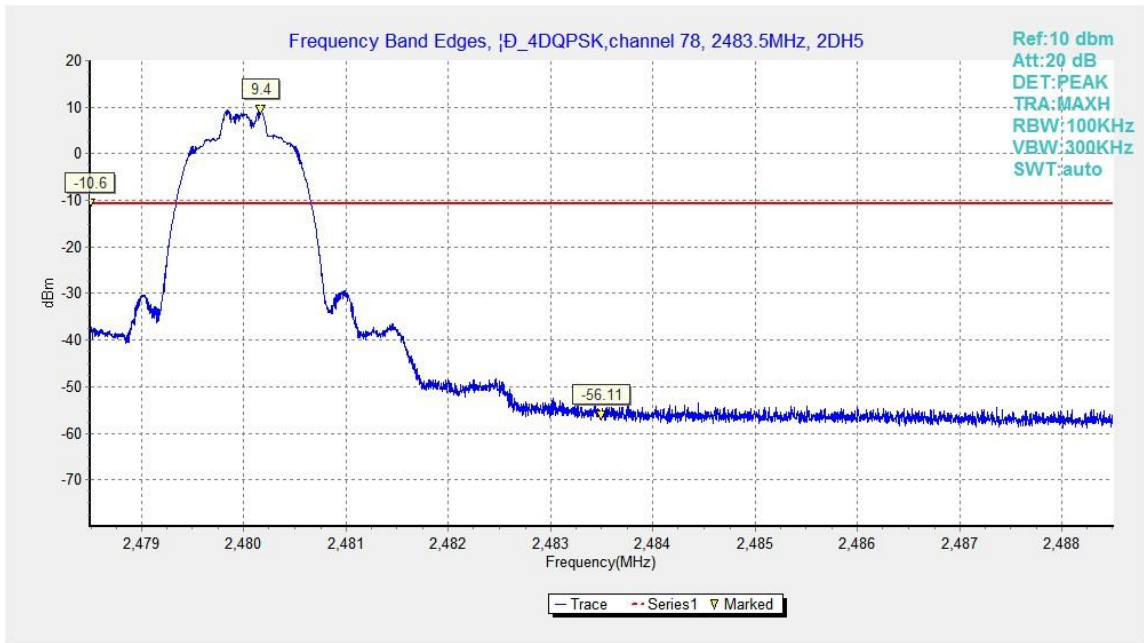

Fig.7. Frequency Band Edges: $\pi/4$ DQPSK, Channel 78, Hopping Off

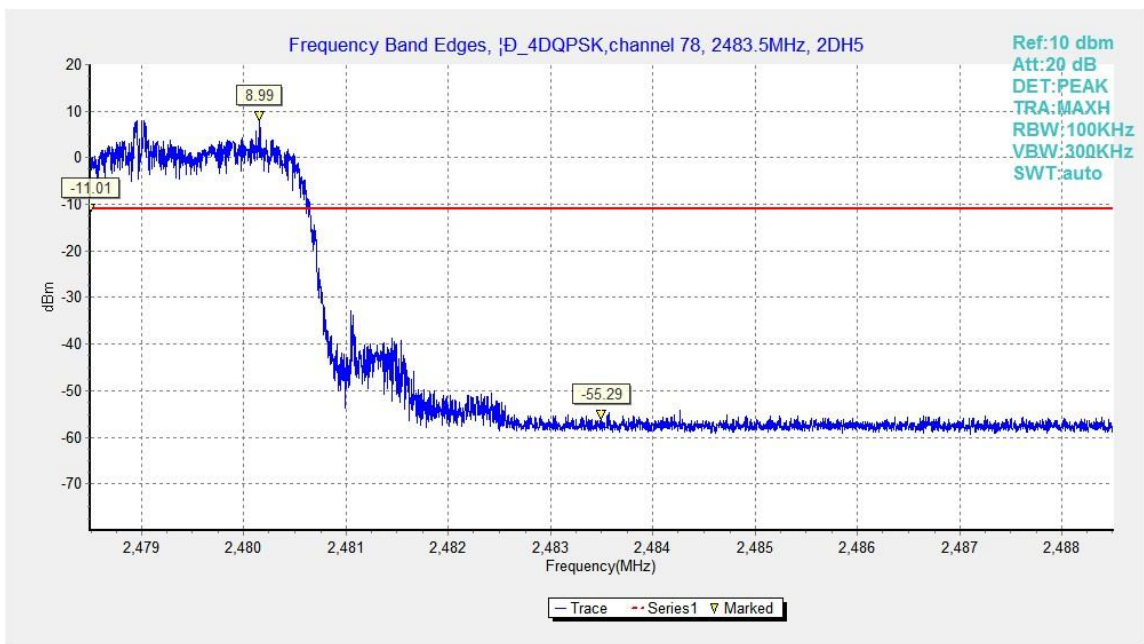

Fig.8. Frequency Band Edges: $\pi/4$ DQPSK, Channel 78, Hopping On

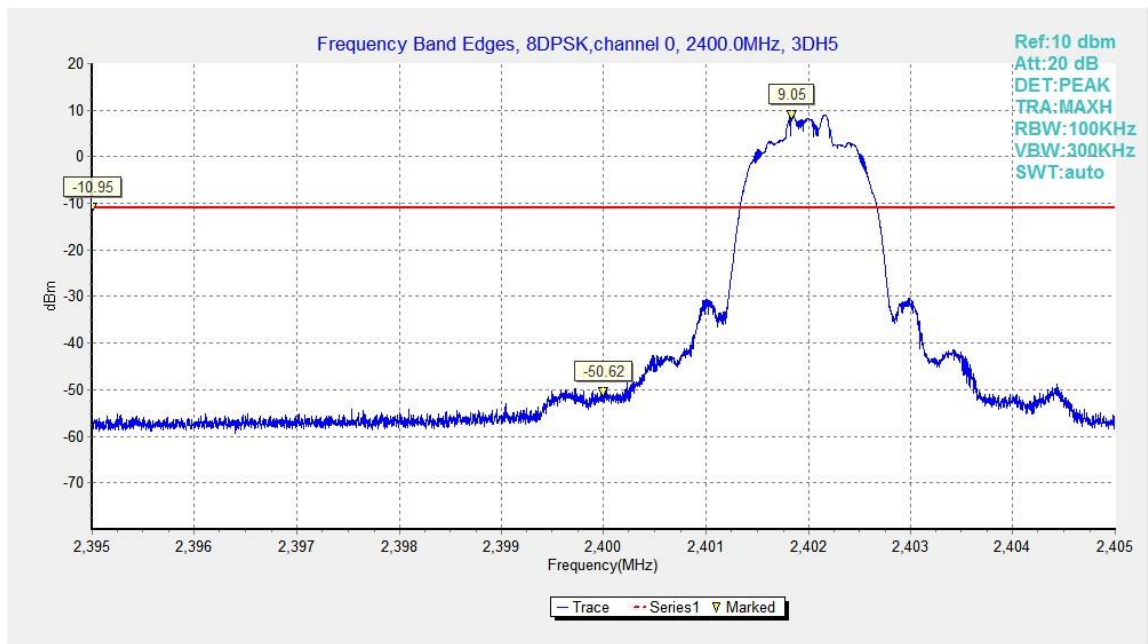

Fig.9. Frequency Band Edges: 8DPSK, Channel 0, Hopping Off

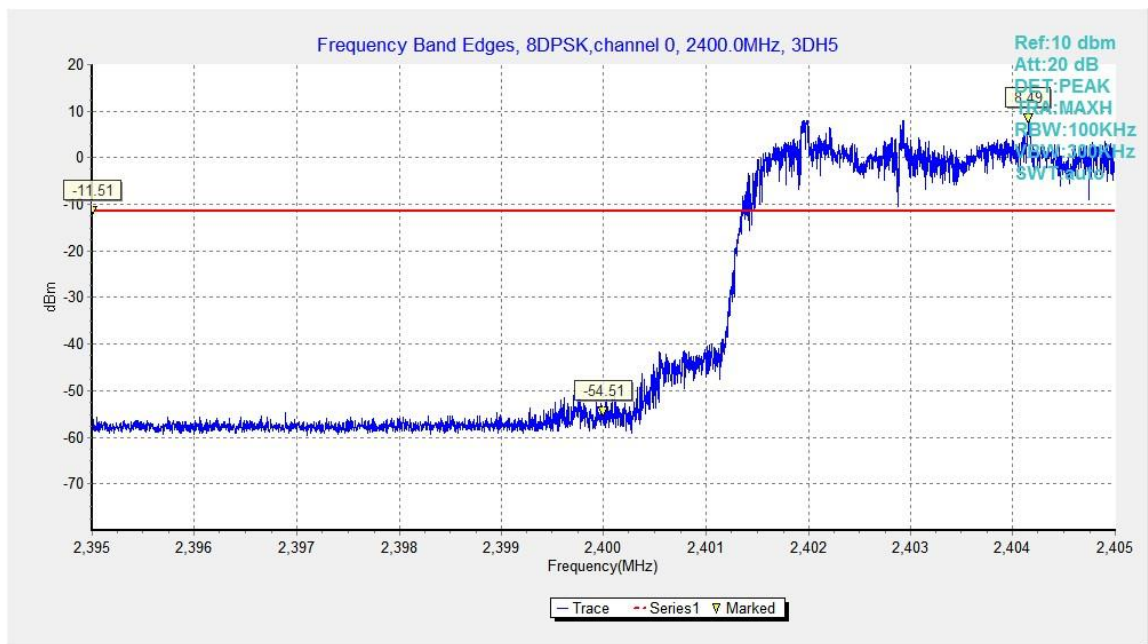

Fig.10. Frequency Band Edges: 8DPSK, Channel 0, Hopping On

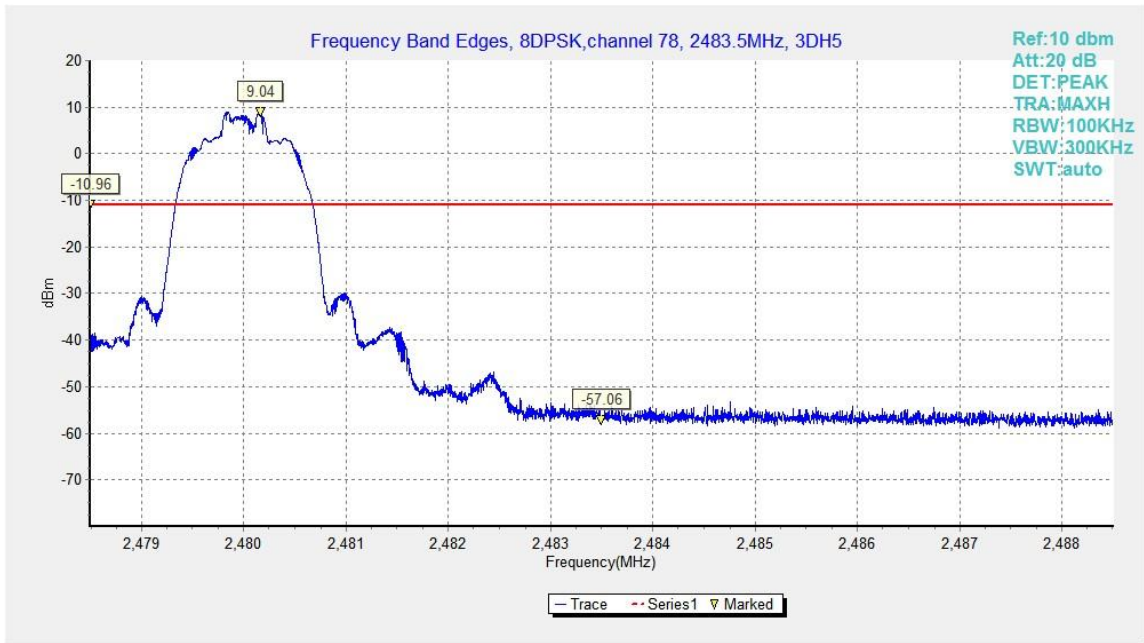

Fig.11. Frequency Band Edges: 8DPSK, Channel 78, Hopping Off

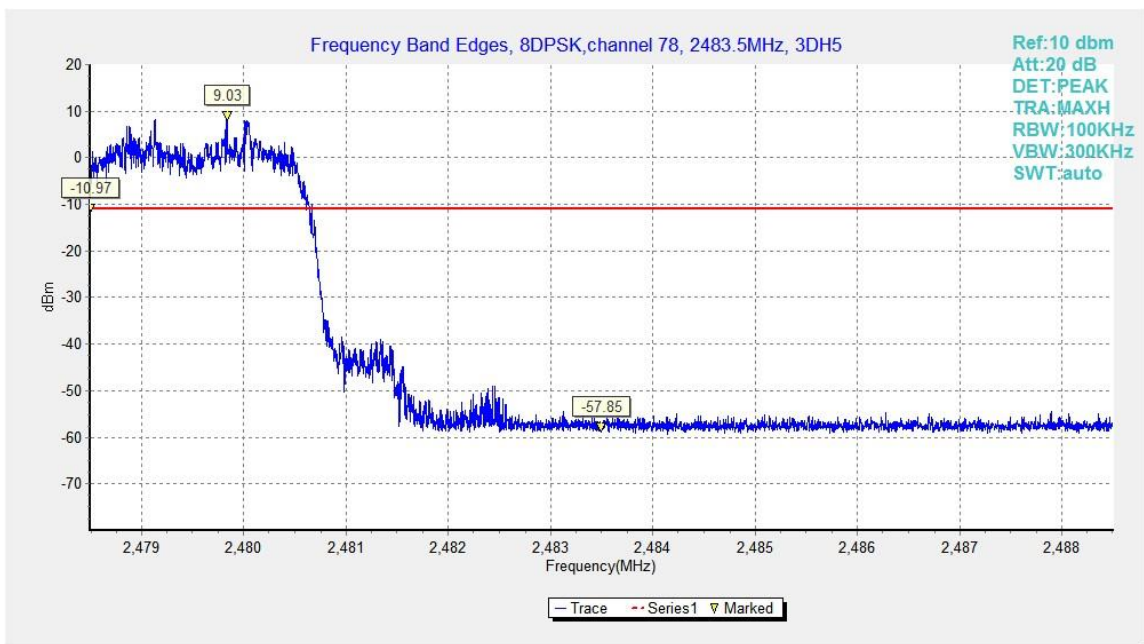

Fig.12. Frequency Band Edges: 8DPSK, Channel 78, Hopping On

B.4. Frequency Band Edges –Radiated

Method of Measurement: See ANSI C63.10-2013-clause 6.4 &6.5 & 6.6

Measurement Limit:

| Standard | Limit |
|--|------------------------------|
| FCC 47 CFR Part 15.247, 15.205, 15.209 | 20dB below peak output power |

radiated emissions which fall in the restricted bands, as defined in § 15.205(a), must also comply with the radiated emission limits specified in § 15.209(a) (see § 15.205(c)).

Limit in restricted band:

| Frequency (MHz) | Field strength(μ V/m) | Measurement distance (m) |
|-----------------|----------------------------|--------------------------|
| 0.009 - 0.490 | 2400/F(kHz) | 300 |
| 0.490 - 1.705 | 24000/F(kHz) | 30 |
| 1.705 – 30.0 | 30 | 30 |

| Frequency of emission (MHz) | Field strength(uV/m) | Field strength(dBuV/m) |
|-----------------------------|----------------------|------------------------|
| 30-88 | 100 | 40 |
| 88-216 | 150 | 43.5 |
| 216-960 | 200 | 46 |
| Above 960 | 500 | 54 |

Set up:

Tabletop devices shall be placed on a nonconducting platform with nominal top surface dimensions 1 m by 1.5 m and the table height shall be 1.5 m.

The EUT and transmitting antenna shall be centered on the turntable.

Test Condition

The EUT shall be tested 1 near top, 1 near middle, and 1 near bottom. Set the unlicensed wireless device to operate in continuous transmit mode. For unlicensed wireless devices unable to be configured for 100% duty cycle even in test mode, configure the system for the maximum duty cycle supported.

When required for unlicensed wireless devices, measurements of the variation of the input power or the radiated signal level of the fundamental frequency component of the emission, as appropriate, shall be performed with the supply voltage varied between 85% and 115% of the nominal rated supply voltage.

Exploratory radiated emissions measurements

Exploratory radiated measurements shall be performed at the measurement distance or at a closer distance than that specified for compliance to determine the emission characteristics of the EUT and, if applicable, the EUT configuration that produces the maximum level of emissions. The frequencies of maximum emission may be determined by manually positioning the antenna close

to the EUT, and then moving the antenna over all sides of the EUT while observing a spectral display. It is advantageous to have prior knowledge of the frequencies of emissions, although this may be determined from such a near-field scan. The near-field scan shall only be used to determine the frequency but not the amplitude of the emissions. Where exploratory measurements are not adequate to determine the worst-case operating modes and are used only to identify the frequencies of the highest emissions, additional preliminary tests can be required.

For emissions from the EUT, the maximum level shall be determined by rotating the EUT and its antenna through 0° to 360°. For each mode of operation required to be tested, the frequency spectrum (based on findings from exploratory measurements) shall be monitored.

Broadband antennas and a spectrum analyzer or a radio-noise meter with a panoramic display are often useful in this type of test. If either antenna height or EUT azimuth are not fully measured during exploratory testing, then complete testing can be required at the OATS or semi-anechoic chamber when the final full spectrum testing is performed.

Final radiated emissions measurements

The final measurements are using the orientation and equipment arrangement of the EUT based on the measurement results found during the preliminary (exploratory) measurements, the EUT arrangement, appropriate modulation, and modes of operation that produce the emissions that have the highest amplitude relative to the limit shall be selected for the final measurement.

For emissions from the EUT, the maximum level shall be determined by rotating the EUT and its antenna through 0° to 360°. Final measurements for the EUT require a measurement antenna height scan of 1 m to 4 m and the antenna rotated to repeat the measurements for both the horizontal and vertical antenna polarizations. For each mode of operation required to be tested, the frequency spectrum (based on findings from exploratory measurements) shall be monitored.

For each mode selected, record the frequency and amplitude of the highest fundamental emission (if applicable), as well as the frequency and amplitude of the six highest spurious emissions relative to the limit. Emissions more than 20 dB below the limit do not need to be reported.

This maximization process was repeated with the EUT positioned in each of its three orthogonal orientations.

The receiver references:

| Frequency of emission (MHz) | RBW/VBW | Sweep Time(s) |
|-----------------------------|---------------|---------------|
| 30-1000 | 100KHz/300KHz | 5 |
| 1000-4000 | 1MHz/3MHz | 15 |
| 4000-18000 | 1MHz/3MHz | 40 |
| 18000-26500 | 1MHz/3MHz | 20 |

EUT ID:UT51a

Measurement Results:

| Mode | Channel | Frequency Range | Test Results | Conclusion |
|------|---------|------------------|--------------|------------|
| GFSK | 0 | 2.38GHz ~2.45GHz | Fig.13 | P |
| | 78 | 2.45GHz ~2.5GHz | Fig.14 | P |

| Mode | Channel | Frequency Range | Test Results | Conclusion |
|---------------|---------|------------------|--------------|------------|
| $\pi/4$ DQPSK | 0 | 2.38GHz ~2.43GHz | Fig.15 | P |
| | 78 | 2.45GHz ~2.5GHz | Fig.16 | P |

| Mode | Channel | Frequency Range | Test Results | Conclusion |
|-------|---------|------------------|--------------|------------|
| 8DPSK | 0 | 2.38GHz ~2.45GHz | Fig.17 | P |
| | 78 | 2.45GHz ~2.5GHz | Fig.18 | P |

Conclusion: PASS

Test graphs as below

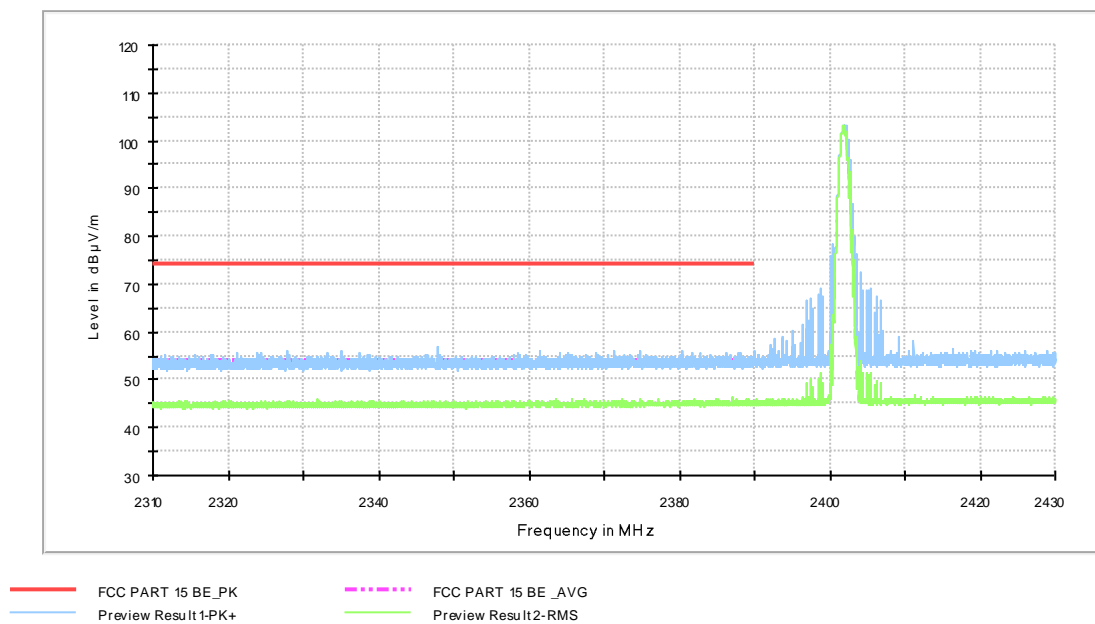
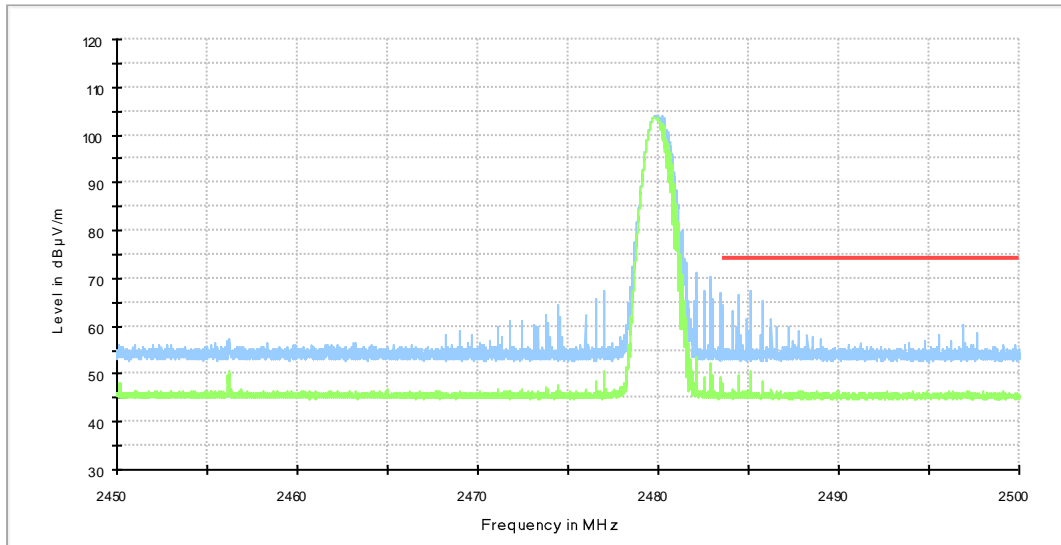
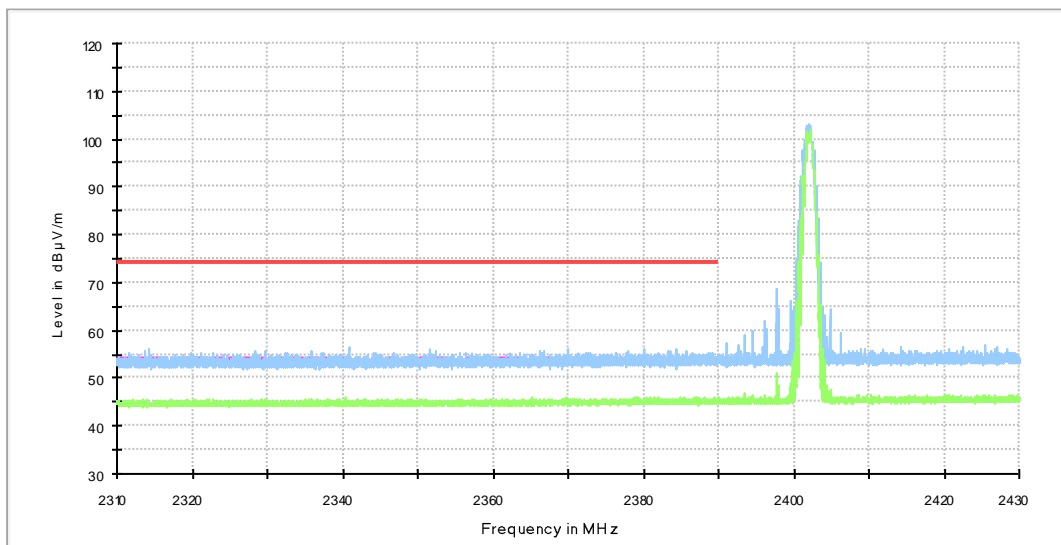

Fig.13. Frequency Band Edges: GFSK, Channel 0, Hopping Off, 2.38 GHz – 2.45GHz



— FCC PART 15 BE_PK
— Preview Result1-PK+
- - - FCC PART 15 BE_AVG
— Preview Result2-RMS

Fig.14. Frequency Band Edges: GFSK, Channel 78, Hopping Off, ch11, 2.45 GHz - 2.50GHz



— FCC PART 15 BE_PK
— Preview Result1-PK+
- - - FCC PART 15 BE_AVG
— Preview Result2-RMS

Fig.15. Frequency Band Edges: $\pi/4$ DQPSK, Channel 0, Hopping Off, 2.38 GHz - 2.45GHz

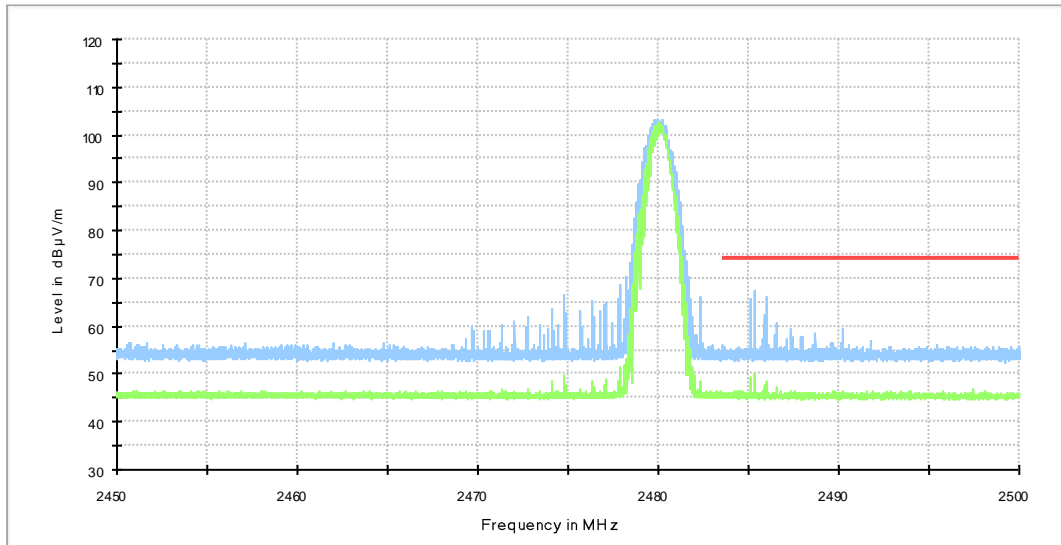

— FCC PART 15 BE_PK
— Preview Result1-PK+
- - - FCC PART 15 BE_AVG
— Preview Result2-RMS

Fig.16. Frequency Band Edges: $\pi/4$ DQPSK, Channel 78, Hopping Off, 2.38 GHz - 2.45GHz

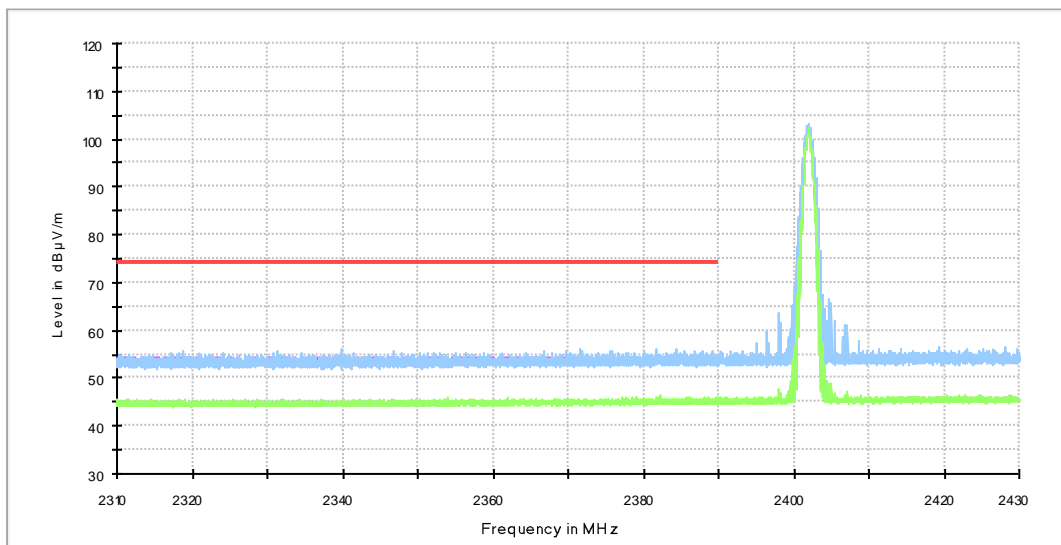

— FCC PART 15 BE_PK
— Preview Result1-PK+
- - - FCC PART 15 BE_AVG
— Preview Result2-RMS

Fig.17. Frequency Band Edges: 8DPSK, Channel 0, 2.38 GHz - 2.45GHz

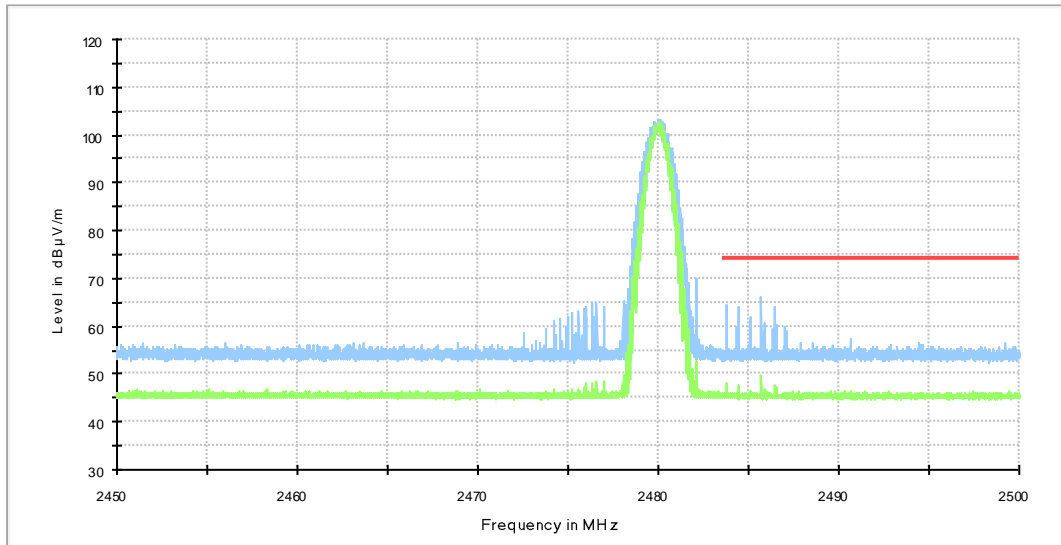

— FCC PART 15 BE_PK
— Preview Result1-PK+
- - - - - FCC PART 15 BE_AVG
— Preview Result2-RMS

Fig.18. Frequency Band Edges: 8DPSK, Channel 78, 2.38 GHz - 2.45GHz

B.5. Transmitter Spurious Emission - Conducted

Method of Measurement: See ANSI C63.10-clause 7.8.8

Measurement Procedure – Reference Level

1. Set the RBW = 100 kHz.
2. Set the VBW = 300 kHz.
3. Set the span to 5-30 % greater than the EBW.
4. Detector = peak.
5. Sweep time = auto couple.
6. Trace mode = max hold.
7. Allow trace to fully stabilize.
8. Use the peak marker function to determine the maximum power level in any 100 kHz band segment within the fundamental EBW. Next, determine the power in 100 kHz band segments outside of the authorized frequency band using the following measurement:

Measurement Procedure - Unwanted Emissions

1. Set RBW = 100 kHz.
2. Set VBW = 300 kHz.
3. Set span to encompass the spectrum to be examined.
4. Detector = peak.
5. Trace Mode = max hold.
6. Sweep = auto couple.
7. Allow the trace to stabilize (this may take some time, depending on the extent of the span).

Ensure that the amplitude of all unwanted emissions outside of the authorized frequency band (excluding restricted frequency bands) is attenuated by at least the minimum requirements specified above.

Measurement Limit:

| Standard | Limit |
|----------------------------|---|
| FCC 47 CFR Part 15.247 (d) | 20dB below peak output power in 100 kHz bandwidth |

Measurement Results:

For GFSK

| Channel | Frequency Range | Test Results | Conclusion |
|---------|------------------|--------------|------------|
| Ch 0 | Center Frequency | Fig.19 | P |

| | | | |
|-------------------|------------------|--------|---|
| 2402 MHz | 30 MHz ~ 1 GHz | Fig.20 | P |
| | 1 GHz ~ 3 GHz | Fig.21 | P |
| | 3 GHz ~ 10 GHz | Fig.22 | P |
| | 10 GHz ~ 26 GHz | Fig.23 | P |
| Ch 39 2441 MHz | Center Frequency | Fig.24 | P |
| | 30 MHz ~ 1 GHz | Fig.25 | P |
| | 1 GHz ~ 3 GHz | Fig.26 | P |
| | 3 GHz ~ 10 GHz | Fig.27 | P |
| | 10 GHz ~ 26 GHz | Fig.28 | P |
| Ch 78 2480 MHz | Center Frequency | Fig.29 | P |
| | 30 MHz ~ 1 GHz | Fig.30 | P |
| | 1 GHz ~ 3 GHz | Fig.31 | P |
| | 3 GHz ~ 10 GHz | Fig.32 | P |
| | 10 GHz ~ 26 GHz | Fig.33 | P |

For $\pi/4$ DQPSK

| Channel | Frequency Range | Test Results | Conclusion |
|-------------------|------------------|--------------|------------|
| Ch 0 2402 MHz | Center Frequency | Fig.34 | P |
| | 30 MHz ~ 1 GHz | Fig.35 | P |
| | 1 GHz ~ 3 GHz | Fig.36 | P |
| | 3 GHz ~ 10 GHz | Fig.37 | P |
| | 10 GHz ~ 26 GHz | Fig.38 | P |
| Ch 39 2441 MHz | Center Frequency | Fig.39 | P |
| | 30 MHz ~ 1 GHz | Fig.40 | P |
| | 1 GHz ~ 3 GHz | Fig.41 | P |
| | 3 GHz ~ 10 GHz | Fig.42 | P |
| | 10 GHz ~ 26 GHz | Fig.43 | P |
| Ch 78 2480 MHz | Center Frequency | Fig.44 | P |
| | 30 MHz ~ 1 GHz | Fig.45 | P |
| | 1 GHz ~ 3 GHz | Fig.46 | P |
| | 3 GHz ~ 10 GHz | Fig.47 | P |
| | 10 GHz ~ 26 GHz | Fig.48 | P |

For 8DPSK

| Channel | Frequency Range | Test Results | Conclusion |
|------------------|------------------|--------------|------------|
| Ch 0 2402 MHz | Center Frequency | Fig.49 | P |
| | 30 MHz ~ 1 GHz | Fig.50 | P |
| | 1 GHz ~ 3 GHz | Fig.51 | P |
| | 3 GHz ~ 10 GHz | Fig.52 | P |
| | 10 GHz ~ 26 GHz | Fig.53 | P |

| | | | |
|-------------------|------------------|--------|---|
| Ch 39 2441 MHz | Center Frequency | Fig.54 | P |
| | 30 MHz ~ 1 GHz | Fig.55 | P |
| | 1 GHz ~ 3 GHz | Fig.56 | P |
| | 3 GHz ~ 10 GHz | Fig.57 | P |
| | 10 GHz ~ 26 GHz | Fig.58 | P |
| Ch 78 2480 MHz | Center Frequency | Fig.59 | P |
| | 30 MHz ~ 1 GHz | Fig.60 | P |
| | 1 GHz ~ 3 GHz | Fig.61 | P |
| | 3 GHz ~ 10 GHz | Fig.62 | P |
| | 10 GHz ~ 26 GHz | Fig.63 | P |

Conclusion: PASS

Test graphs as below

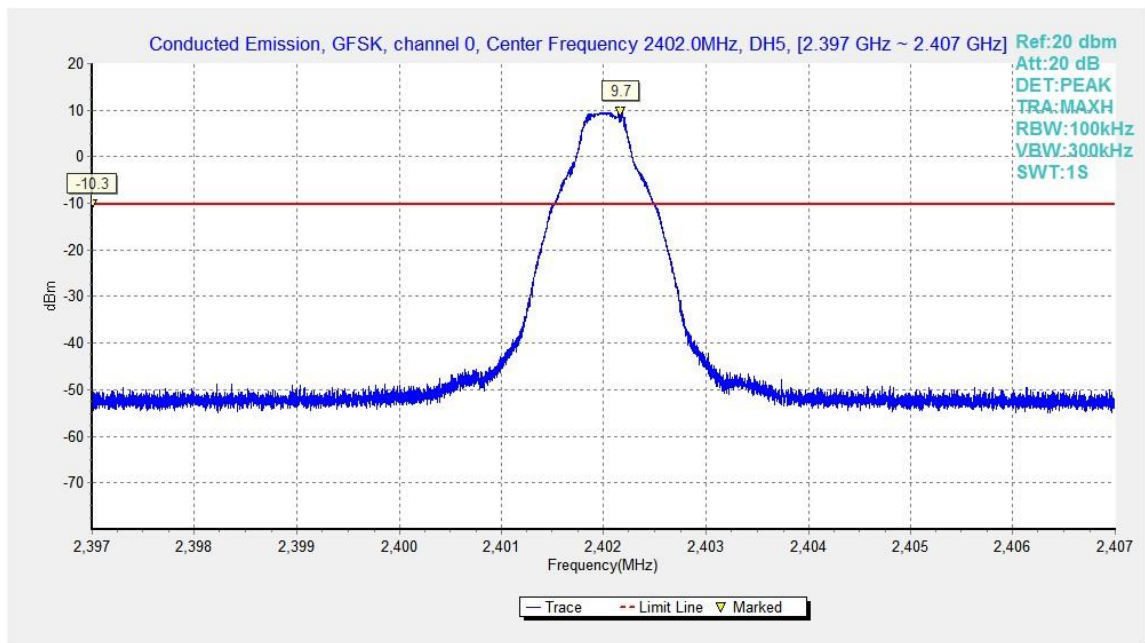

Fig.19. Conducted spurious emission: GFSK, Channel 0,2402MHz

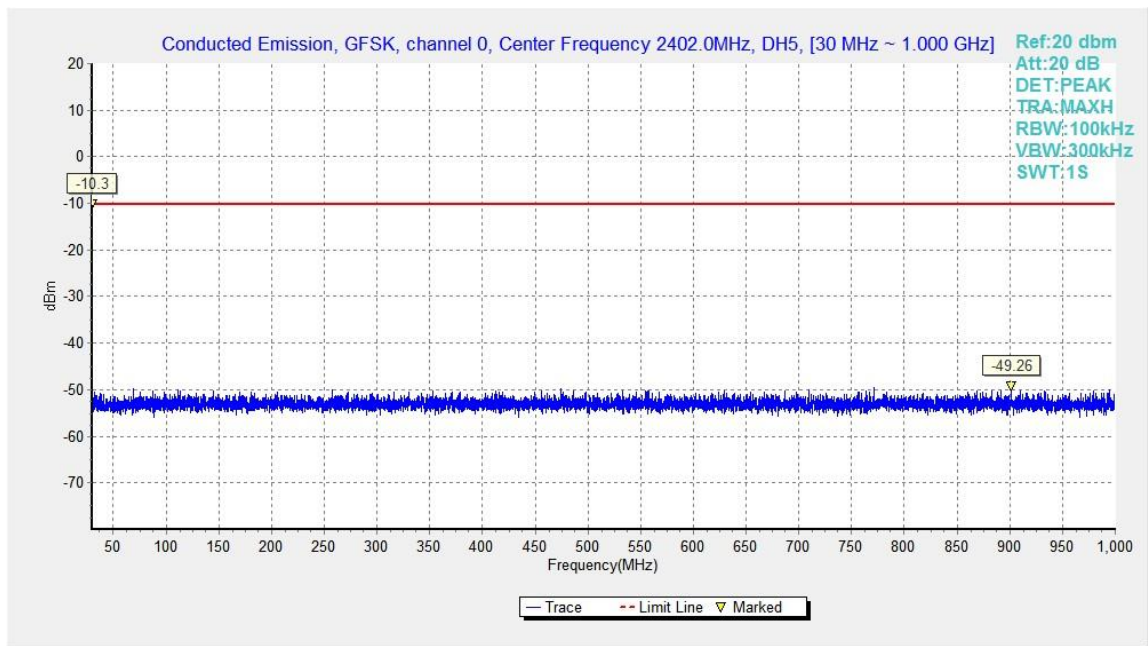

Fig.20. Conducted spurious emission: GFSK, Channel 0, 30MHz - 1GHz

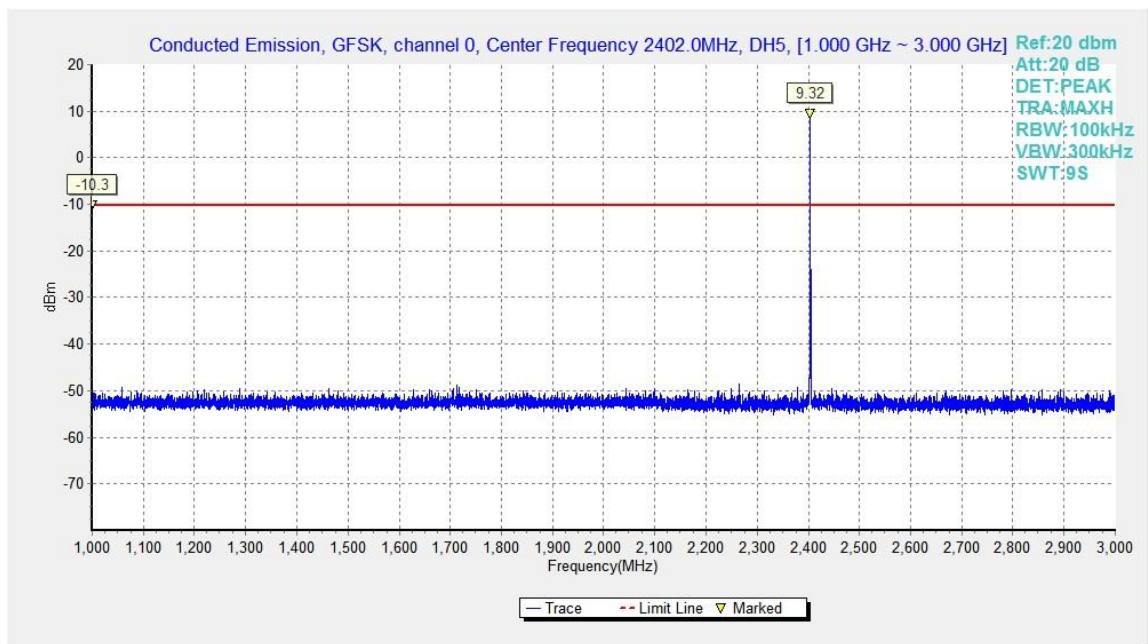

Fig.21. Conducted spurious emission: GFSK, Channel 0, 1GHz - 3GHz

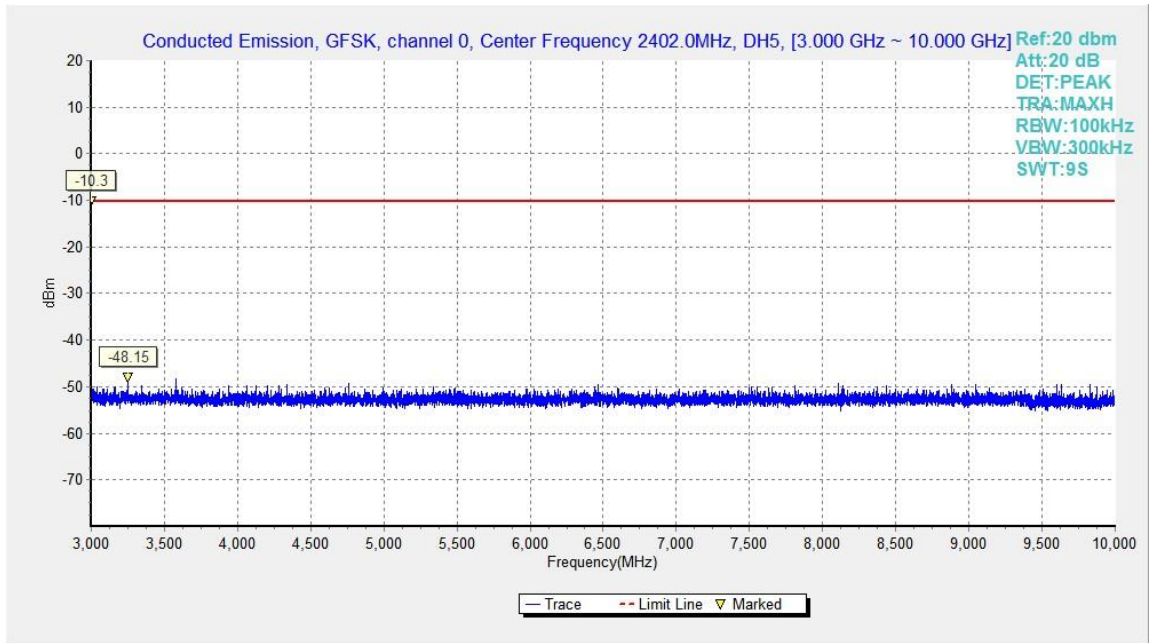

Fig.22. Conducted spurious emission: GFSK, Channel 0, 3GHz - 10GHz

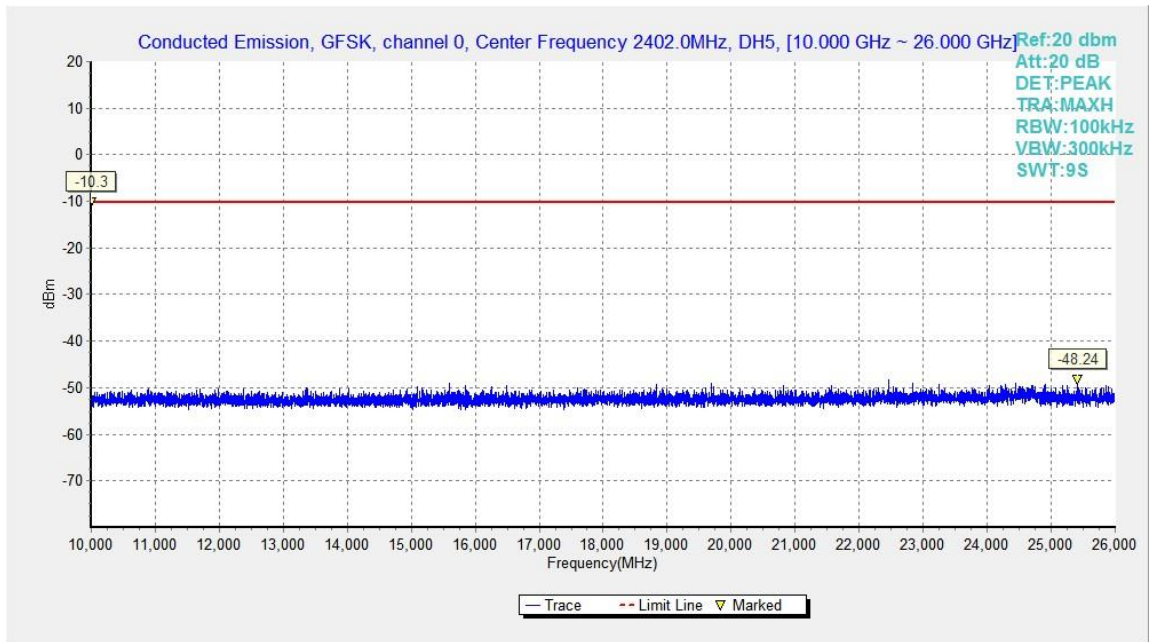

Fig.23. Conducted spurious emission: GFSK, Channel 0, 10GHz - 26GHz

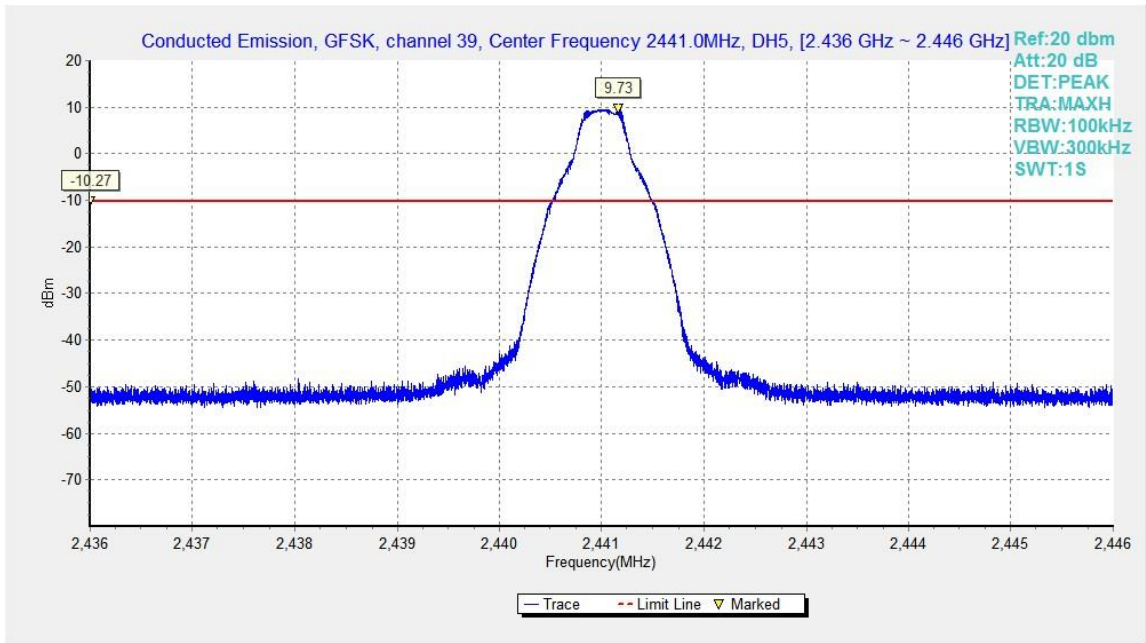

Fig.24. Conducted spurious emission: GFSK, Channel 39, 2441MHz

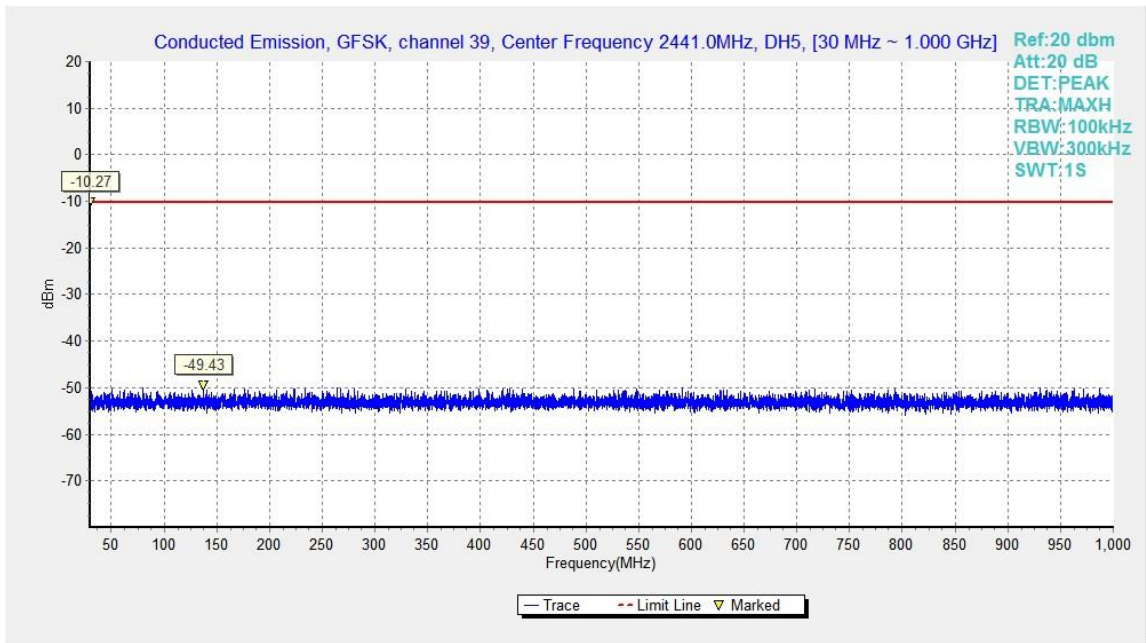

Fig.25. Conducted spurious emission: GFSK, Channel 39, 30MHz - 1GHz

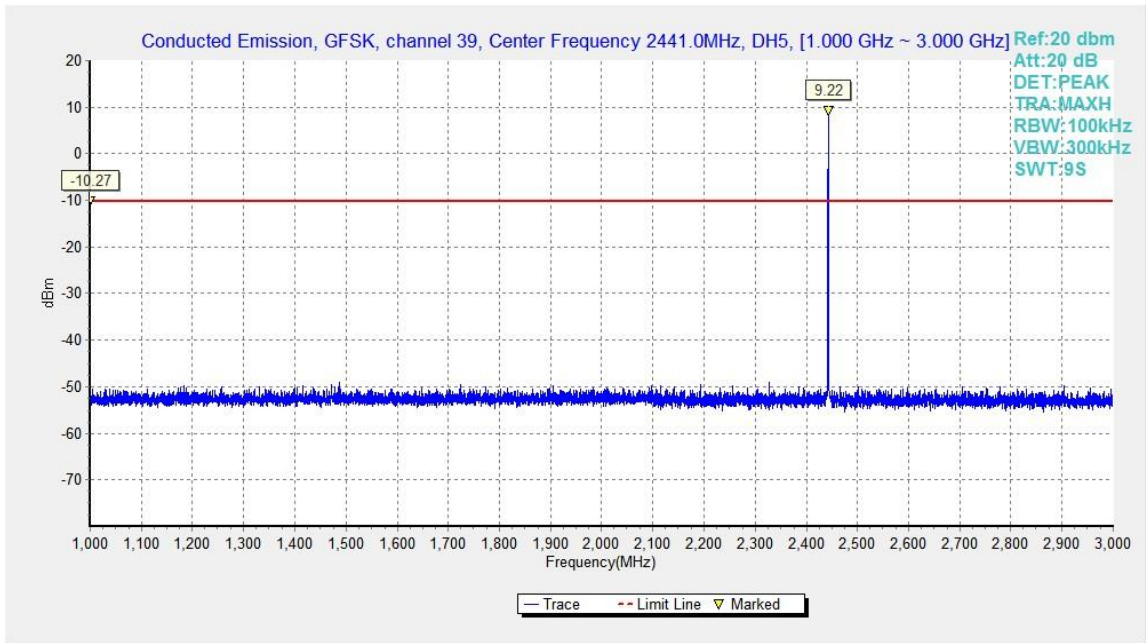

Fig.26. Conducted spurious emission: GFSK, Channel 39, 1GHz – 3GHz

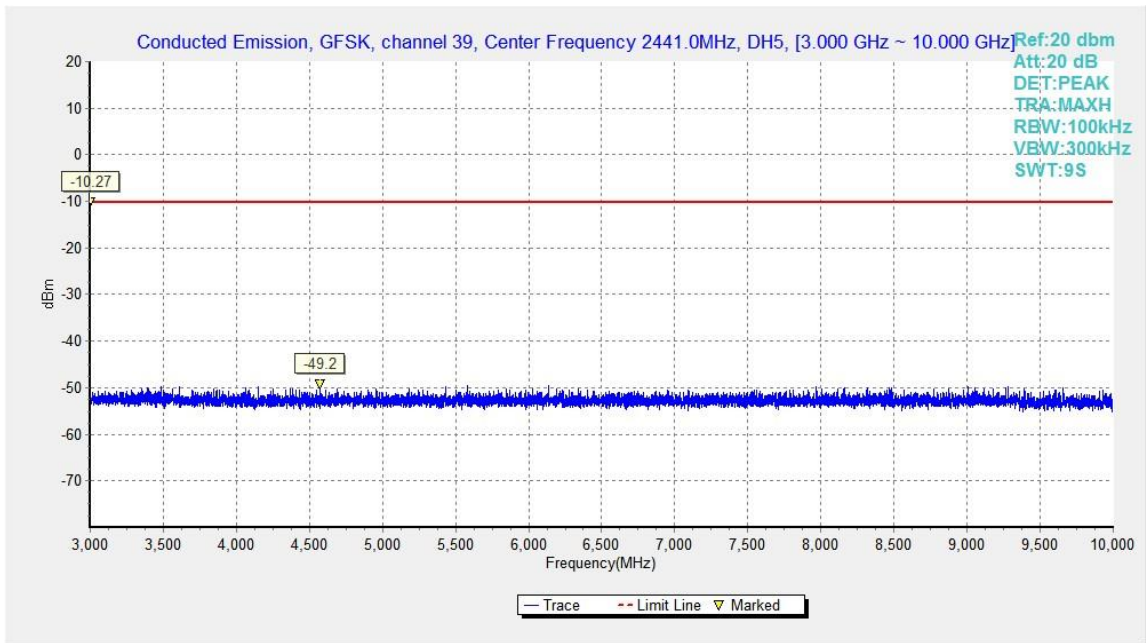

Fig.27. Conducted spurious emission: GFSK, Channel 39, 3GHz – 10GHz

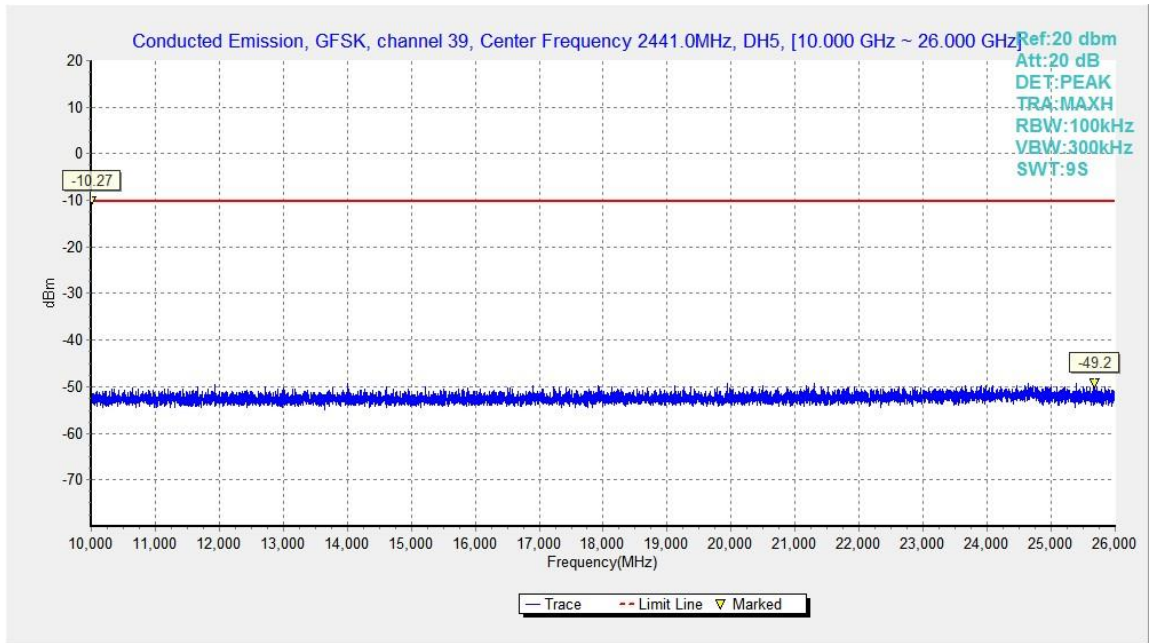

Fig.28. Conducted spurious emission: GFSK, Channel 39, 10GHz – 26GHz

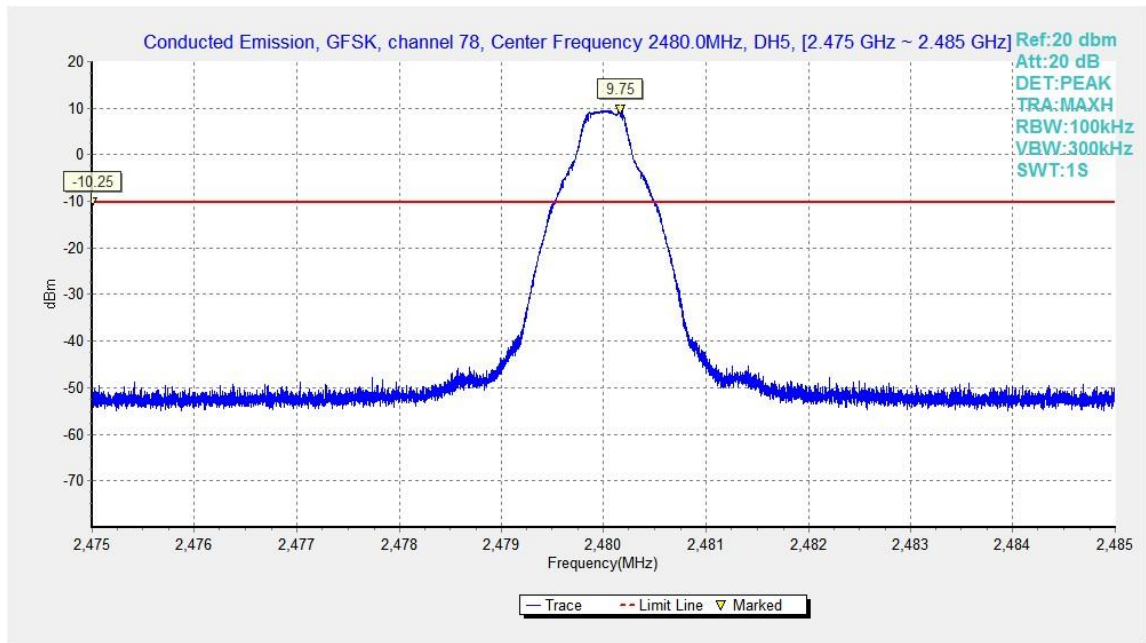

Fig.29. Conducted spurious emission: GFSK, Channel 78, 2480MHz

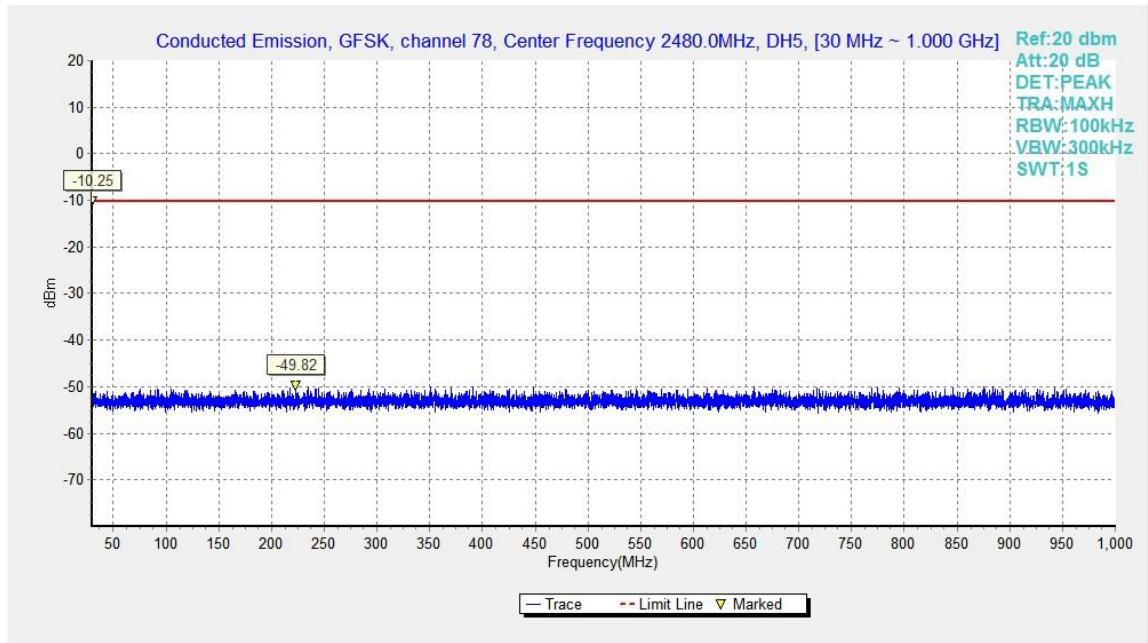

Fig.30. Conducted spurious emission: GFSK, Channel 78, 30MHz - 1GHz

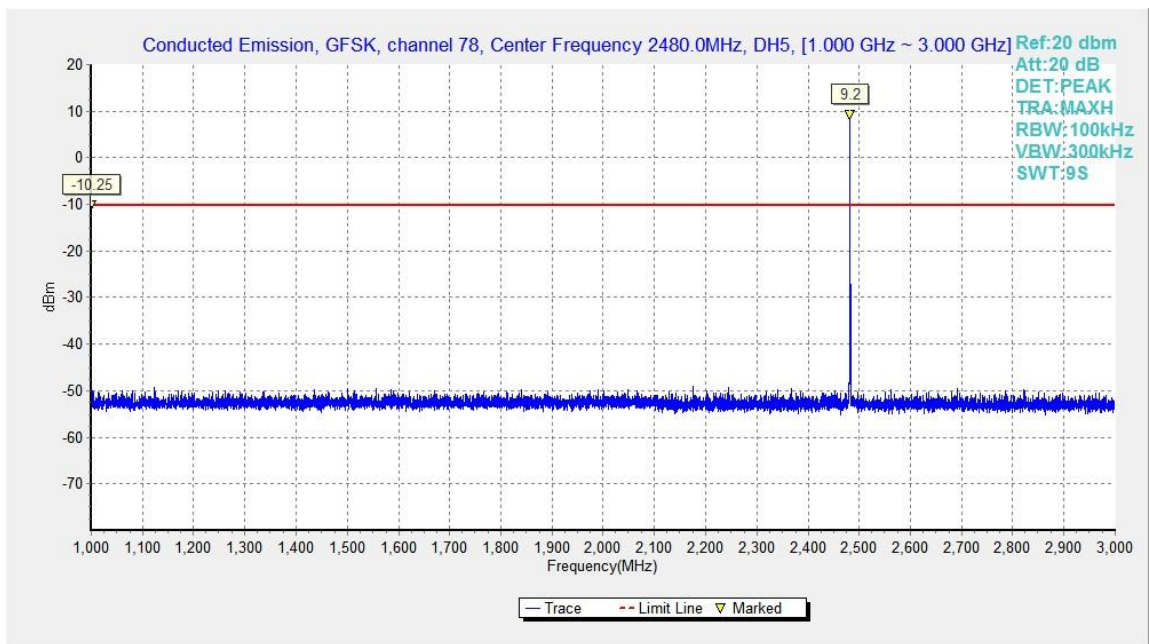

Fig.31. Conducted spurious emission: GFSK, Channel 78, 1GHz - 3GHz

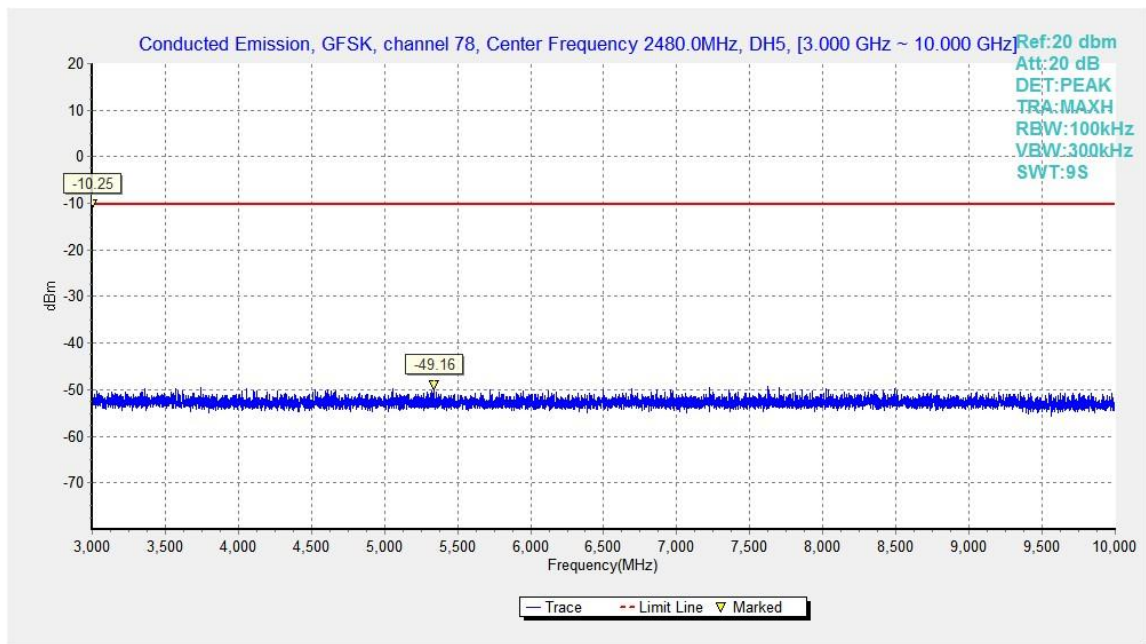

Fig.32. Conducted spurious emission: GFSK, Channel 78, 3GHz - 10GHz

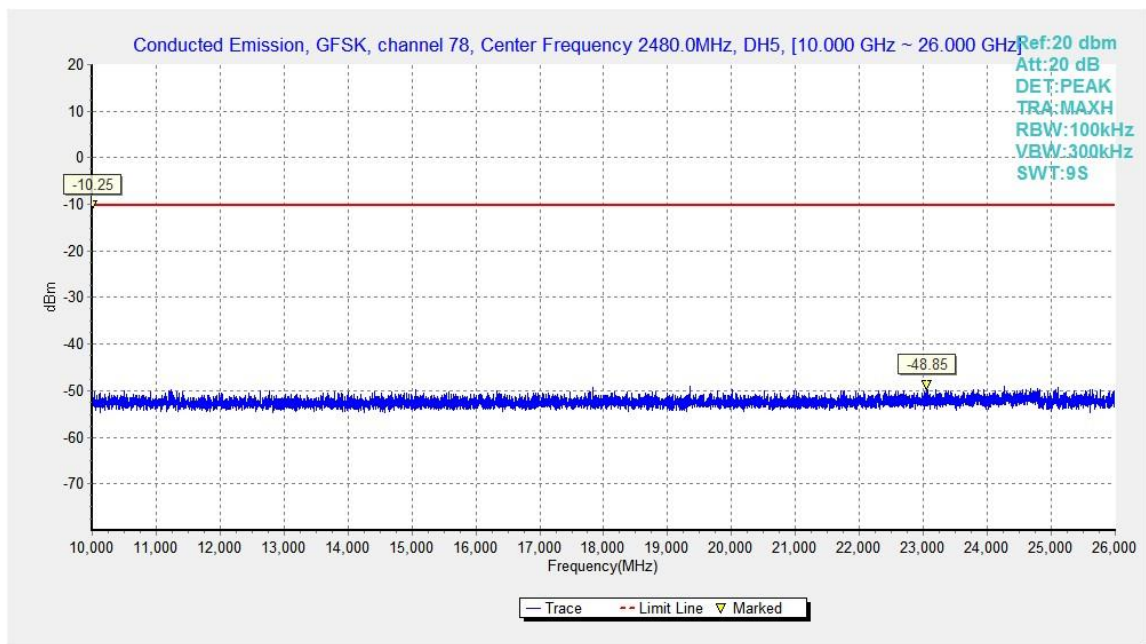

Fig.33. Conducted spurious emission: GFSK, Channel 78, 10GHz - 26GHz

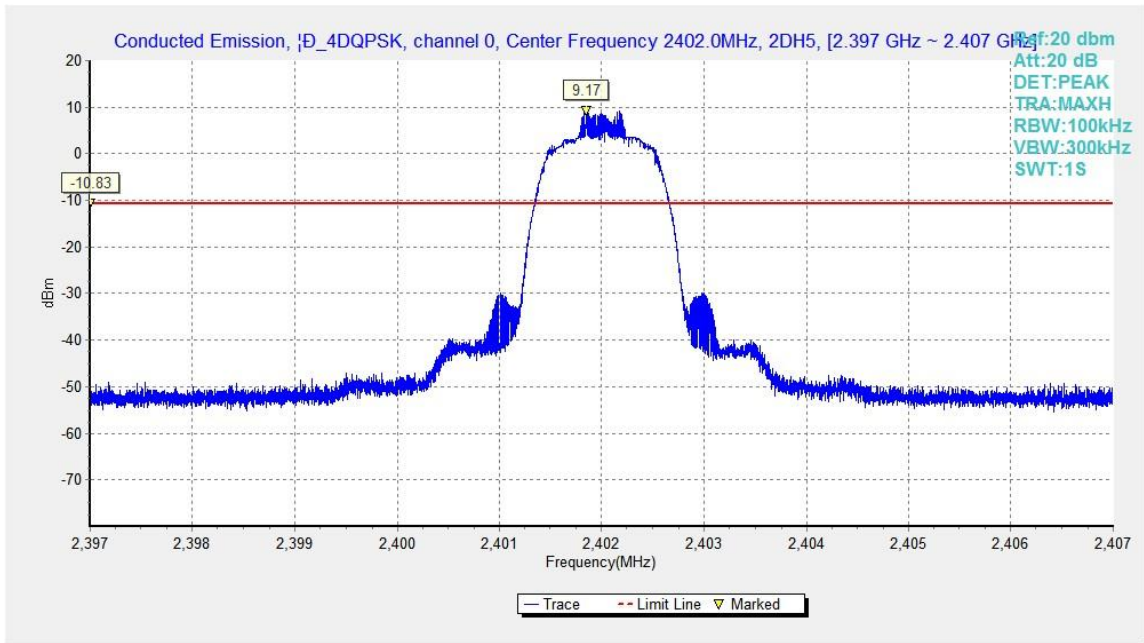

Fig.34. Conducted spurious emission: $\pi/4$ DQPSK, Channel 0, 2402MHz

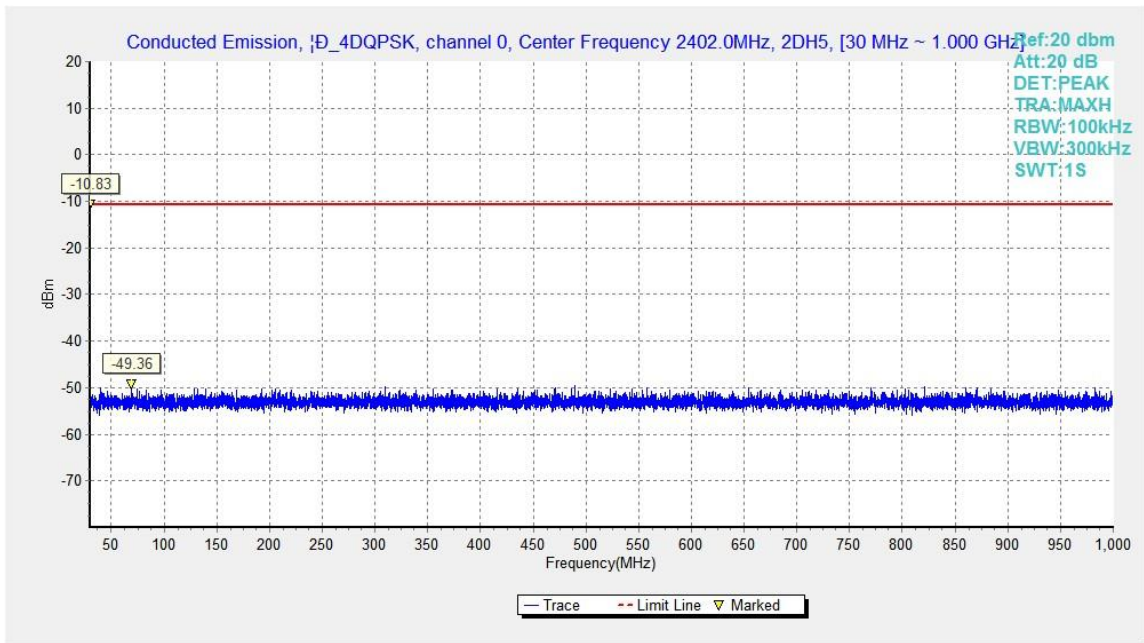

Fig.35. Conducted spurious emission: $\pi/4$ DQPSK, Channel 0, 30MHz - 1GHz

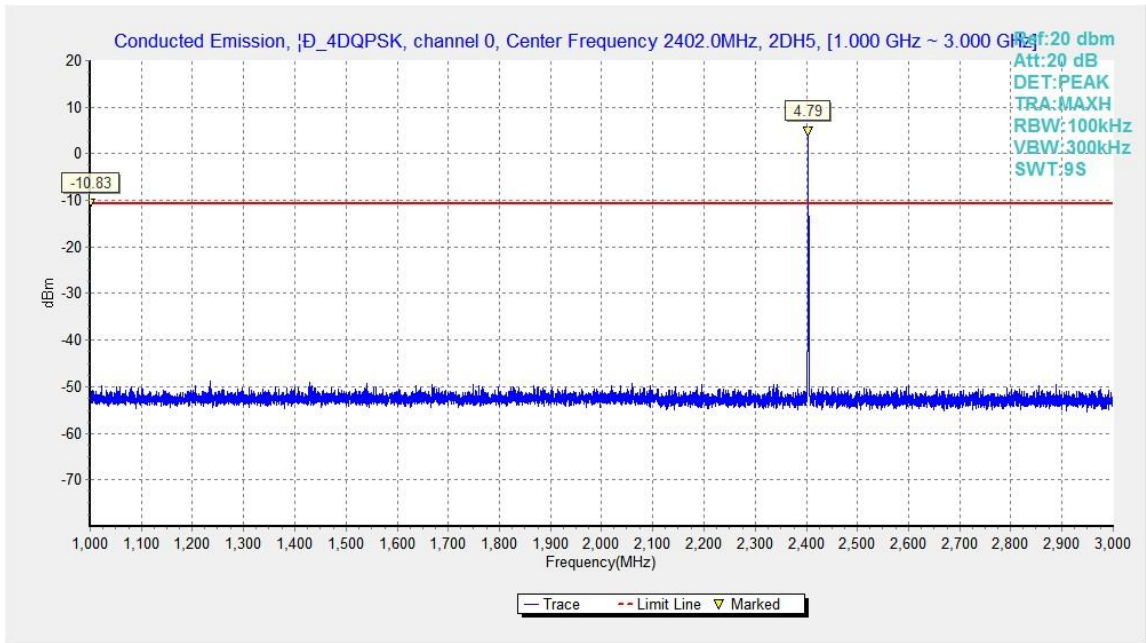

Fig.36. Conducted spurious emission: $\pi/4$ DQPSK, Channel 0, 1GHz - 3GHz

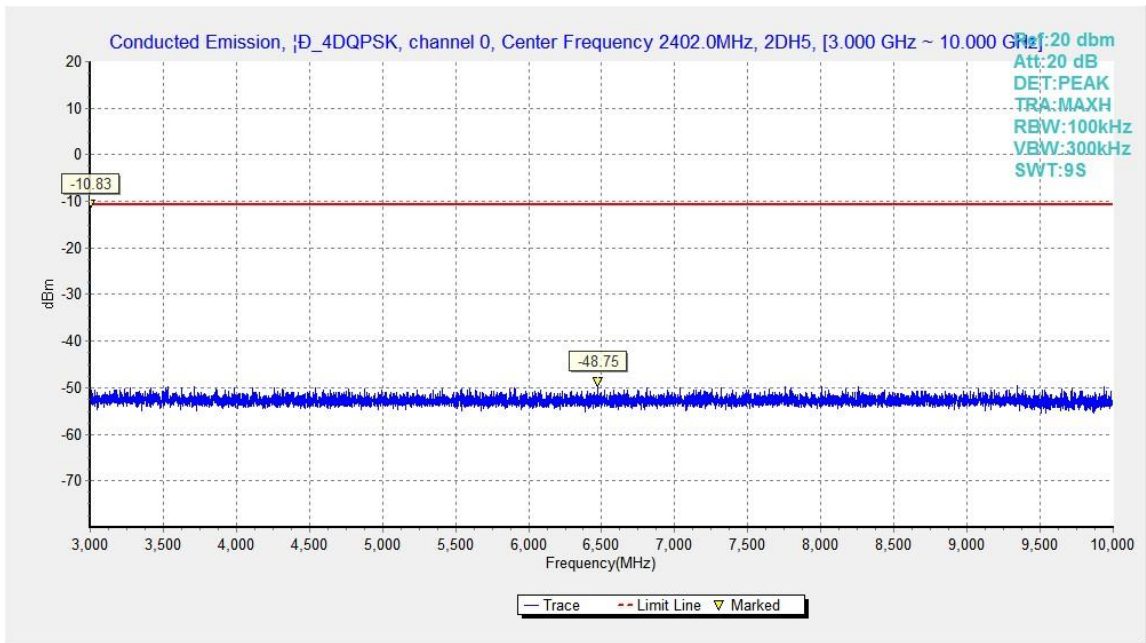

Fig.37. Conducted spurious emission: $\pi/4$ DQPSK, Channel 0, 3GHz - 10GHz

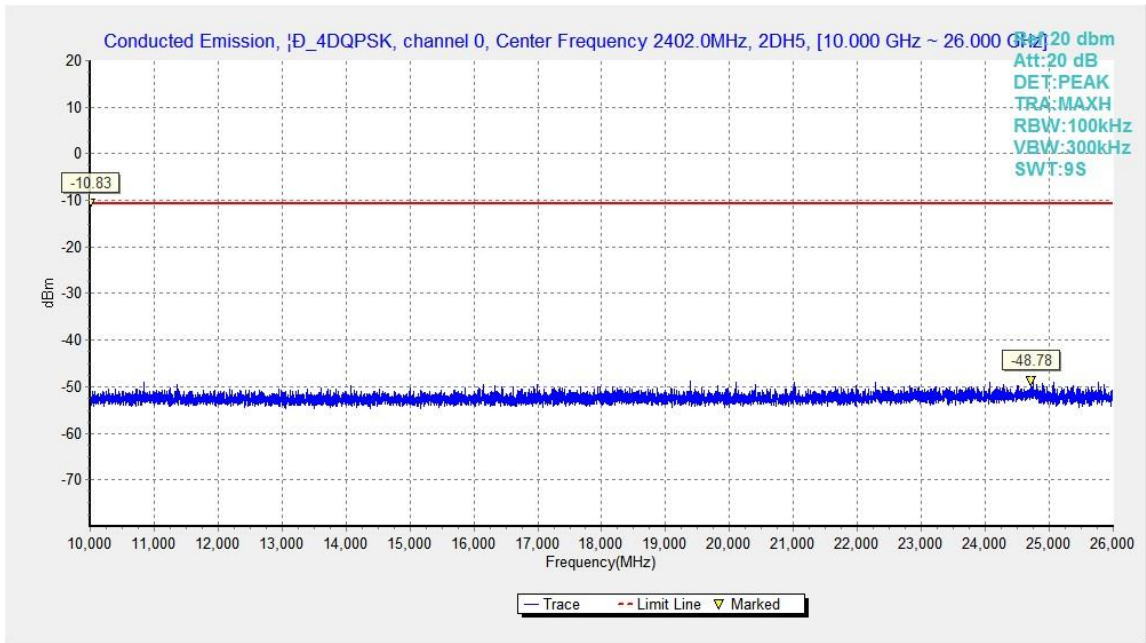

Fig.38. Conducted spurious emission: $\pi/4$ DQPSK, Channel 0, 10GHz - 26GHz

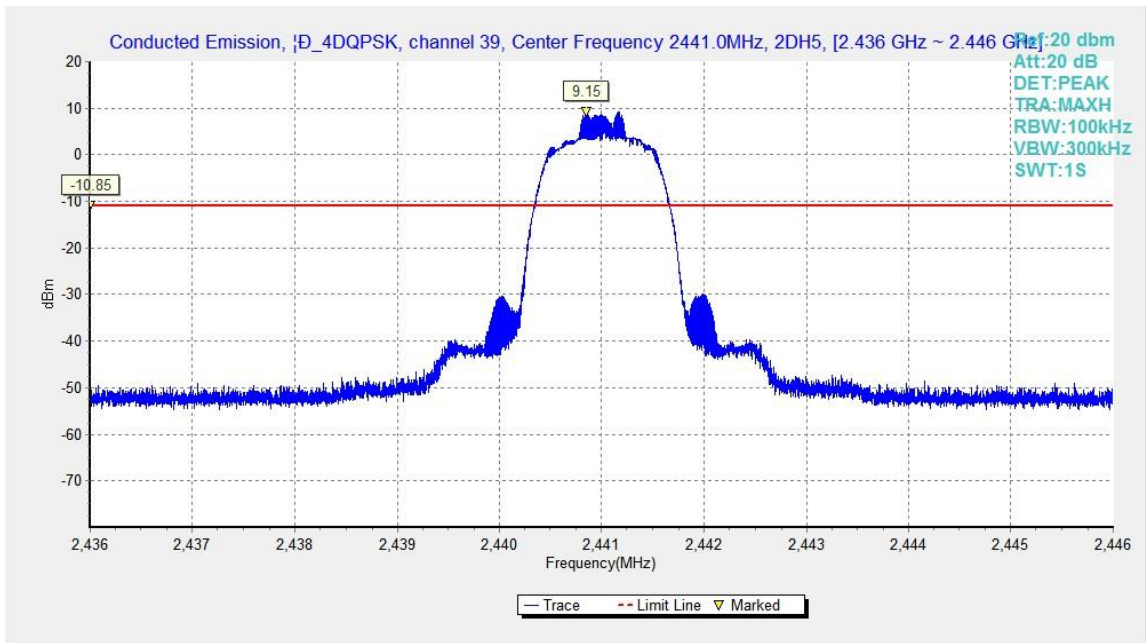

Fig.39. Conducted spurious emission: $\pi/4$ DQPSK, Channel 39, 2441MHz

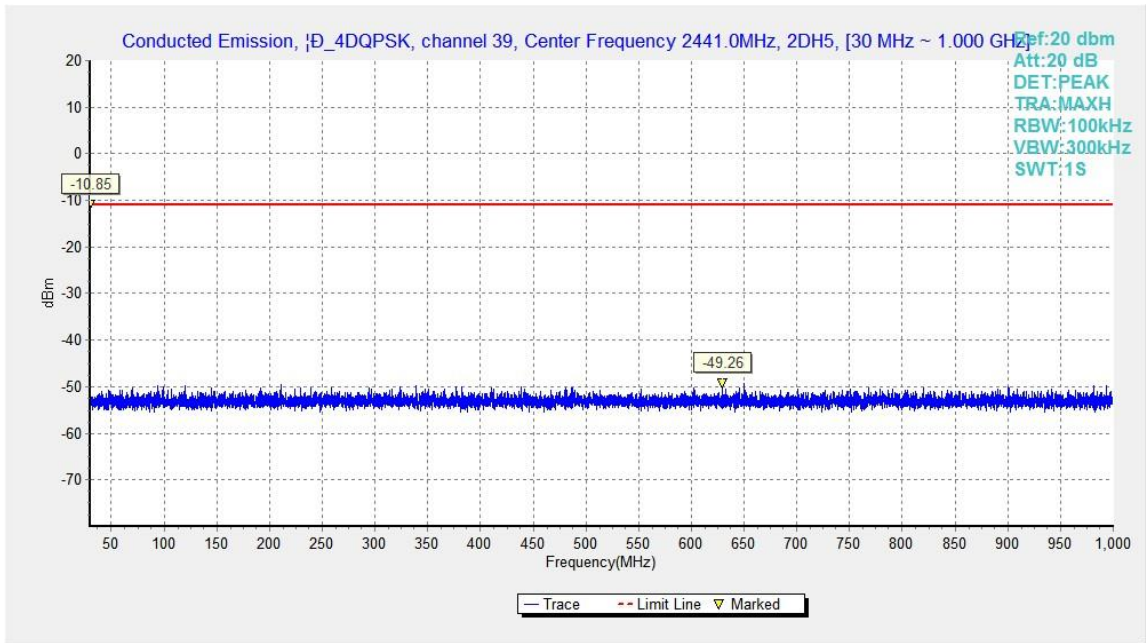

Fig.40. Conducted spurious emission: $\pi/4$ DQPSK, Channel 39, 30MHz - 1GHz

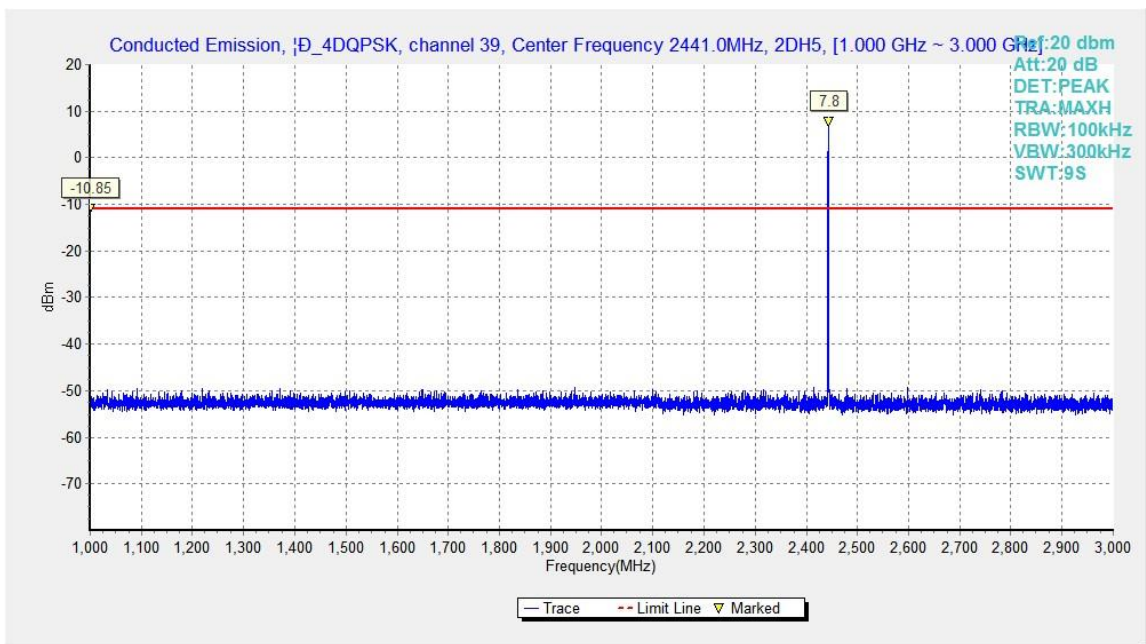

Fig.41. Conducted spurious emission: $\pi/4$ DQPSK, Channel 39, 1GHz - 3GHz

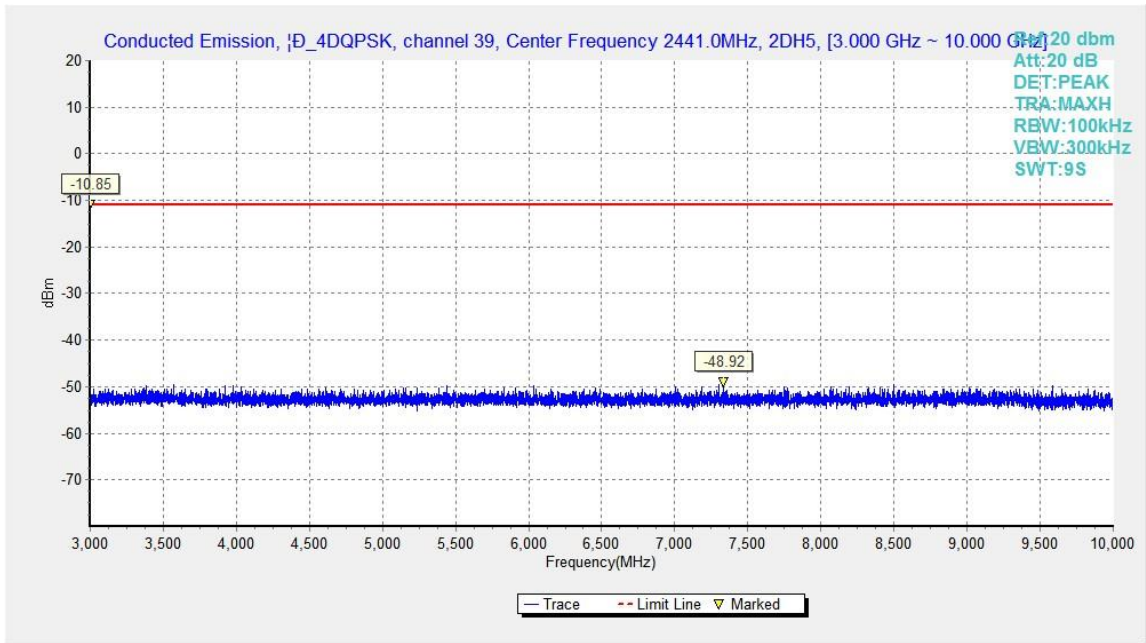

Fig.42. Conducted spurious emission: $\pi/4$ DQPSK, Channel 39, 3GHz - 10GHz

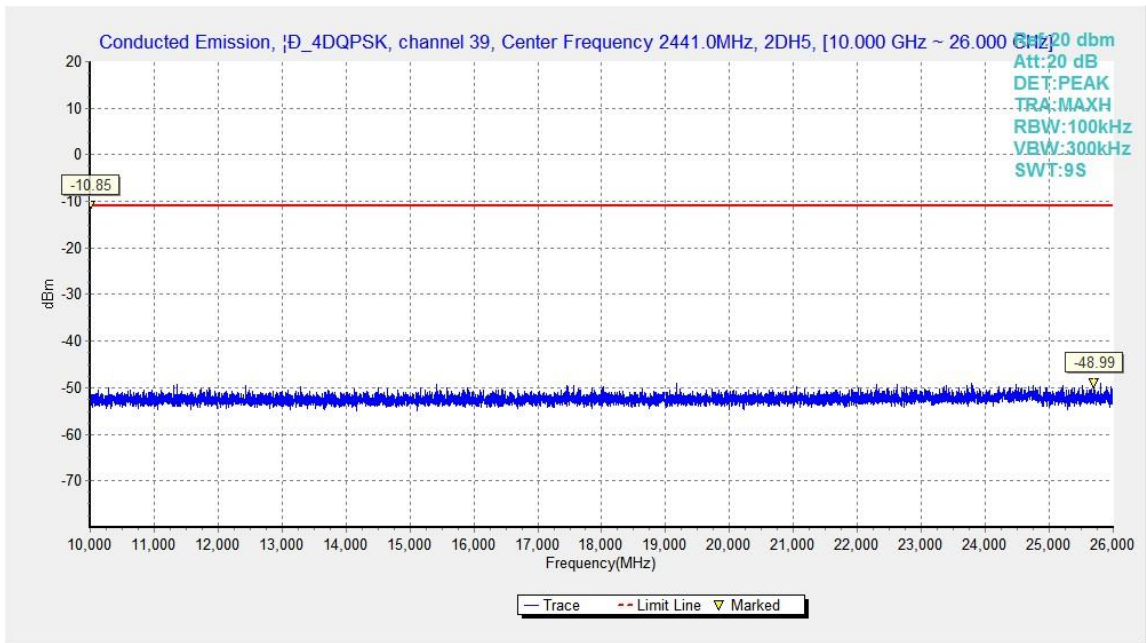

Fig.43. Conducted spurious emission: $\pi/4$ DQPSK, Channel 39, 10GHz – 26GHz

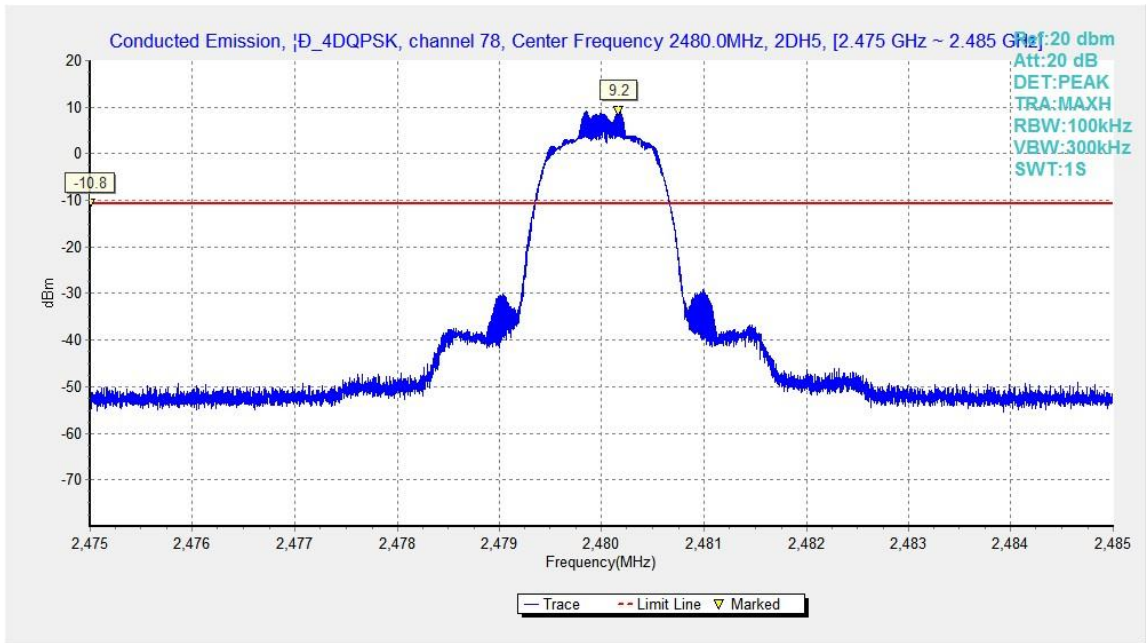

Fig.44. Conducted spurious emission: $\pi/4$ DQPSK, Channel 78, 2480MHz

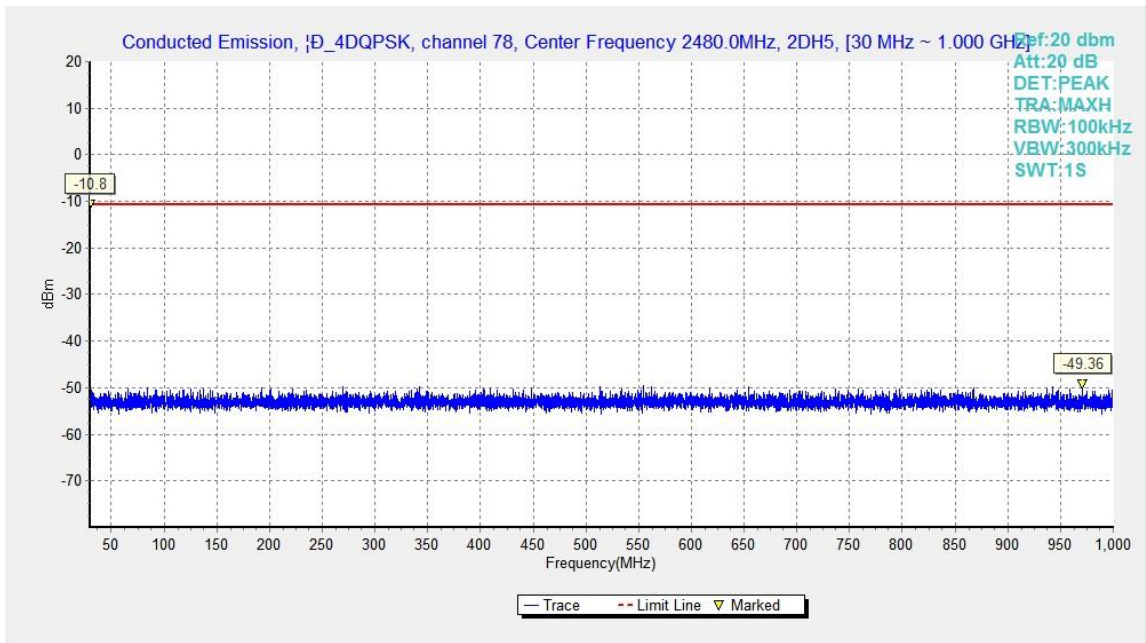

Fig.45. Conducted spurious emission: $\pi/4$ DQPSK, Channel 78, 30MHz - 1GHz

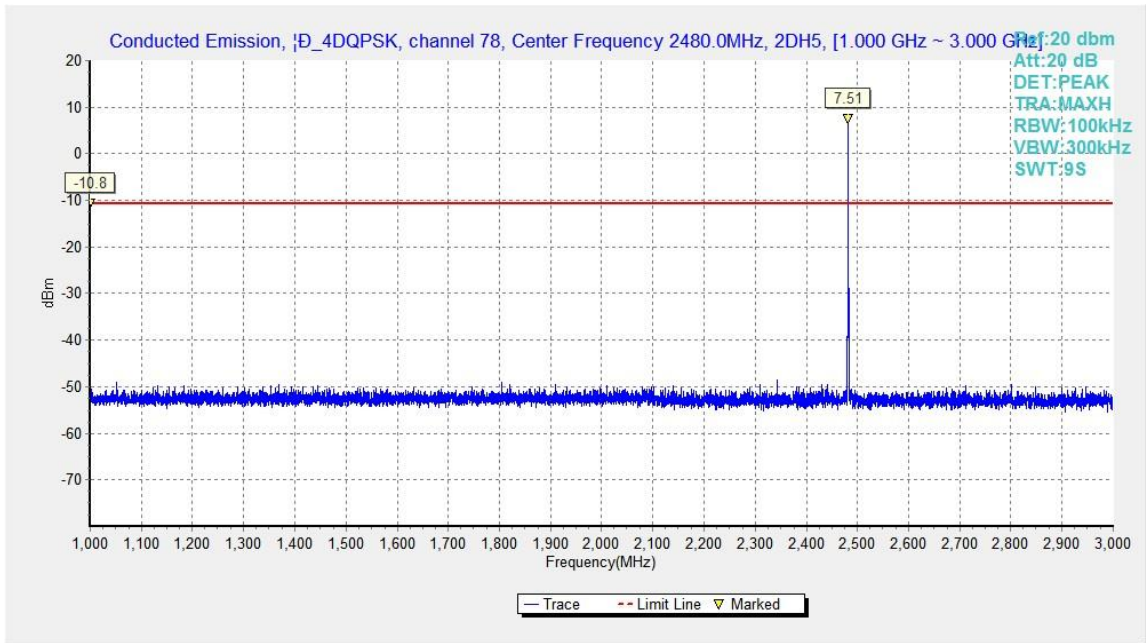

Fig.46. Conducted spurious emission: $\pi/4$ DQPSK, Channel 78, 1GHz - 3GHz

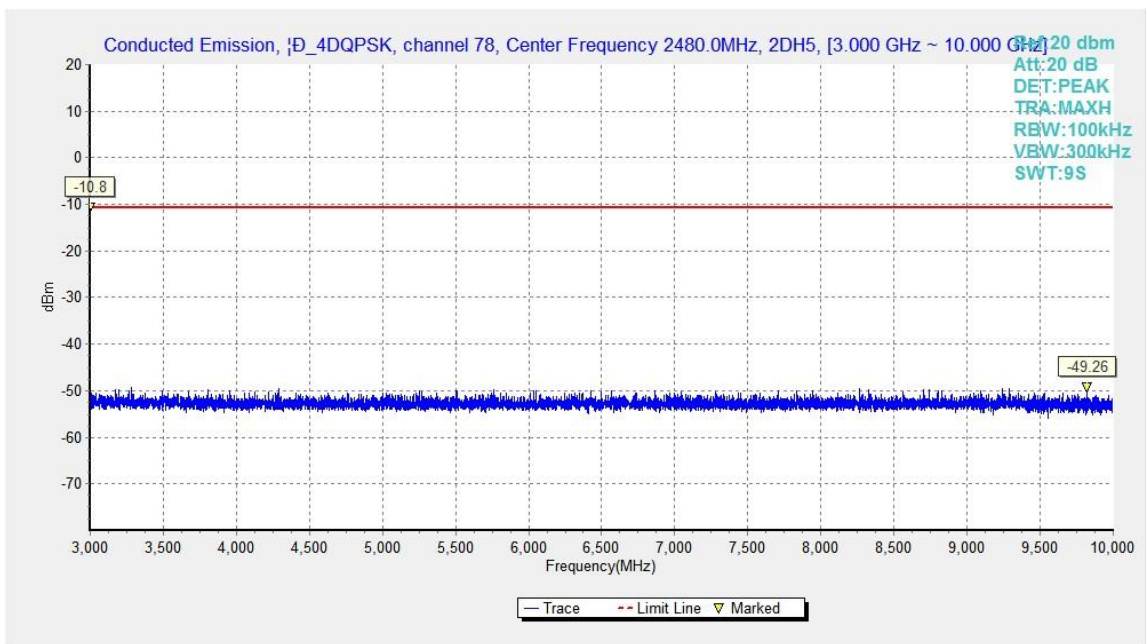

Fig.47. Conducted spurious emission: $\pi/4$ DQPSK, Channel 78, 3GHz - 10GHz

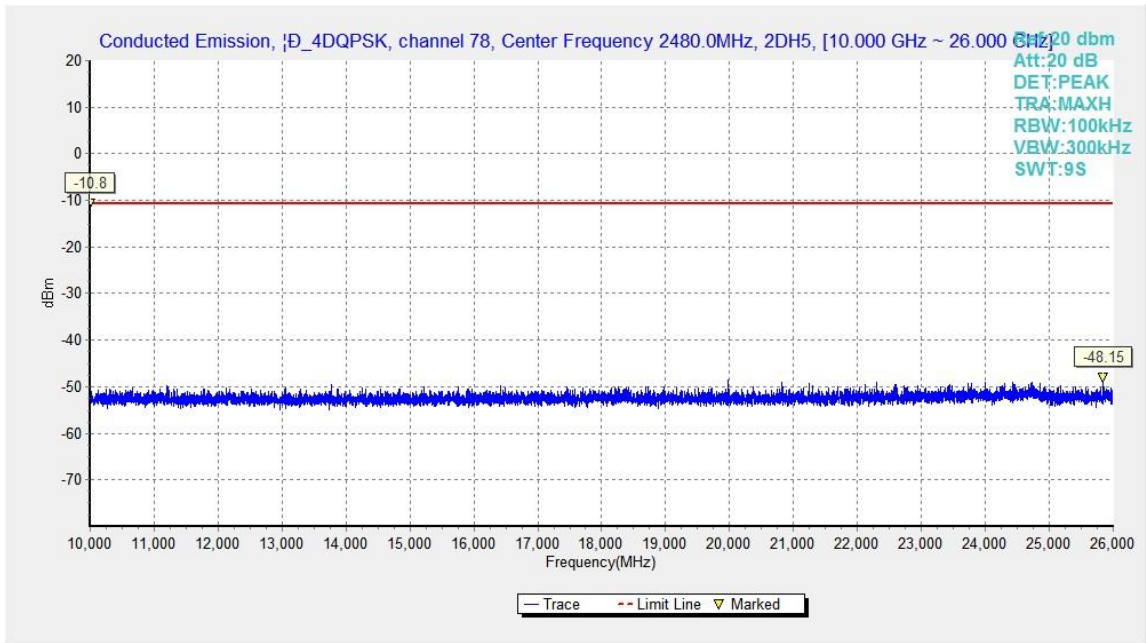

Fig.48. Conducted spurious emission: $\pi/4$ DQPSK, Channel 78, 10GHz - 26GHz

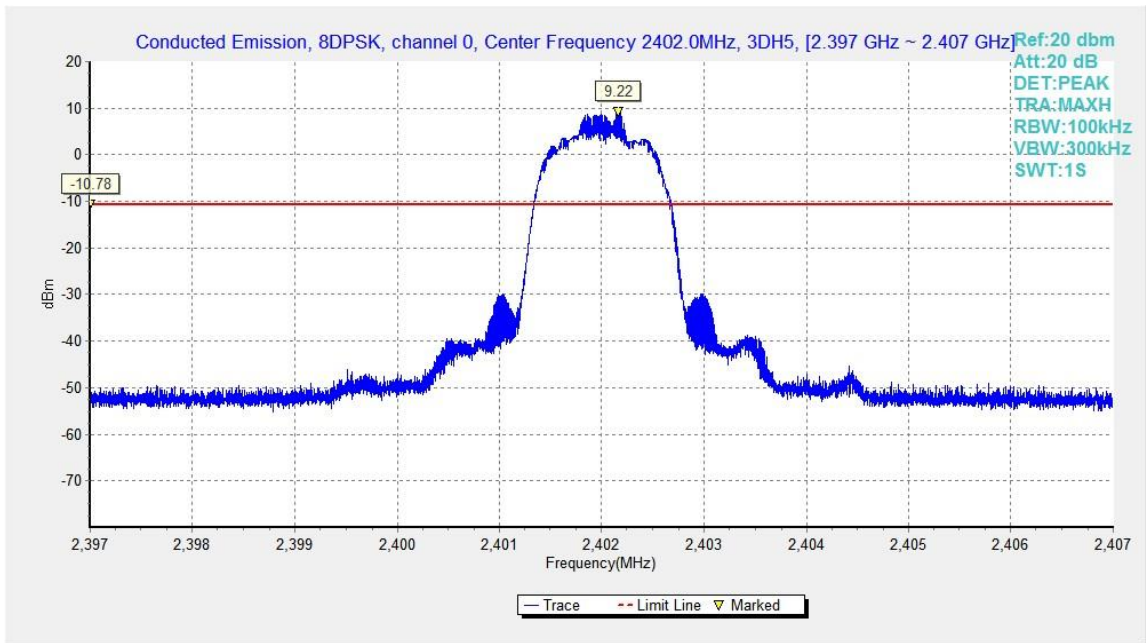

Fig.49. Conducted spurious emission: 8DPSK, Channel 0, 2402MHz

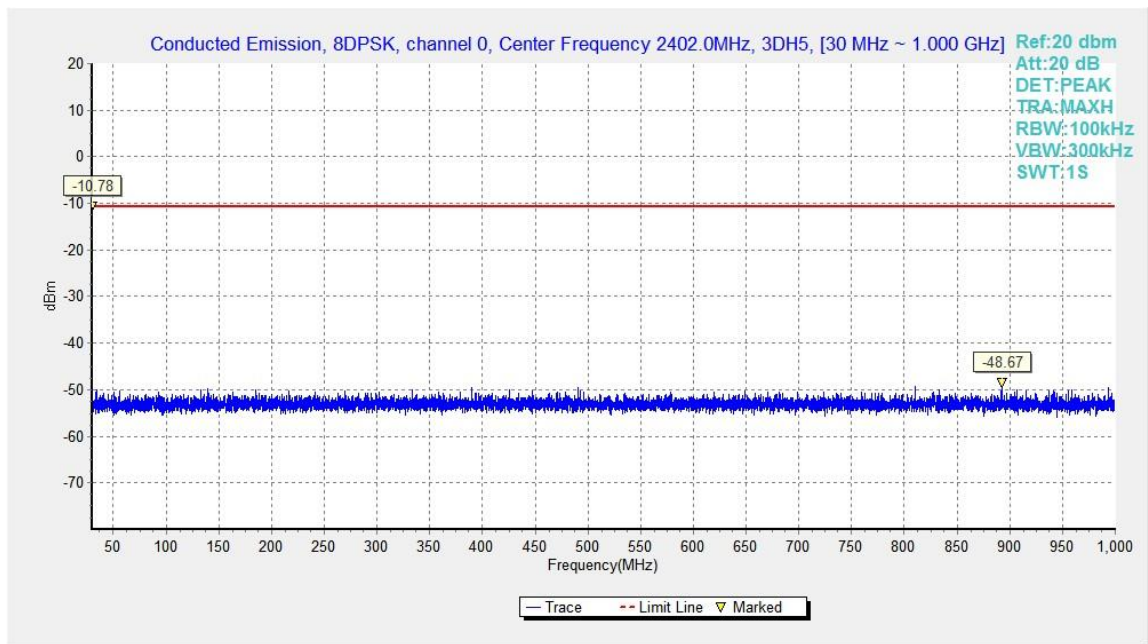

Fig.50. Conducted spurious emission: 8DPSK, Channel 0, 30MHz - 1GHz

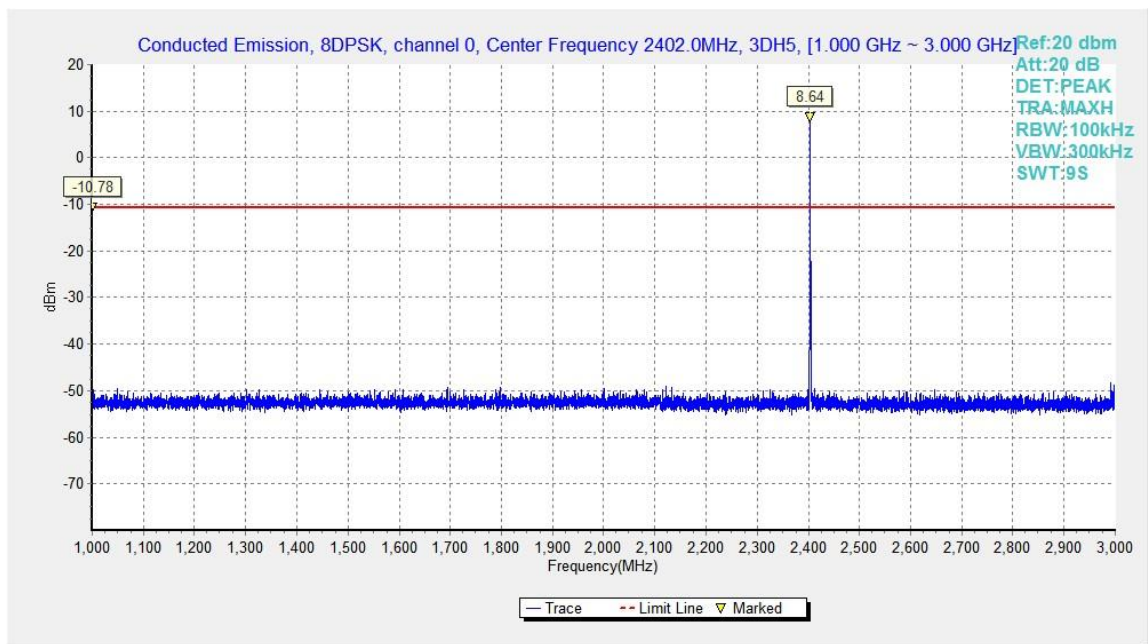

Fig.51. Conducted spurious emission: 8DPSK, Channel 0, 1GHz - 3GHz

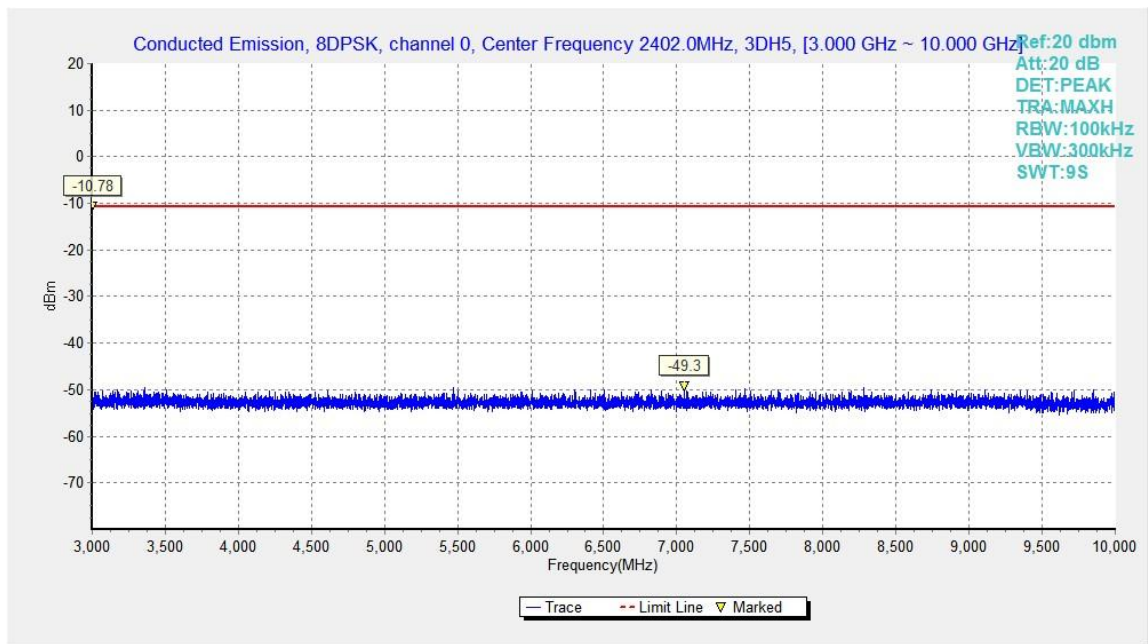

Fig.52. Conducted spurious emission: 8DPSK, Channel 0, 3GHz - 10GHz

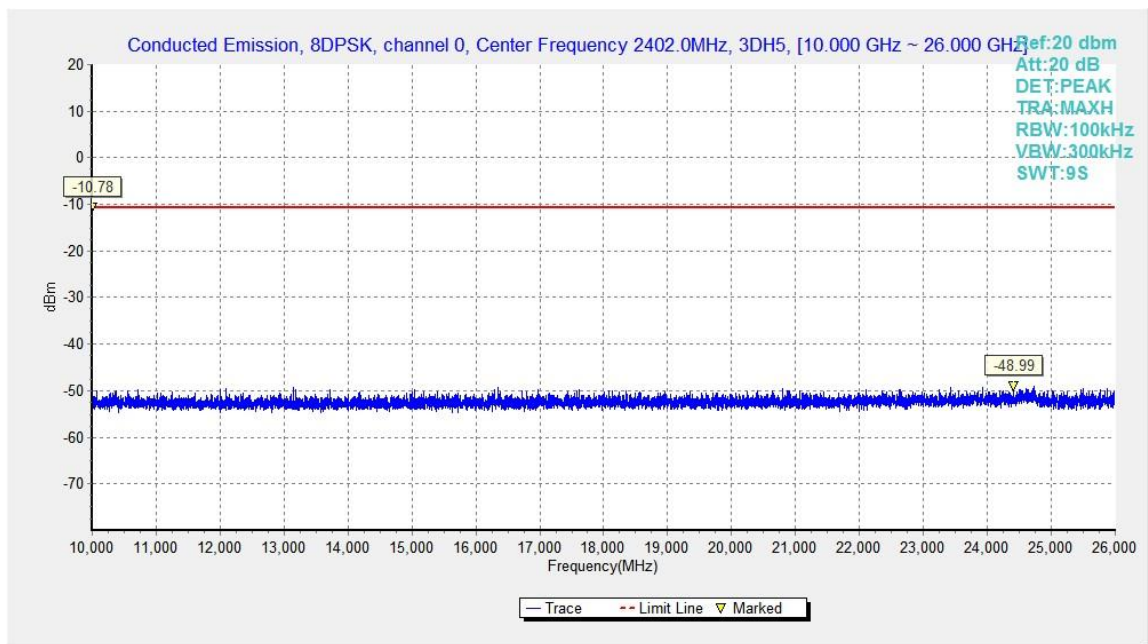

Fig.53. Conducted spurious emission: 8DPSK, Channel 0, 10GHz - 26GHz

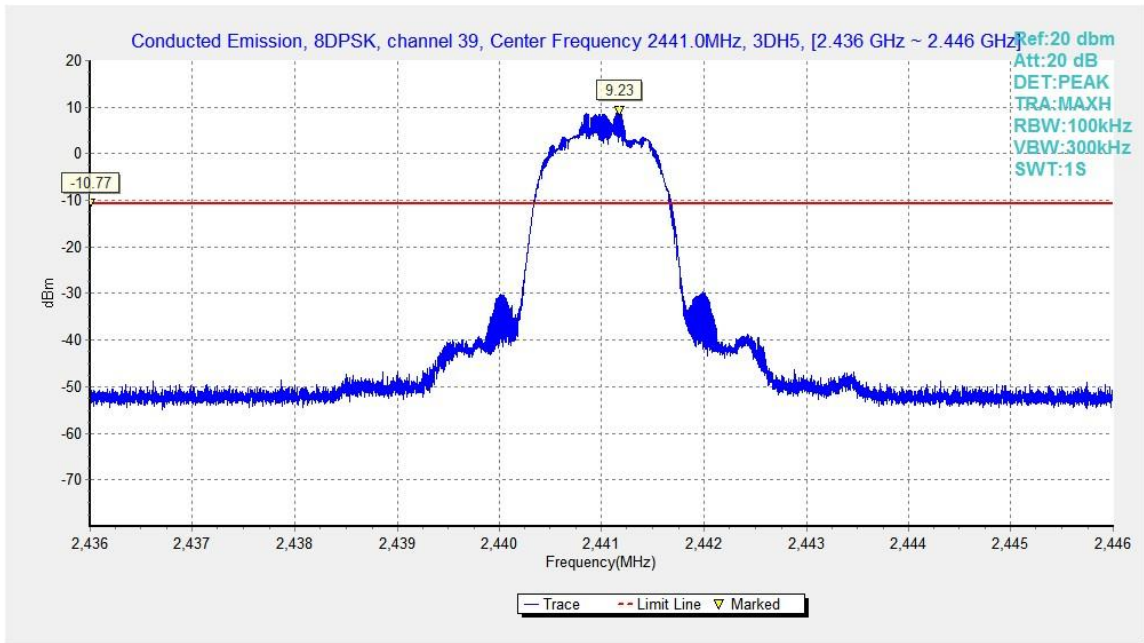

Fig.54. Conducted spurious emission: 8DPSK, Channel 39, 2441MHz

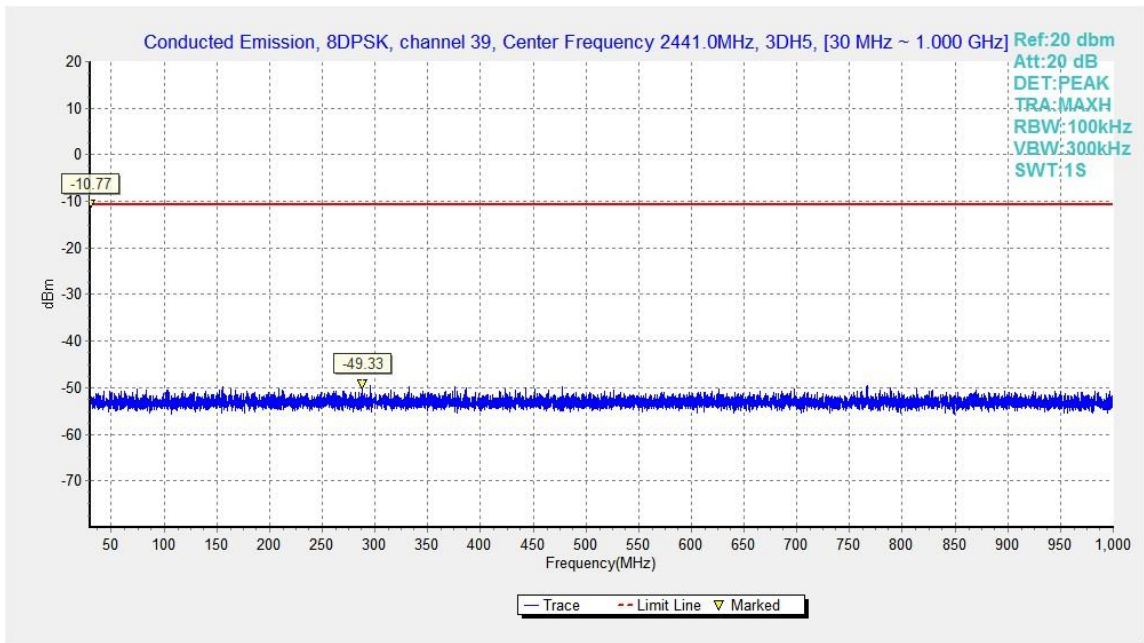

Fig.55. Conducted spurious emission: 8DPSK, Channel 39, 30MHz - 1GHz

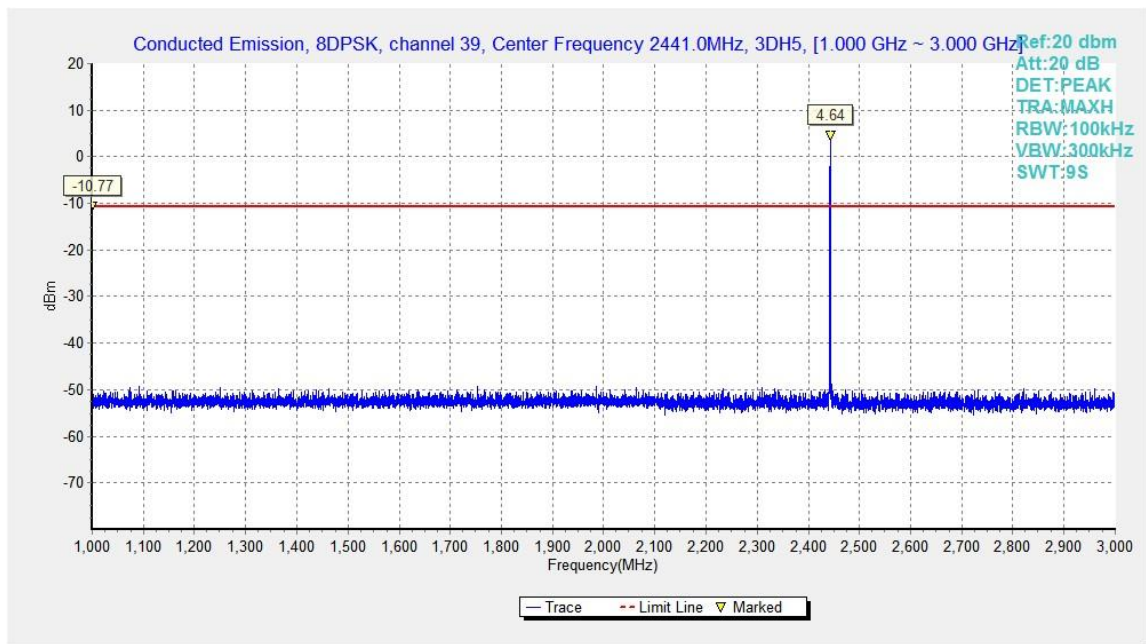

Fig.56. Conducted spurious emission: 8DPSK, Channel 39, 1GHz - 3GHz

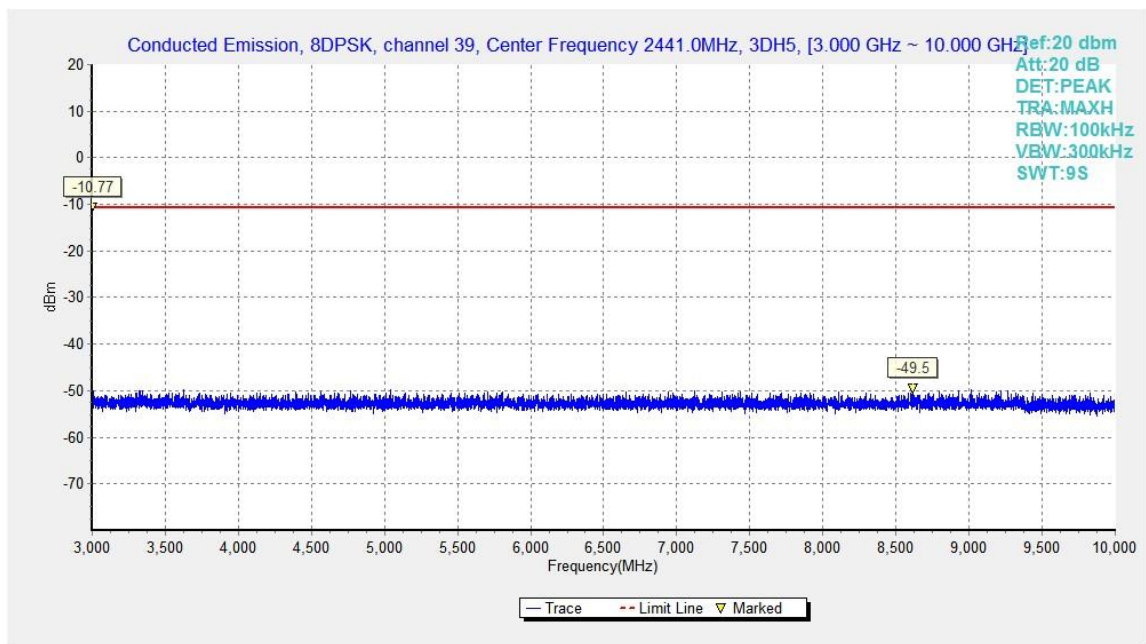

Fig.57. Conducted spurious emission: 8DPSK, Channel 39, 3GHz - 10GHz

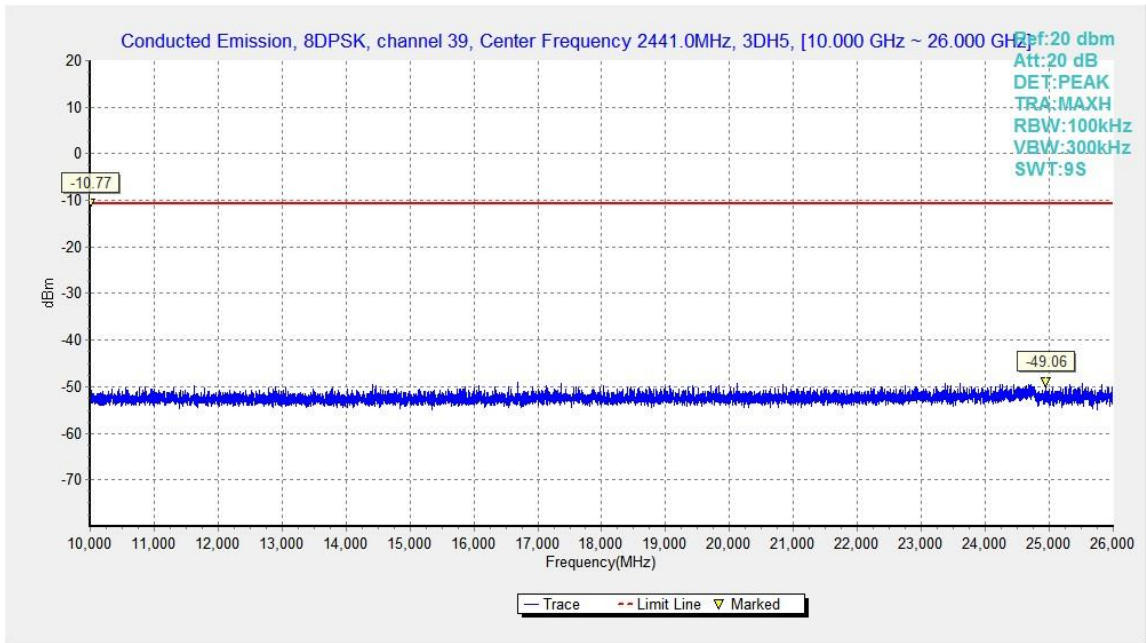

Fig.58. Conducted spurious emission: 8DPSK, Channel 39, 10GHz – 26GHz

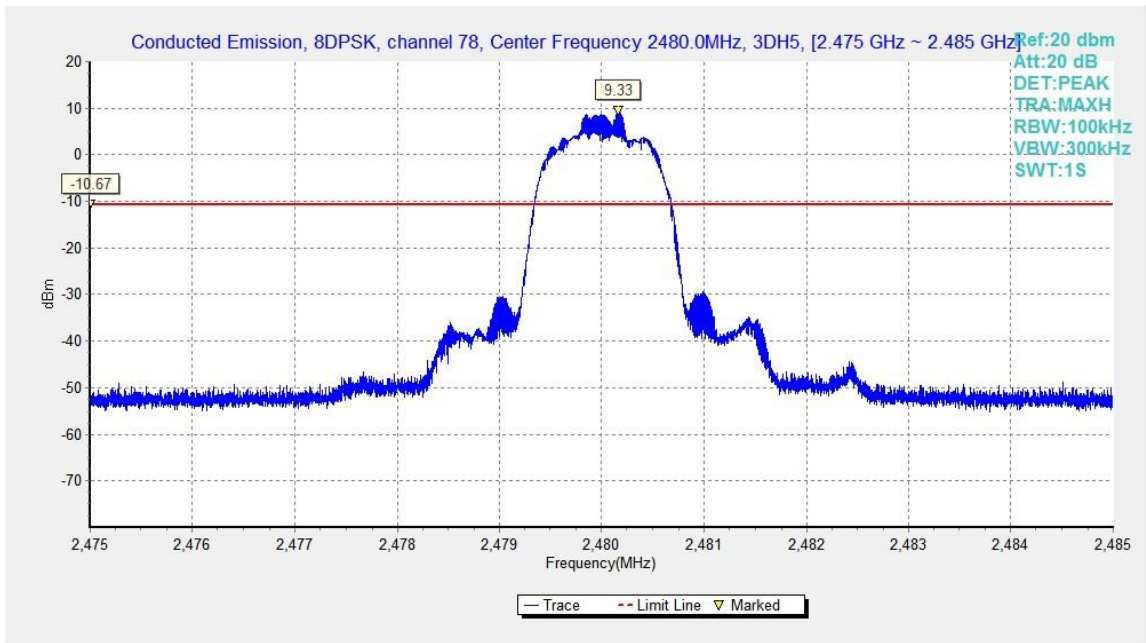

Fig.59. Conducted spurious emission: 8DPSK, Channel 78, 2480MHz

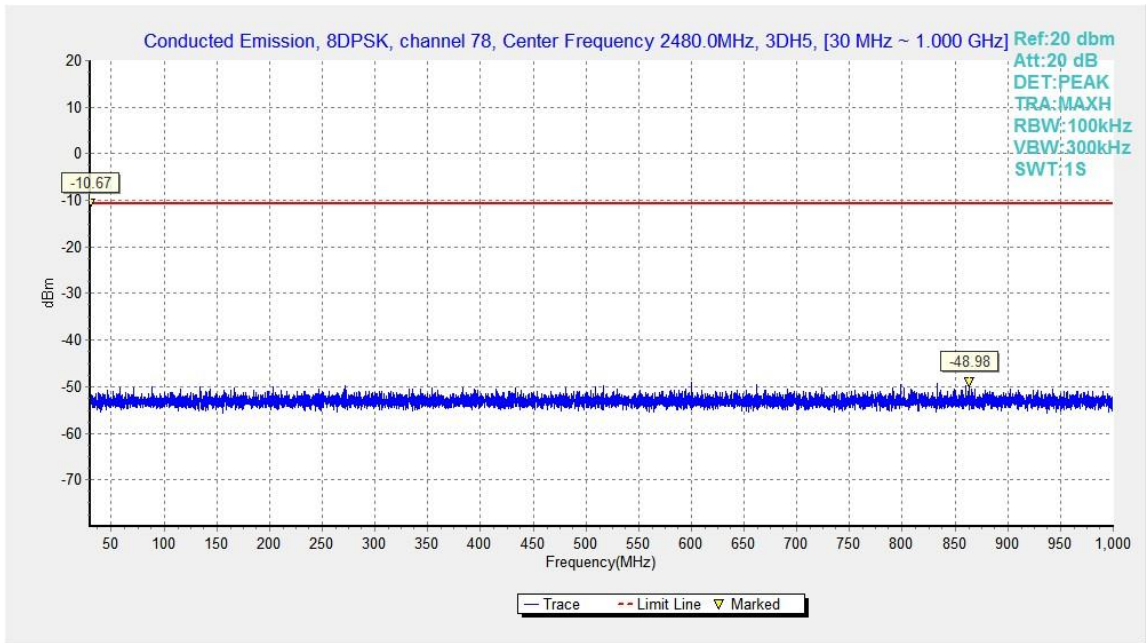

Fig.60. Conducted spurious emission: 8DPSK, Channel 78, 30MHz - 1GHz

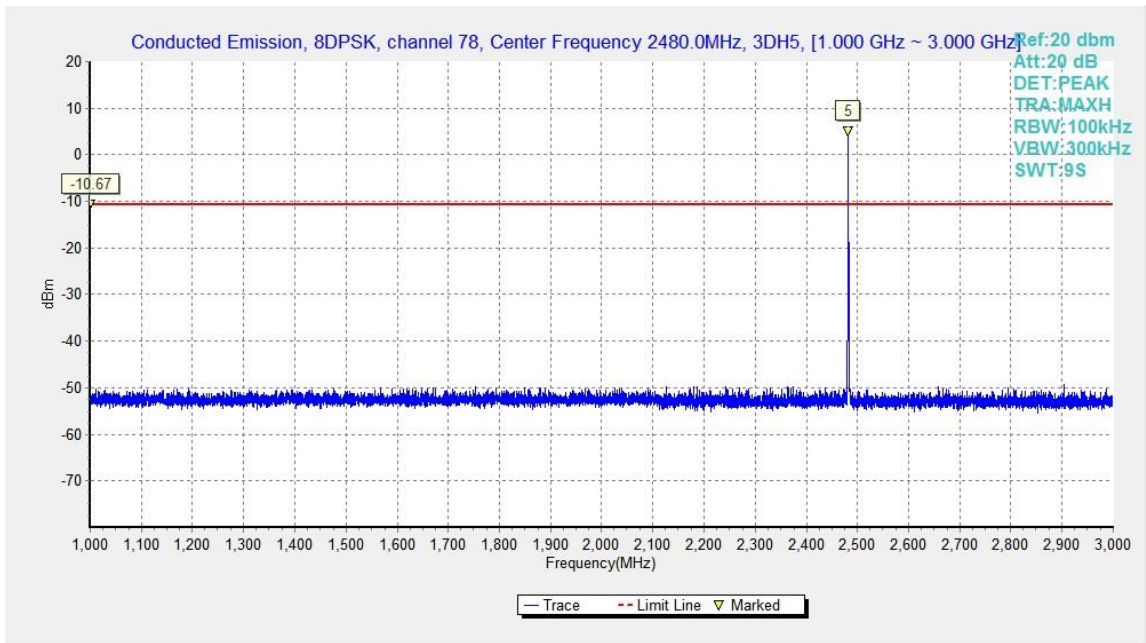

Fig.61. Conducted spurious emission: 8DPSK, Channel 78, 1GHz - 3GHz

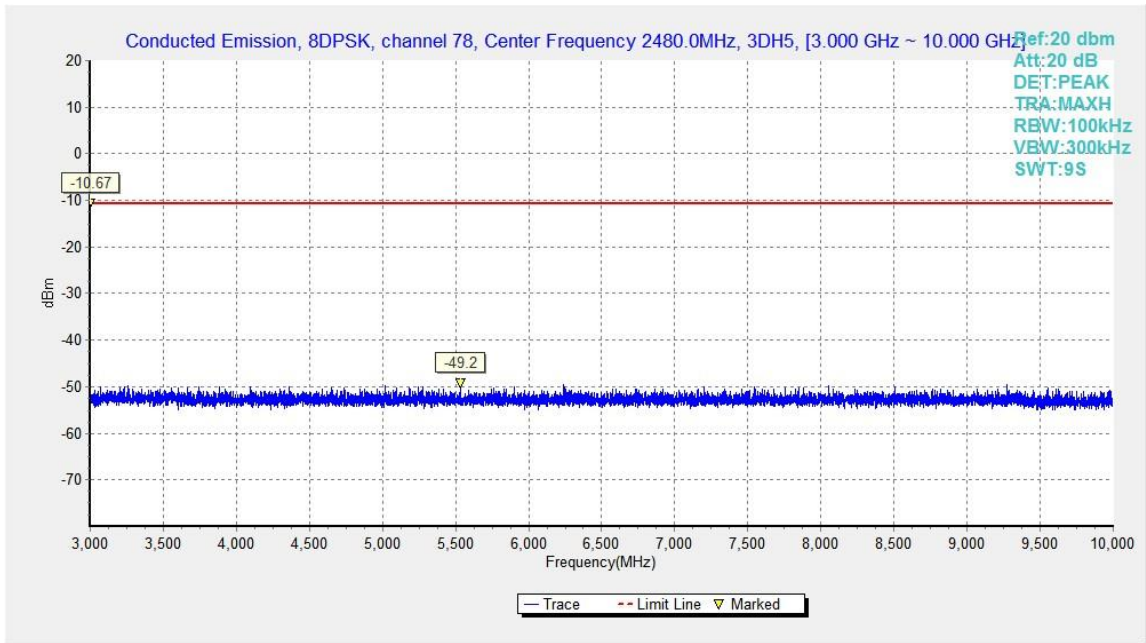

Fig.62. Conducted spurious emission: 8DPSK, Channel 78, 3GHz - 10GHz

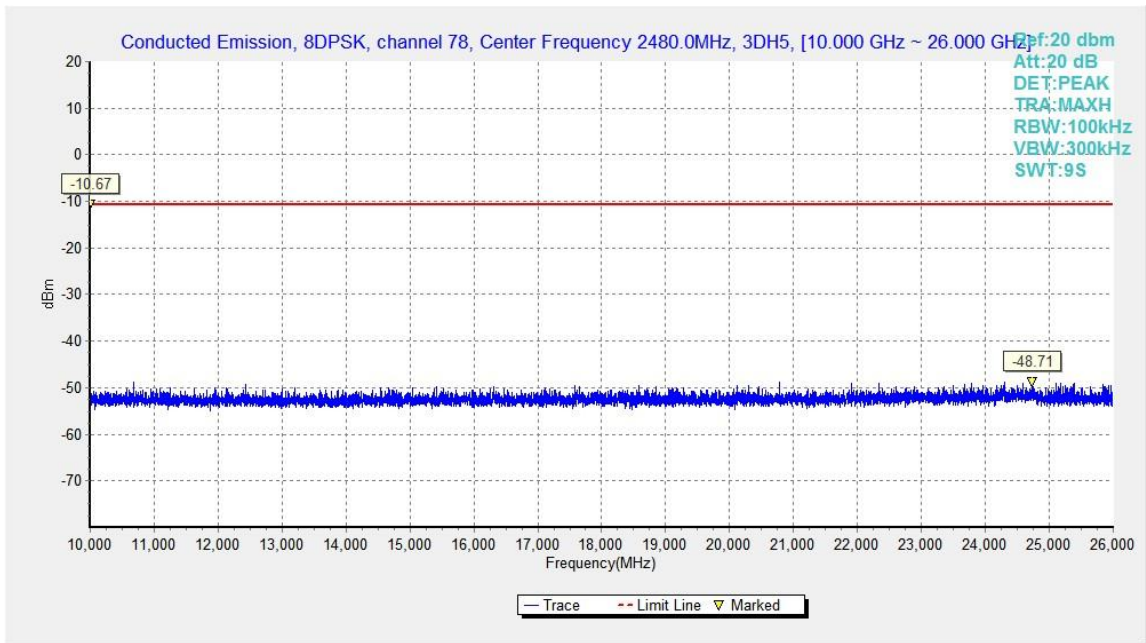

Fig.63. Conducted spurious emission: 8DPSK, Channel 78, 10GHz - 26GHz

B.6. Transmitter Spurious Emission - Radiated

Method of Measurement: See ANSI C63.10-2013-clause 6.4 & 6.5 & 6.6

Measurement Limit:

| Standard | Limit |
|--|------------------------------|
| FCC 47 CFR Part 15.247, 15.205, 15.209 | 20dB below peak output power |

radiated emissions which fall in the restricted bands, as defined in § 15.205(a), must also comply with the radiated emission limits specified in § 15.209(a) (see § 15.205(c)).

Limit in restricted band:

| Frequency (MHz) | Field strength(μ V/m) | Measurement distance (m) |
|-----------------|----------------------------|--------------------------|
| 0.009 - 0.490 | 2400/F(kHz) | 300 |
| 0.490 - 1.705 | 24000/F(kHz) | 30 |
| 1.705 – 30.0 | 30 | 30 |

| Frequency of emission (MHz) | Field strength(μ V/m) | Field strength(dBuV/m) |
|-----------------------------|----------------------------|------------------------|
| 30-88 | 100 | 40 |
| 88-216 | 150 | 43.5 |
| 216-960 | 200 | 46 |
| Above 960 | 500 | 54 |

Set up:

Tabletop devices shall be placed on a nonconducting platform with nominal top surface dimensions 1 m by 1.5 m. For emissions testing at or below 1 GHz, the table height shall be 80 cm above the reference ground plane. For emission measurements above 1 GHz, the table height shall be 1.5 m

The EUT and transmitting antenna shall be centered on the turntable.

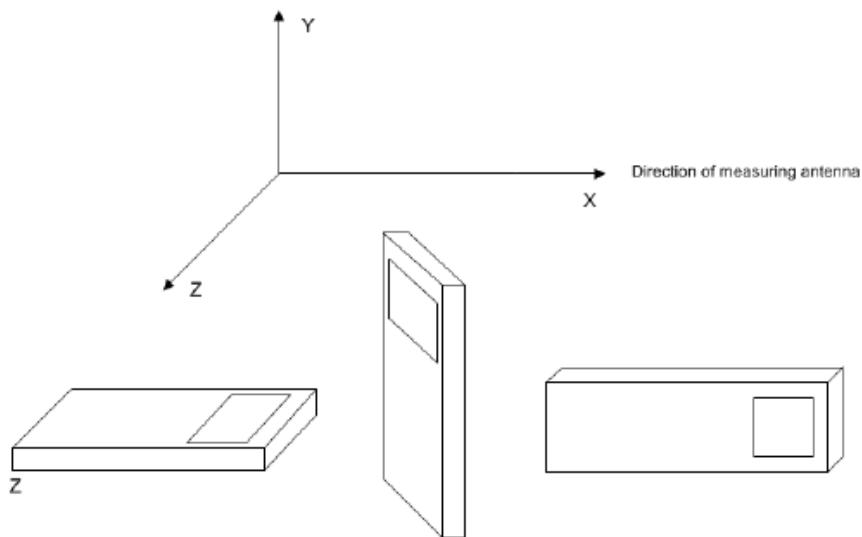
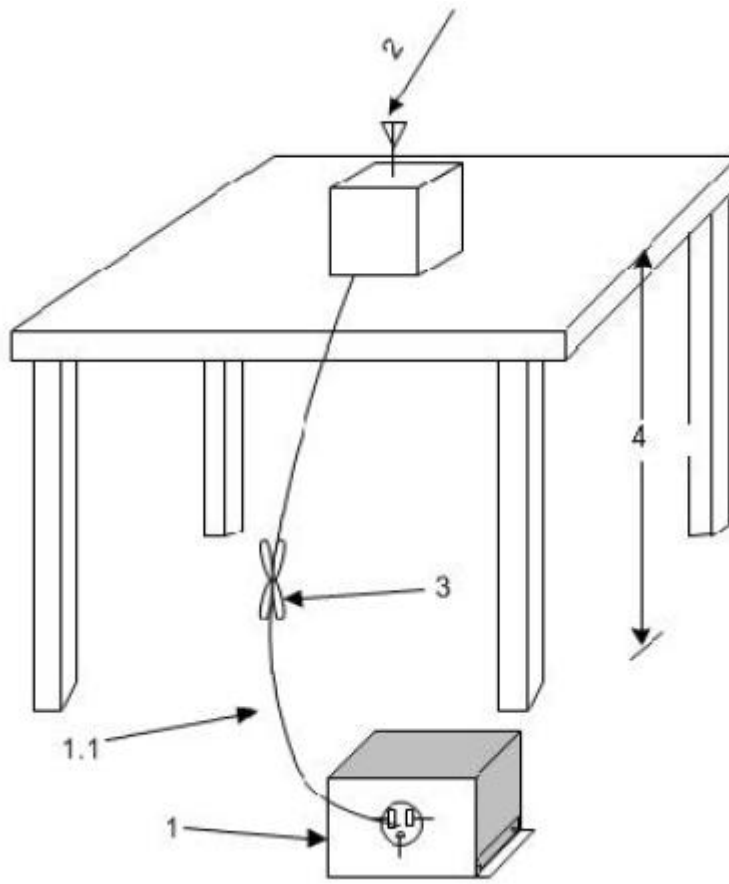

Test Condition

The EUT shall be tested 1 near top, 1 near middle, and 1 near bottom. Set the unlicensed wireless device to operate in continuous transmit mode. For unlicensed wireless devices unable to be configured for 100% duty cycle even in test mode, configure the system for the maximum duty cycle supported.

When required for unlicensed wireless devices, measurements of the variation of the input power or the radiated signal level of the fundamental frequency component of the emission, as appropriate, shall be performed with the supply voltage varied between 85% and 115% of the

nominal rated supply voltage.

Exploratory radiated emissions measurements

Exploratory radiated measurements shall be performed at the measurement distance or at a closer distance than that specified for compliance to determine the emission characteristics of the EUT and, if applicable, the EUT configuration that produces the maximum level of emissions. The frequencies of maximum emission may be determined by manually positioning the antenna close to the EUT, and then moving the antenna over all sides of the EUT while observing a spectral display. It is advantageous to have prior knowledge of the frequencies of emissions, although this may be determined from such a near-field scan. The near-field scan shall only be used to determine the frequency but not the amplitude of the emissions. Where exploratory measurements are not adequate to determine the worst-case operating modes and are used only to identify the frequencies of the highest emissions, additional preliminary tests can be required.

For emissions from the EUT, the maximum level shall be determined by rotating the EUT and its antenna through 0° to 360° . For each mode of operation required to be tested, the frequency spectrum (based on findings from exploratory measurements) shall be monitored.

Broadband antennas and a spectrum analyzer or a radio-noise meter with a panoramic display are often useful in this type of test. If either antenna height or EUT azimuth are not fully measured during exploratory testing, then complete testing can be required at the OATS or semi-anechoic chamber when the final full spectrum testing is performed.

Final radiated emissions measurements

The final measurements are using the orientation and equipment arrangement of the EUT based on the measurement results found during the preliminary (exploratory) measurements, the EUT arrangement, appropriate modulation, and modes of operation that produce the emissions that have the highest amplitude relative to the limit shall be selected for the final measurement.

For each mode of operation required to be tested, the frequency spectrum (based on findings from exploratory measurements) shall be monitored. The highest signal levels relative to the limit shall be determined by rotating the EUT from 0° to 360° and with varying the measurement antenna height between 1 m and 4 m in vertical and horizontal polarizations.

For each mode selected, record the frequency and amplitude of the highest fundamental emission (if applicable), as well as the frequency and amplitude of the six highest spurious emissions relative to the limit. Emissions more than 20 dB below the limit do not need to be reported.

This maximization process was repeated with the EUT positioned in each of its three orthogonal orientations.

The receiver references:

| Frequency of emission (MHz) | RBW/VBW | Sweep Time(s) |
|-----------------------------|---------------|---------------|
| 30-1000 | 100KHz/300KHz | 5 |
| 1000-4000 | 1MHz/3MHz | 15 |
| 4000-18000 | 1MHz/3MHz | 40 |
| 18000-26500 | 1MHz/3MHz | 20 |

P_{Mea} is the field strength recorded from the instrument.

The measurement results are obtained as described below:

$$\text{Result} = P_{Mea} + \text{Cable Loss} + \text{Antenna Factor}$$

Where:

P_{Mea} field strength recorded from the instrument

EUT ID: UT51a

Peak Measurement results

GFSK Ch 0

| Frequency (MHz) | Measurement Result (dB μ V/m) | Cable loss (dB) | Antenna Factor (dB/m) | Receiver Reading (dB μ V) | Limit (dB μ V/m) | Margin (dB) | Antenna Pol. (H/V) |
|-----------------|-----------------------------------|-----------------|-----------------------|-------------------------------|----------------------|-------------|--------------------|
| 17943.500 | 53.64 | -25.50 | 46.70 | 32.44 | 74.00 | 20.36 | V |
| 12572.500 | 49.80 | -31.00 | 39.00 | 41.90 | 74.00 | 24.20 | V |
| 14992.000 | 49.26 | -27.90 | 40.20 | 36.86 | 74.00 | 24.74 | H |
| 9222.000 | 43.59 | -33.70 | 38.00 | 39.29 | 74.00 | 30.41 | V |
| 7993.000 | 43.51 | -34.80 | 37.10 | 41.21 | 74.00 | 30.49 | V |
| 2347.900 | 56.78 | -20.10 | 28.00 | 48.88 | 74.00 | 17.22 | V |

GFSK Ch 39

| Frequency (MHz) | Measurement Result (dB μ V/m) | Cable loss (dB) | Antenna Factor (dB/m) | Receiver Reading (dB μ V) | Limit (dB μ V/m) | Margin (dB) | Antenna Pol. (H/V) |
|-----------------|-----------------------------------|-----------------|-----------------------|-------------------------------|----------------------|-------------|--------------------|
| 16901.000 | 53.83 | -26.30 | 42.40 | 37.83 | 74.00 | 20.17 | H |
| 14885.000 | 49.86 | -28.60 | 40.80 | 37.66 | 74.00 | 24.14 | H |
| 12636.500 | 49.11 | -31.00 | 39.00 | 41.21 | 74.00 | 24.89 | V |
| 8114.000 | 44.12 | -34.60 | 37.30 | 41.32 | 74.00 | 29.88 | H |
| 7457.500 | 42.76 | -35.20 | 36.70 | 41.16 | 74.00 | 31.24 | H |
| 4762.000 | 38.60 | -37.30 | 33.00 | 42.90 | 74.00 | 35.40 | V |

GFSK Ch 78

| Frequency (MHz) | Measurement Result (dB μ V/m) | Cable loss (dB) | Antenna Factor (dB/m) | Receiver Reading (dB μ V) | Limit (dB μ V/m) | Margin (dB) | Antenna Pol. (H/V) |
|-----------------|-----------------------------------|-----------------|-----------------------|-------------------------------|----------------------|-------------|--------------------|
| 17931.500 | 52.93 | -25.50 | 46.70 | 31.73 | 74.00 | 21.07 | H |
| 14864.500 | 49.08 | -28.60 | 40.80 | 36.88 | 74.00 | 24.92 | H |
| 12550.500 | 49.07 | -31.00 | 39.00 | 41.17 | 74.00 | 24.93 | V |
| 8475.000 | 43.41 | -34.40 | 37.80 | 40.01 | 74.00 | 30.59 | V |
| 7854.500 | 43.06 | -34.90 | 37.10 | 40.86 | 74.00 | 30.94 | H |
| 2485.100 | 67.38 | -20.00 | 28.30 | 59.08 | 74.00 | 6.62 | V |