



SAR TEST REPORT

No. I21Z60727-SEM06

For

BLU Products, Inc.

Smart Phone

Model name: B140DL

With

Hardware Version: V1.0

Software Version: BLU_B140DL_V11.0.01.05.01.04_FSec

FCC ID: YHLBLUB140DL

Issued Date: 2021-6-19

Note:

The test results in this test report relate only to the devices specified in this report. This report shall not be reproduced except in full without the written approval of CTTL.

The report must not be used by the client to claim product certification, approval, or endorsement by NVLAP, NIST, or any agency of the U.S. Government.

Test Laboratory:

CTTL, Telecommunication Technology Labs, CAICT

No. 51, Xueyuan Road, Haidian District, Beijing, P. R. China 100191.

Tel:+86(0)10-62304633-2512, Fax:+86(0)10-62304633-2504

Email: ctl_terminals@caict.ac.cn, website: www.caict.ac.cn



No.I21Z60772-SEM06

REPORT HISTORY

Report Number	Revision	Issue Date	Description
I21Z60727-SEM06	Rev.0	2021-6-19	Initial creation of test report

TABLE OF CONTENT

1 TEST LABORATORY	5
1.1 TESTING LOCATION	5
1.2 TESTING ENVIRONMENT.....	5
1.3 PROJECT DATA	5
1.4 SIGNATURE.....	5
2 STATEMENT OF COMPLIANCE	6
3 CLIENT INFORMATION	8
3.1 APPLICANT INFORMATION	8
3.2 MANUFACTURER INFORMATION	8
4 EQUIPMENT UNDER TEST (EUT) AND ANCILLARY EQUIPMENT (AE)	9
4.1 ABOUT EUT	9
4.2 INTERNAL IDENTIFICATION OF EUT USED DURING THE TEST	9
4.3 INTERNAL IDENTIFICATION OF AE USED DURING THE TEST	9
5 TEST METHODOLOGY	10
5.1 APPLICABLE LIMIT REGULATIONS	10
5.2 APPLICABLE MEASUREMENT STANDARDS.....	10
6 SPECIFIC ABSORPTION RATE (SAR).....	11
6.1 INTRODUCTION.....	11
6.2 SAR DEFINITION.....	11
7 TISSUE SIMULATING LIQUIDS	12
7.1 TARGETS FOR TISSUE SIMULATING LIQUID	12
7.2 DIELECTRIC PERFORMANCE	12
8 SYSTEM VERIFICATION	16
8.1 SYSTEM SETUP.....	16
8.2 SYSTEM VERIFICATION.....	17
9 MEASUREMENT PROCEDURES	18
9.1 TESTS TO BE PERFORMED	18
9.2 GENERAL MEASUREMENT PROCEDURE.....	20
9.3 WCDMA MEASUREMENT PROCEDURES FOR SAR	21
9.4 SAR MEASUREMENT FOR LTE.....	22
9.5 BLUETOOTH & WI-FI MEASUREMENT PROCEDURES FOR SAR	24
9.6 POWER DRIFT.....	24
10 AREA SCAN BASED 1-G SAR.....	25
10.1 REQUIREMENT OF KDB.....	25
10.2 FAST SAR ALGORITHMS	25



11 CONDUCTED OUTPUT POWER.....	26
11.1 GSM MEASUREMENT RESULT	26
11.2 WCDMA MEASUREMENT RESULT.....	28
11.3 LTE MEASUREMENT RESULT	30
11.4 WI-FI AND BT MEASUREMENT RESULT	69
12 SIMULTANEOUS TX SAR CONSIDERATIONS.....	71
12.1 INTRODUCTION.....	71
12.2 TRANSMIT ANTENNA SEPARATION DISTANCES	71
12.3 SAR MEASUREMENT POSITIONS	72
12.4 STANDALONE SAR TEST EXCLUSION CONSIDERATIONS	72
13 EVALUATION OF SIMULTANEOUS.....	73
14 SAR TEST RESULT	75
14.1 SAR RESULT.....	76
14.2 SAR RESULTS FOR STANDARD PROCEDURE	91
14.3 WLAN EVALUATION FOR 2.4G	99
14.4 SAR EVALUATION FOR PHABLET	104
15 SAR MEASUREMENT VARIABILITY.....	109
16 MEASUREMENT UNCERTAINTY	111
16.1 MEASUREMENT UNCERTAINTY FOR NORMAL SAR TESTS (300MHZ~3GHZ)	111
16.2 MEASUREMENT UNCERTAINTY FOR FAST SAR TESTS (300MHZ~3GHZ)	112
17 MAIN TEST INSTRUMENTS.....	113
ANNEX A GRAPH RESULTS.....	114
ANNEX B SYSTEM VERIFICATION RESULTS	161
ANNEX C SAR MEASUREMENT SETUP	177
ANNEX D POSITION OF THE WIRELESS DEVICE IN RELATION TO THE PHANTOM	183
ANNEX E EQUIVALENT MEDIA RECIPES	186
ANNEX F SYSTEM VALIDATION	187
ANNEX G PROBE CALIBRATION CERTIFICATE.....	188
ANNEX H DIPOLE CALIBRATION CERTIFICATE	197
ANNEX I ACCREDITATION CERTIFICATE.....	245

1 Test Laboratory

1.1 Testing Location

Company Name:	CTTL(Shouxiang)
Address:	No. 51 Shouxiang Science Building, Xueyuan Road, Haidian District, Beijing, P. R. China100191

1.2 Testing Environment

Temperature:	18°C~25°C,
Relative humidity:	30%~ 70%
Ground system resistance:	< 0.5 Ω
Ambient noise & Reflection:	< 0.012 W/kg

1.3 Project Data

Project Leader:	Qi Dianyuan
Test Engineer:	Lin Xiaojun
Testing Start Date:	May 21, 2021
Testing End Date:	June 7, 2021

1.4 Signature



Lin Xiaojun

(Prepared this test report)

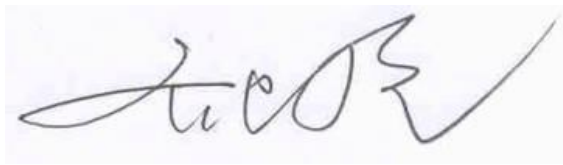

Qi Dianyuan

(Reviewed this test report)

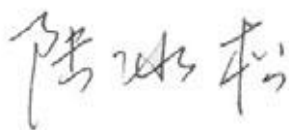

Lu Bingsong

Deputy Director of the laboratory

(Approved this test report)

2 Statement of Compliance

The maximum results of SAR found during testing for BLU Products, Inc. Smart Phone B140DL are as follows:

Table 2.1: Highest Reported SAR (1g)

Equipment Class	Mode	Highest Reported SAR (1g)			
		1g SAR Head	1g SAR Body-worn 15mm	1g SAR Hotspot 10mm	Product Specific 10-g SAR 0mm
PCE	GSM 850	0.21	/	0.4	/
	PCS 1900	0.29	/	1.31	3.94
	WCDMA1900	0.6	/	1.42	3.43
	WCDMA1700	0.41	0.89	1.5	3.51
	WCDMA850	0.29	/	0.46	/
	LTE Band 12	0.38	/	0.54	/
	LTE Band 13	0.41	/	0.68	/
	LTE Band 25	0.58	0.41	1.01	3.1
	LTE Band 26	0.39	/	0.61	/
	LTE Band 41	0.11	0.5	1.21	2.66
	LTE Band 41 HPUE	0.15	1.09	1.3	3.53
	LTE Band 66	0.45	0.49	1.01	3.65
LTE Band 71	0.38	/	0.47	/	
DTS	WLAN 2.4 GHz	0.69	0.5	0.58	1.87

The SAR values found for the Mobile Phone are below the maximum recommended levels of 1.6 W/kg as averaged over any 1g tissue according to the ANSI C95.1-1992.

For body operation, this device has been tested and meets FCC RF exposure guidelines when used with any accessory that contains no metal and which provides a minimum separation distance of 10 mm for hotspot and 15mm for body worn between this device and the body of the user. Use of other accessories may not ensure compliance with FCC RF exposure guidelines.

The EUT battery must be fully charged and checked periodically during the test to ascertain uniform power output.

The measurement together with the test system set-up is described in annex C of this test report. A detailed description of the equipment under test can be found in chapter 4 of this test report. The highest reported SAR value is obtained at the case of **(Table 2.1)**, and the values are: **1.5 W/kg(1g)**.

Table 2.2: The sum of reported SAR values for main antenna and WiFi2.4G

	Position	Main antenna	WiFi	Sum
Highest reported SAR value for Head	Left hand, Touch cheek	0.6	0.69	1.29
Highest reported SAR value for Body	Rear 10mm	1.21	0.34	1.55
	Bottom 10mm	1.5	/	1.5

Table 2.4: The sum of reported SAR values for main antenna and BT

	Position	Main antenna	BT	Sum
Maximum reported SAR value for Head	Left hand, Touch cheek	0.6	0.17 ^[1]	0.77
Maximum reported SAR value for Body	Rear 10mm	1.31	0.09 ^[1]	1.4
	Bottom 10mm	1.5	/	1.5

[1] - Estimated SAR for Bluetooth (see the table 13.3)

According to the above tables, the highest sum of reported SAR values is **1.55 W/kg (1g)**. The detail for simultaneous transmission consideration is described in chapter 13.



3 Client Information

3.1 Applicant Information

Company Name:	BLU Products, Inc.
Address/Post:	10814 NW 33rd St # 100 Doral, FL 33172, USA
Contact Person:	Zeng wei
Contact Email:	zwei@ctasiasz.com
Telephone:	305.715.7171
Fax	305.436.8819

3.2 Manufacturer Information

Company Name:	BLU Products, Inc.
Address/Post:	10814 NW 33rd St # 100 Doral, FL 33172, USA
Contact Person:	Zeng wei
Contact Email:	zwei@ctasiasz.com
Telephone:	305.715.7171
Fax	305.436.8819

4 Equipment Under Test (EUT) and Ancillary Equipment (AE)

4.1 About EUT

Description:	Smart Phone
Model name:	B140DL
Operating mode(s):	UMTS FDD 2/4/5, BT, Wi-Fi(2.4G) LTE Band 12/13/25/26/41/66/71
Tested Tx Frequency:	824 – 849 MHz (GSM 850)
	1850 – 1910 MHz (GSM 1900)
	824–849 MHz (WCDMA 850 Band V)
	1710 – 1755 MHz (WCDMA 1700 Band IV)
	1850–1910 MHz (WCDMA1900 Band II)
	699 – 716 MHz (LTE Band 12)
	777 –787 MHz (LTE Band 13)
	1850 – 1915 MHz (LTE Band 25)
	814 – 849 MHz (LTE Band 26)
	2496 – 2690 MHz (LTE Band 41)
	1710 – 1780 MHz (LTE Band 66)
	663 – 698 MHz (LTE Band 71)
	2402 – 2480 MHz (Bluetooth)
2412 – 2462 MHz (Wi-Fi 2.4G)	
Test device Production information:	Production unit
Device type:	Portable device
Antenna type:	Integrated antenna
Hotspot mode:	Support

4.2 Internal Identification of EUT used during the test

EUT ID*	IMEI	HW	SW Version
EUT1	353011720006873	V1.0	BLU_B140DL_V11.0.01.05.01.04_FSec
EUT2	353011720006246	V1.0	BLU_B140DL_V11.0.01.05.01.04_FSec
EUT3	353011720019694	V1.0	BLU_B140DL_V11.0.01.05.01.04_FSec
EUT4	353011720019900	V1.0	BLU_B140DL_V11.0.01.05.01.04_FSec

*EUT ID: is used to identify the test sample in the lab internally.

Note: It is performed to test SAR with the EUT3~4 and conducted power with the EUT1~2.

4.3 Internal Identification of AE used during the test

AE ID*	Description	Model	SN	Manufacturer
AE1	Battery	PT34H406082J	P104-BTC000-000	Ningbo Veken Battery Co., Ltd.

*AE ID: is used to identify the test sample in the lab internally.

5 TEST METHODOLOGY

5.1 Applicable Limit Regulations

ANSI C95.1–1992: IEEE Standard for Safety Levels with Respect to Human Exposure to Radio Frequency Electromagnetic Fields, 3 kHz to 300 GHz.

It specifies the maximum exposure limit of **1.6 W/kg** as averaged over any 1 gram of tissue for portable devices being used within 20 cm of the user in the uncontrolled environment.

5.2 Applicable Measurement Standards

IEEE 1528–2013: Recommended Practice for Determining the Peak Spatial-Average Specific Absorption Rate (SAR) in the Human Head from Wireless Communications Devices: Measurement Techniques.

KDB447498 D01: General RF Exposure Guidance v06: Mobile and Portable Devices RF Exposure Procedures and Equipment Authorization Policies.

KDB648474 D04 Handset SAR v01r03: SAR Evaluation Considerations for Wireless Handsets.

KDB941225 D01 SAR test for 3G devices v03r01: SAR Measurement Procedures for 3G Devices

KDB941225 D05 SAR for LTE Devices v02r05: SAR Evaluation Considerations for LTE Devices

KDB941225 D06 Hotspot Mode SAR v02r01: SAR Evaluation Procedures for Portable Devices with Wireless Router Capabilities

KDB248227 D01 802.11 Wi-Fi SAR v02r02: SAR GUIDANCE FOR IEEE 802.11 (Wi-Fi) TRANSMITTERS

KDB865664 D01 SAR measurement 100 MHz to 6 GHz v01r04: SAR Measurement Requirements for 100 MHz to 6 GHz.

KDB865664 D02 RF Exposure Reporting v01r02: RF Exposure Compliance Reporting and Documentation Considerations

6 Specific Absorption Rate (SAR)

6.1 Introduction

SAR is related to the rate at which energy is absorbed per unit mass in an object exposed to a radio field. The SAR distribution in a biological body is complicated and is usually carried out by experimental techniques or numerical modeling. The standard recommends limits for two tiers of groups, occupational/controlled and general population/uncontrolled, based on a person's awareness and ability to exercise control over his or her exposure. In general, occupational/controlled exposure limits are higher than the limits for general population/uncontrolled.

6.2 SAR Definition

The SAR definition is the time derivative (rate) of the incremental energy (dW) absorbed by (dissipated in) an incremental mass (dm) contained in a volume element (dv) of a given density (ρ). The equation description is as below:

$$SAR = \frac{d}{dt} \left(\frac{dW}{dm} \right) = \frac{d}{dt} \left(\frac{dW}{\rho dv} \right)$$

SAR is expressed in units of Watts per kilogram (W/kg)

SAR measurement can be either related to the temperature elevation in tissue by

$$SAR = c \left(\frac{\delta T}{\delta t} \right)$$

Where: C is the specific heat capacity, δT is the temperature rise and δt is the exposure duration, or related to the electrical field in the tissue by

$$SAR = \frac{\sigma |E|^2}{\rho}$$

Where: σ is the conductivity of the tissue, ρ is the mass density of tissue and E is the RMS electrical field strength.

However for evaluating SAR of low power transmitter, electrical field measurement is typically applied.

7 Tissue Simulating Liquids

7.1 Targets for tissue simulating liquid

Table 7.1: Targets for tissue simulating liquid

Frequency(MHz)	Liquid Type	Conductivity(σ)	$\pm 10\%$ Range	Permittivity(ϵ)	$\pm 10\%$ Range
750	Head	0.89	0.80~0.98	41.94	37.75~46.13
835	Head	0.90	0.81~0.99	41.5	37.35~45.65
1750	Head	1.37	1.23~1.51	40.08	36.07~44.09
1900	Head	1.40	1.26~1.54	40.0	36~44
2450	Head	1.80	1.62~1.98	39.2	35.28~43.12
2600	Head	1.96	1.76~2.16	39.01	35.11~42.91

7.2 Dielectric Performance

Table 7.2: Dielectric Performance of Tissue Simulating Liquid

Measurement Date (yyyy-mm-dd)	Type	Frequency	Permittivity ϵ	Drift (%)	Conductivity σ (S/m)	Drift (%)
2021/5/21	Head	750 MHz	44.44	5.96%	0.8572	-3.69%
2021/5/21	Head	835 MHz	44.15	6.39%	0.8915	-0.94%
2021/5/23	Head	1750 MHz	42.31	5.56%	1.396	1.90%
2021/5/23	Head	1900 MHz	41.73	4.32%	1.509	7.79%
2021/5/23	Head	2600 MHz	40.52	3.87%	2.064	5.31%
2021/5/25	Head	1900 MHz	40.63	1.58%	1.493	6.64%
2021/5/26	Head	1750 MHz	40.98	2.25%	1.409	2.85%
2021/5/26	Head	1900 MHz	40.63	1.58%	1.493	6.64%
2021/5/26	Head	2450 MHz	39.79	1.51%	1.924	6.89%
2021/5/26	Head	2600 MHz	39.31	0.77%	2.047	4.44%
2021/5/28	Head	1750 MHz	40.98	2.25%	1.409	2.85%
2021/5/28	Head	1900 MHz	40.63	1.58%	1.493	6.64%
2021/5/28	Head	2450 MHz	39.79	1.51%	1.924	6.89%
2021/5/28	Head	2600 MHz	39.31	0.77%	2.047	4.44%
2021/6/7	Head	2450MHz	40.27	2.73%	1.915	6.39 %

Note: The liquid temperature is 22.0°C

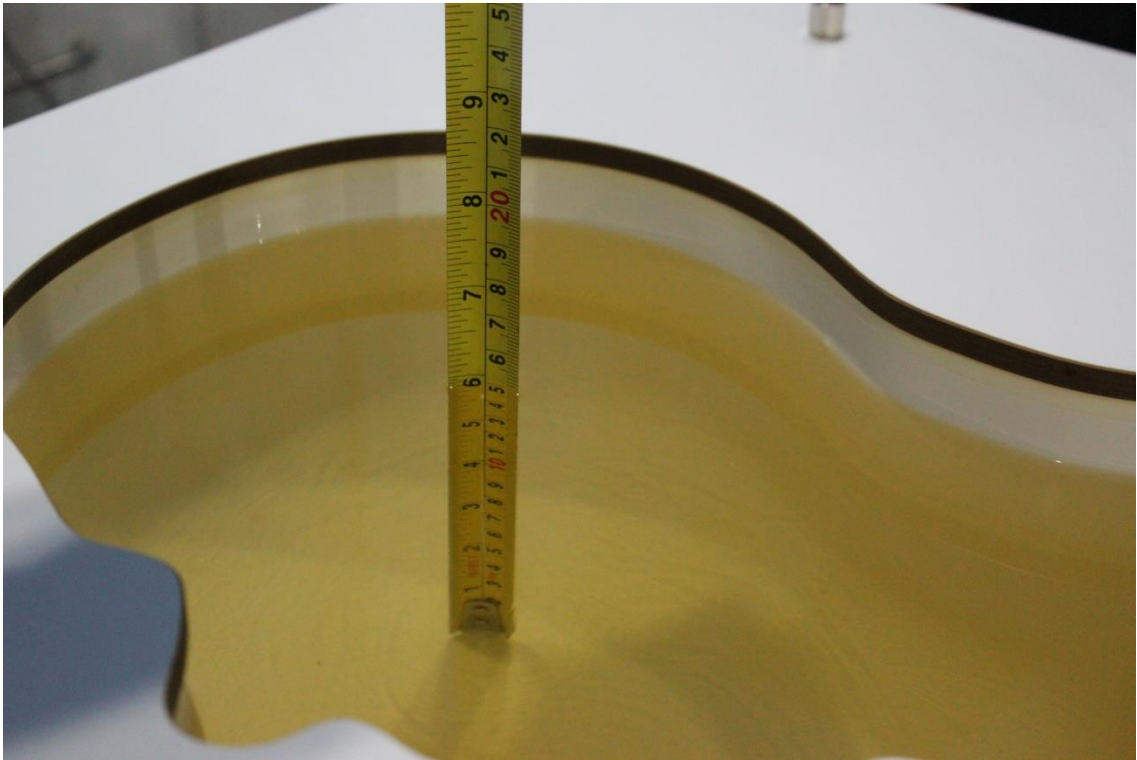

Picture 7-1 Liquid depth in the Head Phantom (750MHz)

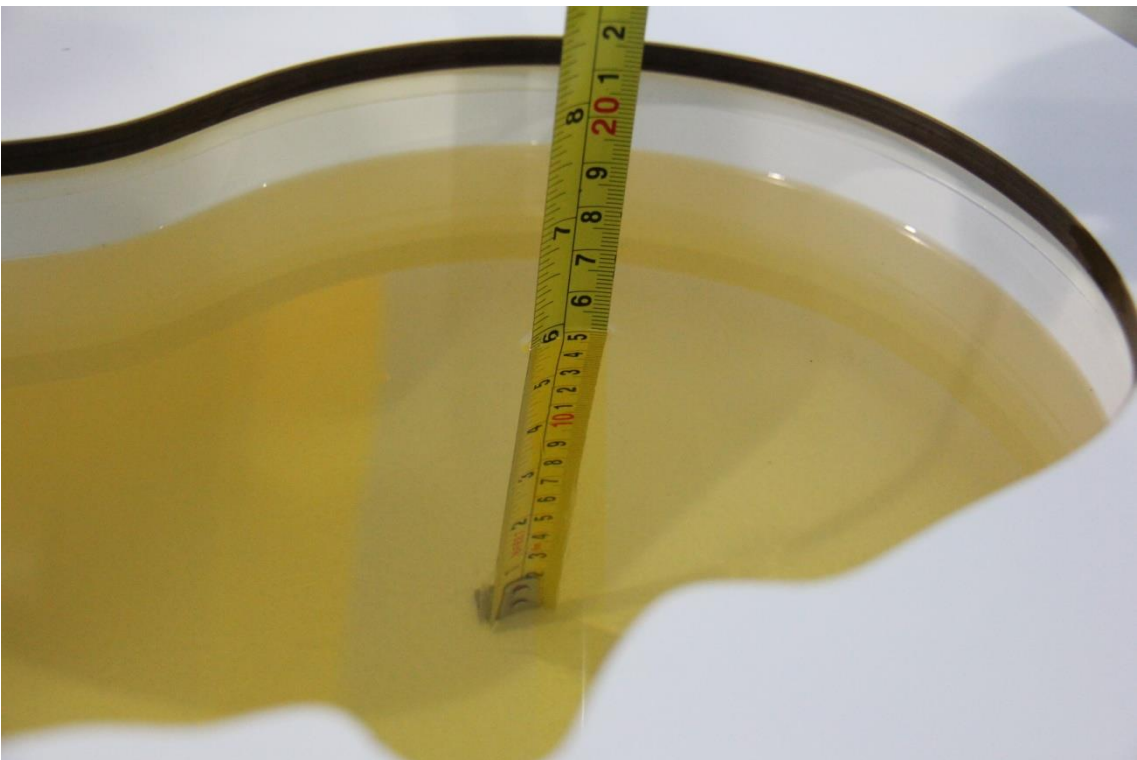

Picture 7-2 Liquid depth in the Head Phantom (835 MHz)



Picture 7-3 Liquid depth in the Head Phantom (1750 MHz)

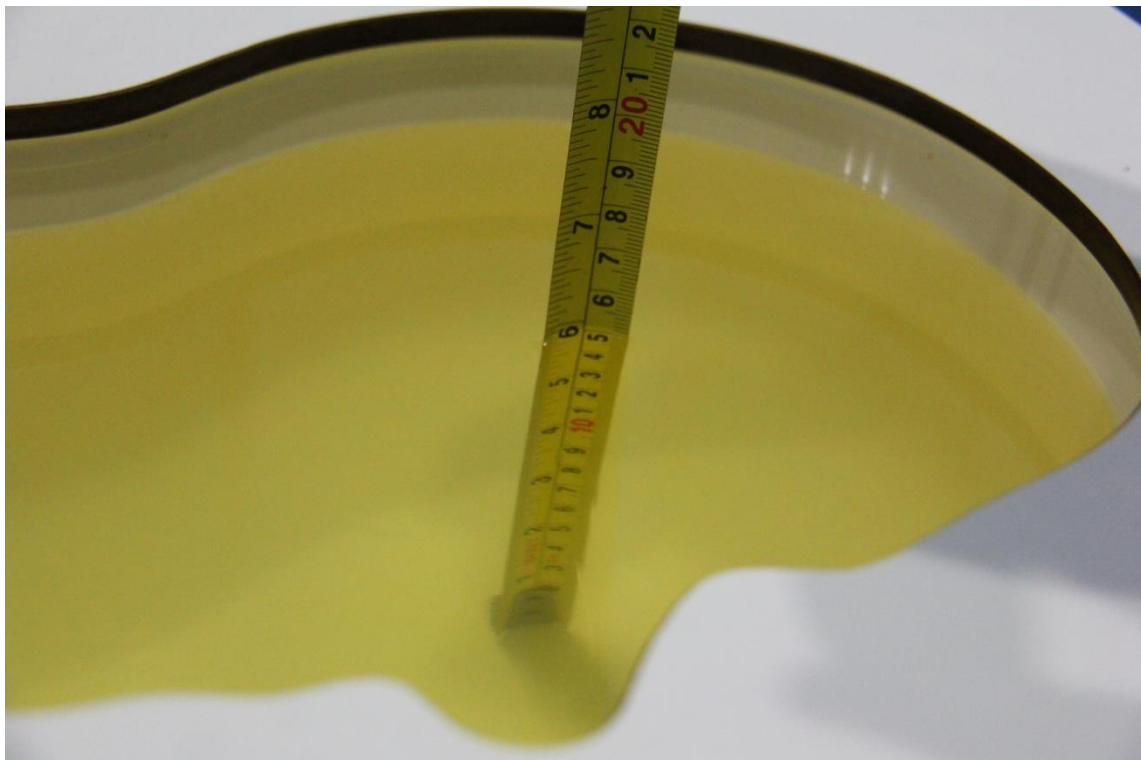

Picture 7-4 Liquid depth in the Head Phantom (1900 MHz)



Picture 7-5 Liquid depth in the Head Phantom (2450MHz)

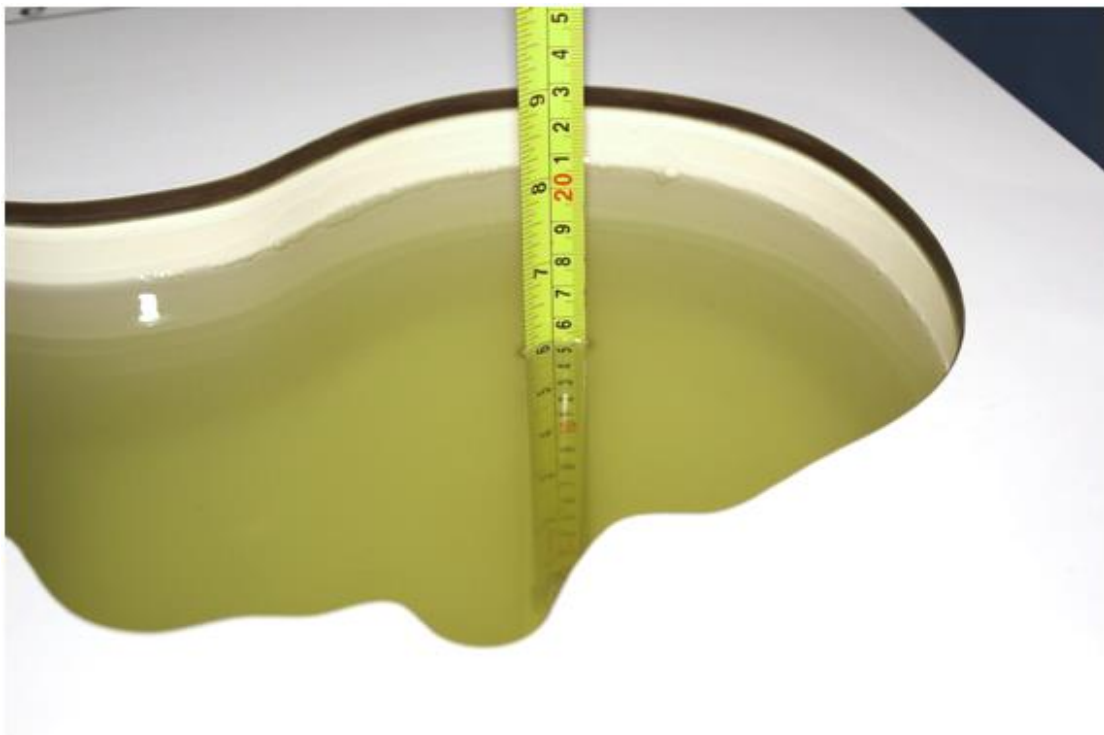

Picture 7-6 Liquid depth in the Head Phantom (2600 MHz)

8 System verification

8.1 System Setup

In the simplified setup for system evaluation, the DUT is replaced by a calibrated dipole and the power source is replaced by a continuous wave that comes from a signal generator. The calibrated dipole must be placed beneath the flat phantom section of the SAM twin phantom with the correct distance holder. The distance holder should touch the phantom surface with a light pressure at the reference marking and be oriented parallel to the long side of the phantom. The equipment setup is shown below:

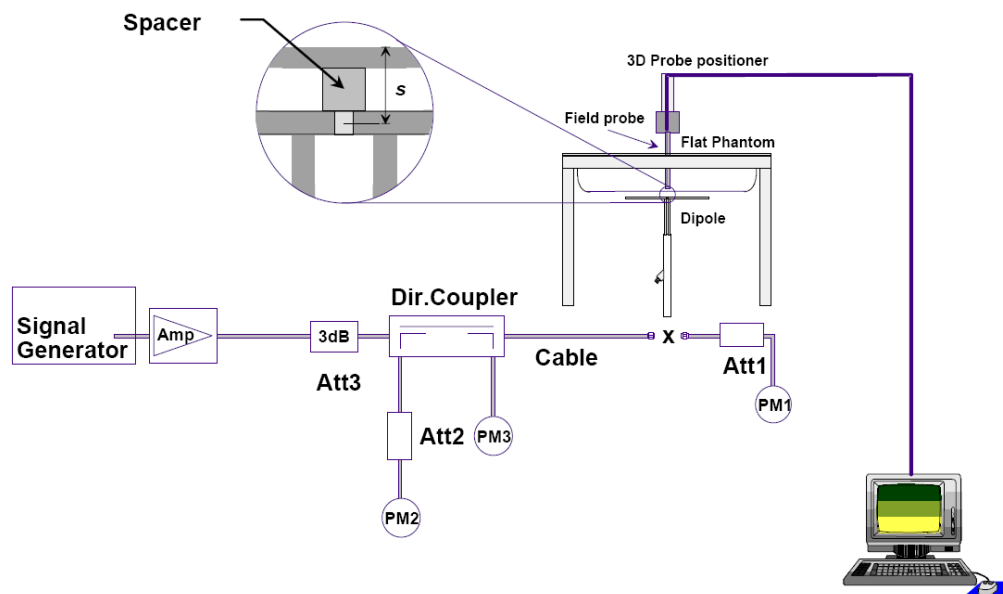

Picture 8.1 System Setup for System Evaluation



Picture 8.2 Photo of Dipole Setup

8.2 System Verification

SAR system verification is required to confirm measurement accuracy, according to the tissue dielectric media, probe calibration points and other system operating parameters required for measuring the SAR of a test device. The system verification must be performed for each frequency band and within the valid range of each probe calibration point required for testing the device.

The system verification results are required that the area scan estimated 1-g SAR is within 3% of the zoom scan 1-g SAR. The details are presented in annex B.

Table 8.1: System Verification of Head

Measurement Date (yyyy-mm-dd)	Frequency	Target value (W/kg)		Measured value(W/kg)		Deviation	
		10 g Average	1 g Average	10 g Average	1 g Average	10 g Average	1 g Average
2021/5/21	750 MHz	5.84	8.85	5.44	8.24	-6.85%	-6.89%
2021/5/21	835 MHz	6.25	9.60	6.08	9.28	-2.72%	-3.33%
2021/5/23	1750 MHz	19.1	36.5	20.4	38.1	7.02%	4.33%
2021/5/23	1900 MHz	20.6	39.6	21.6	42.0	5.05%	6.06%
2021/5/23	2600 MHz	25.3	57.0	25.9	58.0	2.45%	1.75%
2021/5/25	1900 MHz	20.6	39.6	21.5	41.6	4.27%	5.05%
2021/5/26	1750 MHz	19.1	36.5	20.5	38.3	7.43%	4.88%
2021/5/26	1900 MHz	20.6	39.6	21.4	41.6	3.88%	5.05%
2021/5/26	2450 MHz	24.5	52.5	25.5	55.2	4.16%	5.14%
2021/5/26	2600 MHz	25.3	57.0	25.5	56.8	0.87%	-0.35%
2021/5/28	1750 MHz	19.1	36.5	20.7	38.8	8.27%	6.30%
2021/5/28	1900 MHz	20.6	39.6	21.8	42.0	6.02%	6.06%
2021/5/28	2450 MHz	24.5	52.5	26.0	56.0	6.29%	6.67%
2021/5/28	2600 MHz	25.3	57.0	25.7	57.2	1.50%	0.35%
2021/6/7	2450 MHz	24.5	52.5	23.9	50.8	-2.37%	-3.24%

9 Measurement Procedures

9.1 Tests to be performed

In order to determine the highest value of the peak spatial-average SAR of a handset, all device positions, configurations and operational modes shall be tested for each frequency band according to steps 1 to 3 below. A flowchart of the test process is shown in picture 9.1.

Step 1: The tests described in 9.2 shall be performed at the channel that is closest to the centre of the transmit frequency band (f_c) for:

- a) all device positions (cheek and tilt, for both left and right sides of the SAM phantom, as described in annex D),
- b) all configurations for each device position in a), e.g., antenna extended and retracted, and
- c) all operational modes, e.g., analogue and digital, for each device position in a) and configuration in b) in each frequency band.

If more than three frequencies need to be tested according to 11.1 (i.e., $N_c > 3$), then all frequencies, configurations and modes shall be tested for all of the above test conditions.

Step 2: For the condition providing highest peak spatial-average SAR determined in Step 1, perform all tests described in 9.2 at all other test frequencies, i.e., lowest and highest frequencies. In addition, for all other conditions (device position, configuration and operational mode) where the peak spatial-average SAR value determined in Step 1 is within 3 dB of the applicable SAR limit, it is recommended that all other test frequencies shall be tested as well.

Step 3: Examine all data to determine the highest value of the peak spatial-average SAR found in Steps 1 to 2.

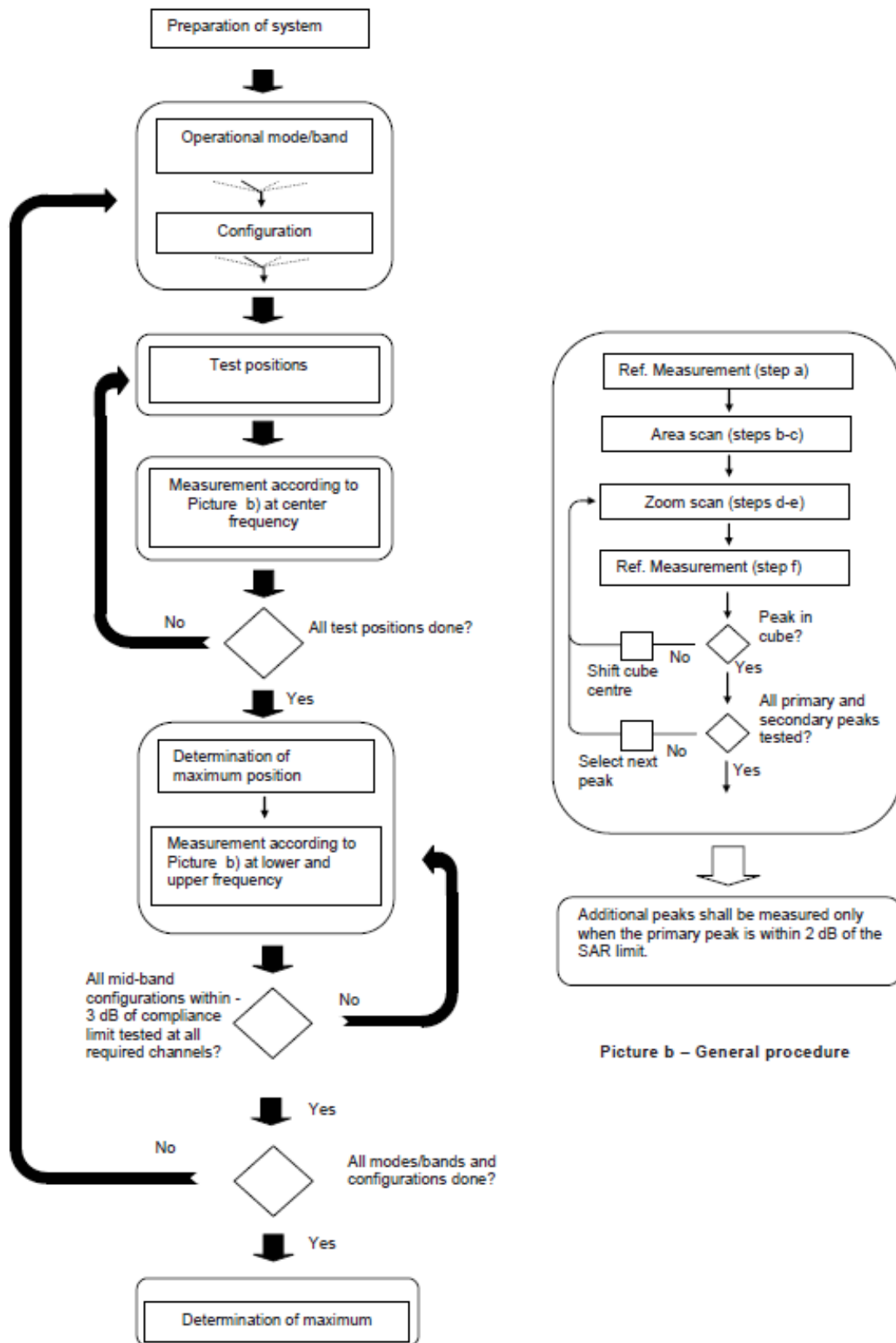

Picture a – Tests to be performed

Picture b – General procedure

Picture 9.1 Block diagram of the tests to be performed

9.2 General Measurement Procedure

The area and zoom scan resolutions specified in the table below must be applied to the SAR measurements and fully documented in SAR reports to qualify for TCB approval. Probe boundary effect error compensation is required for measurements with the probe tip closer than half a probe tip diameter to the phantom surface. Both the probe tip diameter and sensor offset distance must satisfy measurement protocols; to ensure probe boundary effect errors are minimized and the higher fields closest to the phantom surface can be correctly measured and extrapolated to the phantom surface for computing 1-g SAR. Tolerances of the post-processing algorithms must be verified by the test laboratory for the scan resolutions used in the SAR measurements, according to the reference distribution functions specified in IEEE Std 1528-2013. The results should be documented as part of the system validation records and may be requested to support test results when all the measurement parameters in the following table are not satisfied.

		≤ 3 GHz	> 3 GHz
Maximum distance from closest measurement point (geometric center of probe sensors) to phantom surface		5 ± 1 mm	$\frac{1}{2} \cdot \delta \cdot \ln(2) \pm 0.5$ mm
Maximum probe angle from probe axis to phantom surface normal at the measurement location		$30^\circ \pm 1^\circ$	$20^\circ \pm 1^\circ$
Maximum area scan spatial resolution: Δx_{Area} , Δy_{Area}		≤ 2 GHz: ≤ 15 mm 2 – 3 GHz: ≤ 12 mm	3 – 4 GHz: ≤ 12 mm 4 – 6 GHz: ≤ 10 mm
		When the x or y dimension of the test device, in the measurement plane orientation, is smaller than the above, the measurement resolution must be \leq the corresponding x or y dimension of the test device with at least one measurement point on the test device.	
Maximum zoom scan spatial resolution: Δx_{Zoom} , Δy_{Zoom}		≤ 2 GHz: ≤ 8 mm 2 – 3 GHz: ≤ 5 mm*	3 – 4 GHz: ≤ 5 mm* 4 – 6 GHz: ≤ 4 mm*
Maximum zoom scan spatial resolution, normal to phantom surface	uniform grid: $\Delta z_{Zoom}(n)$	≤ 5 mm	3 – 4 GHz: ≤ 4 mm 4 – 5 GHz: ≤ 3 mm 5 – 6 GHz: ≤ 2 mm
	graded grid	$\Delta z_{Zoom}(1)$: between 1 st two points closest to phantom surface	≤ 4 mm
		$\Delta z_{Zoom}(n>1)$: between subsequent points	$\leq 1.5 \cdot \Delta z_{Zoom}(n-1)$
Minimum zoom scan volume	x, y, z	≥ 30 mm	3 – 4 GHz: ≥ 28 mm 4 – 5 GHz: ≥ 25 mm 5 – 6 GHz: ≥ 22 mm
Note: δ is the penetration depth of a plane-wave at normal incidence to the tissue medium; see draft standard IEEE P1528-2011 for details. * When zoom scan is required and the <i>reported</i> SAR from the area scan based 1-g SAR estimation procedures of KDB 447498 is ≤ 1.4 W/kg, ≤ 8 mm, ≤ 7 mm and ≤ 5 mm zoom scan resolution may be applied, respectively, for 2 GHz to 3 GHz, 3 GHz to 4 GHz and 4 GHz to 6 GHz.			

9.3 WCDMA Measurement Procedures for SAR

The following procedures are applicable to WCDMA handsets operating under 3GPP Release99, Release 5 and Release 6. The default test configuration is to measure SAR with an established radio link between the DUT and a communication test set using a 12.2kbps RMC (reference measurement channel) configured in Test Loop Mode 1. SAR is selectively confirmed for other physical channel configurations (DPCCH & DPDCH_n), HSDPA and HSPA (HSUPA/HSDPA) modes according to output power, exposure conditions and device operating capabilities. Both uplink and downlink should be configured with the same RMC or AMR, when required. SAR for Release 5 HSDPA and Release 6 HSPA are measured using the applicable FRC (fixed reference channel) and E-DCH reference channel configurations. Maximum output power is verified according to applicable versions of 3GPP TS 34.121 and SAR must be measured according to these maximum output conditions. When Maximum Power Reduction (MPR) is not implemented according to Cubic Metric (CM) requirements for Release 6 HSPA, the following procedures do not apply.

For Release 5 HSDPA Data Devices:

Sub-test	β_c	β_d	β_d (SF)	β_c / β_d	β_{hs}	CM/dB
1	2/15	15/15	64	2/15	4/15	0.0
2	12/15	15/15	64	12/15	24/25	1.0
3	15/15	8/15	64	15/8	30/15	1.5
4	15/15	4/15	64	15/4	30/15	1.5

For Release 6 HSPA Data Devices

Sub-test	β_c	β_d	β_d (SF)	β_c / β_d	β_{hs}	β_{ec}	β_{ed}	β_{ed} (SF)	β_{ed} (codes)	CM (dB)	MPR (dB)	AG Index	E-TFCI
1	11/15	15/15	64	11/15	22/15	209/225	1039/225	4	1	1.5	1.5	20	75
2	6/15	15/15	64	6/15	12/15	12/15	12/15	4	1	1.5	1.5	12	67
3	15/15	9/15	64	15/9	30/15	30/15	$\beta_{ed1}:47/15$ $\beta_{ed2}:47/15$	4	2	1.5	1.5	15	92
4	2/15	15/15	64	2/15	4/15	4/15	56/75	4	1	1.5	1.5	17	71
5	15/15	15/15	64	15/15	24/15	30/15	134/15	4	1	1.5	1.5	21	81

Rel.8 DC-HSDPA (Cat 24)

SAR test exclusion for Rel.8 DC-HSDPA must satisfy the SAR test exclusion requirements of Rel.5 HSDPA. SAR test exclusion for DC-HSDPA devices is determined by power measurements according to the H-Set 12, Fixed Reference Channel (FRC) configuration in Table C.8.1.12 of 3GPP TS 34.121-1. A primary and a secondary serving HS-DSCH Cell are required to perform the power measurement and for the results to qualify for SAR test exclusion.

9.4 SAR Measurement for LTE

SAR tests for LTE are performed with a base station simulator, Rohde & Schwarz CMW500. Closed loop power control was used so the UE transmits with maximum output power during SAR testing. All powers were measured with the CMW 500.

It is performed for conducted power and SAR based on the KDB941225 D05.

SAR is evaluated separately according to the following procedures for the different test positions in each exposure condition – head, body, body-worn accessories and other use conditions. The procedures in the following subsections are applied separately to test each LTE frequency band.

1) QPSK with 1 RB allocation

Start with the largest channel bandwidth and measure SAR for QPSK with 1 RB allocation, using the RB offset and required test channel combination with the highest maximum output power among RB offsets at the upper edge, middle and lower edge of each required test channel. When the reported SAR is ≤ 0.8 W/kg, testing of the remaining RB offset configurations and required test channels is not required for 1 RB allocation; otherwise, SAR is required for the remaining required test channels and only for the RB offset configuration with the highest output power for that channel. When the reported SAR of a required test channel is > 1.45 W/kg, SAR is required for all three RB offset configurations for that required test channel.

2) QPSK with 50% RB allocation

The procedures required for 1 RB allocation in 1) are applied to measure the SAR for QPSK with 50% RB allocation.

3) QPSK with 100% RB allocation

For QPSK with 100% RB allocation, SAR is not required when the highest maximum output power for 100 % RB allocation is less than the highest maximum output power in 50% and 1 RB allocations and the highest reported SAR for 1 RB and 50% RB allocation in 1) and 2) are ≤ 0.8 W/kg. Otherwise, SAR is measured for the highest output power channel; and if the reported SAR is > 1.45 W/kg, the remaining required test channels must also be tested.

TDD test:

TDD testing is performed using guidance from FCC KDB 941225 D05 v02r05 and the SAR test guidance provided in April 2013 TCB works hop notes. TDD is tested at the highest duty factor using UL-DL configuration 0 with special subframe configuration 6 and applying the FDD LTE procedures in KDB 941225 D05 v02r05. SAR testing is performed using the extended cyclic prefix listed in 3GPP TS 36.211.

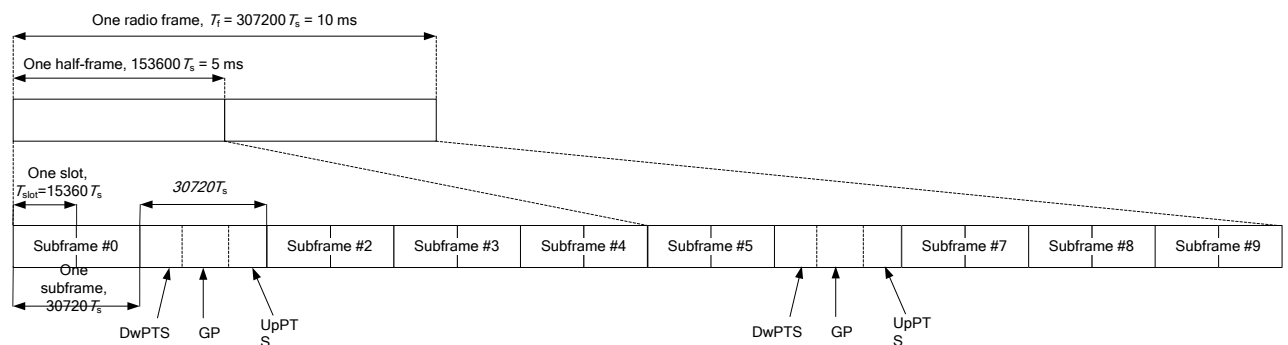

Figure 9.2: Frame structure type 2 (for 5 ms switch-point periodicity)

Table 9.1: Configuration of special subframe (lengths of DwPTS/GP/UpPTS)

Special subframe configuration	Normal cyclic prefix in downlink			Extended cyclic prefix in downlink		
	DwPTS	UpPTS		DwPTS	UpPTS	
		Normal cyclic prefix in uplink	Extended cyclic prefix in uplink		Normal cyclic prefix in uplink	Extended cyclic prefix in uplink
0	$6592 \cdot T_s$	$2192 \cdot T_s$	$2560 \cdot T_s$	$7680 \cdot T_s$	$2192 \cdot T_s$	$2560 \cdot T_s$
1	$19760 \cdot T_s$			$20480 \cdot T_s$		
2	$21952 \cdot T_s$			$23040 \cdot T_s$		
3	$24144 \cdot T_s$			$25600 \cdot T_s$		
4	$26336 \cdot T_s$	$4384 \cdot T_s$	$5120 \cdot T_s$	$7680 \cdot T_s$	$4384 \cdot T_s$	$5120 \cdot T_s$
5	$6592 \cdot T_s$			$20480 \cdot T_s$		
6	$19760 \cdot T_s$			$23040 \cdot T_s$		
7	$21952 \cdot T_s$			$12800 \cdot T_s$		
8	$24144 \cdot T_s$			-		
9	$13168 \cdot T_s$	-	-	-	-	-

Table 9.2: Uplink-downlink configurations

Uplink-downlink configuration	Downlink-to-Uplink Switch-point periodicity	Subframe number										
		0	1	2	3	4	5	6	7	8	9	
0	5 ms	D	S	U	U	U	D	S	U	U	U	
1	5 ms	D	S	U	U	D	D	S	U	U	D	
2	5 ms	D	S	U	D	D	D	S	U	D	D	
3	10 ms	D	S	U	U	U	D	D	D	D	D	
4	10 ms	D	S	U	U	D	D	D	D	D	D	
5	10 ms	D	S	U	D	D	D	D	D	D	D	
6	5 ms	D	S	U	U	U	D	S	U	U	D	

Duty factor is calculated by:

$$\begin{aligned}
 \text{Duty factor} &= \text{uplink frame} \cdot 6 + \text{UpPTS} \cdot 2 / \text{one frame length} \\
 &= (30720 \cdot T_s \cdot 6 + 5120 \cdot T_s \cdot 2) / 307200 \cdot T_s \\
 &= 0.633
 \end{aligned}$$

According to the KDB 447498 D01, SAR should be evaluated at more than 3 frequencies for devices supporting transmit bands wider than 100MHz. Oct.2014 FCC-TCB conference notes (Dec. 2014 rev.) specifies the 5 test channels to use for 3GPP band 41 SAR evaluation.

9.5 Bluetooth & Wi-Fi Measurement Procedures for SAR

Normal network operating configurations are not suitable for measuring the SAR of 802.11 transmitters in general. Unpredictable fluctuations in network traffic and antenna diversity conditions can introduce undesirable variations in SAR results. The SAR for these devices should be measured using chipset based test mode software to ensure that the results are consistent and reliable.

Chipset based test mode software is hardware dependent and generally varies among manufacturers. The device operating parameters established in a test mode for SAR measurements must be identical to those programmed in production units, including output power levels, amplifier gain settings and other RF performance tuning parameters. The test frequencies should correspond to actual channel frequencies defined for domestic use. SAR for devices with switched diversity should be measured with only one antenna transmitting at a time during each SAR measurement, according to a fixed modulation and data rate. The same data pattern should be used for all measurements.

9.6 Power Drift

To control the output power stability during the SAR test, DASY5 system calculates the power drift by measuring the E-field at the same location at the beginning and at the end of the measurement for each test position. These drift values can be found in section14 labeled as: (Power Drift [dB]). This ensures that the power drift during one measurement is within 5%.

10 Area Scan Based 1-g SAR

10.1 Requirement of KDB

According to the KDB447498 D01 v06, when the implementation is based the specific polynomial fit algorithm as presented at the 29th Bioelectromagnetics Society meeting (2007) and the estimated 1-gSAR is ≤ 1.2 W/kg, a zoom scan measurement is not required provided it is also not needed for any other purpose; for example, if the peak SAR location required for simultaneous transmission SAR test exclusion can be determined accurately by the SAR system or manually to discriminate between distinctive peaks and scattered noisy SAR distributions from area scans.

There must not be any warning or alert messages due to various measurement concerns identified by the SAR system; for example, noise in measurements, peaks too close to scan boundary, peaks are too sharp, spatial resolution and uncertainty issues etc. The SAR system verification must also demonstrate that the area scan estimated 1-g SAR is within 3% of the zoom scan 1-g SAR (See Annex B). When all the SAR results for each exposure condition in a frequency band and wireless mode are based on estimated 1-g SAR, the 1-g SAR for the highest SAR configuration must be determined by a zoom scan.

10.2 Fast SAR Algorithms

The approach is based on the area scan measurement applying a frequency dependent attenuation parameter. This attenuation parameter was empirically determined by analyzing a large number of phones. The MOTOROLA FAST SAR was developed and validated by the MOTOROLA Research Group in Ft. Lauderdale.

In the initial study, an approximation algorithm based on Linear fit was developed. The accuracy of the algorithm has been demonstrated across a broad frequency range (136-2450 MHz) and for both 1- and 10-g averaged SAR using a sample of 264 SAR measurements from 55 wireless handsets. For the sample size studied, the root-mean-squared errors of the algorithm are 1.2% and 5.8% for 1- and 10-g averaged SAR, respectively. The paper describing the algorithm in detail is expected to be published in August 2004 within the Special Issue of Transactions on MTT.

In the second step, the same research group optimized the fitting algorithm to an Polynomial fit whereby the frequency validity was extended to cover the range 30-6000MHz. Details of this study can be found in the BEMS 2007 Proceedings.

Both algorithms are implemented in DASY software.

11 Conducted Output Power

For Main antenna, there are three sets of tune-up power, Receiver on, Receiver off+Hotspot on and Receiver off+Hotspot off.

Table1: Summary of Receiver detection mechanism

Antenna	Receiver on (head scenario)	Receiver off + Hotspot on (Body/other scenario)	Receiver off +Hotspot off (Body/other scenario)
Main antenna	Power Level A1	Power Level B1	Power Level C1

11.1 GSM Measurement result

During the process of testing, the EUT was controlled via R&S Digital Radio Communication tester (CMW500) to ensure the maximum power transmission and proper modulation. This result contains conducted output power for the EUT. In all cases, the measured peak output power should be greater and within 5% than EMI measurement.

Table 11.1-1: The conducted power measurement results for GSM, GPRS and EGPRS Level A1/B1/C1

GSM 850 Speech (GMSK)	Measured Power (dBm)			Tune up	calculation	Averaged Power (dBm)		
	251	190	128			251	190	128
1 Txslot	32.12	32.14	32.15	33.50	/	/	/	/
GSM 850 GPRS (GMSK)	Measured Power (dBm)				calculation	Averaged Power (dBm)		
	251	190	128			251	190	128
1 Txslot	32.09	32.12	32.13	33.50	-9.03	23.06	23.09	23.10
2 Txslots	30.61	30.63	30.64	31.50	-6.02	24.59	24.61	24.62
3Txslots	28.51	28.56	28.61	29.50	-4.26	24.25	24.30	24.35
4 Txslots	26.46	26.53	26.57	27.50	-3.01	23.45	23.52	23.56
GSM 850 EGPRS (GMSK)	Measured Power (dBm)				calculation	Averaged Power (dBm)		
	251	190	128			251	190	128
1 Txslot	32.04	32.06	32.07	33.50	-9.03	23.01	23.03	23.04
2 Txslots	30.57	30.58	30.59	31.50	-6.02	24.55	24.56	24.57
3Txslots	28.47	28.51	28.55	29.50	-4.26	24.21	24.25	24.29
4 Txslots	26.42	26.47	26.51	27.50	-3.01	23.41	23.46	23.50
GSM 850 EGPRS (8PSK)	Measured Power (dBm)				calculation	Averaged Power (dBm)		
	251	190	128			251	190	128
1 Txslot	26.23	26.22	26.33	27.50	-9.03	17.20	17.19	17.30
2 Txslots	25.35	24.11	24.20	25.50	-6.02	19.33	18.09	18.18
3Txslots	21.80	21.86	21.97	23.50	-4.26	17.54	17.60	17.71
4 Txslots	19.58	19.62	19.74	21.50	-3.01	16.57	16.61	16.73
PCS1900 Speech (GMSK)	Measured Power (dBm)			Tune up	calculation	Averaged Power (dBm)		
	810	661	512			810	661	512

1 Txslot	17.38	17.41	17.25	18.00	/	/	/	/
PCS1900 GPRS (GMSK)	Measured Power (dBm)				calculation	Averaged Power (dBm)		
	810	661	512			810	661	512
1 Txslot	29.25	29.33	29.28	31.00	-9.03	20.22	20.30	20.25
2 Txslots	27.48	27.36	27.20	29.00	-6.02	21.46	21.34	21.18
3Txslots	25.54	25.38	25.18	27.00	-4.26	21.28	21.12	20.92
4 Txslots	23.56	23.39	23.14	25.00	-3.01	20.55	20.38	20.13
PCS1900 EGPRS (GMSK)	Measured Power (dBm)				calculation	Averaged Power (dBm)		
	810	661	512			810	661	512
1 Txslot	29.24	29.33	29.26	31.00	-9.03	20.21	20.30	20.23
2 Txslots	27.47	27.35	27.19	29.00	-6.02	21.45	21.33	21.17
3Txslots	25.54	25.37	25.17	27.00	-4.26	21.28	21.11	20.91
4 Txslots	23.55	23.38	23.13	25.00	-3.01	20.54	20.37	20.12
PCS1900 EGPRS (8PSK)	Measured Power (dBm)				calculation	Averaged Power (dBm)		
	810	661	512			810	661	512
1 Txslot	25.09	25.08	25.07	26.50	-9.03	16.06	16.05	16.04
2 Txslots	23.68	23.01	22.96	24.50	-6.02	17.66	16.99	16.94
3Txslots	20.75	20.82	20.76	22.50	-4.26	16.49	16.56	16.50
4 Txslots	18.58	18.67	18.59	20.50	-3.01	15.57	15.66	15.58

NOTES:

1) Division Factors

To average the power, the division factor is as follows:

1TX-slot = 1 transmit time slot out of 8 time slots=> conducted power divided by (8/1) => -9.03dB

2TX-slots = 2 transmit time slots out of 8 time slots=> conducted power divided by (8/2) => -6.02dB

3TX-slots = 3 transmit time slots out of 8 time slots=> conducted power divided by (8/3) => -4.26dB

4TX-slots = 4 transmit time slots out of 8 time slots=> conducted power divided by (8/4) => -3.01dB

According to the conducted power as above, the body measurements are performed with 2Txslots for GSM850 and GSM1900.

11.2 WCDMA Measurement result

Table 11.2-1: The conducted Power for WCDMA- Power Level A1/B1/C1

Item	band	FDDV result			
	ARFCN	4233 (846.6MHz)	4182 (836.4MHz)	4132 (826.4MHz)	Tune up
WCDMA	\	22.95	22.93	22.82	24
HSUPA	1	19.39	19.36	19.36	21
	2	19.41	19.36	19.38	21
	3	20.4	20.36	20.37	22
	4	18.92	18.91	18.90	20.5
	5	20.39	20.36	20.35	22
HSPA+		21	20.89	20.88	22.5
DC-HSDPA	1	21.37	21.35	21.36	23
	2	21.35	21.36	21.30	23
	3	20.85	20.88	20.86	22.5
	4	20.84	20.86	20.85	22.5

Table 11.2-2: The conducted Power for WCDMA- Power Level A1

Item	band	FDDIV result			
	ARFCN	1513 (1752.6MHz)	1412(1732.4MHz)	1312 (1712.4MHz)	Tune up
WCDMA	\	23.85	23.81	23.89	25
HSUPA	1	21.4	21.35	21.42	22
	2	21.1	21.11	21.12	22
	3	22.08	22.09	22.10	23
	4	20.8	20.82	20.83	21.5
	5	22.2	22.19	22.22	23
HSPA+		22.88	22.85	22.80	23
DC-HSDPA	1	23.18	23.20	23.22	23.5
	2	23.2	23.21	23.24	23.5
	3	22.75	22.76	22.76	23.5
	4	22.74	22.77	22.76	23.5
Item	band	FDDII result			
	ARFCN	9538 (1907.6MHz)	9400 (1880MHz)	9262 (1852.4MHz)	Tune up
WCDMA	\	24.02	24.03	24.10	25
HSUPA	1	21.3	21.46	21.35	22
	2	21.28	21.24	21.36	22
	3	22.26	22.23	22.33	23
	4	20.76	20.75	20.80	21.5
	5	22.16	22.18	22.23	23
HSPA+		22.8	22.82	22.86	23
DC-HSDPA	1	23.28	23.30	23.33	23.5
	2	23.26	23.31	23.36	23.5
	3	22.8	22.82	22.84	23.5
	4	22.79	22.81	22.82	23.5

Table 11.2-3: The conducted Power for WCDMA- Power Level B1/C1

Item	band	FDDIV result- Power Level B1			
	ARFCN	1513 (1752.6MHz)	1412(1732.4MHz)	1312 (1712.4MHz)	Tune up
WCDMA	\	19.88	19.90	19.88	21
HSUPA	1	17.63	17.55	17.65	18
	2	17.33	17.26	17.32	18
	3	18.25	18.26	18.24	19
	4	16.88	16.90	16.87	17.5
	5	18.24	18.25	18.25	19
HSPA+		18.9	18.88	18.83	19
DC-HSDPA	1	19.25	19.28	19.26	19.5
	2	19.24	19.26	19.25	19.5
	3	18.75	18.76	18.74	19.5
	4	18.76	18.75	18.73	19.5
Item	band	FDDII result- Power Level B1/C1			
	ARFCN	9538 (1907.6MHz)	9400 (1880MHz)	9262 (1852.4MHz)	Tune up
WCDMA	\	22.91	22.95	22.93	24
HSUPA	1	20.29	20.71	20.35	22
	2	20.26	20.22	20.33	22
	3	21.24	21.25	21.29	23
	4	19.72	19.73	19.77	21.5
	5	21.16	21.19	21.23	23
HSPA+		21.79	21.80	21.87	23
DC-HSDPA	1	22.24	22.32	22.38	23.5
	2	22.26	22.33	22.40	23.5
	3	21.79	21.82	21.85	23.5
	4	21.8	21.81	21.84	23.5

Table 11.2-4: The conducted Power for WCDMA- Power Level C1

Item	band	FDDIV result			
	ARFCN	1513 (1752.6MHz)	1412(1732.4MHz)	1312 (1712.4MHz)	Tune up
WCDMA	\	22.90	22.91	22.89	23
HSUPA	1	20.43	20.35	20.44	21.5
	2	20.09	20.11	20.11	21.5
	3	21.05	21.08	21.06	21
	4	19.77	19.79	19.78	21
	5	21.24	21.23	21.19	21.5
HSPA+		21.91	21.84	21.81	22
DC-HSDPA	1	22.21	22.25	22.25	22.5
	2	22.23	22.26	22.26	22.5
	3	21.76	21.78	21.77	22
	4	21.75	21.77	21.76	22

11.3 LTE Measurement result

Table 11.3-1: Maximum Power Reduction (MPR) for LTE

Modulation	Channel bandwidth / Transmission bandwidth configuration [RB]						MPR (dB)
	1.4 MHz	3 MHz	5 MHz	10 MHz	15 MHz	20 MHz	
QPSK	> 5	> 4	> 8	> 12	> 16	> 18	1
16 QAM	≤ 5	≤ 4	≤ 8	≤ 12	≤ 16	≤ 18	1
16 QAM	> 5	> 4	> 8	> 12	> 16	> 18	2
64 QAM	≤ 5	≤ 4	≤ 8	≤ 12	≤ 16	≤ 18	2
64 QAM	> 5	> 4	> 8	> 12	> 16	> 18	3

Table 11.3-2: The tune up for LTE

Band	Tune up
LTE Band 12 Power Level A1/B1/C1	25.5
LTE Band 13 Power Level A1/B1/C1	25.5
LTE Band 25 Power Level A1	25
LTE Band 25 Power Level B1	23
LTE Band 25 Power Level C1	24
LTE Band 26 Power Level A1/B1/C1	25.5
LTE Band 41 Power Level A1/C1	24
LTE Band 41 Power Level B1	23
LTE Band 41(HPUE) Power Level A1/C1	27
LTE Band 41(HPUE) Power Level B1	25
LTE Band 66 Power Level A1	25
LTE Band 66 Power Level B1	20
LTE Band 66 Power Level C1	23
LTE Band 71 Power Level A1/B1/C1	25.5

Power Level A1/B1/C1

Band 12					
Bandwidth (MHz)	RB allocation	Frequency (MHz)	QPSK	16QAM	64QAM
	RB offset (Start RB)		Actual output power (dBm)	Actual output power (dBm)	Actual output power (dBm)
1.4MHz	1RB-High (5)	715.3	24.36	23.60	22.56
		707.5	24.41	23.60	22.57
		699.7	24.50	23.61	22.58
	1RB-Middle (3)	715.3	24.46	23.66	22.54
		707.5	24.43	23.67	22.64
		699.7	24.50	23.80	22.67
	1RB-Low (0)	715.3	24.35	23.52	22.52
		707.5	24.41	23.62	22.58
		699.7	24.45	23.75	22.66
	3RB-High (3)	715.3	24.44	23.34	22.50
		707.5	24.47	23.50	22.57
		699.7	24.56	23.59	22.69
	3RB-Middle (1)	715.3	24.51	23.43	22.61
		707.5	24.52	23.56	22.64
		699.7	24.58	23.63	22.69
	3RB-Low (0)	715.3	24.45	23.43	22.51
		707.5	24.44	23.42	22.57
		699.7	24.56	23.56	22.65
	6RB (0)	715.3	23.47	22.55	21.46
		707.5	23.49	22.61	21.51
		699.7	23.50	22.68	21.56
3MHz	1RB-High (14)	714.5	24.41	23.60	22.55
		707.5	24.46	23.70	22.56
		700.5	23.98	23.84	22.66
	1RB-Middle (7)	714.5	24.60	23.87	22.73
		707.5	24.61	23.82	22.77
		700.5	24.67	23.87	22.77
	1RB-Low (0)	714.5	24.45	23.70	22.66
		707.5	24.50	23.74	22.64
		700.5	24.55	23.71	22.77
	8RB-High (7)	714.5	23.40	22.49	21.51
		707.5	23.47	22.55	21.54
		700.5	23.54	22.69	21.68
	8RB-Middle (4)	714.5	23.48	22.58	22.00
		707.5	23.49	22.60	21.60
		700.5	23.59	22.73	21.65
	8RB-Low (0)	714.5	23.44	22.55	21.52
		707.5	23.51	22.59	21.57
		700.5	23.53	22.66	21.88
	15RB (0)	714.5	23.46	22.47	21.47
		707.5	23.53	22.52	21.53
		700.5	23.57	22.60	21.59

5MHz	1RB-High (24)	713.5	24.36	23.64	22.55	
		707.5	24.47	23.70	22.58	
		701.5	24.48	23.70	22.63	
	1RB-Middle (12)	713.5	24.66	23.85	22.74	
		707.5	24.57	23.81	22.78	
		701.5	24.63	23.93	22.87	
	1RB-Low (0)	713.5	24.42	23.64	22.59	
		707.5	24.44	23.62	22.62	
		701.5	24.49	23.77	22.62	
	12RB-High (13)	713.5	23.45	22.44	21.46	
		707.5	23.46	22.50	21.52	
		701.5	23.59	22.61	21.63	
	12RB-Middle (6)	713.5	23.52	22.56	21.57	
		707.5	23.53	22.59	21.58	
		701.5	23.63	22.62	21.62	
	12RB-Low (0)	713.5	23.52	22.48	21.52	
		707.5	23.57	22.58	21.63	
		701.5	23.52	22.55	21.58	
	25RB (0)	713.5	23.49	22.48	21.51	
		707.5	23.51	22.53	21.56	
		701.5	23.57	22.61	21.60	
	10MHz	1RB-High (49)	711	24.47	23.55	22.57
			707.5	24.48	23.66	22.62
			704	24.48	23.67	22.63
1RB-Middle (24)		711	24.62	23.81	22.76	
		707.5	24.62	23.88	22.76	
		704	24.70	23.90	22.86	
1RB-Low (0)		711	24.57	23.85	22.67	
		707.5	24.59	23.86	22.68	
		704	24.58	23.85	22.67	
25RB-High (25)		711	23.58	22.58	21.57	
		707.5	23.55	22.56	21.58	
		704	23.55	22.60	21.58	
25RB-Middle (12)		711	23.63	22.65	21.63	
		707.5	23.62	22.62	21.64	
		704	23.62	22.65	21.65	
25RB-Low (0)		711	23.74	22.72	21.72	
		707.5	23.55	22.58	21.60	
		704	23.53	22.57	21.54	
50RB (0)		711	23.67	22.68	21.66	
		707.5	23.55	22.58	21.58	
		704	23.55	22.57	21.56	

Power Level A1/B1/C1

Band 13					
Bandwidth (MHz)	RB allocation	Frequency (MHz)	QPSK	16QAM	64QAM
	RB offset (Start RB)		Actual output power (dBm)	Actual output power (dBm)	Actual output power (dBm)
5MHz	1RB-High (24)	784.5	24.07	23.32	22.24
		782	24.11	23.32	22.29
		779.5	24.07	23.31	22.23
	1RB-Middle (12)	784.5	24.30	23.60	22.55
		782	24.30	23.46	22.39
		779.5	24.25	23.45	22.37
	1RB-Low (0)	784.5	24.12	23.36	22.32
		782	24.13	23.31	22.31
		779.5	24.12	23.25	22.21
	12RB-High (13)	784.5	23.17	22.18	21.21
		782	23.19	22.25	21.26
		779.5	23.19	22.25	21.24
	12RB-Middle (6)	784.5	23.25	22.24	21.28
		782	23.21	22.27	21.27
		779.5	23.19	22.23	21.24
	12RB-Low (0)	784.5	23.23	22.24	21.26
		782	23.18	22.21	21.25
		779.5	23.08	22.11	21.14
25RB (0)	784.5	23.19	22.24	21.24	
	782	23.19	22.22	21.23	
	779.5	23.16	22.21	21.19	
10MHz	1RB-High	782	24.10	23.38	22.25
	1RB-Middle	782	24.25	23.49	22.41
	1RB-Low (0)	782	24.19	23.42	22.35
	25RB-High	782	23.21	22.26	21.27
	25RB-Middle	782	23.24	22.26	21.28
	25RB-Low	782	23.18	22.22	21.21
	50RB (0)	782	23.19	22.24	21.22

Power Level A1

Band 25						
Bandwidth (MHz)	RB allocation	Frequency (MHz)	Actual output power (dBm)			
	RB offset		QPSK	16QAM	64QAM	
1.4MHz	1RB-High (5)	1914.3	24.06	23.26	22.13	
		1882.5	24.05	23.22	22.17	
		1850.7	24.07	23.38	22.21	
	1RB-Middle (3)	1914.3	24.13	23.46	22.25	
		1882.5	24.15	23.31	22.25	
		1850.7	24.18	23.49	22.29	
	1RB-Low (0)	1914.3	24.06	23.25	22.18	
		1882.5	24.05	23.37	22.13	
		1850.7	24.05	23.25	22.24	
	3RB-High (3)	1914.3	24.19	23.10	22.19	
		1882.5	24.16	23.04	22.15	
		1850.7	24.20	23.18	22.24	
	3RB-Middle (1)	1914.3	24.24	23.15	22.25	
		1882.5	24.18	23.14	22.20	
		1850.7	24.20	23.12	22.25	
	3RB-Low (0)	1914.3	24.19	23.15	22.17	
		1882.5	24.11	23.10	22.23	
		1850.7	24.16	23.17	22.21	
	6RB (0)	1914.3	23.21	22.24	21.17	
		1882.5	23.14	22.19	21.08	
		1850.7	23.19	22.26	21.15	
	3MHz	1RB-High (14)	1913.5	24.19	23.36	22.28
			1882.5	24.12	23.31	22.20
			1851.5	24.17	23.50	22.30
		1RB-Middle (7)	1913.5	24.32	23.59	22.32
			1882.5	24.30	23.35	22.43
			1851.5	24.28	23.53	22.40
1RB-Low (0)		1913.5	24.17	23.42	22.25	
		1882.5	24.13	23.34	22.21	
		1851.5	24.18	23.41	22.30	
8RB-High (7)		1913.5	23.20	22.20	21.18	
		1882.5	23.14	22.16	21.14	
		1851.5	23.16	22.20	21.18	
8RB-Middle (4)		1913.5	23.21	22.23	21.20	
		1882.5	23.17	22.21	21.15	
		1851.5	23.20	22.24	21.23	
8RB-Low (0)		1913.5	23.21	22.22	21.19	
		1882.5	23.14	22.21	21.15	
		1851.5	23.17	22.23	21.19	
15RB (0)		1913.5	23.20	22.18	21.14	

		1882.5	23.14	22.13	21.10	
		1851.5	23.13	22.16	21.11	
5MHz	1RB-High (24)	1912.5	24.18	23.43	22.27	
		1882.5	24.14	23.34	22.24	
		1852.5	24.15	23.36	22.31	
	1RB-Middle (12)	1912.5	24.34	23.56	22.44	
		1882.5	24.32	23.56	22.43	
		1852.5	24.39	23.49	22.42	
	1RB-Low (0)	1912.5	24.16	23.37	22.26	
		1882.5	24.14	23.43	22.34	
		1852.5	24.18	23.47	22.36	
	12RB-High (13)	1912.5	23.16	22.21	21.26	
		1882.5	23.18	22.17	21.18	
		1852.5	23.21	22.22	21.20	
	12RB-Middle (6)	1912.5	23.29	22.26	21.36	
		1882.5	23.22	22.25	21.21	
		1852.5	23.28	22.27	21.26	
	12RB-Low (0)	1912.5	23.28	22.28	21.32	
		1882.5	23.20	22.17	21.22	
		1852.5	23.24	22.26	21.23	
	25RB (0)	1912.5	23.28	22.25	21.31	
		1882.5	23.21	22.20	21.20	
		1852.5	23.23	22.26	21.21	
	10MHz	1RB-High (49)	1910	24.16	23.34	22.21
			1882.5	24.07	23.31	22.30
			1855	24.15	23.42	22.46
1RB-Middle (24)		1910	24.25	23.44	22.27	
		1882.5	24.19	23.46	22.39	
		1855	24.25	23.53	22.43	
1RB-Low (0)		1910	24.15	23.32	22.25	
		1882.5	24.12	23.42	22.32	
		1855	24.18	23.47	22.40	
25RB-High (25)		1910	23.12	22.53	21.12	
		1882.5	23.15	22.18	21.16	
		1855	23.22	22.24	21.21	
25RB-Middle (12)		1910	23.21	22.21	21.22	
		1882.5	23.17	22.21	21.17	
		1855	23.22	22.25	21.23	
25RB-Low (0)		1910	23.29	22.25	21.26	
		1882.5	23.18	22.21	21.20	
		1855	23.24	22.28	21.25	
50RB (0)		1910	23.22	22.19	21.21	
		1882.5	23.18	22.19	21.18	
		1855	23.27	22.27	21.24	
15MHz		1RB-High (74)	1907.5	24.12	23.31	22.23
			1882.5	24.09	23.30	22.29
			1857.5	24.15	23.44	22.42
	1RB-Middle	1907.5	24.13	23.39	22.24	

	(37)	1882.5	24.11	23.38	22.28
		1857.5	24.18	23.50	22.43
	1RB-Low (0)	1907.5	24.16	23.48	22.31
		1882.5	24.13	23.49	22.64
		1857.5	24.16	23.48	22.38
	36RB-High (38)	1907.5	23.18	22.14	21.17
		1882.5	23.56	22.17	21.14
		1857.5	23.24	22.20	21.22
	36RB-Middle (19)	1907.5	23.26	22.21	21.26
		1882.5	23.19	22.20	21.21
		1857.5	23.22	22.23	21.21
	36RB-Low (0)	1907.5	23.22	22.24	21.24
		1882.5	23.18	22.18	21.19
		1857.5	23.24	22.24	21.24
	75RB (0)	1907.5	23.20	22.18	21.19
1882.5		23.16	22.16	21.15	
1857.5		23.22	22.24	21.46	
20MHz	1RB-High (99)	1905	24.04	23.16	22.14
		1882.5	24.01	23.22	22.13
		1860	24.03	23.42	22.29
	1RB-Middle (50)	1905	24.09	23.43	22.28
		1882.5	24.05	23.38	22.24
		1860	24.10	23.38	22.40
	1RB-Low (0)	1905	24.09	23.44	22.31
		1882.5	24.01	23.29	22.24
		1860	24.04	23.33	22.23
	50RB-High (50)	1905	23.00	21.92	20.94
		1882.5	23.02	22.03	21.01
		1860	23.11	22.12	21.10
	50RB-Middle (25)	1905	23.14	22.16	21.13
		1882.5	23.09	22.10	21.09
		1860	23.15	22.15	21.13
	50RB-Low (0)	1905	23.13	22.17	21.14
		1882.5	23.02	22.06	21.04
		1860	23.12	22.13	21.11
	100RB (0)	1905	23.06	22.07	21.04
		1882.5	23.00	21.99	21.00
		1860	23.12	22.11	21.08

Power Level B1

Band 25						
Bandwidth (MHz)	RB allocation	Frequency (MHz)	Actual output power (dBm)			
	RB offset		QPSK	16QAM	64QAM	
1.4MHz	1RB-High (5)	1914.3	21.99	22.25	22.06	
		1882.5	21.99	22.24	22.07	
		1850.7	22.02	22.35	22.15	
	1RB-Middle (3)	1914.3	22.10	22.29	22.19	
		1882.5	22.10	22.27	22.23	
		1850.7	22.13	22.31	22.20	
	1RB-Low (0)	1914.3	21.99	22.14	22.22	
		1882.5	21.98	22.19	22.07	
		1850.7	22.01	22.23	22.21	
	3RB-High (3)	1914.3	22.07	22.02	22.12	
		1882.5	22.06	22.06	22.16	
		1850.7	22.14	22.11	22.19	
	3RB-Middle (1)	1914.3	22.13	22.10	22.17	
		1882.5	22.11	22.12	22.14	
		1850.7	22.17	22.14	22.23	
	3RB-Low (0)	1914.3	22.10	21.99	22.13	
		1882.5	22.10	22.06	22.14	
		1850.7	22.12	22.08	22.20	
	6RB (0)	1914.3	22.10	22.18	22.09	
		1882.5	22.09	22.17	21.05	
		1850.7	22.15	22.19	21.13	
	3MHz	1RB-High (14)	1913.5	22.03	22.22	22.18
			1882.5	22.04	22.34	22.02
			1851.5	22.05	22.37	22.26
		1RB-Middle (7)	1913.5	22.11	22.40	22.27
			1882.5	22.15	22.39	22.24
			1851.5	22.18	22.44	22.32
1RB-Low (0)		1913.5	22.02	22.32	22.16	
		1882.5	22.05	22.35	22.16	
		1851.5	22.08	22.27	22.18	
8RB-High (7)		1913.5	22.05	22.09	21.14	
		1882.5	22.05	22.08	21.04	
		1851.5	22.08	22.13	21.11	
8RB-Middle (4)		1913.5	22.07	22.12	21.12	
		1882.5	22.05	22.09	21.07	
		1851.5	22.09	22.12	21.12	
8RB-Low (0)		1913.5	22.06	22.12	21.14	
		1882.5	22.03	22.10	21.05	
		1851.5	22.09	22.09	21.10	
15RB (0)		1913.5	22.06	22.08	21.08	

		1882.5	22.02	22.03	20.99	
		1851.5	22.06	22.08	21.03	
5MHz	1RB-High (24)	1912.5	22.04	22.18	22.10	
		1882.5	21.97	22.14	22.13	
		1852.5	22.01	22.30	22.12	
	1RB-Middle (12)	1912.5	22.17	22.26	22.30	
		1882.5	22.16	22.49	22.31	
		1852.5	22.21	22.34	22.36	
	1RB-Low (0)	1912.5	22.00	22.28	22.07	
		1882.5	21.95	22.34	22.13	
		1852.5	22.04	22.32	22.19	
	12RB-High (13)	1912.5	22.04	22.04	21.09	
		1882.5	22.03	22.02	21.02	
		1852.5	22.08	22.05	21.06	
	12RB-Middle (6)	1912.5	22.14	22.13	21.20	
		1882.5	22.10	22.08	21.07	
		1852.5	22.14	22.13	21.13	
	12RB-Low (0)	1912.5	22.11	22.10	21.18	
		1882.5	22.08	22.04	21.04	
		1852.5	22.12	22.07	21.09	
	25RB (0)	1912.5	22.08	22.11	21.11	
		1882.5	22.05	22.03	21.02	
		1852.5	22.10	22.09	21.08	
	10MHz	1RB-High (49)	1910	22.01	22.28	22.16
			1882.5	21.95	22.26	22.05
			1855	22.07	22.44	22.29
1RB-Middle (24)		1910	22.05	22.32	22.16	
		1882.5	22.11	22.24	22.24	
		1855	22.09	22.32	22.30	
1RB-Low (0)		1910	22.04	22.29	22.16	
		1882.5	22.04	22.31	22.18	
		1855	22.07	22.39	22.17	
25RB-High (25)		1910	21.97	21.99	21.02	
		1882.5	22.03	22.04	21.02	
		1855	22.09	22.10	21.09	
25RB-Middle (12)		1910	22.07	22.05	21.07	
		1882.5	22.06	22.06	21.02	
		1855	22.10	22.11	21.07	
25RB-Low (0)		1910	22.14	22.11	21.13	
		1882.5	22.08	22.08	21.05	
		1855	22.14	22.14	21.11	
50RB (0)		1910	22.04	22.06	21.35	
		1882.5	22.07	22.07	21.04	
		1855	22.12	22.11	21.11	
15MHz		1RB-High (74)	1907.5	22.02	22.33	22.13
			1882.5	22.02	22.25	22.15
			1857.5	22.07	22.44	22.30
	1RB-Middle	1907.5	22.06	22.32	22.17	

	(37)	1882.5	22.05	22.25	22.20
		1857.5	22.11	22.33	22.27
	1RB-Low (0)	1907.5	22.09	22.40	22.28
		1882.5	22.07	22.40	22.27
		1857.5	22.08	22.36	22.27
	36RB-High (38)	1907.5	22.05	22.01	21.06
		1882.5	22.08	22.04	21.03
		1857.5	22.14	22.11	21.12
	36RB-Middle (19)	1907.5	22.11	22.10	21.13
		1882.5	22.11	22.05	21.06
		1857.5	22.12	22.10	21.09
	36RB-Low (0)	1907.5	22.18	22.11	21.34
		1882.5	22.07	22.11	21.08
		1857.5	22.14	22.08	21.32
	75RB (0)	1907.5	22.07	22.07	21.08
		1882.5	22.07	22.08	21.05
		1857.5	22.11	22.11	21.07
	20MHz	1RB-High (99)	1905	22.20	22.45
1882.5			22.22	22.49	22.27
1860			22.17	22.48	22.32
1RB-Middle (50)		1905	22.32	22.42	22.39
		1882.5	22.27	22.41	22.30
		1860	22.36	22.47	22.36
1RB-Low (0)		1905	22.27	22.48	22.35
		1882.5	22.22	22.39	22.31
		1860	22.26	22.47	22.39
50RB-High (50)		1905	22.11	22.08	21.07
		1882.5	22.19	22.14	21.10
		1860	22.26	22.24	21.18
50RB-Middle (25)		1905	22.31	22.29	21.24
		1882.5	22.24	22.22	21.17
		1860	22.32	22.24	21.19
50RB-Low (0)		1905	22.27	22.29	21.25
		1882.5	22.21	22.19	21.11
		1860	22.29	22.22	21.18
100RB (0)		1905	22.24	22.19	21.15
		1882.5	22.21	22.14	21.07
		1860	22.25	22.19	21.15

Power Level /C1

Band 25						
Bandwidth (MHz)	RB allocation	Frequency (MHz)	Actual output power (dBm)			
	RB offset		QPSK	16QAM	64QAM	
1.4MHz	1RB-High (5)	1914.3	22.99	23.26	22.15	
		1882.5	22.95	23.20	22.10	
		1850.7	23.00	23.21	22.19	
	1RB-Middle (3)	1914.3	23.09	23.27	22.30	
		1882.5	23.04	23.39	22.17	
		1850.7	23.12	23.39	22.28	
	1RB-Low (0)	1914.3	22.98	23.24	22.18	
		1882.5	22.97	23.22	22.17	
		1850.7	22.96	23.33	22.20	
	3RB-High (3)	1914.3	23.08	23.06	22.11	
		1882.5	23.08	23.08	22.13	
		1850.7	23.09	23.10	22.17	
	3RB-Middle (1)	1914.3	23.16	23.17	22.21	
		1882.5	23.14	23.11	22.21	
		1850.7	23.18	23.14	22.21	
	3RB-Low (0)	1914.3	23.11	23.10	22.16	
		1882.5	23.06	23.09	22.13	
		1850.7	23.13	23.09	22.19	
	6RB (0)	1914.3	23.15	22.15	21.14	
		1882.5	23.05	22.20	21.04	
		1850.7	23.12	22.20	21.12	
	3MHz	1RB-High (14)	1913.5	23.00	23.25	22.17
			1882.5	22.98	23.23	22.13
			1851.5	23.05	23.40	22.18
		1RB-Middle (7)	1913.5	23.19	23.35	22.36
			1882.5	23.22	23.48	22.32
			1851.5	23.18	23.54	22.37
1RB-Low (0)		1913.5	23.01	23.36	22.17	
		1882.5	22.98	23.25	22.12	
		1851.5	23.03	23.32	22.27	
8RB-High (7)		1913.5	23.05	22.10	21.11	
		1882.5	23.03	22.09	21.02	
		1851.5	23.06	22.13	21.12	
8RB-Middle (4)		1913.5	23.10	22.12	21.14	
		1882.5	23.05	22.10	21.05	
		1851.5	23.10	22.13	21.13	
8RB-Low (0)		1913.5	23.09	22.13	21.14	
		1882.5	23.04	22.09	21.07	
		1851.5	23.06	22.13	21.12	
15RB (0)		1913.5	23.06	22.05	21.10	

		1882.5	23.03	22.04	21.00
		1851.5	23.06	22.07	21.06
5MHz	1RB-High (24)	1912.5	22.99	23.30	22.16
		1882.5	22.94	23.32	22.06
		1852.5	22.99	23.35	22.22
	1RB-Middle (12)	1912.5	23.16	23.48	22.32
		1882.5	23.07	23.43	22.41
		1852.5	23.14	23.38	22.39
	1RB-Low (0)	1912.5	22.98	23.16	22.16
		1882.5	22.96	23.30	22.20
		1852.5	23.01	23.28	22.20
	12RB-High (13)	1912.5	22.99	22.04	21.08
		1882.5	23.03	22.01	21.03
		1852.5	23.07	22.04	21.09
	12RB-Middle (6)	1912.5	23.12	22.13	21.16
		1882.5	23.07	22.11	21.09
		1852.5	23.12	22.07	21.12
	12RB-Low (0)	1912.5	23.11	22.08	21.13
		1882.5	23.02	22.02	21.05
		1852.5	23.10	22.10	21.08
	25RB (0)	1912.5	23.10	22.12	21.12
		1882.5	23.03	22.04	21.00
		1852.5	23.09	22.10	21.08
10MHz	1RB-High (49)	1910	23.00	23.22	22.17
		1882.5	22.96	23.16	22.21
		1855	23.02	23.35	22.21
	1RB-Middle (24)	1910	23.10	23.24	22.21
		1882.5	23.05	23.26	22.18
		1855	23.11	23.35	22.37
	1RB-Low (0)	1910	23.01	23.35	22.20
		1882.5	22.97	23.35	22.19
		1855	23.03	23.33	22.22
	25RB-High (25)	1910	23.01	22.00	21.00
		1882.5	23.02	22.04	21.01
		1855	23.10	22.09	21.09
	25RB-Middle (12)	1910	23.09	22.09	21.09
		1882.5	23.02	22.05	21.03
		1855	23.08	22.10	21.10
	25RB-Low (0)	1910	23.15	22.12	21.12
		1882.5	23.04	22.06	21.04
		1855	23.11	22.14	21.12
	50RB (0)	1910	23.08	22.04	21.06
		1882.5	23.05	22.06	21.02
		1855	23.12	22.12	21.12
15MHz	1RB-High (74)	1907.5	23.02	23.23	22.25
		1882.5	22.99	23.28	22.20
		1857.5	23.10	23.44	22.26
	1RB-Middle	1907.5	23.06	23.29	22.12

	(37)	1882.5	23.01	23.31	22.16
		1857.5	23.07	23.39	22.36
	1RB-Low (0)	1907.5	23.07	23.43	22.37
		1882.5	23.03	23.28	22.22
		1857.5	23.06	23.34	22.27
	36RB-High (38)	1907.5	23.09	22.02	21.07
		1882.5	23.07	22.06	21.05
		1857.5	23.13	22.09	21.12
	36RB-Middle (19)	1907.5	23.17	22.12	21.14
		1882.5	23.08	22.08	21.09
		1857.5	23.11	22.08	21.10
	36RB-Low (0)	1907.5	23.13	22.13	21.14
		1882.5	23.11	22.07	21.06
		1857.5	23.15	22.12	21.13
	75RB (0)	1907.5	23.12	22.08	21.10
		1882.5	23.07	22.06	21.02
		1857.5	23.11	22.12	21.09
	20MHz	1RB-High (99)	1905	23.03	23.27
1882.5			23.02	23.32	22.25
1860			23.05	23.31	22.42
1RB-Middle (50)		1905	23.12	23.33	22.26
		1882.5	23.11	23.31	22.21
		1860	23.14	23.30	22.38
1RB-Low (0)		1905	23.08	23.34	22.32
		1882.5	23.02	23.31	22.26
		1860	23.05	23.27	22.33
50RB-High (50)		1905	23.01	21.97	20.96
		1882.5	23.06	22.04	21.01
		1860	23.12	22.12	21.09
50RB-Middle (25)		1905	23.14	22.15	21.14
		1882.5	23.11	22.12	21.07
		1860	23.18	22.15	21.15
50RB-Low (0)		1905	23.13	22.19	21.16
		1882.5	23.06	22.08	21.04
		1860	23.16	22.12	21.11
100RB (0)		1905	23.07	22.08	21.04
		1882.5	23.03	22.05	21.01
		1860	23.12	22.14	21.09

Power Level A1/B1/C1

Band 26						
Bandwidth (MHz)	RB allocation	Frequency (MHz)	Actual output power (dBm)			
	RB offset		QPSK	16QAM	64QAM	
1.4MHz	1RB-High (5)	848.3	24.09	23.31	22.14	
		831.5	24.10	23.38	22.27	
		814.7	24.10	23.41	22.25	
	1RB-Middle (3)	848.3	24.15	23.44	22.24	
		831.5	24.21	23.41	22.31	
		814.7	24.21	23.50	22.38	
	1RB-Low (0)	848.3	24.05	23.21	22.17	
		831.5	24.13	23.45	22.28	
		814.7	24.11	23.32	22.28	
	3RB-High (3)	848.3	24.16	23.16	22.23	
		831.5	24.19	23.13	22.24	
		814.7	24.25	23.18	22.31	
	3RB-Middle (1)	848.3	24.22	23.17	22.24	
		831.5	24.25	23.18	22.37	
		814.7	24.28	23.26	22.29	
	3RB-Low (0)	848.3	24.16	23.13	22.23	
		831.5	24.25	23.22	22.29	
		814.7	24.21	23.22	22.33	
	6RB (0)	848.3	23.22	22.27	21.17	
		831.5	23.21	22.26	21.23	
		814.7	23.22	22.31	21.24	
	3MHz	1RB-High (14)	847.5	24.12	23.34	22.18
			831.5	24.15	23.50	22.33
			815.5	23.74	23.01	21.97
		1RB-Middle (7)	847.5	24.30	23.36	22.32
			831.5	24.23	23.52	22.35
			815.5	23.85	23.15	22.03
1RB-Low (0)		847.5	24.11	23.36	22.20	
		831.5	24.19	23.36	22.37	
		815.5	23.76	22.99	21.90	
8RB-High (7)		847.5	23.13	22.19	21.15	
		831.5	23.16	22.19	21.22	
		815.5	22.73	21.81	20.78	
8RB-Middle (4)		847.5	23.13	22.20	21.18	
		831.5	23.19	22.28	21.26	
		815.5	22.76	21.85	20.83	
8RB-Low (0)		847.5	23.14	22.22	21.17	
		831.5	23.17	22.26	21.24	
		815.5	22.73	21.80	21.49	
15RB (0)		847.5	23.16	22.17	21.10	

		831.5	23.16	22.18	21.17	
		815.5	22.75	21.77	20.74	
5MHz	1RB-High (24)	846.5	24.08	23.33	22.22	
		831.5	24.12	23.45	22.22	
		816.5	24.19	23.38	22.23	
	1RB-Middle (12)	846.5	24.19	23.41	22.38	
		831.5	24.27	23.61	22.39	
		816.5	24.30	23.62	22.45	
	1RB-Low (0)	846.5	24.10	23.36	22.21	
		831.5	24.20	23.46	22.34	
		816.5	24.15	23.40	22.27	
	12RB-High (13)	846.5	23.10	22.24	21.12	
		831.5	23.16	22.12	21.22	
		816.5	23.20	22.19	21.27	
	12RB-Middle (6)	846.5	23.20	22.15	21.19	
		831.5	23.23	22.21	21.24	
		816.5	23.24	22.24	21.34	
	12RB-Low (0)	846.5	23.25	22.22	21.20	
		831.5	23.23	22.21	21.26	
		816.5	23.20	22.19	21.23	
	25RB (0)	846.5	23.22	22.22	21.20	
		831.5	23.19	22.18	21.24	
		816.5	23.20	22.24	21.26	
	10MHz	1RB-High (49)	844	24.11	23.25	22.24
			831.5	24.17	23.41	22.26
			820	24.14	23.43	22.28
1RB-Middle (24)		844	24.25	23.44	22.28	
		831.5	24.24	23.52	22.25	
		820	24.27	23.60	22.41	
1RB-Low (0)		844	24.09	23.47	22.27	
		831.5	24.20	23.51	22.37	
		820	24.21	23.52	22.38	
25RB-High (25)		844	23.08	22.05	21.03	
		831.5	24.25	22.18	21.18	
		820	23.21	22.23	21.25	
25RB-Middle (12)		844	23.23	22.23	21.20	
		831.5	23.21	22.22	21.27	
		820	23.23	22.25	21.28	
25RB-Low (0)		844	23.32	22.29	21.27	
		831.5	23.28	22.29	21.32	
		820	23.23	22.26	21.28	
50RB (0)		844	23.25	22.24	21.18	
		831.5	23.23	22.21	21.27	
		820	23.23	22.21	21.24	
15MHz		1RB-High (74)	841.5	24.19	23.40	22.29
			831.5	24.17	23.50	22.37
			822.5	24.23	23.55	22.38
	1RB-Middle	841.5	24.22	23.49	22.36	

	(37)	831.5	24.26	23.49	22.41
		822.5	24.24	23.47	22.35
	1RB-Low (0)	841.5	24.23	23.49	22.43
		831.5	24.28	23.48	22.43
		822.5	24.25	23.62	22.46
	36RB-High (38)	841.5	23.22	22.15	21.15
		831.5	23.23	22.20	21.27
		822.5	23.26	22.24	21.28
	36RB-Middle (19)	841.5	23.31	22.28	21.29
		831.5	23.28	22.26	21.30
		822.5	23.30	22.29	21.30
	36RB-Low (0)	841.5	23.32	22.33	21.33
		831.5	23.34	22.29	21.36
		822.5	23.32	22.31	21.32
	75RB (0)	841.5	23.28	22.28	21.23
		831.5	23.29	22.26	21.28
		822.5	23.28	22.28	21.32

Power Level A1/C1

Band 41					
Bandwidth (MHz)	RB allocation	Frequency (MHz)	Actual output power (dBm)		
	RB offset		QPSK	16QAM	64QAM
5MHz	1RB-High (24)	2687.5	23.33	22.48	21.04
		2640.3	23.24	22.32	20.90
		2593	23.31	23.24	21.03
		2545.8	23.30	22.39	21.08
		2498.5	23.28	22.33	20.94
	1RB-Middle (12)	2687.5	23.47	22.67	21.15
		2640.3	23.37	22.48	21.05
		2593	23.50	22.58	21.17
		2545.8	23.39	22.51	21.10
		2498.5	23.42	22.51	21.11
	1RB-Low (0)	2687.5	23.35	22.52	21.09
		2640.3	23.22	22.35	20.95
		2593	23.40	22.49	21.06
		2545.8	23.27	22.38	21.03
		2498.5	23.31	22.45	21.00
	12RB-High (13)	2687.5	22.41	21.34	20.37
		2640.3	22.21	21.21	20.26
		2593	22.32	21.26	20.37
		2545.8	22.28	21.20	20.30
		2498.5	22.29	21.22	20.29
	12RB-Middle (6)	2687.5	22.44	21.36	20.40
		2640.3	22.31	21.24	20.31

		2593	22.39	21.33	20.45
		2545.8	22.31	21.23	20.34
		2498.5	22.28	21.22	20.34
		2687.5	22.42	21.35	20.42
		2640.3	22.25	21.19	20.27
	12RB-Low (0)	2593	22.36	21.33	20.40
		2545.8	22.27	21.19	20.28
		2498.5	22.25	21.20	20.28
		2687.5	22.40	21.42	20.40
		2640.3	22.25	21.29	20.32
	25RB (0)	2593	22.36	21.36	20.43
		2545.8	22.31	21.28	20.32
		2498.5	22.25	21.71	20.32
		2685	23.32	22.47	21.03
		2639	23.26	22.35	20.93
1RB-High (49)	2593	23.30	22.41	20.98	
	2547	23.37	22.47	21.08	
	2501	23.21	22.27	20.90	
	2685	23.44	22.55	21.12	
	2639	23.37	22.43	20.99	
1RB-Middle (24)	2593	23.43	22.51	21.12	
	2547	23.36	22.45	21.08	
	2501	23.32	22.44	21.01	
	2685	23.45	22.61	21.13	
	2639	23.26	22.37	20.93	
1RB-Low (0)	2593	23.47	22.57	21.18	
	2547	23.32	22.42	21.08	
	2501	23.34	22.44	20.99	
	2685	22.41	21.41	20.44	
	2639	22.25	21.28	20.27	
25RB-High (25)	2593	22.33	21.35	20.41	
	2547	22.94	21.31	20.34	
	2501	22.21	21.22	20.27	
	2685	22.48	21.45	20.46	
	2639	22.30	21.29	20.31	
25RB-Middle (12)	2593	22.39	21.39	20.46	
	2547	22.33	21.33	20.38	
	2501	22.25	21.24	20.32	
	2685	22.49	21.49	20.56	
	2639	22.30	21.31	20.33	
25RB-Low (0)	2593	22.46	21.47	20.52	
	2547	22.35	21.33	20.39	
	2501	22.26	21.25	20.28	
	2685	22.42	21.46	20.47	
	2639	22.27	21.31	20.27	
50RB (0)	2593	22.41	21.42	20.43	
	2547	22.32	21.36	20.34	
	2501	22.22	21.27	20.25	

15MHz	1RB-High (74)	2682.5	23.27	22.41	20.98
		2637.8	23.17	22.32	20.86
		2593	23.23	22.31	20.92
		2548.3	23.37	22.43	21.07
		2503.5	23.17	22.19	20.79
	1RB-Middle (37)	2682.5	23.38	22.51	21.07
		2637.8	23.18	22.29	20.86
		2593	23.33	22.44	21.05
		2548.3	23.33	22.42	21.28
		2503.5	23.25	22.37	20.88
	1RB-Low (0)	2682.5	23.39	22.72	21.10
		2637.8	23.25	22.34	20.92
		2593	23.48	22.55	21.18
		2548.3	23.29	22.38	20.93
		2503.5	23.29	22.34	20.93
	36RB-High (38)	2682.5	22.38	21.36	20.33
		2637.8	22.22	21.20	20.20
		2593	22.30	21.21	20.29
		2548.3	22.46	21.28	20.30
		2503.5	22.18	21.12	20.15
	36RB-Middle (19)	2682.5	22.42	21.35	20.44
		2637.8	22.26	21.20	20.23
		2593	22.38	21.29	20.35
		2548.3	22.29	21.28	20.30
		2503.5	22.20	21.15	20.19
	36RB-Low (0)	2682.5	22.46	21.41	20.47
		2637.8	22.28	21.19	20.23
		2593	22.45	21.40	20.43
2548.3		22.31	21.25	20.29	
2503.5		22.22	21.20	20.21	
75RB (0)	2682.5	22.41	21.41	20.47	
	2637.8	22.25	21.23	20.26	
	2593	22.33	21.33	20.39	
	2548.3	22.30	21.29	20.33	
	2503.5	22.16	21.16	20.21	
20MHz	1RB-High (99)	2680	23.26	22.38	20.97
		2636.5	23.21	22.30	20.87
		2593	23.25	22.32	20.92
		2549.5	23.41	22.51	21.05
		2506	23.21	22.31	20.90
	1RB-Middle (50)	2680	23.42	22.58	21.14
		2636.5	23.23	22.29	20.96
		2593	23.42	22.54	21.12
		2549.5	23.44	22.54	21.12
		2506	23.35	22.42	21.01
	1RB-Low (0)	2680	23.43	22.51	21.12
		2636.5	23.27	22.32	20.91
		2593	23.55	22.63	21.22

		2549.5	23.33	22.42	20.98
		2506	23.45	22.53	21.08
	50RB-High (50)	2680	22.34	21.35	20.34
		2636.5	22.16	21.19	20.15
		2593	22.28	21.31	20.32
		2549.5	22.33	21.39	20.34
		2506	22.25	21.30	20.28
		2680	22.41	21.44	20.44
	50RB-Middle (25)	2636.5	22.23	21.26	20.25
		2593	22.38	21.42	20.45
		2549.5	22.34	21.37	20.38
		2506	22.29	21.35	20.32
		2680	22.45	21.50	20.98
	50RB-Low (0)	2636.5	22.24	21.29	20.24
		2593	22.50	21.52	20.53
		2549.5	22.36	21.38	20.36
		2506	22.29	21.35	20.33
		2680	22.43	21.41	20.44
	100RB (0)	2636.5	22.25	21.24	20.26
		2593	22.42	21.45	20.47
2549.5		22.33	21.38	20.36	
2506		22.32	21.32	20.33	
2680		22.43	21.41	20.44	

Power Level B1

Band 41					
Bandwidth (MHz)	RB allocation	Frequency (MHz)	Actual output power (dBm)		
	RB offset		QPSK	16QAM	64QAM
5MHz	1RB-High (24)	2687.5	22.36	22.49	21.06
		2640.3	22.22	22.35	20.91
		2593	22.31	22.39	20.98
		2545.8	22.24	22.40	21.07
		2498.5	22.27	22.28	20.95
	1RB-Middle (12)	2687.5	22.52	22.65	21.17
		2640.3	22.36	22.51	21.05
		2593	22.47	22.66	21.16
		2545.8	22.41	22.50	21.09
		2498.5	22.43	22.51	21.12
	1RB-Low (0)	2687.5	22.38	22.48	21.93
		2640.3	22.24	22.35	20.95
		2593	22.39	22.46	21.09
		2545.8	22.27	22.38	21.01
		2498.5	22.36	22.42	21.09
	12RB-High (13)	2687.5	22.40	21.31	20.38
		2640.3	22.22	21.19	20.27

		2593	22.30	21.27	20.39
		2545.8	22.26	21.21	20.29
		2498.5	22.28	21.23	20.28
	12RB-Middle (6)	2687.5	22.45	21.37	20.40
		2640.3	22.30	21.22	20.30
		2593	22.40	21.36	20.44
		2545.8	22.31	21.25	20.34
		2498.5	22.29	21.22	20.35
	12RB-Low (0)	2687.5	22.42	21.32	20.41
		2640.3	22.23	21.53	20.26
		2593	22.35	21.31	20.42
		2545.8	22.27	21.20	20.30
		2498.5	22.25	21.18	20.30
	25RB (0)	2687.5	22.41	21.41	20.44
		2640.3	22.24	21.27	20.31
2593		22.36	21.36	20.44	
2545.8		22.29	21.28	20.33	
2498.5		22.24	21.26	20.31	
10MHz	1RB-High (49)	2685	22.35	22.49	21.04
		2639	22.24	22.38	20.93
		2593	22.30	22.38	21.00
		2547	22.38	22.47	21.30
		2501	22.18	22.32	20.90
	1RB-Middle (24)	2685	22.40	22.55	21.12
		2639	22.32	22.40	21.00
		2593	22.44	22.50	21.19
		2547	22.37	22.47	21.06
		2501	22.34	22.41	21.02
	1RB-Low (0)	2685	22.45	22.55	21.12
		2639	22.28	22.35	20.98
		2593	22.45	22.57	21.17
		2547	22.38	22.48	21.09
		2501	22.33	22.43	21.05
	25RB-High (25)	2685	22.42	21.40	20.45
		2639	22.27	21.26	20.29
		2593	22.37	21.34	20.41
		2547	22.32	21.30	20.36
		2501	22.21	21.22	20.27
	25RB-Middle (12)	2685	22.46	21.46	20.49
		2639	22.30	21.30	20.33
		2593	22.39	21.41	20.46
		2547	22.35	21.33	20.37
		2501	22.25	21.26	21.00
25RB-Low (0)	2685	22.51	21.47	20.59	
	2639	22.29	21.32	20.34	
	2593	22.45	21.46	20.52	
	2547	22.36	21.33	20.39	
	2501	22.23	21.24	20.30	

	50RB (0)	2685	22.42	21.46	20.48
		2639	22.25	21.32	20.25
		2593	22.39	21.40	20.42
		2547	22.33	21.37	20.34
		2501	22.22	21.25	20.25
15MHz	1RB-High (74)	2682.5	22.30	22.42	20.98
		2637.8	22.23	22.32	20.87
		2593	22.20	22.30	20.91
		2548.3	22.34	22.48	21.03
		2503.5	22.12	22.23	20.82
	1RB-Middle (37)	2682.5	22.37	22.48	21.03
		2637.8	22.21	22.27	20.89
		2593	22.33	22.41	21.03
		2548.3	22.34	22.36	21.02
		2503.5	22.22	22.31	20.90
	1RB-Low (0)	2682.5	22.41	22.52	21.11
		2637.8	22.23	22.32	20.94
		2593	22.47	22.55	21.21
		2548.3	22.26	22.39	20.96
		2503.5	22.29	22.39	21.05
	36RB-High (38)	2682.5	22.38	21.31	20.34
		2637.8	22.20	21.18	20.22
		2593	22.30	21.26	20.31
		2548.3	22.36	21.29	20.34
		2503.5	22.17	21.13	20.14
	36RB-Middle (19)	2682.5	22.40	21.37	20.44
		2637.8	22.28	21.21	20.23
		2593	22.34	21.31	20.37
		2548.3	22.31	21.26	20.76
		2503.5	22.23	21.17	20.18
	36RB-Low (0)	2682.5	22.46	21.43	20.49
		2637.8	22.27	21.20	20.23
		2593	22.41	21.47	20.44
		2548.3	22.31	21.27	20.30
		2503.5	22.23	21.20	20.24
	75RB (0)	2682.5	22.41	21.42	20.48
		2637.8	22.25	21.29	20.27
		2593	22.34	21.36	20.39
		2548.3	22.29	21.31	20.31
		2503.5	22.18	21.19	20.21
20MHz	1RB-High (99)	2680	22.34	22.48	20.99
		2636.5	22.28	22.36	20.96
		2593	22.24	22.35	20.94
		2549.5	22.29	22.52	21.05
		2506	22.15	22.24	20.82
	1RB-Middle (50)	2680	22.47	22.53	21.14
		2636.5	22.30	22.37	20.99
		2593	22.47	22.52	21.05

		2549.5	22.44	22.52	21.08
		2506	22.28	22.38	20.92
	1RB-Low (0)	2680	22.53	22.52	21.19
		2636.5	22.31	22.39	20.97
		2593	22.54	22.53	21.21
		2549.5	22.42	22.41	21.24
		2506	22.33	22.41	21.04
	50RB-High (50)	2680	22.36	21.39	20.38
		2636.5	22.23	21.26	20.20
		2593	22.29	21.31	20.32
		2549.5	22.29	21.39	20.37
		2506	22.20	21.25	20.21
	50RB-Middle (25)	2680	22.44	21.49	20.49
		2636.5	22.30	21.32	20.30
		2593	22.40	21.45	20.42
		2549.5	22.34	21.40	20.36
		2506	22.23	21.24	20.25
	50RB-Low (0)	2680	22.48	21.55	20.54
		2636.5	22.33	21.37	20.31
		2593	22.49	21.53	20.49
2549.5		22.35	21.37	20.35	
2506		22.25	21.27	20.20	
100RB (0)	2680	22.45	21.43	20.46	
	2636.5	22.29	21.31	20.30	
	2593	22.40	21.43	20.45	
	2549.5	22.37	21.37	20.36	
	2506	22.26	21.24	20.23	

Power Level A1/C1

Band 41 HPUE					
Bandwidth (MHz)	RB allocation	Frequency (MHz)	Actual output power (dBm)		
	RB offset		QPSK	16QAM	64QAM
5MHz	1RB-High (24)	2687.5	26.30	25.52	24.35
		2640.3	26.27	25.42	24.22
		2593	26.30	25.50	24.30
		2545.8	26.31	25.68	24.31
		2498.5	26.26	25.46	24.25
	1RB-Middle (12)	2687.5	26.37	25.58	24.38
		2640.3	26.27	25.46	24.27
		2593	26.34	25.54	24.36
		2545.8	26.33	25.53	24.30
		2498.5	26.32	25.53	24.32
	1RB-Low (0)	2687.5	26.35	25.56	24.37
		2640.3	26.25	25.42	24.24

		2593	26.37	25.57	24.37
		2545.8	26.28	25.46	24.28
		2498.5	26.31	25.49	24.30
	12RB-High (13)	2687.5	25.42	24.44	23.43
		2640.3	25.26	24.27	23.32
		2593	25.37	24.36	23.41
		2545.8	25.32	24.31	23.35
		2498.5	25.30	24.30	23.37
		2687.5	25.45	24.58	23.46
	12RB-Middle (6)	2640.3	25.31	24.30	23.35
		2593	25.42	24.42	23.46
		2545.8	25.34	24.32	23.36
		2498.5	25.31	24.30	23.38
		2687.5	25.45	24.44	23.46
	12RB-Low (0)	2640.3	25.31	24.28	23.35
		2593	25.41	24.41	23.45
		2545.8	25.33	24.30	23.32
		2498.5	25.29	24.28	23.37
		2687.5	25.42	24.46	23.47
	25RB (0)	2640.3	25.28	24.29	23.35
2593		25.38	24.42	23.44	
2545.8		25.31	24.32	23.34	
2498.5		25.27	24.31	23.37	
2685		26.33	25.58	24.33	
10MHz	1RB-High (49)	2639	26.25	25.48	24.25
		2593	26.29	25.51	24.27
		2547	26.37	25.59	24.34
		2501	26.21	25.42	24.20
		2685	26.45	25.64	24.41
	1RB-Middle (24)	2639	26.29	25.51	24.31
		2593	26.39	25.59	24.40
		2547	26.37	25.59	24.36
		2501	26.33	25.53	24.30
		2685	26.45	25.64	24.41
	1RB-Low (0)	2639	26.24	25.48	24.23
		2593	26.45	25.65	24.45
		2547	26.34	25.55	24.30
		2501	26.32	25.55	24.33
		2685	25.44	24.45	23.49
	25RB-High (25)	2639	25.28	24.54	23.37
		2593	25.39	24.42	23.46
		2547	25.36	24.37	23.41
		2501	25.25	24.28	23.37
		2685	25.48	24.49	23.53
25RB-Middle (12)	2639	25.30	24.32	23.39	
	2593	25.43	24.45	23.49	
	2547	25.36	24.38	23.38	
	2501	25.28	24.31	23.42	

	25RB-Low (0)	2685	25.50	24.49	23.57
		2639	25.34	24.34	23.41
		2593	25.49	24.51	23.54
		2547	25.38	24.39	23.44
		2501	25.64	24.30	23.38
	50RB (0)	2685	25.46	24.51	23.46
		2639	25.31	24.34	23.33
		2593	25.42	24.45	23.46
		2547	25.34	24.39	23.36
		2501	25.26	24.32	23.32
15MHz	1RB-High (74)	2682.5	26.24	25.50	24.54
		2637.8	26.21	25.41	24.19
		2593	26.21	25.40	24.20
		2548.3	26.36	25.57	24.34
		2503.5	26.14	25.35	24.14
	1RB-Middle (37)	2682.5	26.44	25.62	24.35
		2637.8	26.18	25.40	24.17
		2593	26.32	25.52	24.32
		2548.3	26.32	25.53	24.31
		2503.5	26.22	25.43	24.21
	1RB-Low (0)	2682.5	26.45	25.63	24.42
		2637.8	26.26	25.44	24.23
		2593	26.47	25.66	24.44
		2548.3	26.29	25.51	24.28
		2503.5	26.28	25.47	24.29
	36RB-High (38)	2682.5	25.42	24.36	23.36
		2637.8	25.26	24.22	23.23
		2593	25.33	24.28	23.33
		2548.3	25.38	24.32	23.35
		2503.5	25.22	24.17	23.21
	36RB-Middle (19)	2682.5	25.44	24.40	23.44
		2637.8	25.29	24.24	23.28
		2593	25.40	24.35	23.39
		2548.3	25.35	24.31	23.31
		2503.5	25.24	24.17	23.20
	36RB-Low (0)	2682.5	25.49	24.46	23.49
		2637.8	25.30	24.26	23.27
		2593	25.48	24.42	23.47
		2548.3	25.36	24.31	23.32
		2503.5	25.28	24.24	23.28
75RB (0)	2682.5	25.43	24.45	23.47	
	2637.8	25.28	24.28	23.30	
	2593	25.40	24.39	23.42	
	2548.3	25.33	24.34	23.35	
	2503.5	25.23	24.24	23.25	
20MHz	1RB-High (99)	2680	26.15	25.38	24.16
		2636.5	26.08	25.30	24.07
		2593	26.12	25.30	24.08

		2549.5	26.20	25.50	24.32
		2506	26.09	25.33	24.14
	1RB-Middle (50)	2680	26.30	25.51	24.32
		2636.5	26.10	25.31	24.11
		2593	26.30	25.49	24.32
		2549.5	26.29	25.52	24.34
		2506	26.25	25.44	24.25
		2680	26.31	25.52	24.33
	1RB-Low (0)	2636.5	26.13	25.30	24.10
		2593	26.41	25.62	24.41
		2549.5	26.33	25.40	24.21
		2506	26.28	25.46	24.28
		2680	25.25	24.30	23.31
	50RB-High (50)	2636.5	25.08	24.10	23.12
		2593	25.25	24.27	23.27
		2549.5	25.30	24.30	23.30
		2506	25.22	24.26	23.26
		2680	25.35	24.37	23.39
	50RB-Middle (25)	2636.5	25.17	24.18	23.19
		2593	25.34	24.38	23.39
		2549.5	25.32	24.33	23.31
		2506	25.27	24.33	23.28
		2680	25.40	24.41	23.43
	50RB-Low (0)	2636.5	25.18	24.19	23.21
		2593	25.55	24.44	23.45
		2549.5	25.32	24.33	23.30
2506		25.51	24.32	23.29	
2680		25.37	24.39	23.37	
100RB (0)	2636.5	25.18	24.18	23.17	
	2593	25.38	24.36	23.38	
	2549.5	25.32	24.30	23.31	
	2506	25.27	24.30	23.30	

Power Level B1

Band 41 HPUE					
Bandwidth (MHz)	RB allocation	Frequency (MHz)	Actual output power (dBm)		
	RB offset		QPSK	16QAM	64QAM
5MHz	1RB-High (24)	2687.5	24.39	24.58	24.32
		2640.3	24.25	24.25	24.22
		2593	24.30	24.53	24.29
		2545.8	24.34	24.54	24.29
		2498.5	24.28	24.48	24.24
	1RB-Middle (12)	2687.5	24.41	24.62	24.39
		2640.3	24.27	24.50	24.26

		2593	24.39	24.60	24.36
		2545.8	24.34	24.56	24.36
		2498.5	24.35	24.56	24.31
	1RB-Low (0)	2687.5	24.38	24.58	24.36
		2640.3	24.26	24.48	24.23
		2593	24.39	24.60	24.38
		2545.8	24.30	24.50	24.27
		2498.5	24.35	24.52	24.28
	12RB-High (13)	2687.5	24.42	24.42	23.44
		2640.3	24.26	24.25	23.31
		2593	24.34	24.36	23.40
		2545.8	24.31	24.31	23.32
		2498.5	24.27	24.28	23.37
	12RB-Middle (6)	2687.5	24.43	24.43	23.45
		2640.3	24.26	24.30	23.36
		2593	24.39	24.42	23.45
		2545.8	24.32	24.30	23.36
		2498.5	24.29	24.29	23.37
	12RB-Low (0)	2687.5	24.43	24.45	23.45
		2640.3	24.28	24.27	23.34
2593		24.38	24.40	23.46	
2545.8		24.30	24.29	23.34	
2498.5		24.28	24.28	23.37	
25RB (0)	2687.5	24.42	24.45	23.46	
	2640.3	24.26	24.28	23.35	
	2593	24.34	24.41	23.44	
	2545.8	24.29	24.31	23.36	
	2498.5	24.27	24.30	23.38	
10MHz	1RB-High (49)	2685	24.40	24.60	24.31
		2639	24.25	24.48	24.22
		2593	24.30	24.53	24.27
		2547	24.40	24.64	24.34
		2501	24.25	24.44	24.19
	1RB-Middle (24)	2685	24.49	24.65	24.37
		2639	24.31	24.54	24.28
		2593	24.44	24.65	24.40
		2547	24.40	24.60	24.35
		2501	24.30	24.55	24.30
	1RB-Low (0)	2685	24.48	24.70	24.43
		2639	24.26	24.48	24.23
		2593	24.47	24.70	24.44
		2547	24.35	24.56	24.32
		2501	24.36	24.55	24.31
	25RB-High (25)	2685	24.42	24.45	23.47
		2639	24.25	24.28	23.37
		2593	24.37	24.40	23.45
		2547	24.35	24.37	23.41
		2501	24.25	24.27	23.35

	25RB-Middle (12)	2685	24.46	24.50	23.51
		2639	24.29	24.31	23.40
		2593	24.41	24.43	23.49
		2547	24.34	24.37	23.40
		2501	24.29	24.31	23.41
	25RB-Low (0)	2685	24.47	24.49	23.56
		2639	24.31	24.34	23.41
		2593	24.45	24.48	23.56
		2547	24.37	24.38	23.40
		2501	24.26	24.30	23.38
	50RB (0)	2685	24.42	24.47	23.45
		2639	24.29	24.32	23.32
		2593	24.41	24.45	23.44
		2547	24.32	24.36	23.36
		2501	24.24	24.32	23.33
15MHz	1RB-High (74)	2682.5	24.28	24.50	24.28
		2637.8	24.19	24.41	24.18
		2593	24.20	24.42	24.17
		2548.3	24.39	24.61	24.36
		2503.5	24.15	24.40	24.13
	1RB-Middle (37)	2682.5	24.36	24.58	24.34
		2637.8	24.18	24.46	24.18
		2593	24.32	24.55	24.33
		2548.3	24.35	24.61	24.32
		2503.5	24.22	24.44	24.20
	1RB-Low (0)	2682.5	24.42	24.64	24.40
		2637.8	24.24	24.46	24.22
		2593	24.45	24.69	24.42
		2548.3	24.29	24.51	24.29
		2503.5	24.30	24.51	24.25
	36RB-High (38)	2682.5	24.38	24.33	23.37
		2637.8	24.20	24.19	23.23
		2593	24.29	24.27	23.33
		2548.3	24.33	24.32	23.34
		2503.5	24.21	24.16	23.19
	36RB-Middle (19)	2682.5	24.39	24.37	23.42
		2637.8	24.25	24.20	23.27
		2593	24.36	24.35	23.37
		2548.3	24.33	24.27	23.31
2503.5		24.17	24.17	23.20	
36RB-Low (0)	2682.5	24.40	24.43	23.48	
	2637.8	24.24	24.22	23.26	
	2593	24.43	24.40	23.46	
	2548.3	24.32	24.27	23.34	
	2503.5	24.25	24.23	23.25	
75RB (0)	2682.5	24.41	24.44	23.46	
	2637.8	24.25	24.28	23.30	
	2593	24.35	24.38	23.42	

		2548.3	24.29	24.31	23.32
		2503.5	24.21	24.24	23.22
20MHz	1RB-High (99)	2680	24.20	24.38	24.15
		2636.5	24.13	24.33	24.09
		2593	24.09	24.31	24.08
		2549.5	24.30	24.41	24.20
		2506	24.05	24.26	24.02
		2680	24.32	24.44	24.30
	1RB-Middle (50)	2636.5	24.15	24.32	24.09
		2593	24.32	24.42	24.27
		2549.5	24.32	24.44	24.28
		2506	24.16	24.38	24.13
		2680	24.39	24.37	24.35
	1RB-Low (0)	2636.5	24.18	24.35	24.12
		2593	24.41	24.43	24.36
		2549.5	24.33	24.39	24.16
		2506	24.23	24.42	24.18
		2680	24.24	24.27	23.30
	50RB-High (50)	2636.5	24.09	24.12	23.11
		2593	24.19	24.21	23.22
		2549.5	24.23	24.28	23.26
		2506	24.11	24.15	23.14
		2680	24.32	24.35	23.38
	50RB-Middle (25)	2636.5	24.16	24.19	23.22
		2593	24.29	24.31	23.30
		2549.5	24.24	24.28	23.27
		2506	24.11	24.18	23.16
		2680	24.34	24.42	23.41
	50RB-Low (0)	2636.5	24.20	24.19	23.24
		2593	24.37	24.38	23.41
		2549.5	24.25	24.25	23.25
		2506	24.12	24.15	23.18
2680		24.31	24.36	23.40	
100RB (0)	2636.5	24.16	24.18	23.20	
	2593	24.32	24.31	23.33	
	2549.5	24.21	24.27	23.27	
	2506	24.14	24.16	23.15	

Power Level A1

Band 66					
Bandwidth (MHz)	RB allocation	Frequency (MHz)	Actual output power (dBm)		
	RB offset		QPSK	16QAM	64QAM
1.4MHz	1RB-High (5)	1779.3	24.04	23.29	22.05
		1745	24.01	23.20	22.06
		1710.7	24.10	23.21	22.10
	1RB-Middle (3)	1779.3	24.17	23.38	22.13
		1745	23.15	23.31	22.08
		1710.7	24.23	23.37	22.17
	1RB-Low (0)	1779.3	24.04	23.14	22.06
		1745	24.03	23.30	22.10
		1710.7	24.09	23.26	22.15
	3RB-High (3)	1779.3	24.20	23.13	22.08
		1745	24.13	23.07	22.07
		1710.7	24.22	23.15	22.17
	3RB-Middle (1)	1779.3	24.21	23.17	22.14
		1745	24.18	23.13	22.15
		1710.7	24.25	23.17	22.23
	3RB-Low (0)	1779.3	24.17	23.11	22.12
		1745	24.11	23.11	22.10
		1710.7	24.21	23.10	22.15
	6RB (0)	1779.3	23.23	22.14	21.06
		1745	23.15	22.21	21.06
		1710.7	23.21	22.20	21.12
3MHz	1RB-High (14)	1778.5	24.13	23.21	22.11
		1745	24.07	23.30	22.10
		1711.5	24.13	23.28	22.18
	1RB-Middle (7)	1778.5	24.16	23.37	22.09
		1745	23.10	23.40	22.23
		1711.5	24.22	23.35	22.32
	1RB-Low (0)	1778.5	24.09	23.31	22.16
		1745	24.09	23.31	22.10
		1711.5	24.15	23.37	22.20
	8RB-High (7)	1778.5	23.12	22.04	21.02
		1745	23.12	22.05	21.02
		1711.5	23.17	22.13	21.13
	8RB-Middle (4)	1778.5	23.13	22.08	21.04
		1745	23.10	22.07	21.08
		1711.5	23.17	22.11	21.15
8RB-Low (0)	1778.5	23.14	22.05	21.03	
	1745	23.07	22.06	21.06	
	1711.5	23.14	22.13	21.10	
15RB (0)	1778.5	23.17	22.05	21.04	

		1745	23.10	22.02	21.00
		1711.5	23.17	22.12	21.10
5MHz	1RB-High (24)	1777.5	24.07	23.23	22.08
		1745	24.05	23.21	22.03
		1712.5	24.10	23.38	22.16
	1RB-Middle (12)	1777.5	24.26	23.36	22.38
		1745	24.19	23.35	22.25
		1712.5	24.28	23.52	22.26
	1RB-Low (0)	1777.5	24.09	23.26	22.08
		1745	24.07	23.26	22.17
		1712.5	24.16	23.36	22.20
	12RB-High (13)	1777.5	23.09	21.98	20.98
		1745	23.13	22.04	21.01
		1712.5	23.19	22.13	21.13
	12RB-Middle (6)	1777.5	23.18	22.06	21.04
		1745	23.15	22.08	21.05
		1712.5	23.21	22.14	21.15
	12RB-Low (0)	1777.5	23.17	22.09	21.07
		1745	23.11	22.04	21.04
		1712.5	23.17	22.07	21.10
	25RB (0)	1777.5	23.16	22.04	21.04
		1745	23.13	22.06	21.04
		1712.5	23.20	22.16	21.12
10MHz	1RB-High (49)	1775	24.10	23.27	22.09
		1745	24.08	23.31	22.14
		1715	24.07	23.32	22.16
	1RB-Middle (24)	1775	24.22	23.40	22.19
		1745	24.12	23.38	22.19
		1715	24.20	23.33	22.24
	1RB-Low (0)	1775	24.15	23.34	22.18
		1745	24.10	23.36	22.13
		1715	24.15	23.31	22.13
	25RB-High (25)	1775	23.15	22.06	21.02
		1745	23.24	22.11	21.10
		1715	23.24	22.16	21.17
	25RB-Middle (12)	1775	23.24	22.14	21.11
		1745	23.18	22.34	21.08
		1715	23.22	22.16	21.18
	25RB-Low (0)	1775	23.23	22.16	21.14
		1745	23.20	22.10	21.08
		1715	23.20	22.16	21.14
	50RB (0)	1775	23.20	22.10	21.09
		1745	23.23	22.15	21.13
		1715	23.24	22.15	21.16
15MHz	1RB-High (74)	1772.5	24.05	23.28	22.05
		1745	24.04	23.29	22.09
		1717.5	24.08	23.38	22.14
	1RB-Middle	1772.5	24.07	23.29	22.15

	(37)	1745	24.02	23.24	22.08
		1717.5	24.05	23.33	22.16
		1772.5	24.08	23.34	22.19
	1RB-Low (0)	1745	24.09	23.36	22.18
		1717.5	24.12	23.39	22.19
		1772.5	23.15	22.03	21.07
	36RB-High (38)	1745	23.18	22.07	21.09
		1717.5	23.17	22.08	21.13
		1772.5	23.20	22.10	21.12
	36RB-Middle (19)	1745	23.17	22.11	21.06
		1717.5	23.18	22.08	21.12
		1772.5	23.22	22.15	21.16
	36RB-Low (0)	1745	23.16	22.08	21.11
		1717.5	23.16	22.07	21.09
		1772.5	23.17	22.10	21.08
	75RB (0)	1745	23.19	22.11	21.09
		1717.5	23.16	22.10	21.08
		1770	23.94	23.07	21.97
20MHz	1RB-High (99)	1745	23.86	23.11	21.94
		1720	23.94	23.24	22.12
		1770	24.09	23.24	22.10
	1RB-Middle (50)	1745	23.99	23.25	21.99
		1720	24.03	23.22	22.19
		1770	23.98	23.22	22.07
	1RB-Low (0)	1745	23.96	23.30	22.08
		1720	24.02	23.33	22.07
		1770	23.08	22.00	21.01
	50RB-High (50)	1745	23.04	21.97	20.97
		1720	23.06	21.99	21.02
		1770	23.11	22.10	21.06
	50RB-Middle (25)	1745	23.11	22.06	21.03
		1720	23.09	22.05	21.03
		1770	23.17	22.14	21.09
	50RB-Low (0)	1745	23.04	22.01	20.98
		1720	23.06	21.98	21.01
		1770	23.10	22.04	21.01
	100RB (0)	1745	23.03	21.96	20.93
		1720	23.02	21.96	20.98

Power Level B1

Band 66					
Bandwidth (MHz)	RB allocation	Frequency (MHz)	Actual output power (dBm)		
	RB offset		QPSK	16QAM	64QAM
1.4MHz	1RB-High (5)	1779.3	19.04	19.20	19.05

	1RB-Middle (3)	1745	19.01	19.19	19.16
		1710.7	19.08	19.35	19.18
		1779.3	19.13	19.32	19.21
	1RB-Low (0)	1745	19.10	19.26	19.12
		1710.7	19.17	19.29	19.25
		1779.3	19.02	19.16	19.10
	3RB-High (3)	1745	18.98	19.24	19.06
		1710.7	19.07	19.32	19.22
		1779.3	19.13	19.01	19.14
	3RB-Middle (1)	1745	19.09	18.99	19.16
		1710.7	19.18	19.12	19.26
		1779.3	19.17	19.09	19.20
	3RB-Low (0)	1745	19.15	19.08	19.18
		1710.7	19.20	19.14	19.24
		1779.3	19.12	19.07	19.13
6RB (0)	1745	19.09	19.06	19.12	
	1710.7	19.16	19.08	19.18	
	1779.3	19.12	19.19	19.07	
3MHz	1RB-High (14)	1778.5	19.10	19.30	19.17
		1745	19.05	19.26	19.15
		1711.5	19.15	19.25	19.28
	1RB-Middle (7)	1778.5	19.17	19.32	19.22
		1745	19.17	19.41	19.28
		1711.5	19.20	19.39	19.28
	1RB-Low (0)	1778.5	19.10	19.19	19.17
		1745	19.04	19.34	19.16
		1711.5	19.13	19.38	19.19
	8RB-High (7)	1778.5	19.06	19.05	19.03
		1745	19.01	19.09	19.05
		1711.5	19.10	19.14	19.10
	8RB-Middle (4)	1778.5	19.09	19.08	19.07
		1745	19.07	19.09	19.09
		1711.5	19.15	19.20	19.14
8RB-Low (0)	1778.5	19.09	19.09	19.04	
	1745	19.03	19.08	18.99	
	1711.5	19.11	19.11	19.11	
15RB (0)	1778.5	19.08	19.07	19.03	
	1745	19.02	19.03	18.97	
	1711.5	19.11	19.13	19.10	
5MHz	1RB-High (24)	1777.5	19.06	19.20	19.10
		1745	19.01	19.28	19.05
		1712.5	19.10	19.30	19.18
	1RB-Middle (12)	1777.5	19.20	19.34	19.29
		1745	19.14	19.43	19.24
		1712.5	19.24	19.48	19.34
1RB-Low (0)	1777.5	19.09	19.19	19.15	

	12RB-High (13)	1745	19.03	19.24	19.15	
		1712.5	19.10	19.38	19.22	
		1777.5	19.07	18.96	19.01	
	12RB-Middle (6)	1745	19.06	19.03	19.03	
		1712.5	19.13	19.15	19.16	
		1777.5	19.13	19.08	19.09	
	12RB-Low (0)	1745	19.10	19.07	19.09	
		1712.5	19.16	19.11	19.16	
		1777.5	19.12	19.08	19.10	
	25RB (0)	1745	19.07	19.06	19.05	
		1712.5	19.11	19.10	19.11	
		1777.5	19.11	19.08	19.04	
10MHz	1RB-High (49)	1745	19.06	19.03	19.02	
		1712.5	19.14	19.11	19.11	
		1775	19.08	19.21	19.11	
	1RB-Middle (24)	1745	19.02	19.25	19.13	
		1715	19.04	19.29	19.13	
		1775	19.16	19.38	19.21	
	1RB-Low (0)	1745	19.13	19.32	19.23	
		1715	19.12	19.40	19.30	
		1775	19.12	19.35	19.25	
	25RB-High (25)	1745	19.07	19.36	19.20	
		1715	19.15	19.33	19.21	
		1775	19.14	19.06	19.07	
	25RB-Middle (12)	1745	19.12	19.11	19.11	
		1715	19.17	19.17	19.15	
		1775	19.16	19.11	19.13	
	25RB-Low (0)	1745	19.09	19.09	19.07	
		1715	19.16	19.14	19.14	
		1775	19.15	19.12	19.14	
	50RB (0)	1745	19.09	19.08	19.09	
		1715	19.14	19.14	19.11	
		1775	19.13	19.12	19.09	
	15MHz	1RB-High (74)	1745	19.11	19.12	19.09
			1715	19.16	19.15	19.14
			1772.5	19.08	19.21	19.11
1RB-Middle (37)		1745	19.02	19.29	19.16	
		1717.5	19.06	19.30	19.18	
		1772.5	19.08	19.26	19.12	
1RB-Low (0)		1745	19.00	19.19	19.08	
		1717.5	19.05	19.27	19.18	
		1772.5	19.09	19.40	19.19	
36RB-High (38)		1745	19.08	19.32	19.25	
		1717.5	19.09	19.39	19.23	
		1772.5	19.11	19.05	19.08	
36RB-Middle		1745	19.12	19.07	19.07	
		1717.5	19.12	19.07	19.09	
			1772.5	19.16	19.09	19.10



	(19)	1745	19.12	19.07	19.08	
		1717.5	19.12	19.09	19.12	
	36RB-Low (0)	1772.5	19.13	19.11	19.13	
		1745	19.11	19.05	19.07	
	75RB (0)	1717.5	19.10	19.10	19.11	
		1772.5	19.13	19.10	19.08	
1745		19.11	19.08	19.06		
20MHz	1RB-High (99)	1717.5	19.11	19.11	19.08	
		1770	18.99	19.20	19.08	
		1745	18.93	19.08	19.05	
	1RB-Middle (50)	1720	18.99	19.18	19.10	
		1770	19.06	19.30	19.15	
		1745	19.00	19.27	19.05	
	1RB-Low (0)	1720	19.04	19.19	19.14	
		1770	19.02	19.26	19.15	
		1745	18.97	19.25	19.13	
	50RB-High (50)	1720	19.01	19.24	19.18	
		1770	19.03	19.03	19.01	
		1745	19.00	18.99	18.97	
	50RB-Middle (25)	1720	19.00	18.98	18.99	
		1770	19.08	19.11	19.07	
		1745	18.99	19.04	19.04	
	50RB-Low (0)	1720	19.01	19.04	19.01	
		1770	19.11	19.11	19.05	
		1745	19.07	18.99	18.97	
	100RB (0)	1720	19.03	18.99	18.96	
		1770	19.06	19.04	19.03	
		1745	18.97	18.95	18.94	
			1720	18.99	18.97	18.96

Power Level C1

Band 66						
Bandwidth (MHz)	RB allocation	Frequency (MHz)	Actual output power (dBm)			
	RB offset		QPSK	16QAM	64QAM	
1.4MHz	1RB-High (5)	1779.3	22.02	22.13	21.99	
		1745	21.94	22.17	22.05	
		1710.7	22.05	22.25	22.09	
	1RB-Middle (3)	1779.3	22.09	22.25	22.06	
		1745	22.01	22.31	22.11	
		1710.7	22.18	22.33	22.21	
	1RB-Low (0)	1779.3	22.14	22.11	22.07	
		1745	21.97	22.18	22.06	
		1710.7	22.07	22.25	22.15	
	3RB-High (3)	1779.3	22.15	21.95	22.06	
		1745	22.05	22.05	22.09	
		1710.7	22.18	22.01	22.17	
	3RB-Middle (1)	1779.3	22.16	22.07	22.14	
		1745	22.13	21.98	22.08	
		1710.7	22.18	22.16	22.23	
	3RB-Low (0)	1779.3	22.12	22.04	22.10	
		1745	22.07	21.97	22.06	
		1710.7	22.17	22.05	22.11	
	6RB (0)	1779.3	22.17	22.14	21.02	
		1745	22.12	22.13	21.06	
		1710.7	22.15	22.23	22.16	
	3MHz	1RB-High (14)	1778.5	22.09	22.20	22.02
			1745	22.04	22.22	22.09
			1711.5	22.13	22.23	22.19
1RB-Middle (7)		1778.5	22.07	22.27	22.18	
		1745	22.11	22.33	22.17	
		1711.5	22.21	22.38	22.29	
1RB-Low (0)		1778.5	22.10	22.19	22.07	
		1745	22.02	22.27	22.11	
		1711.5	22.12	22.24	22.16	
8RB-High (7)		1778.5	22.07	22.04	20.99	
		1745	22.02	22.02	21.04	
		1711.5	22.10	22.11	21.08	
8RB-Middle (4)		1778.5	22.10	22.06	21.02	
		1745	22.05	22.08	21.00	
		1711.5	22.11	22.11	21.09	
8RB-Low (0)		1778.5	22.10	22.03	21.02	
		1745	22.03	22.03	21.04	
		1711.5	22.11	22.11	21.09	
15RB (0)	1778.5	22.10	22.04	20.98		

		1745	22.05	22.02	20.99
		1711.5	22.12	22.09	21.08
5MHz	1RB-High (24)	1777.5	22.05	22.12	21.99
		1745	22.00	22.10	22.08
		1712.5	22.06	22.16	22.16
	1RB-Middle (12)	1777.5	22.16	22.26	22.27
		1745	22.13	22.34	22.17
		1712.5	22.19	22.31	22.30
	1RB-Low (0)	1777.5	22.09	22.23	22.07
		1745	22.03	22.22	22.12
		1712.5	22.10	22.34	22.13
	12RB-High (13)	1777.5	22.04	21.90	20.95
		1745	22.04	22.01	20.99
		1712.5	22.15	22.10	21.11
	12RB-Middle (6)	1777.5	22.13	22.05	21.06
		1745	22.09	22.01	21.05
		1712.5	22.15	22.09	21.12
	12RB-Low (0)	1777.5	22.12	22.03	21.05
		1745	22.04	22.01	21.04
		1712.5	22.13	22.07	21.09
	25RB (0)	1777.5	22.12	22.03	21.04
		1745	22.09	22.04	21.00
		1712.5	22.15	22.10	21.10
10MHz	1RB-High (49)	1775	22.05	22.20	21.98
		1745	22.00	22.16	22.13
		1715	22.02	22.30	22.11
	1RB-Middle (24)	1775	22.18	22.33	22.15
		1745	22.09	22.27	22.12
		1715	22.17	22.27	22.12
	1RB-Low (0)	1775	22.08	22.27	22.14
		1745	22.03	22.34	22.09
		1715	22.11	22.25	22.13
	25RB-High (25)	1775	22.11	22.03	21.00
		1745	22.11	22.09	21.09
		1715	22.19	22.13	21.12
	25RB-Middle (12)	1775	22.20	22.13	21.10
		1745	22.11	22.07	21.07
		1715	22.19	22.12	21.12
	25RB-Low (0)	1775	22.16	22.12	21.11
		1745	22.09	22.09	21.08
		1715	22.15	22.12	21.09
	50RB (0)	1775	22.14	22.09	21.05
		1745	22.18	22.12	21.10
		1715	22.16	22.10	21.14
15MHz	1RB-High (74)	1772.5	22.04	22.16	22.01
		1745	22.01	22.15	22.01
		1717.5	22.03	22.21	22.14
	1RB-Middle	1772.5	22.05	22.25	22.14

	(37)	1745	22.00	22.11	22.14
		1717.5	22.06	22.17	22.15
	1RB-Low (0)	1772.5	22.08	22.24	22.16
		1745	22.12	22.24	22.18
		1717.5	22.10	22.24	22.20
	36RB-High (38)	1772.5	22.12	22.03	21.01
		1745	22.12	22.05	21.04
		1717.5	22.14	22.06	21.10
	36RB-Middle (19)	1772.5	22.14	22.10	21.08
		1745	22.11	22.07	21.08
		1717.5	22.12	22.04	21.09
	36RB-Low (0)	1772.5	22.17	22.12	21.12
		1745	22.10	22.04	21.07
		1717.5	22.13	22.07	21.08
	75RB (0)	1772.5	22.14	22.09	21.05
1745		22.13	22.08	21.05	
1717.5		22.14	22.15	21.06	
20MHz	1RB-High (99)	1770	21.97	22.08	22.03
		1745	21.90	22.08	21.97
		1720	21.94	22.18	22.05
	1RB-Middle (50)	1770	22.03	22.24	22.21
		1745	21.99	22.18	22.05
		1720	21.97	22.20	22.08
	1RB-Low (0)	1770	22.00	22.23	22.04
		1745	21.92	22.13	22.13
		1720	21.95	22.14	22.08
	50RB-High (50)	1770	22.06	21.98	21.00
		1745	22.01	21.97	20.98
		1720	22.01	21.97	20.97
	50RB-Middle (25)	1770	22.08	22.09	21.06
		1745	22.07	22.05	20.99
		1720	22.05	22.05	20.99
	50RB-Low (0)	1770	22.12	22.10	21.10
		1745	22.09	22.02	20.98
		1720	22.06	21.99	21.00
	100RB (0)	1770	22.08	22.05	21.02
		1745	21.98	21.95	20.92
		1720	22.00	21.95	20.95

Power Level A1/B1C1

Band 71						
Bandwidth (MHz)	RB allocation	Frequency (MHz)	Actual output power (dBm)			
	RB offset		QPSK	16QAM	64QAM	
5MHz	1RB-High (24)	695.5	24.52	23.70	22.68	
		680.5	24.50	23.73	22.66	
		665.5	24.41	23.64	22.55	
	1RB-Middle (12)	695.5	24.67	23.92	22.85	
		680.5	24.56	23.94	22.78	
		665.5	24.66	23.78	22.66	
	1RB-Low (0)	695.5	24.52	23.76	22.65	
		680.5	24.52	23.68	22.68	
		665.5	24.44	23.59	22.60	
	12RB-High (13)	695.5	23.62	22.59	21.62	
		680.5	23.58	22.57	21.54	
		665.5	23.49	22.46	21.46	
	12RB-Middle (6)	695.5	23.64	22.63	21.62	
		680.5	23.62	22.59	21.59	
		665.5	23.55	22.51	21.52	
	12RB-Low (0)	695.5	23.66	22.61	21.64	
		680.5	23.61	22.60	21.62	
		665.5	23.50	22.43	21.44	
	25RB (0)	695.5	23.67	22.67	21.61	
		680.5	23.63	22.59	21.60	
		665.5	23.53	22.48	21.48	
	10MHz	1RB-High (49)	693	23.73	22.90	21.77
			680.5	24.58	23.75	22.69
			668	24.48	23.68	22.60
		1RB-Middle (24)	693	23.79	22.90	21.83
			680.5	24.63	23.80	22.71
			668	24.61	23.78	22.65
1RB-Low (0)		693	23.78	22.94	21.74	
		680.5	24.52	23.76	22.66	
		668	24.53	23.71	22.61	
25RB-High (25)		693	22.83	21.73	20.73	
		680.5	23.69	22.57	21.63	
		668	23.63	22.61	21.60	
25RB-Middle (12)		693	22.87	21.74	20.73	
		680.5	23.68	22.65	21.63	
		668	23.60	22.58	21.56	
25RB-Low (0)		693	22.92	21.80	20.80	
		680.5	23.74	22.72	21.69	
		668	23.64	22.59	21.56	
50RB (0)		693	22.86	21.76	20.75	

		680.5	23.75	22.69	21.69
		668	23.65	22.61	21.59
15MHz	1RB-High (74)	690.5	24.63	23.89	22.72
		680.5	24.63	23.89	22.69
		670.5	24.59	23.70	22.65
	1RB-Middle (37)	690.5	24.70	23.90	22.74
		680.5	24.65	23.82	22.70
		670.5	24.61	23.85	22.74
	1RB-Low (0)	690.5	24.71	23.96	22.75
		680.5	24.64	23.83	22.70
		670.5	24.60	23.80	22.71
	36RB-High (38)	690.5	23.74	22.68	21.65
		680.5	23.80	22.73	21.72
		670.5	23.77	22.67	21.65
	36RB-Middle (19)	690.5	23.80	22.70	21.70
		680.5	23.77	22.69	21.67
		670.5	23.64	22.61	21.61
	36RB-Low (0)	690.5	23.79	22.70	21.69
		680.5	23.80	22.73	21.71
		670.5	23.73	22.65	21.59
	75RB (0)	690.5	23.76	22.68	21.64
		680.5	23.78	22.74	21.66
		670.5	23.70	22.64	21.62
20MHz	1RB-High (99)	688	24.45	23.67	22.64
		683	24.41	23.62	22.60
		673	24.44	23.75	22.59
	1RB-Middle (50)	688	24.52	23.85	22.72
		683	24.57	23.85	22.71
		673	24.53	23.76	22.76
	1RB-Low (0)	688	24.54	23.79	22.65
		683	24.47	23.79	22.65
		673	24.45	23.68	22.56
	50RB-High (50)	688	23.51	22.48	21.50
		683	23.63	22.60	21.60
		673	23.46	22.44	21.43
	50RB-Middle (25)	688	23.64	22.63	21.62
		683	23.64	22.61	21.63
		673	23.56	22.54	21.50
	50RB-Low (0)	688	23.58	22.60	21.58
		683	23.75	22.72	21.70
		673	23.51	22.47	21.49
	100RB (0)	688	23.59	22.55	21.54
		683	23.68	22.64	21.62
		673	23.48	22.44	21.43

11.4 Wi-Fi and BT Measurement result

The maximum output power of BT is 6.04dBm.

The maximum tune up of BT is 6.3dBm.

The average conducted power for Wi-Fi is as following:

Receiver OFF+Hotspot ON

802.11b(dBm)	
Channel\data rate	5.5Mbps
11(2462MHz)	20.40
6(2437MHz)	20.43
1(2412MHz)	20.37
Tune up	20.50
802.11g(dBm)	
Channel\data rate	6Mbps
6(2437MHz)	18.56
Tune up	19.50
11(2462MHz)	17.44
1(2412MHz)	17.23
Tune up	17.50
802.11n(dBm)-20MHz	
Channel\data rate	MCS0
6(2437MHz)	18.56
Tune up	19.50
11(2462MHz)	16.77
1(2412MHz)	16.64
Tune up	17.50

Receiver OFF+Hotspot OFF

802.11b(dBm)	
Channel\data rate	5.5Mbps
11(2462MHz)	19.37
6(2437MHz)	19.38
1(2412MHz)	19.01
Tune up	19.50
802.11g(dBm)	
Channel\data rate	6Mbps
6(2437MHz)	18.56
Tune up	19.50
11(2462MHz)	17.44
1(2412MHz)	17.23
Tune up	17.50
802.11n(dBm)-20MHz	
Channel\data rate	MCS0
6(2437MHz)	18.56
Tune up	19.50
11(2462MHz)	16.77
1(2412MHz)	16.64
Tune up	17.50

**Receiver ON& Simultaneous with cellular**

802.11b(dBm)	
Channel\data rate	5.5Mbps
11(2462MHz)	17.53
6(2437MHz)	17.58
1(2412MHz)	17.28
Tune up	17.70
802.11g(dBm)	
Channel\data rate	6Mbps
11(2462MHz)	17.44
6(2437MHz)	17.26
1(2412MHz)	17.23
Tune up	17.50
802.11n(dBm)-20MHz	
Channel\data rate	MCS0
11(2462MHz)	16.77
6(2437MHz)	16.87
1(2412MHz)	16.64
Tune up	17.50

12 Simultaneous TX SAR Considerations

12.1 Introduction

The following procedures adopted from “FCC SAR Considerations for Cell Phones with Multiple Transmitters” are applicable to handsets with built-in unlicensed transmitters such as 802.11 a/b/g and Bluetooth devices which may simultaneously transmit with the licensed transmitter. For this device, the BT and Wi-Fi can transmit simultaneous with other transmitters.

12.2 Transmit Antenna Separation Distances

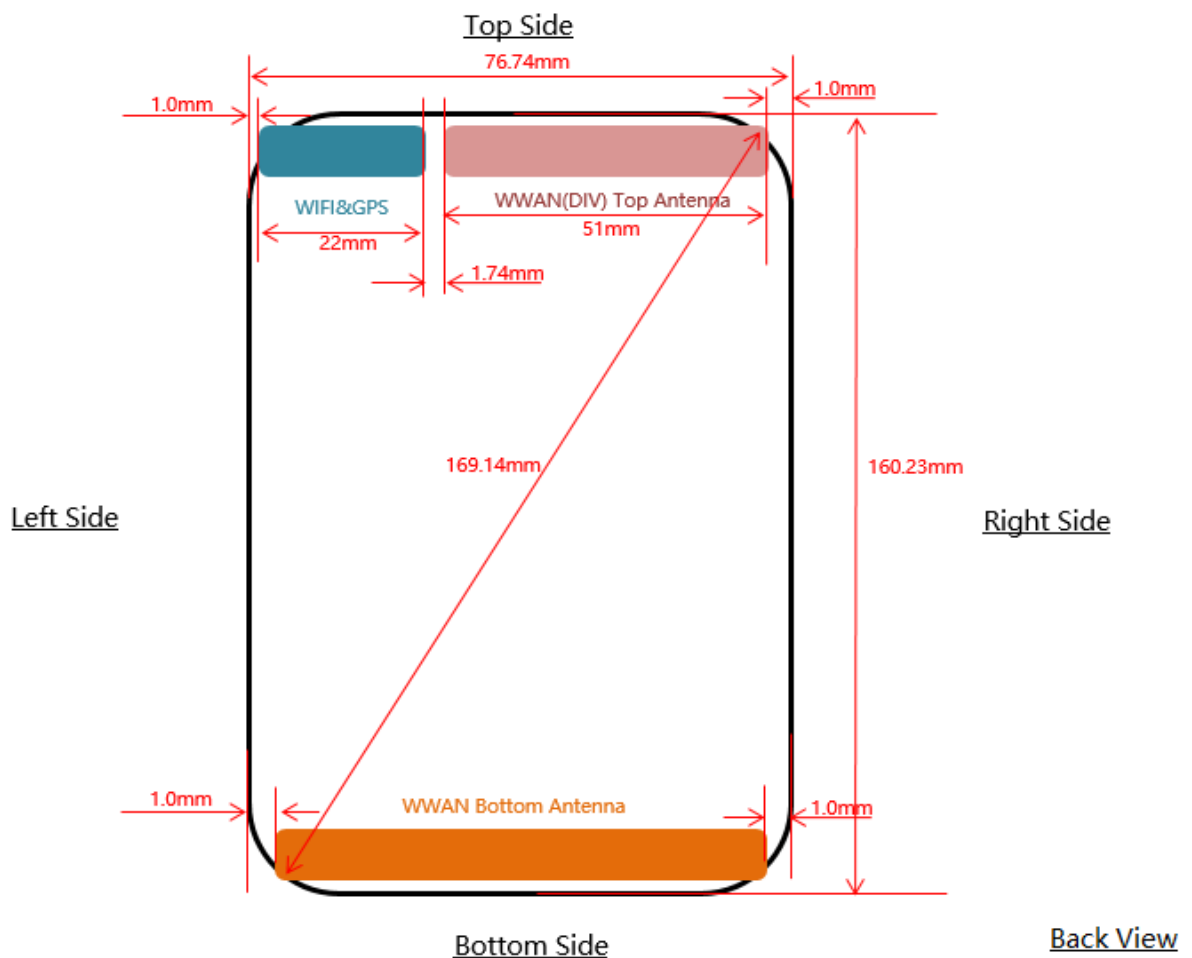

Picture 12.1 Antenna Locations

12.3 SAR Measurement Positions

According to the KDB941225 D06 Hot Spot SAR v01, the edges with less than 2.5 cm distance to the antennas need to be tested for SAR.

SAR measurement positions						
Mode	Front	Rear	Left edge	Right edge	Top edge	Bottom edge
Main antenna	Yes	Yes	Yes	Yes	No	Yes
WLAN	Yes	Yes	No	Yes	Yes	No

12.4 Standalone SAR Test Exclusion Considerations

Standalone 1-g head or body SAR evaluation by measurement or numerical simulation is not required when the corresponding SAR Exclusion Threshold condition, listed below, is satisfied. The 1-g SAR test exclusion threshold for 100 MHz to 6 GHz at test separation distances ≤ 50 mm are determined by:

$[(\text{max. power of channel, including tune-up tolerance, mW}) / (\text{min. test separation distance, mm})] \cdot [\sqrt{f(\text{GHz})}] \leq 3.0$ for 1-g SAR, where

- $f(\text{GHz})$ is the RF channel transmit frequency in GHz
- Power and distance are rounded to the nearest mW and mm before calculation
- The result is rounded to one decimal place for comparison

Table 12.1: Standalone SAR test exclusion considerations

Band/Mode	F(GHz)	Position	SAR test exclusion threshold(mW)	RF output power		SAR test exclusion
				dBm	mW	
Bluetooth	2.441	Head	9.60	6.3	4.27	Yes
		Body	19.20	6.3	4.27	Yes
2.4GHz WLAN	2.45	Head	9.58	20.5	112.2	No
		Body	19.17	20.5	112.2	No

13 Evaluation of Simultaneous

Table 13.1: The sum of reported SAR values for main antenna and WiFi2.4G

	Position	Main antenna	WiFi	Sum
Highest reported SAR value for Head	Left hand, Touch cheek	0.6	0.69	1.29
Highest reported SAR value for Body	Rear 10mm	1.31	0.34	1.65⁽¹⁾
	Bottom 10mm	1.5	/	1.5

Note1: According to the KDB 447498 D01, when the sum of SAR is larger than the limit, SAR test exclusion is determined by the SAR to peak location separation ratio. The ratio is determined by $(SAR1 + SAR2)^{1.5}/R_i$, rounded to two decimal digits, and must be ≤ 0.04 for all antenna pairs in the configuration to qualify for 1-g SAR test exclusion. See for detail **Table 13.4**

Table 13.2: The sum of reported SAR values for main antenna and BT

	Position	Main antenna	BT	Sum
Maximum reported SAR value for Head	Left hand, Touch cheek	0.6	0.17 ^[1]	0.77
Maximum reported SAR value for Body	Rear 10mm	1.31	0.09 ^[1]	1.4
	Bottom 10mm	1.5	/	1.5

[1] - Estimated SAR for Bluetooth (see the table 13.3)

Table 13.3: Estimated SAR for Bluetooth

Mode/Band	F (GHz)	Position	Distance (mm)	Upper limit of power *		Estimated _{1g} (W/kg)
				dBm	mW	
Bluetooth	2.441	Head	5	6.3	4.27	0.17
Bluetooth	2.441	Body	10	6.3	4.27	0.09
Bluetooth	2.441	Body	15	6.3	4.27	0.06

* - Maximum possible output power declared by manufacturer

When standalone SAR test exclusion applies to an antenna that transmits simultaneously with other antennas, the standalone SAR must be estimated according to following to determine simultaneous transmission SAR test exclusion:

$(\text{max. power of channel, including tune-up tolerance, mW}) / (\text{min. test separation distance, mm}) \cdot [\sqrt{f(\text{GHz})} / x] \text{ W/kg}$ for test separation distances $\leq 50 \text{ mm}$;

where $x = 7.5$ for 1-g SAR.

When the minimum test separation distance is $< 5 \text{ mm}$, a distance of 5 mm is applied to determine SAR test exclusion

Conclusion:

According to the above tables, the sum of reported SAR values is $< 1.6 \text{ W/kg}$. So the simultaneous transmission SAR with volume scans is not required.

Table 13.4: The sum of reported SAR values for main antenna and WiFi

	Position	band	Main antenna	WiFi	Sum (1g)	Distance (mm)	Ratio
Highest reported SAR value for Phablet	Rear 10mm	WCDMA1700	1.31	0.34	1.65	136.1	0.016
		LTE Band41 HPUE	1.3	0.34	1.64	142.11	0.015

According to the KDB 447498 D01, when the sum of SAR is larger than the limit, SAR test exclusion is determined by the SAR to peak location separation ratio. The ratio is determined by $(SAR_1 + SAR_2)^{1.5}/R_i$, rounded to two decimal digits, and must be ≤ 0.04 for all antenna pairs in the configuration to qualify for 1-g SAR test exclusion.

Maxima and position w.r.t. Grid Reference Point		associated 1g averages
Zoom Scan (D:\2021\I21Z60727(FCC)\WIFI2.4G Body 18dB 10mm 58a LJY.da53:0/11b 5.5M 18db Rear 10mm)		
Max. 1 at (23.80, -61.00, -1.00) mm		0.33 W/kg
Zoom Scan (D:\2021\I21Z60727(FCC)\WCDMA1700 Body 56a SYF jiang4.da53:1/Rear Low 10mm)		
Max. 2 at (11.00, 74.50, -1.32) mm		1.01 W/kg
Distances and Separation Ratios		
Max. 1 - Max. 2		Distance [mm]: 136.10 / Separation ratio [W/kg/mm]: 0.01

Picture 13.4-1 Distance evaluation for WCDMA1700 and WiFi 2.4G Body Rear 10mm

Maxima and position w.r.t. Grid Reference Point		associated 1g averages
Zoom Scan (D:\2021\I21Z60727(FCC)\WIFI2.4G Body 18dB 10mm 58a LJY.da53:0/11b 5.5M 18db Rear 10mm)		
Max. 1 at (23.80, -61.00, -1.00) mm		0.33 W/kg
Zoom Scan (D:\2021\I21Z60727(FCC)\LTE Band41 Body PC2 58a LJY Jiang2.da53:0/Rear 50RB-Low 10mm)		
Max. 2 at (-20.60, 74.00, -1.44) mm		1.08 W/kg
Distances and Separation Ratios		
Max. 1 - Max. 2		Distance [mm]: 142.11 / Separation ratio [W/kg/mm]: 0.01

Picture 13.4-2 Distance evaluation for LTE Band41 HPUE and WiFi 2.4G Body Rear 10mm

14 SAR Test Result

It is determined by user manual for the distance between the EUT and the phantom bottom. The distance is 10 mm or 15mm and just applied to the condition of body worn accessory.

It is performed for all SAR measurements with area scan based 1-g SAR estimation (Fast SAR). A zoom scan measurement is added when the estimated 1-gSAR is the highest measured SAR in each exposure configuration, wireless mode and frequency band combination or more than 1.2W/kg.

The calculated SAR is obtained by the following formula:

$$\text{Reported SAR} = \text{Measured SAR} \times 10^{(P_{\text{Target}} - P_{\text{Measured}})/10}$$

Where P_{Target} is the power of manufacturing upper limit;

P_{Measured} is the measured power in chapter 11.

Table 14.1: Duty Cycle

Mode	Duty Cycle
Speech for GSM850/1900	1:8..3
GPRS&EGPRS for GSM850/1900	1:4
WCDMA<E FDD	1:1
LTE B41 PC2	1:2.309
LTE B41 PC3	1:1.58

14.1 SAR result

H : The headset of other brands

Table 14.1-1: SAR Values (GSM 850 MHz Band - Head)

Ambient Temperature: 23.3°C Liquid Temperature: 22.8°C											
Frequency		Side	Test Position	Figure No.	Conducted Power (dBm)	Max. tune-up Power (dBm)	Measured SAR(10g) (W/kg)	Reported SAR(10g) (W/kg)	Measured SAR(1g) (W/kg)	Reported SAR(1g) (W/kg)	Power Drift (dB)
Ch.	MHz										
251	848.8	Left	Touch	Fig.1	32.12	33.5	0.12	0.16	0.156	0.21	0.09
190	836.6	Left	Touch	/	32.14	33.5	0.109	0.15	0.142	0.19	-0.01
128	824.2	Left	Touch	/	32.15	33.5	0.117	0.16	0.15	0.20	0.12
190	836.6	Left	Tilt	/	32.14	33.5	0.064	0.09	0.078	0.11	0.09
190	836.6	Right	Touch	/	32.14	33.5	0.107	0.15	0.141	0.20	-0.06
190	836.6	Right	Tilt	/	32.14	33.5	0.053	0.07	0.066	0.09	0.1

Table 14.1-2: SAR Values (GSM 850 MHz Band - Body)

Ambient Temperature: 23.3°C Liquid Temperature: 22.8°C											
Frequency		Mode (number of timeslots)	Test Position	Figure No.	Conducted Power (dBm)	Max. tune-up Power (dBm)	Measured SAR(10g) (W/kg)	Reported SAR(10g) (W/kg)	Measured SAR(1g) (W/kg)	Reported SAR(1g) (W/kg)	Power Drift (dB)
Ch.	MHz										
190	836.6	GPRS (2)	Front	/	30.63	31.5	0.156	0.19	0.197	0.24	-0.04
251	848.8	GPRS (2)	Rear	Fig.2	30.61	31.5	0.253	0.31	0.326	0.40	0.13
190	836.6	GPRS (2)	Rear	/	30.63	31.5	0.249	0.30	0.32	0.39	-0.07
128	824.2	GPRS (2)	Rear	/	30.64	31.5	0.245	0.30	0.315	0.38	0.09
190	836.6	GPRS (2)	Left	/	30.63	31.5	0.146	0.18	0.201	0.25	-0.18
190	836.6	GPRS (2)	Right	/	30.63	31.5	0.148	0.18	0.205	0.25	0.18
190	836.6	GPRS (2)	Bottom	/	30.63	31.5	<0.01	<0.01	<0.01	<0.01	/
251	848.8	EGPRS (2)	Rear	/	30.57	31.5	0.243	0.30	0.311	0.39	-0.18

Note: The distance between the EUT and the phantom bottom is 10mm.

Table 14.1-3: SAR Values (GSM 1900 MHz Band - Head)

Ambient Temperature: 22.5°C Liquid Temperature: 21.9°C											
Frequency		Side	Test Position	Figure No.	Conducted Power (dBm)	Max. tune-up Power (dBm)	Measured SAR(10g) (W/kg)	Reported SAR(10g) (W/kg)	Measured SAR(1g) (W/kg)	Reported SAR(1g) (W/kg)	Power Drift (dB)
Ch.	MHz										
810	1909.8	Left	Touch	/	29.28	31	0.112	0.17	0.178	0.26	-0.13
661	1880	Left	Touch	/	29.36	31	0.12	0.18	0.191	0.28	0.06
512	1850.2	Left	Touch	Fig.3	29.32	31	0.123	0.18	0.194	0.29	-0.07
661	1880	Left	Tilt	/	29.36	31	0.072	0.11	0.109	0.16	0.01
661	1880	Right	Touch	/	29.36	31	0.096	0.14	0.153	0.22	0.02
661	1880	Right	Tilt	/	29.36	31	0.07	0.10	0.111	0.16	-0.15

Table 14.1-4: SAR Values (GSM 1900 MHz Band - Body)

Frequency		Mode (number of timeslots)	Test Position	Figure No.	Conducted Power (dBm)	Max. tune-up Power (dBm)	Measured SAR(10g) (W/kg)	Reported SAR(10g) (W/kg)	Measured SAR(1g) (W/kg)	Reported SAR(1g) (W/kg)	Power Drift (dB)	
Ch.	MHz											
		Ambient Temperature: 22.8 °C						Liquid Temperature: 21.2 °C				
661	1880	GPRS (2)	Front	/	27.36	29	0.247	0.36	0.472	0.69	0.1	
661	1880	GPRS (2)	Rear	/	27.36	29	0.241	0.35	0.436	0.64	0.07	
661	1880	GPRS (2)	Left	/	27.36	29	0.108	0.16	0.193	0.28	-0.19	
661	1880	GPRS (2)	Right	/	27.36	29	0.049	0.07	0.076	0.11	-0.14	
810	1909.8	GPRS (2)	Bottom	/	27.48	29	0.44	0.62	0.839	1.19	-0.04	
661	1880	GPRS (2)	Bottom	/	27.36	29	0.42	0.61	0.745	1.09	-0.1	
512	1850.2	GPRS (2)	Bottom	Fig.4	27.20	29	0.473	0.72	0.867	1.31	0.05	
512	1850.2	EGPRS (2)	Bottom	/	27.19	29	0.42	0.64	0.758	1.15	0.06	
512	1850.2	GPRS (2)	Bottom	H	27.20	29	0.453	0.69	0.791	1.20	0.16	

Note: The distance between the EUT and the phantom bottom is 10mm.

Table 14.1-5: SAR Values (WCDMA 1900 MHz Band - Head)

Frequency		Side	Test Position	Figure No.	Conducted Power (dBm)	Max. tune-up Power (dBm)	Measured SAR(10g) (W/kg)	Reported SAR(10g) (W/kg)	Measured SAR(1g) (W/kg)	Reported SAR(1g) (W/kg)	Power Drift (dB)	
Ch.	MHz											
		Ambient Temperature: 22.5 °C						Liquid Temperature: 21.9 °C				
9538	1907.6	Left	Touch	/	24.02	25	0.308	0.39	0.472	0.59	0.1	
9400	1880	Left	Touch	/	24.03	25	0.301	0.38	0.467	0.58	0.05	
9262	1852.4	Left	Touch	Fig.5	24.10	25	0.313	0.39	0.484	0.60	0.08	
9400	1880	Left	Tilt		24.03	25	0.195	0.24	0.289	0.36	0.13	
9400	1880	Right	Touch		24.03	25	0.271	0.34	0.423	0.53	0.03	
9400	1880	Right	Tilt	/	24.03	25	0.237	0.30	0.367	0.46	-0.04	

Table 14.1-6: SAR Values (WCDMA 1900 MHz Band - Body)

Frequency		Test Position	Figure No.	Ambient Temperature: 23 °C		Liquid Temperature: 22.5 °C		Measured SAR(1g) (W/kg)	Reported SAR(1g) (W/kg)	Power Drift (dB)
Ch.	MHz			Conducted Power (dBm)	Max. tune-up Power (dBm)	Measured SAR(10g) (W/kg)	Reported SAR(10g) (W/kg)			
9538	1907.6	Front	/	22.91	24	0.44	0.57	0.781	1.00	-0.01
9400	1880	Front	/	22.95	24	0.439	0.56	0.78	0.99	-0.14
9262	1852.4	Front	/	22.93	24	0.437	0.56	0.776	0.99	0.09
9538	1907.6	Rear	/	22.91	24	0.476	0.61	0.825	1.06	0.09
9400	1880	Rear	/	22.95	24	0.457	0.58	0.811	1.03	-0.14
9262	1852.4	Rear	/	22.93	24	0.423	0.54	0.756	0.97	-0.05
9400	1880	Left	/	22.95	24	0.207	0.26	0.359	0.46	0.1
9400	1880	Right	/	22.95	24	0.096	0.12	0.169	0.22	0.04
9538	1907.6	Bottom	/	22.91	24	0.567	0.73	1.03	1.32	0.09
9400	1880	Bottom	/	22.95	24	0.564	0.72	1.01	1.29	0.01
9262	1852.4	Bottom	Fig.6	22.93	24	0.612	0.78	1.11	1.42	0.08
9262	1852.4	Bottom	H	22.93	24	0.562	0.72	1.02	1.30	0.09

Note1: The distance between the EUT and the phantom bottom is 10mm

Table 14.1-7: SAR Values (WCDMA 1700 MHz Band - Head)

Frequency		Side	Test Position	Figure No.	Ambient Temperature: 22.5 °C		Liquid Temperature: 21.9 °C		Measured SAR(1g) (W/kg)	Reported SAR(1g) (W/kg)	Power Drift (dB)
Ch.	MHz				Conducted Power (dBm)	Max. tune-up Power (dBm)	Measured SAR(10g) (W/kg)	Reported SAR(10g) (W/kg)			
1412	1732.4	Left	Touch	/	23.81	25	0.154	0.20	0.226	0.30	-0.05
1412	1732.4	Left	Tilt	/	23.81	25	0.109	0.14	0.16	0.21	-0.07
1513	1752.6	Right	Touch	/	23.85	25	0.206	0.27	0.31	0.40	0.01
1412	1732.4	Right	Touch	/	23.81	25	0.202	0.27	0.305	0.40	0.02
1312	1712.4	Right	Touch	Fig.7	23.89	25	0.21	0.27	0.319	0.41	-0.05
1412	1732.4	Right	Tilt	/	23.81	25	0.1	0.13	0.145	0.19	0.05

Table 14.1-8: SAR Values (WCDMA 1700 MHz Band - Body)

Ambient Temperature: 23 °C						Liquid Temperature: 22.5°C				
Frequency		Test Position	Figure No.	Conducted Power (dBm)	Max. tune-up Power (dBm)	Measured SAR(10g) (W/kg)	Reported SAR(10g) (W/kg)	Measured SAR(1g) (W/kg)	Reported SAR(1g) (W/kg)	Power Drift (dB)
Ch.	MHz									
1412	1732.5	Front	/	19.90	21	0.27	0.35	0.49	0.63	0.03
1513	1752.6	Rear	/	19.88	21	0.349	0.45	0.656	0.85	-0.05
1412	1732.5	Rear	/	19.90	21	0.434	0.56	0.814	1.05	-0.18
1312	1712.4	Rear	/	19.88	21	0.532	0.69	1.01	1.31	0.05
1412	1732.5	Left	/	19.90	21	0.049	0.06	0.08	0.10	0.01
1412	1732.5	Right	/	19.90	21	0.056	0.07	0.094	0.12	-0.14
1513	1752.6	Bottom	/	19.88	21	0.455	0.59	0.842	1.09	-0.02
1412	1732.5	Bottom	/	19.90	21	0.524	0.68	0.915	1.18	-0.18
1312	1712.4	Bottom	Fig.8	19.88	21	0.626	0.81	1.16	1.50	0.05
1312	1712.4	Bottom	H	19.88	21	0.588	0.77	0.983	1.27	0.04

Note1: The distance between the EUT and the phantom bottom is 10mm

Table 14.1-9: SAR Values (WCDMA 1700 MHz Band - Body)

Ambient Temperature: 23 °C						Liquid Temperature: 22.5°C				
Frequency		Test Position	Figure No.	Conducted Power (dBm)	Max. tune-up Power (dBm)	Measured SAR(10g) (W/kg)	Reported SAR(10g) (W/kg)	Measured SAR(1g) (W/kg)	Reported SAR(1g) (W/kg)	Power Drift (dB)
Ch.	MHz									
1412	1732.4	Front	/	22.91	23	0.211	0.22	0.35	0.36	-0.12
1513	1752.6	Rear	/	22.90	23	0.318	0.33	0.557	0.57	0.1
1412	1732.4	Rear	/	22.91	23	0.39	0.40	0.688	0.70	0.02
1312	1712.4	Rear	Fig.9	22.89	23	0.492	0.50	0.872	0.89	0.08

Note1: The distance between the EUT and the phantom bottom is 15mm

Table 14.1-10: SAR Values (WCDMA 850 MHz Band - Head)

Ambient Temperature: 23.3 °C						Liquid Temperature: 22.8°C					
Frequency		Side	Test Position	Figure No.	Conducted Power (dBm)	Max. tune-up Power (dBm)	Measured SAR(10g) (W/kg)	Reported SAR(10g) (W/kg)	Measured SAR(1g) (W/kg)	Reported SAR(1g) (W/kg)	Power Drift (dB)
Ch.	MHz										
4183	836.6	Left	Touch	/	22.93	24	0.165	0.21	0.213	0.27	-0.09
4183	836.6	Left	Tilt	/	22.93	24	0.09	0.12	0.109	0.14	0.14
4233	846.6	Right	Touch	/	22.95	24	0.167	0.21	0.21	0.27	0.02
4183	836.6	Right	Touch	Fig.10	22.93	24	0.175	0.22	0.224	0.29	-0.01
4132	826.4	Right	Touch	/	22.82	24	0.099	0.13	0.128	0.17	-0.18
4183	836.6	Right	Tilt	/	22.93	24	0.118	0.15	0.145	0.19	0.05

Table 14.1-11: SAR Values (WCDMA 850 MHz Band - Body)

Frequency		Test Position	Figure No.	Conducted Power (dBm)	Max. tune-up Power (dBm)	Ambient Temperature: 23.3 °C		Liquid Temperature: 22.8 °C		Power Drift (dB)
Ch.	MHz					Measured SAR(10g) (W/kg)	Reported SAR(10g) (W/kg)	Measured SAR(1g) (W/kg)	Reported SAR(1g) (W/kg)	
4183	836.6	Front	/	22.93	24	0.155	0.20	0.201	0.26	0.03
4233	846.6	Rear	/	22.95	24	0.237	0.30	0.308	0.39	0.13
4183	836.6	Rear	/	22.93	24	0.219	0.28	0.283	0.36	-0.1
4132	826.4	Rear	Fig.11	22.82	24	0.269	0.35	0.347	0.46	0.01
4183	836.6	Left	/	22.93	24	0.149	0.19	0.211	0.27	0.11
4183	836.6	Right	/	22.93	24	0.141	0.18	0.197	0.25	-0.17
4183	836.6	Bottom	/	22.93	24	<0.01	<0.01	<0.01	<0.01	/

Note: The distance between the EUT and the phantom bottom is 10mm.

Table 14.1-12: SAR Values (LTE Band12 - Head)

Frequency		Mode	Side	Test Position	Figure No.	Conduct ed Power (dBm)	Max. tune-up Power (dBm)	Ambient Temperature: 23.3 °C		Liquid Temperature: 22.8 °C		Power Drift (dB)
Ch.	MHz							Measured SAR(10g) (W/kg)	Reported SAR(10g) (W/kg)	Measured SAR(1g) (W/kg)	Reported SAR(1g) (W/kg)	
23060	704	1RB_Mid	Left	Touch	/	24.70	25.5	0.235	0.28	0.295	0.35	-0.07
23060	704	1RB_Mid	Left	Tilt	/	24.70	25.5	0.148	0.18	0.179	0.22	-0.19
23060	704	1RB_Mid	Right	Touch	Fig.12	24.70	25.5	0.251	0.30	0.315	0.38	0.14
23060	704	1RB_Mid	Right	Tilt	/	24.70	25.5	0.162	0.19	0.198	0.24	0.02
23130	711	25RB_Low	Left	Touch	/	23.74	24.5	0.191	0.23	0.239	0.28	-0.15
23130	711	25RB_Low	Left	Tilt	/	23.74	24.5	0.123	0.15	0.149	0.18	0.12
23130	711	25RB_Low	Right	Touch	/	23.74	24.5	0.196	0.23	0.244	0.29	-0.1
23130	711	25RB_Low	Right	Tilt	/	23.74	24.5	0.126	0.15	0.154	0.18	-0.1

Note1: The LTE mode is QPSK_10MHz.

Table 14.1-13: SAR Values (LTE Band12 - Body)

Frequency		Mode	Test Position	Figure No.	Ambient Temperature: 23.3 °C		Liquid Temperature: 22.8°C				
Ch.	MHz				Conducted Power (dBm)	Max. tune-up Power (dBm)	Measured SAR(10g) (W/kg)	Reported SAR(10g) (W/kg)	Measured SAR(1g) (W/kg)	Reported SAR(1g) (W/kg)	Power Drift (dB)
23060	704	1RB_Mid	Front	/	24.62	25.5	0.221	0.27	0.278	0.34	0.12
23060	704	1RB_Mid	Rear	Fig.13	24.62	25.5	0.351	0.43	0.445	0.54	0.07
23060	704	1RB_Mid	Left	/	24.62	25.5	0.24	0.29	0.323	0.40	-0.15
23060	704	1RB_Mid	Right	/	24.62	25.5	0.26	0.32	0.354	0.43	0.11
23060	704	1RB_Mid	Bottom	/	24.62	25.5	0.021	0.03	0.035	0.04	-0.08
23130	711	25RB_Low	Front	/	23.74	24.5	0.17	0.20	0.215	0.26	0.14
23130	711	25RB_Low	Rear	/	23.74	24.5	0.266	0.32	0.34	0.41	0.09
23130	711	25RB_Low	Left	/	23.74	24.5	0.193	0.23	0.264	0.31	0.18
23130	711	25RB_Low	Right	/	23.74	24.5	0.207	0.25	0.284	0.34	-0.03
23130	711	25RB_Low	Bottom	/	23.74	24.5	<0.01	<0.01	<0.01	<0.01	/

Note1: The distance between the EUT and the phantom bottom is 10mm.

Note2: The LTE mode is QPSK_10MHz.

Table 14.1-14: SAR Values (LTE Band13 - Head)

Frequency		Mode	Side	Test Position	Figure No.	Ambient Temperature: 23.3 °C		Liquid Temperature: 22.8°C				
Ch.	MHz					Conduct ed Power (dBm)	Max. tune-up Power (dBm)	Measured SAR(10g) (W/kg)	Reported SAR(10g) (W/kg)	Measured SAR(1g) (W/kg)	Reported SAR(1g) (W/kg)	Power Drift (dB)
23230	782	1RB_Mid	Left	Touch	/	24.25	25.5	0.221	0.29	0.282	0.38	0.05
23230	782	1RB_Mid	Left	Tilt	/	24.25	25.5	0.147	0.20	0.18	0.24	0.07
23230	782	1RB_Mid	Right	Touch	Fig.14	24.25	25.5	0.244	0.33	0.309	0.41	0.17
23230	782	1RB_Mid	Right	Tilt	/	24.25	25.5	0.188	0.25	0.23	0.31	0.02
23230	782	25RB_Mid	Left	Touch	/	23.24	24.5	0.168	0.22	0.215	0.29	0.15
23230	782	25RB_Mid	Left	Tilt	/	23.24	24.5	0.119	0.16	0.145	0.19	-0.06
23230	782	25RB_Mid	Right	Touch	/	23.24	24.5	0.184	0.25	0.232	0.31	-0.04
23230	782	25RB_Mid	Right	Tilt	/	23.24	24.5	0.139	0.19	0.171	0.23	-0.04

Note1: The LTE mode is QPSK_10MHz.

Table 14.1-15: SAR Values (LTE Band13 - Body)

Ambient Temperature: 23.3 °C						Liquid Temperature: 22.8°C					
Frequency		Mode	Test Position	Figure No.	Conducted Power (dBm)	Max. tune-up Power (dBm)	Measured SAR(10g) (W/kg)	Reported SAR(10g) (W/kg)	Measured SAR(1g) (W/kg)	Reported SAR(1g) (W/kg)	Power Drift (dB)
Ch.	MHz										
23230	782	1RB_Mid	Front	/	24.25	25.5	0.26	0.35	0.328	0.44	-0.16
23230	782	1RB_Mid	Rear	Fig.15	24.25	25.5	0.401	0.53	0.509	0.68	-0.03
23230	782	1RB_Mid	Left	/	24.25	25.5	0.275	0.37	0.374	0.50	-0.04
23230	782	1RB_Mid	Right	/	24.25	25.5	0.303	0.40	0.409	0.55	0.05
23230	782	1RB_Mid	Bottom	/	24.25	25.5	0.034	0.05	0.053	0.07	0.09
23230	782	25RB_Mid	Front	/	23.24	24.5	0.201	0.27	0.253	0.34	-0.14
23230	782	25RB_Mid	Rear	/	23.24	24.5	0.312	0.42	0.395	0.53	0.13
23230	782	25RB_Mid	Left	/	23.24	24.5	0.219	0.29	0.3	0.40	0.07
23230	782	25RB_Mid	Right	/	23.24	24.5	0.237	0.32	0.323	0.43	-0.07
23230	782	25RB_Mid	Bottom	/	23.24	24.5	0.025	0.03	0.037	0.05	0.09

Note1: The distance between the EUT and the phantom bottom is 10mm.

Note2: The LTE mode is QPSK_10MHz.

Table 14.1-16: SAR Values (LTE Band25 - Head)

Ambient Temperature: 22.5 °C						Liquid Temperature: 21.9°C						
Frequency		Mode	Side	Test Position	Figure No.	Conduct ed Power (dBm)	Max. tune-up Power (dBm)	Measured SAR(10g) (W/kg)	Reported SAR(10g) (W/kg)	Measured SAR(1g) (W/kg)	Reported SAR(1g) (W/kg)	Power Drift (dB)
Ch.	MHz											
26140	1860	1RB_Mid	Left	Touch	Fig.16	24.10	25	0.304	0.37	0.469	0.58	-0.05
26140	1860	1RB_Mid	Left	Tilt	/	24.10	25	0.19	0.23	0.285	0.35	-0.03
26140	1860	1RB_Mid	Right	Touch		24.10	25	0.259	0.32	0.403	0.50	0.01
26140	1860	1RB_Mid	Right	Tilt	/	24.10	25	0.196	0.24	0.3	0.37	-0.16
26140	1860	50RB_Mid	Left	Touch	/	23.15	24	0.216	0.26	0.331	0.40	0.01
26140	1860	50RB_Mid	Left	Tilt	/	23.15	24	0.126	0.15	0.189	0.23	0.15
26140	1860	50RB_Mid	Right	Touch	/	23.15	24	0.193	0.23	0.294	0.36	0.05
26140	1860	50RB_Mid	Right	Tilt	/	23.15	24	0.147	0.18	0.224	0.27	-0.13

Note1: The LTE mode is QPSK_20MHz.

Table 14.1-17: SAR Values (LTE Band25 - Body)

Frequency		Mode	Test Position	Figure No.	Conducted Power (dBm)	Max. tune-up Power (dBm)	Measured SAR(10g) (W/kg)	Reported SAR(10g) (W/kg)	Measured SAR(1g) (W/kg)	Reported SAR(1g) (W/kg)	Power Drift (dB)
Ch.	MHz										
Ambient Temperature: 23 °C						Liquid Temperature: 22.5 °C					
26140	1860	1RB_Mid	Front	/	22.36	23	0.317	0.37	0.544	0.63	-0.05
26140	1860	1RB_Mid	Rear	/	22.36	23	0.326	0.38	0.556	0.64	0.05
26140	1860	1RB_Mid	Left	/	22.36	23	0.146	0.17	0.239	0.28	0.16
26140	1860	1RB_Mid	Right	/	22.36	23	0.069	0.08	0.116	0.13	0.14
26590	1905	1RB_Mid	Bottom	/	22.32	23	0.424	0.50	0.761	0.89	0.15
26365	1882.5	1RB_Mid	Bottom	/	22.27	23	0.439	0.52	0.789	0.93	-0.14
26140	1860	1RB_Mid	Bottom	Fig.17	22.36	23	0.484	0.56	0.874	1.01	-0.15
26140	1860	50RB_Mid	Front	/	22.32	23	0.309	0.36	0.528	0.62	0.08
26140	1860	50RB_Mid	Rear	/	22.32	23	0.319	0.37	0.541	0.63	-0.14
26140	1860	50RB_Mid	Left	/	22.32	23	0.142	0.17	0.234	0.27	0.15
26140	1860	50RB_Mid	Right	/	22.32	23	0.068	0.08	0.116	0.14	0.18
26590	1905	50RB_Mid	Bottom	/	22.31	23	0.417	0.49	0.747	0.88	-0.04
26365	1882.5	50RB_Mid	Bottom	/	22.24	23	0.437	0.52	0.783	0.93	0.11
26140	1860	50RB_Mid	Bottom	/	22.32	23	0.475	0.56	0.848	0.99	0.08
26140	1860	100RB	Bottom	/	22.25	23	0.456	0.54	0.837	0.99	-0.19

Note1: The distance between the EUT and the phantom bottom is 10mm.

Note2: The LTE mode is QPSK_20MHz.

Table 14.1-18: SAR Values (LTE Band25 - Body)

Frequency		Mode	Test Position	Figure No.	Conducted Power (dBm)	Max. tune-up Power (dBm)	Measured SAR(10g) (W/kg)	Reported SAR(10g) (W/kg)	Measured SAR(1g) (W/kg)	Reported SAR(1g) (W/kg)	Power Drift (dB)
Ch.	MHz										
Ambient Temperature: 23 °C						Liquid Temperature: 22.5 °C					
26140	1860	1RB_Mid	Front	Fig.18	23.14	24	0.201	0.25	0.34	0.41	-0.04
26140	1860	1RB_Mid	Rear	/	23.14	24	0.198	0.24	0.333	0.41	-0.17
26140	1860	50RB_Mid	Front	/	23.18	24	0.198	0.24	0.334	0.40	0.07
26140	1860	50RB_Mid	Rear	/	23.18	24	0.193	0.23	0.325	0.39	0.14

Note1: The distance between the EUT and the phantom bottom is 15mm.

Note2: The LTE mode is QPSK_20MHz.

Table 14.1-19: SAR Values (LTE Band26 - Head)

Frequency		Mode	Side	Test Position	Figure No.	Conducted Power (dBm)	Max. tune-up Power (dBm)	Measured SAR(10g) (W/kg)	Reported SAR(10g) (W/kg)	Measured SAR(1g) (W/kg)	Reported SAR(1g) (W/kg)	Power Drift (dB)
Ch.	MHz											
Ambient Temperature: 23.3 °C Liquid Temperature: 22.8 °C												
26865	831.5	1RB_Low	Left	Touch	Fig.19	24.28	25.5	0.234	0.31	0.297	0.39	0.05
26865	831.5	1RB_Low	Left	Tilt	/	24.28	25.5	0.143	0.19	0.173	0.23	0.05
26865	831.5	1RB_Low	Right	Touch	/	24.28	25.5	0.218	0.29	0.277	0.37	0.04
26865	831.5	1RB_Low	Right	Tilt	/	24.28	25.5	0.137	0.18	0.168	0.22	-0.08
26865	831.5	36RB_Low	Left	Touch	/	23.34	24.5	0.19	0.25	0.242	0.32	0.15
26865	831.5	36RB_Low	Left	Tilt	/	23.34	24.5	0.116	0.15	0.142	0.19	0.13
26865	831.5	36RB_Low	Right	Touch	/	23.34	24.5	0.175	0.23	0.222	0.29	0.08
26865	831.5	36RB_Low	Right	Tilt	/	23.34	24.5	0.11	0.14	0.136	0.18	-0.11

Note1: The LTE mode is QPSK_15MHz.

Table 14.1-20: SAR Values (LTE Band26 - Body)

Frequency		Mode	Test Position	Figure No.	Conducted Power (dBm)	Max. tune-up Power (dBm)	Measured SAR(10g) (W/kg)	Reported SAR(10g) (W/kg)	Measured SAR(1g) (W/kg)	Reported SAR(1g) (W/kg)	Power Drift (dB)
Ch.	MHz										
Ambient Temperature: 23.3 °C Liquid Temperature: 22.8 °C											
26865	831.5	1RB_Low	Front	/	24.28	25.5	0.133	0.18	0.168	0.22	-0.17
26865	831.5	1RB_Low	Rear	Fig.20	24.28	25.5	0.358	0.47	0.457	0.61	0.04
26865	831.5	1RB_Low	Left	/	24.28	25.5	0.24	0.32	0.334	0.44	0.11
26865	831.5	1RB_Low	Right	/	24.28	25.5	0.228	0.30	0.315	0.42	-0.18
26865	831.5	1RB_Low	Bottom	/	24.28	25.5	0.03	0.04	0.044	0.06	0.16
26865	831.5	36RB_Low	Front	/	23.34	24.5	0.201	0.26	0.255	0.33	-0.05
26865	831.5	36RB_Low	Rear	/	23.34	24.5	0.302	0.39	0.389	0.51	-0.18
26865	831.5	36RB_Low	Left	/	23.34	24.5	0.185	0.24	0.256	0.33	-0.07
26865	831.5	36RB_Low	Right	/	23.34	24.5	0.178	0.23	0.249	0.33	0.19
26865	831.5	36RB_Low	Bottom	/	23.34	24.5	<0.01	<0.01	<0.01	<0.01	/

Note1: The distance between the EUT and the phantom bottom is 10mm.

Note2: The LTE mode is QPSK_15MHz.

Table 14.1-21: SAR Values (LTE Band41 - Head)

Ambient Temperature: 22.5 °C						Liquid Temperature: 21.9°C						
Frequency		Mode	Side	Test Position	Figure No.	Conducted Power (dBm)	Max. tune-up Power (dBm)	Measured SAR(10g) (W/kg)	Reported SAR(10g) (W/kg)	Measured SAR(1g) (W/kg)	Reported SAR(1g) (W/kg)	Power Drift (dB)
Ch.	MHz											
40620	2593	1RB-Low	Left	Touch	/	23.55	24	0.054	0.06	0.072	0.08	0.09
40620	2593	1RB-Low	Left	Tilt	/	23.55	24	0.032	0.04	0.045	0.05	-0.17
40620	2593	1RB-Low	Right	Touch	Fig.21	23.55	24	0.052	0.06	0.096	0.11	-0.12
40620	2593	1RB-Low	Right	Tilt	/	23.55	24	0.023	0.03	0.045	0.05	0.19
40620	2593	50RB-Low	Left	Touch	/	22.50	23	0.041	0.05	0.053	0.06	0.15
40620	2593	50RB-Low	Left	Tilt	/	22.50	23	0.024	0.03	0.033	0.04	-0.16
40620	2593	50RB-Low	Right	Touch	/	22.50	23	0.045	0.05	0.083	0.09	0.05
40620	2593	50RB-Low	Right	Tilt	/	22.50	23	0.018	0.02	0.034	0.04	0

Note1: The LTE mode is QPSK_20MHz.

Table 14.1-22: SAR Values (LTE Band41 - Body)

Ambient Temperature: 23 °C						Liquid Temperature: 22.5°C					
Frequency		Mode	Test Position	Figure No.	Conducted Power (dBm)	Max. tune-up Power (dBm)	Measured SAR(10g) (W/kg)	Reported SAR(10g) (W/kg)	Measured SAR(1g) (W/kg)	Reported SAR(1g) (W/kg)	Power Drift (dB)
Ch.	MHz										
40620	2593	1RB-Low	Front	/	22.54	23	0.194	0.22	0.413	0.46	-0.04
41490	2680	1RB-Low	Rear	/	22.53	23	0.422	0.47	0.942	1.05	0.07
41055	2636.5	1RB-Low	Rear	/	22.31	23	0.453	0.53	1.01	1.18	-0.02
40620	2593	1RB-Low	Rear	/	22.54	23	0.34	0.38	0.762	0.85	-0.16
40185	2549.5	1RB-Low	Rear	/	22.42	23	0.245	0.28	0.545	0.62	0.08
39750	2506	1RB-Low	Rear	/	22.33	23	0.18	0.21	0.394	0.46	0.19
40620	2593	1RB-Low	Left	/	22.54	23	0.05	0.06	0.092	0.10	-0.09
40620	2593	1RB-Low	Right	/	22.54	23	0.05	0.06	0.09	0.10	-0.13
40620	2593	1RB-Low	Bottom	/	22.54	23	0.293	0.33	0.642	0.71	0.02
40620	2593	50RB-Low	Front	/	22.54	23	0.199	0.22	0.425	0.47	-0.02
41490	2680	50RB-Low	Rear	/	22.48	23	0.415	0.47	0.933	1.05	-0.16
41055	2636.5	50RB-Low	Rear	Fig.22	22.33	23	0.463	0.54	1.04	1.21	0.04
40620	2593	50RB-Low	Rear	/	22.49	23	0.353	0.40	0.791	0.89	-0.04
40185	2549.5	50RB-Low	Rear	/	22.35	23	0.257	0.30	0.572	0.66	0.09
39750	2506	50RB-Low	Rear	/	22.25	23	0.178	0.21	0.392	0.47	-0.17
40620	2593	50RB-Low	Left	/	22.54	23	0.048	0.05	0.087	0.10	-0.18
40620	2593	50RB-Low	Right	/	22.54	23	0.052	0.06	0.092	0.10	-0.15
40620	2593	50RB-Low	Bottom	/	22.49	23	0.307	0.35	0.675	0.76	-0.14
41490	2680	100RB	Rear	/	22.45	23	0.401	0.46	0.898	1.02	-0.18
41055	2636.5	50RB-Low	Rear	H	22.33	23	0.405	0.47	0.869	1.01	0.15

Note1: The distance between the EUT and the phantom bottom is 10mm.

Note2: The LTE mode is QPSK_20MHz.

Table 14.1-23: SAR Values (LTE Band41 - Body)

Ambient Temperature: 23 °C					Liquid Temperature: 22.5°C						
Frequency		Mode	Test Position	Figure No.	Conducted Power (dBm)	Max. tune-up Power (dBm)	Measured SAR(10g) (W/kg)	Reported SAR(10g) (W/kg)	Measured SAR(1g) (W/kg)	Reported SAR(1g) (W/kg)	Power Drift (dB)
Ch.	MHz										
40620	2593	1RB-Low	Front	/	23.55	24	0.113	0.13	0.223	0.25	0.03
40620	2593	1RB-Low	Rear	Fig.23	23.55	24	0.22	0.24	0.452	0.50	0.08
40620	2593	50RB-Low	Front	/	22.50	23	0.092	0.10	0.182	0.20	0.12
40620	2593	50RB-Low	Rear	/	22.50	23	0.179	0.20	0.367	0.41	-0.09

Note1: The distance between the EUT and the phantom bottom is 15mm.

Note2: The LTE mode is QPSK_20MHz.

Table 14.1-24: SAR Values (LTE Band41 HPUE - Head)

Ambient Temperature: 22.5 °C					Liquid Temperature: 21.9°C							
Frequency		Mode	Side	Test Position	Figure No.	Conducted Power (dBm)	Max. tune-up Power (dBm)	Measured SAR(10g) (W/kg)	Reported SAR(10g) (W/kg)	Measured SAR(1g) (W/kg)	Reported SAR(1g) (W/kg)	Power Drift (dB)
Ch.	MHz											
40620	2593	1RB-Low	Left	Touch	/	26.41	27	0.052	0.06	0.091	0.10	0.02
40620	2593	1RB-Low	Left	Tilt	/	26.41	27	0.027	0.03	0.05	0.06	-0.03
40620	2593	1RB-Low	Right	Touch	Fig.24	26.41	27	0.075	0.09	0.135	0.15	0.08
40620	2593	1RB-Low	Right	Tilt	/	26.41	27	0.033	0.04	0.06	0.07	0.03
40620	2593	50RB-Low	Left	Touch	/	25.55	26	0.037	0.04	0.065	0.07	0.19
40620	2593	50RB-Low	Left	Tilt	/	25.55	26	0.031	0.03	0.053	0.06	0.12
40620	2593	50RB-Low	Right	Touch	/	25.55	26	0.062	0.07	0.11	0.12	0.19
40620	2593	50RB-Low	Right	Tilt	/	25.55	26	0.024	0.03	0.045	0.05	-0.07

Note1: The LTE mode is QPSK_20MHz.

Table 14.1-25: SAR Values (LTE Band41 HPUE - Body)

Frequency		Mode	Test Position	Figure No.	Conducted Power (dBm)	Max. tune-up Power (dBm)	Measured SAR(10g) (W/kg)	Reported SAR(10g) (W/kg)	Measured SAR(1g) (W/kg)	Reported SAR(1g) (W/kg)	Power Drift (dB)
Ch.	MHz										
Ambient Temperature: 23 °C Liquid Temperature: 22.5°C											
40620	2593	1RB-Low	Front	/	24.41	25	0.194	0.22	0.425	0.49	-0.1
41490	2680	1RB-Low	Rear	/	24.39	25	0.419	0.48	1.03	1.19	0.14
41055	2636.5	1RB-Low	Rear	/	24.18	25	0.468	0.57	1.04	1.26	0.05
40620	2593	1RB-Low	Rear	/	24.41	25	0.358	0.41	0.832	0.95	0.16
40185	2549.5	1RB-Low	Rear	/	24.33	25	0.247	0.29	0.543	0.63	-0.05
39750	2506	1RB-Low	Rear	/	24.23	25	0.178	0.21	0.387	0.46	0.12
40620	2593	1RB-Low	Left	/	24.41	25	0.051	0.06	0.099	0.11	0.19
40620	2593	1RB-Low	Right	/	24.41	25	0.048	0.05	0.088	0.10	0.02
40620	2593	1RB-Low	Bottom	/	24.41	25	0.291	0.33	0.63	0.72	0.18
40620	2593	50RB-Low	Front	/	24.37	25	0.201	0.23	0.443	0.51	-0.03
41490	2680	50RB-Low	Rear	/	24.34	25	0.416	0.48	1.02	1.19	-0.01
41055	2636.5	50RB-Low	Rear	Fig.25	24.20	25	0.477	0.57	1.08	1.30	-0.09
40620	2593	50RB-Low	Rear	/	24.37	25	0.371	0.43	0.863	1.00	0.08
40185	2549.5	50RB-Low	Rear	/	24.25	25	0.259	0.31	0.571	0.68	-0.03
39750	2506	50RB-Low	Rear	/	24.12	25	0.177	0.22	0.388	0.48	0.06
40620	2593	50RB-Low	Left	/	24.37	25	0.049	0.06	0.095	0.11	0.11
40620	2593	50RB-Low	Right	/	24.37	25	0.05	0.06	0.09	0.10	0.07
40620	2593	50RB-Low	Bottom	/	24.37	25	0.303	0.35	0.666	0.77	0.02
40620	2593	100RB	Rear	/	24.32	25	0.368	0.43	0.865	1.01	-0.09
41055	2636.5	50RB-Low	Rear	H	24.20	25	0.423	0.51	0.924	1.11	0.07

Note1: The distance between the EUT and the phantom bottom is 10mm.

Note2: The LTE mode is QPSK_20MHz.

Table 14.1-26: SAR Values (LTE Band41 HPUE - Body)

Frequency		Mode	Test Position	Figure No.	Conducted Power (dBm)	Max. tune-up Power (dBm)	Measured SAR(10g) (W/kg)	Reported SAR(10g) (W/kg)	Measured SAR(1g) (W/kg)	Reported SAR(1g) (W/kg)	Power Drift (dB)
Ch.	MHz										
Ambient Temperature: 23 °C Liquid Temperature: 22.5°C											
40620	2593	1RB-Low	Front	/	26.41	27	0.186	0.21	0.363	0.42	-0.05
41490	2680	1RB-Low	Rear	/	26.31	27	0.356	0.42	0.736	0.86	0.16
41055	2636.5	1RB-Low	Rear	Fig.26	26.13	27	0.432	0.53	0.894	1.09	0.02
40620	2593	1RB-Low	Rear	/	26.41	27	0.352	0.40	0.724	0.83	-0.17
40185	2549.5	1RB-Low	Rear	/	26.33	27	0.23	0.27	0.474	0.55	0.11
39750	2506	1RB-Low	Rear	/	26.28	27	0.156	0.18	0.315	0.37	0.04
40620	2593	50RB-Low	Front	/	25.55	26	0.151	0.17	0.295	0.33	-0.04
40620	2593	50RB-Low	Rear	/	25.55	26	0.291	0.32	0.598	0.66	0.08
40620	2593	100RB	Rear	/	25.38	26	0.297	0.34	0.611	0.70	0.01

Note1: The distance between the EUT and the phantom bottom is 15mm.

Note2: The LTE mode is QPSK_20MHz.

Table 14.1-27: SAR Values (LTE Band66 - Head)

Frequency		Mode	Side	Test Position	Figure No.	Conduct ed Power (dBm)	Max. tune-up Power (dBm)	Measured SAR(10g) (W/kg)	Reported SAR(10g) (W/kg)	Measured SAR(1g) (W/kg)	Reported SAR(1g) (W/kg)	Power Drift (dB)
Ch.	MHz											
Ambient Temperature: 22.5 °C Liquid Temperature: 21.9°C												
132572	1770	1RB_Mid	Left	Touch	/	24.09	25	0.188	0.23	0.28	0.35	0.04
132572	1770	1RB_Mid	Left	Tilt	/	24.09	25	0.115	0.14	0.168	0.21	-0.16
132572	1770	1RB_Mid	Right	Touch	Fig.27	24.09	25	0.233	0.29	0.363	0.45	0.18
132572	1770	1RB_Mid	Right	Tilt	/	24.09	25	0.143	0.18	0.214	0.26	0.16
132572	1770	50RB_Low	Left	Touch	/	23.17	24	0.136	0.16	0.201	0.24	-0.12
132572	1770	50RB_Low	Left	Tilt	/	23.17	24	0.077	0.09	0.111	0.13	0.01
132572	1770	50RB_Low	Right	Touch	/	23.17	24	0.191	0.23	0.293	0.35	-0.1
132572	1770	50RB_Low	Right	Tilt	/	23.17	24	0.108	0.13	0.161	0.19	-0.16

Note1: The LTE mode is QPSK_20MHz.

Table 14.1-28: SAR Values (LTE Band66 - Body)

Frequency		Mode	Test Position	Figure No.	Conducted Power (dBm)	Max. tune-up Power (dBm)	Measured SAR(10g) (W/kg)	Reported SAR(10g) (W/kg)	Measured SAR(1g) (W/kg)	Reported SAR(1g) (W/kg)	Power Drift (dB)
Ch.	MHz										
Ambient Temperature: 23 °C		Liquid Temperature: 22.5 °C									
132072	1720	1RB_Mid	Front	/	19.08	20	0.133	0.16	0.216	0.27	-0.1
132072	1720	1RB_Mid	Rear	/	19.08	20	0.218	0.27	0.406	0.50	-0.15
132072	1720	1RB_Mid	Left	/	19.08	20	0.052	0.06	0.084	0.10	0.18
132072	1720	1RB_Mid	Right	/	19.08	20	0.031	0.04	0.048	0.06	-0.14
132572	1770	1RB_Mid	Bottom	/	19.06	20	0.299	0.37	0.55	0.68	-0.18
132322	1745	1RB_Mid	Bottom	/	19.00	20	0.357	0.45	0.656	0.83	0.14
132072	1720	1RB_Mid	Bottom	Fig.28	19.08	20	0.441	0.55	0.815	1.01	-0.14
132572	1770	50RB_Low	Front	/	19.11	20	0.129	0.16	0.219	0.27	0.11
132572	1770	50RB_Low	Rear	/	19.11	20	0.225	0.28	0.422	0.52	0.04
132572	1770	50RB_Low	Left	/	19.11	20	0.049	0.06	0.078	0.10	0.17
132572	1770	50RB_Low	Right	/	19.11	20	0.03	0.04	0.047	0.06	0.06
132572	1770	50RB_Low	Bottom	/	19.11	20	0.307	0.38	0.564	0.69	-0.15
132572	1770	100RB	Bottom	/	19.06	20	0.297	0.37	0.544	0.68	0.14

Note1: The distance between the EUT and the phantom bottom is 10mm.

Note2: The LTE mode is QPSK_20MHz.

Table 14.1-29: SAR Values (LTE Band66 - Body)

Frequency		Mode	Test Position	Figure No.	Conducted Power (dBm)	Max. tune-up Power (dBm)	Measured SAR(10g) (W/kg)	Reported SAR(10g) (W/kg)	Measured SAR(1g) (W/kg)	Reported SAR(1g) (W/kg)	Power Drift (dB)
Ch.	MHz										
Ambient Temperature: 23 °C		Liquid Temperature: 22.5 °C									
26140	1860	1RB_Mid	Front	/	22.03	23	0.152	0.19	0.246	0.31	-0.02
26140	1860	1RB_Mid	Rear	/	22.03	23	0.224	0.28	0.386	0.48	0.08
26140	1860	50RB_Low	Front	/	22.12	23	0.153	0.19	0.249	0.30	-0.06
26140	1860	50RB_Low	Rear	Fig.29	22.12	23	0.229	0.28	0.397	0.49	0.03

Note1: The distance between the EUT and the phantom bottom is 15mm.

Note2: The LTE mode is QPSK_20MHz.

Table 14.1-30: SAR Values (LTE Band71 - Head)

Frequency		Mode	Side	Test Position	Figure No.	Conducted Power (dBm)	Max. tune-up Power (dBm)	Ambient Temperature: 23.3 °C		Liquid Temperature: 22.8 °C		Power Drift (dB)
Ch.	MHz							Measured SAR(10g) (W/kg)	Reported SAR(10g) (W/kg)	Measured SAR(1g) (W/kg)	Reported SAR(1g) (W/kg)	
133322	683	1RB_Mid	Left	Touch	/	24.57	25.5	0.23	0.28	0.29	0.36	0.18
133322	683	1RB_Mid	Left	Tilt	/	24.57	25.5	0.143	0.18	0.173	0.21	-0.04
133322	683	1RB_Mid	Right	Touch	Fig.30	24.57	25.5	0.248	0.31	0.31	0.38	0.06
133322	683	1RB_Mid	Right	Tilt	/	24.57	25.5	0.137	0.17	0.169	0.21	-0.02
133322	683	50RB_Low	Left	Touch	/	23.75	24.5	0.184	0.22	0.229	0.27	0.12
133322	683	50RB_Low	Left	Tilt	/	23.75	24.5	0.108	0.13	0.131	0.16	-0.09
133322	683	50RB_Low	Right	Touch	/	23.75	24.5	0.207	0.25	0.257	0.31	-0.08
133322	683	50RB_Low	Right	Tilt	/	23.75	24.5	0.107	0.13	0.131	0.16	0.05

Note1: The LTE mode is QPSK_20MHz.

Table 14.1-31: SAR Values (LTE Band71 - Body)

Frequency		Mode	Test Position	Figure No.	Conducted Power (dBm)	Max. tune-up Power (dBm)	Ambient Temperature: 23.3 °C		Liquid Temperature: 22.8 °C		Power Drift (dB)
Ch.	MHz						Measured SAR(10g) (W/kg)	Reported SAR(10g) (W/kg)	Measured SAR(1g) (W/kg)	Reported SAR(1g) (W/kg)	
133322	683	1RB_Mid	Front	/	24.57	25.5	0.192	0.24	0.245	0.30	-0.14
133322	683	1RB_Mid	Rear	Fig.31	24.57	25.5	0.298	0.37	0.38	0.47	-0.02
133322	683	1RB_Mid	Left	/	24.57	25.5	0.206	0.26	0.283	0.35	0.19
133322	683	1RB_Mid	Right	/	24.57	25.5	0.263	0.33	0.356	0.44	-0.14
133322	683	1RB_Mid	Bottom	/	24.57	25.5	0.034	0.04	0.064	0.08	-0.02
133322	683	50RB_Low	Front	/	23.75	24.5	0.159	0.19	0.202	0.24	0.12
133322	683	50RB_Low	Rear	/	23.75	24.5	0.239	0.28	0.302	0.36	0.19
133322	683	50RB_Low	Left	/	23.75	24.5	0.168	0.20	0.228	0.27	0.03
133322	683	50RB_Low	Right	/	23.75	24.5	0.211	0.25	0.289	0.34	0.15
133322	683	50RB_Low	Bottom	/	23.75	24.5	0.025	0.03	0.043	0.05	-0.1

Note1: The distance between the EUT and the phantom bottom is 10mm.

Note2: The LTE mode is QPSK_20MHz.

14.2 SAR results for Standard procedure

There is zoom scan measurement to be added for the highest measured SAR in each exposure configuration/band.

Table 14.2-1: SAR Values (GSM 850 MHz Band - Head)

Ambient Temperature: 23.3 °C						Liquid Temperature: 22.8 °C					
Frequency		Side	Test Position	Figure No.	Conducted Power (dBm)	Max. tune-up Power (dBm)	Measured SAR(10g) (W/kg)	Reported SAR(10g) (W/kg)	Measured SAR(1g) (W/kg)	Reported SAR(1g) (W/kg)	Power Drift (dB)
Ch.	MHz										
251	848.8	Left	Touch	Fig.1	32.12	33.5	0.12	0.16	0.156	0.21	0.09

Table 14.2-2: SAR Values (GSM 850 MHz Band - Body)

Ambient Temperature: 23.3 °C						Liquid Temperature: 22.8 °C					
Frequency		Mode (number of timeslots)	Test Position	Figure No.	Conducted Power (dBm)	Max. tune-up Power (dBm)	Measured SAR(10g) (W/kg)	Reported SAR(10g) (W/kg)	Measured SAR(1g) (W/kg)	Reported SAR(1g) (W/kg)	Power Drift (dB)
Ch.	MHz										
251	848.8	GPRS (2)	Rear	Fig.2	30.61	31.5	0.253	0.31	0.326	0.40	0.13

Note: The distance between the EUT and the phantom bottom is 10mm.

Table 14.2-3: SAR Values (GSM 1900 MHz Band - Head)

Ambient Temperature: 22.5 °C						Liquid Temperature: 21.9 °C					
Frequency		Side	Test Position	Figure No.	Conducted Power (dBm)	Max. tune-up Power (dBm)	Measured SAR(10g) (W/kg)	Reported SAR(10g) (W/kg)	Measured SAR(1g) (W/kg)	Reported SAR(1g) (W/kg)	Power Drift (dB)
Ch.	MHz										
512	1850.2	Left	Touch	Fig.3	29.32	31	0.123	0.18	0.194	0.29	-0.07

Table 14.2-4: SAR Values (GSM 1900 MHz Band - Body)

Ambient Temperature: 22.8 °C						Liquid Temperature: 21.2 °C					
Frequency		Mode (number of timeslots)	Test Position	Figure No.	Conducted Power (dBm)	Max. tune-up Power (dBm)	Measured SAR(10g) (W/kg)	Reported SAR(10g) (W/kg)	Measured SAR(1g) (W/kg)	Reported SAR(1g) (W/kg)	Power Drift (dB)
Ch.	MHz										
512	1850.2	GPRS (2)	Bottom	Fig.4	27.20	29	0.473	0.72	0.867	1.31	0.05

Note: The distance between the EUT and the phantom bottom is 10mm.

Table 14.2-5: SAR Values (WCDMA 1900 MHz Band - Head)

Ambient Temperature: 22.9 °C						Liquid Temperature: 22.3 °C					
Frequency		Side	Test Position	Figure No.	Conducted Power (dBm)	Max. tune-up Power (dBm)	Measured SAR(10g) (W/kg)	Reported SAR(10g) (W/kg)	Measured SAR(1g) (W/kg)	Reported SAR(1g) (W/kg)	Power Drift (dB)
Ch.	MHz										
9262	1852.4	Left	Touch	Fig.5	24.10	25	0.313	0.39	0.484	0.60	0.08

Table 14.2-6: SAR Values (WCDMA 1900 MHz Band - Body)

Ambient Temperature: 23 °C						Liquid Temperature: 22.5°C				
Frequency		Test Position	Figure No.	Conducted Power (dBm)	Max. tune-up Power (dBm)	Measured SAR(10g) (W/kg)	Reported SAR(10g) (W/kg)	Measured SAR(1g) (W/kg)	Reported SAR(1g) (W/kg)	Power Drift (dB)
Ch.	MHz									
9262	1852.4	Bottom	Fig.6	22.93	24	0.612	0.78	1.11	1.42	0.08

Note1: The distance between the EUT and the phantom bottom is 10mm

Table 14.2-7: SAR Values (WCDMA 1700 MHz Band - Head)

Ambient Temperature: 22.5 °C						Liquid Temperature: 21.9°C					
Frequency		Side	Test Position	Figure No.	Conducted Power (dBm)	Max. tune-up Power (dBm)	Measured SAR(10g) (W/kg)	Reported SAR(10g) (W/kg)	Measured SAR(1g) (W/kg)	Reported SAR(1g) (W/kg)	Power Drift (dB)
Ch.	MHz										
1312	1712.4	Right	Touch	Fig.7	23.89	25	0.21	0.27	0.319	0.41	-0.05

Table 14.2-8: SAR Values (WCDMA 1700 MHz Band - Body)

Ambient Temperature: 23 °C						Liquid Temperature: 22.5°C				
Frequency		Test Position	Figure No.	Conducted Power (dBm)	Max. tune-up Power (dBm)	Measured SAR(10g) (W/kg)	Reported SAR(10g) (W/kg)	Measured SAR(1g) (W/kg)	Reported SAR(1g) (W/kg)	Power Drift (dB)
Ch.	MHz									
1312	1712.4	Bottom	Fig.8	19.88	21	0.626	0.81	1.16	1.50	0.05

Note1: The distance between the EUT and the phantom bottom is 10mm

Table 14.2-9: SAR Values (WCDMA 1700 MHz Band - Body)

Ambient Temperature: 23 °C						Liquid Temperature: 22.5°C				
Frequency		Test Position	Figure No.	Conducted Power (dBm)	Max. tune-up Power (dBm)	Measured SAR(10g) (W/kg)	Reported SAR(10g) (W/kg)	Measured SAR(1g) (W/kg)	Reported SAR(1g) (W/kg)	Power Drift (dB)
Ch.	MHz									
1312	1712.4	Rear	Fig.9	22.89	23	0.492	0.50	0.872	0.89	0.08

Note1: The distance between the EUT and the phantom bottom is 15mm

Table 14.2-10: SAR Values (WCDMA 850 MHz Band - Head)

Ambient Temperature: 23.3 °C						Liquid Temperature: 22.8°C					
Frequency		Side	Test Position	Figure No.	Conducted Power (dBm)	Max. tune-up Power (dBm)	Measured SAR(10g) (W/kg)	Reported SAR(10g) (W/kg)	Measured SAR(1g) (W/kg)	Reported SAR(1g) (W/kg)	Power Drift (dB)
Ch.	MHz										
4183	836.6	Right	Touch	Fig.10	22.93	24	0.175	0.22	0.224	0.29	-0.01

Table 14.2-11: SAR Values (WCDMA 850 MHz Band - Body)

Frequency		Test Position	Figure No.	Conducted Power (dBm)	Max. tune-up Power (dBm)	Measured SAR(10g) (W/kg)	Reported SAR(10g) (W/kg)	Measured SAR(1g) (W/kg)	Reported SAR(1g) (W/kg)	Power Drift (dB)
Ch.	MHz									
4132	826.4	Rear	Fig.11	22.82	24	0.269	0.35	0.347	0.46	0.01

Note: The distance between the EUT and the phantom bottom is 10mm.

Table 14.2-12: SAR Values (LTE Band12 - Head)

Frequency		Mode	Side	Test Position	Figure No.	Conducted Power (dBm)	Max. tune-up Power (dBm)	Measured SAR(10g) (W/kg)	Reported SAR(10g) (W/kg)	Measured SAR(1g) (W/kg)	Reported SAR(1g) (W/kg)	Power Drift (dB)
Ch.	MHz											
23060	704	1RB_Mid	Right	Touch	Fig.12	24.70	25.5	0.251	0.30	0.315	0.38	0.14

Note1: The LTE mode is QPSK_10MHz.

Table 14.2-13: SAR Values (LTE Band12 - Body)

Frequency		Mode	Test Position	Figure No.	Conducted Power (dBm)	Max. tune-up Power (dBm)	Measured SAR(10g) (W/kg)	Reported SAR(10g) (W/kg)	Measured SAR(1g) (W/kg)	Reported SAR(1g) (W/kg)	Power Drift (dB)
Ch.	MHz										
23060	704	1RB_Mid	Rear	Fig.13	24.62	25.5	0.351	0.43	0.445	0.54	0.07

Note1: The distance between the EUT and the phantom bottom is 10mm.

Note2: The LTE mode is QPSK_10MHz.

Table 14.2-14: SAR Values (LTE Band13 - Head)

Frequency		Mode	Side	Test Position	Figure No.	Conducted Power (dBm)	Max. tune-up Power (dBm)	Measured SAR(10g) (W/kg)	Reported SAR(10g) (W/kg)	Measured SAR(1g) (W/kg)	Reported SAR(1g) (W/kg)	Power Drift (dB)
Ch.	MHz											
23230	782	1RB_Mid	Right	Touch	Fig.14	24.25	25.5	0.244	0.33	0.309	0.41	0.17

Note1: The LTE mode is QPSK_10MHz.

Table 14.2-15: SAR Values (LTE Band13 - Body)

Ambient Temperature: 23.3 °C						Liquid Temperature: 22.8 °C					
Frequency		Mode	Test Position	Figure No.	Conducted Power (dBm)	Max. tune-up Power (dBm)	Measured SAR(10g) (W/kg)	Reported SAR(10g) (W/kg)	Measured SAR(1g) (W/kg)	Reported SAR(1g) (W/kg)	Power Drift (dB)
Ch.	MHz										
23230	782	1RB_Mid	Rear	Fig.15	24.25	25.5	0.401	0.53	0.509	0.68	-0.03

Note1: The distance between the EUT and the phantom bottom is 10mm.

Note2: The LTE mode is QPSK_10MHz.

Table 14.2-16: SAR Values (LTE Band25 - Head)

Ambient Temperature: 22.5 °C						Liquid Temperature: 21.9 °C						
Frequency		Mode	Side	Test Position	Figure No.	Conduct ed Power (dBm)	Max. tune-up Power (dBm)	Measured SAR(10g) (W/kg)	Reported SAR(10g) (W/kg)	Measured SAR(1g) (W/kg)	Reported SAR(1g) (W/kg)	Power Drift (dB)
Ch.	MHz											
26140	1860	1RB_Mid	Left	Touch	Fig.16	24.10	25	0.304	0.37	0.469	0.58	-0.05

Note1: The LTE mode is QPSK_20MHz.

Table 14.2-17: SAR Values (LTE Band25 - Body)

Ambient Temperature: 23 °C						Liquid Temperature: 22.5 °C					
Frequency		Mode	Test Position	Figure No.	Conducted Power (dBm)	Max. tune-up Power (dBm)	Measured SAR(10g) (W/kg)	Reported SAR(10g) (W/kg)	Measured SAR(1g) (W/kg)	Reported SAR(1g) (W/kg)	Power Drift (dB)
Ch.	MHz										
26140	1860	1RB_Mid	Bottom	Fig.17	22.36	23	0.484	0.56	0.874	1.01	-0.15

Note1: The distance between the EUT and the phantom bottom is 10mm.

Note2: The LTE mode is QPSK_20MHz.

Table 14.2-18: SAR Values (LTE Band25 - Body)

Ambient Temperature: 23 °C						Liquid Temperature: 22.5 °C					
Frequency		Mode	Test Position	Figure No.	Conducted Power (dBm)	Max. tune-up Power (dBm)	Measured SAR(10g) (W/kg)	Reported SAR(10g) (W/kg)	Measured SAR(1g) (W/kg)	Reported SAR(1g) (W/kg)	Power Drift (dB)
Ch.	MHz										
26140	1860	1RB_Mid	Front	Fig.18	23.14	24	0.201	0.25	0.34	0.41	-0.04

Note1: The distance between the EUT and the phantom bottom is 15mm.

Note2: The LTE mode is QPSK_20MHz.

Table 14.2-19: SAR Values (LTE Band26 - Head)

Frequency		Mode	Side	Test Position	Figure No.	Conducted Power (dBm)	Max. tune-up Power (dBm)	Measured SAR(10g) (W/kg)	Reported SAR(10g) (W/kg)	Measured SAR(1g) (W/kg)	Reported SAR(1g) (W/kg)	Power Drift (dB)
Ch.	MHz											
26865	831.5	1RB_Low	Left	Touch	Fig.19	24.28	25.5	0.234	0.31	0.297	0.39	0.05

Note1: The LTE mode is QPSK_15MHz.

Table 14.2-20: SAR Values (LTE Band26 - Body)

Frequency		Mode	Test Position	Figure No.	Conducted Power (dBm)	Max. tune-up Power (dBm)	Measured SAR(10g) (W/kg)	Reported SAR(10g) (W/kg)	Measured SAR(1g) (W/kg)	Reported SAR(1g) (W/kg)	Power Drift (dB)
Ch.	MHz										
26865	831.5	1RB_Low	Rear	Fig.20	24.28	25.5	0.358	0.47	0.457	0.61	0.04

Note1: The distance between the EUT and the phantom bottom is 10mm.

Note2: The LTE mode is QPSK_15MHz.

Table 14.2-21: SAR Values (LTE Band41 - Head)

Frequency		Mode	Side	Test Position	Figure No.	Conducted Power (dBm)	Max. tune-up Power (dBm)	Measured SAR(10g) (W/kg)	Reported SAR(10g) (W/kg)	Measured SAR(1g) (W/kg)	Reported SAR(1g) (W/kg)	Power Drift (dB)
Ch.	MHz											
40620	2593	1RB-Low	Right	Touch	Fig.21	23.55	24	0.052	0.06	0.096	0.11	-0.12

Note1: The LTE mode is QPSK_20MHz.

Table 14.2-22: SAR Values (LTE Band41 - Body)

Frequency		Mode	Test Position	Figure No.	Conducted Power (dBm)	Max. tune-up Power (dBm)	Measured SAR(10g) (W/kg)	Reported SAR(10g) (W/kg)	Measured SAR(1g) (W/kg)	Reported SAR(1g) (W/kg)	Power Drift (dB)
Ch.	MHz										
41055	2636.5	50RB-Low	Rear	Fig.22	22.33	23	0.463	0.54	1.04	1.21	0.04

Note1: The distance between the EUT and the phantom bottom is 10mm.

Note2: The LTE mode is QPSK_20MHz.

Table 14.2-23: SAR Values (LTE Band41 - Body)

Ambient Temperature: 23 °C						Liquid Temperature: 22.5°C					
Frequency		Mode	Test Position	Figure No.	Conducted Power (dBm)	Max. tune-up Power (dBm)	Measured SAR(10g) (W/kg)	Reported SAR(10g) (W/kg)	Measured SAR(1g) (W/kg)	Reported SAR(1g) (W/kg)	Power Drift (dB)
Ch.	MHz										
40620	2593	1RB-Low	Rear	Fig.23	23.55	24	0.22	0.24	0.452	0.50	0.08

Note1: The distance between the EUT and the phantom bottom is 15mm.

Note2: The LTE mode is QPSK_20MHz.

Table 14.2-24: SAR Values (LTE Band41 HPUE - Head)

Ambient Temperature: 22.5 °C						Liquid Temperature: 21.9°C						
Frequency		Mode	Side	Test Position	Figure No.	Conduct ed Power (dBm)	Max. tune-up Power (dBm)	Measured SAR(10g) (W/kg)	Reported SAR(10g) (W/kg)	Measured SAR(1g) (W/kg)	Reported SAR(1g) (W/kg)	Power Drift (dB)
Ch.	MHz											
40620	2593	1RB-Low	Right	Touch	Fig.24	26.41	27	0.075	0.09	0.135	0.15	0.08

Note1: The LTE mode is QPSK_20MHz.

Table 14.2-25: SAR Values (LTE Band41 HPUE - Body)

Ambient Temperature: 23 °C						Liquid Temperature: 22.5°C					
Frequency		Mode	Test Position	Figure No.	Conducted Power (dBm)	Max. tune-up Power (dBm)	Measured SAR(10g) (W/kg)	Reported SAR(10g) (W/kg)	Measured SAR(1g) (W/kg)	Reported SAR(1g) (W/kg)	Power Drift (dB)
Ch.	MHz										
41055	2636.5	50RB-Low	Rear	Fig.25	24.20	25	0.477	0.57	1.08	1.30	-0.09

Note1: The distance between the EUT and the phantom bottom is 10mm.

Note2: The LTE mode is QPSK_20MHz.

Table 14.2-26: SAR Values (LTE Band41 HPUE - Body)

Ambient Temperature: 23 °C						Liquid Temperature: 22.5°C					
Frequency		Mode	Test Position	Figure No.	Conducted Power (dBm)	Max. tune-up Power (dBm)	Measured SAR(10g) (W/kg)	Reported SAR(10g) (W/kg)	Measured SAR(1g) (W/kg)	Reported SAR(1g) (W/kg)	Power Drift (dB)
Ch.	MHz										
41055	2636.5	1RB-Low	Rear	Fig.26	26.13	27	0.432	0.53	0.894	1.09	0.02

Note1: The distance between the EUT and the phantom bottom is 15mm.

Note2: The LTE mode is QPSK_20MHz.

Table 14.2-27: SAR Values (LTE Band66 - Head)

Ambient Temperature: 22.5 °C						Liquid Temperature: 21.9°C						
Frequency		Mode	Side	Test Position	Figure No.	Conducted Power (dBm)	Max. tune-up Power (dBm)	Measured SAR(10g) (W/kg)	Reported SAR(10g) (W/kg)	Measured SAR(1g) (W/kg)	Reported SAR(1g) (W/kg)	Power Drift (dB)
Ch.	MHz											
132572	1770	1RB_Mid	Right	Touch	Fig.27	24.09	25	0.233	0.29	0.363	0.45	0.18

Note1: The LTE mode is QPSK_20MHz.

Table 14.2-28: SAR Values (LTE Band66 - Body)

Ambient Temperature: 23 °C						Liquid Temperature: 22.5°C					
Frequency		Mode	Test Position	Figure No.	Conducted Power (dBm)	Max. tune-up Power (dBm)	Measured SAR(10g) (W/kg)	Reported SAR(10g) (W/kg)	Measured SAR(1g) (W/kg)	Reported SAR(1g) (W/kg)	Power Drift (dB)
Ch.	MHz										
132072	1720	1RB_Mid	Bottom	Fig.28	19.08	20	0.441	0.55	0.815	1.01	-0.14

Note1: The distance between the EUT and the phantom bottom is 10mm.

Note2: The LTE mode is QPSK_20MHz.

Table 14.2-29: SAR Values (LTE Band66 - Body)

Ambient Temperature: 23 °C						Liquid Temperature: 22.5°C					
Frequency		Mode	Test Position	Figure No.	Conducted Power (dBm)	Max. tune-up Power (dBm)	Measured SAR(10g) (W/kg)	Reported SAR(10g) (W/kg)	Measured SAR(1g) (W/kg)	Reported SAR(1g) (W/kg)	Power Drift (dB)
Ch.	MHz										
26140	1860	50RB_Low	Rear	Fig.29	22.12	23	0.229	0.28	0.397	0.49	0.03

Note1: The distance between the EUT and the phantom bottom is 15mm.

Note2: The LTE mode is QPSK_20MHz.

Table 14.2-30: SAR Values (LTE Band71 - Head)

Ambient Temperature: 23.3 °C						Liquid Temperature: 22.8°C						
Frequency		Mode	Side	Test Position	Figure No.	Conducted Power (dBm)	Max. tune-up Power (dBm)	Measured SAR(10g) (W/kg)	Reported SAR(10g) (W/kg)	Measured SAR(1g) (W/kg)	Reported SAR(1g) (W/kg)	Power Drift (dB)
Ch.	MHz											
133322	683	1RB_Mid	Right	Touch	Fig.30	24.57	25.5	0.248	0.31	0.31	0.38	0.06

Note1: The LTE mode is QPSK_20MHz.

Table 14.2-31: SAR Values (LTE Band71 - Body)

Frequency		Mode	Test Position	Figure No.	Conducted Power (dBm)	Max. tune-up Power (dBm)	Measured SAR(10g) (W/kg)	Reported SAR(10g) (W/kg)	Measured SAR(1g) (W/kg)	Reported SAR(1g) (W/kg)	Power Drift (dB)
Ch.	MHz										
133322	683	1RB_Mid	Rear	Fig.31	24.57	25.5	0.298	0.37	0.38	0.47	-0.02

Note1: The distance between the EUT and the phantom bottom is 10mm.

Note2: The LTE mode is QPSK_20MHz.

14.3 WLAN Evaluation for 2.4G

According to the KDB248227 D01, SAR is measured for 2.4GHz 802.11b DSSS using the initial test position procedure.

Head Evaluation

Table 14.3-1: SAR Values (WLAN - Head)– 802.11b (Fast SAR) –receiver on

Ambient Temperature: 22.9 °C						Liquid Temperature: 22.5 °C					
Frequency		Side	Test Position	Figure No.	Conducted Power (dBm)	Max. tune-up Power (dBm)	Measured SAR(10g) (W/kg)	Reported SAR(10g) (W/kg)	Measured SAR(1g) (W/kg)	Reported SAR(1g)(W/kg)	Power Drift (dB)
MHz	Ch.										
2437	6	Left	Touch	/	17.58	17.7	0.327	0.34	0.635	0.65	-0.11
2437	6	Left	Tilt	/	17.58	17.7	0.262	0.27	0.532	0.55	-0.03
2437	6	Right	Touch	/	17.58	17.7	0.189	0.19	0.33	0.34	0.06
2437	6	Right	Tilt	/	17.58	17.7	0.136	0.14	0.245	0.25	-0.09

As shown above table, the initial test position for head is “Left Touch”. So the head SAR of WLAN is presented as below:

Table 14.3-2: SAR Values (WLAN - Head)– 802.11b (Full SAR)

Ambient Temperature: 22.9 °C						Liquid Temperature: 22.5 °C					
Frequency		Side	Test Position	Figure No.	Conducted Power (dBm)	Max. tune-up Power (dBm)	Measured SAR(10g) (W/kg)	Reported SAR(10g) (W/kg)	Measured SAR(1g) (W/kg)	Reported SAR(1g)(W/kg)	Power Drift (dB)
MHz	Ch.										
2437	6	Left	Touch	Fig.32	17.58	17.7	0.337	0.35	0.67	0.69	-0.11
2437	6	Left	Tilt	/	17.58	17.7	0.252	0.26	0.51	0.52	-0.03

Note1: When the reported SAR of the initial test position is > 0.4 W/kg, SAR is repeated for the 802.11 transmission mode configuration tested in the initial test position using subsequent highest estimated 1-g SAR conditions determined by area scans, on the highest maximum output power channel, until the reported SAR is \leq 0.8 W/kg.

Note2: For all positions/configurations tested using the initial test position and subsequent test positions, when the reported SAR is > 0.8 W/kg, SAR is measured for these test positions/configurations on the subsequent next highest measured output power channel until the reported SAR is \leq 1.2 W/kg or all required channels are tested.

According to the KDB248227 D01, The reported SAR must be scaled to 100% transmission duty factor to determine compliance at the maximum tune-up tolerance limit. The scaled reported SAR is presented as below.

Table 14.3-3: SAR Values (WLAN - Head) – 802.11b (Scaled Reported SAR)

Ambient Temperature: 22.9 °C						Liquid Temperature: 22.5 °C	
Frequency		Side	Test Position	Actual duty factor	maximum duty factor	Reported SAR (1g)(W/kg)	Scaled reported SAR (1g)(W/kg)
MHz	Ch.						
2437	6	Left	Tilt	100%	100%	0.69	0.69

SAR is not required for OFDM because the 802.11b adjusted SAR \leq 1.2 W/kg.

Body Evaluation
Table 14.3-4: SAR Values (WLAN - Body)– 802.11b (Fast SAR) –Receiver off+Hotspot off

Frequency		Test Position	Figure No.	Ambient Temperature: 22.9 °C		Liquid Temperature: 22.5 °C				Power Drift (dB)
MHz	Ch.			Conducted Power (dBm)	Max. tune-up Power (dBm)	Measured SAR(10g) (W/kg)	Reported SAR(10g) (W/kg)	Measured SAR(1g) (W/kg)	Reported SAR(1g) (W/kg)	
2437	6	Front	/	19.38	19.5	0.143	0.15	0.266	0.27	-0.18
2437	6	Rear	/	19.38	19.5	0.243	0.25	0.485	0.50	-0.15
2437	6	Right	/	19.38	19.5	0.157	0.16	0.312	0.32	-0.05
2437	6	Top	/	19.38	19.5	0.126	0.13	0.255	0.26	0.14

As shown above table, the initial test position for body is “Rear”. So the body SAR of WLAN is presented as below:

Table 14.3-5: SAR Values (WLAN - Body)– 802.11b (Full SAR)

Frequency		Test Position	Figure No.	Ambient Temperature: 22.9 °C		Liquid Temperature: 22.5 °C				Power Drift (dB)
MHz	Ch.			Conducted Power (dBm)	Max. tune-up Power (dBm)	Measured SAR(10g) (W/kg)	Reported SAR(10g) (W/kg)	Measured SAR(1g) (W/kg)	Reported SAR(1g) (W/kg)	
2437	6	Rear	Fig.33	19.38	19.5	0.243	0.25	0.485	0.50	-0.15
2437	6	Right		19.38	19.5	0.138	0.14	0.27	0.28	-0.05

Note1: When the reported SAR of the initial test position is > 0.4 W/kg, SAR is repeated for the 802.11 transmission mode configuration tested in the initial test position using subsequent highest estimated 1-g SAR conditions determined by area scans, on the highest maximum output power channel, until the reported SAR is \leq 0.8 W/kg.

Note2: For all positions/configurations tested using the initial test position and subsequent test positions, when the reported SAR is > 0.8 W/kg, SAR is measured for these test positions/configurations on the subsequent next highest measured output power channel until the reported SAR is \leq 1.2 W/kg or all required channels are tested.

Note3: The distance between the EUT and the phantom bottom is 10mm.

According to the KDB248227 D01, The reported SAR must be scaled to 100% transmission duty factor to determine compliance at the maximum tune-up tolerance limit. The scaled reported SAR is presented as below.

Table 14.3-6: SAR Values (WLAN - Body) – 802.11b (Scaled Reported SAR)

Frequency		Test Position	Ambient Temperature: 22.9 °C		Liquid Temperature: 22.5 °C	
MHz	Ch.		Actual duty factor	maximum duty factor	Reported SAR (1g)(W/kg)	Scaled reported SAR (1g)(W/kg)
2437	6	Rear	100%	100%	0.5	0.5

SAR is not required for OFDM because the 802.11b adjusted SAR \leq 1.2 W/kg.

Table 14.3-7: SAR Values (WLAN - Body)– 802.11b (Fast SAR) - Receiver off+Hotspot on

Frequency		Test Position	Figure No.	Conducted Power (dBm)	Max. tune-up Power (dBm)	Ambient Temperature: 22.9°C		Liquid Temperature: 22.5°C		Power Drift (dB)
MHz	Ch.					Measured SAR(10g) (W/kg)	Reported SAR(10g) (W/kg)	Measured SAR(1g) (W/kg)	Reported SAR(1g) (W/kg)	
2437	6	Front	/	20.43	20.5	0.149	0.15	0.268	0.27	0.11
2437	6	Rear	/	20.43	20.5	0.305	0.31	0.598	0.61	0.02
2437	6	Right	/	20.43	20.5	0.159	0.16	0.31	0.32	-0.1
2437	6	Top	/	20.43	20.5	0.166	0.17	0.333	0.34	0.08

As shown above table, the initial test position for body is “Top”. So the body SAR of WLAN is presented as below:

Table 14.3-8: SAR Values (WLAN - Body)– 802.11b (Full SAR)

Frequency		Test Position	Figure No.	Conducted Power (dBm)	Max. tune-up Power (dBm)	Ambient Temperature: 22.9°C		Liquid Temperature: 22.5°C		Power Drift (dB)
MHz	Ch.					Measured SAR(10g) (W/kg)	Reported SAR(10g) (W/kg)	Measured SAR(1g) (W/kg)	Reported SAR(1g) (W/kg)	
2437	6	Rear	Fig.34	20.43	20.5	0.286	0.29	0.575	0.58	0.02
2437	6	Right	/	20.43	20.5	0.19	0.19	0.296	0.30	-0.1

Note1: When the reported SAR of the initial test position is > 0.4 W/kg, SAR is repeated for the 802.11 transmission mode configuration tested in the initial test position using subsequent highest estimated 1-g SAR conditions determined by area scans, on the highest maximum output power channel, until the reported SAR is \leq 0.8 W/kg.

Note2: For all positions/configurations tested using the initial test position and subsequent test positions, when the reported SAR is > 0.8 W/kg, SAR is measured for these test positions/configurations on the subsequent next highest measured output power channel until the reported SAR is \leq 1.2 W/kg or all required channels are tested.

Note3: The distance between the EUT and the phantom bottom is 10mm.

According to the KDB248227 D01, The reported SAR must be scaled to 100% transmission duty factor to determine compliance at the maximum tune-up tolerance limit. The scaled reported SAR is presented as below.

Table 14.3-9: SAR Values (WLAN - Body) – 802.11b (Scaled Reported SAR)

Frequency		Test Position	Ambient Temperature: 22.9°C		Liquid Temperature: 22.5°C	
MHz	Ch.		Actual duty factor	maximum duty factor	Reported SAR (1g)(W/kg)	Scaled reported SAR (1g)(W/kg)
2437	6	Rear	100%	100%	0.58	0.58

SAR is not required for OFDM because the 802.11b adjusted SAR \leq 1.2 W/kg.

Table 14.3-10: SAR Values (WLAN - Body)– 802.11b (Fast SAR) – Cellular+WIFI2.4G

Frequency		Test Position	Figure No.	Ambient Temperature: 22.9°C		Liquid Temperature: 22.5°C				Power Drift (dB)
MHz	Ch.			Conducted Power (dBm)	Max. tune-up Power (dBm)	Measured SAR(10g) (W/kg)	Reported SAR(10g) (W/kg)	Measured SAR(1g) (W/kg)	Reported SAR(1g) (W/kg)	
2437	6	Front	/	17.58	17.7	0.086	0.09	0.16	0.16	0.12
2437	6	Rear	/	17.58	17.7	0.179	0.18	0.351	0.36	-0.17
2437	6	Right	/	17.58	17.7	0.095	0.10	0.186	0.19	-0.03
2437	6	Top	/	17.58	17.7	0.086	0.09	0.17	0.17	0.13

As shown above table, the initial test position for body is “Top”. So the body SAR of WLAN is presented as below:

Table 14.3-11: SAR Values (WLAN - Body)– 802.11b (Full SAR)

Frequency		Test Position	Figure No.	Ambient Temperature: 22.9°C		Liquid Temperature: 22.5°C				Power Drift (dB)
MHz	Ch.			Conducted Power (dBm)	Max. tune-up Power (dBm)	Measured SAR(10g) (W/kg)	Reported SAR(10g) (W/kg)	Measured SAR(1g) (W/kg)	Reported SAR(1g) (W/kg)	
2437	6	Rear	Fig.35	17.58	17.7	0.164	0.17	0.329	0.34	-0.17

Note1: When the reported SAR of the initial test position is > 0.4 W/kg, SAR is repeated for the 802.11 transmission mode configuration tested in the initial test position using subsequent highest estimated 1-g SAR conditions determined by area scans, on the highest maximum output power channel, until the reported SAR is \leq 0.8 W/kg.

Note2: For all positions/configurations tested using the initial test position and subsequent test positions, when the reported SAR is > 0.8 W/kg, SAR is measured for these test positions/configurations on the subsequent next highest measured output power channel until the reported SAR is \leq 1.2 W/kg or all required channels are tested.

Note3: The distance between the EUT and the phantom bottom is 10mm.

According to the KDB248227 D01, The reported SAR must be scaled to 100% transmission duty factor to determine compliance at the maximum tune-up tolerance limit. The scaled reported SAR is presented as below.

Table 14.3-12: SAR Values (WLAN - Body) – 802.11b (Scaled Reported SAR)

Frequency		Test Position	Ambient Temperature: 22.9°C		Liquid Temperature: 22.5°C	
MHz	Ch.		Actual duty factor	maximum duty factor	Reported SAR (1g)(W/kg)	Scaled reported SAR (1g)(W/kg)
2437	6	Rear	100%	100%	0.34	0.34

SAR is not required for OFDM because the 802.11b adjusted SAR \leq 1.2 W/kg.

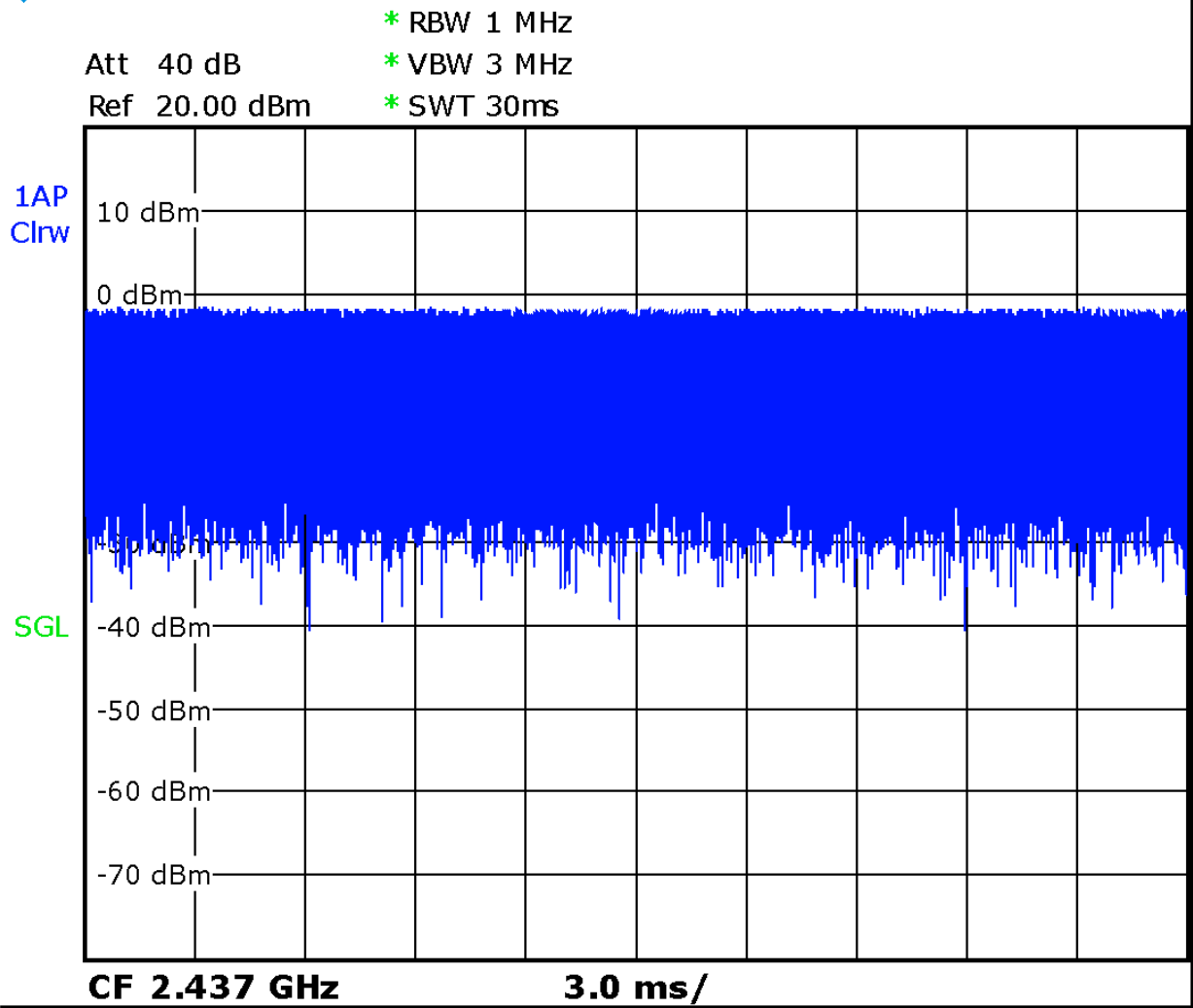

Picture 14.1 Duty factor plot

14.4 SAR Evaluation for Phablet

According to the KDB648474 D04, for smart phones, with a display diagonal dimension > 15.0 cm or an overall diagonal dimension > 16.0 cm, that can provide similar mobile web access and multimedia support found in mini-tablets or UMPC mini-tablets and support voice calls next to the ear, unless it is confirmed otherwise through KDB inquiries, the following phablet procedures should be applied to evaluate SAR compliance for each applicable wireless modes and frequency band. Devices marketed as phablets, regardless of form factors and operating characteristics must be tested as a phablet to determine SAR compliance.

1. The normally required head and body-worn accessory SAR test procedures for handsets, including hotspot mode, must be applied.
2. The UMPC mini-tablet procedures must also be applied to test the SAR of all surfaces and edges with an antenna located at ≤ 25 mm from that surface or edge, in direct contact with a flat phantom, for 10-g extremity SAR according to the body-equivalent tissue dielectric parameters in KDB Publication 865664 D01 to address interactive hand use exposure conditions. When hotspot mode applies, 10-g extremity SAR is required only for the surfaces and edges with hotspot mode 1-g reported SAR > 1.2 W/kg; however, when power reduction applies to hotspot mode the measured SAR must be scaled to the maximum output power, including tolerance, allowed for phablet modes to compare with the 1.2 W/kg SAR test reduction threshold. The normal tablet procedures in KDB Publication 616217 are required when the overall diagonal dimension of the device is > 20.0 cm. Hotspot mode SAR is not required when normal tablet procedures are applied. Extremity 10-g SAR is also not required for the front (top) surface of larger form factor full size tablets. The more conservative normal tablet SAR results can be used to support phablet mode 10-g extremity SAR.
3. The simultaneous transmission operating configurations applicable to voice and data transmissions for both phone and mini-tablet modes must be taken into consideration separately for 1-g and 10-g SAR to determine the simultaneous transmission SAR test exclusion and measurement requirements for the relevant wireless modes and exposure conditions

For the device of this project, the display diagonal dimension is 151 cm (> 15.0 cm) and the overall diagonal dimension is 172 cm (> 16.0 cm), so this device is a phone as “phablet”.

Table 14.4-1: 10g extremity SAR determination

Frequency			Mode	Position	Conducted Power (dBm)	Hotspot off tune-up Power (dBm)	Measured SAR(1g) (W/kg)	Adjusted SAR(1g) (W/kg)	Test reduction threshold (W/kg)
Band	Ch.	MHz							
GSM1900	512	1850.2	GPRS(2)	Bottom	27.20	29	0.867	1.31	1.2
WCDMA1900	9538	1907.6	RMC	Rear	22.91	24	1.03	1.32	
WCDMA1900	9400	1880	RMC	Rear	22.95	24	1.01	1.29	
WCDMA1900	9262	1852.4	RMC	Rear	22.93	24	1.11	1.42	
WCDMA1700	9538	1907.6	RMC	Rear	19.88	23	0.656	1.35	
WCDMA1700	9400	1880	RMC	Rear	19.90	23	0.814	1.66	
WCDMA1700	9262	1852.4	RMC	Rear	19.88	23	1.01	2.07	
WCDMA1700	9538	1907.6	RMC	Bottom	19.88	23	0.842	1.73	
WCDMA1700	9400	1880	RMC	Bottom	19.90	23	0.915	1.87	
WCDMA1700	9262	1852.4	RMC	Bottom	19.88	23	1.16	2.38	
LTE Band25	26140	1860	1RB-Mid	Bottom	22.36	24	0.874	1.28	
LTE Band25	26140	1860	50RB-Mid	Bottom	22.32	24	0.848	1.25	
LTE Band41	41490	2680	1RB-Low	Rear	22.53	24	0.942	1.32	
LTE Band41	41055	2636.5	1RB-Low	Rear	22.31	24	1.01	1.49	
LTE Band41	41055	2636.5	50RB-Low	Rear	22.33	23	1.04	1.21	
LTE Band41 (HPUE)	41490	2680	1RB-Low	Rear	24.39	27	1.03	1.88	
LTE Band41 (HPUE)	41055	2636.5	1RB-Low	Rear	24.18	27	1.04	1.99	
LTE Band41 (HPUE)	40620	2593	1RB-Low	Rear	24.41	27	0.832	1.51	
LTE Band41 (HPUE)	41490	2680	50RB-Low	Rear	24.34	26	1.02	1.49	
LTE Band41 (HPUE)	41055	2636.5	50RB-Low	Rear	24.20	26	1.08	1.63	
LTE Band41 (HPUE)	40620	2593	50RB-Low	Rear	24.37	26	0.863	1.26	
LTE Band41 (HPUE)	40620	2593	100RB	Rear	24.32	26	0.865	1.27	
LTE Band66	132572	1770	1RB-Mid	Bottom	19.06	23	0.55	1.36	
LTE Band66	132322	1745	1RB-Mid	Bottom	19.00	23	0.656	1.65	
LTE Band66	132072	1720	1RB-Mid	Bottom	19.08	23	0.815	2.01	
LTE Band66	132572	1770	50RB-Low	Bottom	19.11	23	0.564	1.38	
LTE Band66	132572	1770	100RB	Bottom	19.06	23	0.544	1.35	

According to the above table, the 10g extremity SAR is required for the GSM1900, WCDMA1900/1700,LTE Band25/41/41(HPUE)/66.

Table 14.4-2: SAR Values for 10g extremity SAR

Frequency			Mode/ Figure No.	Conducted Power (dBm)	Max. tune-up Power (dBm)	Measured SAR(10g) (W/kg)	Reported SAR(10g) (W/kg)	Power Drift (dB)	Limited (W/kg)
Band	Ch.	MHz							
Ambient Temperature: 22.9°C Liquid Temperature: 22.5°C									
GSM1900	810	1909.8	GPRS(2) Bottom	27.48	29	1.8	2.56	-0.18	4.0
GSM1900	661	1880	GPRS(2) Bottom	27.36	29	2.11	3.08	-0.16	
GSM1900	512	1850.2	GPRS(2) Bottom	27.20	29	2.6	3.94	-0.11	
WCDMA1900	9538	1907.6	RMC Bottom	22.91	24	2.24	2.88	-0.08	
WCDMA1900	9400	1880	RMC Bottom	22.95	24	2.48	3.16	-0.02	
WCDMA1900	9262	1852.4	RMC Bottom	22.93	24	2.68	3.43	-0.08	
WCDMA1700	1513	1752.6	RMC Rear	22.90	23	2.09	2.14	-0.17	
WCDMA1700	1412	1732.4	RMC Rear	22.91	23	2.11	2.15	0.03	
WCDMA1700	1312	1712.4	RMC Rear	22.89	23	2.07	2.12	0.13	
WCDMA1700	1513	1752.6	RMC Bottom	22.90	23	2.97	3.04	-0.13	
WCDMA1700	1412	1732.4	RMC Bottom	22.91	23	3.24	3.31	-0.04	
WCDMA1700	1312	1712.4	RMC Bottom	22.89	23	3.42	3.51	-0.01	
LTE Band25	26590	1905	1RB-Mid Bottom	23.12	24	2.25	2.76	0.18	
LTE Band25	26365	1882.5	1RB-Mid Bottom	23.11	24	2.35	2.88	0.18	
LTE Band25	26140	1860	1RB-Mid Bottom	23.14	24	2.54	3.10	0.01	
LTE Band25	26590	1905	50RB-Mid Bottom	23.12	24	2.19	2.68	0.13	
LTE Band25	26365	1882.5	50RB-Mid Bottom	23.11	24	2.35	2.88	-0.02	
LTE Band25	26140	1860	50RB-Mid Bottom	23.14	24	2.48	3.02	-0.18	
LTE Band25	26590	1905	100RB Bottom	23.07	24	2.23	2.76	0.08	
LTE Band25	26365	1882.5	100RB Bottom	23.03	24	2.44	3.05	0.15	
LTE Band25	26140	1860	100RB Bottom	23.12	24	2.46	3.01	-0.08	
LTE Band41	41490	2680	1RB-Low Rear	23.55	24	2.28	2.53	-0.15	
LTE Band41	41055	2636.5	1RB-Low Rear	23.55	24	2.4	2.66	0.04	
LTE Band41	40620	2593	1RB-Low Rear	23.55	24	2.38	2.64	0.15	
LTE Band41	40185	2549.5	1RB-Low Rear	23.55	24	2.33	2.58	0.17	
LTE Band41	39750	2506	1RB-Low Rear	23.55	24	2.08	2.31	0.06	
LTE Band41	41490	2680	50RB-Low Rear	22.50	23	1.75	1.96	0.11	
LTE Band41	41055	2636.5	50RB-Low Rear	22.50	23	1.92	2.15	-0.01	
LTE Band41	40620	2593	50RB-Low Rear	22.50	23	1.9	2.13	0.04	
LTE Band41	40185	2549.5	50RB-Low Rear	22.50	23	1.89	2.12	0.18	
LTE Band41	39750	2506	50RB-Low Rear	22.50	23	1.67	1.87	0.11	
LTE Band41	41490	2680	100RB Rear	22.43	23	1.96	2.23	0.12	
LTE Band41	41055	2636.5	100RB Rear	22.25	23	1.91	2.27	0.01	
LTE Band41	40620	2593	100RB Rear	22.42	23	1.76	2.01	0.02	



LTE Band41	40185	2549.5	100RB Rear	22.33	23	1.52	1.77	-0.08
LTE Band41	39750	2506	100RB Rear	22.32	23	1.44	1.68	0.03
LTE Band41 (HPUE)	41490	2680	1RB-Low Rear	26.31	27	2.7	3.16	-0.11
LTE Band41 (HPUE)	41055	2636.5	1RB-Low Rear	26.13	27	2.89	3.53	0.01
LTE Band41 (HPUE)	40620	2593	1RB-Low Rear	26.41	27	2.82	3.23	0.15
LTE Band41 (HPUE)	40185	2549.5	1RB-Low Rear	26.33	27	2.63	3.07	-0.16
LTE Band41 (HPUE)	39750	2506	1RB-Low Rear	26.28	27	2.46	2.90	-0.15
LTE Band41 (HPUE)	41490	2680	50RB-Low Rear	25.40	26	2.19	2.51	-0.03
LTE Band41 (HPUE)	41055	2636.5	50RB-Low Rear	25.18	26	2.24	2.71	-0.01
LTE Band41 (HPUE)	40620	2593	50RB-Low Rear	25.55	26	2.32	2.57	-0.15
LTE Band41 (HPUE)	40185	2549.5	50RB-Low Rear	25.32	26	2.14	2.50	-0.07
LTE Band41 (HPUE)	39750	2506	50RB-Low Rear	25.51	26	1.93	2.16	0
LTE Band41 (HPUE)	41490	2680	100RB Rear	25.40	26	2.37	2.72	-0.03
LTE Band41 (HPUE)	41055	2636.5	100RB Rear	25.18	26	2.3	2.78	0.05
LTE Band41 (HPUE)	40185	2549.5	100RB Rear	25.32	26	1.91	2.23	0.01
LTE Band41 (HPUE)	39750	2506	100RB Rear	25.51	26	1.82	2.04	0.07
LTE Band41 (HPUE)	40620	2593	100RB Rear	25.55	26	2.44	2.71	0.09
LTE Band66	132572	1770	1RB-Mid Bottom	22.03	23	2.44	3.05	0.13
LTE Band66	132322	1745	1RB-Mid Bottom	21.99	23	2.64	3.33	-0.11
LTE Band66	132072	1720	1RB-Mid Bottom	21.97	23	2.88	3.65	-0.05
LTE Band66	132572	1770	50RB-Low Bottom	22.12	23	2.52	3.09	-0.17
LTE Band66	132322	1745	50RB-Low Bottom	22.09	23	2.65	3.27	0.12
LTE Band66	132072	1720	50RB-Low Bottom	22.06	23	2.76	3.43	0.01
LTE Band66	132572	1770	100RB Bottom	22.08	23	2.5	3.09	-0.06
LTE Band66	132322	1745	100RB Bottom	21.98	23	2.72	3.44	-0.07
LTE Band66	132072	1720	100RB Bottom	22.00	23	2.81	3.54	-0.09
WIFI2.4G	6	2437	Rear	17.58	17.7	1.82	1.87	-0.17
WIFI2.4G	6	2437	Bottom	17.58	17.7	0.048	0.05	0.12

Note1: The distance between the EUT and the phantom bottom is 0mm.

Table 14.4-3: The sum of SAR values for 10g extremity SAR

	Position	Main antenna	WiFi-2.4G	Sum	Limited
10-g extremity SAR (Separation Distance 0mm)	Bottom (GSM1900)	3.94	0.05	3.99	4.0
	Rear (LTE Band41 HPUE)	3.53	1.87	5.4	

Table 14.4-4: The sum of reported SAR values for main antenna and WiFi (Extremity SAR)

	Position	band	Main antenna	WiFi	Sum (10g)	Distance (mm)	Ratio
Highest reported SAR value for Phablet	Rear 0mm	WCDMA1700	2.15	1.87	4.02	141.06	0.057
		LTE Band41	2.66	1.87	4.53	140.36	0.069
		LTE Band41 HPUE	3.53	1.87	5.4	146.19	0.086

According to the KDB 447498 D01, when the sum of SAR is larger than the limit, SAR test exclusion is determined by the SAR to peak location separation ratio. The ratio is determined by $(SAR_1 + SAR_2)^{1.5}/R_i$, rounded to two decimal digits, and must be ≤ 0.1 for all antenna pairs in the configuration to qualify for 10-g SAR test exclusion.

Maxima and position w.r.t. Grid Reference Point	associated 1g averages
Zoom Scan (D:\2021\I21Z60727(FCC)\WIFI2.4G Body 18dB 0mm 58a LJY.da53:0/11b 5.5M 18db Rear 0mm)	
Max. 1 at (24.00, -67.40, -0.92) mm	4.25 W/kg
Zoom Scan (D:\2021\I21Z60727(FCC)\WCDMA1700 Body 0mm 56a SYF jiang1.da53:0/Rear Mid 0mm reduce ...)	
Max. 2 at (-15.90, 67.90, -1.35) mm	4.73 W/kg
Distances and Separation Ratios	
Max. 1 - Max. 2	Distance [mm]: 141.06 / Separation ratio [W/kg/mm]: 0.19

Picture 14.4-1 Distance evaluation for WCDMA1700 and WiFi 2.4G Body Rear 0mm

Maxima and position w.r.t. Grid Reference Point	associated 1g averages
Zoom Scan (D:\2021\I21Z60727(FCC)\WIFI2.4G Body 18dB 0mm 58a LJY.da53:0/11b 5.5M 18db Rear 0mm)	
Max. 1 at (24.00, -67.40, -0.92) mm	4.25 W/kg
Zoom Scan (D:\2021\I21Z60727(FCC)\LTE Band41 Body 0mm PC3 58a SYF.da53:0/Rear 1RB-Low 0mm)	
Max. 2 at (-14.40, 67.60, -1.23) mm	7.12 W/kg
Distances and Separation Ratios	
Max. 1 - Max. 2	Distance [mm]: 140.36 / Separation ratio [W/kg/mm]: 0.27

Picture 14.4-2 Distance evaluation for LTE Band41 and WiFi 2.4G Body Rear 0mm

Maxima and position w.r.t. Grid Reference Point	associated 1g averages
Zoom Scan (D:\2021\I21Z60727(FCC)\WIFI2.4G Body 18dB 0mm 58a LJY.da53:0/11b 5.5M 18db Rear 0mm)	
Max. 1 at (24.00, -67.40, -0.92) mm	4.25 W/kg
Zoom Scan (D:\2021\I21Z60727(FCC)\LTE Band41 Body 0mm PC2 58a SYF.da53:0/Rear 1RB-Low 0mm 2)	
Max. 2 at (-24.80, 70.40, -1.32) mm	8.42 W/kg
Distances and Separation Ratios	
Max. 1 - Max. 2	Distance [mm]: 146.19 / Separation ratio [W/kg/mm]: 0.31

Picture 14.4-3 Distance evaluation for LTE Band41 HPUE and WiFi 2.4G Body Rear 0mm

15 SAR Measurement Variability

SAR measurement variability must be assessed for each frequency band, which is determined by the SAR probe calibration point and tissue-equivalent medium used for the device measurements. When both head and body tissue-equivalent media are required for SAR measurements in a frequency band, the variability measurement procedures should be applied to the tissue medium with the highest measured SAR, using the highest measured SAR configuration for that tissue-equivalent medium.

The following procedures are applied to determine if repeated measurements are required.

- 1) Repeated measurement is not required when the original highest measured SAR is < 0.80 W/kg; steps 2) through 4) do not apply.
- 2) When the original highest measured SAR is ≥ 0.80 W/kg, repeat that measurement once.
- 3) Perform a second repeated measurement only if the ratio of largest to smallest SAR for the original and first repeated measurements is > 1.20 or when the original or repeated measurement is ≥ 1.45 W/kg ($\sim 10\%$ from the 1-g SAR limit).
- 4) Perform a third repeated measurement only if the original, first or second repeated measurement is ≥ 1.5 W/kg and the ratio of largest to smallest SAR for the original, first and second repeated measurements is > 1.20 .

Table 15.1: SAR Measurement Variability for Body GSM1900 (1g)

Frequency		Test Position	Spacing (mm)	Original SAR (W/kg)	First Repeated SAR (W/kg)	The Ratio	Second Repeated SAR (W/kg)
Ch.	MHz						
512	1850.2	Bottom	10	0.867	0.858	1.01	/

Table 15.2: SAR Measurement Variability for Body WCDMA1900 (1g)

Frequency		Test Position	Spacing (mm)	Original SAR (W/kg)	First Repeated SAR (W/kg)	The Ratio	Second Repeated SAR (W/kg)
Ch.	MHz						
9262	1852.4	Bottom	10	1.11	1.05	1.06	/

Table 15.3: SAR Measurement Variability for Body WCDMA1700 (1g)

Frequency		Test Position	Spacing (mm)	Original SAR (W/kg)	First Repeated SAR (W/kg)	The Ratio	Second Repeated SAR (W/kg)
Ch.	MHz						
1312	1712.4	Bottom	10	1.16	1.12	1.04	/

Table 15.4: SAR Measurement Variability for Body LTE B25 (1g)

Frequency		Mode	Test Position	Spacing (mm)	Original SAR (W/kg)	First Repeated SAR (W/kg)	The Ratio	Second Repeated SAR (W/kg)
Ch.	MHz							
26140	1860	1RB_Mid	Bottom	10	0.874	0.865	1.04	/

Table 15.5: SAR Measurement Variability for Body LTE B41 (1g)

Frequency		Mode	Test Position	Spacing (mm)	Original SAR (W/kg)	First Repeated SAR (W/kg)	The Ratio	Second Repeated SAR (W/kg)
Ch.	MHz							
41055	2636.5	50RB_Low	Rear	10	1.04	1.01	1.03	/

Table 15.6: SAR Measurement Variability for Body LTE B41 HPUE (1g)

Frequency		Mode	Test Position	Spacing (mm)	Original SAR (W/kg)	First Repeated SAR (W/kg)	The Ratio	Second Repeated SAR (W/kg)
Ch.	MHz							
41055	2636.5	50RB_Low	Rear	10	1.08	1.02	1.06	/

Table 15.4: SAR Measurement Variability for Body LTE B66 (1g)

Frequency		Mode	Test Position	Spacing (mm)	Original SAR (W/kg)	First Repeated SAR (W/kg)	The Ratio	Second Repeated SAR (W/kg)
Ch.	MHz							
132072	1720	1RB_Mid	Bottom	10	0.815	0.802	1.02	/

16 Measurement Uncertainty

16.1 Measurement Uncertainty for Normal SAR Tests (300MHz~3GHz)

No.	Error Description	Type	Uncertainty value	Probably Distribution	Div.	(Ci) 1g	(Ci) 10g	Std. Unc. (1g)	Std. Unc. (10g)	Degree of freedom
Measurement system										
1	Probe calibration	B	6.0	N	1	1	1	6.0	6.0	∞
2	Isotropy	B	4.7	R	$\sqrt{3}$	0.7	0.7	1.9	1.9	∞
3	Boundary effect	B	1.0	R	$\sqrt{3}$	1	1	0.6	0.6	∞
4	Linearity	B	4.7	R	$\sqrt{3}$	1	1	2.7	2.7	∞
5	Detection limit	B	1.0	N	1	1	1	0.6	0.6	∞
6	Readout electronics	B	0.3	R	$\sqrt{3}$	1	1	0.3	0.3	∞
7	Response time	B	0.8	R	$\sqrt{3}$	1	1	0.5	0.5	∞
8	Integration time	B	2.6	R	$\sqrt{3}$	1	1	1.5	1.5	∞
9	RF ambient conditions-noise	B	0	R	$\sqrt{3}$	1	1	0	0	∞
10	RFambient conditions-reflection	B	0	R	$\sqrt{3}$	1	1	0	0	∞
11	Probe positioned mech. restrictions	B	0.4	R	$\sqrt{3}$	1	1	0.2	0.2	∞
12	Probe positioning with respect to phantom shell	B	2.9	R	$\sqrt{3}$	1	1	1.7	1.7	∞
13	Post-processing	B	1.0	R	$\sqrt{3}$	1	1	0.6	0.6	∞
Test sample related										
14	Test sample positioning	A	3.3	N	1	1	1	3.3	3.3	71
15	Device holder uncertainty	A	3.4	N	1	1	1	3.4	3.4	5
16	Drift of output power	B	5.0	R	$\sqrt{3}$	1	1	2.9	2.9	∞
Phantom and set-up										
17	Phantom uncertainty	B	4.0	R	$\sqrt{3}$	1	1	2.3	2.3	∞
18	Liquid conductivity (target)	B	5.0	R	$\sqrt{3}$	0.64	0.43	1.8	1.2	∞
19	Liquid conductivity (meas.)	A	2.06	N	1	0.64	0.43	1.32	0.89	43
20	Liquid permittivity (target)	B	5.0	R	$\sqrt{3}$	0.6	0.49	1.7	1.4	∞
21	Liquid permittivity (meas.)	A	1.6	N	1	0.6	0.49	1.0	0.8	521

Combined standard uncertainty	$u_c = \sqrt{\sum_{i=1}^{21} c_i^2 u_i^2}$							9.55	9.43	257
Expanded uncertainty (confidence interval of 95 %)	$u_e = 2u_c$							19.1	18.9	

16.2 Measurement Uncertainty for Fast SAR Tests (300MHz~3GHz)

No.	Error Description	Type	Uncertainty value	Probably Distribution	Div.	(Ci) 1g	(Ci) 10g	Std. Unc. (1g)	Std. Unc. (10g)	Degree of freedom
Measurement system										
1	Probe calibration	B	6.0	N	1	1	1	6.0	6.0	∞
2	Isotropy	B	4.7	R	$\sqrt{3}$	0.7	0.7	1.9	1.9	∞
3	Boundary effect	B	1.0	R	$\sqrt{3}$	1	1	0.6	0.6	∞
4	Linearity	B	4.7	R	$\sqrt{3}$	1	1	2.7	2.7	∞
5	Detection limit	B	1.0	R	$\sqrt{3}$	1	1	0.6	0.6	∞
6	Readout electronics	B	0.3	R	$\sqrt{3}$	1	1	0.3	0.3	∞
7	Response time	B	0.8	R	$\sqrt{3}$	1	1	0.5	0.5	∞
8	Integration time	B	2.6	R	$\sqrt{3}$	1	1	1.5	1.5	∞
9	RF ambient conditions-noise	B	0	R	$\sqrt{3}$	1	1	0	0	∞
10	RFambient conditions-reflection	B	0	R	$\sqrt{3}$	1	1	0	0	∞
11	Probe positioned mech. Restrictions	B	0.4	R	$\sqrt{3}$	1	1	0.2	0.2	∞
12	Probe positioning with respect to phantom shell	B	2.9	R	$\sqrt{3}$	1	1	1.7	1.7	∞
13	Post-processing	B	1.0	R	$\sqrt{3}$	1	1	0.6	0.6	∞
14	Fast SAR z-Approximation	B	7.0	R	$\sqrt{3}$	1	1	4.0	4.0	∞
Test sample related										
15	Test sample positioning	A	3.3	N	1	1	1	3.3	3.3	71
16	Device holder uncertainty	A	3.4	N	1	1	1	3.4	3.4	5
17	Drift of output power	B	5.0	R	$\sqrt{3}$	1	1	2.9	2.9	∞
Phantom and set-up										
18	Phantom uncertainty	B	4.0	R	$\sqrt{3}$	1	1	2.3	2.3	∞
19	Liquid conductivity (target)	B	5.0	R	$\sqrt{3}$	0.64	0.43	1.8	1.2	∞
20	Liquid conductivity	A	2.06	N	1	0.64	0.43	1.32	0.89	43

	(meas.)									
21	Liquid permittivity (target)	B	5.0	R	$\sqrt{3}$	0.6	0.49	1.7	1.4	∞
22	Liquid permittivity (meas.)	A	1.6	N	1	0.6	0.49	1.0	0.8	521
Combined standard uncertainty		$u_c = \sqrt{\sum_{i=1}^{22} c_i^2 u_i^2}$						10.4	10.3	257
Expanded uncertainty (confidence interval of 95 %)		$u_e = 2u_c$						20.8	20.6	

17 MAIN TEST INSTRUMENTS

Table 17.1: List of Main Instruments

No.	Name	Type	Serial Number	Calibration Date	Valid Period
01	Network analyzer	E5071C	MY46110673	January 14, 2021	One year
02	Power meter	NRVD	102083	October 23, 2020	One year
03	Power sensor	NRV-Z5	100542		
04	Signal Generator	E4438C	MY49071430	February 1, 2021	One Year
05	Amplifier	60S1G4	0331848	No Calibration Requested	
06	BTS	CMW500	159890	January 25 2021	One year
07	BTS	CMW500	159889	January 13 2021	One year
08	E-field Probe	SPEAG EX3DV4	7464	December 18,2020	One year
09	DAE	SPEAG DAE4	1588	September 2, 2020	One year
10	Dipole Validation Kit	SPEAG D750V3	1017	July 24,2020	One year
11	Dipole Validation Kit	SPEAG D835V2	4d069	July 24,,2020	One year
12	Dipole Validation Kit	SPEAG D1750V2	1003	July 24, 2020	One year
13	Dipole Validation Kit	SPEAG D1900V2	5d101	July 28,2020	One year
14	Dipole Validation Kit	SPEAG D2450V2	853	July 21,2020	One year
15	Dipole Validation Kit	SPEAG D2600V2	1012	July 21,2020	One year

END OF REPORT BODY

ANNEX A Graph Results

GSM850 Head

Date/Time: 5/21/2021

Electronics: DAE4 Sn1588

Medium: H700-6000

Medium parameters used (interpolated): $f = 848.8$ MHz; $\sigma = 0.897$ S/m; $\epsilon_r = 44.12$; $\rho = 1000$ kg/m³

Ambient Temperature: 23.3°C Liquid Temperature: 22.8°C

Communication System: UID 0, GSM 850 (0) Frequency: 848.8 MHz Duty Cycle: 1:8.30042

Probe: EX3DV4 - SN7464 ConvF(10.43, 10.43, 10.43) @ 848.8 MHz

Area Scan (81x131x1): Interpolated grid: dx=1.500 mm, dy=1.500 mm

Maximum value of SAR (interpolated) = 0.190 W/kg

Zoom Scan (5x5x7)/Cube 0: Measurement grid: dx=8mm, dy=8mm, dz=5mm

Reference Value = 2.080 V/m; Power Drift = 0.09 dB

Peak SAR (extrapolated) = 0.194 W/kg

SAR(1 g) = 0.156 W/kg; SAR(10 g) = 0.120 W/kg

Maximum value of SAR (measured) = 0.163 W/kg

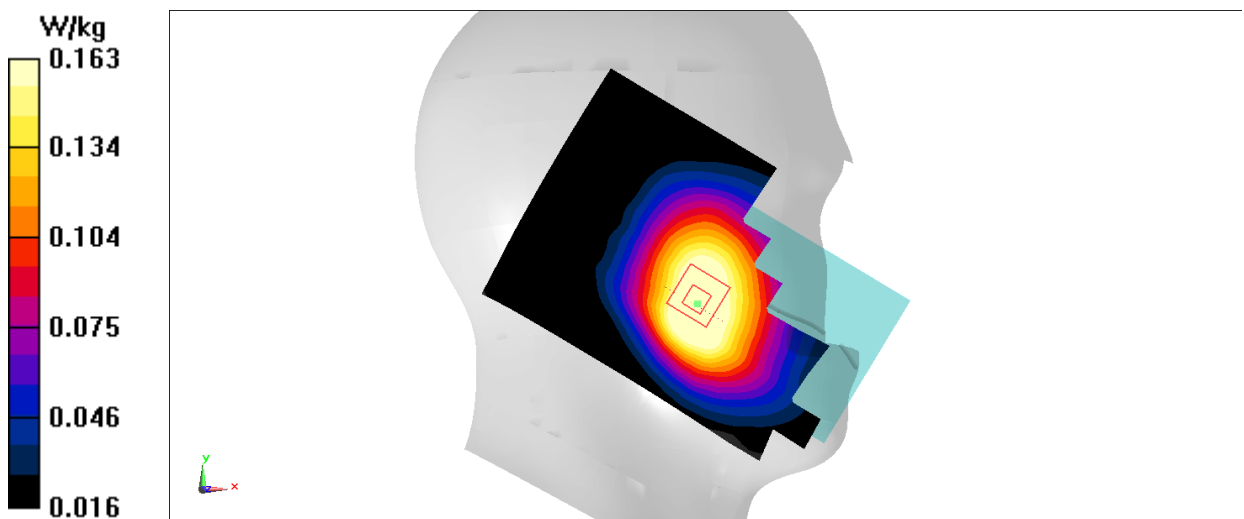

Fig. A-1

GSM850 Body

Date/Time: 5/21/2021

Electronics: DAE4 Sn1588

Medium: H700-6000

Medium parameters used (interpolated): $f = 848.8$ MHz; $\sigma = 0.897$ S/m; $\epsilon_r = 44.12$; $\rho = 1000$ kg/m³

Ambient Temperature: 23.3°C Liquid Temperature: 22.8°C

Communication System: UID 0, GSM 850 GPRS-2 (0) Frequency: 848.8 MHz Duty Cycle: 1:4.00037

Probe: EX3DV4 - SN7464 ConvF(10.43, 10.43, 10.43) @ 848.8 MHz

Area Scan (81x131x1): Interpolated grid: dx=1.500 mm, dy=1.500 mm

Maximum value of SAR (interpolated) = 0.385 W/kg

Zoom Scan (6x6x7)/Cube 0: Measurement grid: dx=8mm, dy=8mm, dz=5mm

Reference Value = 18.47 V/m; Power Drift = 0.13 dB

Peak SAR (extrapolated) = 0.430 W/kg

SAR(1 g) = 0.326 W/kg; SAR(10 g) = 0.253 W/kg

Maximum value of SAR (measured) = 0.393 W/kg

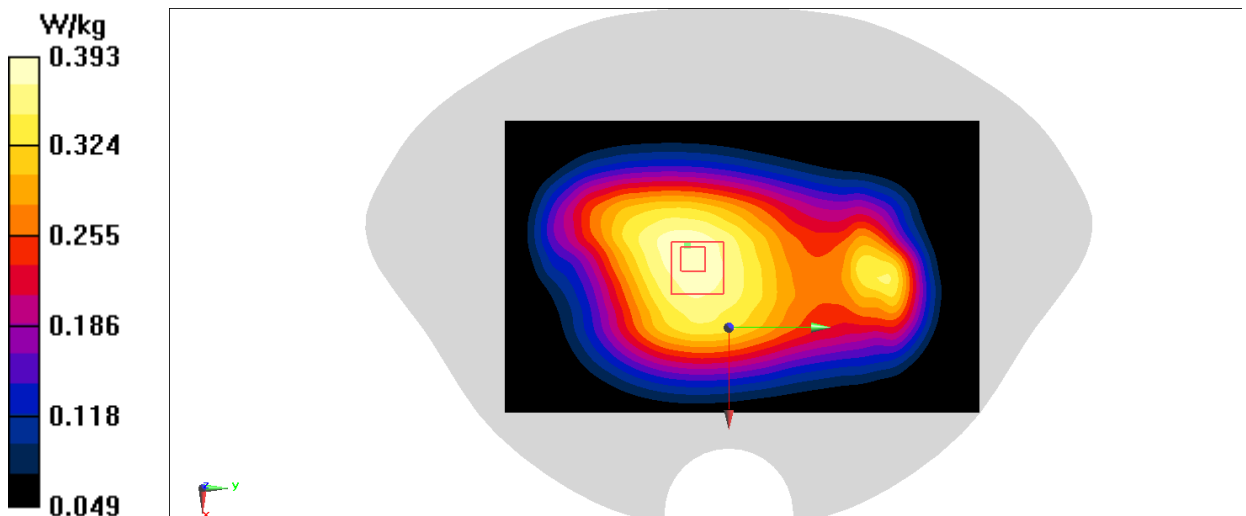

Fig. A-2

GSM1900 Head

Date/Time: 5/23/2021

Electronics: DAE4 Sn1588

Medium: H700-6000

Medium parameters used (interpolated): $f = 1850.2$ MHz; $\sigma = 1.477$ S/m; $\epsilon_r = 41.905$; $\rho = 1000$ kg/m³

Ambient Temperature: 23.5°C Liquid Temperature: 21.9°C

Communication System: UID 0, GSM 1900 (0) Frequency: 1850.2 MHz Duty Cycle: 1:8.30042

Probe: EX3DV4 - SN7464 ConvF(8.15, 8.15, 8.15) @ 1850.2 MHz

Area Scan (81x131x1): Interpolated grid: dx=1.500 mm, dy=1.500 mm

Maximum value of SAR (interpolated) = 0.274 W/kg

Zoom Scan (5x5x7)/Cube 0: Measurement grid: dx=8mm, dy=8mm, dz=5mm

Reference Value = 1.650 V/m; Power Drift = -0.07 dB

Peak SAR (extrapolated) = 0.295 W/kg

SAR(1 g) = 0.194 W/kg; SAR(10 g) = 0.123 W/kg

Maximum value of SAR (measured) = 0.256 W/kg

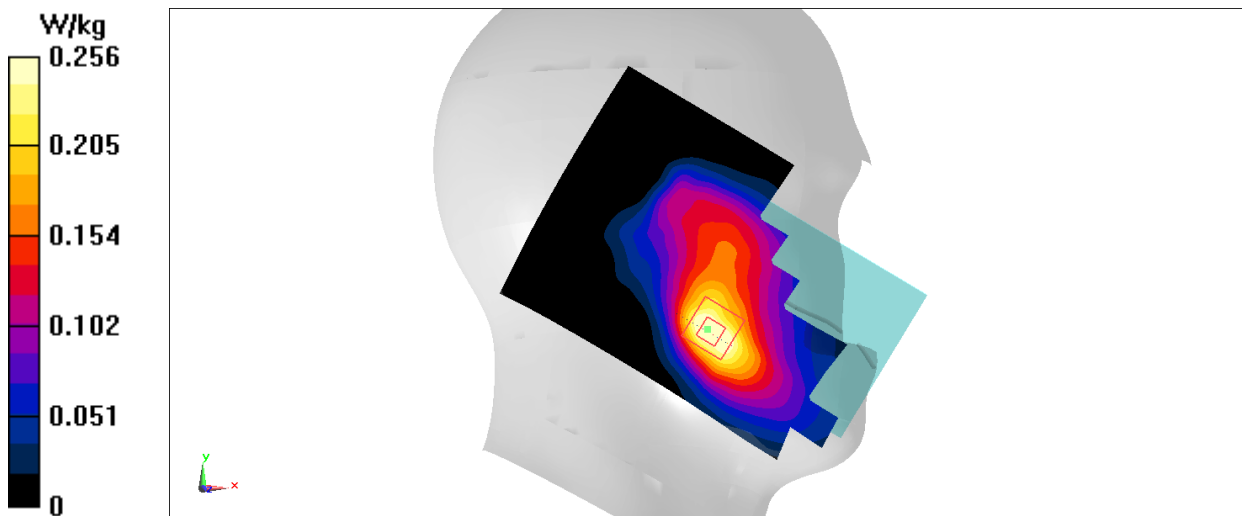

Fig. A-3

GSM1900 Body

Date/Time: 5/25/2021

Electronics: DAE4 Sn1588

Medium: H700-6000

Medium parameters used (interpolated): $f = 1850.2$ MHz; $\sigma = 1.464$ S/m; $\epsilon_r = 40.696$; $\rho = 1000$ kg/m³

Ambient Temperature: 23.8°C Liquid Temperature: 21.2°C

Communication System: UID 0, GSM 1900 GPRS-2 (0) Frequency: 1850.2 MHz Duty Cycle: 1:4.00037

Probe: EX3DV4 - SN7464 ConvF(8.15, 8.15, 8.15) @ 1850.2 MHz

Area Scan (81x131x1): Interpolated grid: dx=1.500 mm, dy=1.500 mm

Maximum value of SAR (interpolated) = 1.30 W/kg

Zoom Scan (5x5x7)/Cube 0: Measurement grid: dx=8mm, dy=8mm, dz=5mm

Reference Value = 13.67 V/m; Power Drift = 0.05 dB

Peak SAR (extrapolated) = 1.51 W/kg

SAR(1 g) = 0.867 W/kg; SAR(10 g) = 0.473 W/kg

Maximum value of SAR (measured) = 1.29 W/kg

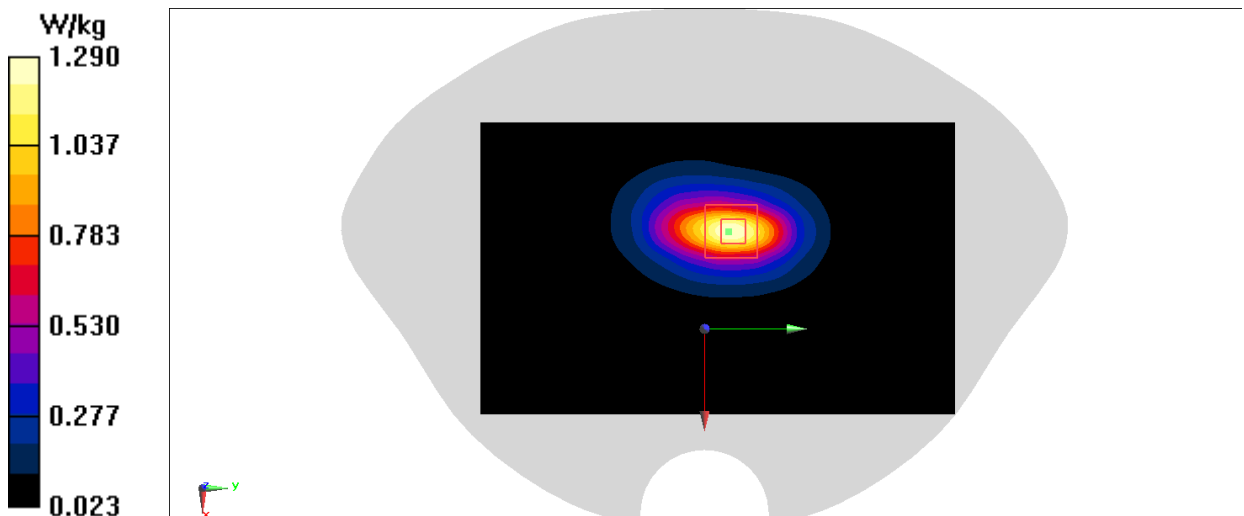

Fig. A-4

WCDMA1900 Head

Date/Time: 5/23/2021

Electronics: DAE4 Sn1588

Medium: H700-6000

Medium parameters used (interpolated): $f = 1852.4$ MHz; $\sigma = 1.478$ S/m; $\epsilon_r = 41.897$; $\rho = 1000$ kg/m³

Ambient Temperature: 23.5°C Liquid Temperature: 21.9°C

Communication System: UID 0, WCDMA 1900 (0) Frequency: 1852.4 MHz Duty Cycle: 1:1

Probe: EX3DV4 - SN7464 ConvF(8.15, 8.15, 8.15) @ 1852.4 MHz

Area Scan (81x131x1): Interpolated grid: dx=1.500 mm, dy=1.500 mm

Maximum value of SAR (interpolated) = 0.677 W/kg

Zoom Scan (5x5x7)/Cube 0: Measurement grid: dx=8mm, dy=8mm, dz=5mm

Reference Value = 3.821 V/m; Power Drift = 0.08 dB

Peak SAR (extrapolated) = 0.724 W/kg

SAR(1 g) = 0.484 W/kg; SAR(10 g) = 0.313 W/kg

Maximum value of SAR (measured) = 0.629 W/kg

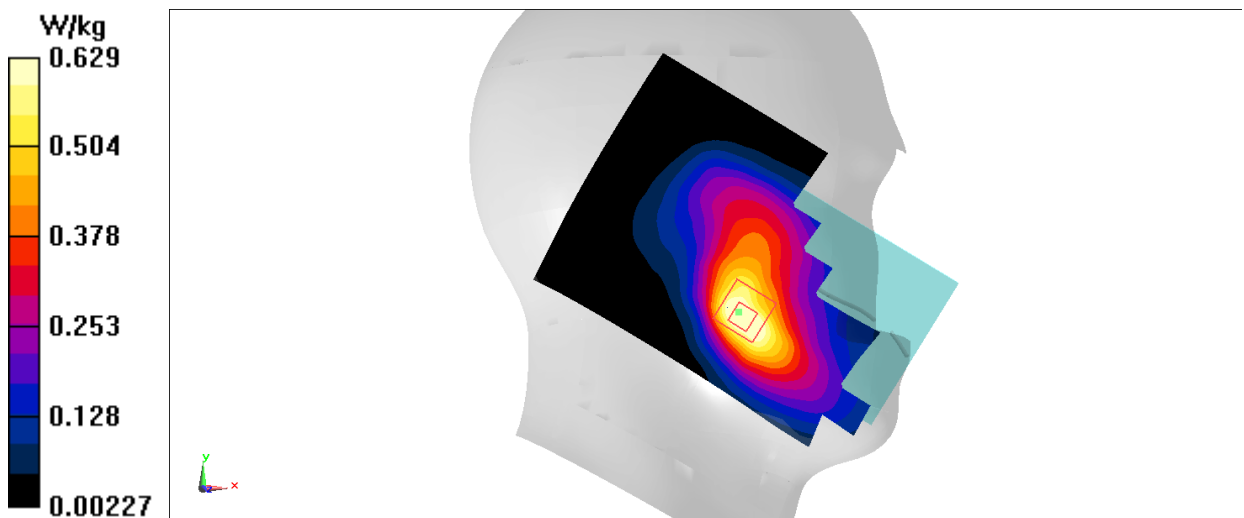

Fig. A-5

WCDMA1900 Body

Date/Time: 5/26/2021

Electronics: DAE4 Sn1588

Medium: H700-6000

Medium parameters used (interpolated): $f = 1852.4$ MHz; $\sigma = 1.465$ S/m; $\epsilon_r = 40.692$; $\rho = 1000$ kg/m³

Ambient Temperature: 23°C Liquid Temperature: 22.5°C

Communication System: UID 0, WCDMA 1900 (0) Frequency: 1852.4 MHz Duty Cycle: 1:1

Probe: EX3DV4 - SN7464 ConvF(8.15, 8.15, 8.15) @ 1852.4 MHz

Area Scan (81x131x1): Interpolated grid: dx=1.500 mm, dy=1.500 mm

Maximum value of SAR (interpolated) = 1.64 W/kg

Zoom Scan (5x5x7)/Cube 0: Measurement grid: dx=8mm, dy=8mm, dz=5mm

Reference Value = 25.70 V/m; Power Drift = 0.08 dB

Peak SAR (extrapolated) = 1.95 W/kg

SAR(1 g) = 1.11 W/kg; SAR(10 g) = 0.612 W/kg

Maximum value of SAR (measured) = 1.63 W/kg

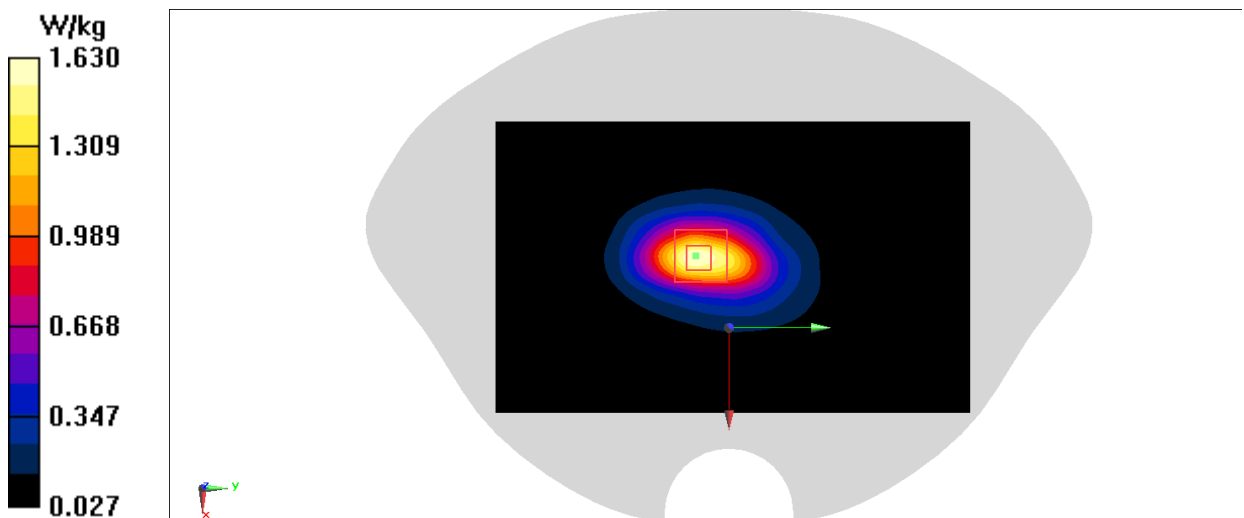

Fig. A-6

WCDMA1700 Head

Date/Time: 5/23/2021

Electronics: DAE4 Sn1588

Medium: H700-6000

Medium parameters used (interpolated): $f = 1712.4$ MHz; $\sigma = 1.359$ S/m; $\epsilon_r = 42.385$; $\rho = 1000$ kg/m³

Ambient Temperature: 23.5°C Liquid Temperature: 21.9°C

Communication System: UID 0, WCDMA 1700 Band4 (0) Frequency: 1712.4 MHz Duty Cycle: 1:1

Probe: EX3DV4 - SN7464 ConvF(8.6, 8.6, 8.6) @ 1712.4 MHz

Area Scan (81x131x1): Interpolated grid: dx=1.500 mm, dy=1.500 mm

Maximum value of SAR (interpolated) = 0.430 W/kg

Zoom Scan (5x5x7)/Cube 0: Measurement grid: dx=8mm, dy=8mm, dz=5mm

Reference Value = 2.995 V/m; Power Drift = -0.05 dB

Peak SAR (extrapolated) = 0.465 W/kg

SAR(1 g) = 0.319 W/kg; SAR(10 g) = 0.210 W/kg

Maximum value of SAR (measured) = 0.407 W/kg

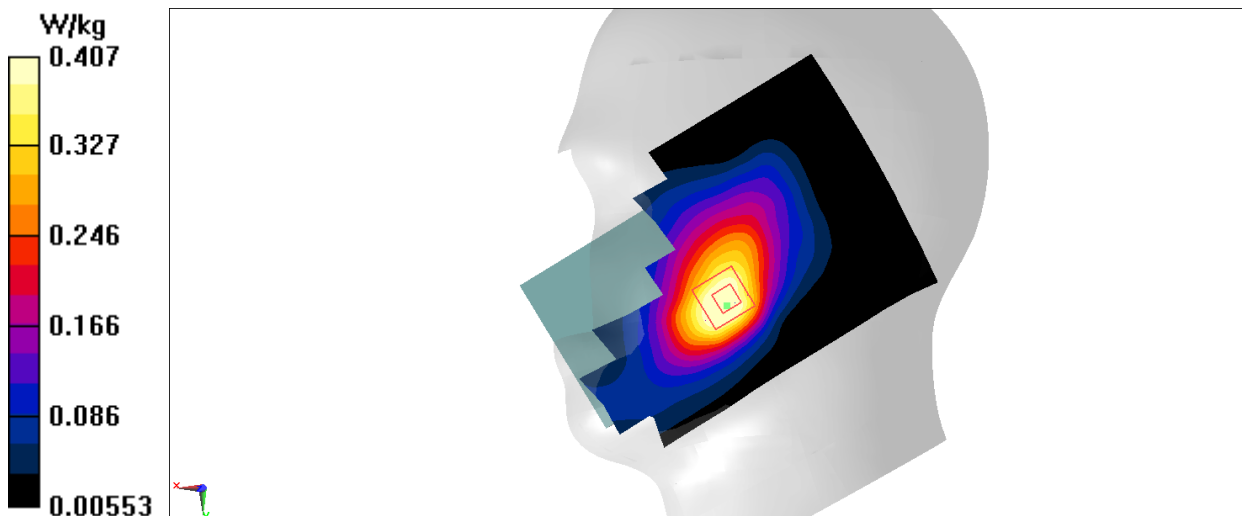

Fig. A-7

WCDMA1700 Body

Date/Time: 5/26/2021

Electronics: DAE4 Sn1588

Medium: H700-6000

Medium parameters used (interpolated): $f = 1712.4$ MHz; $\sigma = 1.386$ S/m; $\epsilon_r = 41.134$; $\rho = 1000$ kg/m³

Ambient Temperature: 23°C Liquid Temperature: 22.5°C

Communication System: UID 0, WCDMA 1700 Band4 (0) Frequency: 1712.4 MHz Duty Cycle: 1:1

Probe: EX3DV4 - SN7464 ConvF(8.6, 8.6, 8.6) @ 1712.4 MHz

Area Scan (81x131x1): Interpolated grid: dx=1.500 mm, dy=1.500 mm

Maximum value of SAR (interpolated) = 1.76 W/kg

Zoom Scan (5x5x7)/Cube 0: Measurement grid: dx=8mm, dy=8mm, dz=5mm

Reference Value = 23.05 V/m; Power Drift = 0.05 dB

Peak SAR (extrapolated) = 2.04 W/kg

SAR(1 g) = 1.16 W/kg; SAR(10 g) = 0.626 W/kg

Maximum value of SAR (measured) = 1.70 W/kg

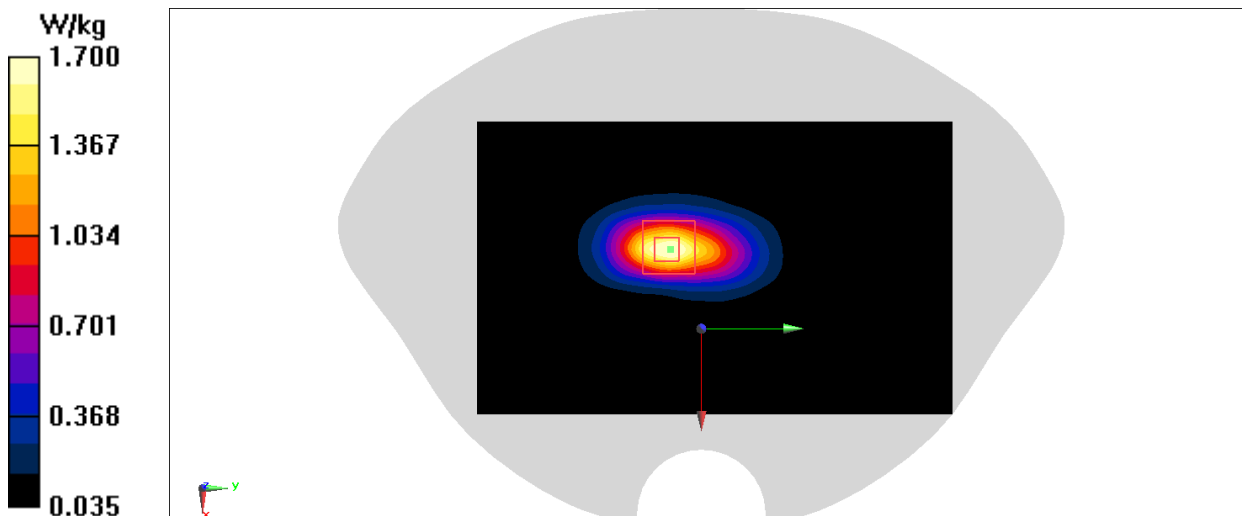

Fig. A-8

WCDMA1700 Body

Date/Time: 5/26/2021

Electronics: DAE4 Sn1588

Medium: H700-6000

Medium parameters used (interpolated): $f = 1712.4$ MHz; $\sigma = 1.386$ S/m; $\epsilon_r = 41.134$; $\rho = 1000$ kg/m³

Ambient Temperature: 23°C Liquid Temperature: 22.5°C

Communication System: UID 0, WCDMA 1700 Band4 (0) Frequency: 1712.4 MHz Duty Cycle: 1:1

Probe: EX3DV4 - SN7464 ConvF(8.6, 8.6, 8.6) @ 1712.4 MHz

Area Scan (81x131x1): Interpolated grid: dx=1.500 mm, dy=1.500 mm

Maximum value of SAR (interpolated) = 1.23 W/kg

Zoom Scan (5x5x7)/Cube 0: Measurement grid: dx=8mm, dy=8mm, dz=5mm

Reference Value = 6.530 V/m; Power Drift = 0.08 dB

Peak SAR (extrapolated) = 1.46 W/kg

SAR(1 g) = 0.872 W/kg; SAR(10 g) = 0.492 W/kg

Maximum value of SAR (measured) = 1.25 W/kg

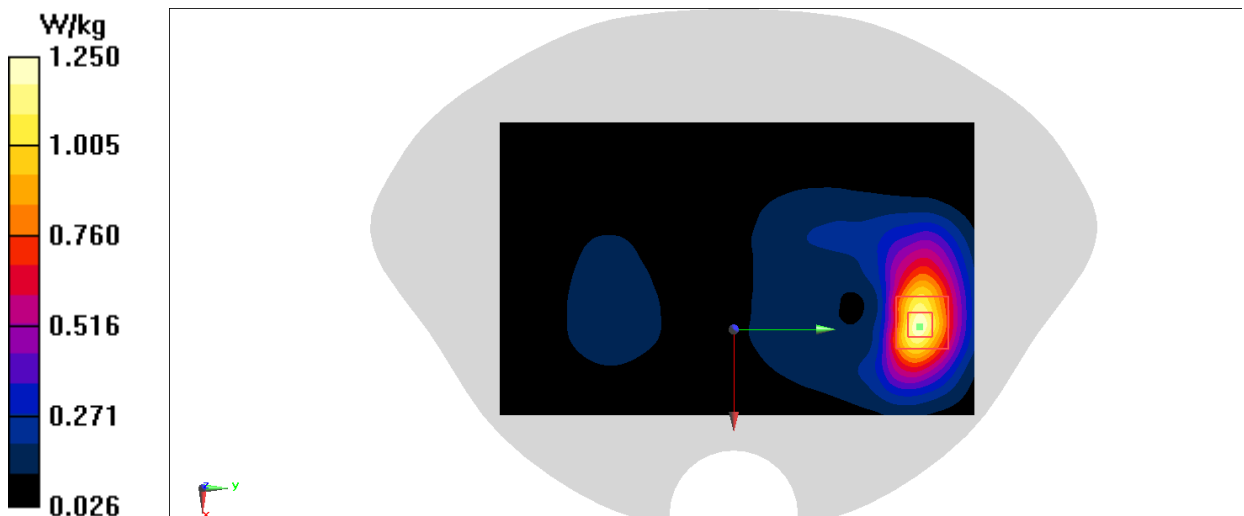

Fig. A-9

WCDMA850 Head

Date/Time: 5/21/2021

Electronics: DAE4 Sn1588

Medium: H700-6000

Medium parameters used (interpolated): $f = 836.6$ MHz; $\sigma = 0.892$ S/m; $\epsilon_r = 44.15$; $\rho = 1000$ kg/m³

Ambient Temperature: 23.3°C Liquid Temperature: 22.8°C

Communication System: UID 0, WCDMA 850 (0) Frequency: 836.6 MHz Duty Cycle: 1:1

Probe: EX3DV4 - SN7464 ConvF(10.43, 10.43, 10.43) @ 836.6 MHz

Area Scan (81x131x1): Interpolated grid: dx=1.500 mm, dy=1.500 mm

Maximum value of SAR (interpolated) = 0.273 W/kg

Zoom Scan (5x5x7)/Cube 0: Measurement grid: dx=8mm, dy=8mm, dz=5mm

Reference Value = 3.972 V/m; Power Drift = -0.11 dB

Peak SAR (extrapolated) = 0.272 W/kg

SAR(1 g) = 0.224 W/kg; SAR(10 g) = 0.175 W/kg

Maximum value of SAR (measured) = 0.234 W/kg

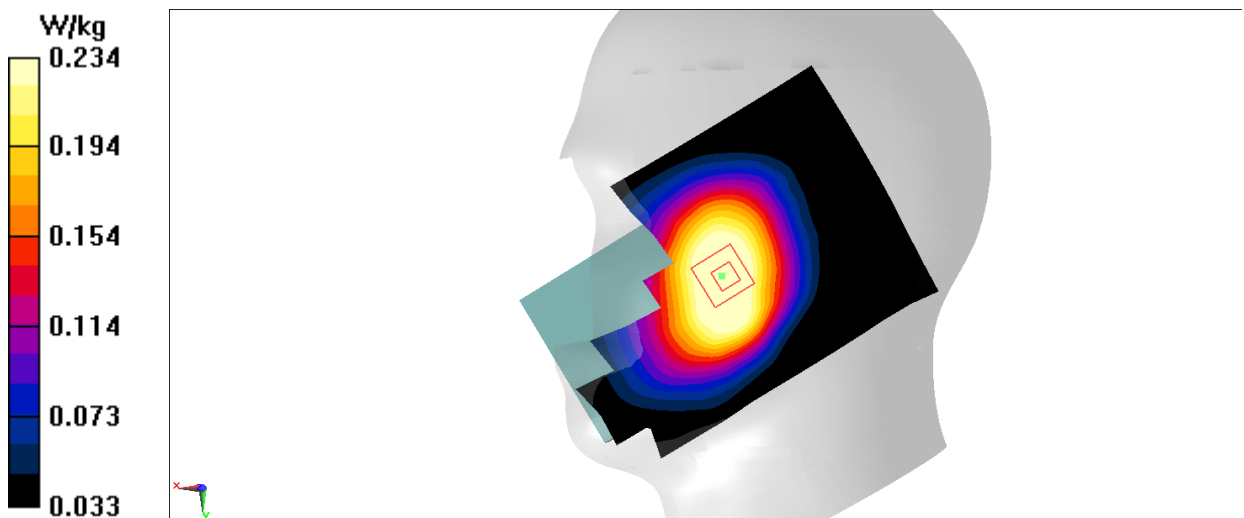

Fig. A-10

WCDMA850 Body

Date/Time: 5/21/2021

Electronics: DAE4 Sn1588

Medium: H700-6000

Medium parameters used (interpolated): $f = 826.4$ MHz; $\sigma = 0.888$ S/m; $\epsilon_r = 44.183$; $\rho = 1000$ kg/m³

Ambient Temperature: 23.3°C Liquid Temperature: 22.8°C

Communication System: UID 0, WCDMA 850 (0) Frequency: 826.4 MHz Duty Cycle: 1:1

Probe: EX3DV4 - SN7464 ConvF(10.43, 10.43, 10.43) @ 826.4 MHz

Area Scan (81x131x1): Interpolated grid: dx=1.500 mm, dy=1.500 mm

Maximum value of SAR (interpolated) = 0.435 W/kg

Zoom Scan (5x5x7)/Cube 0: Measurement grid: dx=8mm, dy=8mm, dz=5mm

Reference Value = 19.41 V/m; Power Drift = 0.01 dB

Peak SAR (extrapolated) = 0.430 W/kg

SAR(1 g) = 0.347 W/kg; SAR(10 g) = 0.269 W/kg

Maximum value of SAR (measured) = 0.361 W/kg

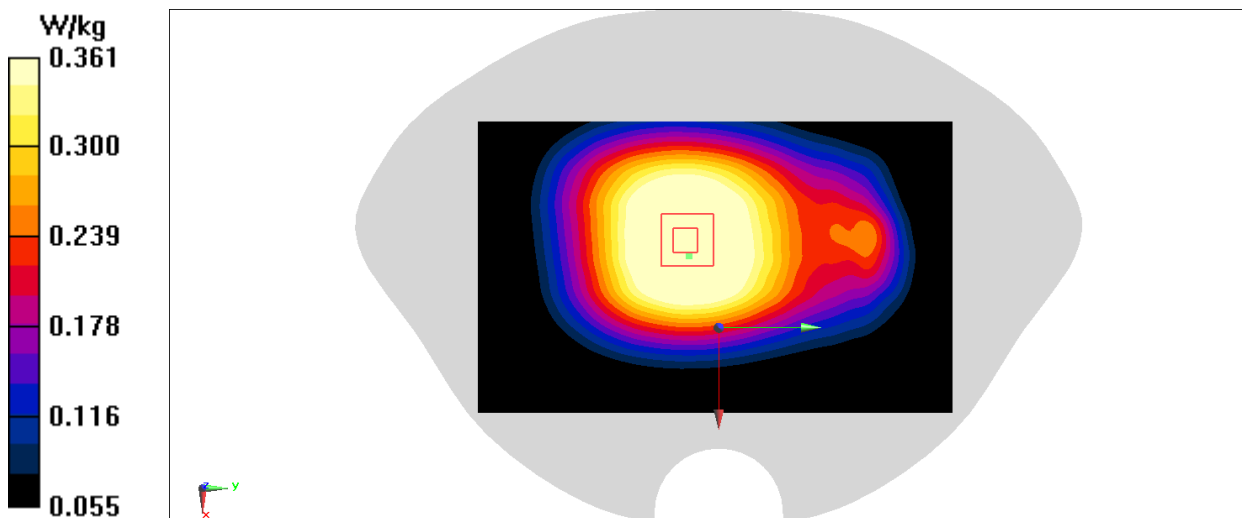

Fig. A-11

LTE Band12 Head

Date/Time: 5/21/2021

Electronics: DAE4 Sn1588

Medium: H700-6000

Medium parameters used (interpolated): $f = 704$ MHz; $\sigma = 0.839$ S/m; $\epsilon_r = 44.589$; $\rho = 1000$ kg/m³

Ambient Temperature: 23.3°C Liquid Temperature: 22.8°C

Communication System: UID 0, LTE Band12 (0) Frequency: 704 MHz Duty Cycle: 1:1

Probe: EX3DV4 - SN7464 ConvF(10.43, 10.43, 10.43) @ 704 MHz

Area Scan (81x131x1): Interpolated grid: dx=1.500 mm, dy=1.500 mm

Maximum value of SAR (interpolated) = 0.375 W/kg

Zoom Scan (5x5x7)/Cube 0: Measurement grid: dx=8mm, dy=8mm, dz=5mm

Reference Value = 7.688 V/m; Power Drift = 0.14 dB

Peak SAR (extrapolated) = 0.378 W/kg

SAR(1 g) = 0.315 W/kg; SAR(10 g) = 0.251 W/kg

Maximum value of SAR (measured) = 0.327 W/kg

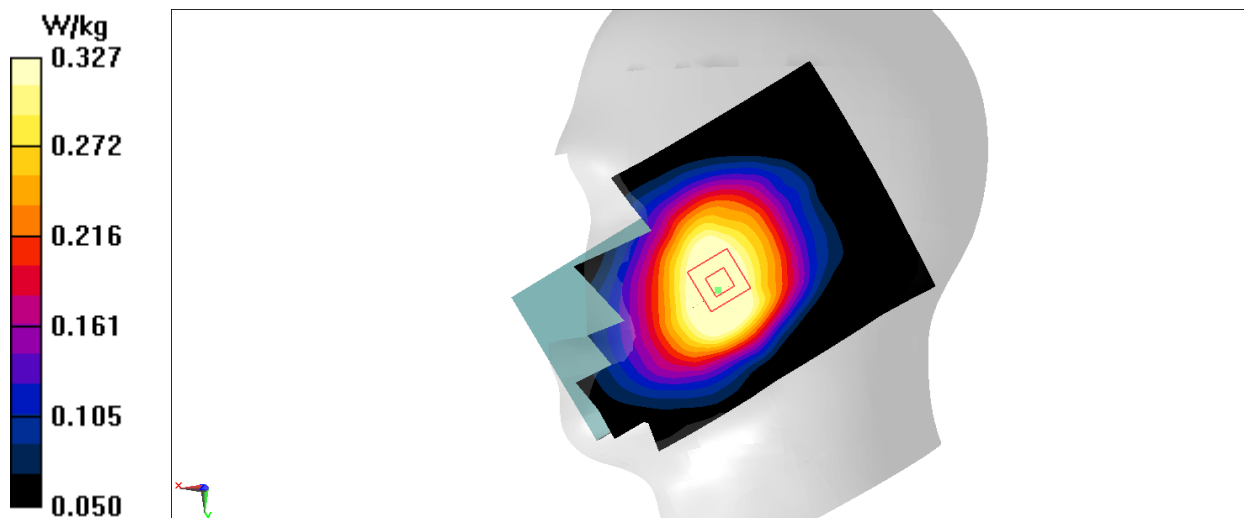

Fig. A-12

LTE Band12 Body

Date/Time: 5/21/2021

Electronics: DAE4 Sn1588

Medium: H700-6000

Medium parameters used (interpolated): $f = 704 \text{ MHz}$; $\sigma = 0.839 \text{ S/m}$; $\epsilon_r = 44.589$; $\rho = 1000 \text{ kg/m}^3$

Ambient Temperature: 23.3°C Liquid Temperature: 22.8°C

Communication System: UID 0, LTE Band12 (0) Frequency: 704 MHz Duty Cycle: 1:1

Probe: EX3DV4 - SN7464 ConvF(10.43, 10.43, 10.43) @ 704 MHz

Area Scan (81x131x1): Interpolated grid: $dx=1.500 \text{ mm}$, $dy=1.500 \text{ mm}$

Maximum value of SAR (interpolated) = 0.526 W/kg

Zoom Scan (6x6x7)/Cube 0: Measurement grid: $dx=8\text{mm}$, $dy=8\text{mm}$, $dz=5\text{mm}$

Reference Value = 22.11 V/m; Power Drift = 0.07 dB

Peak SAR (extrapolated) = 0.582 W/kg

SAR(1 g) = 0.445 W/kg; SAR(10 g) = 0.351 W/kg

Maximum value of SAR (measured) = 0.532 W/kg

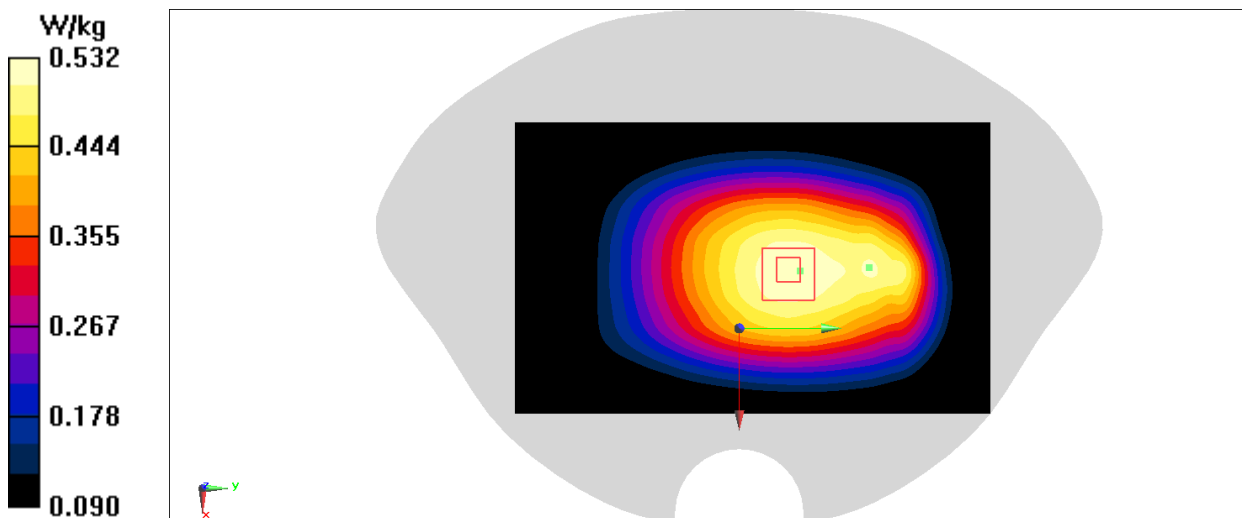

Fig. A-13

LTE Band13 Head

Date/Time: 5/21/2021

Electronics: DAE4 Sn1588

Medium: H700-6000

Medium parameters used (interpolated): $f = 782$ MHz; $\sigma = 0.87$ S/m; $\epsilon_r = 44.319$; $\rho = 1000$ kg/m³

Ambient Temperature: 23.3°C Liquid Temperature: 22.8°C

Communication System: UID 0, LTE Band13 (0) Frequency: 782 MHz Duty Cycle: 1:1

Probe: EX3DV4 - SN7464 ConvF(10.43, 10.43, 10.43) @ 782 MHz

Area Scan (81x131x1): Interpolated grid: dx=1.500 mm, dy=1.500 mm

Maximum value of SAR (interpolated) = 0.371 W/kg

Zoom Scan (5x5x7)/Cube 0: Measurement grid: dx=8mm, dy=8mm, dz=5mm

Reference Value = 4.309 V/m; Power Drift = 0.17 dB

Peak SAR (extrapolated) = 0.372 W/kg

SAR(1 g) = 0.309 W/kg; SAR(10 g) = 0.244 W/kg

Maximum value of SAR (measured) = 0.319 W/kg

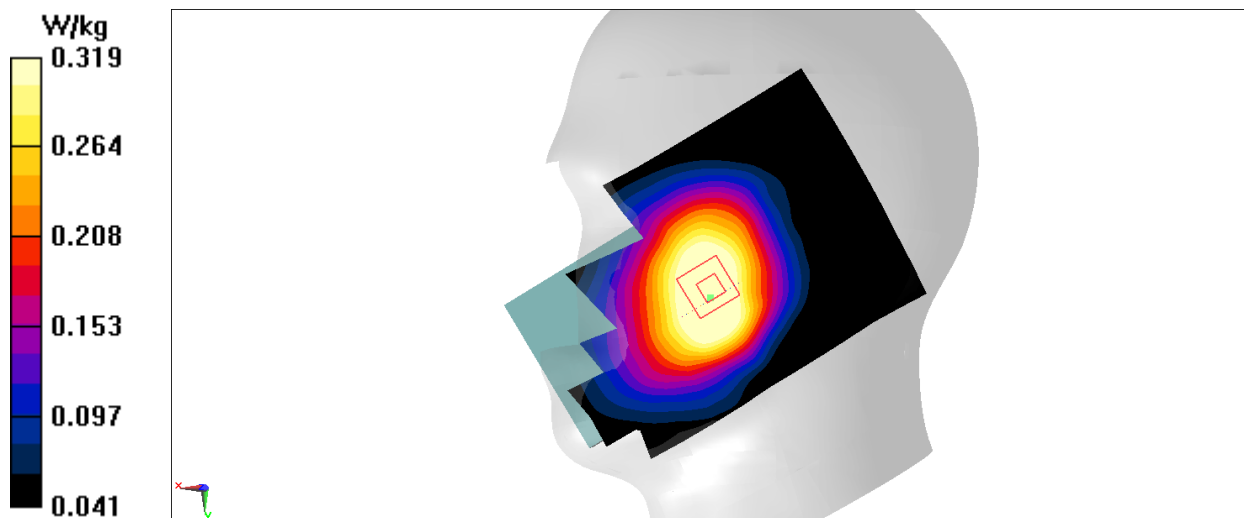

Fig. A-14

LTE Band13 Body

Date/Time: 5/21/2021

Electronics: DAE4 Sn1588

Medium: H700-6000

Medium parameters used (interpolated): $f = 782 \text{ MHz}$; $\sigma = 0.87 \text{ S/m}$; $\epsilon_r = 44.319$; $\rho = 1000 \text{ kg/m}^3$

Ambient Temperature: 23.3°C Liquid Temperature: 22.8°C

Communication System: UID 0, LTE Band13 (0) Frequency: 782 MHz Duty Cycle: 1:1

Probe: EX3DV4 - SN7464 ConvF(10.43, 10.43, 10.43) @ 782 MHz

Area Scan (81x131x1): Interpolated grid: $dx=1.500 \text{ mm}$, $dy=1.500 \text{ mm}$

Maximum value of SAR (interpolated) = 0.597 W/kg

Zoom Scan (5x5x7)/Cube 0: Measurement grid: $dx=8\text{mm}$, $dy=8\text{mm}$, $dz=5\text{mm}$

Reference Value = 24.39 V/m; Power Drift = -0.03 dB

Peak SAR (extrapolated) = 0.668 W/kg

SAR(1 g) = 0.509 W/kg; SAR(10 g) = 0.401 W/kg

Maximum value of SAR (measured) = 0.610 W/kg

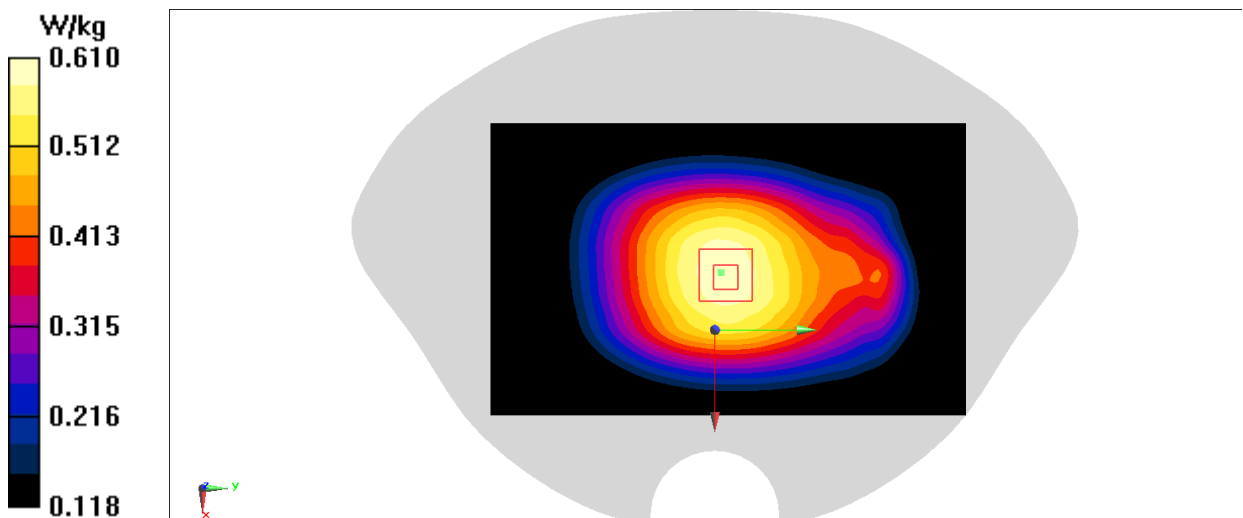

Fig. A-15

LTE Band25 Head

Date/Time: 5/23/2021

Electronics: DAE4 Sn1588

Medium: H700-6000

Medium parameters used: $f = 1860$ MHz; $\sigma = 1.484$ S/m; $\epsilon_r = 41.867$; $\rho = 1000$ kg/m³

Ambient Temperature: 23.5°C Liquid Temperature: 21.9°C

Communication System: UID 0, LTE Band25 (0) Frequency: 1860 MHz Duty Cycle: 1:1

Probe: EX3DV4 - SN7464 ConvF(8.15, 8.15, 8.15) @ 1860 MHz

Area Scan (81x131x1): Interpolated grid: dx=1.500 mm, dy=1.500 mm

Maximum value of SAR (interpolated) = 0.656 W/kg

Zoom Scan (5x5x7)/Cube 0: Measurement grid: dx=8mm, dy=8mm, dz=5mm

Reference Value = 3.958 V/m; Power Drift = -0.05 dB

Peak SAR (extrapolated) = 0.705 W/kg

SAR(1 g) = 0.469 W/kg; SAR(10 g) = 0.304 W/kg

Maximum value of SAR (measured) = 0.620 W/kg

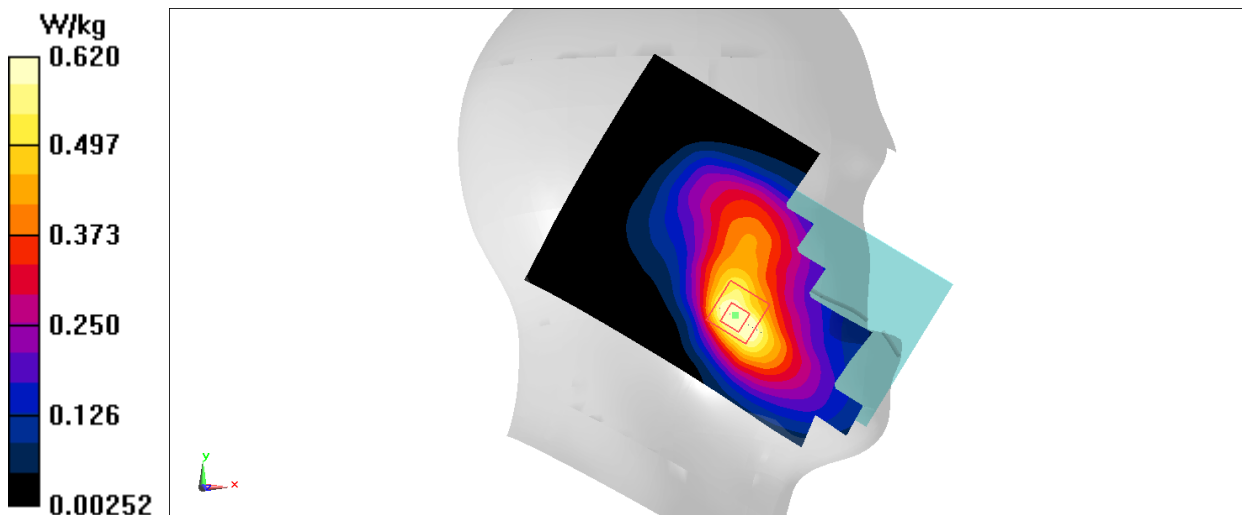

Fig. A-16

LTE Band25 Body

Date/Time: 5/26/2021

Electronics: DAE4 Sn1588

Medium: H700-6000

Medium parameters used: $f = 1860$ MHz; $\sigma = 1.469$ S/m; $\epsilon_r = 40.68$; $\rho = 1000$ kg/m³

Ambient Temperature: 23°C Liquid Temperature: 22.5°C

Communication System: UID 0, LTE Band25 (0) Frequency: 1860 MHz Duty Cycle: 1:1

Probe: EX3DV4 - SN7464 ConvF(8.15, 8.15, 8.15) @ 1860 MHz

Area Scan (81x131x1): Interpolated grid: dx=1.500 mm, dy=1.500 mm

Maximum value of SAR (interpolated) = 1.34 W/kg

Zoom Scan (7x7x7)/Cube 0: Measurement grid: dx=5mm, dy=5mm, dz=5mm

Reference Value = 22.84 V/m; Power Drift = -0.15 dB

Peak SAR (extrapolated) = 1.46 W/kg

SAR(1 g) = 0.874 W/kg; SAR(10 g) = 0.484 W/kg

Maximum value of SAR (measured) = 0.969 W/kg

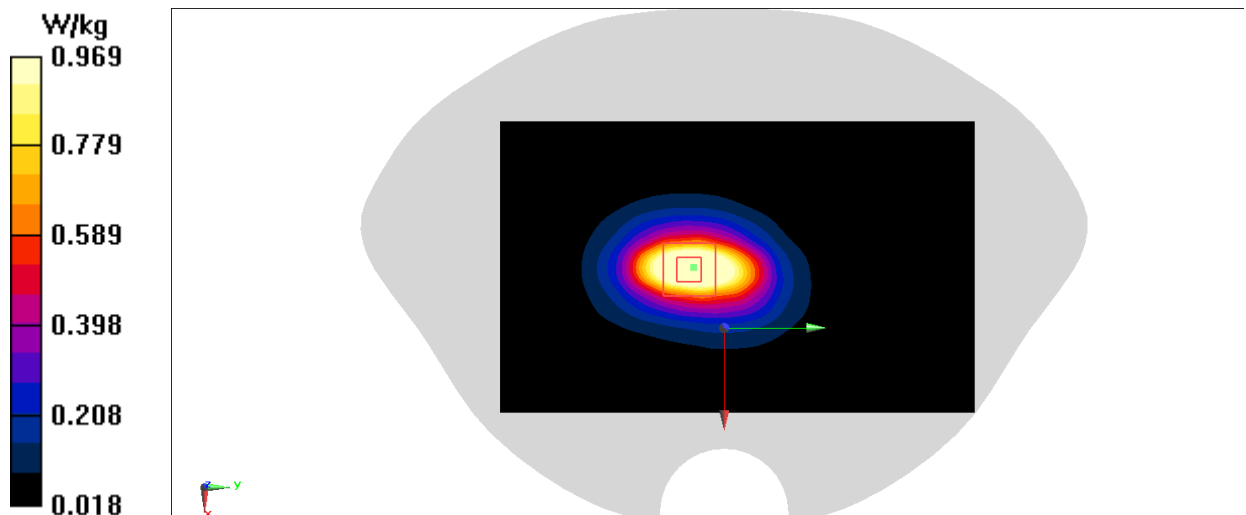

Fig. A-17

LTE Band25 Body

Date/Time: 5/26/2021

Electronics: DAE4 Sn1588

Medium: H700-6000

Medium parameters used: $f = 1860 \text{ MHz}$; $\sigma = 1.469 \text{ S/m}$; $\epsilon_r = 40.68$; $\rho = 1000 \text{ kg/m}^3$

Ambient Temperature: 23°C Liquid Temperature: 22.5°C

Communication System: UID 0, LTE Band25 (0) Frequency: 1860 MHz Duty Cycle: 1:1

Probe: EX3DV4 - SN7464 ConvF(8.15, 8.15, 8.15) @ 1860 MHz

Area Scan (81x131x1): Interpolated grid: $dx=1.500 \text{ mm}$, $dy=1.500 \text{ mm}$

Maximum value of SAR (interpolated) = 0.495 W/kg

Zoom Scan (5x5x7)/Cube 0: Measurement grid: $dx=8\text{mm}$, $dy=8\text{mm}$, $dz=5\text{mm}$

Reference Value = 9.741 V/m ; Power Drift = -0.04 dB

Peak SAR (extrapolated) = 0.578 W/kg

SAR(1 g) = 0.340 W/kg ; SAR(10 g) = 0.201 W/kg

Maximum value of SAR (measured) = 0.491 W/kg

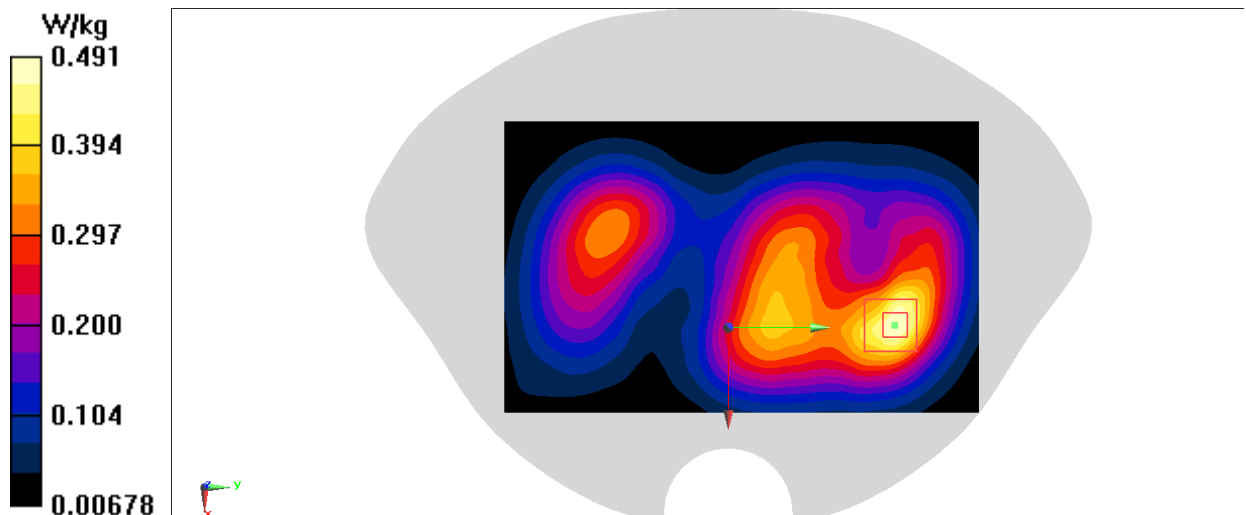

Fig. A-18

LTE Band26 Head

Date/Time: 5/21/2021

Electronics: DAE4 Sn1588

Medium: H700-6000

Medium parameters used (interpolated): $f = 831.5$ MHz; $\sigma = 0.89$ S/m; $\epsilon_r = 44.166$; $\rho = 1000$ kg/m³

Ambient Temperature: 23.3°C Liquid Temperature: 22.8°C

Communication System: UID 0, LTE Band26 (0) Frequency: 831.5 MHz Duty Cycle: 1:1

Probe: EX3DV4 - SN7464 ConvF(10.43, 10.43, 10.43) @ 831.5 MHz

Area Scan (81x131x1): Interpolated grid: dx=1.500 mm, dy=1.500 mm

Maximum value of SAR (interpolated) = 0.348 W/kg

Zoom Scan (5x5x7)/Cube 0: Measurement grid: dx=8mm, dy=8mm, dz=5mm

Reference Value = 2.232 V/m; Power Drift = 0.05 dB

Peak SAR (extrapolated) = 0.384 W/kg

SAR(1 g) = 0.297 W/kg; SAR(10 g) = 0.234 W/kg

Maximum value of SAR (measured) = 0.354 W/kg

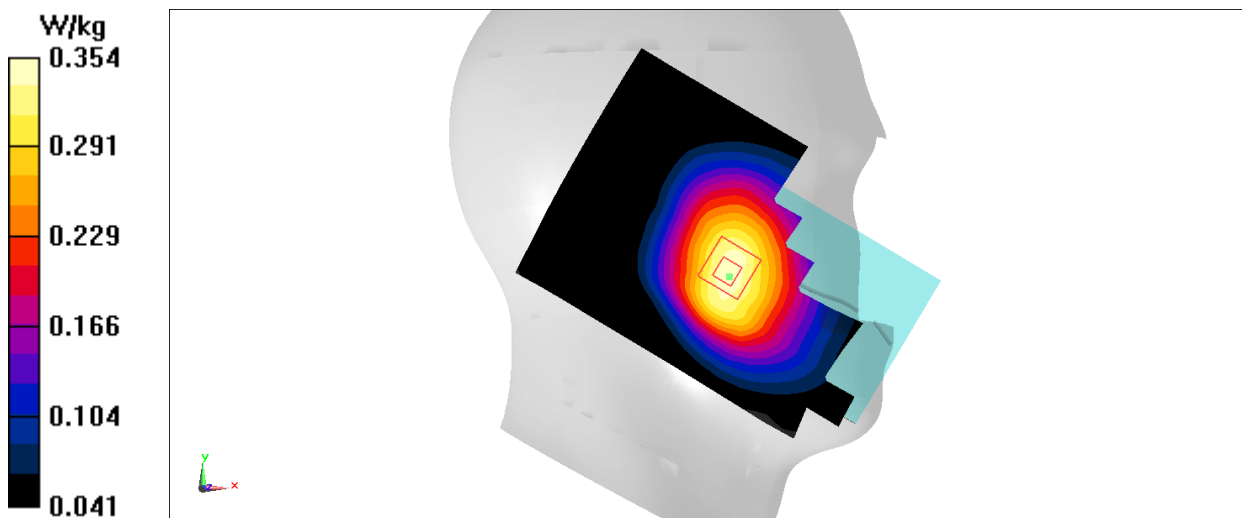

Fig. A-19

LTE Band26 Body

Date/Time: 5/21/2021

Electronics: DAE4 Sn1588

Medium: H700-6000

Medium parameters used (interpolated): $f = 831.5$ MHz; $\sigma = 0.89$ S/m; $\epsilon_r = 44.166$; $\rho = 1000$ kg/m³

Ambient Temperature: 23.3°C Liquid Temperature: 22.8°C

Communication System: UID 0, LTE Band26 (0) Frequency: 831.5 MHz Duty Cycle: 1:1

Probe: EX3DV4 - SN7464 ConvF(10.43, 10.43, 10.43) @ 831.5 MHz

Area Scan (81x131x1): Interpolated grid: dx=1.500 mm, dy=1.500 mm

Maximum value of SAR (interpolated) = 0.544 W/kg

Zoom Scan (5x5x7)/Cube 0: Measurement grid: dx=8mm, dy=8mm, dz=5mm

Reference Value = 22.51 V/m; Power Drift = 0.04 dB

Peak SAR (extrapolated) = 0.606 W/kg

SAR(1 g) = 0.457 W/kg; SAR(10 g) = 0.358 W/kg

Maximum value of SAR (measured) = 0.550 W/kg

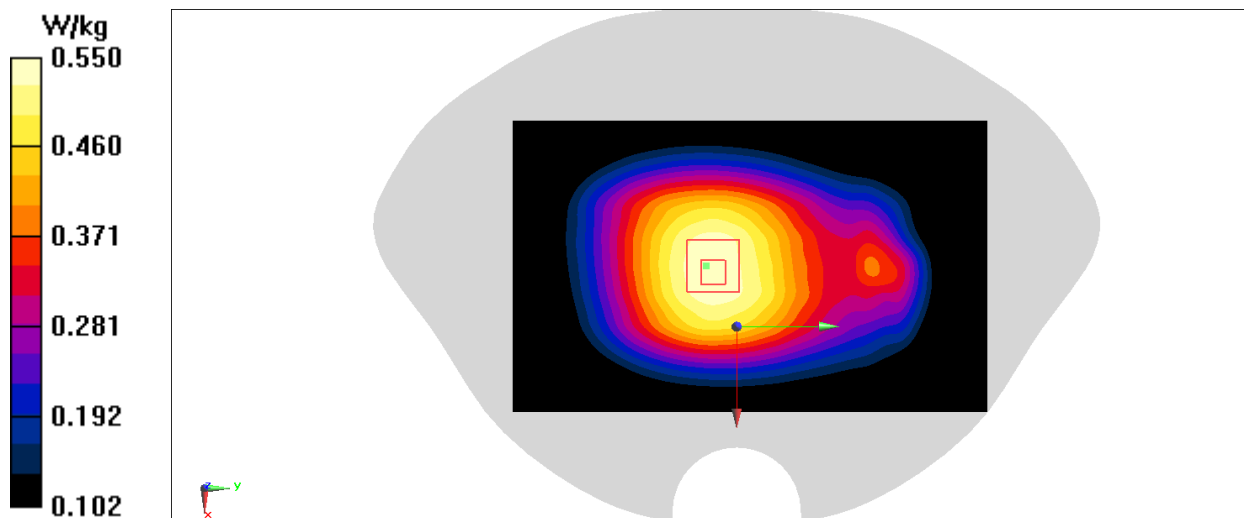

Fig. A-20

LTE Band41 Head

Date/Time: 5/23/2021

Electronics: DAE4 Sn1588

Medium: H700-6000

Medium parameters used (interpolated): $f = 2593$ MHz; $\sigma = 2.057$ S/m; $\epsilon_r = 40.544$; $\rho = 1000$ kg/m³

Ambient Temperature: 23.5°C Liquid Temperature: 21.9°C

Communication System: UID 0, LTE Band41 (0) Frequency: 2593 MHz Duty Cycle: 1:1.5787

Probe: EX3DV4 - SN7464 ConvF(7.47, 7.47, 7.47) @ 2593 MHz

Area Scan (101x161x1): Interpolated grid: dx=1.200 mm, dy=1.200 mm

Maximum value of SAR (interpolated) = 0.159 W/kg

Zoom Scan (7x7x7)/Cube 0: Measurement grid: dx=5mm, dy=5mm, dz=5mm

Reference Value = 1.430 V/m; Power Drift = -0.12 dB

Peak SAR (extrapolated) = 0.171 W/kg

SAR(1 g) = 0.096 W/kg; SAR(10 g) = 0.052 W/kg

Smallest distance from peaks to all points 3 dB below = 11 mm

Maximum value of SAR (measured) = 0.142 W/kg

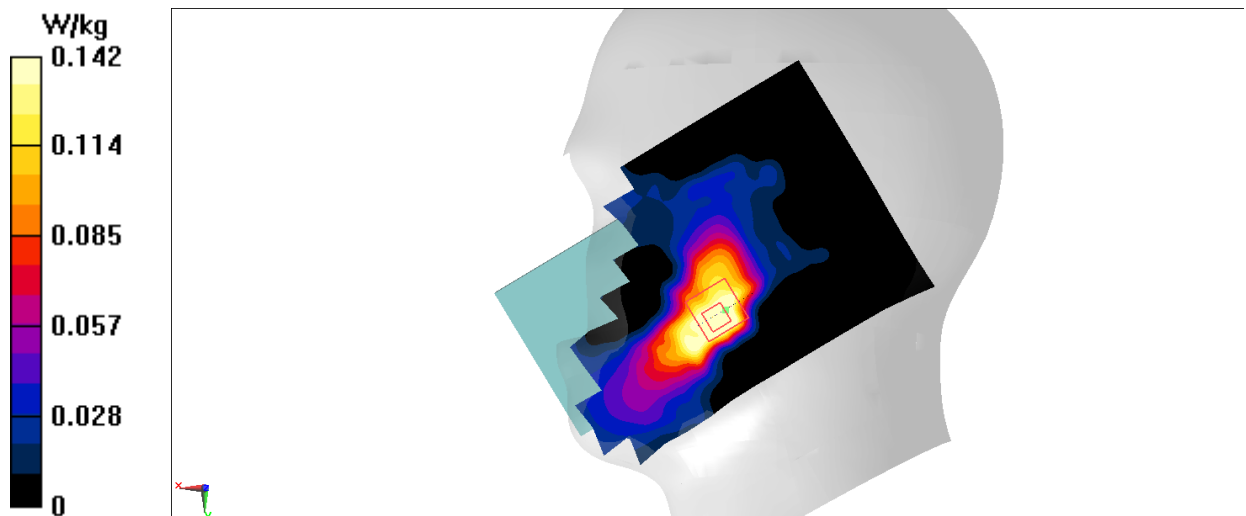

Fig. A-21

LTE Band41 Body

Date/Time: 5/26/2021

Electronics: DAE4 Sn1588

Medium: H700-6000

Medium parameters used (interpolated): $f = 2636.5$ MHz; $\sigma = 2.074$ S/m; $\epsilon_r = 39.232$; $\rho = 1000$ kg/m³

Ambient Temperature: 23°C Liquid Temperature: 22.5°C

Communication System: UID 0, LTE Band41 (0) Frequency: 2636.5 MHz Duty Cycle: 1:1.5787

Probe: EX3DV4 - SN7464 ConvF(7.47, 7.47, 7.47) @ 2636.5 MHz

Area Scan (101x161x1): Interpolated grid: dx=1.200 mm, dy=1.200 mm

Maximum value of SAR (interpolated) = 1.92 W/kg

Zoom Scan (7x7x7)/Cube 0: Measurement grid: dx=5mm, dy=5mm, dz=5mm

Reference Value = 2.361 V/m; Power Drift = 0.04 dB

Peak SAR (extrapolated) = 2.13 W/kg

SAR(1 g) = 1.04 W/kg; SAR(10 g) = 0.463 W/kg

Maximum value of SAR (measured) = 1.74 W/kg

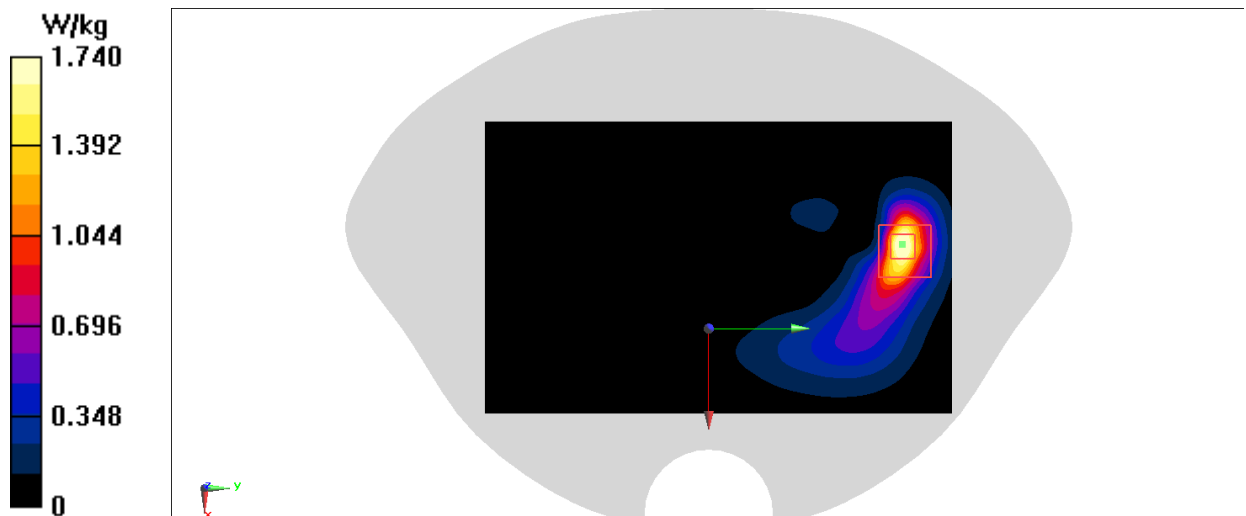

Fig. A-22

LTE Band41 Body

Date/Time: 5/26/2021

Electronics: DAE4 Sn1588

Medium: H700-6000

Medium parameters used (interpolated): $f = 2593$ MHz; $\sigma = 2.042$ S/m; $\epsilon_r = 39.327$; $\rho = 1000$ kg/m³

Ambient Temperature: 23°C Liquid Temperature: 22.5°C

Communication System: UID 0, LTE Band41 (0) Frequency: 2593 MHz Duty Cycle: 1:1.5787

Probe: EX3DV4 - SN7464 ConvF(7.47, 7.47, 7.47) @ 2593 MHz

Area Scan (101x161x1): Interpolated grid: dx=1.200 mm, dy=1.200 mm

Maximum value of SAR (interpolated) = 0.746 W/kg

Zoom Scan (7x7x7)/Cube 0: Measurement grid: dx=5mm, dy=5mm, dz=5mm

Reference Value = 2.790 V/m; Power Drift = 0.08 dB

Peak SAR (extrapolated) = 0.880 W/kg

SAR(1 g) = 0.452 W/kg; SAR(10 g) = 0.220 W/kg

Maximum value of SAR (measured) = 0.723 W/kg

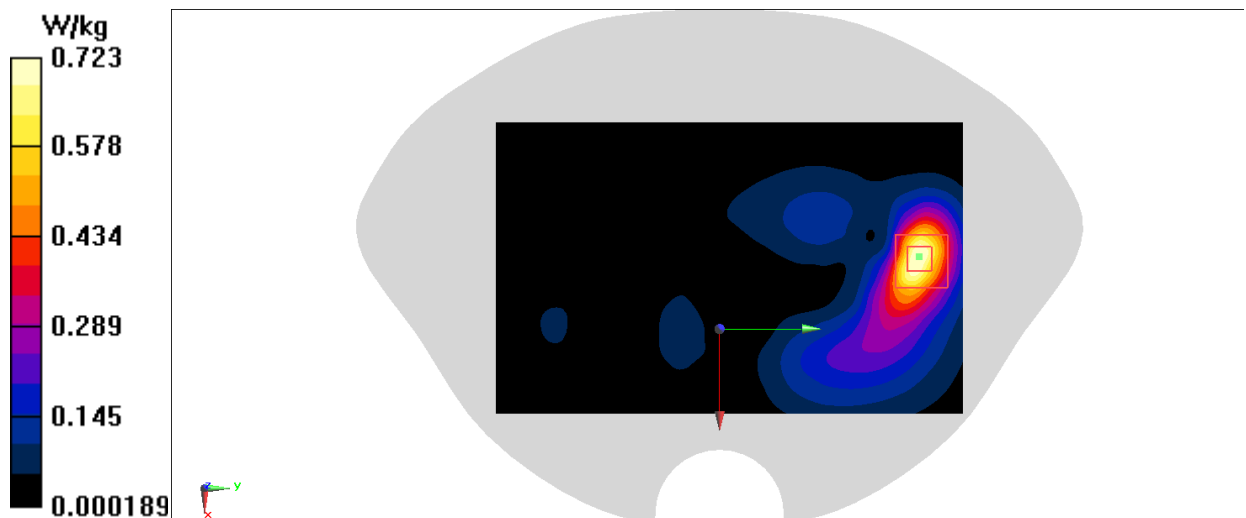

Fig. A-23

LTE Band41 HPUE Head

Date/Time: 5/23/2021

Electronics: DAE4 Sn1588

Medium: H700-6000

Medium parameters used (interpolated): $f = 2593$ MHz; $\sigma = 2.057$ S/m; $\epsilon_r = 40.544$; $\rho = 1000$ kg/m³

Ambient Temperature: 23.5°C Liquid Temperature: 21.9°C

Communication System: UID 0, LTE Band41 (0) Frequency: 2593 MHz Duty Cycle: 1:2.309

Probe: EX3DV4 - SN7464 ConvF(7.47, 7.47, 7.47) @ 2593 MHz

Area Scan (101x161x1): Interpolated grid: dx=1.200 mm, dy=1.200 mm

Maximum value of SAR (interpolated) = 0.219 W/kg

Zoom Scan (7x7x7)/Cube 0: Measurement grid: dx=5mm, dy=5mm, dz=5mm

Reference Value = 1.402 V/m; Power Drift = 0.08 dB

Peak SAR (extrapolated) = 0.241 W/kg

SAR(1 g) = 0.135 W/kg; SAR(10 g) = 0.075 W/kg

Maximum value of SAR (measured) = 0.202 W/kg

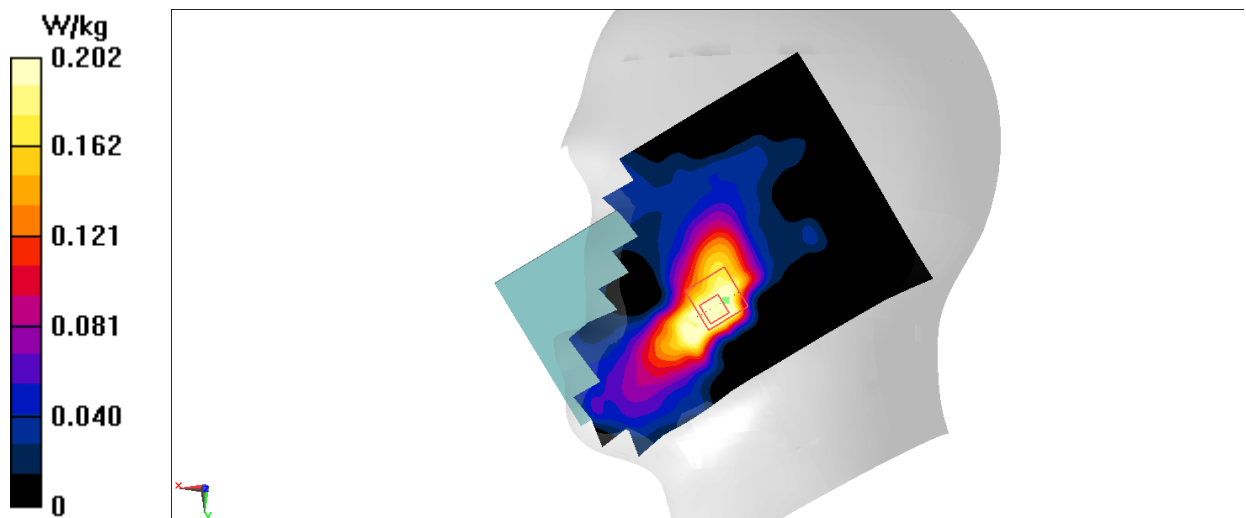

Fig. A-24

LTE Band41 HPUE Body

Date/Time: 5/26/2021

Electronics: DAE4 Sn1588

Medium: H700-6000

Medium parameters used (interpolated): $f = 2636.5$ MHz; $\sigma = 2.074$ S/m; $\epsilon_r = 39.232$; $\rho = 1000$ kg/m³

Ambient Temperature: 23°C Liquid Temperature: 22.5°C

Communication System: UID 0, LTE Band41 (0) Frequency: 2636.5 MHz Duty Cycle: 1:2.309

Probe: EX3DV4 - SN7464 ConvF(7.47, 7.47, 7.47) @ 2636.5 MHz

Area Scan (101x161x1): Interpolated grid: dx=1.200 mm, dy=1.200 mm

Maximum value of SAR (interpolated) = 1.85 W/kg

Zoom Scan (7x7x7)/Cube 0: Measurement grid: dx=5mm, dy=5mm, dz=5mm

Reference Value = 3.338 V/m; Power Drift = -0.09 dB

Peak SAR (extrapolated) = 2.21 W/kg

SAR(1 g) = 1.08 W/kg; SAR(10 g) = 0.477 W/kg

Maximum value of SAR (measured) = 1.79 W/kg

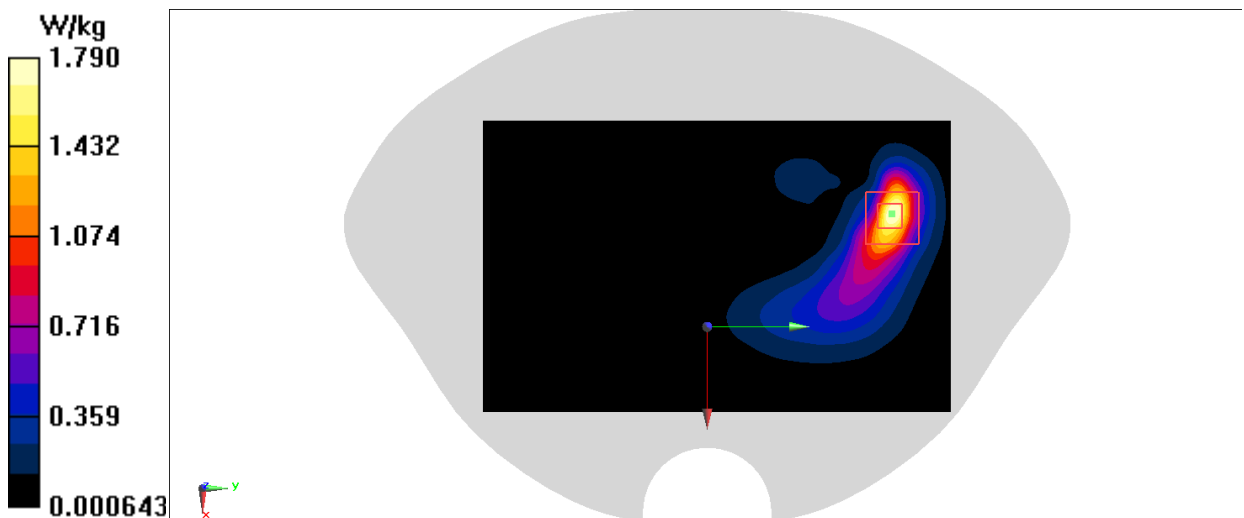

Fig. A-25

LTE Band41 HPUE Body

Date/Time: 5/26/2021

Electronics: DAE4 Sn1588

Medium: H700-6000

Medium parameters used (interpolated): $f = 2636.5$ MHz; $\sigma = 2.074$ S/m; $\epsilon_r = 39.232$; $\rho = 1000$ kg/m³

Ambient Temperature: 23°C Liquid Temperature: 22.5°C

Communication System: UID 0, LTE Band41 (0) Frequency: 2636.5 MHz Duty Cycle: 1:2.309

Probe: EX3DV4 - SN7464 ConvF(7.47, 7.47, 7.47) @ 2636.5 MHz

Area Scan (101x161x1): Interpolated grid: dx=1.200 mm, dy=1.200 mm

Maximum value of SAR (interpolated) = 1.52 W/kg

Zoom Scan (7x7x7)/Cube 0: Measurement grid: dx=5mm, dy=5mm, dz=5mm

Reference Value = 3.053 V/m; Power Drift = 0.02 dB

Peak SAR (extrapolated) = 1.74 W/kg

SAR(1 g) = 0.894 W/kg; SAR(10 g) = 0.432 W/kg

Maximum value of SAR (measured) = 1.42 W/kg

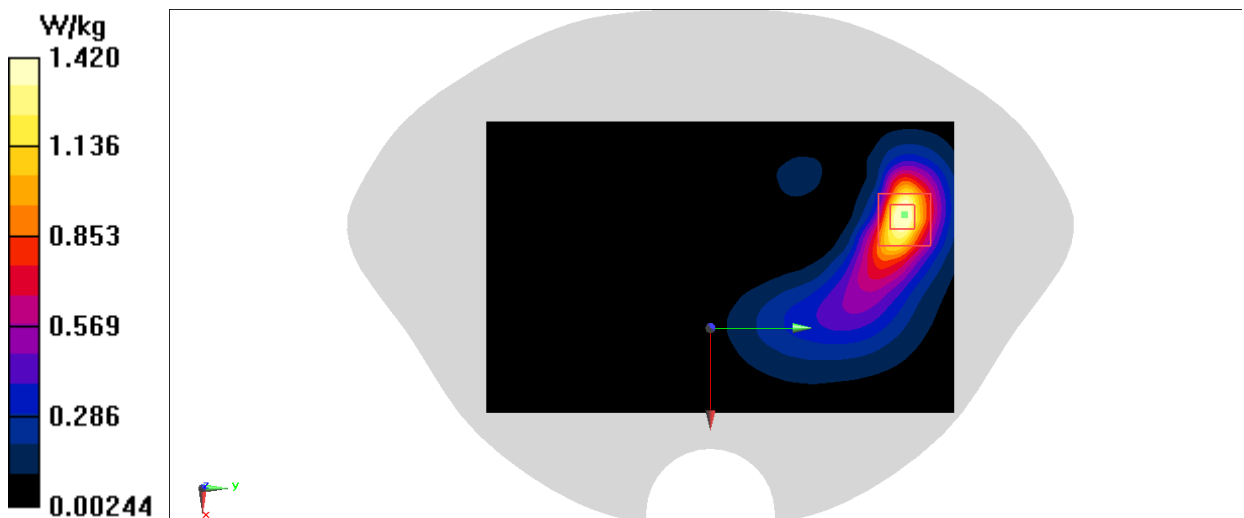

Fig. A-26

LTE Band66 Head

Date/Time: 5/23/2021

Electronics: DAE4 Sn1588

Medium: H700-6000

Medium parameters used: $f = 1770$ MHz; $\sigma = 1.415$ S/m; $\epsilon_r = 42.234$; $\rho = 1000$ kg/m³

Ambient Temperature: 23.5°C Liquid Temperature: 21.9°C

Communication System: UID 0, LTE Band66 (0) Frequency: 1770 MHz Duty Cycle: 1:1

Probe: EX3DV4 - SN7464 ConvF(8.6, 8.6, 8.6) @ 1770 MHz

Area Scan (81x131x1): Interpolated grid: dx=1.500 mm, dy=1.500 mm

Maximum value of SAR (interpolated) = 0.478 W/kg

Zoom Scan (6x6x7)/Cube 0: Measurement grid: dx=8mm, dy=8mm, dz=5mm

Reference Value = 3.088 V/m; Power Drift = 0.18 dB

Peak SAR (extrapolated) = 0.540 W/kg

SAR(1 g) = 0.363 W/kg; SAR(10 g) = 0.233 W/kg

Maximum value of SAR (measured) = 0.466 W/kg

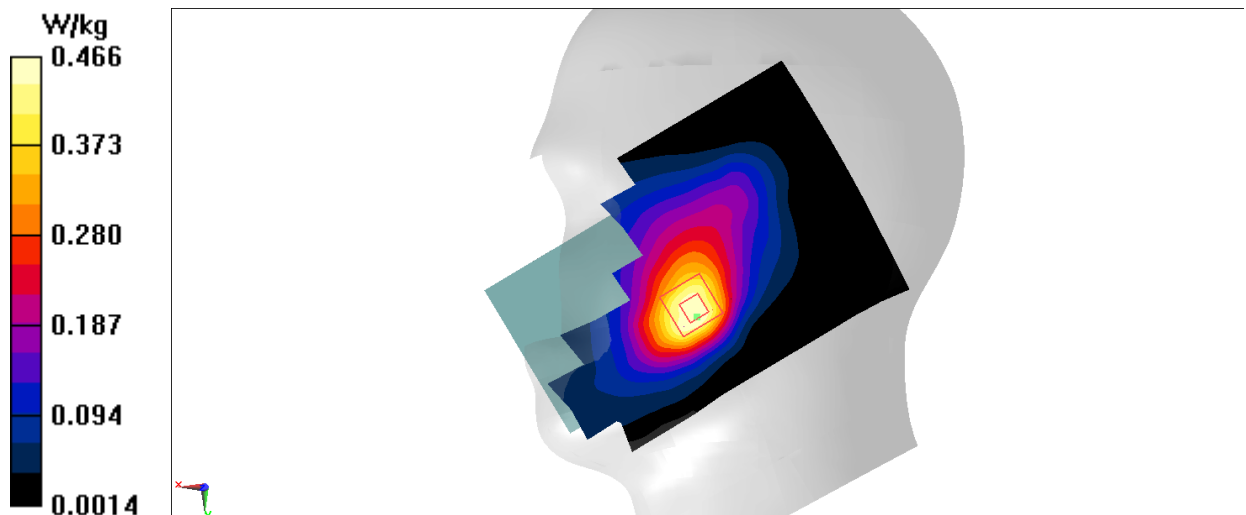

Fig. A-27

LTE Band66 Body

Date/Time: 5/26/2021

Electronics: DAE4 Sn1588

Medium: H700-6000

Medium parameters used: $f = 1720$ MHz; $\sigma = 1.391$ S/m; $\epsilon_r = 41.103$; $\rho = 1000$ kg/m³

Ambient Temperature: 23°C Liquid Temperature: 22.5°C

Communication System: UID 0, LTE Band66 (0) Frequency: 1720 MHz Duty Cycle: 1:1

Probe: EX3DV4 - SN7464 ConvF(8.6, 8.6, 8.6) @ 1720 MHz

Area Scan (81x131x1): Interpolated grid: dx=1.500 mm, dy=1.500 mm

Maximum value of SAR (interpolated) = 1.25 W/kg

Zoom Scan (5x5x7)/Cube 0: Measurement grid: dx=8mm, dy=8mm, dz=5mm

Reference Value = 22.65 V/m; Power Drift = -0.14 dB

Peak SAR (extrapolated) = 1.39 W/kg

SAR(1 g) = 0.815 W/kg; SAR(10 g) = 0.441 W/kg

Maximum value of SAR (measured) = 0.899 W/kg

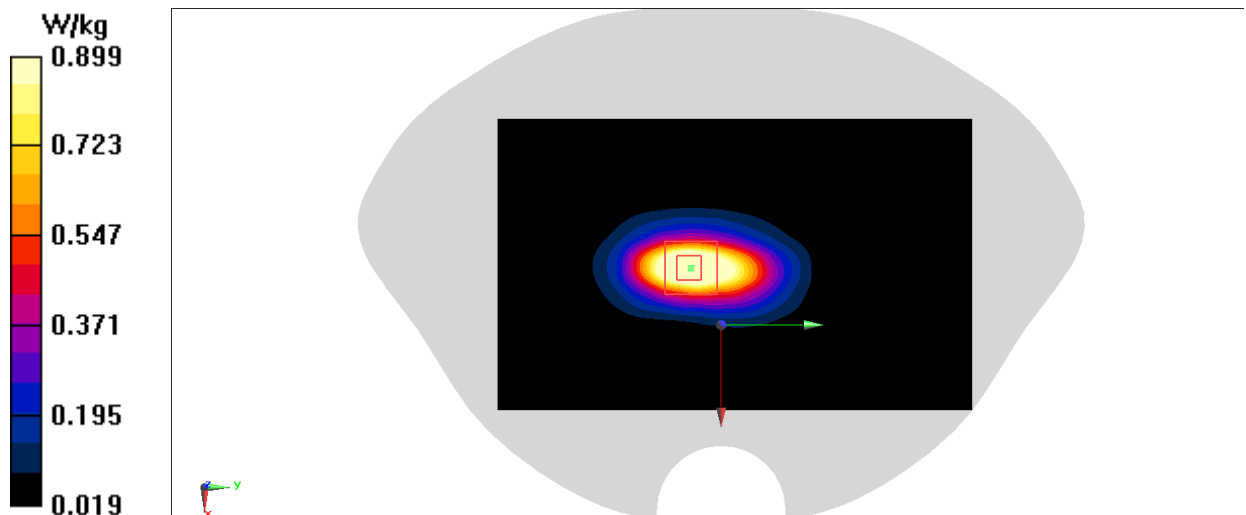

Fig. A-28

LTE Band66 Body

Date/Time: 5/26/2021

Electronics: DAE4 Sn1588

Medium: H700-6000

Medium parameters used: $f = 1770 \text{ MHz}$; $\sigma = 1.42 \text{ S/m}$; $\epsilon_r = 40.91$; $\rho = 1000 \text{ kg/m}^3$

Ambient Temperature: 23°C Liquid Temperature: 22.5°C

Communication System: UID 0, LTE Band66 (0) Frequency: 1770 MHz Duty Cycle: 1:1

Probe: EX3DV4 - SN7464 ConvF(8.6, 8.6, 8.6) @ 1770 MHz

Area Scan (81x131x1): Interpolated grid: $dx=1.500 \text{ mm}$, $dy=1.500 \text{ mm}$

Maximum value of SAR (interpolated) = 0.547 W/kg

Zoom Scan (5x5x7)/Cube 0: Measurement grid: $dx=8\text{mm}$, $dy=8\text{mm}$, $dz=5\text{mm}$

Reference Value = 6.431 V/m ; Power Drift = 0.03 dB

Peak SAR (extrapolated) = 0.657 W/kg

SAR(1 g) = 0.397 W/kg ; SAR(10 g) = 0.229 W/kg

Maximum value of SAR (measured) = 0.563 W/kg

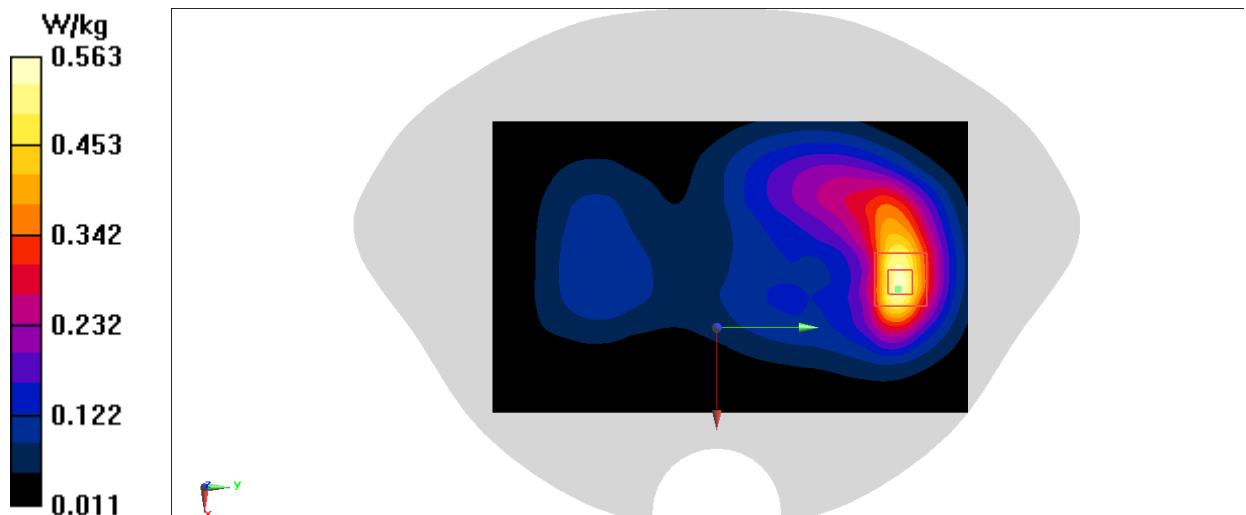

Fig. A-29

LTE Band71 Head

Date/Time: 5/21/2021

Electronics: DAE4 Sn1588

Medium: H700-6000

Medium parameters used (extrapolated): $f = 683 \text{ MHz}$; $\sigma = 0.831 \text{ S/m}$; $\epsilon_r = 44.664$; $\rho = 1000 \text{ kg/m}^3$

Ambient Temperature: 23.3°C Liquid Temperature: 22.8°C

Communication System: UID 0, LTE Band71 (0) Frequency: 683 MHz Duty Cycle: 1:1

Probe: EX3DV4 - SN7464 ConvF(10.43, 10.43, 10.43) @ 683 MHz

Area Scan (81x131x1): Interpolated grid: $dx=1.500 \text{ mm}$, $dy=1.500 \text{ mm}$

Maximum value of SAR (interpolated) = 0.354 W/kg

Zoom Scan (6x6x7)/Cube 0: Measurement grid: $dx=8\text{mm}$, $dy=8\text{mm}$, $dz=5\text{mm}$

Reference Value = 6.769 V/m; Power Drift = 0.06 dB

Peak SAR (extrapolated) = 0.398 W/kg

SAR(1 g) = 0.310 W/kg; SAR(10 g) = 0.248 W/kg

Maximum value of SAR (measured) = 0.365 W/kg

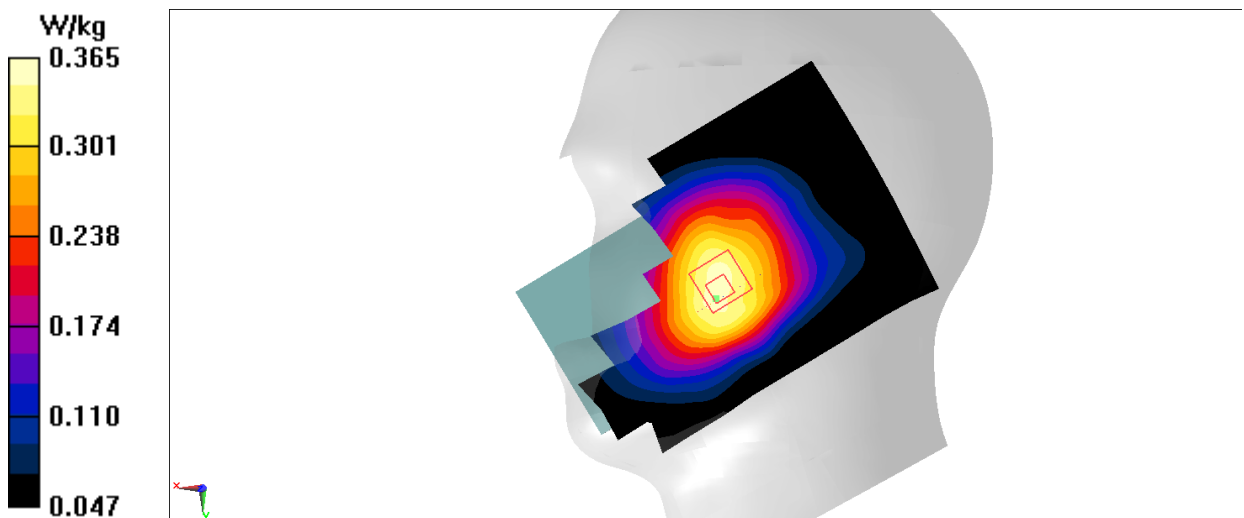

Fig. A-30

LTE Band71 Body

Date/Time: 5/21/2021

Electronics: DAE4 Sn1588

Medium: H700-6000

Medium parameters used (extrapolated): $f = 683 \text{ MHz}$; $\sigma = 0.831 \text{ S/m}$; $\epsilon_r = 44.664$; $\rho = 1000 \text{ kg/m}^3$

Ambient Temperature: 23.3°C Liquid Temperature: 22.8°C

Communication System: UID 0, LTE Band71 (0) Frequency: 683 MHz Duty Cycle: 1:1

Probe: EX3DV4 - SN7464 ConvF(10.43, 10.43, 10.43) @ 683 MHz

Area Scan (81x131x1): Interpolated grid: $dx=1.500 \text{ mm}$, $dy=1.500 \text{ mm}$

Maximum value of SAR (interpolated) = 0.474 W/kg

Zoom Scan (6x9x7)/Cube 0: Measurement grid: $dx=8\text{mm}$, $dy=8\text{mm}$, $dz=5\text{mm}$

Reference Value = 21.90 V/m; Power Drift = -0.02 dB

Peak SAR (extrapolated) = 0.549 W/kg

SAR(1 g) = 0.380 W/kg; SAR(10 g) = 0.298 W/kg

Maximum value of SAR (measured) = 0.467 W/kg

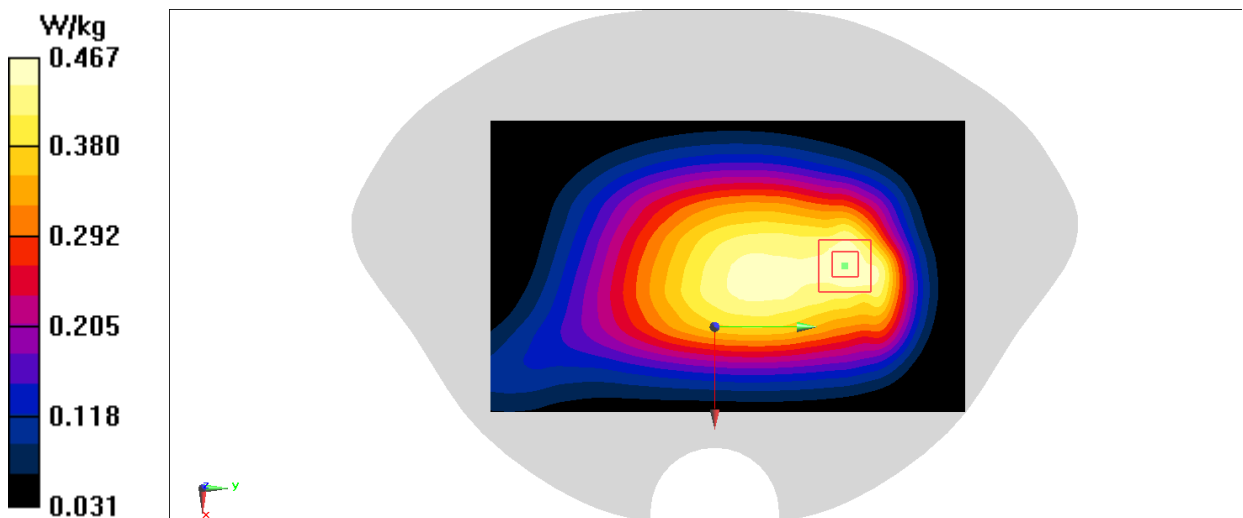

Fig. A-31

WiFi2.4G Head

Date/Time: 5/25/2021

Electronics: DAE4 Sn1588

Medium: H700-6000

Medium parameters used (interpolated): $f = 2437$ MHz; $\sigma = 1.911$ S/m; $\epsilon_r = 39.832$; $\rho = 1000$ kg/m³

Ambient Temperature: 23.5°C Liquid Temperature: 21.9°C

Communication System: UID 0, Wlan 2450 (0) Frequency: 2437 MHz Duty Cycle: 1:1

Probe: EX3DV4 - SN7464 ConvF(7.75, 7.75, 7.75) @ 2437 MHz

Area Scan (101x161x1): Interpolated grid: dx=1.200 mm, dy=1.200 mm

Maximum value of SAR (interpolated) = 1.07 W/kg

Zoom Scan (7x8x7)/Cube 0: Measurement grid: dx=5mm, dy=5mm, dz=5mm

Reference Value = 11.28 V/m; Power Drift = -0.11 dB

Peak SAR (extrapolated) = 1.30 W/kg

SAR(1 g) = 0.670 W/kg; SAR(10 g) = 0.337 W/kg

Maximum value of SAR (measured) = 1.02 W/kg

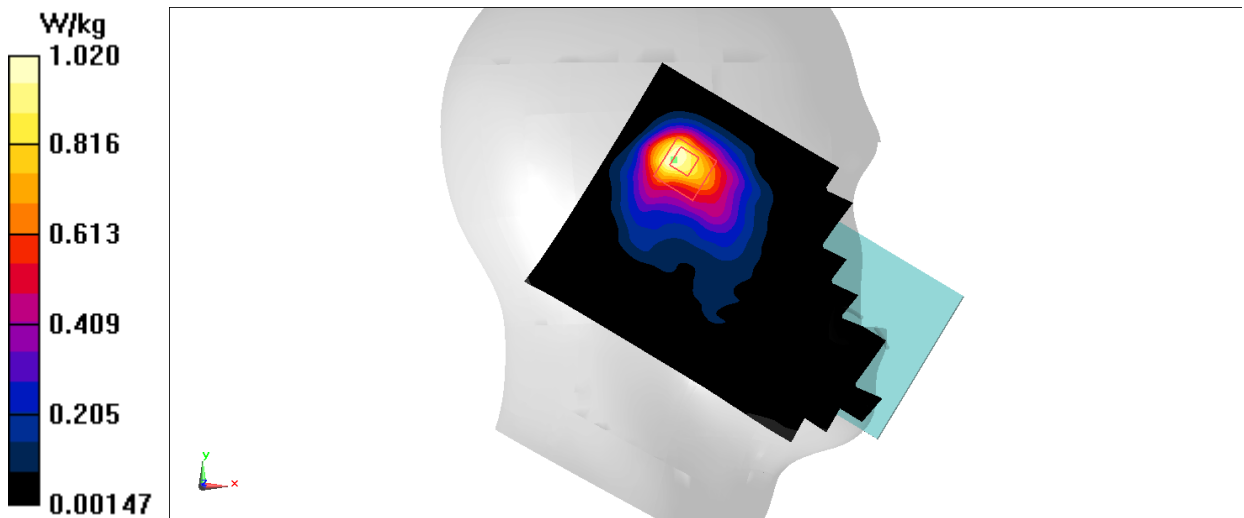

Fig. A-32

WiFi2.4G Body

Date/Time: 5/26/2021

Electronics: DAE4 Sn1588

Medium: H700-6000

Medium parameters used (interpolated): $f = 2437$ MHz; $\sigma = 1.911$ S/m; $\epsilon_r = 39.832$; $\rho = 1000$ kg/m³

Ambient Temperature: 23°C Liquid Temperature: 22.5°C

Communication System: UID 0, WLan 2450 (0) Frequency: 2437 MHz Duty Cycle: 1:1

Probe: EX3DV4 - SN7464 ConvF(7.75, 7.75, 7.75) @ 2437 MHz

Area Scan (101x161x1): Interpolated grid: dx=1.200 mm, dy=1.200 mm

Maximum value of SAR (interpolated) = 0.784 W/kg

Zoom Scan (7x8x7)/Cube 0: Measurement grid: dx=5mm, dy=5mm, dz=5mm

Reference Value = 7.919 V/m; Power Drift = -0.15 dB

Peak SAR (extrapolated) = 1.02 W/kg

SAR(1 g) = 0.485 W/kg; SAR(10 g) = 0.243 W/kg

Maximum value of SAR (measured) = 0.803 W/kg

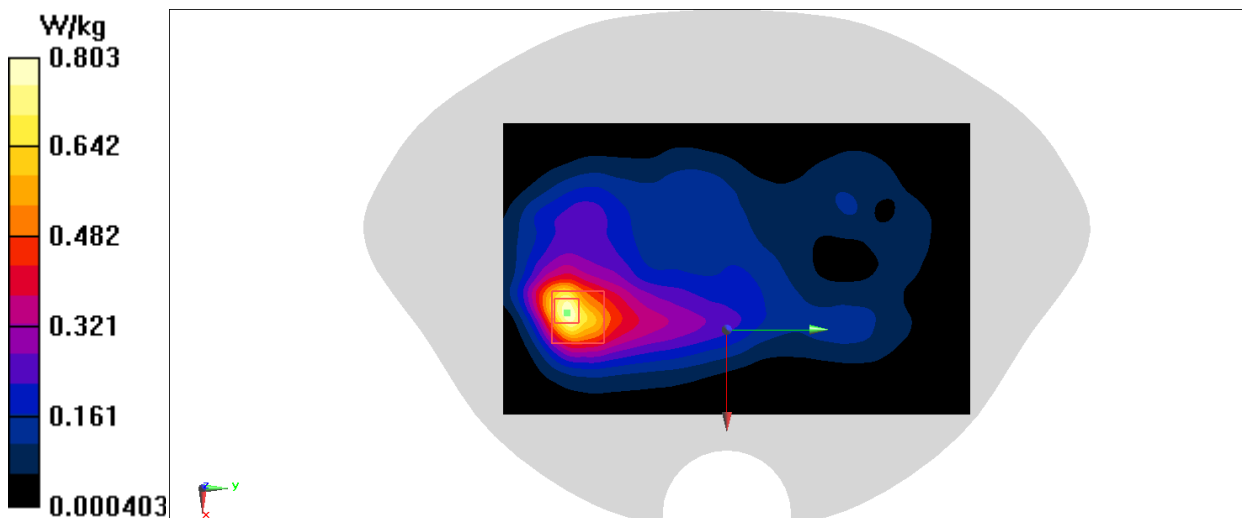

Fig. A-33

WiFi2.4G Body

Date/Time: 6/7/2021

Electronics: DAE4 Sn1588

Medium: H700-6000

Medium parameters used (interpolated): $f = 2437$ MHz; $\sigma = 1.898$ S/m; $\epsilon_r = 40.206$; $\rho = 1000$ kg/m³

Ambient Temperature: 23.1°C Liquid Temperature: 22.4°C

Communication System: UID 0, WLan 2450 (0) Frequency: 2437 MHz Duty Cycle: 1:1

Probe: EX3DV4 - SN7464 ConvF(7.75, 7.75, 7.75) @ 2437 MHz

Area Scan (101x161x1): Interpolated grid: dx=1.200 mm, dy=1.200 mm

Maximum value of SAR (interpolated) = 0.956 W/kg

Zoom Scan (7x7x7)/Cube 0: Measurement grid: dx=5mm, dy=5mm, dz=5mm

Reference Value = 6.672 V/m; Power Drift = 0.02 dB

Peak SAR (extrapolated) = 1.18 W/kg

SAR(1 g) = 0.575 W/kg; SAR(10 g) = 0.286 W/kg

Maximum value of SAR (measured) = 0.932 W/kg

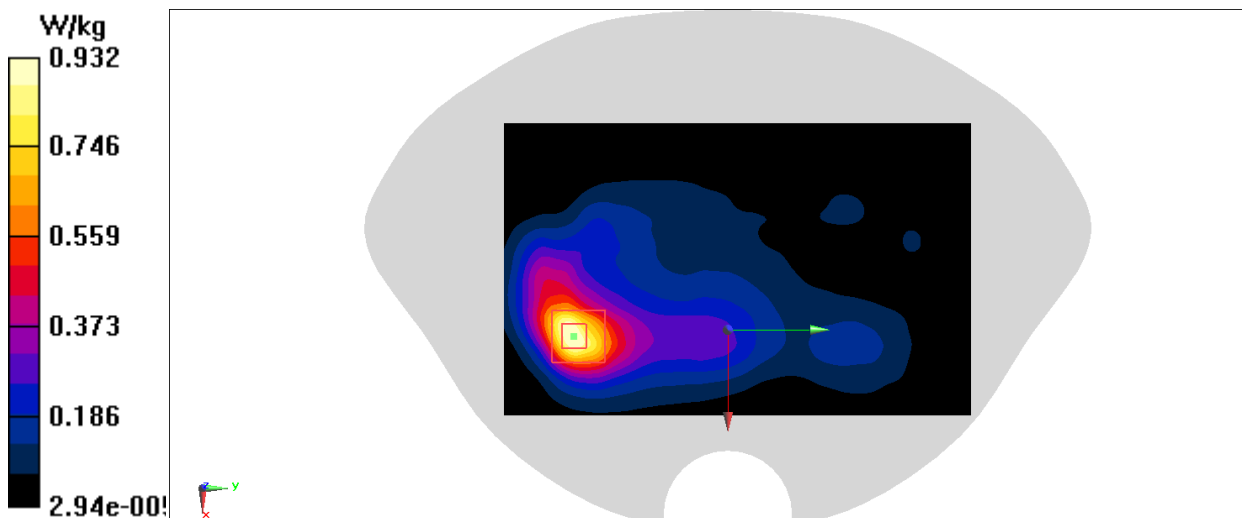

Fig. A-34

WiFi2.4G Body

Date/Time: 6/7/2021

Electronics: DAE4 Sn1588

Medium: H700-6000

Medium parameters used (interpolated): $f = 2437$ MHz; $\sigma = 1.898$ S/m; $\epsilon_r = 40.206$; $\rho = 1000$ kg/m³

Ambient Temperature: 23.1°C Liquid Temperature: 22.4°C

Communication System: UID 0, WLan 2450 (0) Frequency: 2437 MHz Duty Cycle: 1:1

Probe: EX3DV4 - SN7464 ConvF(7.75, 7.75, 7.75) @ 2437 MHz

Area Scan (101x161x1): Interpolated grid: dx=1.200 mm, dy=1.200 mm

Maximum value of SAR (interpolated) = 0.555 W/kg

Zoom Scan (7x8x7)/Cube 0: Measurement grid: dx=5mm, dy=5mm, dz=5mm

Reference Value = 5.468 V/m; Power Drift = -0.17 dB

Peak SAR (extrapolated) = 0.691 W/kg

SAR(1 g) = 0.329 W/kg; SAR(10 g) = 0.164 W/kg

Maximum value of SAR (measured) = 0.538 W/kg

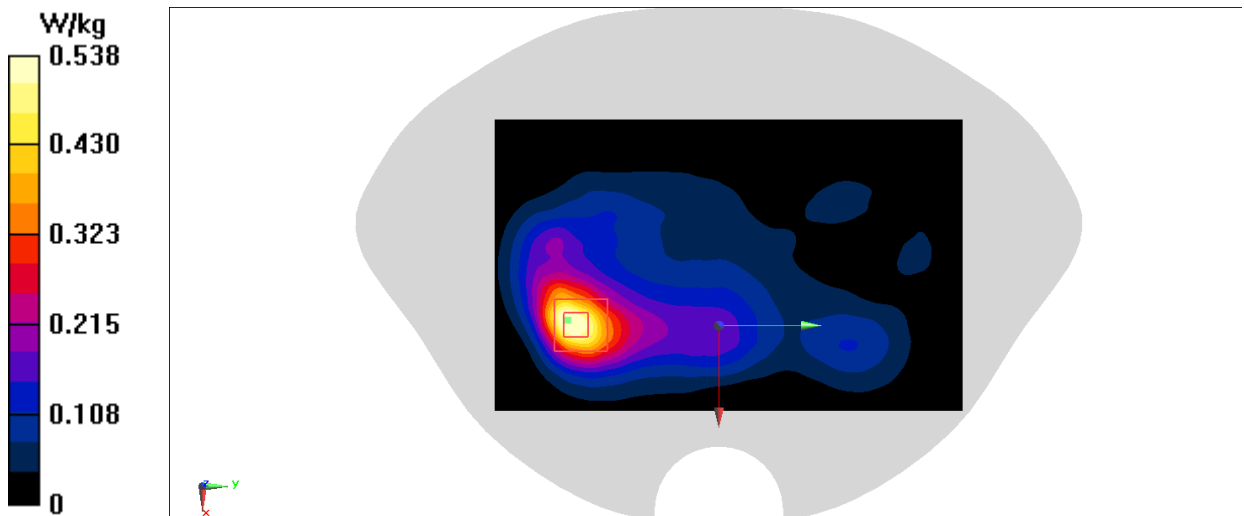

Fig. A-35

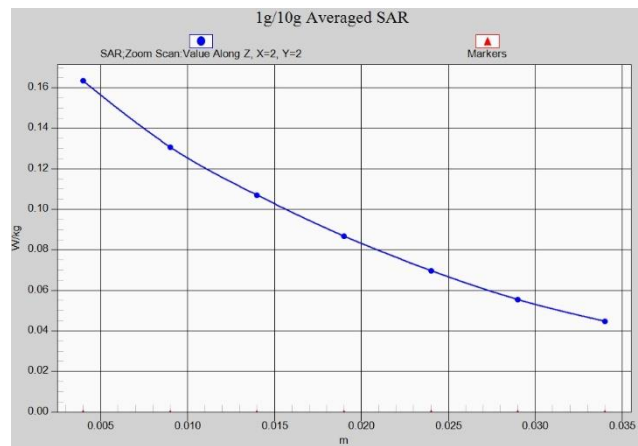

Fig. A-1 Z-Scan at power reference point (GSM850)

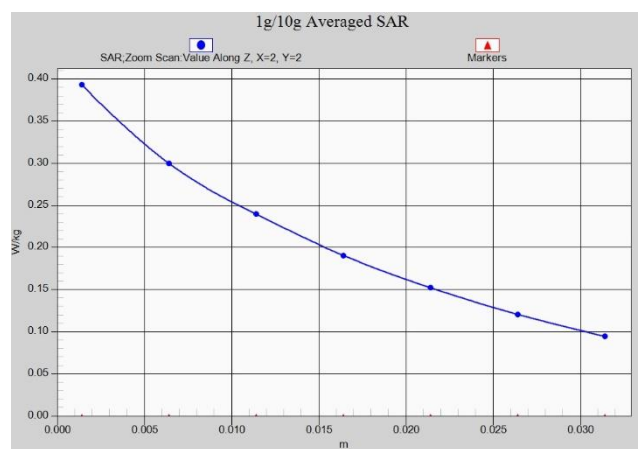

Fig. A-2 Z-Scan at power reference point (GSM850)

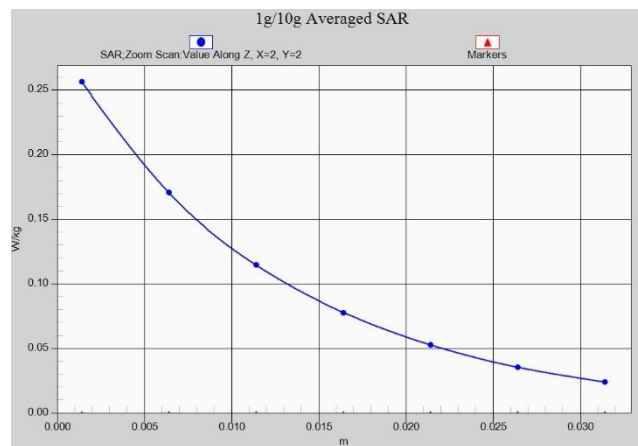

Fig. A-3 Z-Scan at power reference point (GSM1900)

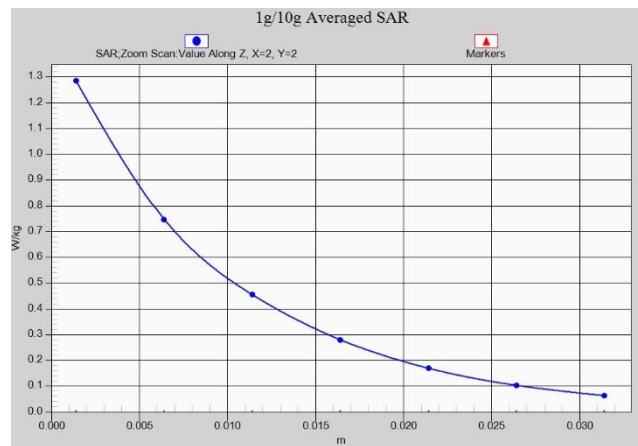

Fig. A-4 Z-Scan at power reference point (GSM1900)

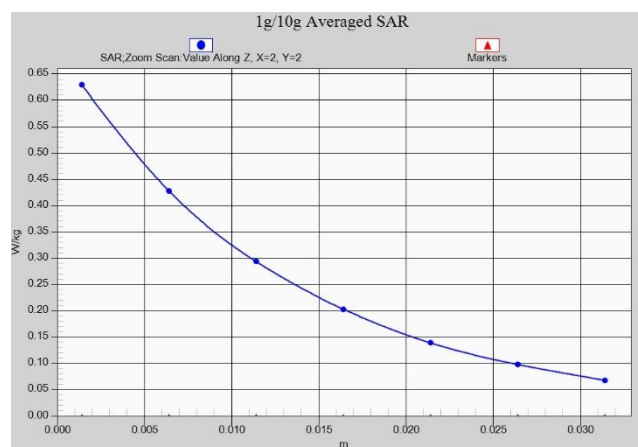

Fig. A-5 Z-Scan at power reference point (WCDMA1900)

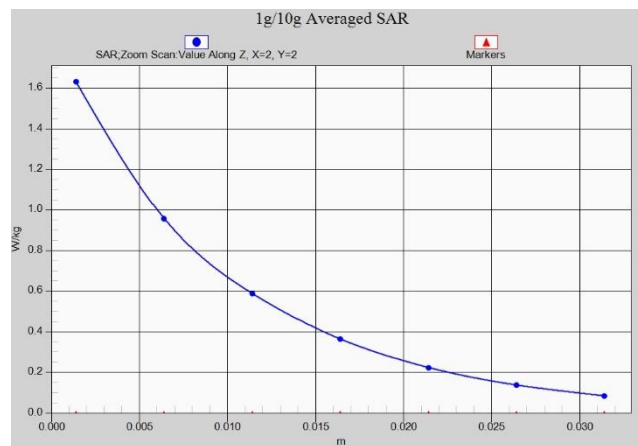

Fig. A-6 Z-Scan at power reference point (WCDMA1900)

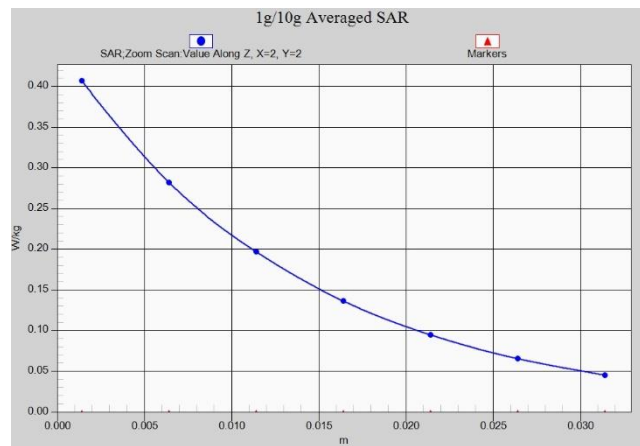

Fig. A-7 Z-Scan at power reference point (WCDMA1700)

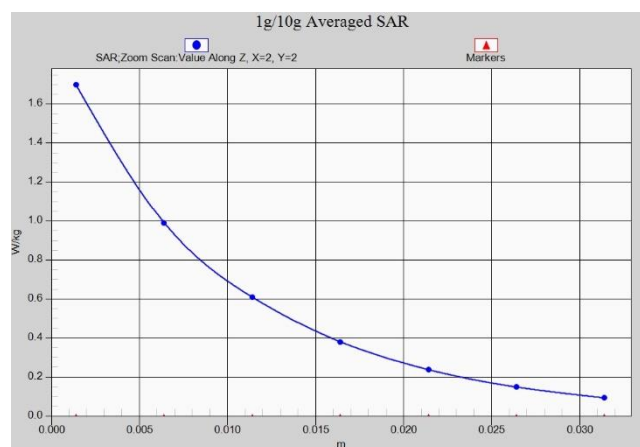

Fig. A-8 Z-Scan at power reference point (WCDMA1700)

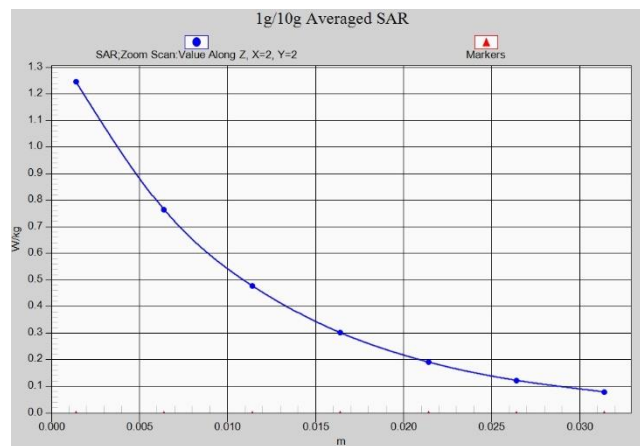

Fig. A-9 Z-Scan at power reference point (WCDMA1700)

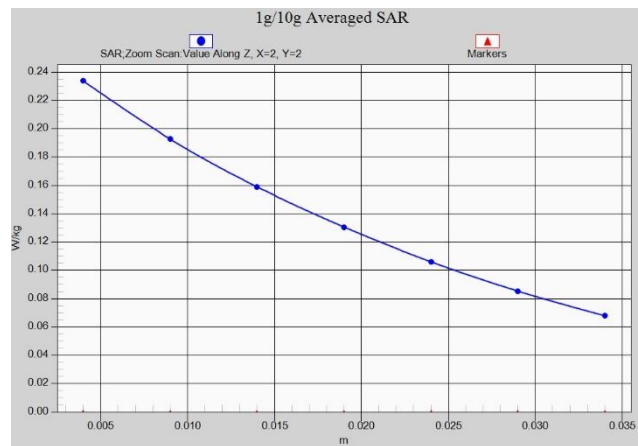

Fig. A-10 Z-Scan at power reference point (WCDMA850)

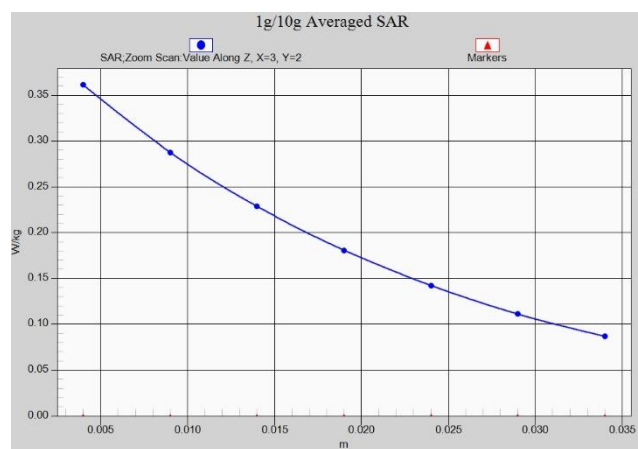

Fig. A-11 Z-Scan at power reference point (WCDMA850)

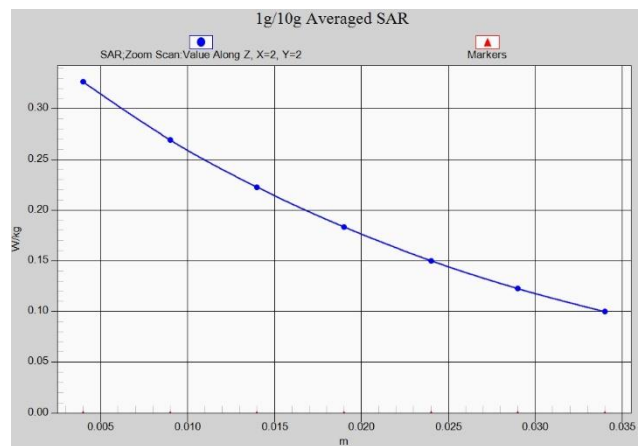

Fig. A-12 Z-Scan at power reference point (LTE Band12)

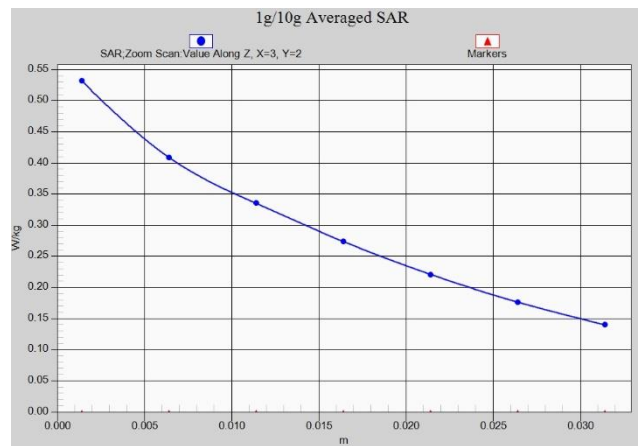

Fig. A-13 Z-Scan at power reference point (LTE Band 12)

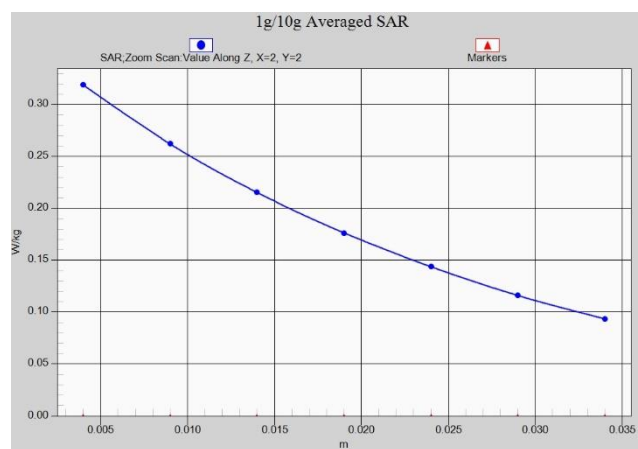

Fig. A-14 Z-Scan at power reference point (LTE Band 13)

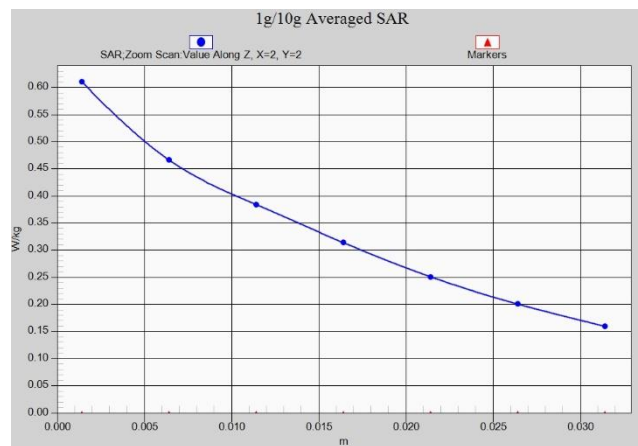

Fig. A-15 Z-Scan at power reference point (LTE Band 13)

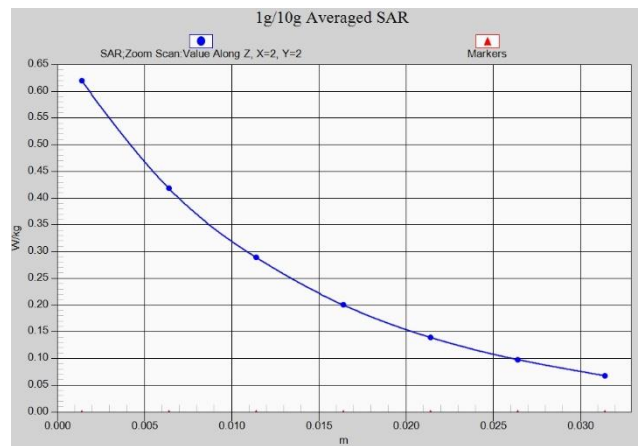

Fig. A-16 Z-Scan at power reference point (LTE Band25)

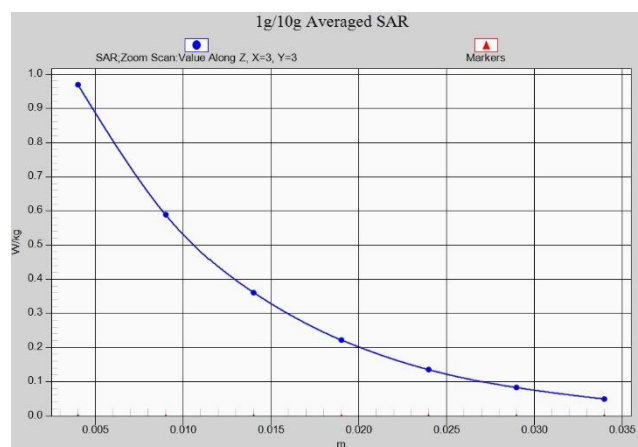

Fig. A-17 Z-Scan at power reference point (LTE Band25)

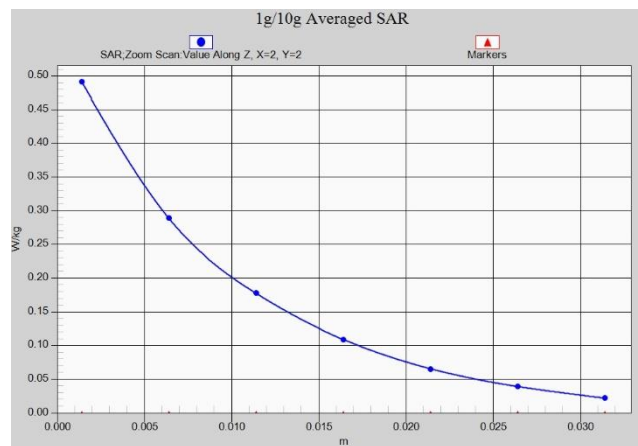

Fig. A-18 Z-Scan at power reference point (LTE Band25)

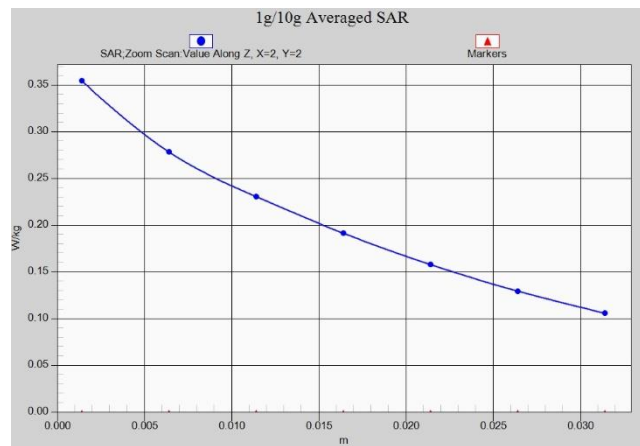

Fig. A-19 Z-Scan at power reference point (LTE Band26)

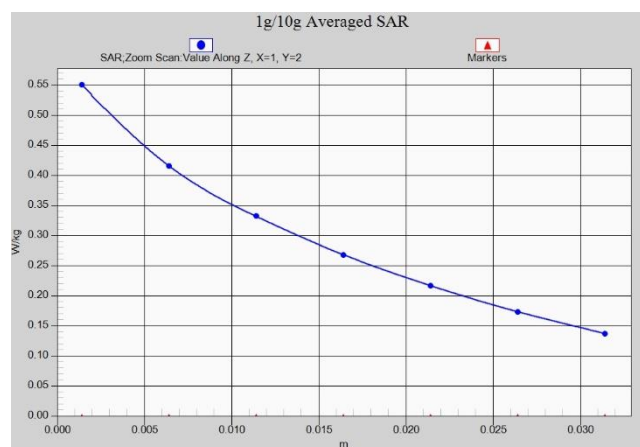

Fig. A-20 Z-Scan at power reference point (LTE Band26)

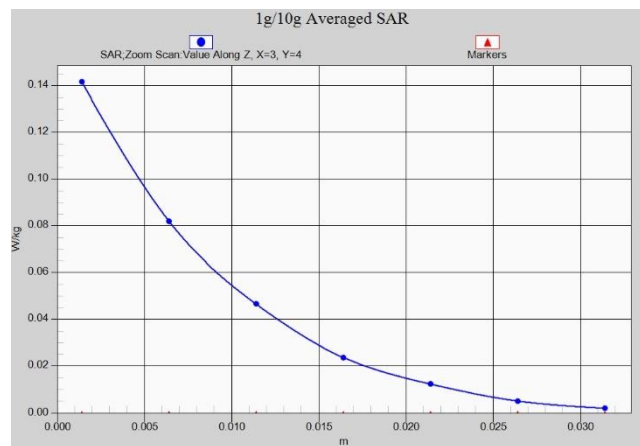

Fig. A-21 Z-Scan at power reference point (LTE Band41)

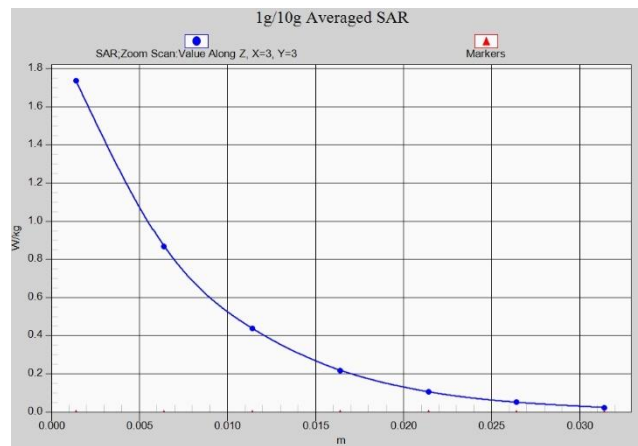

Fig. A-22 Z-Scan at power reference point (LTE Band41)

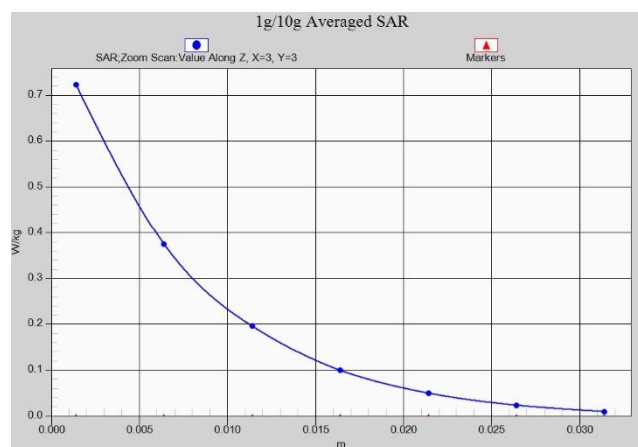

Fig. A-23 Z-Scan at power reference point (LTE Band41)

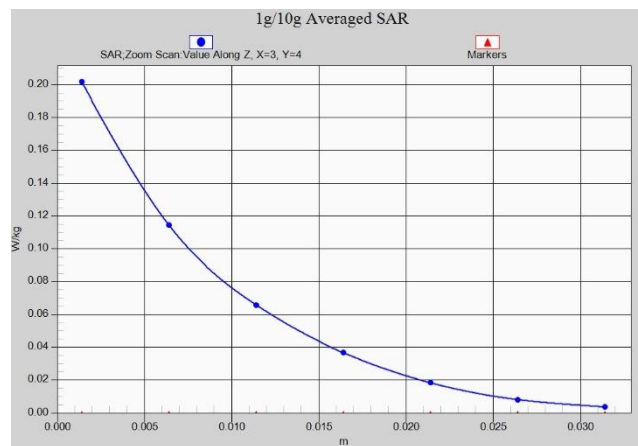

Fig. A-24 Z-Scan at power reference point (LTE Band41 HPUE)

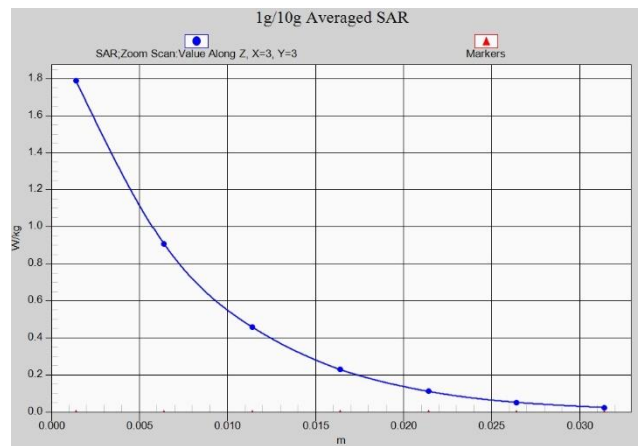

Fig. A-25 Z-Scan at power reference point (LTE Band41 HPUE)

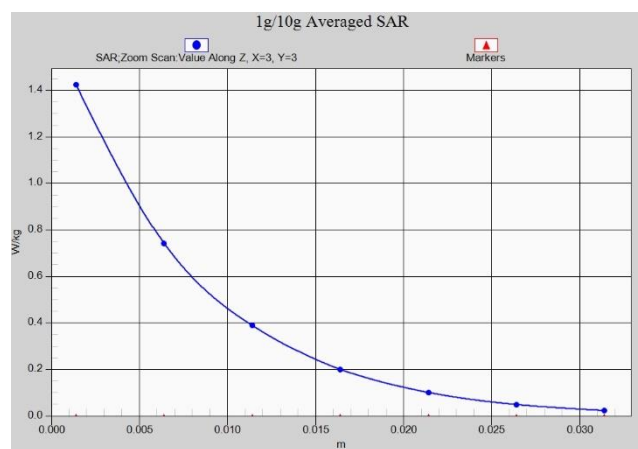

Fig. A-26 Z-Scan at power reference point (LTE Band41 HPUE)

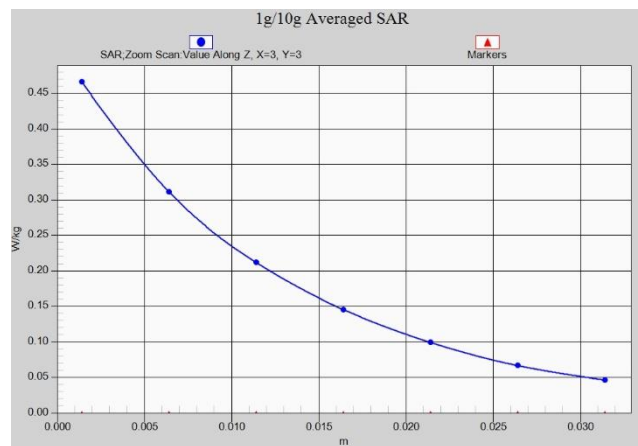

Fig. A-27 Z-Scan at power reference point (LTE Band66)