



# FCC PART 15C TEST REPORT

No. I22Z62030-IOT17

for

**BLU Products,Inc.**

**Smart phone**

**Model Name: B135DL**

**FCC ID: YHLBLUB135DL**

with

**Hardware Version: V1.0**

**Software Version: BLU\_B135DL\_V12.0.01.05.01.04**

**Issued Date: 2023-2-1**

**Note:**

The test results in this test report relate only to the devices specified in this report. This report shall not be reproduced except in full without the written approval of CTTL.

The report must not be used by the client to claim product certification, approval, or endorsement by NVLAP, NIST, or any agency of the U.S. Government.

**Test Laboratory:**

**CTTL, Telecommunication Technology Labs, CAICT**

No.52, HuayuanNorth Road, Haidian District, Beijing, P. R. China 100191.

Tel:+86(0)10-62304633-2512,Fax:+86(0)10-62304633-2504

Email:[cttl\\_terminals@caict.ac.cn](mailto:cttl_terminals@caict.ac.cn), website: [www.chinattl.com](http://www.chinattl.com)



## **REPORT HISTORY**

<b>Report Number</b>	<b>Revision</b>	<b>Description</b>	<b>Issue Date</b>
I22Z62030-IOT17	Rev.0	1st edition	2023-2-1

## **CONTENTS**

1.	Test Laboratory .....	5
1.1.	Introduction & Accreditation .....	5
1.2.	Testing Location .....	5
1.3.	Testing Environment .....	6
1.4.	Project data .....	6
1.5.	Signature .....	6
2.	Client Information .....	7
2.1.	Applicant Information .....	7
2.2.	Manufacturer Information .....	7
3.	Equipment Under Test (EUT) and Ancillary Equipment (AE) .....	8
3.1.	About EUT .....	8
3.2.	Internal Identification of EUT .....	8
3.3.	Internal Identification of AE .....	8
3.4.	Normal Accessory setting .....	9
3.5.	General Description .....	9
4.	Reference Documents .....	10
4.1.	Documents supplied by applicant .....	10
4.2.	Reference Documents for testing .....	10
5.	Test Results .....	11
5.1.	Summary of Test Results .....	11
5.2.	Statements .....	11
6.	Test Facilities Utilized .....	12
7.	Measurement Uncertainty .....	13
7.1.	Peak Output Power - Conducted .....	13
7.2.	Frequency Band Edges - Conducted .....	13
7.3.	Frequency Band Edges - Radiated .....	13
7.4.	Transmitter Spurious Emission - Conducted .....	13
7.5.	Transmitter Spurious Emission - Radiated .....	13
7.6.	Time of Occupancy (Dwell Time) .....	13
7.7.	20dB Bandwidth .....	14
7.8.	Carrier Frequency Separation .....	14
7.9.	AC Powerline Conducted Emission .....	14
	ANNEX A: EUT parameters .....	15
	ANNEX B: Detailed Test Results .....	16
	B.1. Measurement Method .....	16
	B.2. Peak Output Power .....	17
	B.3. Frequency Band Edges – Conducted .....	19
	B.4. Frequency Band Edges – Radiated .....	26
	B.5. Transmitter Spurious Emission - Conducted .....	31
	B.6. Transmitter Spurious Emission - Radiated .....	56
	B.7. Time of Occupancy (Dwell Time) .....	65
	B.8. 20dB Bandwidth .....	76



B.9. Carrier Frequency Separation.....	82
B.10. Number of Hopping Channels.....	85
B.11. AC Powerline Conducted Emission .....	89
ANNEX C: Accreditation Certificate .....	93



## **1. Test Laboratory**

### **1.1. Introduction & Accreditation**

**Telecommunication Technology Labs, CAICT** is an ISO/IEC 17025:2017 accredited test laboratory under NATIONAL VOLUNTARY LABORATORY ACCREDITATION PROGRAM (NVLAP) with lab code 600118-0, and is also an FCC accredited test laboratory (CN5017), and ISED accredited test laboratory (ISED#: 24849). The detail accreditation scope can be found on NVLAP website.

### **1.2. Testing Location**

Conducted testing Location: CTTL(huayuan North Road)

Address: No. 52, Huayuan North Road, Haidian District, Beijing,  
P. R. China 100191

Radiated testing Location: CTTL(BDA)

Address: No.18A, Kangding Street, Beijing Economic-Technology  
Development Area, Beijing, P. R. China 100176

### 1.3. Testing Environment

Normal Temperature: 20-27°C  
Relative Humidity: 20-50%

### 1.4. Project data

Testing Start Date: 2022-11-4  
Testing End Date: 2022-12-27

### 1.5. Signature



---

**Wu Le**  
**(Prepared this test report)**



---

**Sun Zhenyu**  
**(Reviewed this test report)**



---

**Hu Xiaoyu**  
**(Approved this test report)**



## **2. Client Information**

### **2.1. Applicant Information**

Company Name: BLU Products, Inc.  
Address /Post: 8600 NW 36th Street, Suite #200 Doral, FL 33166.  
City: /  
Postal Code: /  
Country: /  
Telephone: 305.715.7171  
Fax: 305.436.8819

### **2.2. Manufacturer Information**

Company Name: BLU Products, Inc.  
Address /Post: 8600 NW 36th Street, Suite #200 Doral, FL 33166.  
City: /  
Postal Code: /  
Country: /  
Telephone: 305.715.7171  
Fax: 305.436.8819

### 3. Equipment Under Test (EUT) and Ancillary Equipment (AE)

#### 3.1. About EUT

Description	Smart phone
Model Name	B135DL
FCC ID	YHLBLUB135DL
Frequency Band	ISM 2400MHz~2483.5MHz
Type of Modulation	GFSK/ $\pi$ /4 DQPSK/8DPSK
Number of Channels	79
Power Supply	3.85V DC by Battery
Antenna gain	-0.84dBi

#### 3.2. Internal Identification of EUT

EUT ID*	SN or IMEI	HW Version	SW Version	Date of receipt
EUT1	356074290014716	V1.0	BLU_B135DL_V12.0.01.05.0 1.04	2022-11-4
EUT2	356074290009005	V1.0	BLU_B135DL_V12.0.01.05.0 1.04	2022-11-4

\*EUT ID: is used to identify the test sample in the lab internally.

#### 3.3. Internal Identification of AE

AE ID*	Description		
AE1	Battery	/	/
AE2	Battery	/	/
AE3	Charger	/	/
AE4	Charger	/	/
AE5	USB Cable	/	/
AE6	USB Cable	/	/

##### AE1

Model	TN-BP4000N3
Manufacturer	Guangdong Fenghua New Energy Co.,Ltd.
Capacity	4000mAh
Nominal Voltage	3.85V

##### AE2

Model	TN-BP4000N3
Manufacturer	Dongguan Ganfeng Electronics Co., Ltd
Capacity	4000mAh
Nominal Voltage	3.85V

##### AE3





Model	TN-050200U3
Manufacturer	Dong Guan City GangQi Electronic Co.,Ltd.
Length of cable	/
AE4	
Model	TN-050200U3
Manufacturer	Guangdong Beicom Electronics Co.,Ltd.
Length of cable	/
AE5	
Model	336275
Manufacturer	SUNTOPS ELECTRONICS CO.,LTD
Length of cable	/
AE6	
Model	T365-011B-1
Manufacturer	Shenzhen Yihuaxing Electronics Co. Ltd.
Length of cable	/

\*AE ID: is used to identify the test sample in the lab internally.

### 3.4. Normal Accessory setting

Fully charged battery should be used during the test.

### 3.5. General Description

The Equipment Under Test (EUT) is a model of Smart phone with integrated antenna. It consists of normal options: lithium battery, charger. Manual and specifications of the EUT were provided to fulfill the test. Samples undergoing test were selected by the Client.

## 4. Reference Documents

### 4.1. Documents supplied by applicant

EUT parameters, referring to Annex A for detailed information, is supplied by the client or manufacturer, which is the basis of testing.

### 4.2. Reference Documents for testing

The following documents listed in this section are referred for testing.

Reference	Title	Version
FCC Part15	FCC CFR 47, Part 15, Subpart C: 15.205 Restricted bands of operation; 15.209 Radiated emission limits, general requirements; 15.247 Operation within the bands 902–928MHz, 2400–2483.5 MHz, and 5725–5850 MHz.	2019
ANSI C63.10	American National Standard of Procedures for Compliance Testing of Unlicensed Wireless Devices	June,2013

## 5. Test Results

### 5.1. Summary of Test Results

Abbreviations used in this clause:

**P** Pass, The EUT complies with the essential requirements in the standard.

**F** Fail, The EUT does not comply with the essential requirements in the standard

**NA** Not Applicable, The test was not applicable

**NP** Not Performed, The test was not performed by CTTL

<b>SUMMARY OF MEASUREMENT RESULTS</b>	<b>Sub-clause</b>	<b>Verdict</b>
Peak Output Power	15.247 (b)(1)	<b>P</b>
Frequency Band Edges- Conducted	15.247 (d)	<b>P</b>
Frequency Band Edges- Radiated	15.247, 15.205, 15.209	<b>P</b>
Transmitter Spurious Emission - Conducted	15.247 (d)	<b>P</b>
Transmitter Spurious Emission - Radiated	15.247, 15.205, 15.209	<b>P</b>
Time of Occupancy (Dwell Time)	15.247 (a) (1)(iii)	<b>P</b>
20dB Bandwidth	15.247 (a)(1)	<b>NA</b>
Carrier Frequency Separation	15.247 (a)(1)	<b>P</b>
Number of hopping channels	15.247 (a)(iii)	<b>P</b>
AC Powerline Conducted Emission	15.107, 15.207	<b>P</b>

Please refer to **ANNEX A** for detail.

The measurement is made according to ANSI C63.10.

### 5.2. Statements

CTTL has evaluated the test cases requested by the applicant /manufacturer as listed in section 5.1 of this report for the EUT specified in section 3 according to the standards or reference documents listed in section 4.2

## 6. Test Facilities Utilized

### Conducted test system

No.	Equipment	Model	Serial Number	Manufacturer	Calibration Period	Calibration Due date
1	Vector Signal Analyzer	FSQ26	100024	R&S	1 year	2023-03-23
2	Bluetooth Tester	CBT	100315	R&S	1 year	2023-01-22
3	Test Receiver	ESCI	100344	R&S	1 year	2023-03-21
4	LISN	ENV216	101200	R&S	1 year	2023-06-29
5	Shielding Room	S81	/	ETS-Lindgren	/	/

### Radiated emission test system

No.	Equipment	Model	Serial Number	Manufacturer	Calibration Period	Calibration Due date
1	Test Receiver	ESU26	100376	R&S	1 year	2023-09-22
2	EMI Antenna	3115	00146404	ETS-Lindgren	1 year	2023-03-08
3	EMI Antenna	3117	00119024	ETS-Lindgren	1 year	2023-06-07
4	Universal Communication Tester	CMW500	159408	R&S	1 year	2023-03-01

## 7. Measurement Uncertainty

### 7.1. Peak Output Power - Conducted

Measurement Uncertainty:

Measurement Uncertainty (k=2)	0.66dB
-------------------------------	--------

### 7.2. Frequency Band Edges - Conducted

Measurement Uncertainty:

Measurement Uncertainty (k=2)	0.66dB
-------------------------------	--------

### 7.3. Frequency Band Edges - Radiated

Measurement Uncertainty:

Measurement Uncertainty (k=2)	/
-------------------------------	---

### 7.4. Transmitter Spurious Emission - Conducted

Measurement Uncertainty:

Frequency Range	Uncertainty (k=2)
30 MHz ~ 8 GHz	1.22dB
8 GHz ~ 12.75 GHz	1.51dB
12.7GHz ~ 26 GHz	1.51dB

### 7.5. Transmitter Spurious Emission - Radiated

Measurement Uncertainty:

Frequency Range	Uncertainty(dBm) (k=2)
9kHz-30MHz	/
$30\text{MHz} \leq f \leq 1\text{GHz}$	5.73
$1\text{GHz} \leq f \leq 18\text{GHz}$	5.58
$18\text{GHz} \leq f \leq 40\text{GHz}$	3.37

### 7.6. Time of Occupancy (Dwell Time)

Measurement Uncertainty:

Measurement Uncertainty (k=2)	0.88ms
-------------------------------	--------

### 7.7. 20dB Bandwidth

**Measurement Uncertainty:**

Measurement Uncertainty (k=2)	61.936Hz
-------------------------------	----------

### 7.8. Carrier Frequency Separation

**Measurement Uncertainty:**

Measurement Uncertainty (k=2)	61.936Hz
-------------------------------	----------

### 7.9. AC Powerline Conducted Emission

**Measurement Uncertainty:**

Measurement Uncertainty (k=2)	3.08dB
-------------------------------	--------



## **ANNEX A: EUT parameters**

Disclaimer: The antenna gain provided by the client may affect the validity of the measurement results in this report, and the client shall bear the impact and consequences arising therefrom.

## **ANNEX B: Detailed Test Results**

### **B.1. Measurement Method**

#### **B.1.1. Conducted Measurements**

The measurement is made according to ANSI C63.10.

- 1). Connect the EUT to the test system correctly.
- 2). Set the EUT to the required work mode (Transmitter, receiver or transmitter & receiver).
- 3). Set the EUT to the required channel.
- 4). Set the EUT hopping mode (hopping or hopping off).
- 5). Set the spectrum analyzer to start measurement.
- 6). Record the values. Vector Signal Analyzer

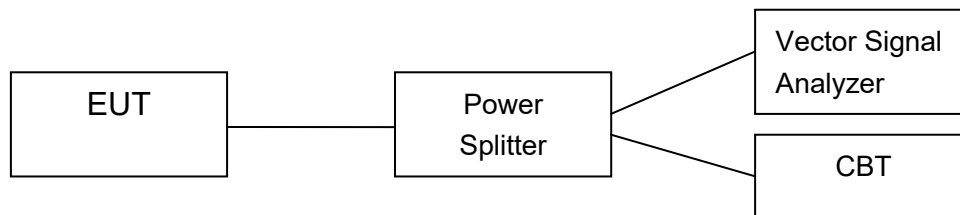

#### **B.1.2. Radiated Emission Measurements**

The measurement is made according to ANSI C63.10

The radiated emission test is performed in semi-anechoic chamber. The distance from the EUT to the reference point of measurement antenna is 3m. The test is carried out on both vertical and horizontal polarization and only maximization result of both polarizations is kept. During the test, the turntable is rotated 360° and the measurement antenna is moved from 1m to 4m to get the maximization result.

In the case of radiated emission, the used settings are as follows,

Sweep frequency from 30 MHz to 1GHz, RBW = 100 kHz, VBW = 300 kHz;

Sweep frequency from 1 GHz to 26GHz, RBW = 1MHz, VBW = 3MHz;

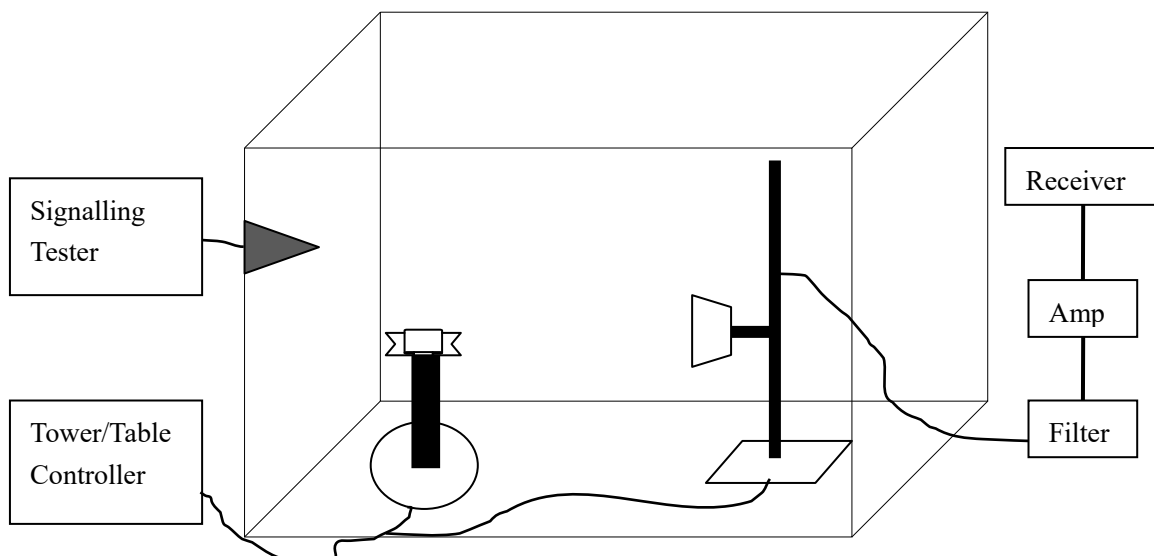



## B.2. Peak Output Power

### B.2.1. Peak Output Power – Conducted

**Method of Measurement: See ANSI C63.10-clause 7.8.5**

a) Use the following spectrum analyzer settings:

- Span: 6MHz
- RBW: 3MHz
- VBW: 3MHz
- Sweep time: 2.5ms
- Detector function: peak
- Trace: max hold

b) Allow trace to stabilize.

c) Use the marker-to-peak function to set the marker to the peak of the emission.

d) The indicated level is the peak output power.

#### Measurement Limit:

Standard	Limits	
	FCC Part 15.247 (b)(1)	Bandwidth $\leq$ 1MHz
Bandwidth $>$ 1MHz		21dBm (125mW)

#### Measurement Results:

##### For GFSK

Channel	Ch 0 2402 MHz	Ch 39 2441 MHz	Ch 78 2480 MHz	Conclusion
Peak Conducted Output Power (dBm)	10.08	10.10	10.11	P

##### For $\pi/4$ DQPSK

Channel	Ch 0 2402 MHz	Ch 39 2441 MHz	Ch 78 2480 MHz	Conclusion
Peak Conducted Output Power (dBm)	9.19	9.23	9.58	P

##### For 8DPSK

Channel	Ch 0 2402 MHz	Ch 39 2441 MHz	Ch 78 2480 MHz	Conclusion
Peak Conducted Output Power (dBm)	9.25	9.17	9.45	P

**Conclusion: PASS**

**B.2.2. E.I.R.P.**

The radiated E.I.R.P. is listed below:

Antenna gain = -0.84dBi

**For GFSK**

Channel	Ch 0 2402 MHz	Ch 39 2441 MHz	Ch 78 2480 MHz	Conclusion
E.I.R.P (dBm)	9.24	9.26	9.27	P

**For  $\pi/4$  DQPSK**

Channel	Ch 0 2402 MHz	Ch 39 2441 MHz	Ch 78 2480 MHz	Conclusion
E.I.R.P (dBm)	8.35	8.39	8.74	P

**For 8DPSK**

Channel	Ch 0 2402 MHz	Ch 39 2441 MHz	Ch 78 2480 MHz	Conclusion
E.I.R.P (dBm)	8.41	8.33	8.61	P

Note: E.I.R.P. are calculated with the antenna gain.

**Conclusion: PASS**

### B.3. Frequency Band Edges – Conducted

**Method of Measurement: See ANSI C63.10-clause 7.8.6**

Connect the spectrum analyzer to the EUT using an appropriate RF cable connected to the EUT output. Configure the spectrum analyzer settings as described below (be sure to enter all losses between the unlicensed wireless device output and the spectrum analyzer).

- Span: 10 MHz
- Resolution Bandwidth: 100 kHz
- Video Bandwidth: 300 kHz
- Sweep Time:Auto
- Detector: Peak
- Trace: max hold

Place a marker at the end of the restricted band closest to the transmit frequency to show compliance. Also measure any emissions in the restricted bands. Save the spectrum analyzer plot. Repeat for each power and modulation for lowest and highest channel.

Observe the stored trace and measure the amplitude delta between the peak of the fundamental and the peak of the band-edge emission. This is not an absolute field strength measurement; it is only a relative measurement to determine the amount by which the emission drops at the band edge relative to the highest fundamental emission level.

**Measurement Limit:**

Standard	Limit (dBc)
FCC 47 CFR Part 15.247 (d)	< -20

**Measurement Result:**

**For GFSK**

Channel	Hopping	Band Edge Power ( dBc)		Conclusion
0	Hopping OFF	Fig.1	-61.02	P
	Hopping ON	Fig.2	-63.49	P
78	Hopping OFF	Fig.3	-66.01	P
	Hopping ON	Fig.4	-66.67	P

**For  $\pi/4$  DQPSK**

Channel	Hopping	Band Edge Power ( dBc)		Conclusion
0	Hopping OFF	Fig.5	-62.14	P
	Hopping ON	Fig.6	-66.38	P
78	Hopping OFF	Fig.7	-66.35	P
	Hopping ON	Fig.8	-65.44	P

**For 8DPSK**

Channel	Hopping	Band Edge Power ( dBc)		Conclusion
0	Hopping OFF	Fig.9	-63.88	P
	Hopping ON	Fig.10	-67.13	P
78	Hopping OFF	Fig.11	-65.23	P

	Hopping ON	Fig.12	-66.01	P
--	------------	--------	--------	---

**Conclusion: PASS**

**Test graphs as below**

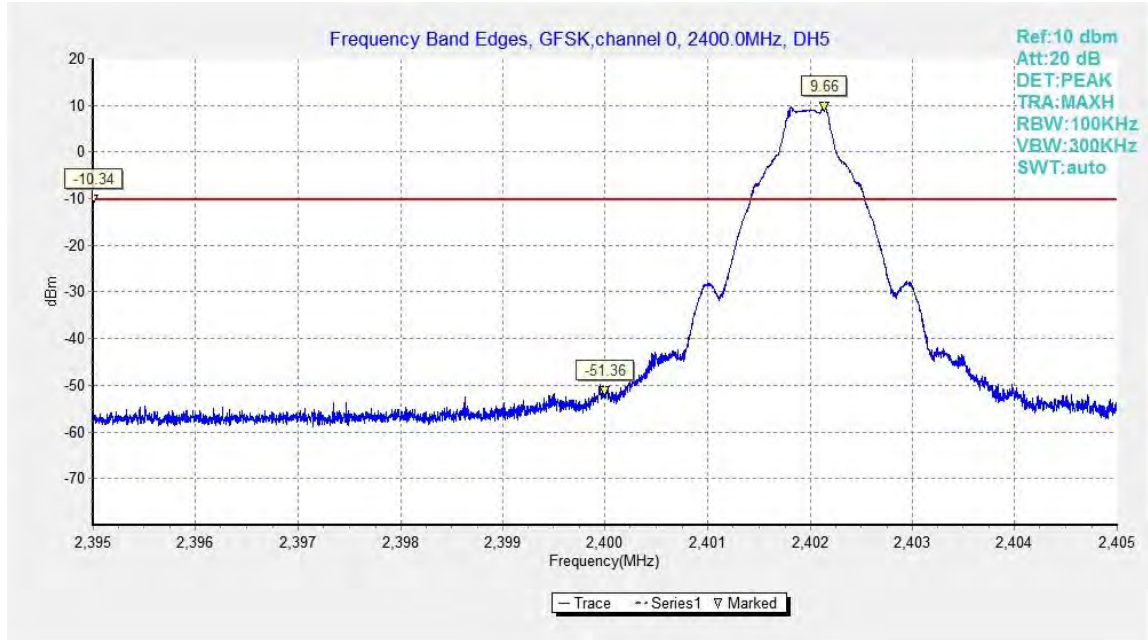

Fig.1. Frequency Band Edges: GFSK, Channel 0, Hopping Off

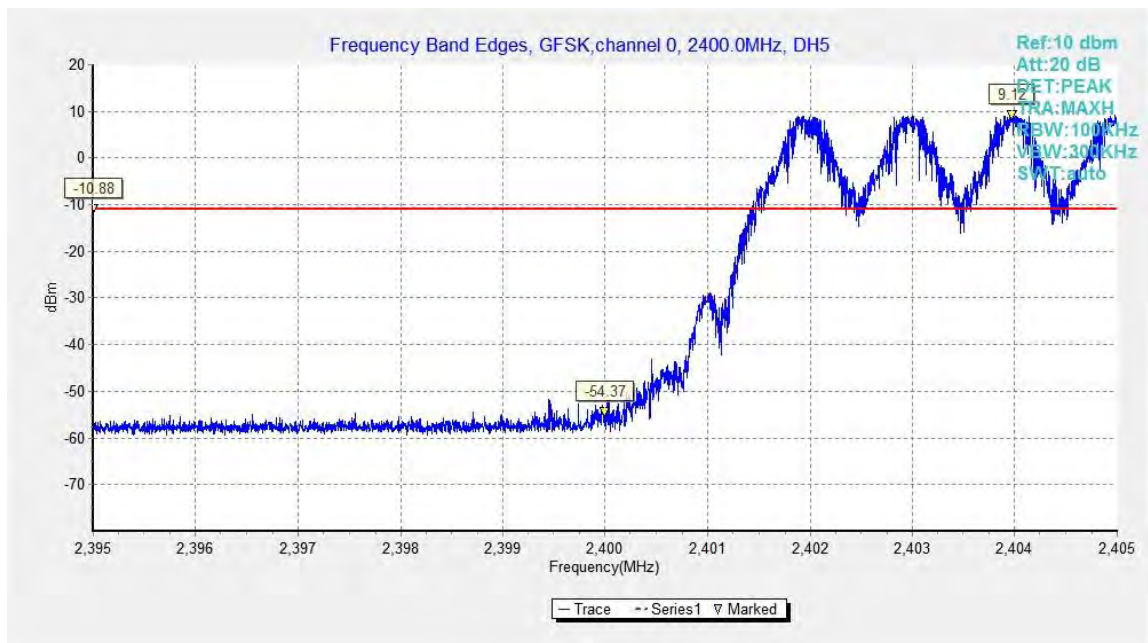

Fig.2. Frequency Band Edges: GFSK, Channel 0, Hopping On

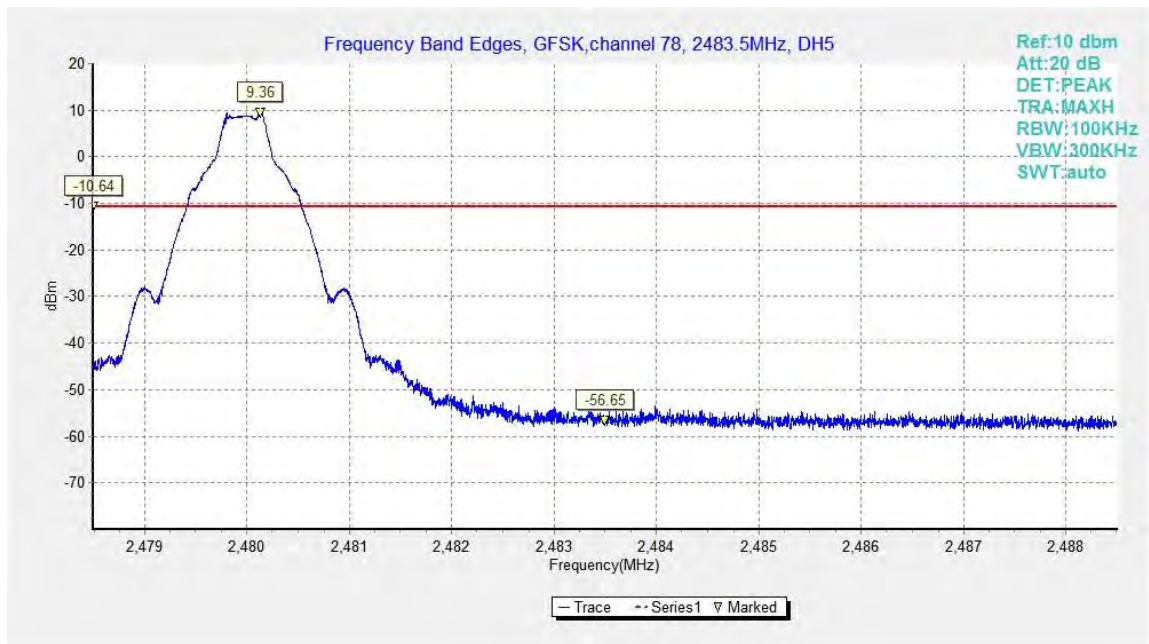

Fig.3. Frequency Band Edges: GFSK, Channel 78, Hopping Off

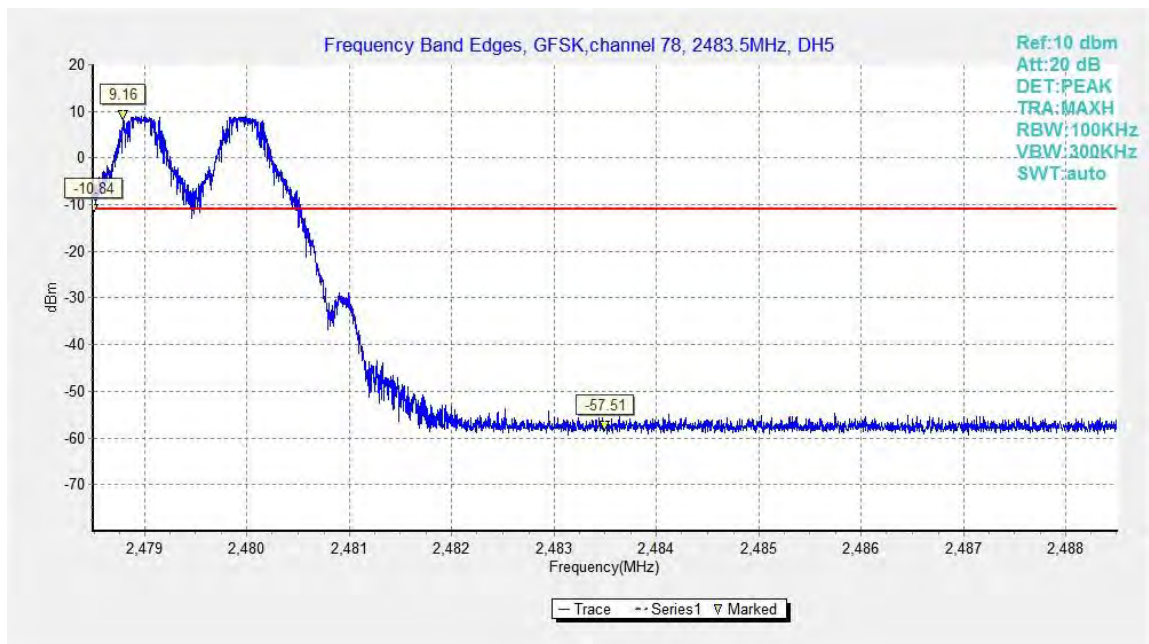

Fig.4. Frequency Band Edges: GFSK, Channel 78, Hopping On

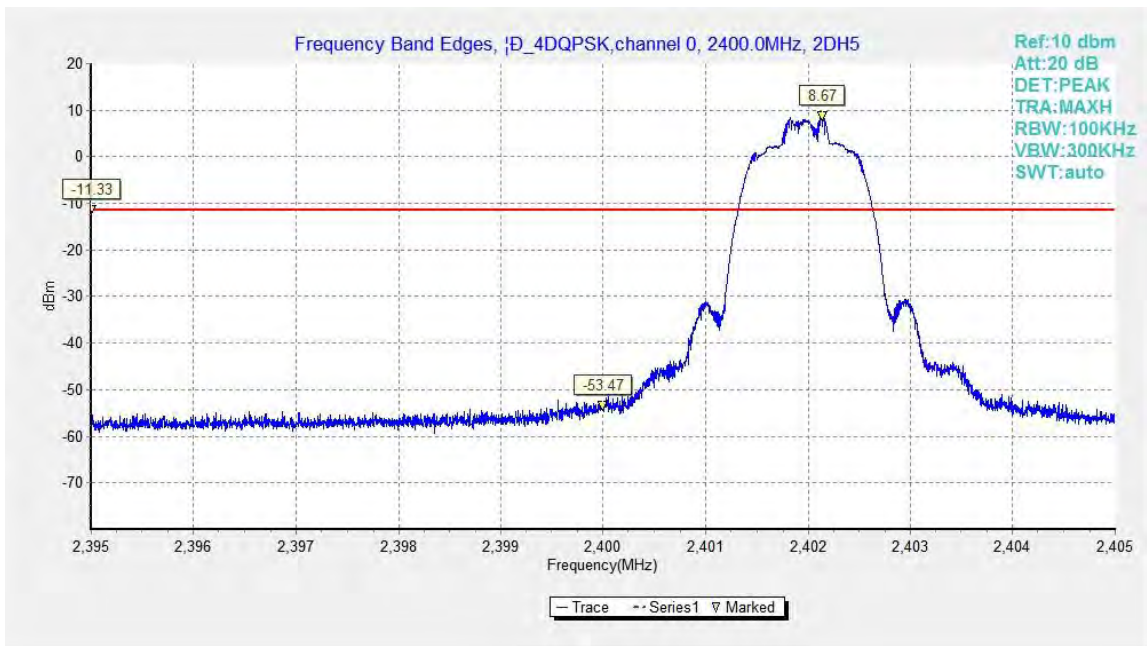

Fig.5. Frequency Band Edges:  $\pi/4$  DQPSK, Channel 0, Hopping Off

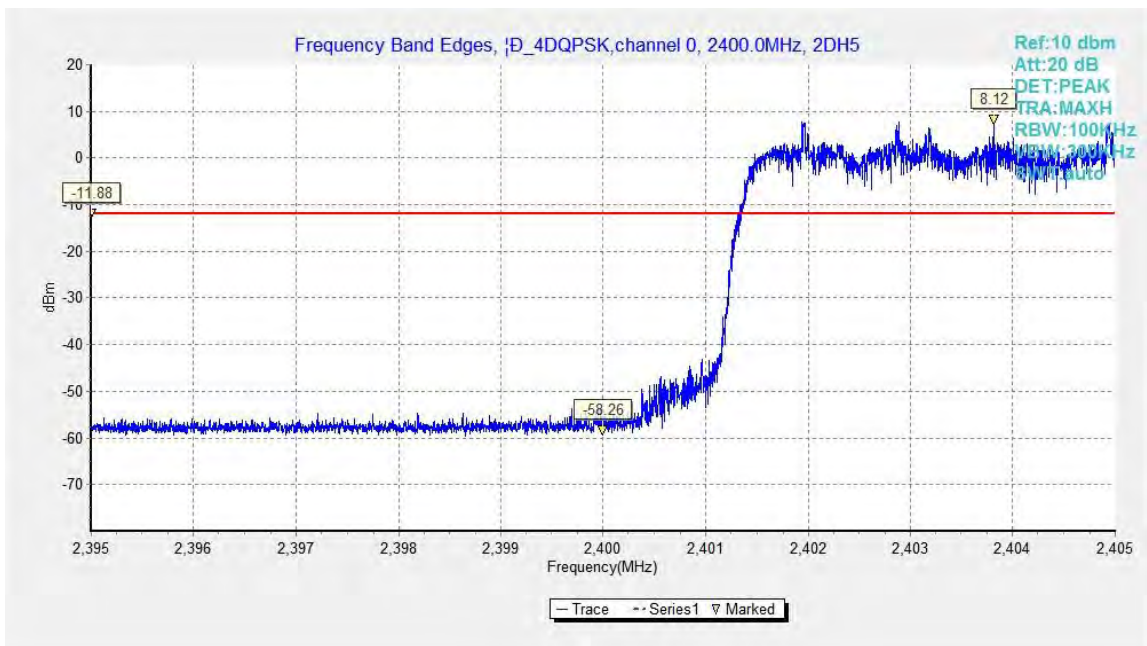

Fig.6. Frequency Band Edges:  $\pi/4$  DQPSK, Channel 0, Hopping On

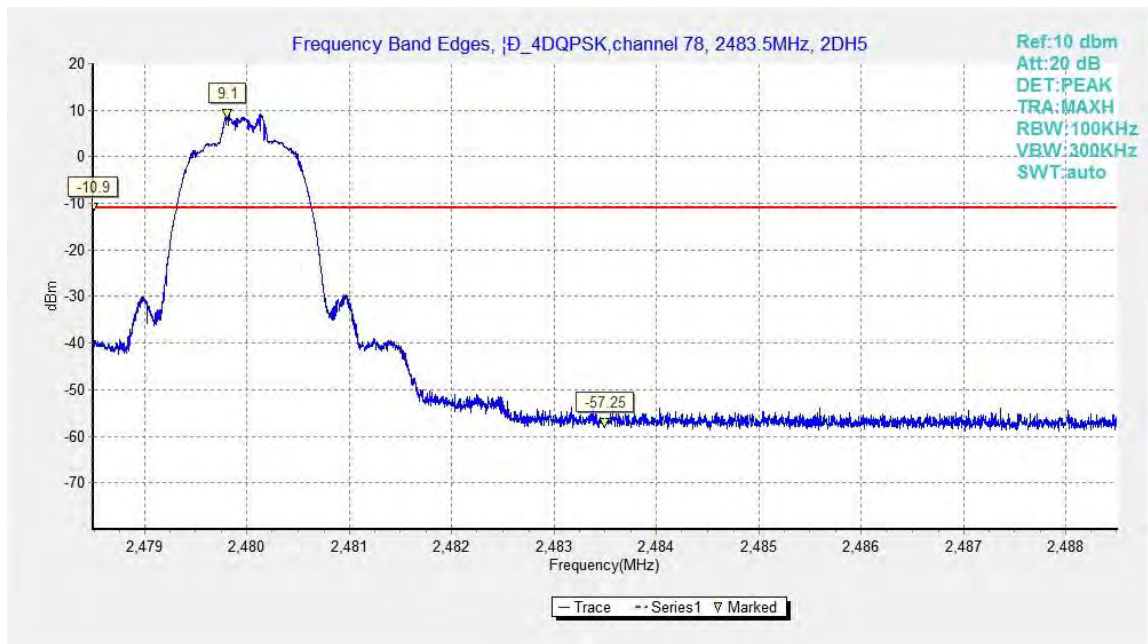

Fig.7. Frequency Band Edges:  $\pi/4$  DQPSK, Channel 78, Hopping Off

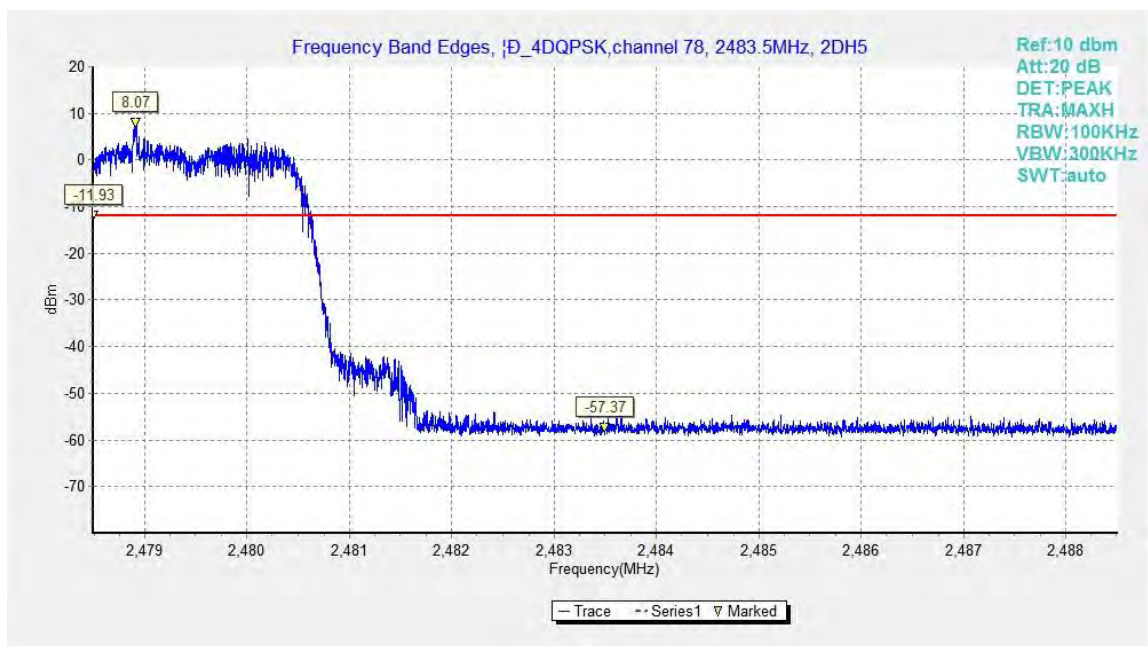

Fig.8. Frequency Band Edges:  $\pi/4$  DQPSK, Channel 78, Hopping On

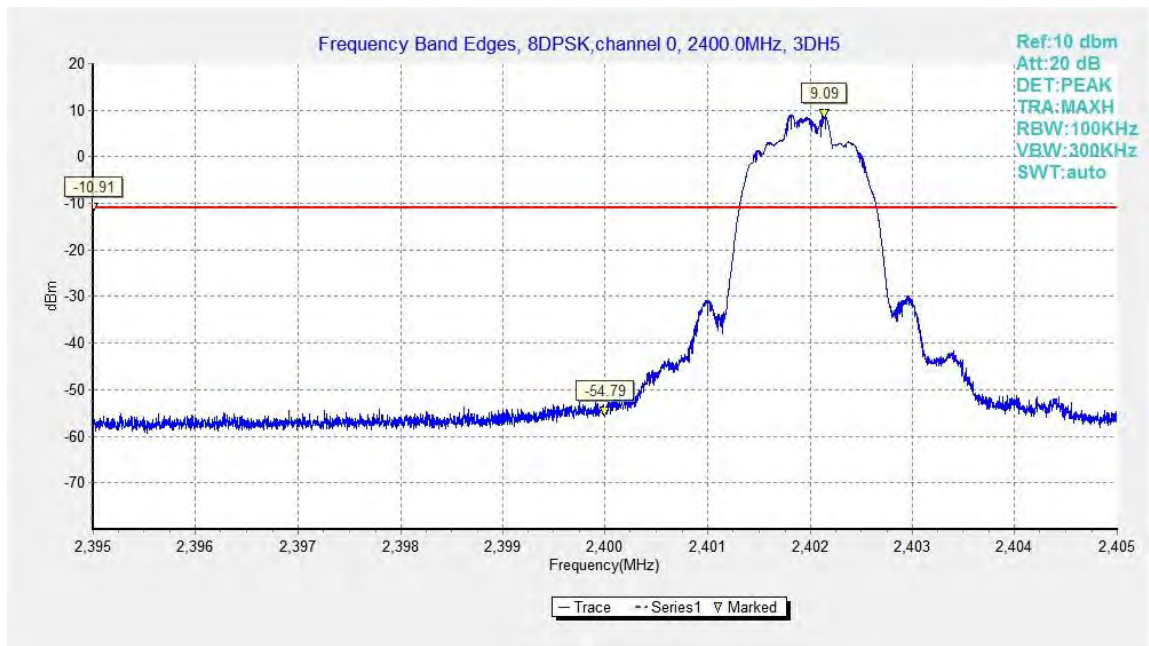

Fig.9. Frequency Band Edges: 8DPSK, Channel 0, Hopping Off

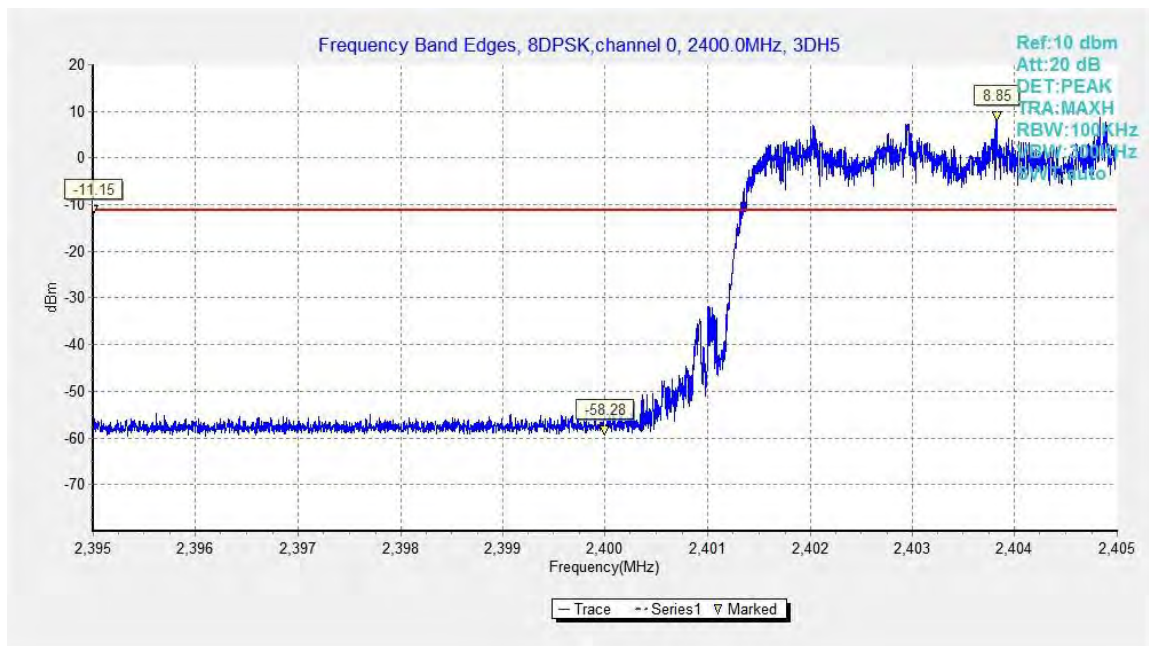

Fig.10. Frequency Band Edges: 8DPSK, Channel 0, Hopping On



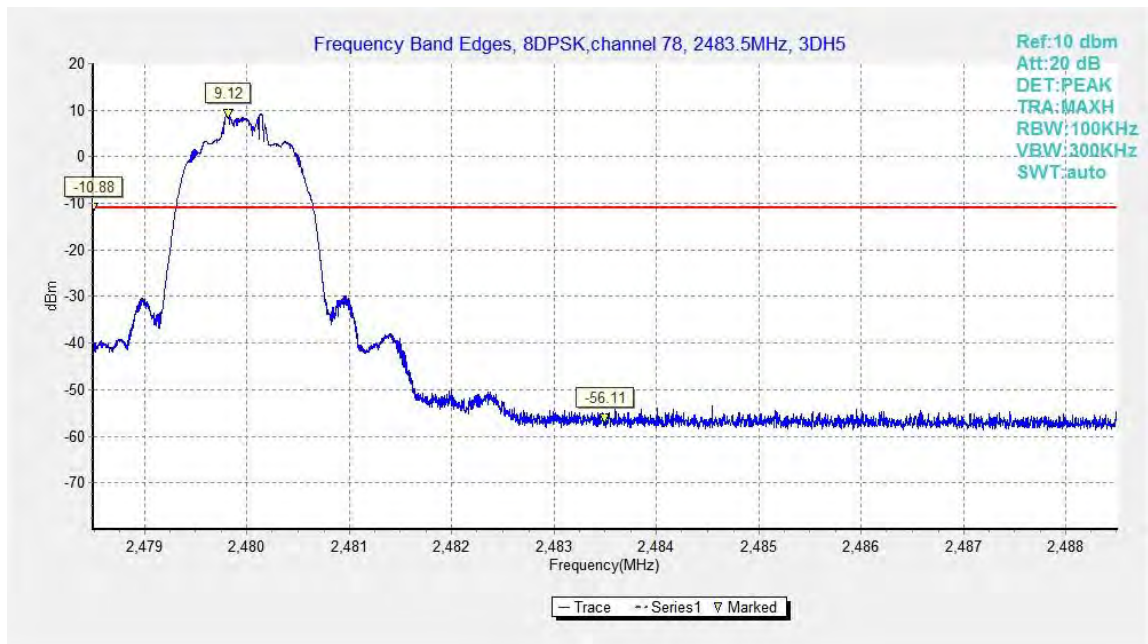

Fig.11. Frequency Band Edges: 8DPSK, Channel 78, Hopping Off

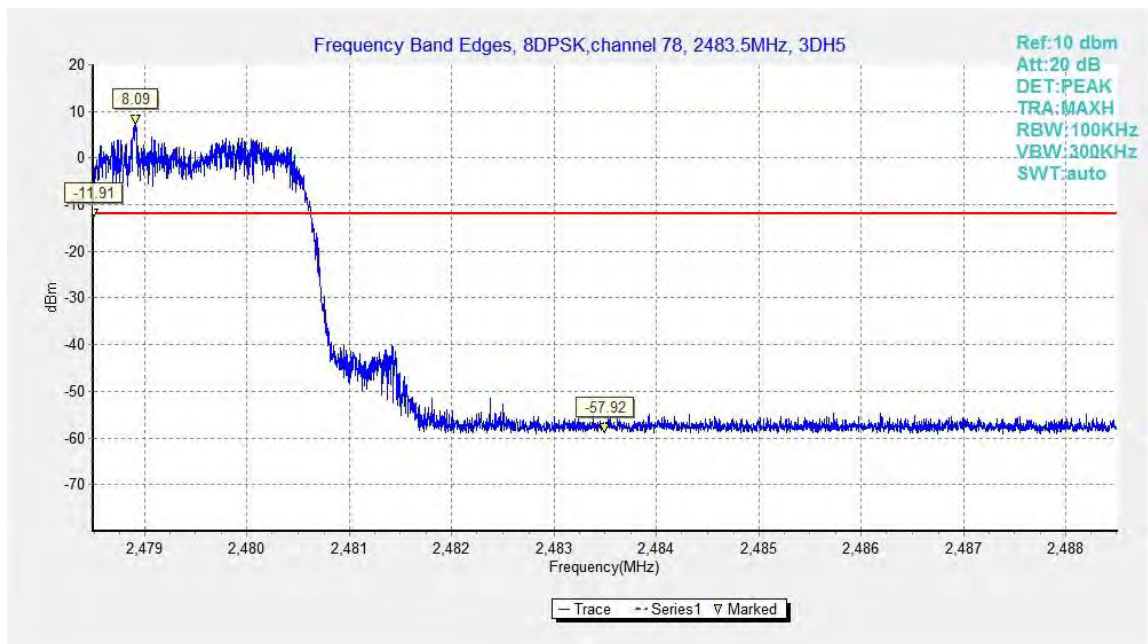

Fig.12. Frequency Band Edges: 8DPSK, Channel 78, Hopping On

## B.4. Frequency Band Edges –Radiated

**Method of Measurement:** See ANSI C63.10-2013-clause 6.4 &6.5 & 6.6

**Measurement Limit:**

Standard	Limit
FCC 47 CFR Part 15.247, 15.205, 15.209	20dB below peak output power

radiated emissions which fall in the restricted bands, as defined in § 15.205(a), must also comply with the radiated emission limits specified in § 15.209(a) (see § 15.205(c)).

**Limit in restricted band:**

Frequency (MHz)	Field strength( $\mu$ V/m)	Measurement distance (m)
0.009 - 0.490	2400/F(kHz)	300
0.490 - 1.705	24000/F(kHz)	30
1.705 – 30.0	30	30

Frequency of emission (MHz)	Field strength(uV/m)	Field strength(dBuV/m)
30-88	100	40
88-216	150	43.5
216-960	200	46
Above 960	500	54

**Set up:**

Tabletop devices shall be placed on a nonconducting platform with nominal top surface dimensions 1 m by 1.5 m and the table height shall be 1.5 m.

The EUT and transmitting antenna shall be centered on the turntable.

**Test Condition**

The EUT shall be tested 1 near top, 1 near middle, and 1 near bottom. Set the unlicensed wireless device to operate in continuous transmit mode. For unlicensed wireless devices unable to be configured for 100% duty cycle even in test mode, configure the system for the maximum duty cycle supported.

When required for unlicensed wireless devices, measurements of the variation of the input power or the radiated signal level of the fundamental frequency component of the emission, as appropriate, shall be performed with the supply voltage varied between 85% and 115% of the nominal rated supply voltage.

**Exploratory radiated emissions measurements**

Exploratory radiated measurements shall be performed at the measurement distance or at a closer distance than that specified for compliance to determine the emission characteristics of the EUT and, if applicable, the EUT configuration that produces the maximum level of emissions. The frequencies of maximum emission may be determined by manually positioning the antenna close to the EUT, and then moving the antenna over all sides of the EUT while observing a spectral

display. It is advantageous to have prior knowledge of the frequencies of emissions, although this may be determined from such a near-field scan. The near-field scan shall only be used to determine the frequency but not the amplitude of the emissions. Where exploratory measurements are not adequate to determine the worst-case operating modes and are used only to identify the frequencies of the highest emissions, additional preliminary tests can be required.

For emissions from the EUT, the maximum level shall be determined by rotating the EUT and its antenna through 0° to 360°. For each mode of operation required to be tested, the frequency spectrum (based on findings from exploratory measurements) shall be monitored.

Broadband antennas and a spectrum analyzer or a radio-noise meter with a panoramic display are often useful in this type of test. If either antenna height or EUT azimuth are not fully measured during exploratory testing, then complete testing can be required at the OATS or semi-anechoic chamber when the final full spectrum testing is performed.

### Final radiated emissions measurements

The final measurements are using the orientation and equipment arrangement of the EUT based on the measurement results found during the preliminary (exploratory) measurements, the EUT arrangement, appropriate modulation, and modes of operation that produce the emissions that have the highest amplitude relative to the limit shall be selected for the final measurement.

For emissions from the EUT, the maximum level shall be determined by rotating the EUT and its antenna through 0° to 360°. Final measurements for the EUT require a measurement antenna height scan of 1 m to 4 m and the antenna rotated to repeat the measurements for both the horizontal and vertical antenna polarizations. For each mode of operation required to be tested, the frequency spectrum (based on findings from exploratory measurements) shall be monitored.

For each mode selected, record the frequency and amplitude of the highest fundamental emission (if applicable), as well as the frequency and amplitude of the six highest spurious emissions relative to the limit. Emissions more than 20 dB below the limit do not need to be reported.

This maximization process was repeated with the EUT positioned in each of its three orthogonal orientations.

### The receiver references:

Frequency of emission (MHz)	RBW/VBW	Sweep Time(s)
30-1000	100kHz/300kHz	5
1000-4000	1MHz/3MHz	15
4000-18000	1MHz/3MHz	40
18000-26500	1MHz/3MHz	20

EUT ID: EUT1

Measurement Results:

Mode	Channel	Frequency Range	Test Results	Conclusion
GFSK	0	2.31GHz ~2.43GHz	Fig.13	P
	78	2.45GHz ~2.5GHz	Fig.14	P

Mode	Channel	Frequency Range	Test Results	Conclusion
$\pi/4$ DQPSK	0	2.31GHz ~2.43GHz	Fig.15	P
	78	2.45GHz ~2.5GHz	Fig.16	P

Mode	Channel	Frequency Range	Test Results	Conclusion
8DPSK	0	2.31GHz ~2.43GHz	Fig.17	P
	78	2.45GHz ~2.5GHz	Fig.18	P

Conclusion: PASS

Test graphs as below

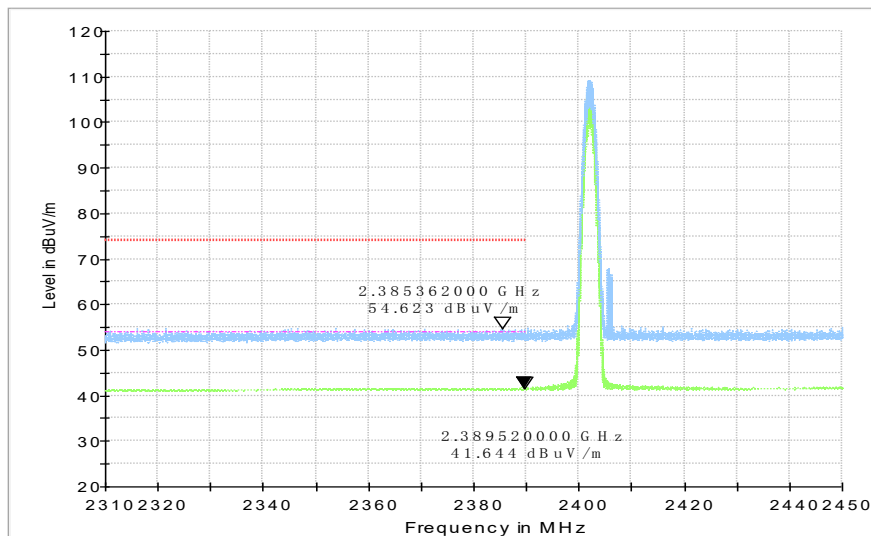
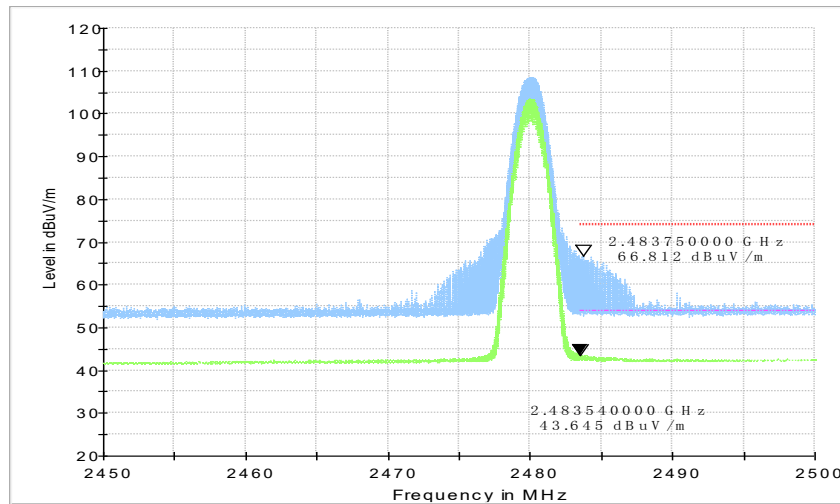
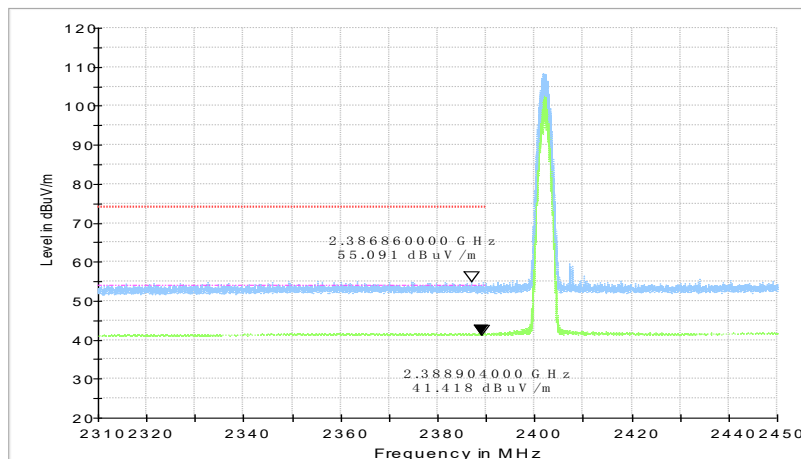

Fig.13. Frequency Band Edges: GFSK, Channel 0, Hopping Off, 2.31 GHz – 2.45GHz



**Fig.14. Frequency Band Edges: GFSK, Channel 78, Hopping Off, ch11, 2.45 GHz - 2.50GHz**



**Fig.15. Frequency Band Edges:  $\pi/4$  DQPSK, Channel 0, Hopping Off, 2.31 GHz - 2.45GHz**

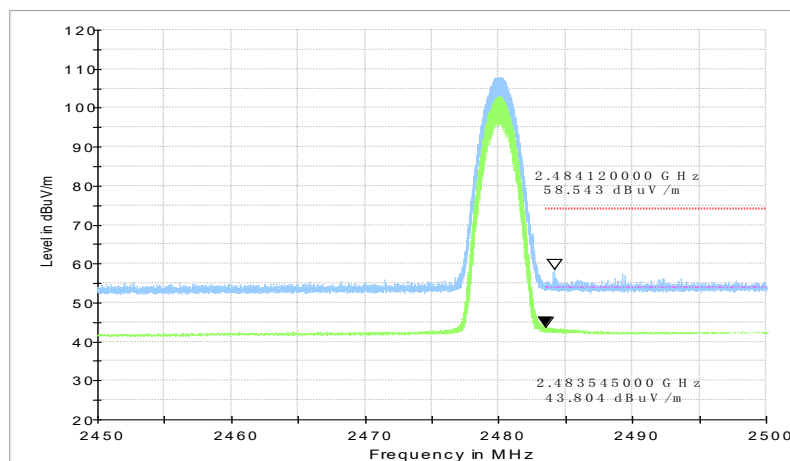

**Fig.16. Frequency Band Edges:  $\pi/4$  DQPSK, Channel 78, Hopping Off, 2.45 GHz - 2.50GHz**

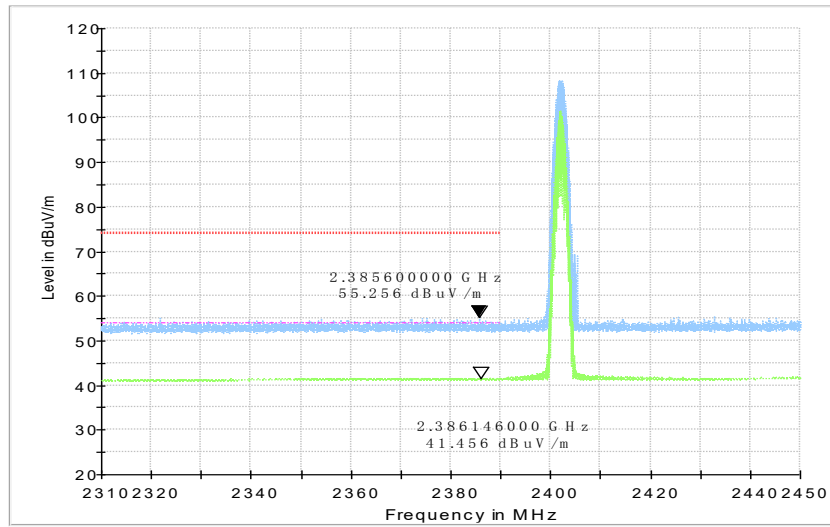

**Fig.17. Frequency Band Edges: 8DPSK, Channel 0, 2.31 GHz - 2.45GHz**

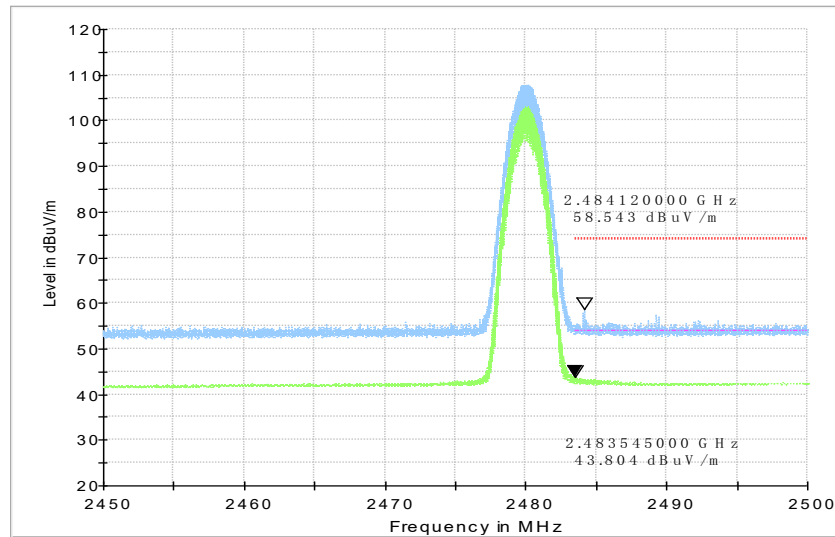

**Fig.18. Frequency Band Edges: 8DPSK, Channel 78, 2.45 GHz - 2.50GHz**

## B.5. Transmitter Spurious Emission - Conducted

**Method of Measurement: See ANSI C63.10-clause 7.8.8**

Measurement Procedure – Reference Level

1. Set the RBW = 100 kHz.
2. Set the VBW = 300 kHz.
3. Set the span to 5-30 % greater than the EBW.
4. Detector = peak.
5. Sweep time = auto couple.
6. Trace mode = max hold.
7. Allow trace to fully stabilize.
8. Use the peak marker function to determine the maximum power level in any 100 kHz band segment within the fundamental EBW. Next, determine the power in 100 kHz band segments outside of the authorized frequency band using the following measurement:

Measurement Procedure - Unwanted Emissions

1. Set RBW = 100 kHz.
2. Set VBW = 300 kHz.
3. Set span to encompass the spectrum to be examined.
4. Detector = peak.
5. Trace Mode = max hold.
6. Sweep = auto couple.
7. Allow the trace to stabilize (this may take some time, depending on the extent of the span).

Ensure that the amplitude of all unwanted emissions outside of the authorized frequency band (excluding restricted frequency bands) is attenuated by at least the minimum requirements specified above.

### Measurement Limit:

Standard	Limit
FCC 47 CFR Part 15.247 (d)	20dB below peak output power in 100 kHz bandwidth

### Measurement Results:

#### For GFSK

Channel	Frequency Range	Test Results	Conclusion
Ch 0	Center Frequency	Fig.19	P

2402 MHz	30 MHz ~ 1 GHz	Fig.20	P
	1 GHz ~ 3 GHz	Fig.21	P
	3 GHz ~ 10 GHz	Fig.22	P
	10 GHz ~ 26 GHz	Fig.23	P
Ch 39 2441 MHz	Center Frequency	Fig.24	P
	30 MHz ~ 1 GHz	Fig.25	P
	1 GHz ~ 3 GHz	Fig.26	P
	3 GHz ~ 10 GHz	Fig.27	P
	10 GHz ~ 26 GHz	Fig.28	P
Ch 78 2480 MHz	Center Frequency	Fig.29	P
	30 MHz ~ 1 GHz	Fig.30	P
	1 GHz ~ 3 GHz	Fig.31	P
	3 GHz ~ 10 GHz	Fig.32	P
	10 GHz ~ 26 GHz	Fig.33	P

**For  $\pi/4$  DQPSK**

Channel	Frequency Range	Test Results	Conclusion
Ch 0 2402 MHz	Center Frequency	Fig.34	P
	30 MHz ~ 1 GHz	Fig.35	P
	1 GHz ~ 3 GHz	Fig.36	P
	3 GHz ~ 10 GHz	Fig.37	P
	10 GHz ~ 26 GHz	Fig.38	P
Ch 39 2441 MHz	Center Frequency	Fig.39	P
	30 MHz ~ 1 GHz	Fig.40	P
	1 GHz ~ 3 GHz	Fig.41	P
	3 GHz ~ 10 GHz	Fig.42	P
	10 GHz ~ 26 GHz	Fig.43	P
Ch 78 2480 MHz	Center Frequency	Fig.44	P
	30 MHz ~ 1 GHz	Fig.45	P
	1 GHz ~ 3 GHz	Fig.46	P
	3 GHz ~ 10 GHz	Fig.47	P
	10 GHz ~ 26 GHz	Fig.48	P

**For 8DPSK**

Channel	Frequency Range	Test Results	Conclusion
Ch 0 2402 MHz	Center Frequency	Fig.49	P
	30 MHz ~ 1 GHz	Fig.50	P
	1 GHz ~ 3 GHz	Fig.51	P
	3 GHz ~ 10 GHz	Fig.52	P
	10 GHz ~ 26 GHz	Fig.53	P



Ch 39 2441 MHz	Center Frequency	Fig.54	P
	30 MHz ~ 1 GHz	Fig.55	P
	1 GHz ~ 3 GHz	Fig.56	P
	3 GHz ~ 10 GHz	Fig.57	P
	10 GHz ~ 26 GHz	Fig.58	P
Ch 78 2480 MHz	Center Frequency	Fig.59	P
	30 MHz ~ 1 GHz	Fig.60	P
	1 GHz ~ 3 GHz	Fig.61	P
	3 GHz ~ 10 GHz	Fig.62	P
	10 GHz ~ 26 GHz	Fig.63	P

**Conclusion: PASS**

**Test graphs as below**

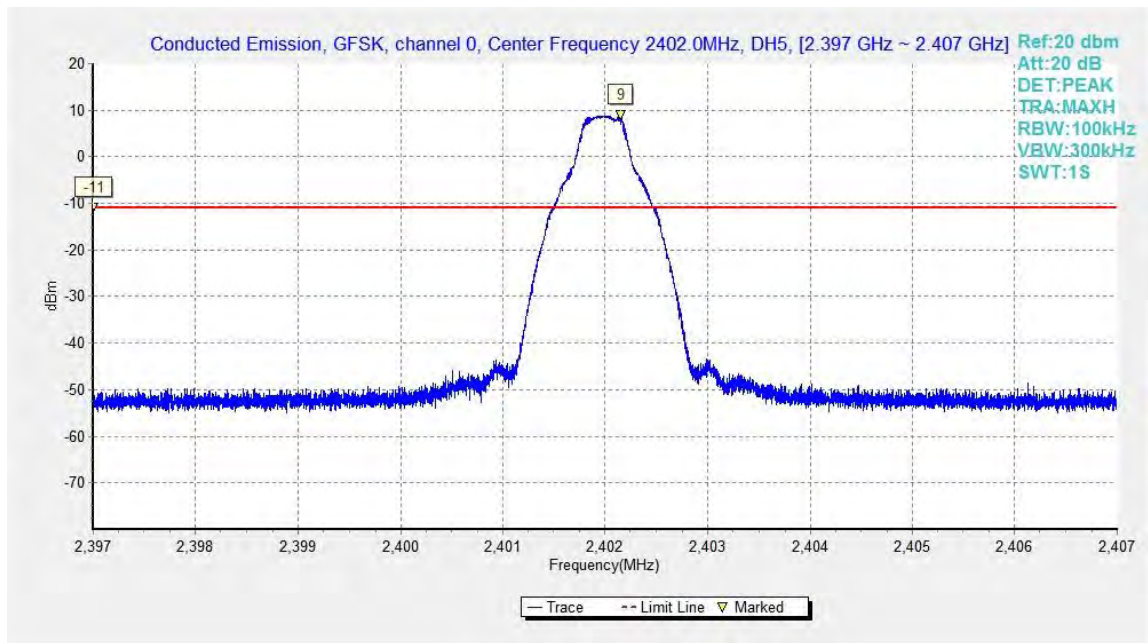

Fig.19. Conducted spurious emission: GFSK, Channel 0,2402MHz

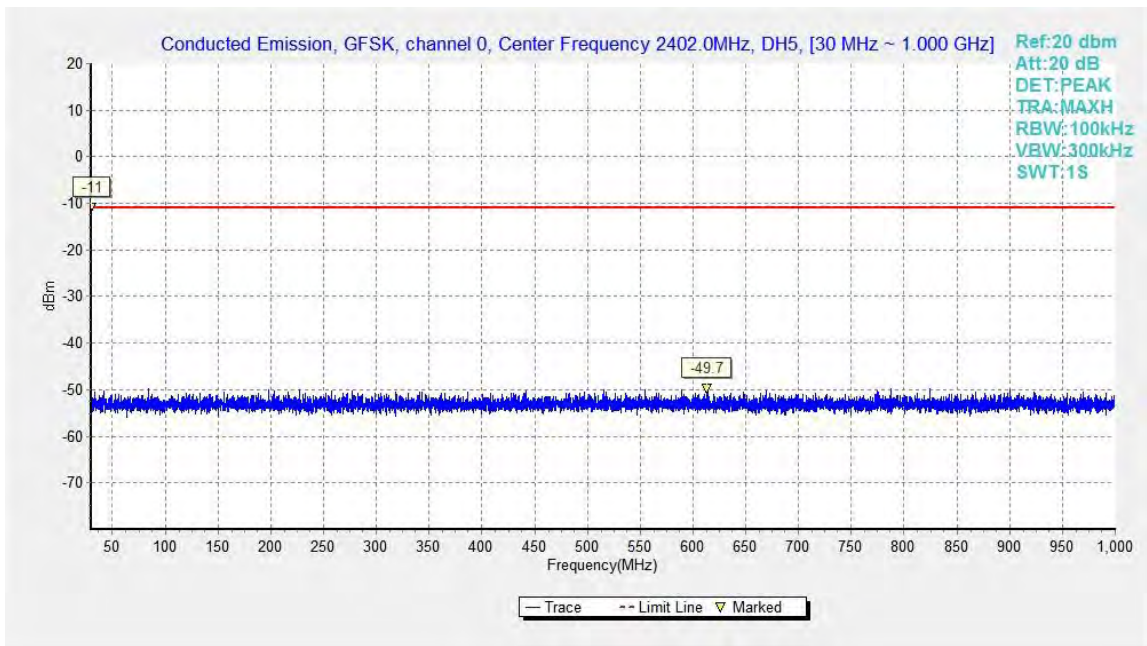

Fig.20. Conducted spurious emission: GFSK, Channel 0, 30MHz - 1GHz

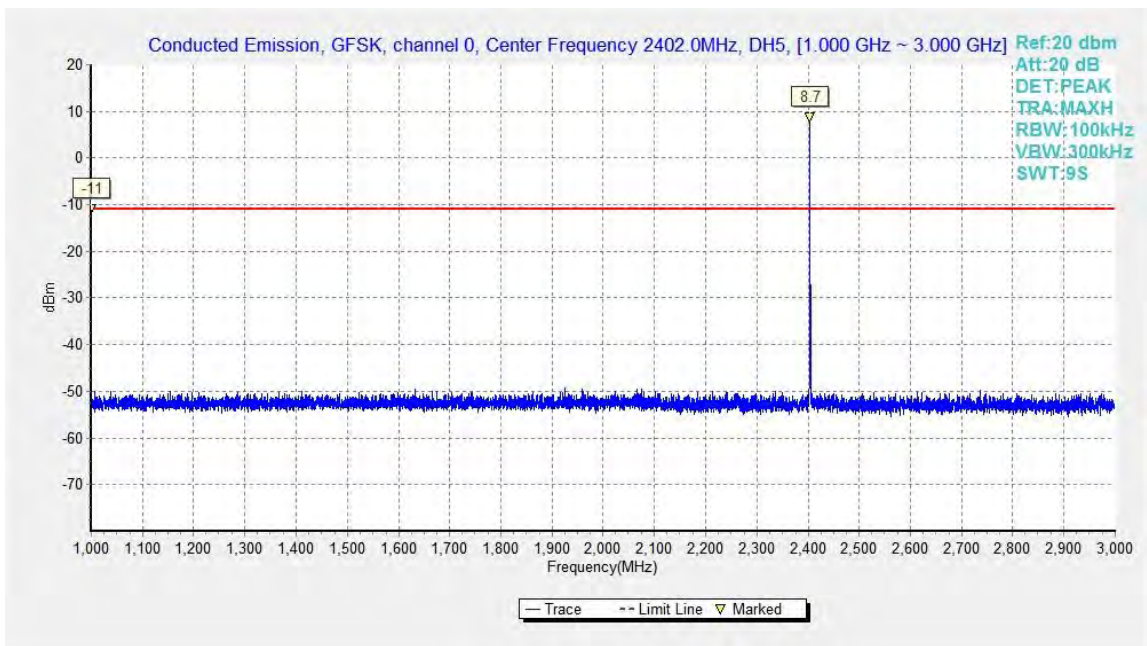

Fig.21. Conducted spurious emission: GFSK, Channel 0, 1GHz - 3GHz

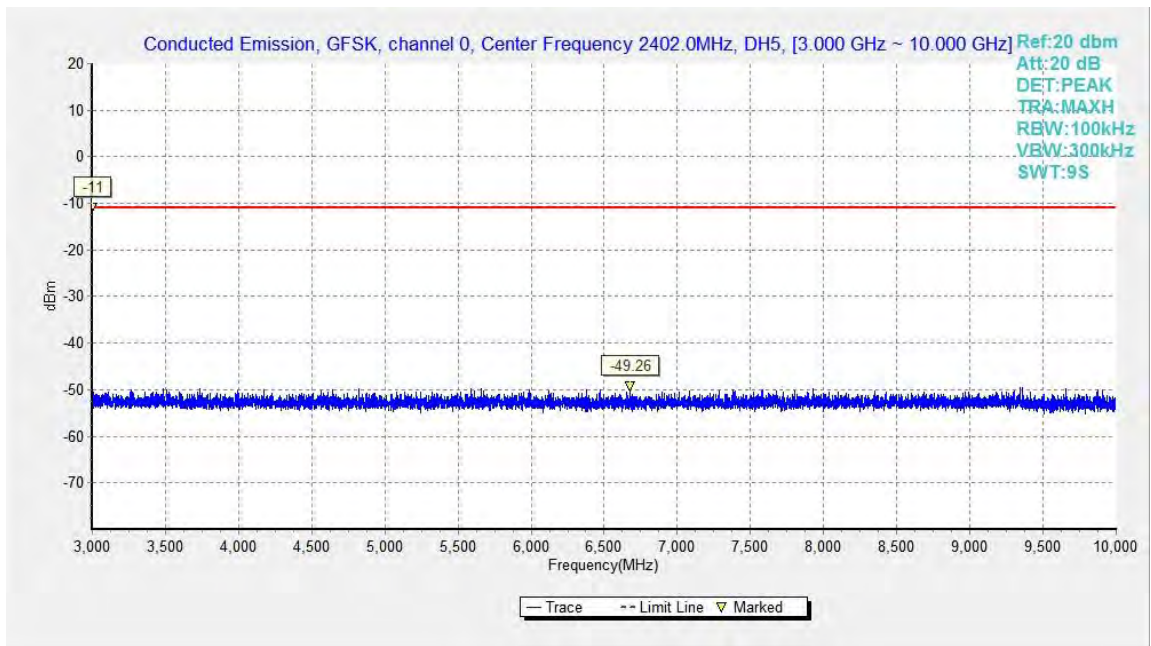

Fig.22. Conducted spurious emission: GFSK, Channel 0, 3GHz - 10GHz

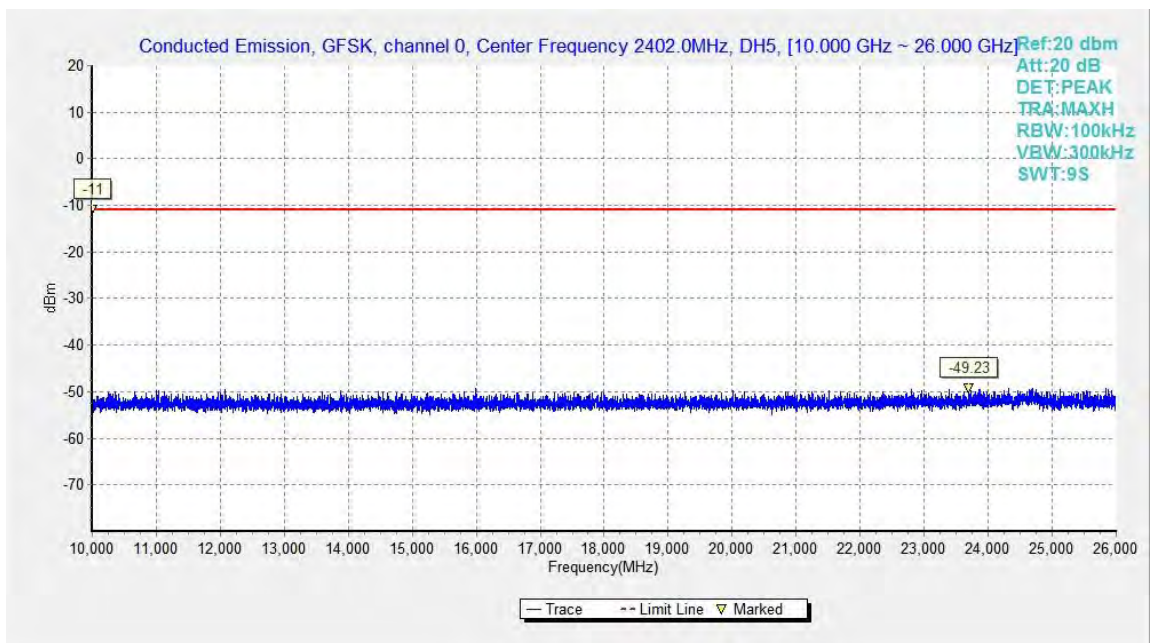

Fig.23. Conducted spurious emission: GFSK, Channel 0, 10GHz - 26GHz

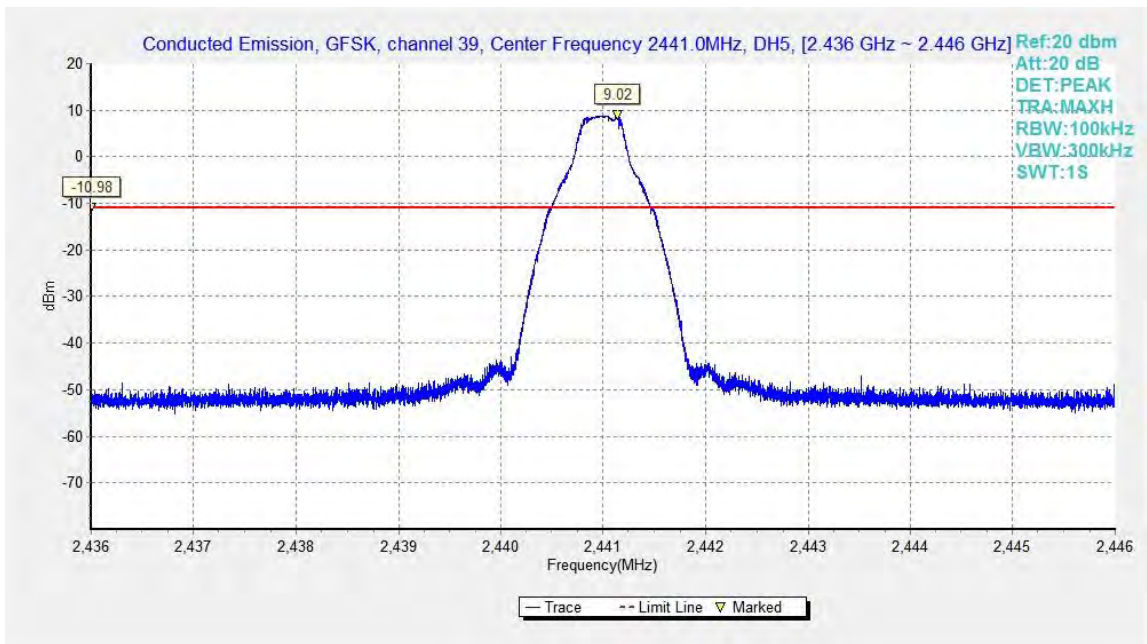

Fig.24. Conducted spurious emission: GFSK, Channel 39, 2441MHz

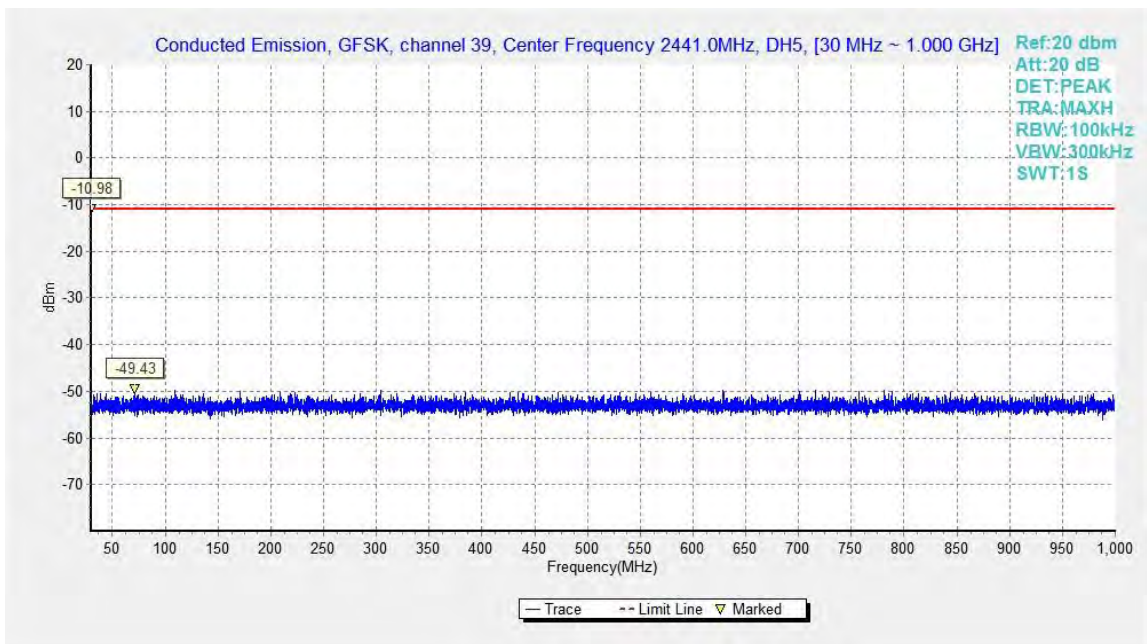

Fig.25. Conducted spurious emission: GFSK, Channel 39, 30MHz - 1GHz

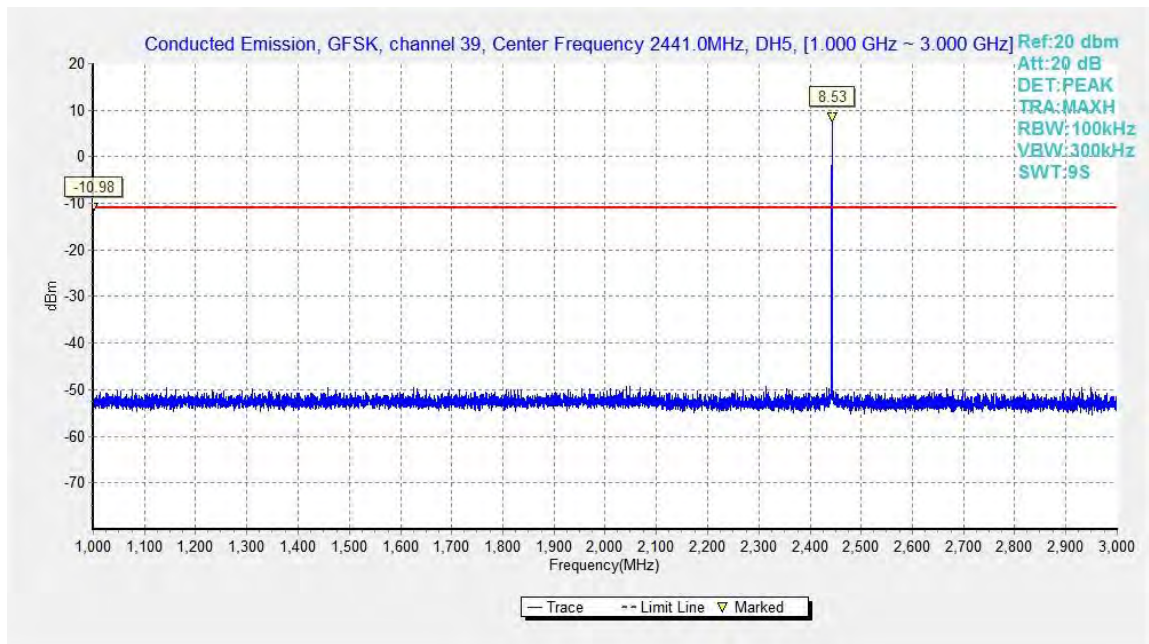

Fig.26. Conducted spurious emission: GFSK, Channel 39, 1GHz – 3GHz

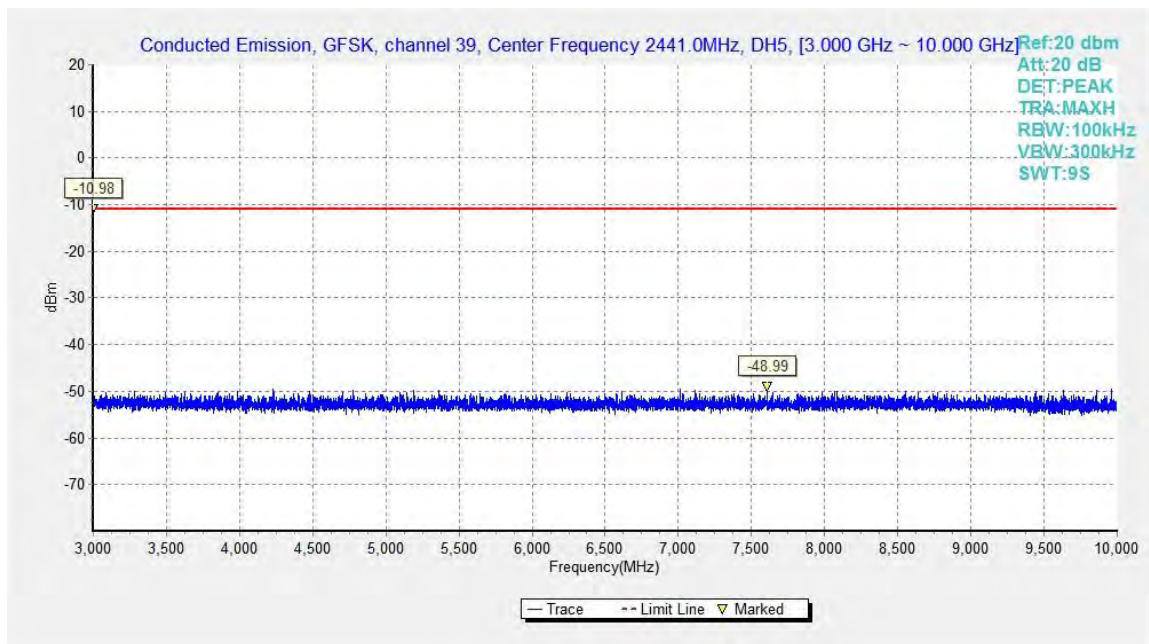

Fig.27. Conducted spurious emission: GFSK, Channel 39, 3GHz – 10GHz

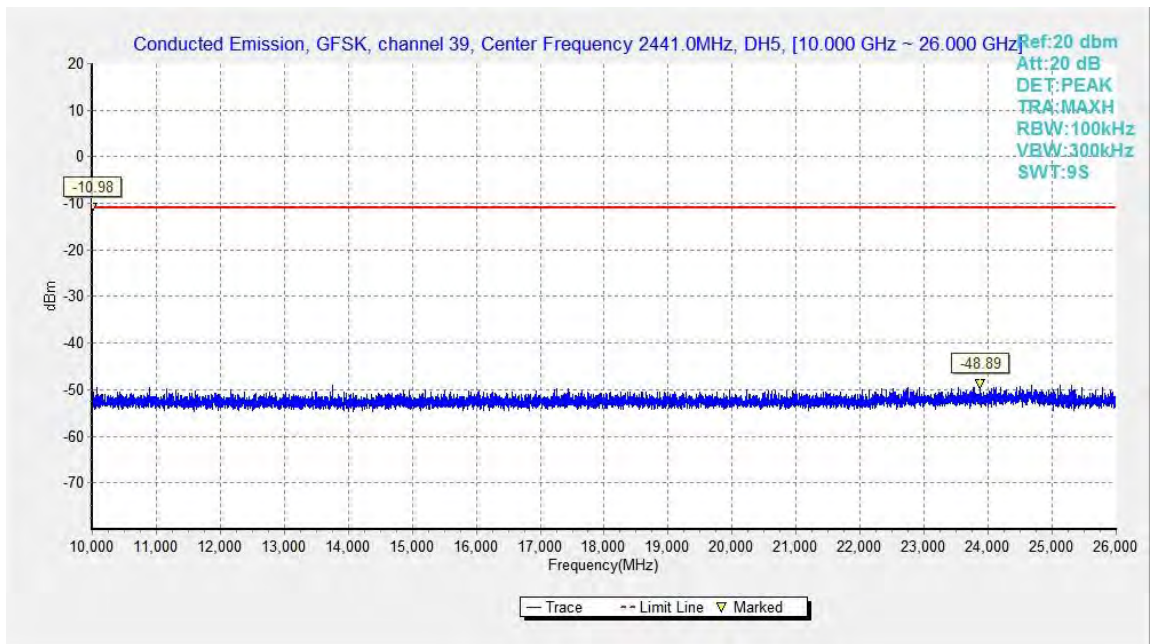

Fig.28. Conducted spurious emission: GFSK, Channel 39, 10GHz – 26GHz

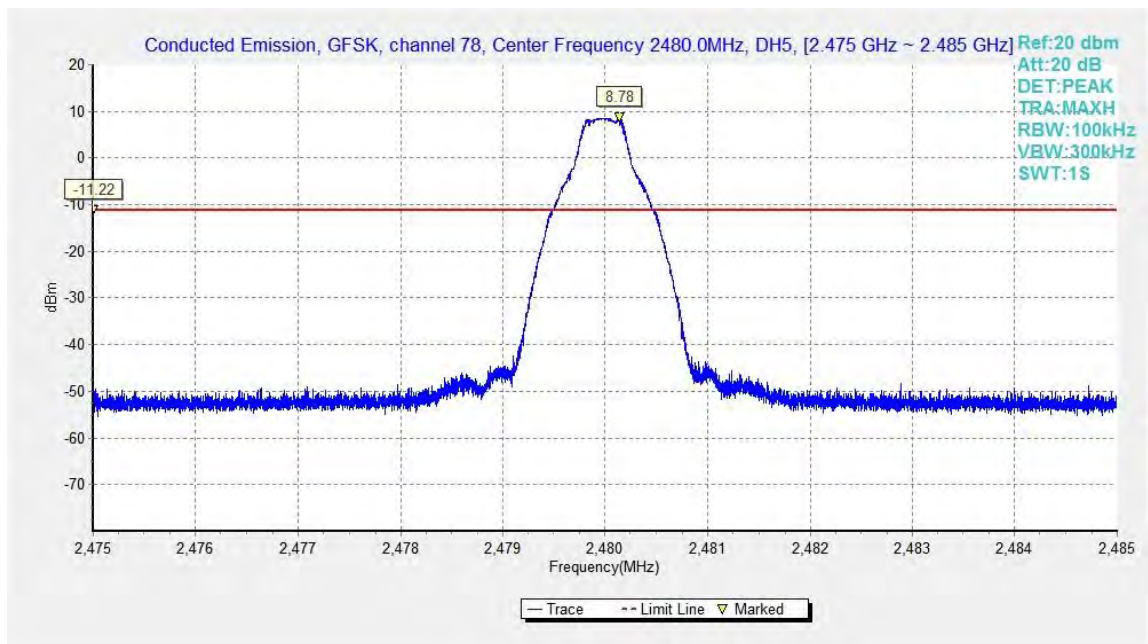

Fig.29. Conducted spurious emission: GFSK, Channel 78, 2480MHz

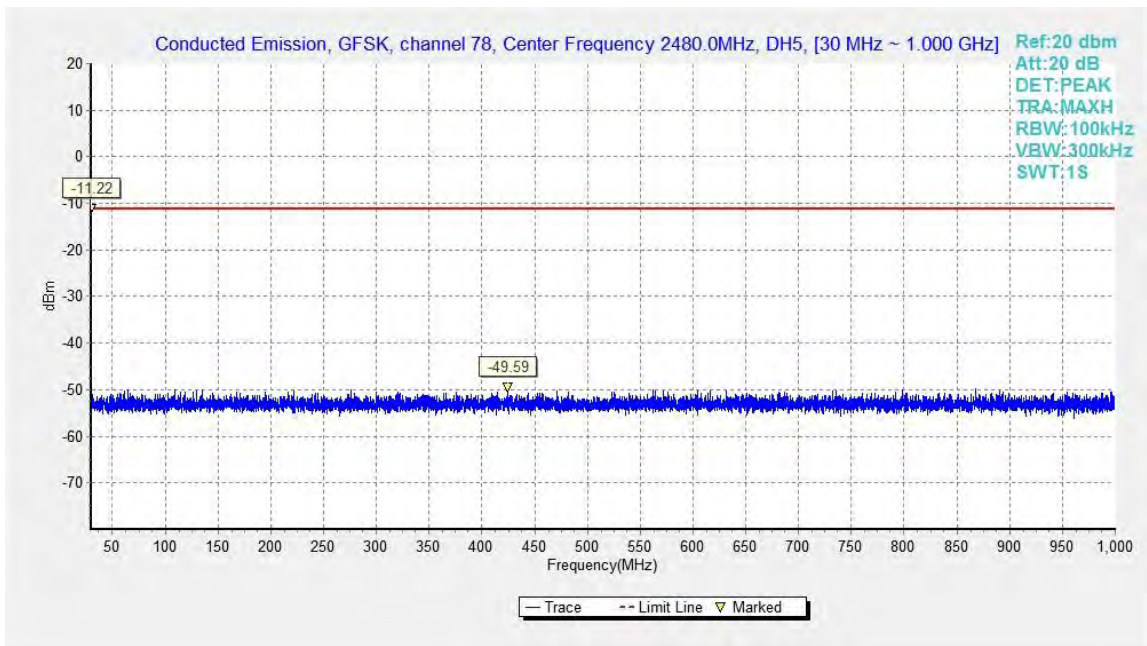

Fig.30. Conducted spurious emission: GFSK, Channel 78, 30MHz - 1GHz

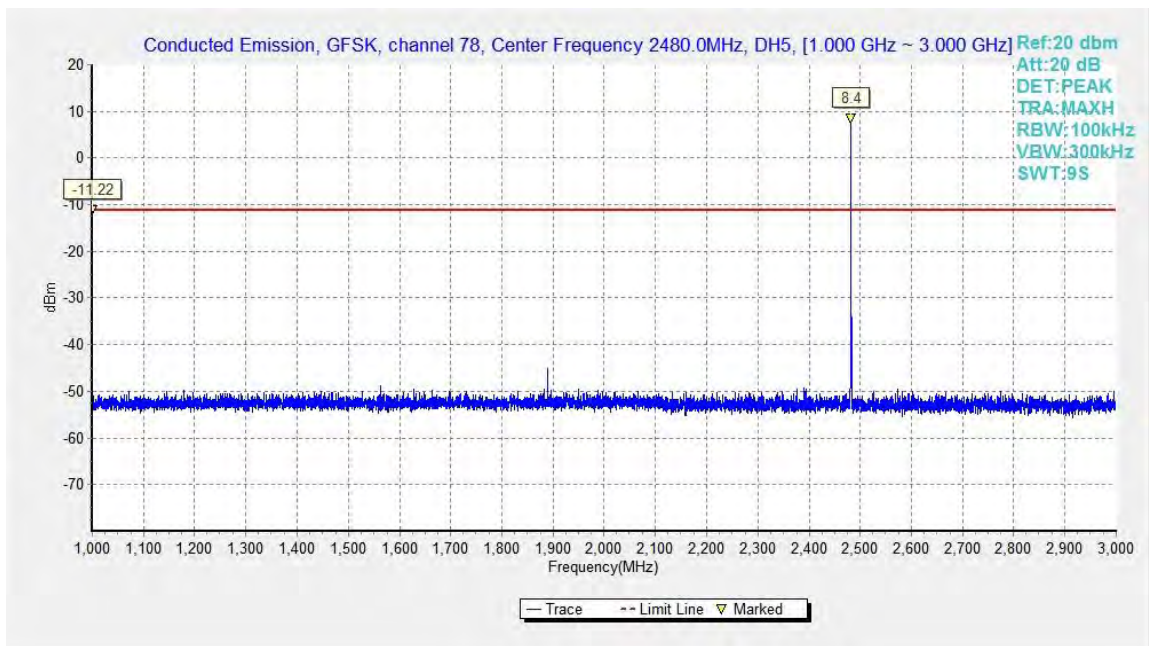

Fig.31. Conducted spurious emission: GFSK, Channel 78, 1GHz - 3GHz

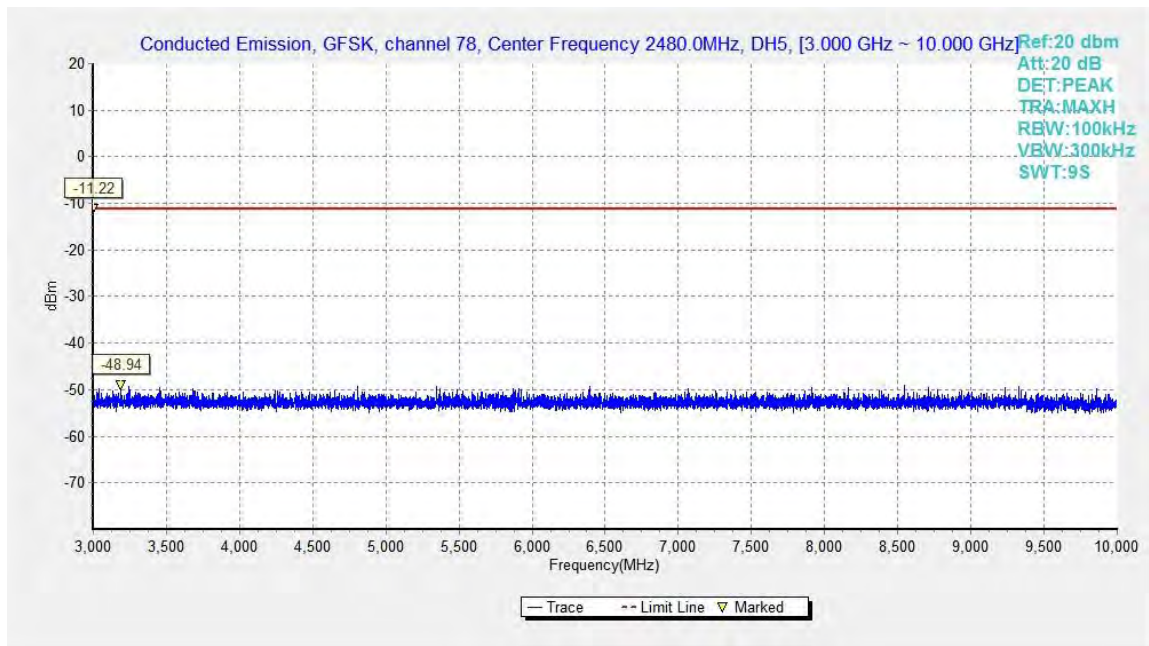

Fig.32. Conducted spurious emission: GFSK, Channel 78, 3GHz - 10GHz

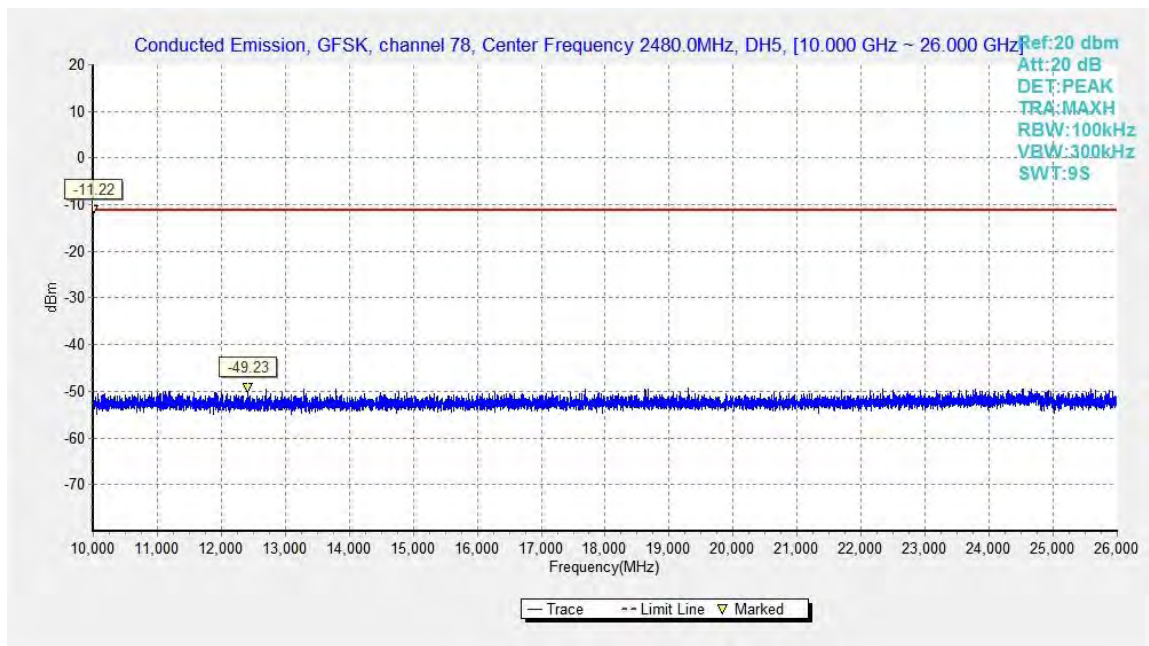

Fig.33. Conducted spurious emission: GFSK, Channel 78, 10GHz - 26GHz



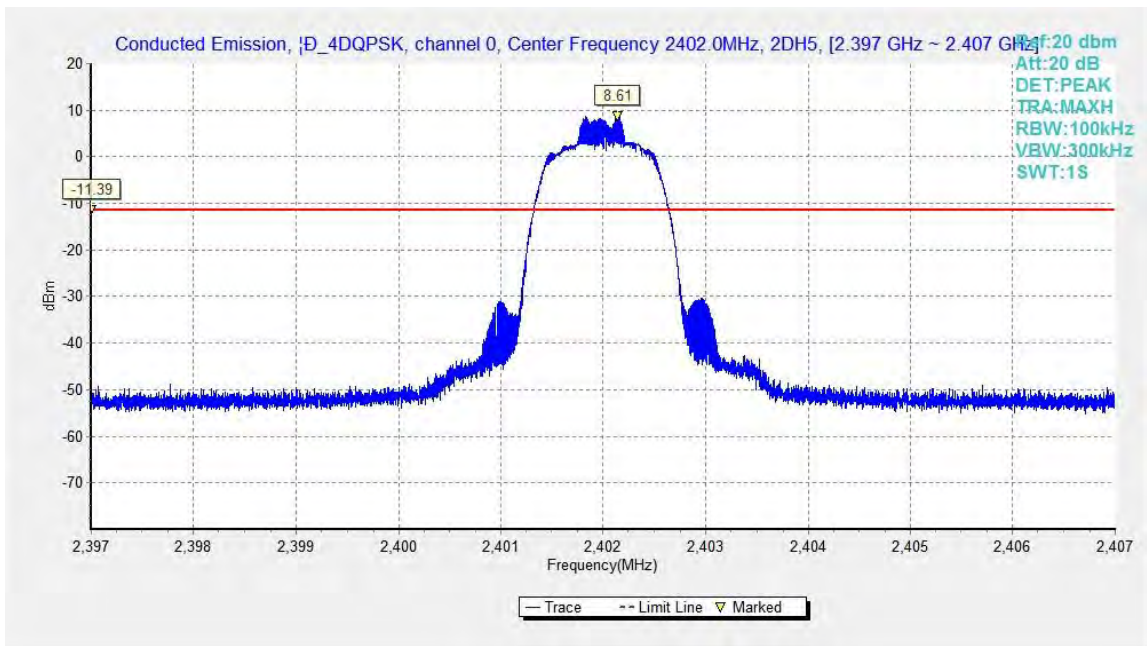

Fig.34. Conducted spurious emission:  $\pi/4$  DQPSK, Channel 0, 2402MHz

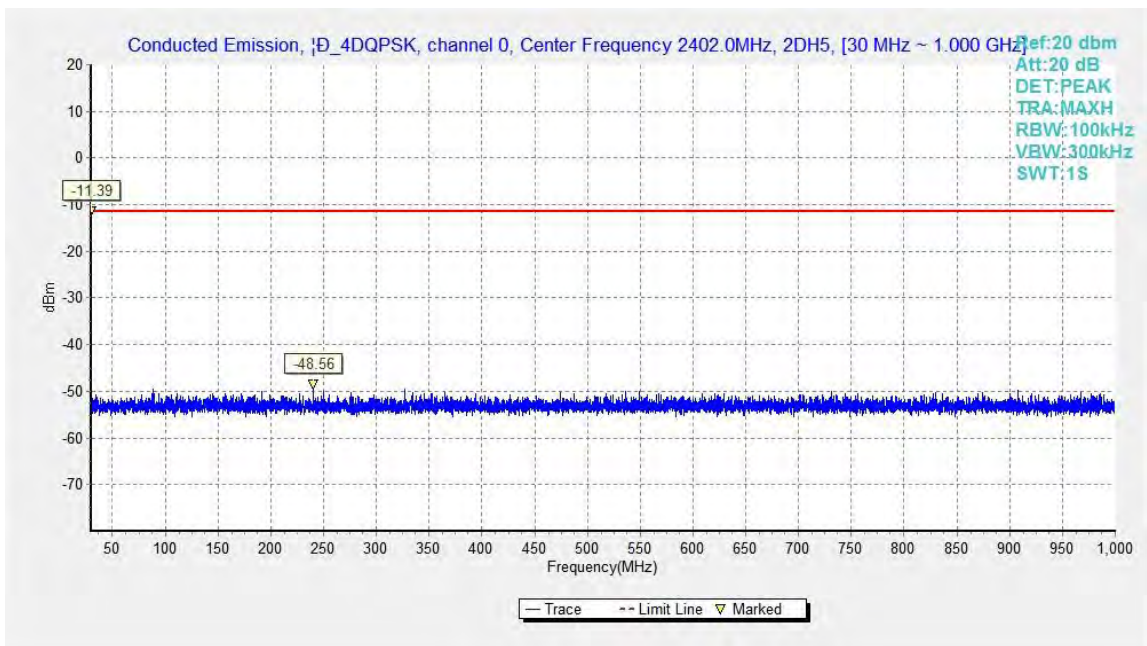

Fig.35. Conducted spurious emission:  $\pi/4$  DQPSK, Channel 0, 30MHz - 1GHz

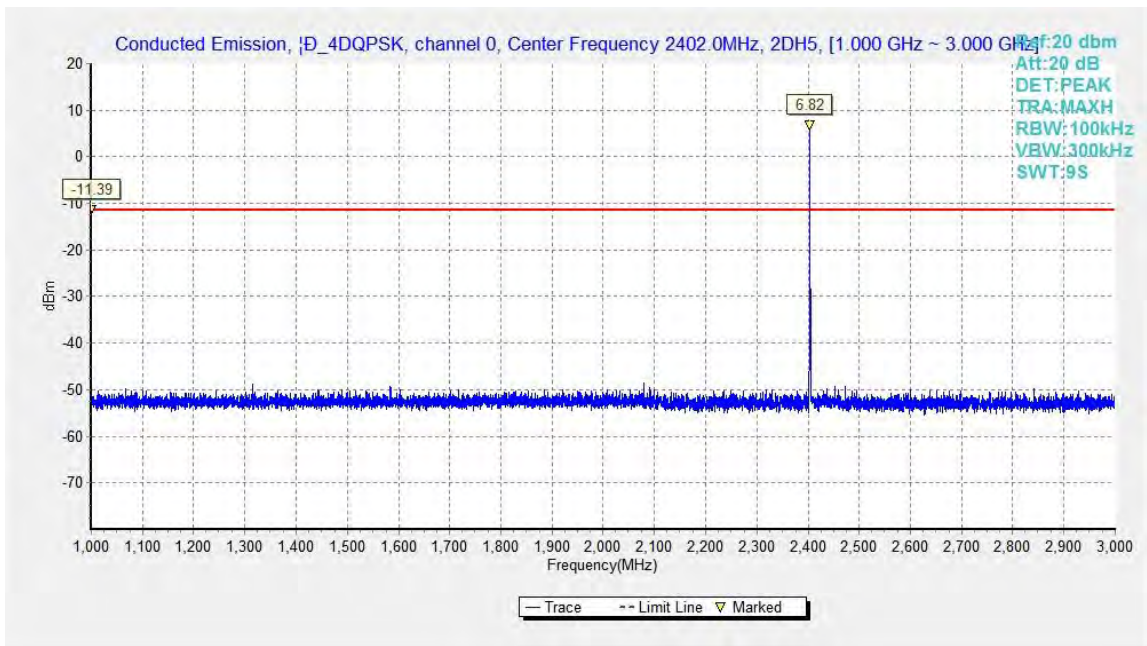

Fig.36. Conducted spurious emission:  $\pi/4$  DQPSK, Channel 0, 1GHz - 3GHz

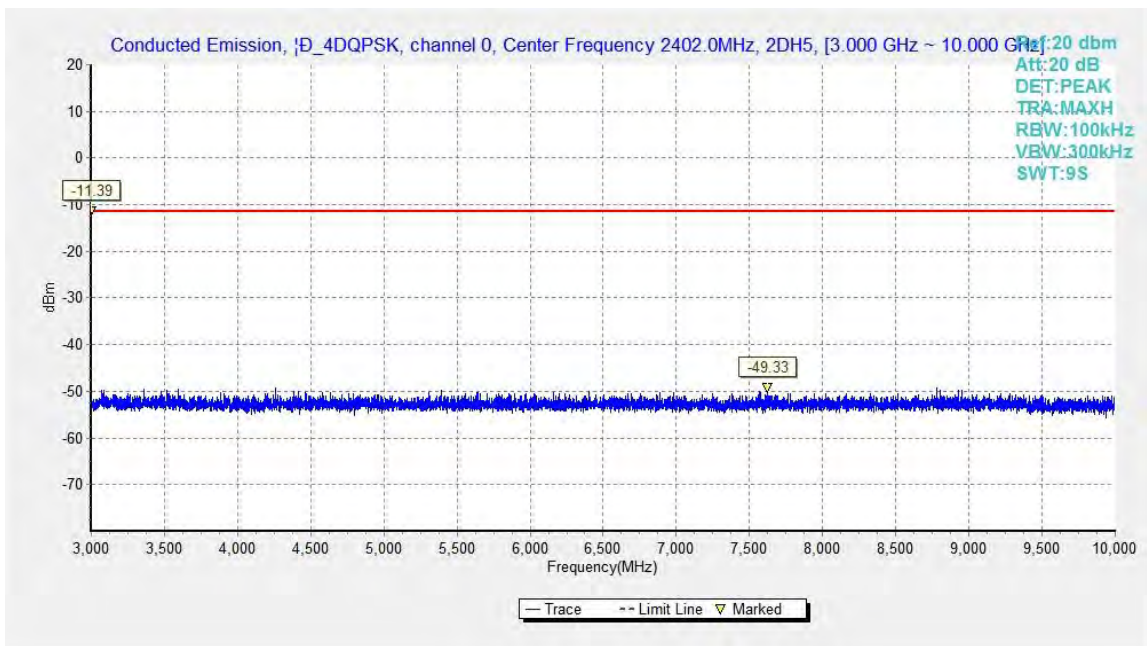

Fig.37. Conducted spurious emission:  $\pi/4$  DQPSK, Channel 0, 3GHz - 10GHz

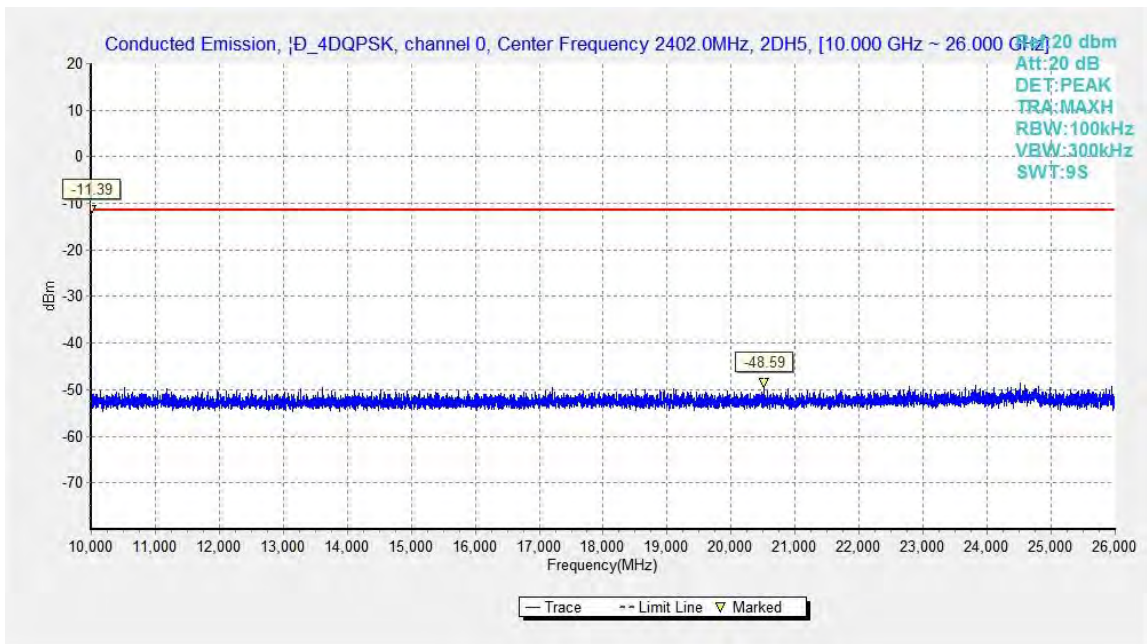

Fig.38. Conducted spurious emission:  $\pi/4$  DQPSK, Channel 0, 10GHz - 26GHz

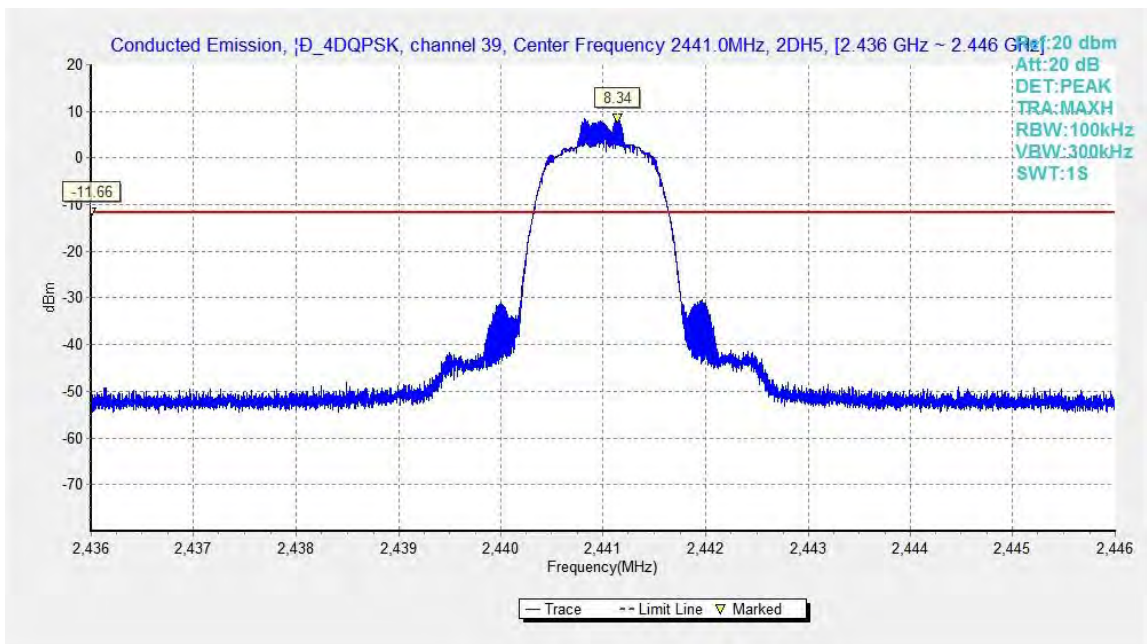

Fig.39. Conducted spurious emission:  $\pi/4$  DQPSK, Channel 39, 2441MHz

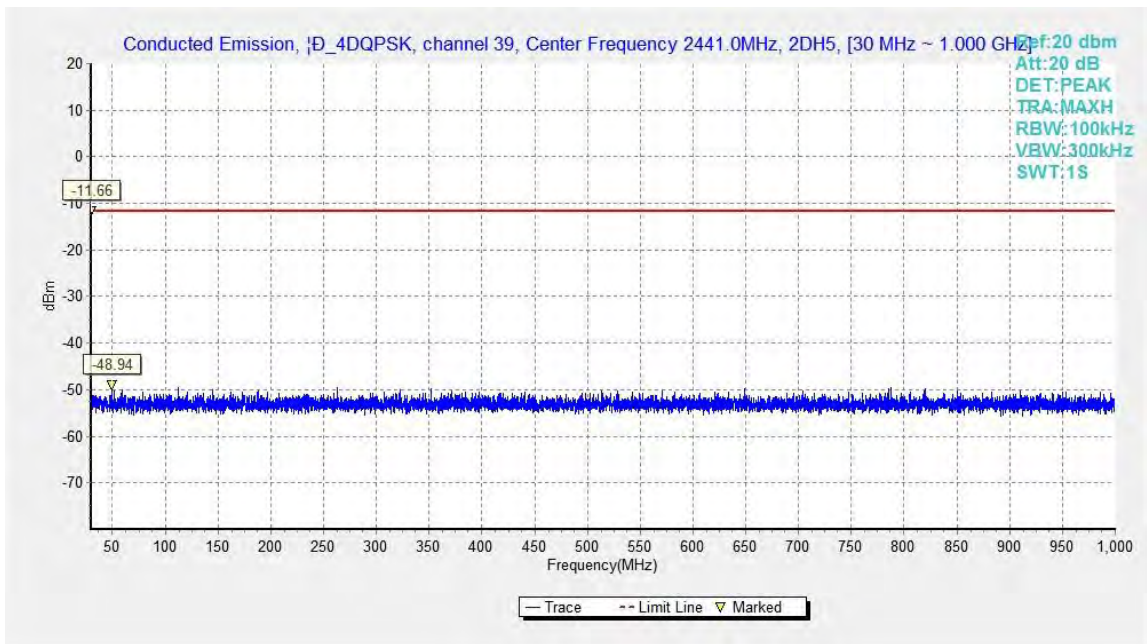

Fig.40. Conducted spurious emission:  $\pi/4$  DQPSK, Channel 39, 30MHz - 1GHz

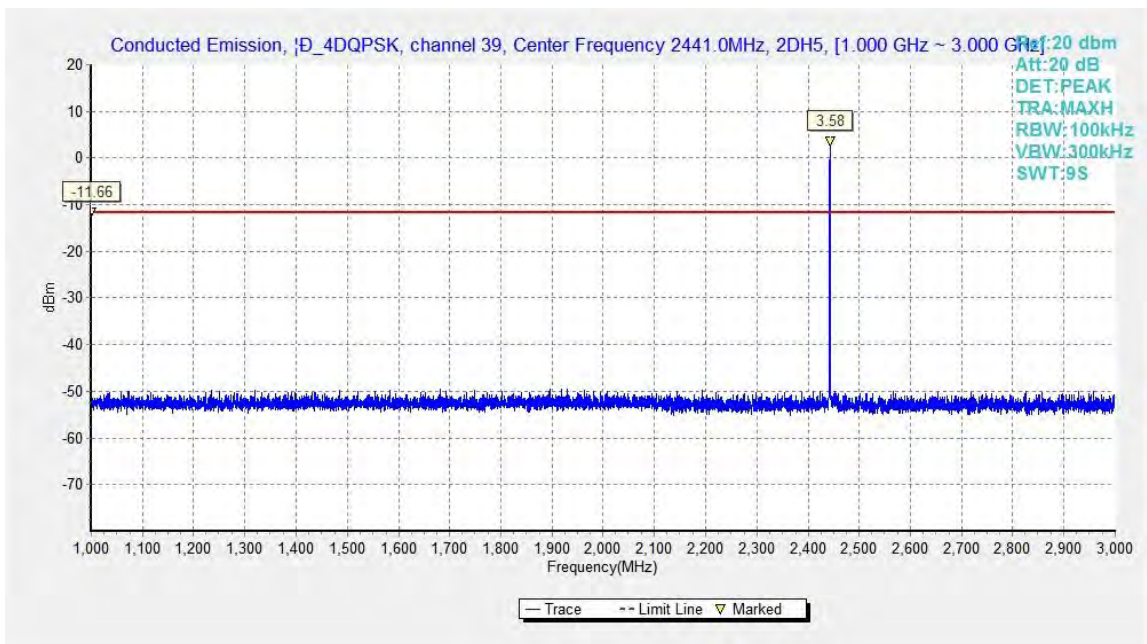

Fig.41. Conducted spurious emission:  $\pi/4$  DQPSK, Channel 39, 1GHz - 3GHz

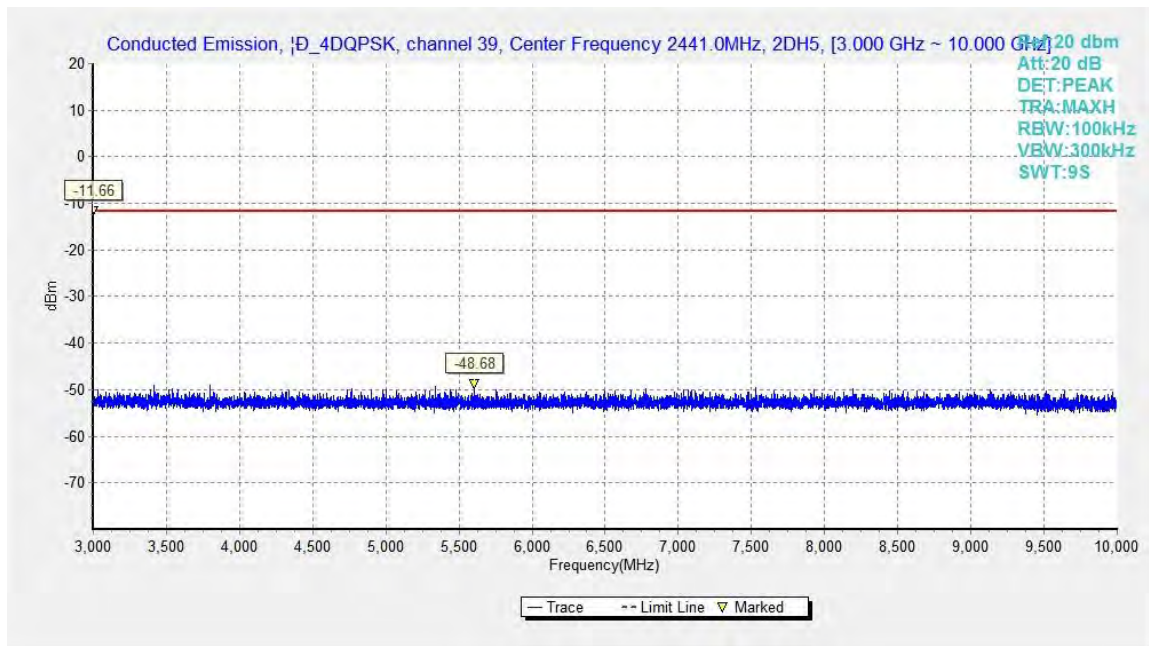

Fig.42. Conducted spurious emission:  $\pi/4$  DQPSK, Channel 39, 3GHz - 10GHz

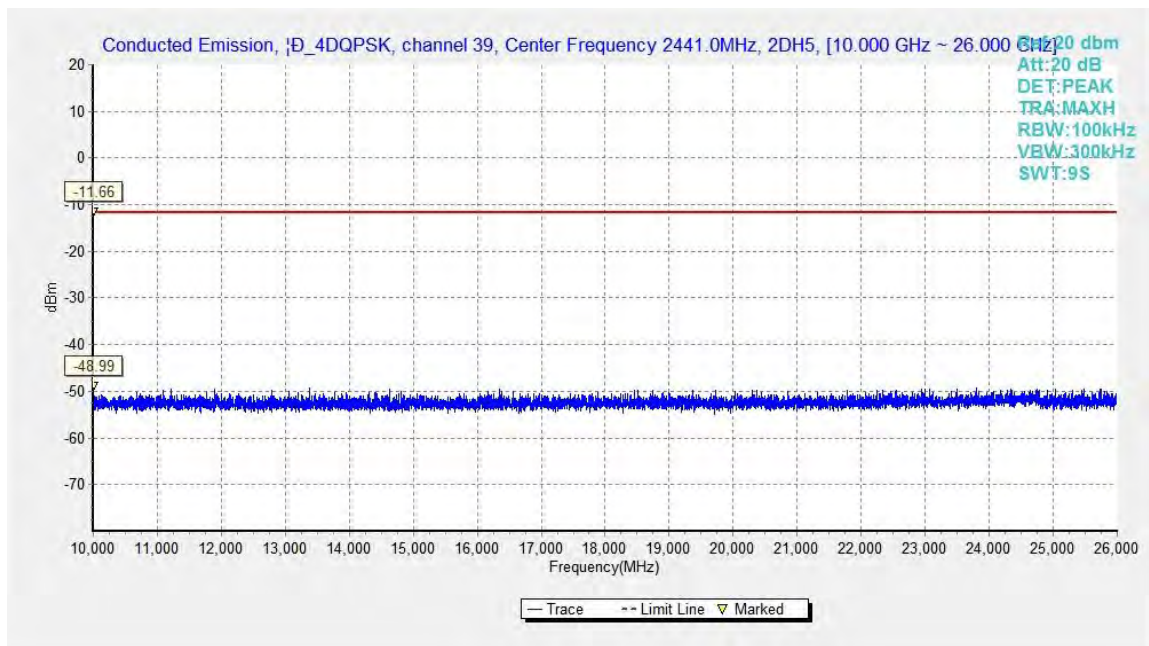

Fig.43. Conducted spurious emission:  $\pi/4$  DQPSK, Channel 39, 10GHz – 26GHz

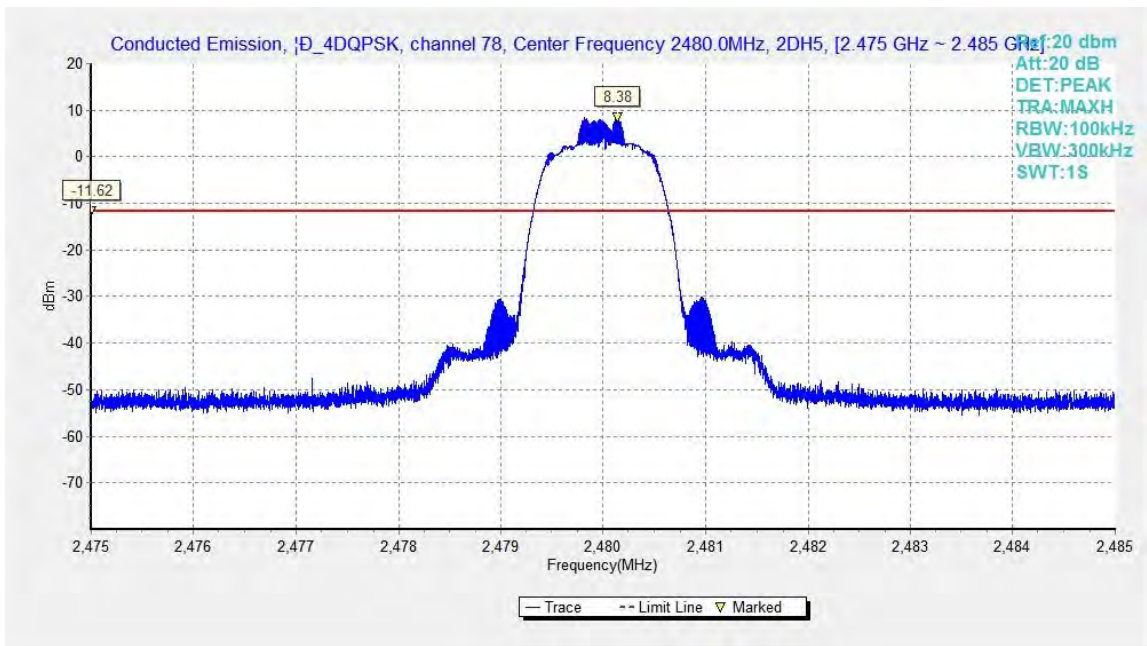

Fig.44. Conducted spurious emission:  $\pi/4$  DQPSK, Channel 78, 2480MHz

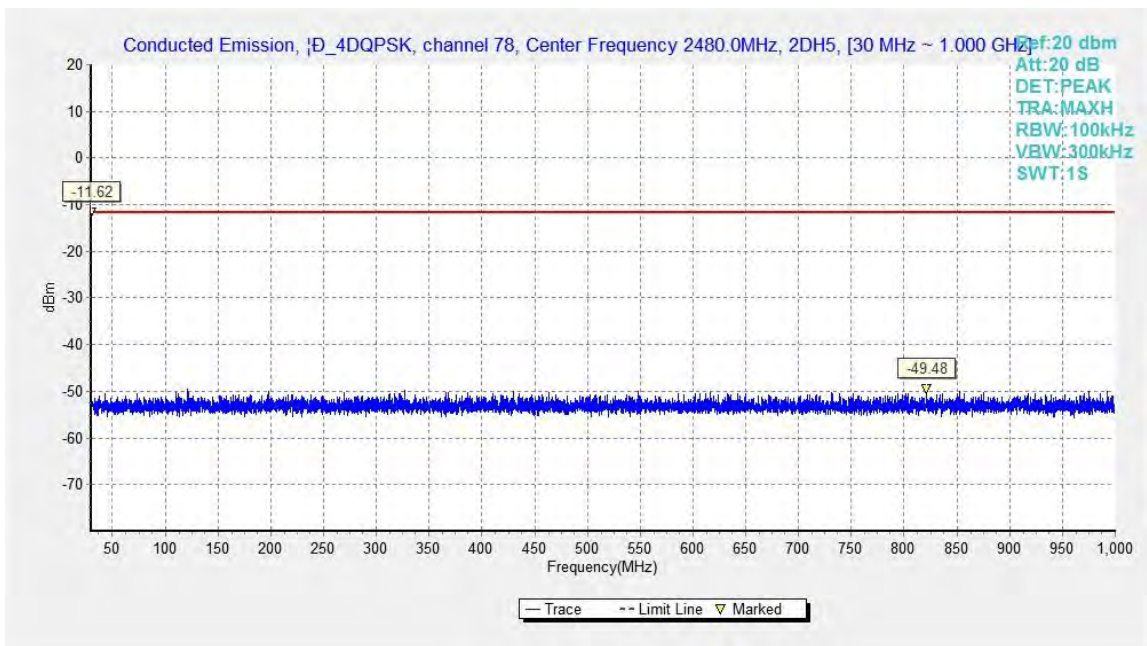

Fig.45. Conducted spurious emission:  $\pi/4$  DQPSK, Channel 78, 30MHz - 1GHz

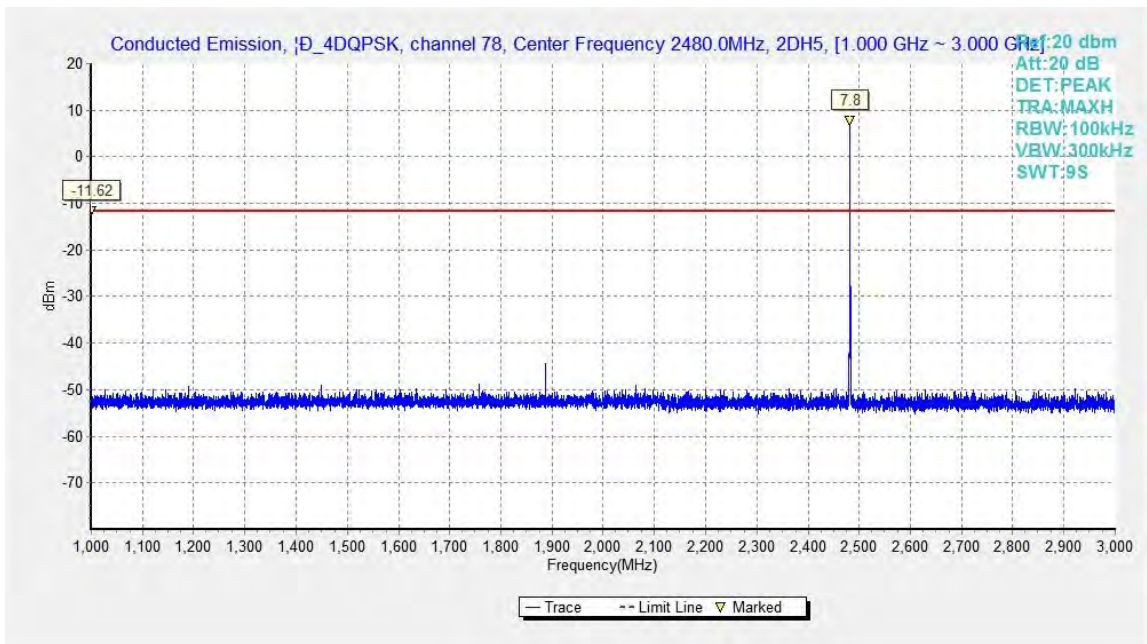

Fig.46. Conducted spurious emission:  $\pi/4$  DQPSK, Channel 78, 1GHz - 3GHz

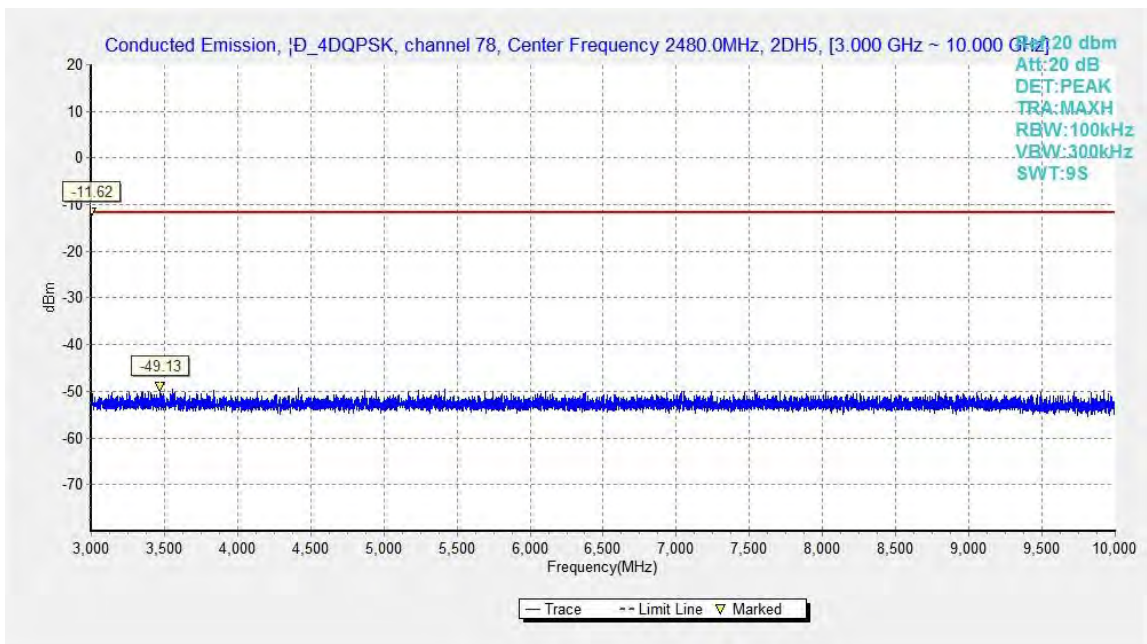

Fig.47. Conducted spurious emission:  $\pi/4$  DQPSK, Channel 78, 3GHz - 10GHz

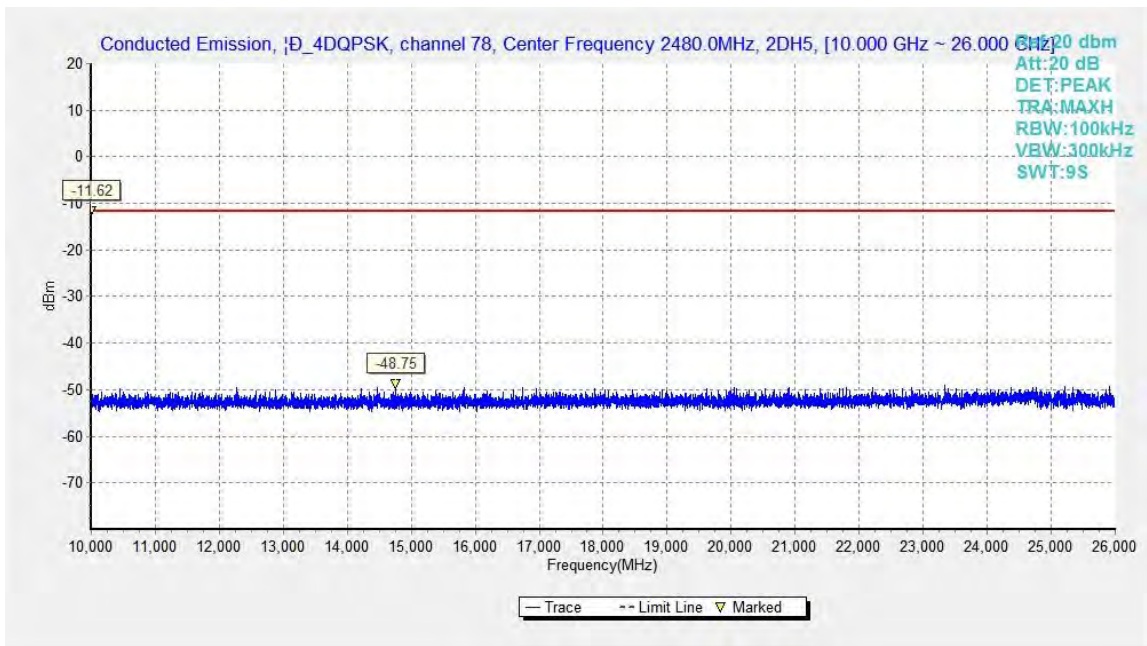

Fig.48. Conducted spurious emission:  $\pi/4$  DQPSK, Channel 78, 10GHz - 26GHz

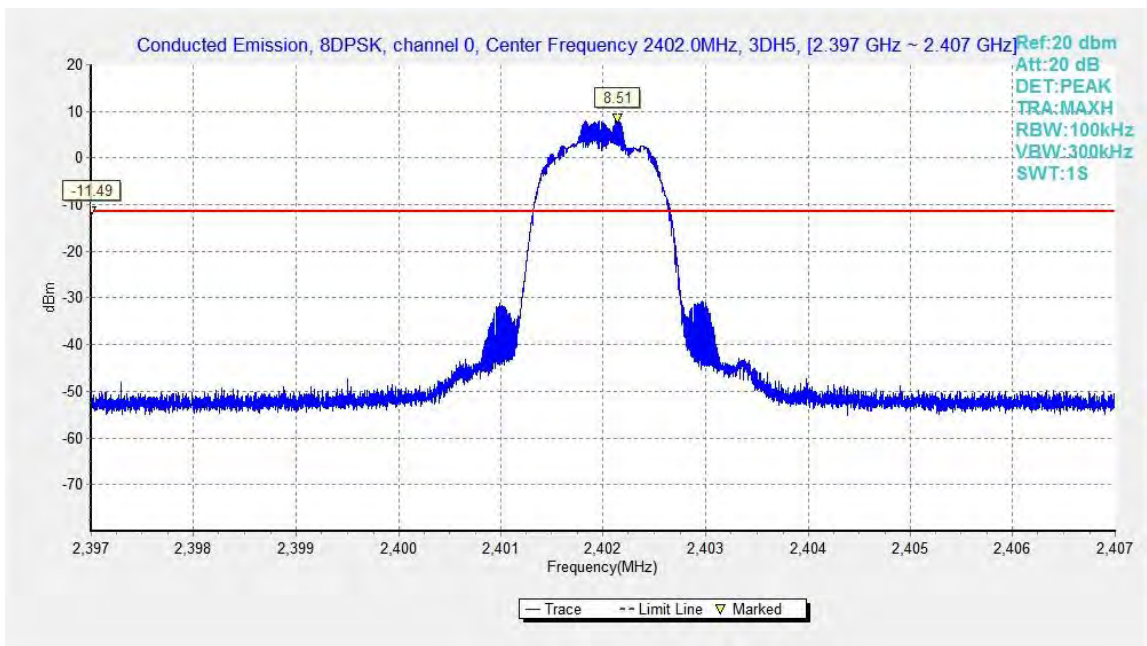

Fig.49. Conducted spurious emission: 8DPSK, Channel 0, 2402MHz



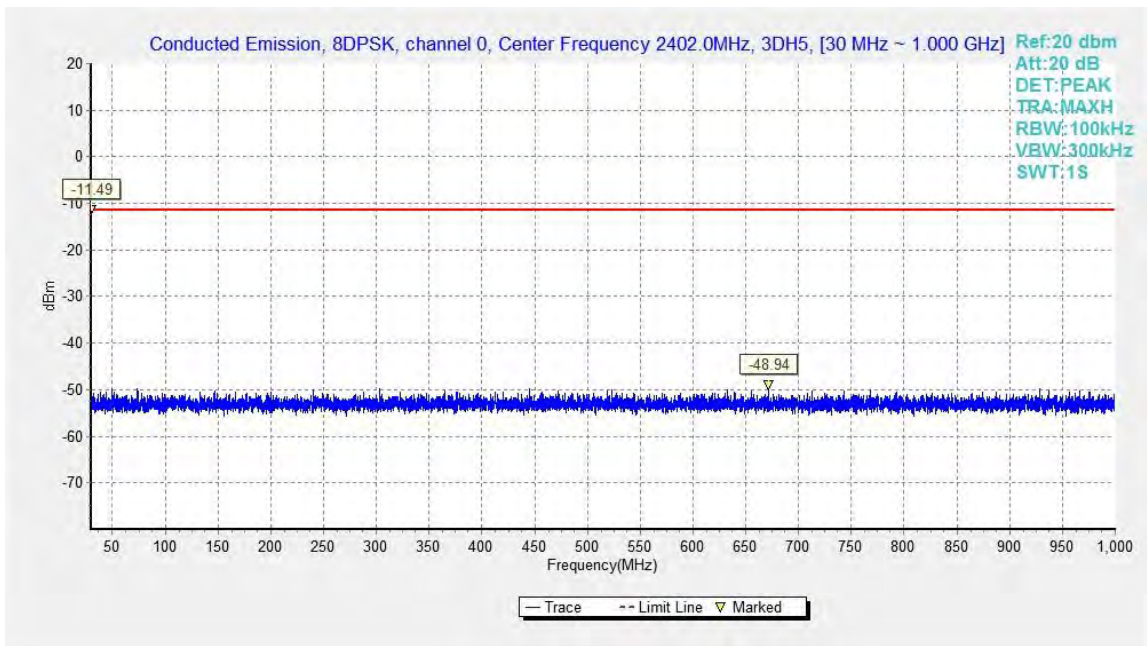

Fig.50. Conducted spurious emission: 8DPSK, Channel 0, 30MHz - 1GHz

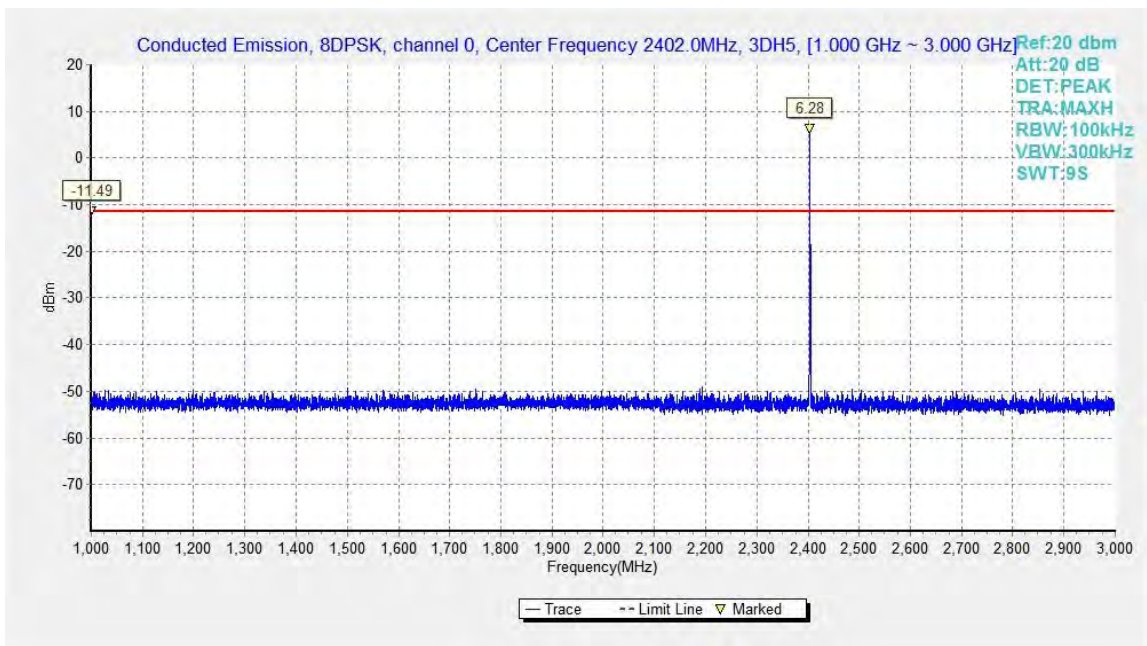

Fig.51. Conducted spurious emission: 8DPSK, Channel 0, 1GHz - 3GHz

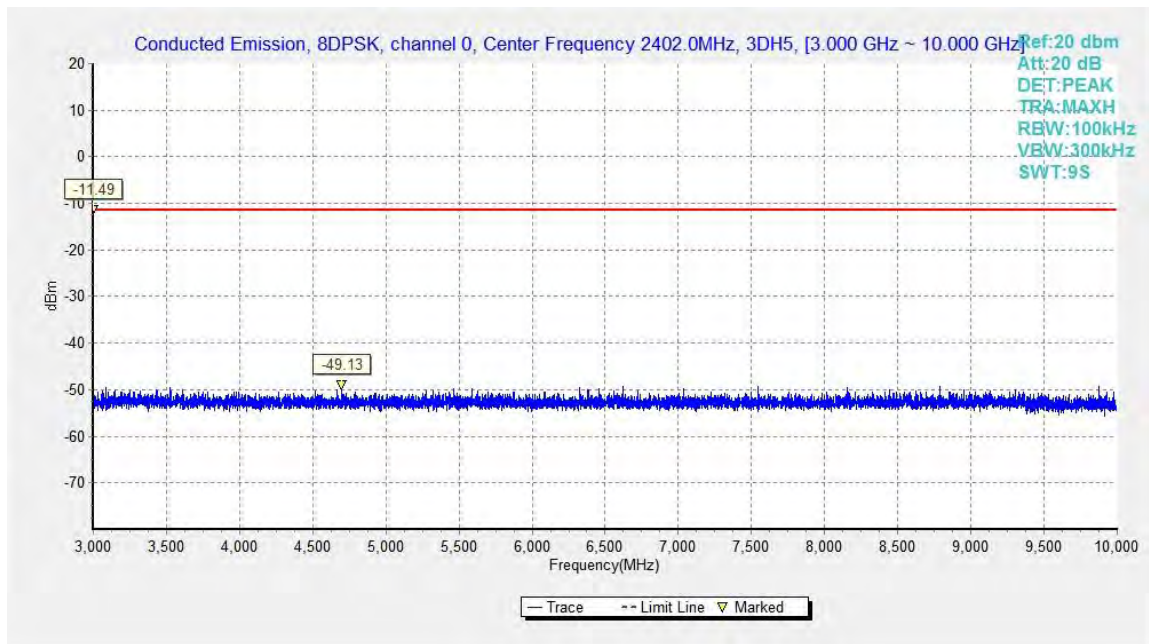

Fig.52. Conducted spurious emission: 8DPSK, Channel 0, 3GHz - 10GHz

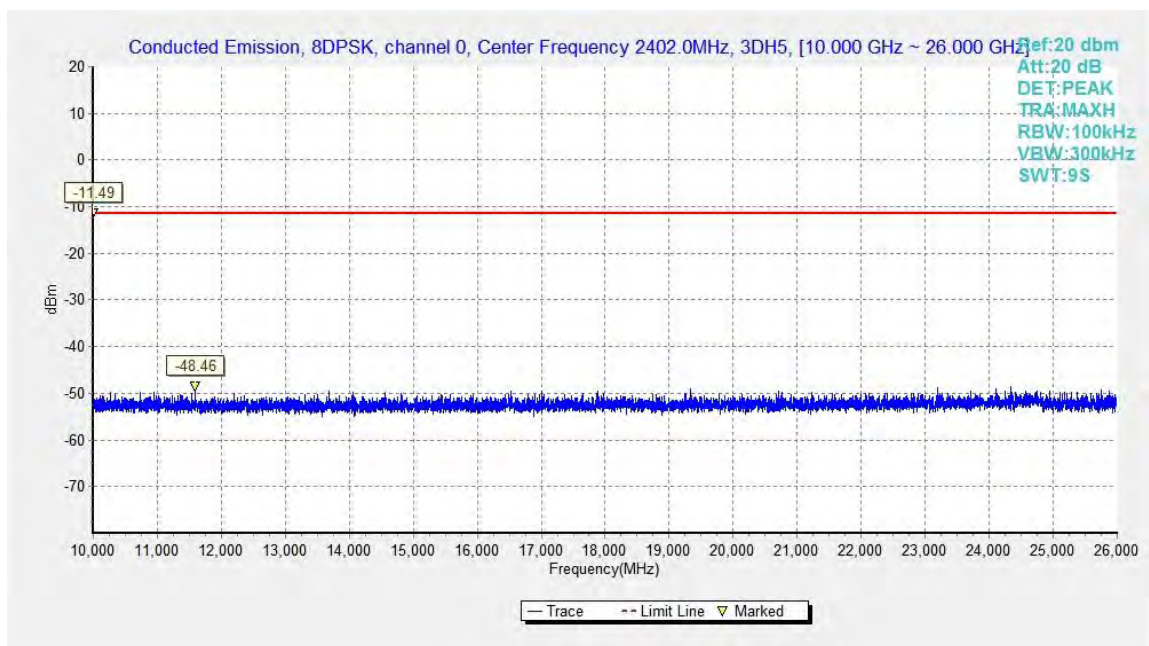

Fig.53. Conducted spurious emission: 8DPSK, Channel 0, 10GHz - 26GHz

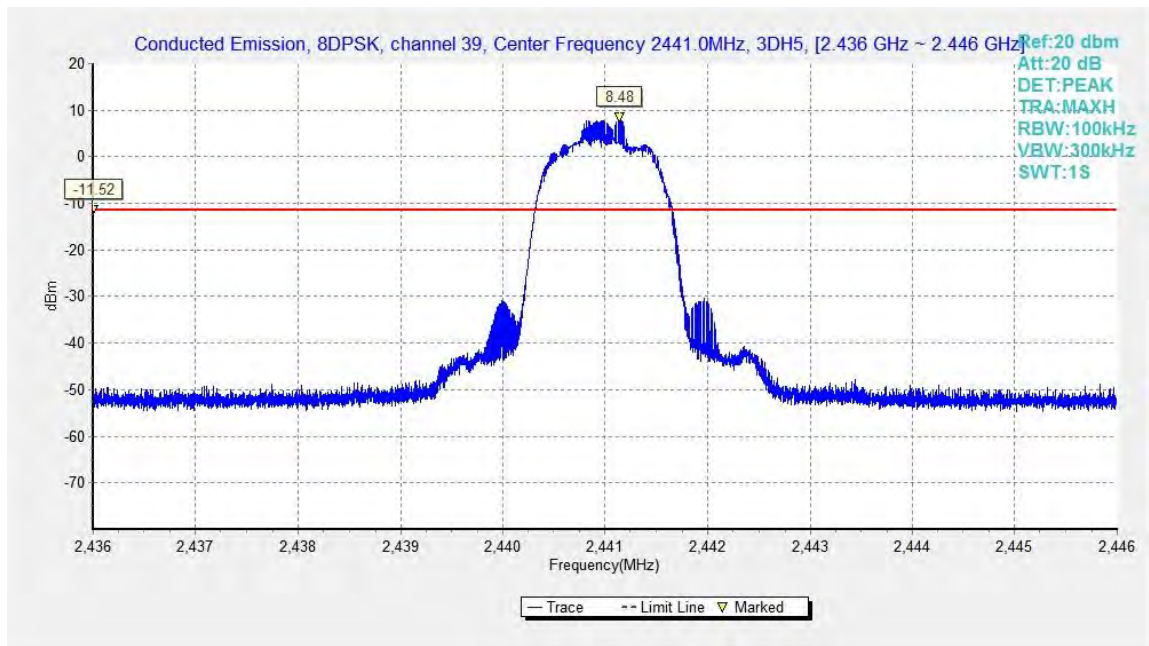

Fig.54. Conducted spurious emission: 8DPSK, Channel 39, 2441MHz

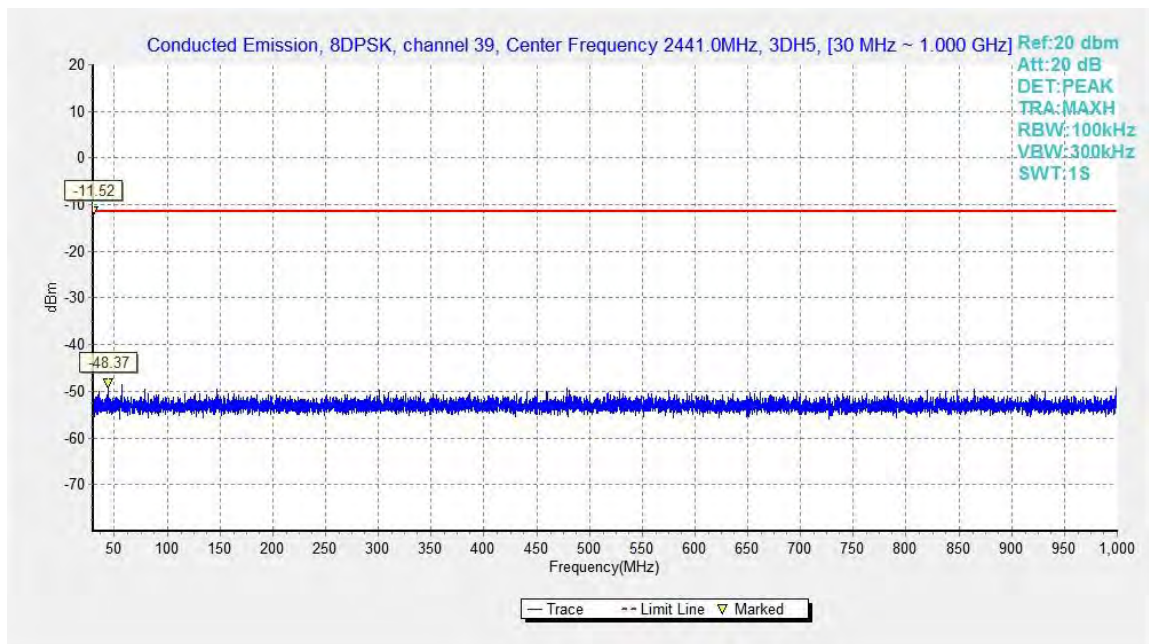

Fig.55. Conducted spurious emission: 8DPSK, Channel 39, 30MHz - 1GHz

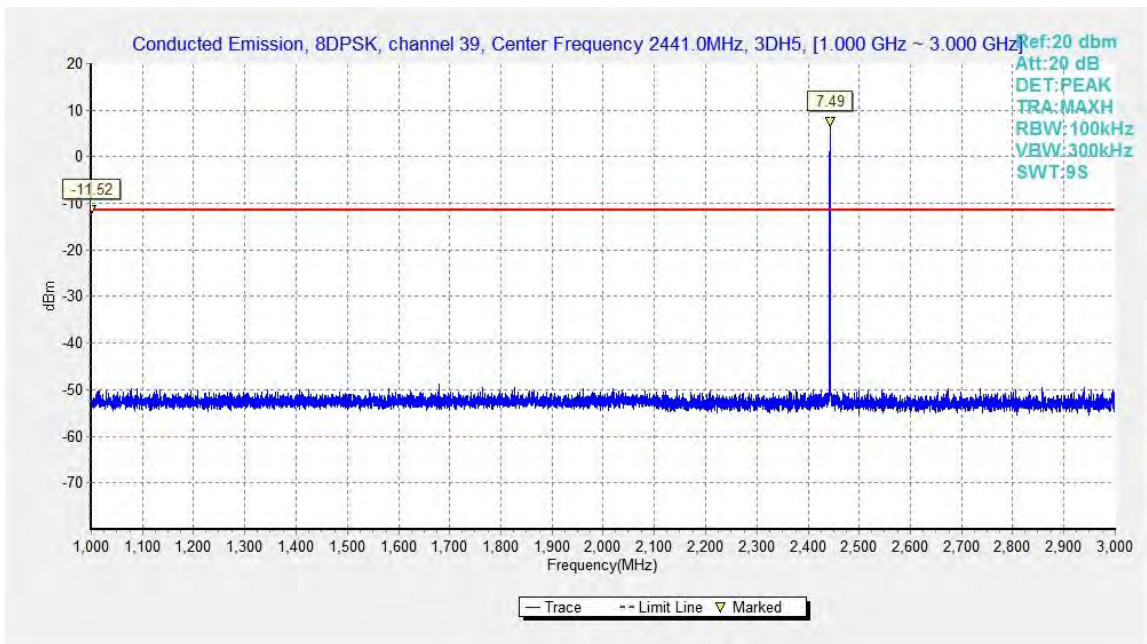

Fig.56. Conducted spurious emission: 8DPSK, Channel 39, 1GHz - 3GHz

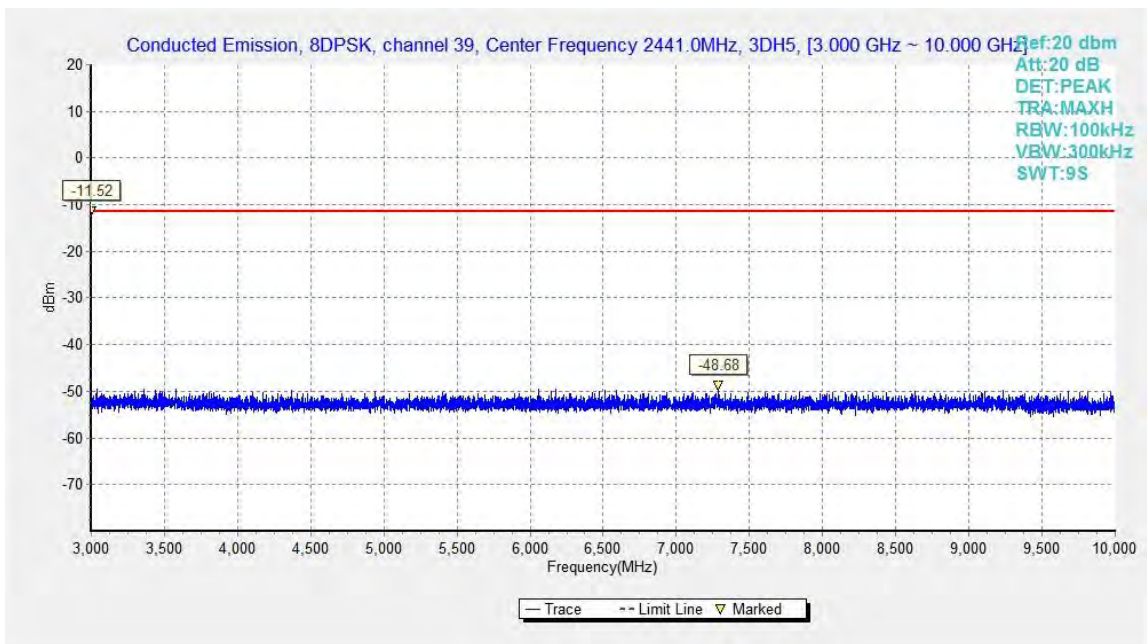

Fig.57. Conducted spurious emission: 8DPSK, Channel 39, 3GHz - 10GHz

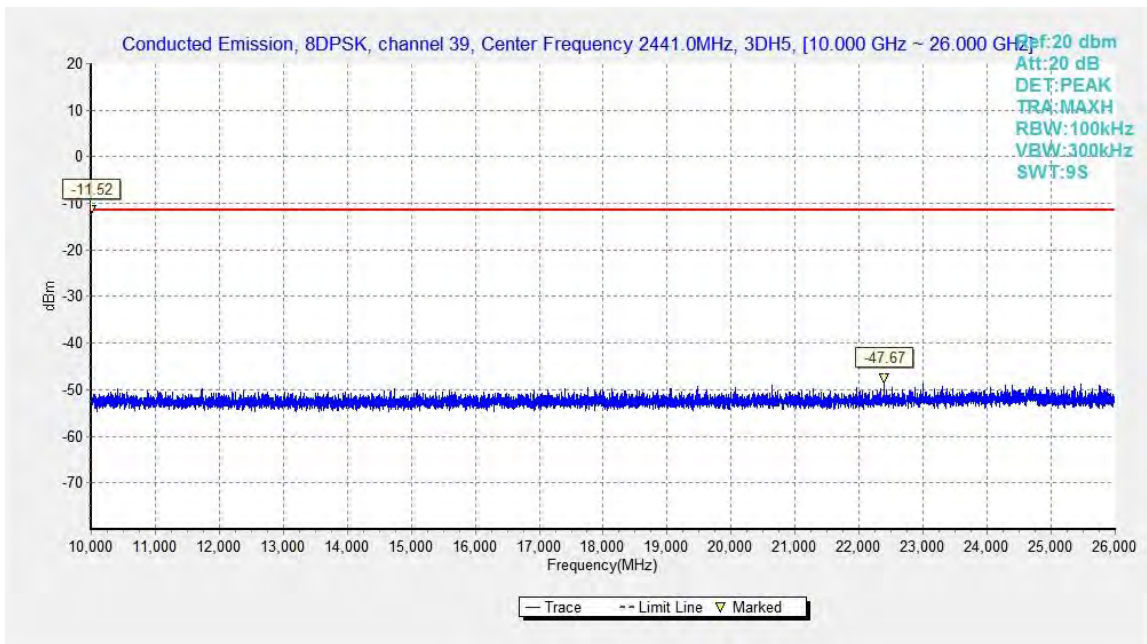

Fig.58. Conducted spurious emission: 8DPSK, Channel 39, 10GHz – 26GHz

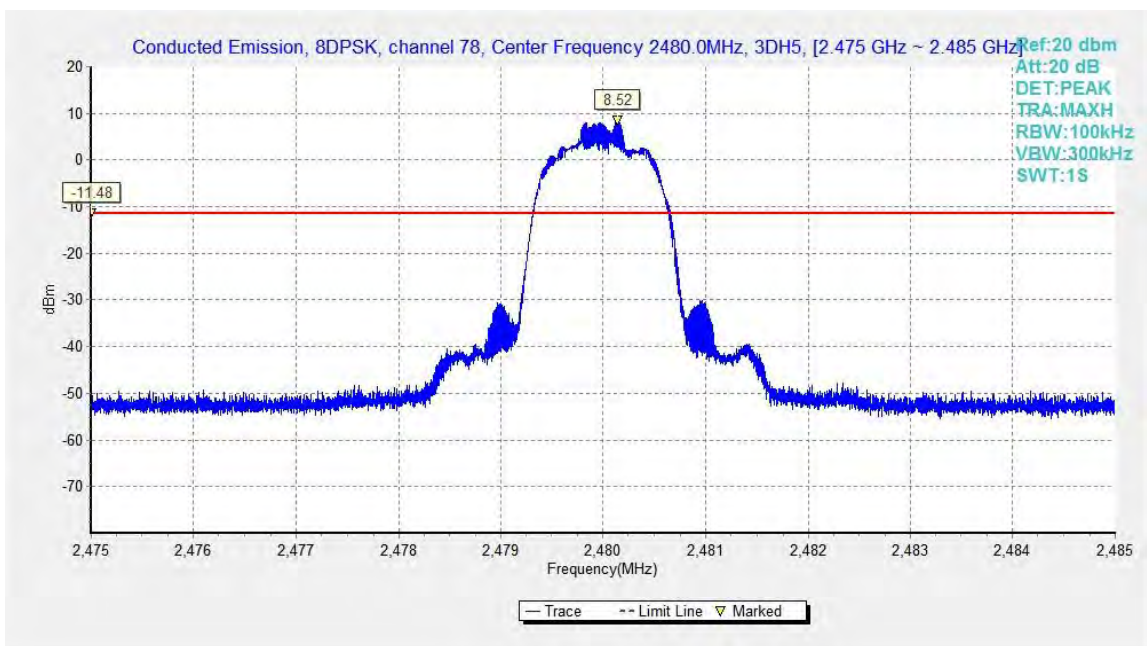

Fig.59. Conducted spurious emission: 8DPSK, Channel 78, 2480MHz

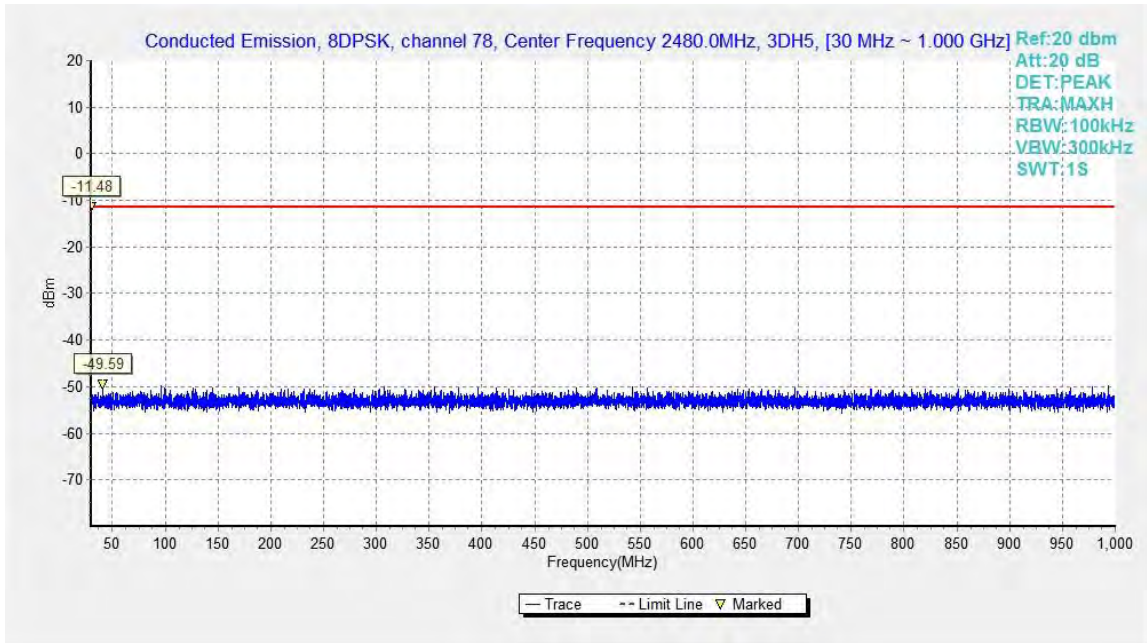

Fig.60. Conducted spurious emission: 8DPSK, Channel 78, 30MHz - 1GHz

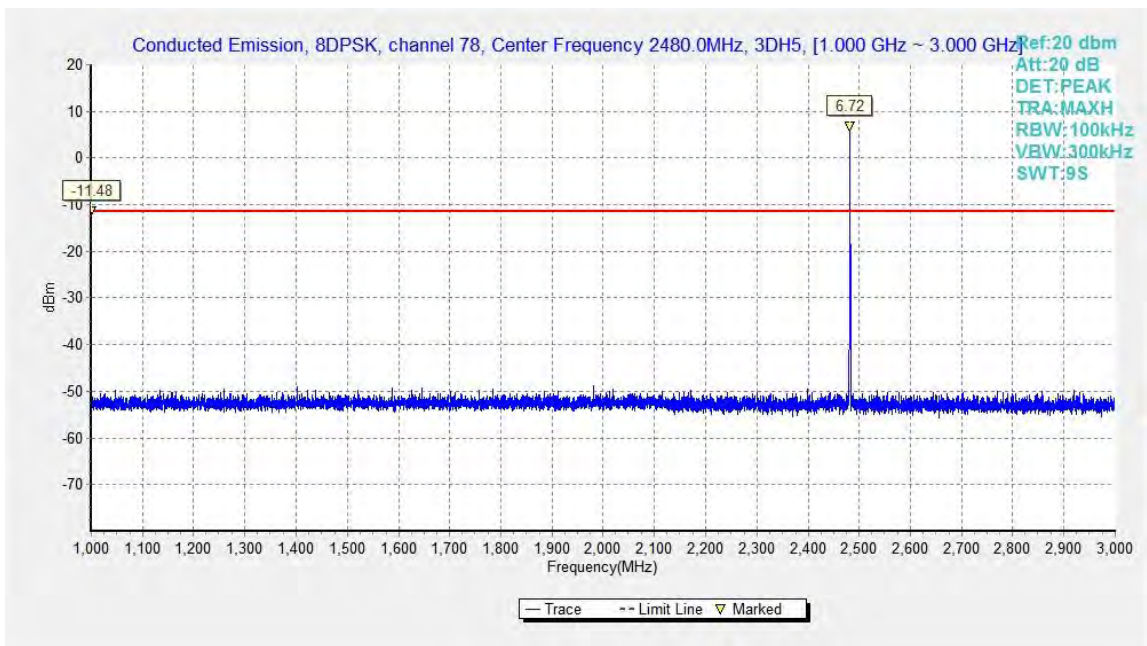

Fig.61. Conducted spurious emission: 8DPSK, Channel 78, 1GHz - 3GHz

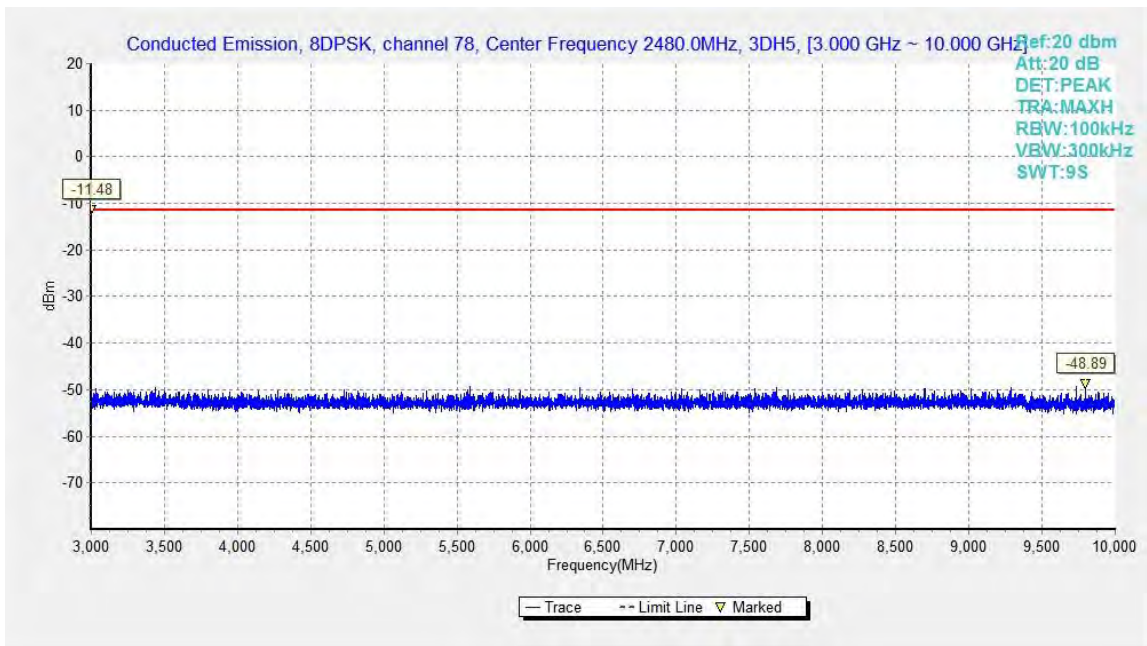

Fig.62. Conducted spurious emission: 8DPSK, Channel 78, 3GHz - 10GHz

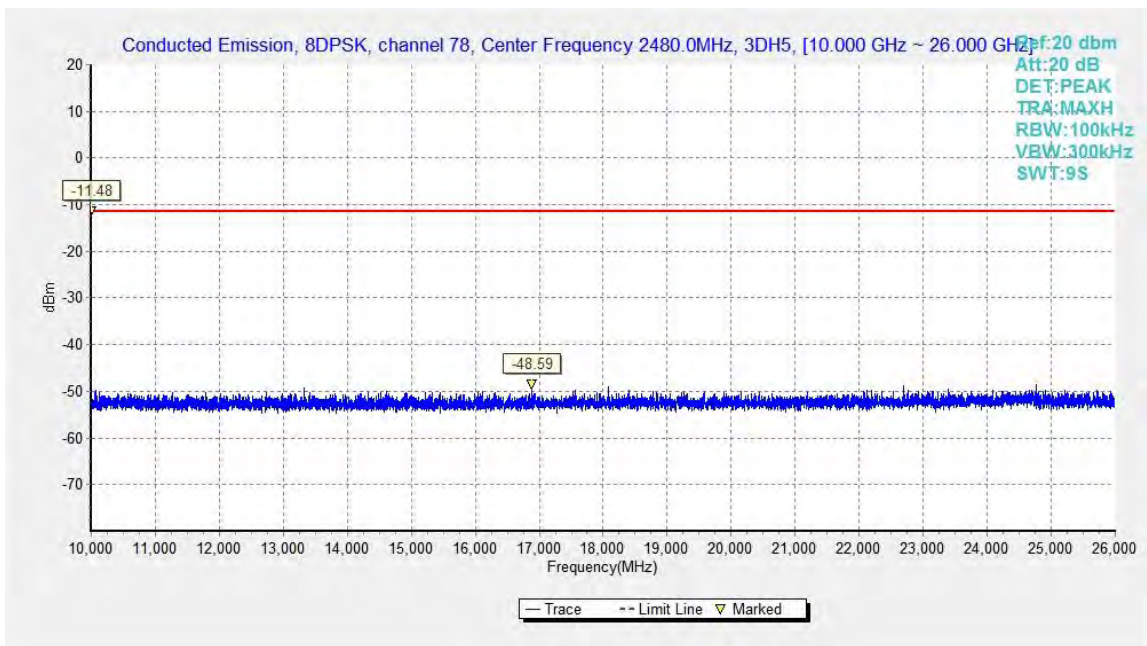

Fig.63. Conducted spurious emission: 8DPSK, Channel 78, 10GHz - 26GHz

## B.6. Transmitter Spurious Emission - Radiated

**Method of Measurement:** See ANSI C63.10-2013-clause 6.4 & 6.5 & 6.6

**Measurement Limit:**

Standard	Limit
FCC 47 CFR Part 15.247, 15.205, 15.209	20dB below peak output power

radiated emissions which fall in the restricted bands, as defined in § 15.205(a), must also comply with the radiated emission limits specified in § 15.209(a) (see § 15.205(c)).

**Limit in restricted band:**

Frequency (MHz)	Field strength( $\mu$ V/m)	Measurement distance (m)
0.009 - 0.490	2400/F(kHz)	300
0.490 - 1.705	24000/F(kHz)	30
1.705 – 30.0	30	30

Frequency of emission (MHz)	Field strength(uV/m)	Field strength(dBuV/m)
30-88	100	40
88-216	150	43.5
216-960	200	46
Above 960	500	54

**Set up:**

Tabletop devices shall be placed on a nonconducting platform with nominal top surface dimensions 1 m by 1.5 m. For emissions testing at or below 1 GHz, the table height shall be 80 cm above the reference ground plane. For emission measurements above 1 GHz, the table height shall be 1.5 m

The EUT and transmitting antenna shall be centered on the turntable.



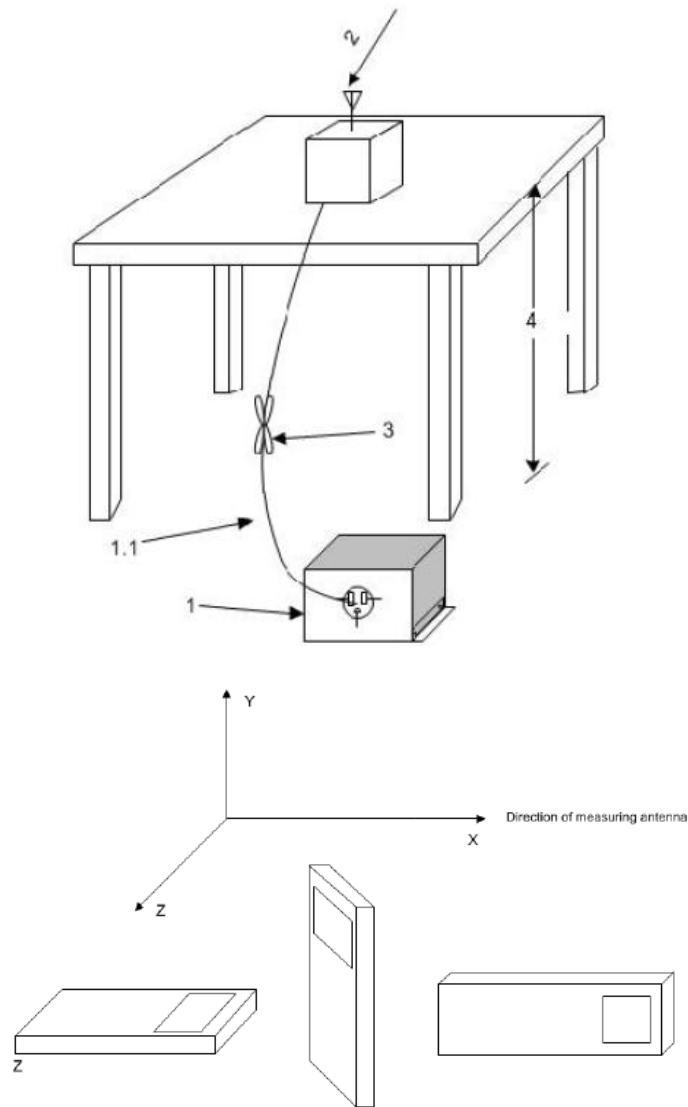

### Test Condition

The EUT shall be tested 1 near top, 1 near middle, and 1 near bottom. Set the unlicensed wireless device to operate in continuous transmit mode. For unlicensed wireless devices unable to be configured for 100% duty cycle even in test mode, configure the system for the maximum duty cycle supported.

When required for unlicensed wireless devices, measurements of the variation of the input power or the radiated signal level of the fundamental frequency component of the emission, as appropriate, shall be performed with the supply voltage varied between 85% and 115% of the nominal rated supply voltage.

### Exploratory radiated emissions measurements

Exploratory radiated measurements shall be performed at the measurement distance or at a closer distance than that specified for compliance to determine the emission characteristics of the EUT and, if applicable, the EUT configuration that produces the maximum level of emissions. The frequencies of maximum emission may be determined by manually positioning the antenna close to the EUT, and then moving the antenna over all sides of the EUT while observing a spectral display. It is advantageous to have prior knowledge of the frequencies of emissions, although this

may be determined from such a near-field scan. The near-field scan shall only be used to determine the frequency but not the amplitude of the emissions. Where exploratory measurements are not adequate to determine the worst-case operating modes and are used only to identify the frequencies of the highest emissions, additional preliminary tests can be required.

For emissions from the EUT, the maximum level shall be determined by rotating the EUT and its antenna through 0° to 360°. For each mode of operation required to be tested, the frequency spectrum (based on findings from exploratory measurements) shall be monitored.

Broadband antennas and a spectrum analyzer or a radio-noise meter with a panoramic display are often useful in this type of test. If either antenna height or EUT azimuth are not fully measured during exploratory testing, then complete testing can be required at the OATS or semi-anechoic chamber when the final full spectrum testing is performed.

### Final radiated emissions measurements

The final measurements are using the orientation and equipment arrangement of the EUT based on the measurement results found during the preliminary (exploratory) measurements, the EUT arrangement, appropriate modulation, and modes of operation that produce the emissions that have the highest amplitude relative to the limit shall be selected for the final measurement.

For each mode of operation required to be tested, the frequency spectrum (based on findings from exploratory measurements) shall be monitored. The highest signal levels relative to the limit shall be determined by rotating the EUT from 0° to 360° and with varying the measurement antenna height between 1 m and 4 m in vertical and horizontal polarizations.

For each mode selected, record the frequency and amplitude of the highest fundamental emission (if applicable), as well as the frequency and amplitude of the six highest spurious emissions relative to the limit. Emissions more than 20 dB below the limit do not need to be reported.

This maximization process was repeated with the EUT positioned in each of its three orthogonal orientations.

### The receiver references:

Frequency of emission (MHz)	RBW/VBW	Sweep Time(s)
30-1000	100kHz/300kHz	5
1000-4000	1MHz/3MHz	15
4000-18000	1MHz/3MHz	40
18000-26500	1MHz/3MHz	20

$P_{Mea}$  is the field strength recorded from the instrument.

The measurement results are obtained as described below:

Result=  $P_{Mea}$  + Cable Loss + Antenna Factor

Where:

$P_{Mea}$  field strength recorded from the instrument

**Peak Measurement results**
**GFSK Ch 0**

Frequency (MHz)	Measurement Result (dBuV/m)	Cable Loss (dB)	Antenna Factor (dB/m)	Receiver Reading (dBuV)	Limit (dBuV/m)	Margin (dB)	Antenna Pol. (H/V)
2385.362	54.62	4.60	31.70	18.32	74.00	19.38	0.00
2389.128	54.46	4.61	31.75	18.09	74.00	19.54	0.00
4804.500	43.66	-36.03	33.80	45.90	74.00	30.34	0.00
7206.000	43.50	-34.58	35.42	42.65	74.00	30.51	0.00
9608.000	44.24	-33.50	36.72	41.02	74.00	29.76	0.00
12010.000	46.72	-31.69	38.81	39.61	74.00	27.28	0.00

**GFSK Ch 39**

Frequency (MHz)	Measurement Result (dBuV/m)	Cable Loss (dB)	Antenna Factor (dB/m)	Receiver Reading (dBuV)	Limit (dBuV/m)	Margin (dB)	Antenna Pol. (H/V)
2375.400	44.62	-36.65	31.56	49.71	74.00	29.38	0.00
2501.400	46.16	-36.53	32.20	49.71	74.00	27.84	0.00
4881.500	46.31	-35.77	33.80	48.28	74.00	27.69	0.00
7323.000	44.51	-34.21	35.55	43.17	74.00	29.49	0.00
9764.000	43.31	-33.57	37.03	39.85	74.00	30.69	0.00
12205.000	46.47	-31.58	38.80	39.25	74.00	27.53	0.00

**GFSK Ch 78**

Frequency (MHz)	Measurement Result (dBuV/m)	Cable Loss (dB)	Antenna Factor (dB/m)	Receiver Reading (dBuV)	Limit (dBuV/m)	Margin (dB)	Antenna Pol. (H/V)
2483.645	66.53	4.65	32.14	29.74	74.00	7.47	0.00
2483.750	66.81	4.65	32.14	30.02	74.00	7.19	0.00
4959.500	46.28	-35.60	33.88	48.00	74.00	27.72	0.00
7440.000	41.62	-34.17	35.50	40.29	74.00	32.38	0.00
9920.000	44.16	-33.25	37.14	40.27	74.00	29.84	0.00
12400.000	45.60	-31.25	38.90	37.95	74.00	28.41	0.00

**$\pi/4$  DQPSK Ch 0**

Frequency (MHz)	Measurement Result (dBuV/m)	Cable Loss (dB)	Antenna Factor (dB/m)	Receiver Reading (dBuV)	Limit (dBuV/m)	Margin (dB)	Antenna Pol. (H/V)
2386.860	55.09	4.61	31.72	18.77	74.00	18.91	0.00
2389.310	54.85	4.61	31.75	18.49	74.00	19.15	0.00
4804.000	42.44	-36.04	33.80	44.68	74.00	31.56	0.00
7206.000	41.59	-34.58	35.42	40.75	74.00	32.41	0.00
9608.000	43.79	-33.50	36.72	40.57	74.00	30.21	0.00
12010.000	45.79	-31.69	38.81	38.67	74.00	28.21	0.00

 **$\pi/4$  DQPSK Ch 39**

Frequency (MHz)	Measurement Result (dBuV/m)	Cable Loss (dB)	Antenna Factor (dB/m)	Receiver Reading (dBuV)	Limit (dBuV/m)	Margin (dB)	Antenna Pol. (H/V)
2371.200	44.72	-36.74	31.50	49.71	74.00	29.28	0.00
2500.400	46.20	-36.51	32.20	49.71	74.00	27.80	0.00
4882.000	44.53	-35.77	33.80	46.50	74.00	29.47	0.00
7323.000	42.48	-34.21	35.55	41.14	74.00	31.52	0.00
9764.000	43.87	-33.57	37.03	40.41	74.00	30.13	0.00
12205.000	45.58	-31.58	38.80	38.36	74.00	28.42	0.00

 **$\pi/4$  DQPSK Ch 78**

Frequency (MHz)	Measurement Result (dBuV/m)	Cable Loss (dB)	Antenna Factor (dB/m)	Receiver Reading (dBuV)	Limit (dBuV/m)	Margin (dB)	Antenna Pol. (H/V)
2484.120	58.54	4.65	32.14	21.76	74.00	15.46	V
2489.275	57.54	4.64	32.16	20.74	74.00	16.46	V
4959.500	44.82	-35.60	33.88	46.55	74.00	29.18	H
7440.000	42.56	-34.17	35.50	41.23	74.00	31.44	H
9920.000	44.23	-33.25	37.14	40.34	74.00	29.77	H
12400.000	45.60	-31.25	38.90	37.95	74.00	28.40	V

**8DPSK Ch 0**

Frequency (MHz)	Measurement Result (dBuV/m)	Cable Loss (dB)	Antenna Factor (dB/m)	Receiver Reading (dBuV)	Limit (dBuV/m)	Margin (dB)	Antenna Pol. (H/V)
2385.600	55.26	4.60	31.70	18.95	74.00	18.74	V
2386.944	54.53	4.61	31.72	18.20	74.00	19.47	H
4804.000	42.46	-36.04	33.80	44.69	74.00	31.54	V
7206.000	42.00	-34.58	35.42	41.16	74.00	32.00	H
9608.000	44.12	-33.50	36.72	40.90	74.00	29.88	H
12010.000	46.13	-31.69	38.81	39.01	74.00	27.87	V

**8DPSK Ch 39**

Frequency (MHz)	Measurement Result (dBuV/m)	Cable Loss (dB)	Antenna Factor (dB/m)	Receiver Reading (dBuV)	Limit (dBuV/m)	Margin (dB)	Antenna Pol. (H/V)
2376.000	44.97	-36.63	31.57	49.71	74.00	29.03	V
2499.000	45.79	-36.48	32.20	49.71	74.00	28.22	H
4882.500	44.39	-35.77	33.80	46.36	74.00	29.61	V
7323.000	42.72	-34.21	35.55	41.37	74.00	31.29	V
9764.000	44.13	-33.57	37.03	40.67	74.00	29.87	V
12205.000	45.34	-31.58	38.80	38.12	74.00	28.66	H

**8DPSK Ch 78**

Frequency (MHz)	Measurement Result (dBuV/m)	Cable Loss (dB)	Antenna Factor (dB/m)	Receiver Reading (dBuV)	Limit (dBuV/m)	Margin (dB)	Antenna Pol. (H/V)
2486.050	60.69	4.65	32.14	23.90	74.00	13.31	H
2486.235	57.03	4.65	32.15	20.24	74.00	16.97	H
4960.000	42.13	-35.60	33.88	43.85	74.00	31.87	H
7440.000	42.46	-34.17	35.50	41.13	74.00	31.54	V
9920.000	43.85	-33.25	37.14	39.95	74.00	30.15	V
12400.000	47.18	-31.25	38.90	39.53	74.00	26.83	H

**Average Measurement results**
**GFSK Ch 0**

Frequency (MHz)	Measurement Result (dBuV/m)	Cable Loss (dB)	Antenna Factor (dB/m)	Receiver Reading (dBuV)	Limit (dBuV/m)	Margin (dB)	Antenna Pol. (H/V)
2387.663	40.30	4.61	31.73	3.96	54.00	13.71	V
2389.500	40.31	4.61	31.75	3.95	54.00	13.69	V
4803.700	35.49	-36.04	33.80	37.72	54.00	18.51	V
7206.100	30.49	-34.58	35.42	29.65	54.00	23.51	V
9607.900	32.05	-33.50	36.72	28.83	54.00	21.95	V
12010.000	34.10	-31.69	38.81	26.98	54.00	19.90	H

**GFSK Ch 39**

Frequency (MHz)	Measurement Result (dBuV/m)	Cable Loss (dB)	Antenna Factor (dB/m)	Receiver Reading (dBuV)	Limit (dBuV/m)	Margin (dB)	Antenna Pol. (H/V)
2483.713	42.44	4.65	27.87	9.92	54.00	11.56	V
2444.850	42.41	4.67	27.58	10.16	54.00	11.59	V
4882.167	38.42	-35.77	33.80	40.39	54.00	15.58	H
7323.100	31.00	-34.21	35.55	29.66	54.00	23.00	H
9763.900	31.65	-33.57	37.03	28.19	54.00	22.35	H
12205.000	33.67	-31.58	38.80	26.45	54.00	20.33	H

**GFSK Ch 78**

Frequency (MHz)	Measurement Result (dBuV/m)	Cable Loss (dB)	Antenna Factor (dB/m)	Receiver Reading (dBuV)	Limit (dBuV/m)	Margin (dB)	Antenna Pol. (H/V)
2483.850	43.09	4.65	32.14	6.30	54.00	10.91	V
2484.188	43.06	4.65	32.14	6.27	54.00	10.94	V
4959.700	39.76	-35.60	33.88	41.48	54.00	14.24	V
7440.100	30.07	-34.17	35.50	28.74	54.00	23.93	H
9919.900	32.12	-33.25	37.14	28.22	54.00	21.89	V
12400.000	34.07	-31.25	38.90	26.42	54.00	19.93	V

**$\pi/4$  DQPSK Ch 0**

Frequency (MHz)	Measurement Result (dBuV/m)	Cable Loss (dB)	Antenna Factor (dB/m)	Receiver Reading (dBuV)	Limit (dBuV/m)	Margin (dB)	Antenna Pol. (H/V)
2387.100	40.28	4.61	31.72	3.95	54.00	13.72	V
2389.463	40.25	4.61	31.75	3.89	54.00	13.75	V
4803.400	30.26	-36.04	33.80	32.50	54.00	23.74	V
7206.100	30.29	-34.58	35.42	29.45	54.00	23.71	H
9607.900	31.87	-33.50	36.72	28.65	54.00	22.13	H
12010.000	33.92	-31.69	38.81	26.81	54.00	20.08	V

 **$\pi/4$  DQPSK Ch 39**

Frequency (MHz)	Measurement Result (dBuV/m)	Cable Loss (dB)	Antenna Factor (dB/m)	Receiver Reading (dBuV)	Limit (dBuV/m)	Margin (dB)	Antenna Pol. (H/V)
2483.550	42.46	4.65	27.87	9.94	54.00	11.54	V
2483.775	42.49	4.65	27.87	9.96	54.00	11.52	V
4882.000	34.78	-35.77	33.80	36.75	54.00	19.22	H
7323.100	30.94	-34.21	35.55	29.60	54.00	23.06	V
9763.900	31.69	-33.57	37.03	28.22	54.00	22.32	H
12205.000	33.60	-31.58	38.80	26.38	54.00	20.40	H

 **$\pi/4$  DQPSK Ch 78**

Frequency (MHz)	Measurement Result (dBuV/m)	Cable Loss (dB)	Antenna Factor (dB/m)	Receiver Reading (dBuV)	Limit (dBuV/m)	Margin (dB)	Antenna Pol. (H/V)
2483.813	43.11	4.65	32.14	6.32	54.00	10.89	V
2484.263	43.05	4.65	32.14	6.26	54.00	10.95	V
4959.700	35.63	-35.60	33.88	37.36	54.00	18.37	V
7440.100	30.16	-34.17	35.50	28.83	54.00	23.84	V
9919.000	32.08	-33.25	37.14	28.18	54.00	21.92	V
12400.000	34.11	-31.25	38.90	26.46	54.00	19.89	V

**8DPSK Ch 0**

Frequency (MHz)	Measurement Result (dBuV/m)	Cable Loss (dB)	Antenna Factor (dB/m)	Receiver Reading (dBuV)	Limit (dBuV/m)	Margin (dB)	Antenna Pol. (H/V)
2388.150	40.26	4.61	31.74	3.92	54.00	13.74	V
2389.650	40.30	4.61	31.76	3.93	54.00	13.70	V
4804.000	31.64	-36.04	33.80	33.88	54.00	22.36	H
7206.100	30.39	-34.58	35.42	29.55	54.00	23.61	V
9607.900	31.90	-33.50	36.72	28.69	54.00	22.10	V
12010.000	33.98	-31.69	38.81	26.87	54.00	20.02	H

**8DPSK Ch 39**

Frequency (MHz)	Measurement Result (dBuV/m)	Cable Loss (dB)	Antenna Factor (dB/m)	Receiver Reading (dBuV)	Limit (dBuV/m)	Margin (dB)	Antenna Pol. (H/V)
2484.375	42.57	4.65	27.88	10.04	54.00	11.43	V
2484.900	42.42	4.65	27.88	9.89	54.00	11.58	V
4882.000	34.99	-35.77	33.80	36.96	54.00	19.01	V
7323.100	30.95	-34.21	35.55	29.61	54.00	23.05	H
9763.900	31.61	-33.57	37.03	28.15	54.00	22.39	H
12205.000	33.56	-31.58	38.80	26.34	54.00	20.44	V

**8DPSK Ch 78**

Frequency (MHz)	Measurement Result (dBuV/m)	Cable Loss (dB)	Antenna Factor (dB/m)	Receiver Reading (dBuV)	Limit (dBuV/m)	Margin (dB)	Antenna Pol. (H/V)
2483.738	43.11	4.65	32.14	6.33	54.00	10.89	V
2484.225	43.13	4.65	32.14	6.34	54.00	10.88	V
4960.000	32.06	-35.60	33.88	33.78	54.00	21.94	H
7440.100	30.00	-34.17	35.50	28.67	54.00	24.00	H
9919.900	32.05	-33.25	37.14	28.16	54.00	21.95	V
12400.000	33.98	-31.25	38.90	26.33	54.00	20.02	H

**Conclusion: Pass**



## B.7. Time of Occupancy (Dwell Time)

### Method of Measurement: See ANSI C63.10-clause 7.8.4

The EUT must have its hopping function enabled. Use the following spectrum analyzer settings:

- Span = zero span, centered on a hopping channel
- RBW = 1 MHz
- VBW  $\geq$  RBW
- Sweep = as necessary to capture the entire dwell time per hopping channel
- Detector function = peak
- Trace = max hold

Measure a pulse time in time domain at middle frequency and then count the hopping number in 31.6s(which equals with 0.4 multiply 79) of middle frequency ,then multiply the pulse time and hopping number and record them.

### Measurement Limit:

Standard	Limit (ms)
FCC 47 CFR Part 15.247(a) (1)(iii)	< 400

### Measurement Result:

#### For GFSK

Channel	Packet	Pulse time (ms)		Number of Transmissions		Dwell Time (ms)	Conclusion
		Fig.	Value	Fig.	Value		
39	DH1	Fig.64	0.38	Fig.65	319	121.22	P
	DH3	Fig.66	1.63	Fig.67	116	189.08	P
	DH5	Fig.68	2.88	Fig.69	65	187.2	P

#### For $\pi/4$ DQPSK

Channel	Packet	Pulse time (ms)		Number of Transmissions		Dwell Time (ms)	Conclusion
		Fig.	Value	Fig.	Value		
39	2DH1	Fig.70	0.38	Fig.71	318	120.84	P
	2DH3	Fig.72	1.64	Fig.73	111	182.04	P
	2DH5	Fig.74	2.89	Fig.75	69	199.41	P

#### For 8DPSK

Channel	Packet	Pulse time (ms)		Number of Transmissions		Dwell Time (ms)	Conclusion
		Fig.	ms	Fig.	Count		
39	3DH1	Fig.76	0.38	Fig.77	321	121.98	P
	3DH3	Fig.78	1.63	Fig.79	108	176.04	P
	3DH5	Fig.80	2.89	Fig.81	64	184.96	P

**Conclusion: PASS**

**Test graphs as below:**

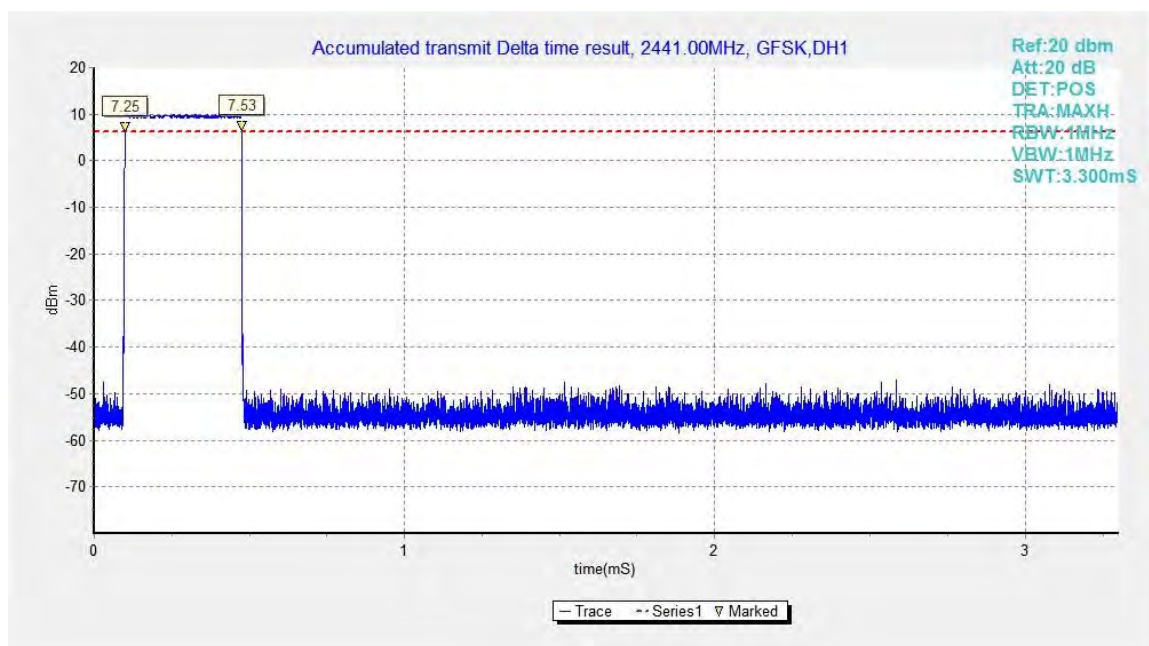

Fig.64. Time of occupancy (Dwell Time): Channel 39, Packet DH1

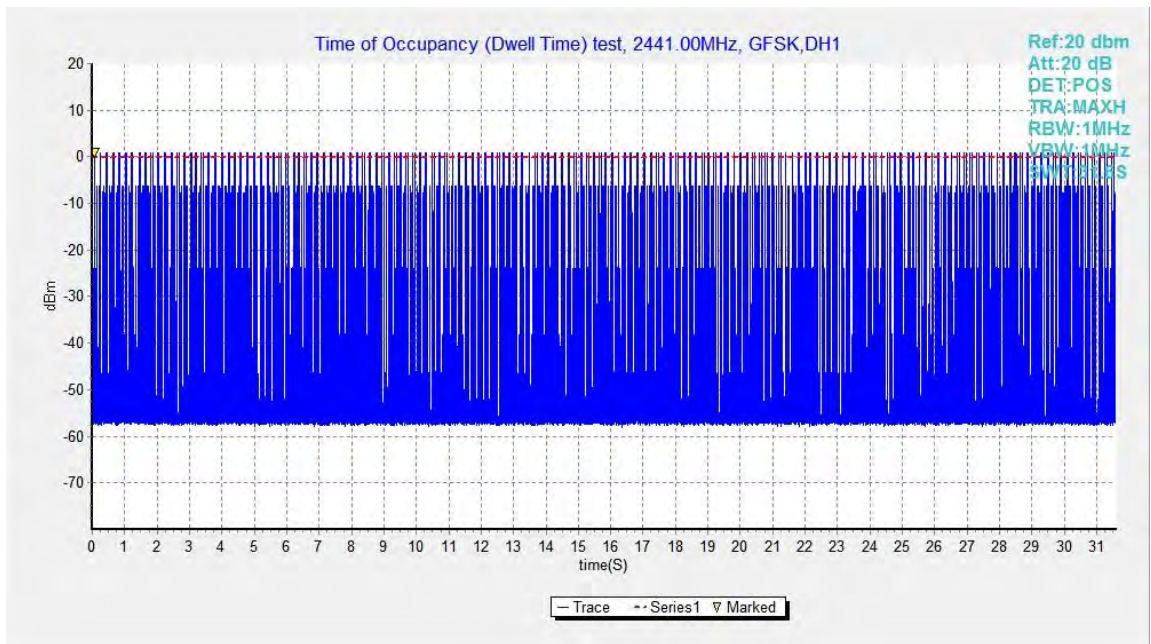

Fig.65. Number of Transmissions Measurement: Channel 39,Packet DH1

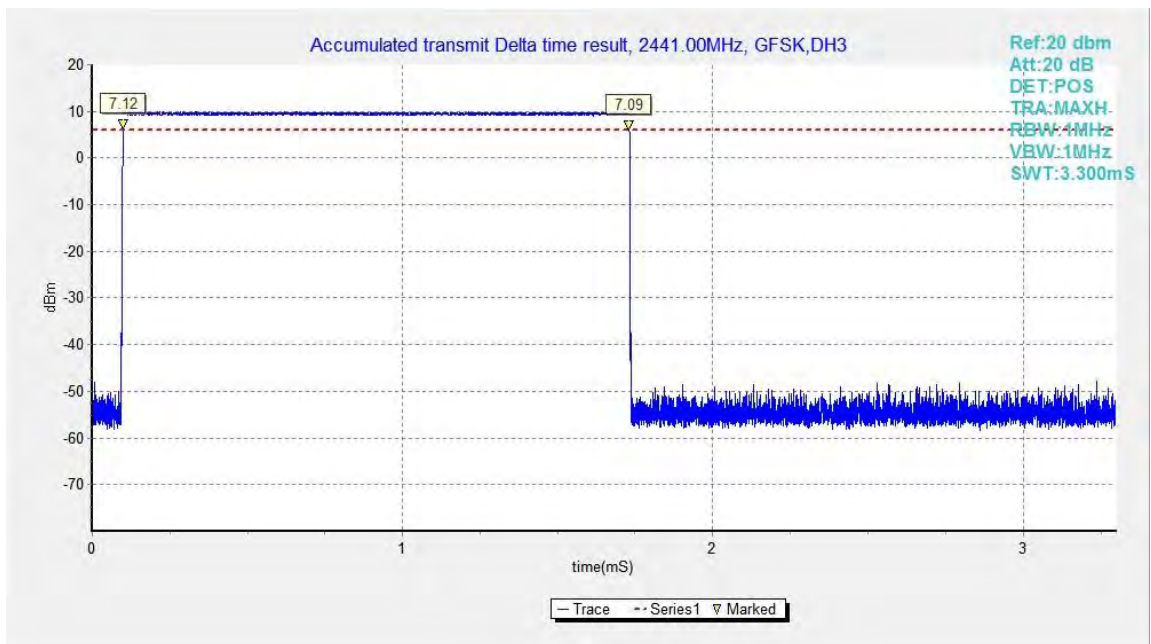

Fig.66. Time of occupancy (Dwell Time): Channel 39, Packet DH3

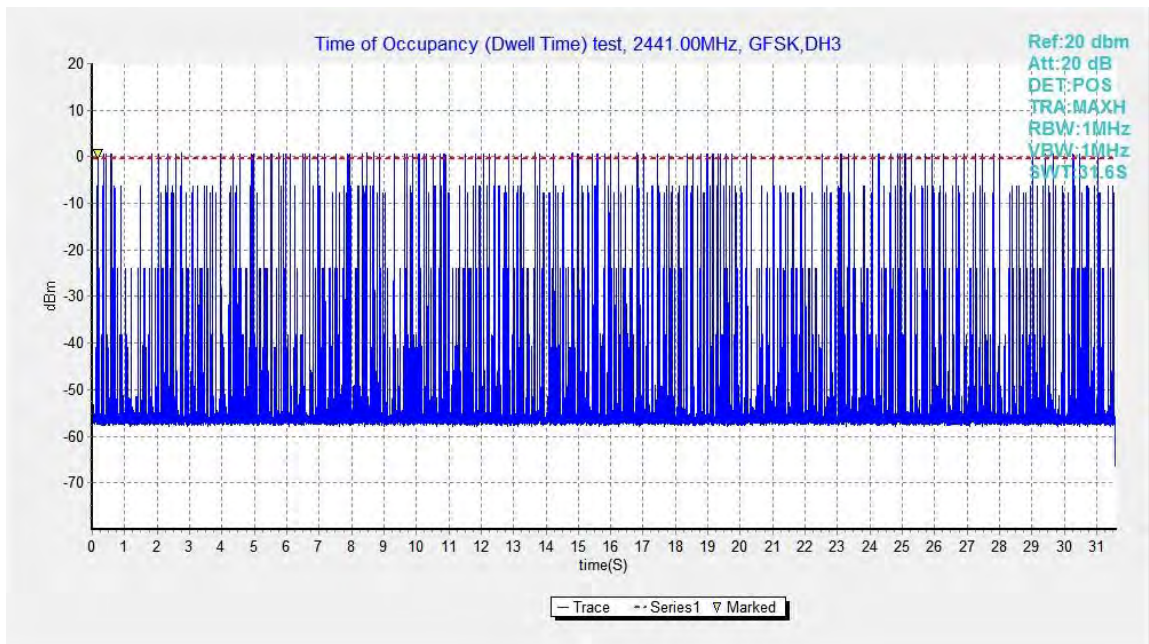

Fig.67. Number of Transmissions Measurement: Channel 39,Packet DH3

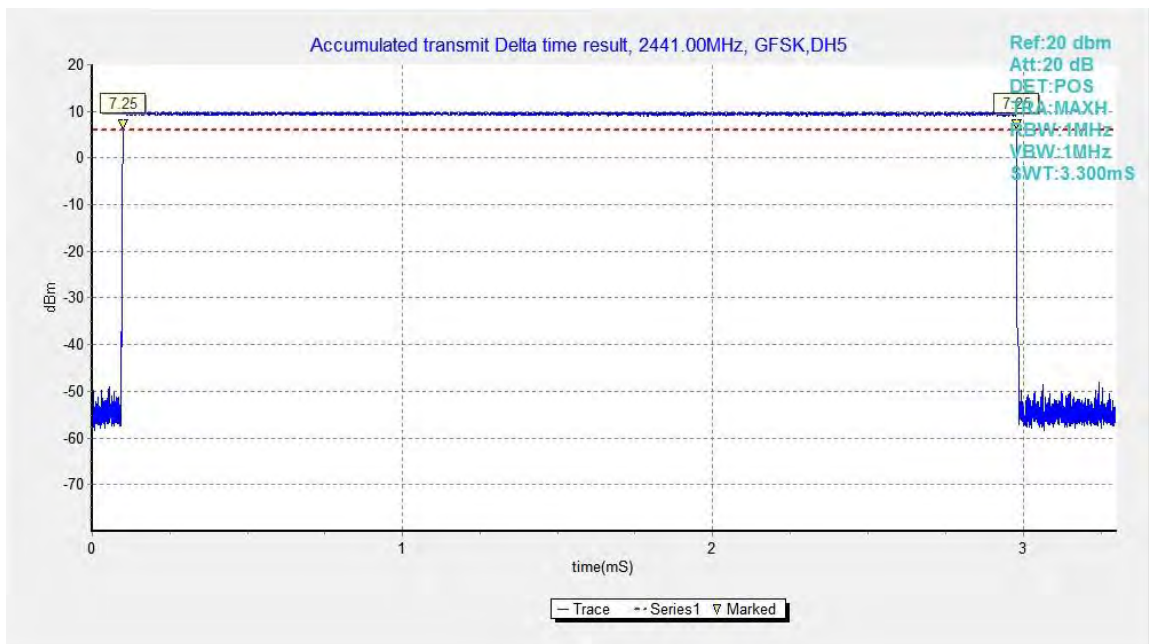

Fig.68. Time of occupancy (Dwell Time): Channel 39, Packet DH5

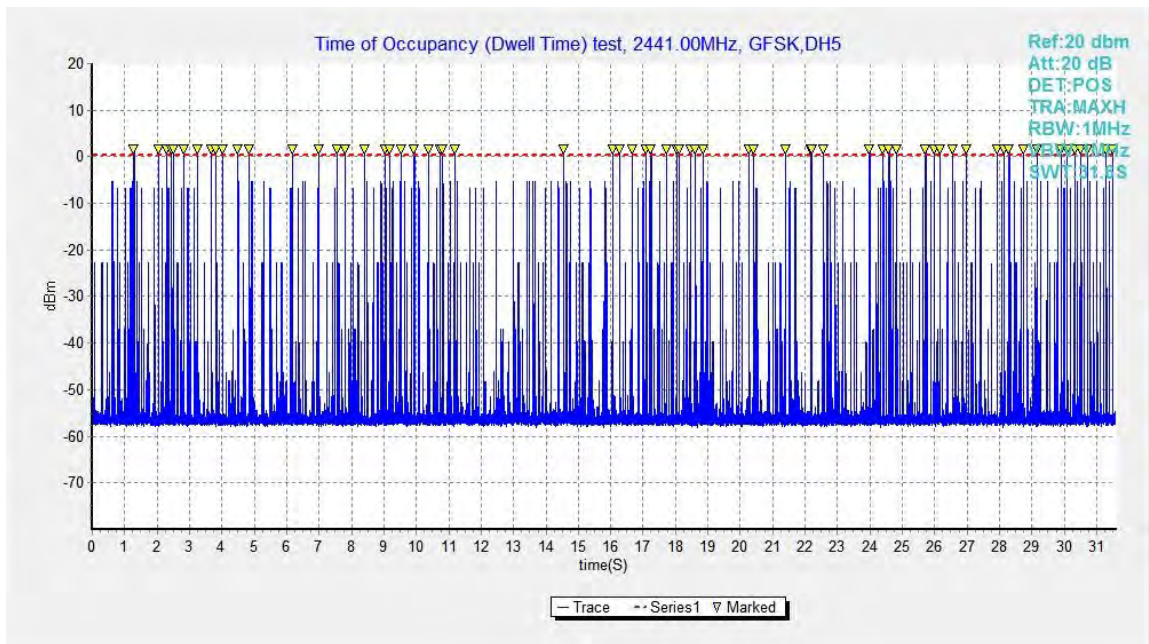

Fig.69. Number of Transmissions Measurement: Channel 39,Packet DH5

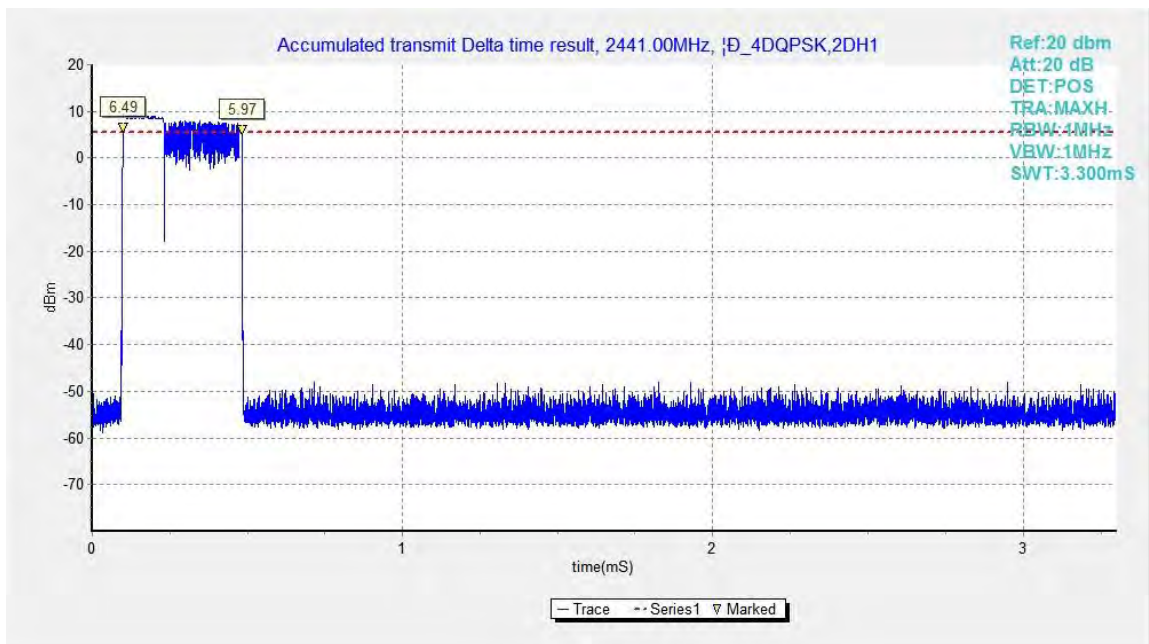

Fig.70. Time of occupancy (Dwell Time): Channel 39, Packet 2-DH1

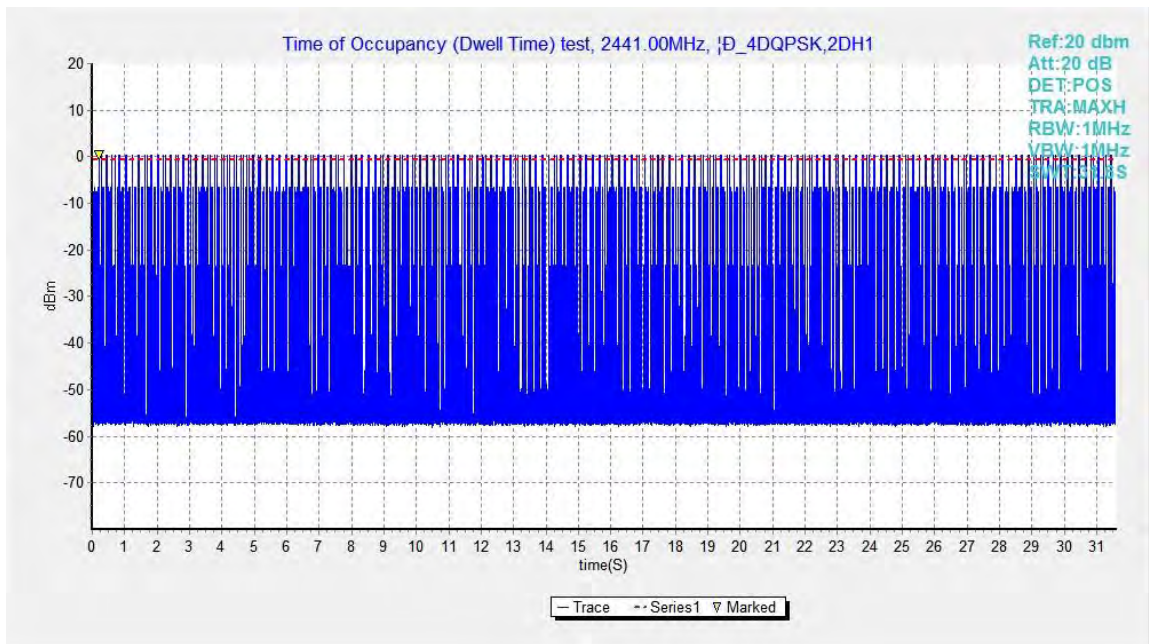

Fig.71. Number of Transmissions Measurement: Channel 39,Packet 2-DH1

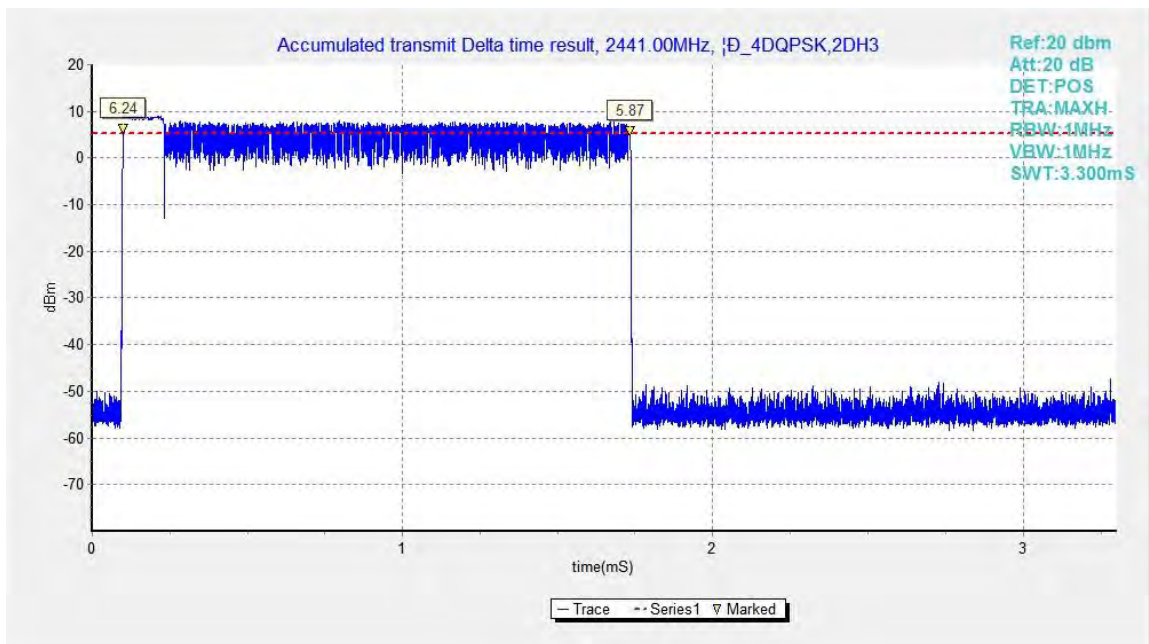

Fig.72. Time of occupancy (Dwell Time): Channel 39, Packet 2-DH3

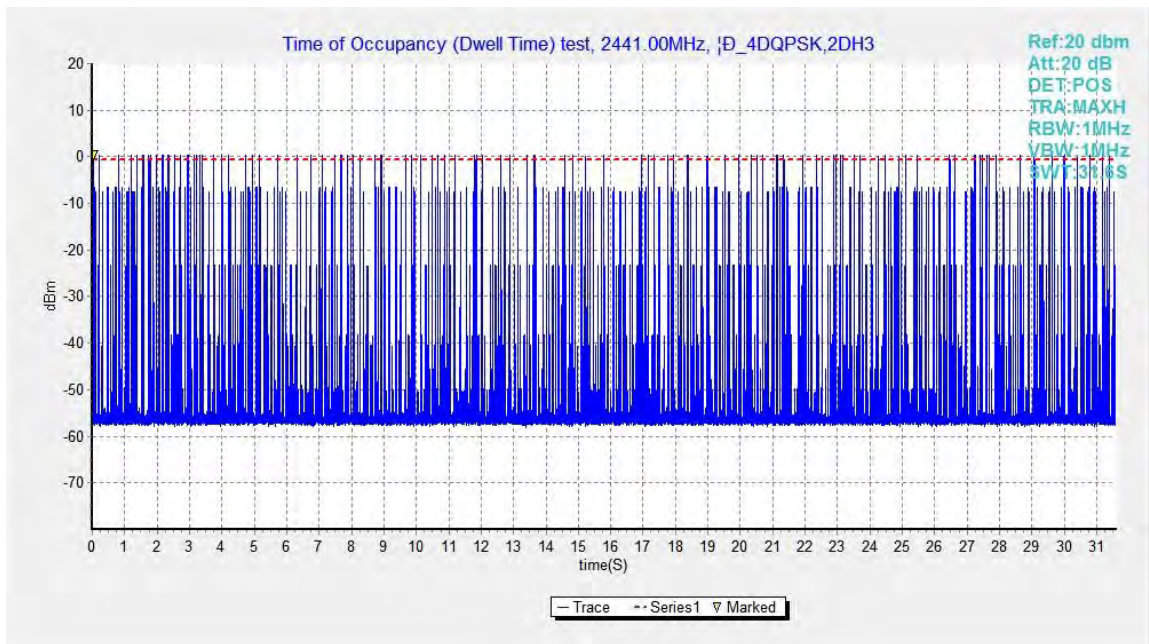

Fig.73. Number of Transmissions Measurement: Channel 39,Packet 2-DH3

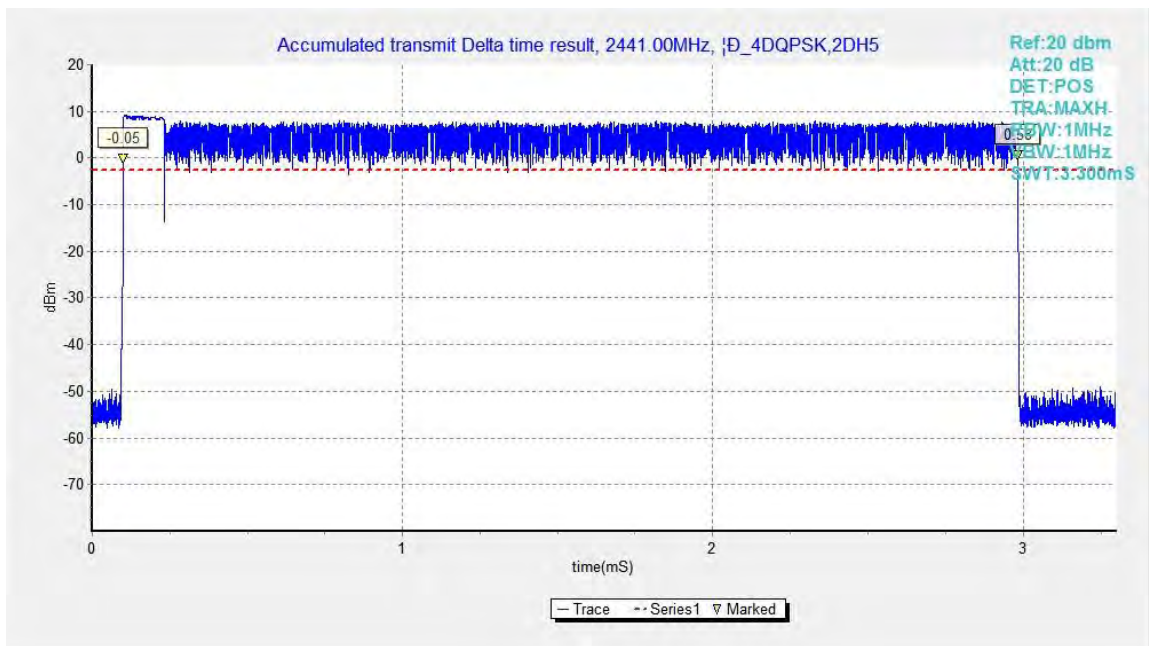

Fig.74. Time of occupancy (Dwell Time): Channel 39, Packet 2-DH5

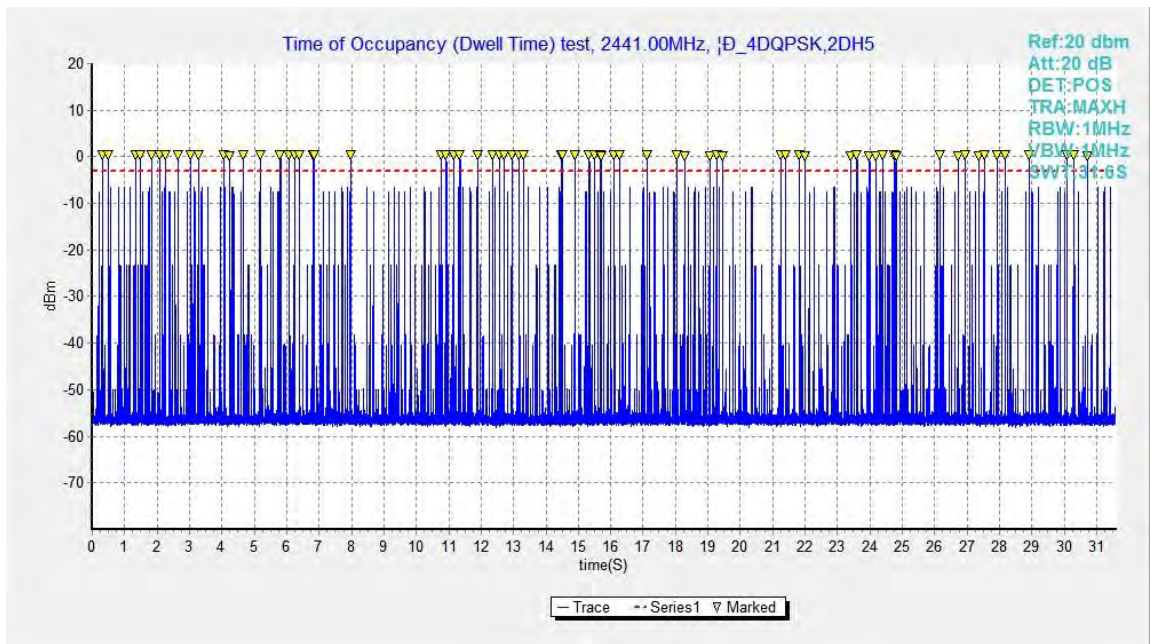

Fig.75. Number of Transmissions Measurement: Channel 39,Packet 2-DH5

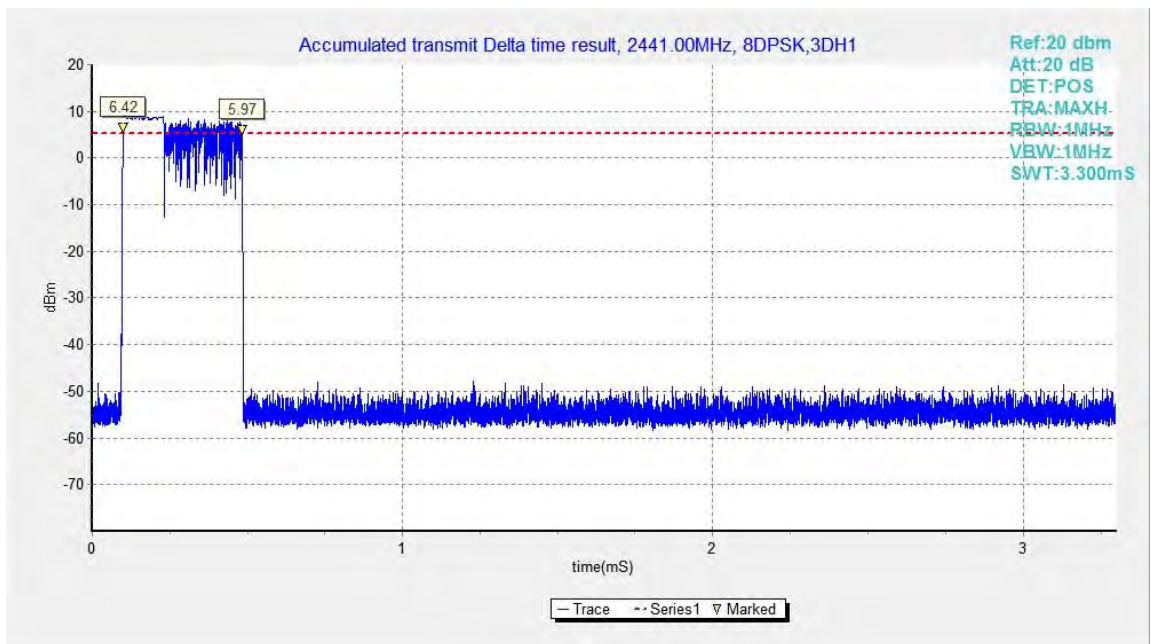

Fig.76. Time of occupancy (Dwell Time): Channel 39, Packet 3-DH1



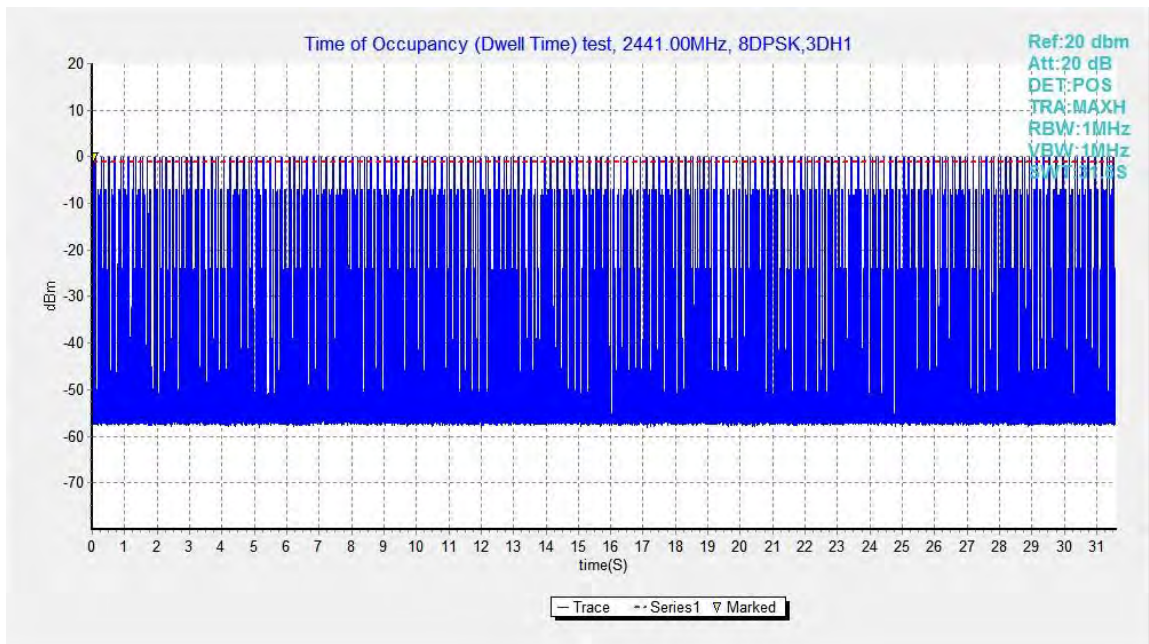

Fig.77. Number of Transmissions Measurement: Channel 39,Packet 3-DH1

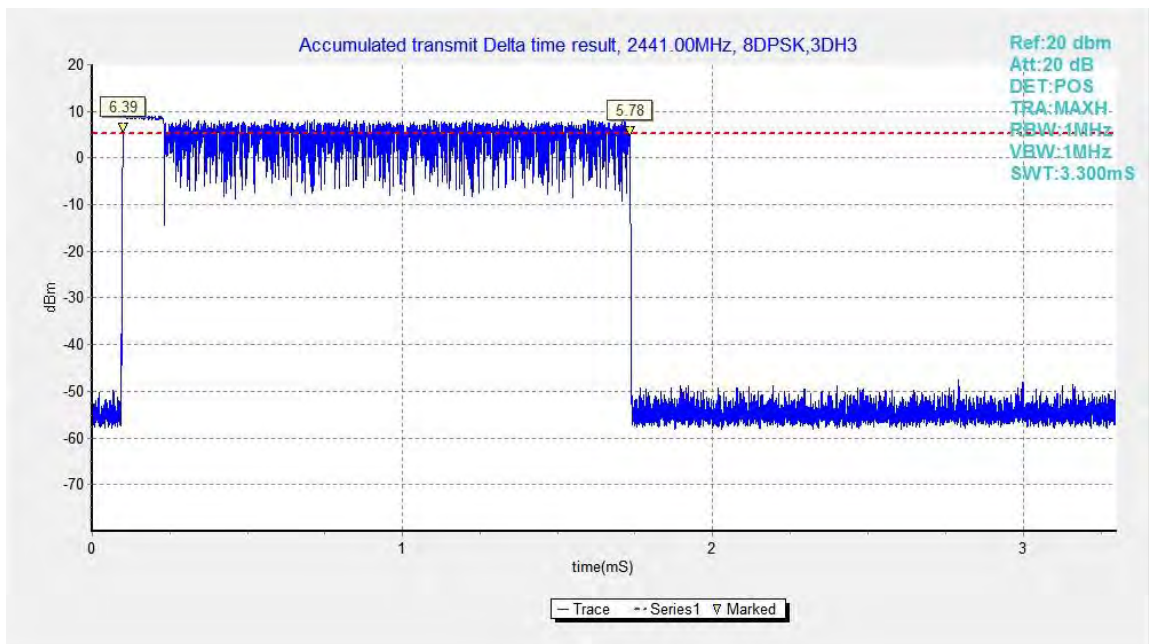

Fig.78. Time of occupancy (Dwell Time): Channel 39, Packet 3-DH3

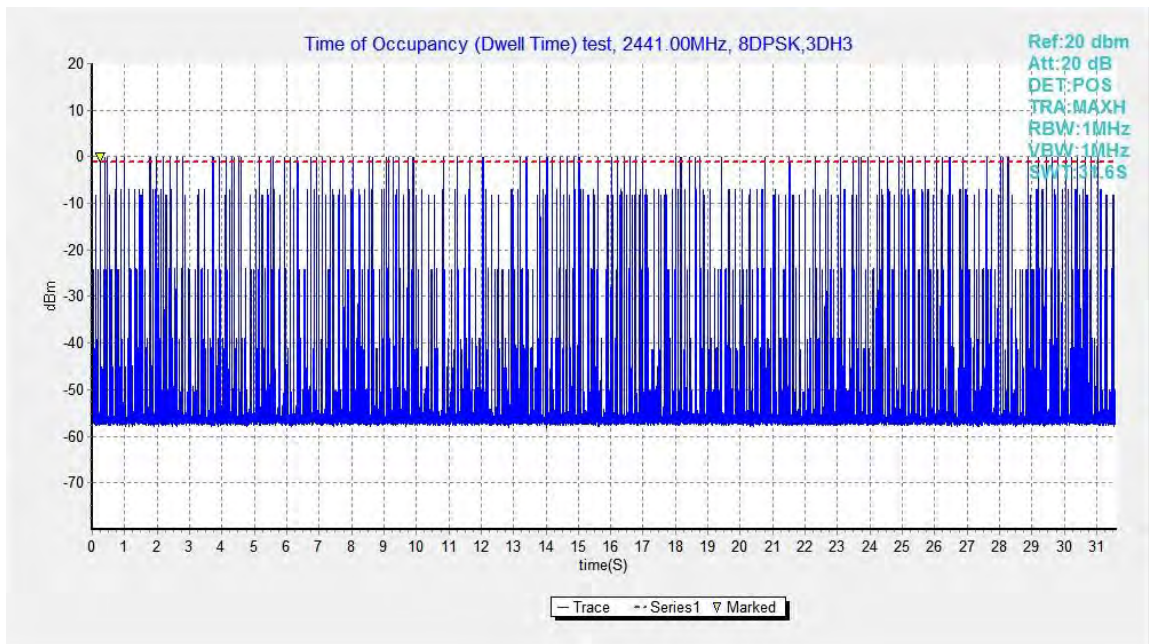

Fig.79. Number of Transmissions Measurement: Channel 39,Packet 3-DH3

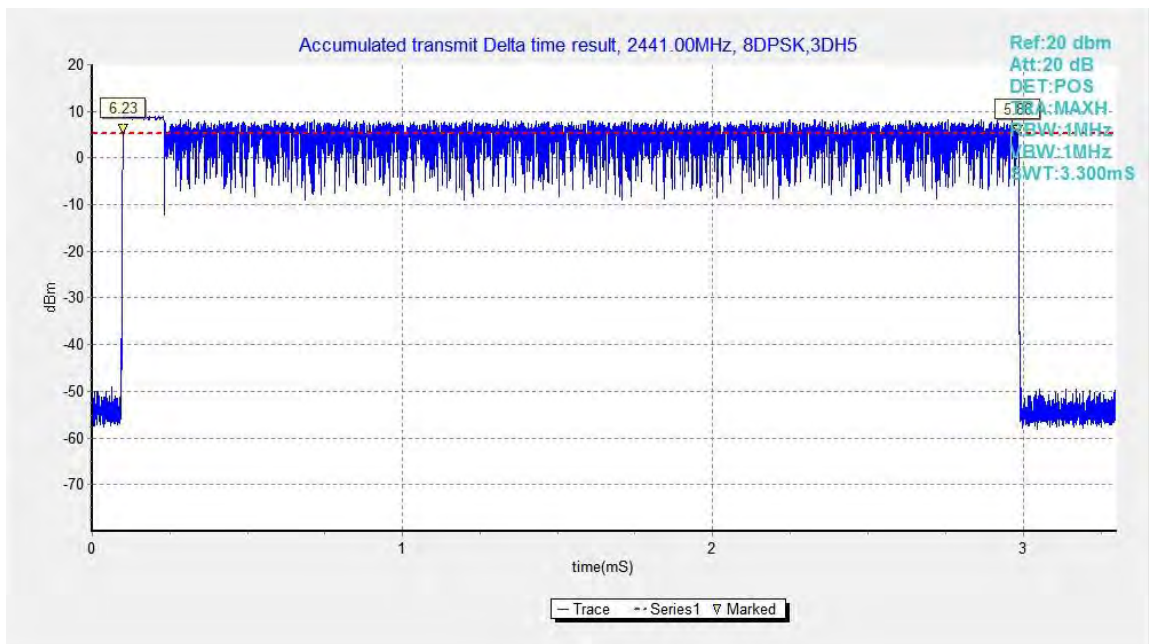

Fig.80. Time of occupancy (Dwell Time): Channel 39, Packet 3-DH5

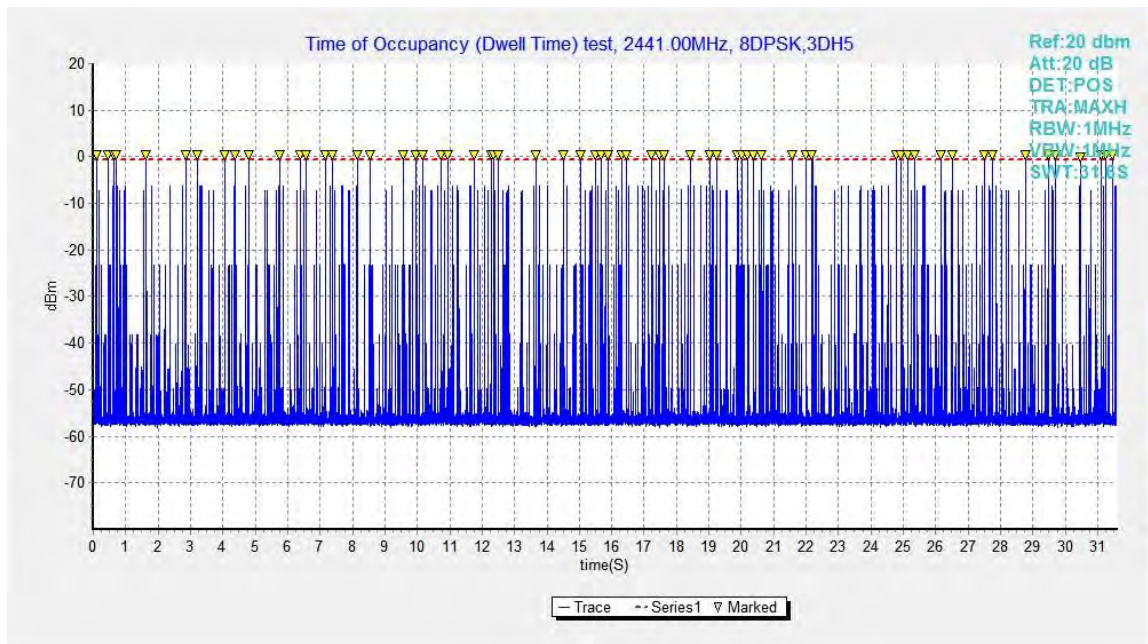

Fig.81. Number of Transmissions Measurement: Channel 39,Packet 3-DH5

## B.8. 20dB Bandwidth

**Method of Measurement: See ANSI C63.10-clause 6.9.2**

Measurement Procedure - Unwanted Emissions

1. Set RBW = 30kHz.
2. Set VBW = 100 kHz.
3. Set span to 3MHz
4. Detector = peak.
5. Trace Mode = max hold.
6. Sweep = auto couple.
7. Allow the trace to stabilize (this may take some time, depending on the extent of the span).

### Measurement Limit:

Standard	Limit
FCC 47 CFR Part 15.247(a)(1)	NA *

Use NdB Down function of the SA to measure the 20dB Bandwidth

\* Comment: This test case is not required according to the latest FCC 47 CFR Part 15.247. But the test results are necessary for “carrier frequency separation” test case, in Annex A.8.

### Measurement Results:

#### For GFSK

Channel	20dB Bandwidth (kHz)		Conclusion
0	Fig.82	939.75	NA
39	Fig.83	942.75	NA
78	Fig.84	941.25	NA

#### For $\pi/4$ DQPSK

Channel	20dB Bandwidth (kHz)		Conclusion
0	Fig.85	1261.50	NA
39	Fig.86	1255.50	NA
78	Fig.87	1223.25	NA

#### For 8DPSK

Channel	20dB Bandwidth (kHz)		Conclusion
0	Fig.88	1257.00	NA
39	Fig.89	1204.50	NA
78	Fig.90	1205.25	NA

**Conclusion: NA**

**Test graphs as below:**

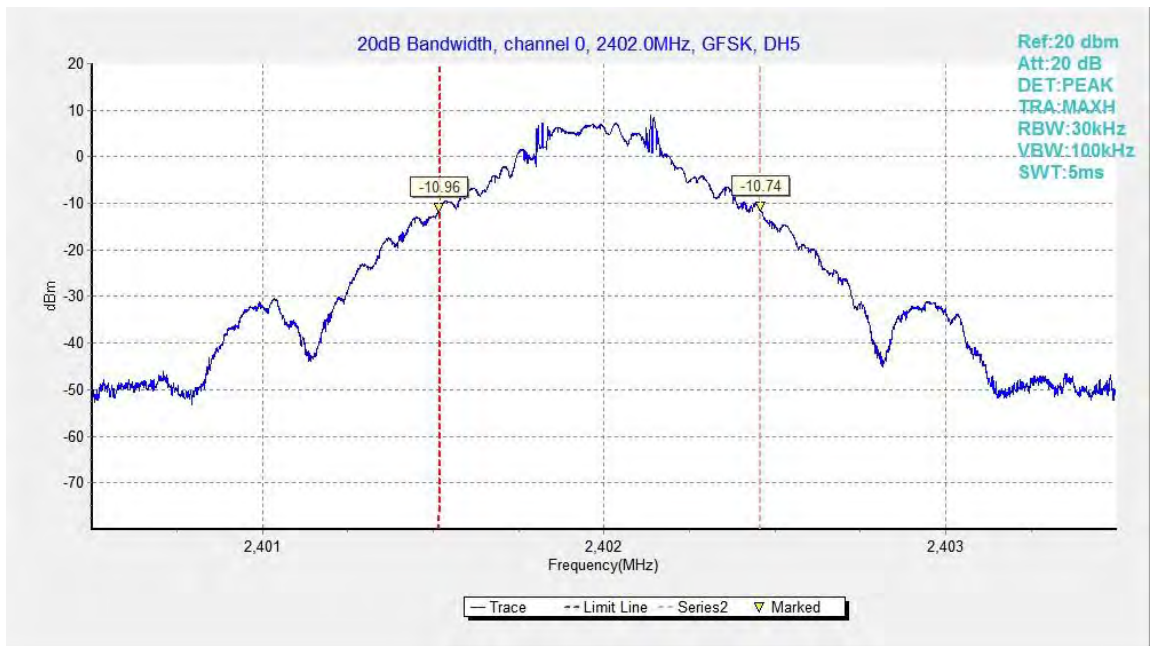

Fig.82. 20dB Bandwidth: GFSK, Channel 0

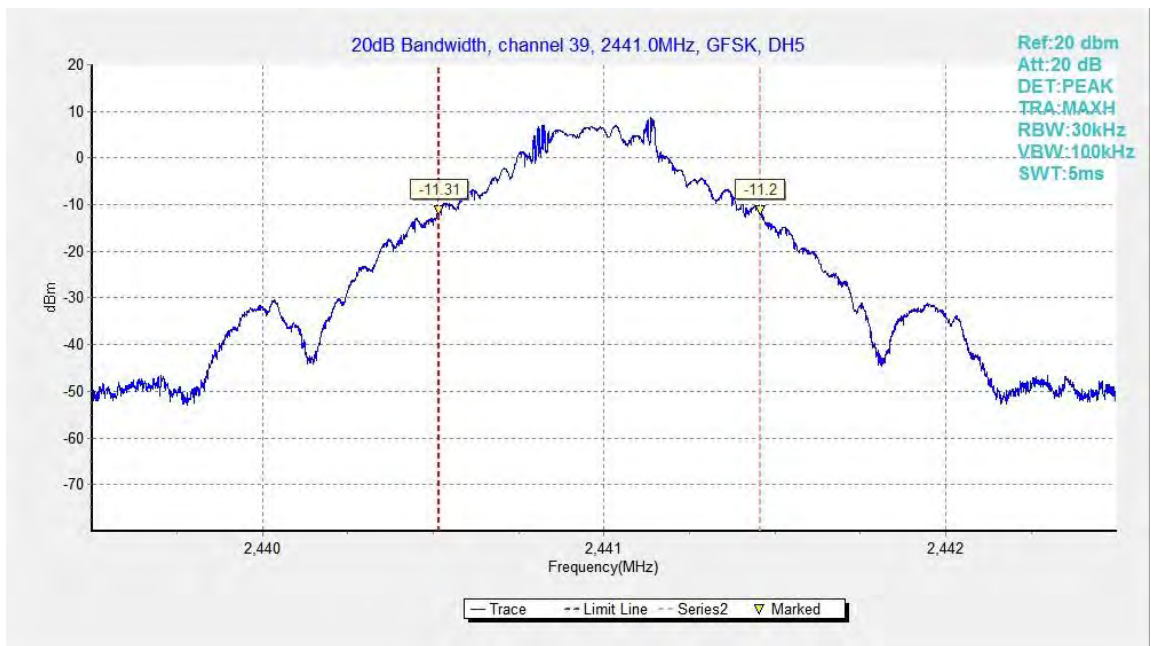

Fig.83. 20dB Bandwidth: GFSK, Channel 39

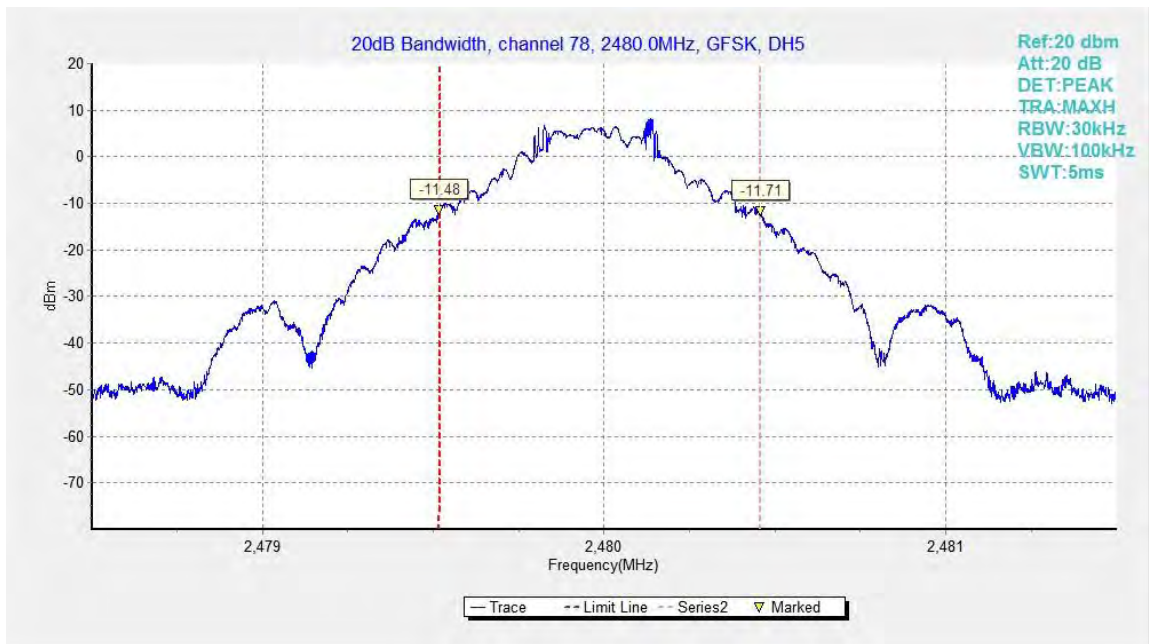

Fig.84. 20dB Bandwidth: GFSK, Channel 78

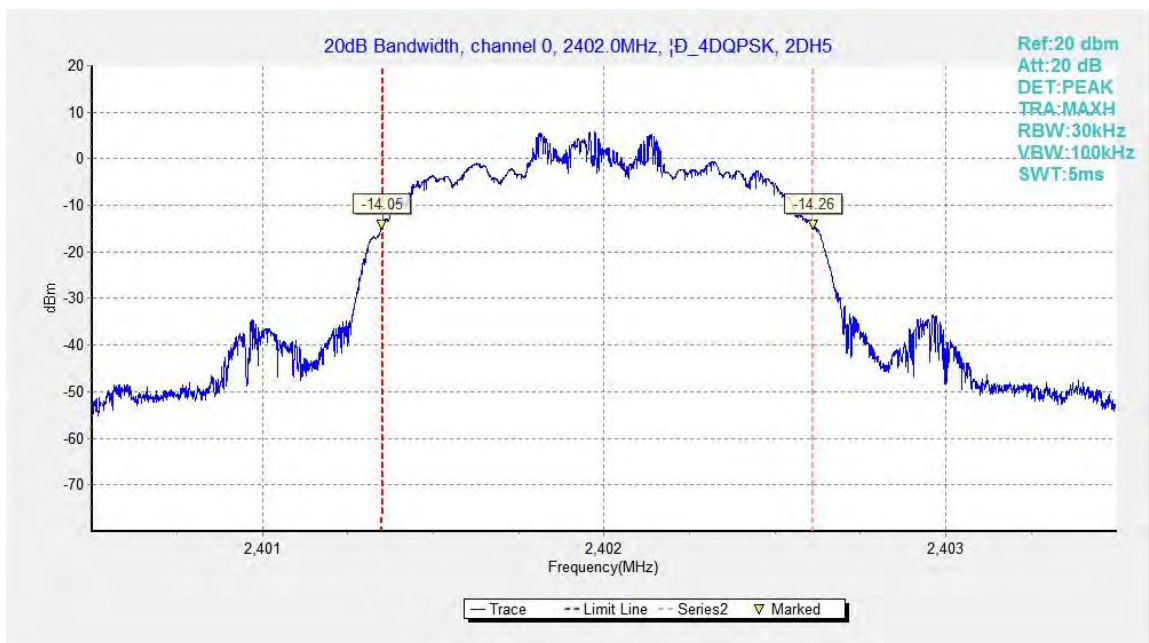

Fig.85. 20dB Bandwidth:  $\pi/4$  DQPSK, Channel 0

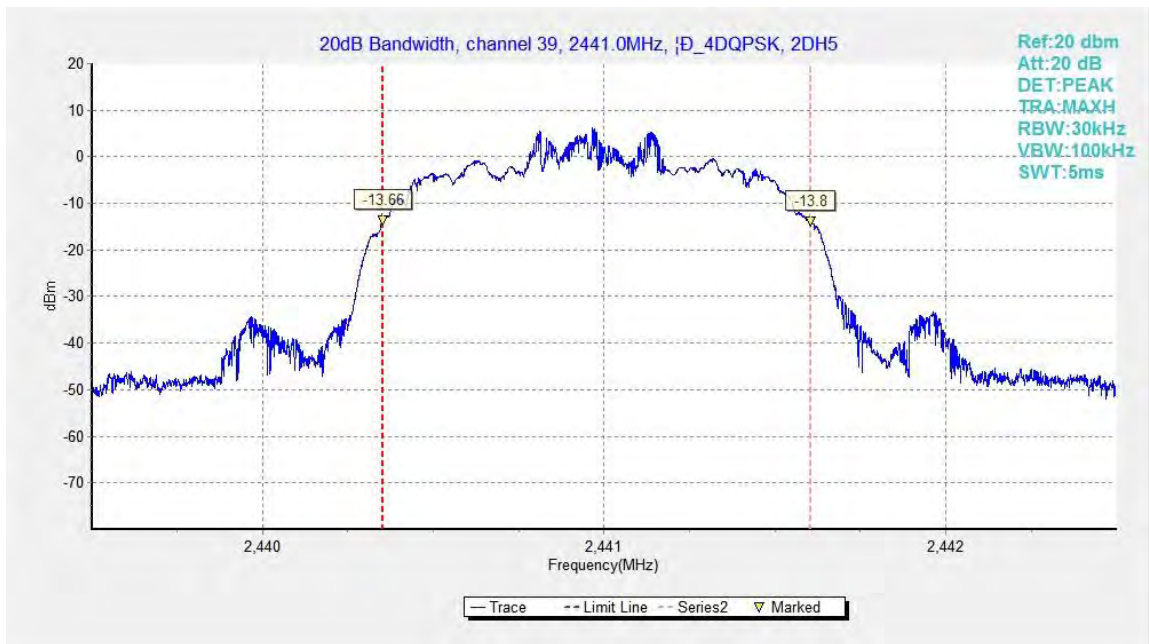

Fig.86. 20dB Bandwidth:  $\pi/4$  DQPSK, Channel 39

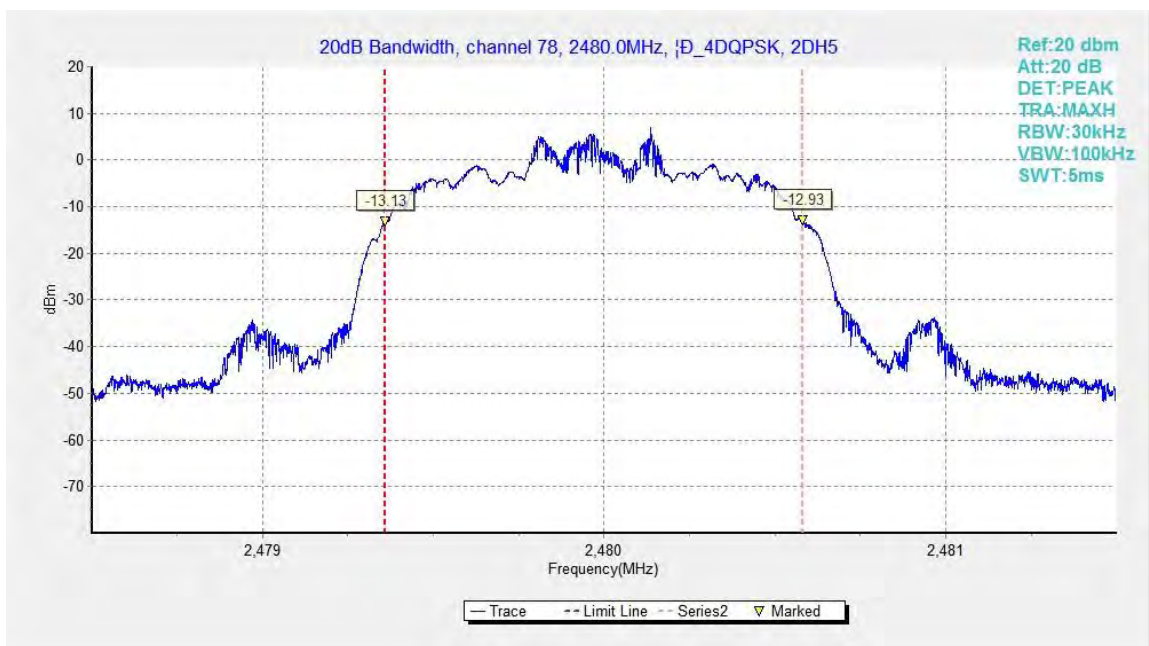

Fig.87. 20dB Bandwidth:  $\pi/4$  DQPSK, Channel 78

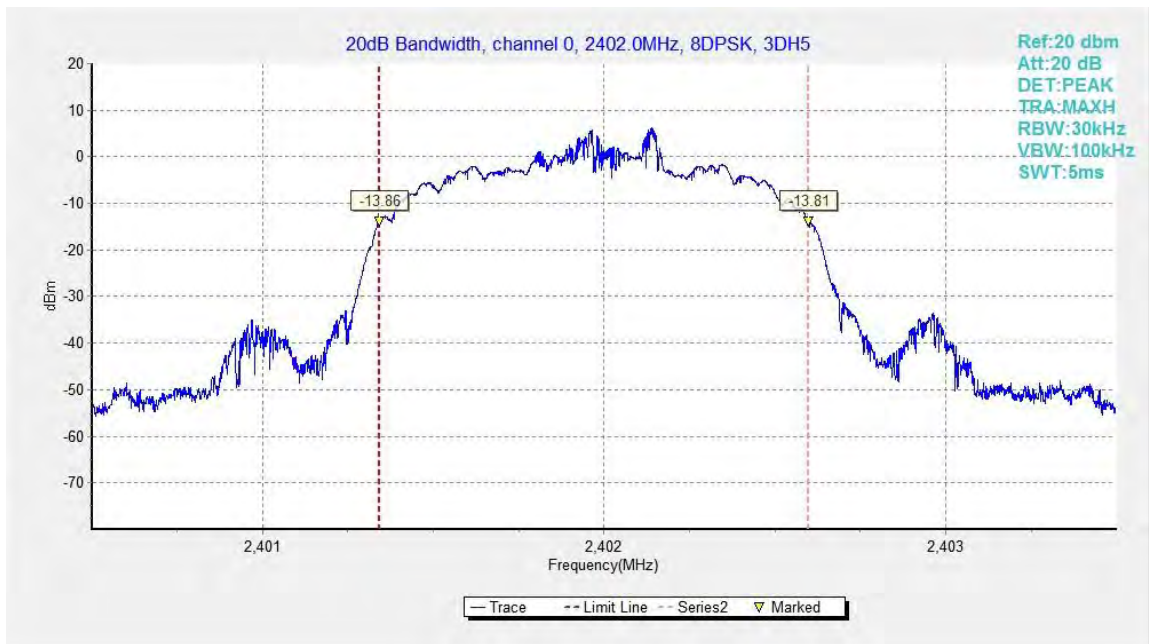

Fig.88. 20dB Bandwidth: 8DPSK, Channel 0

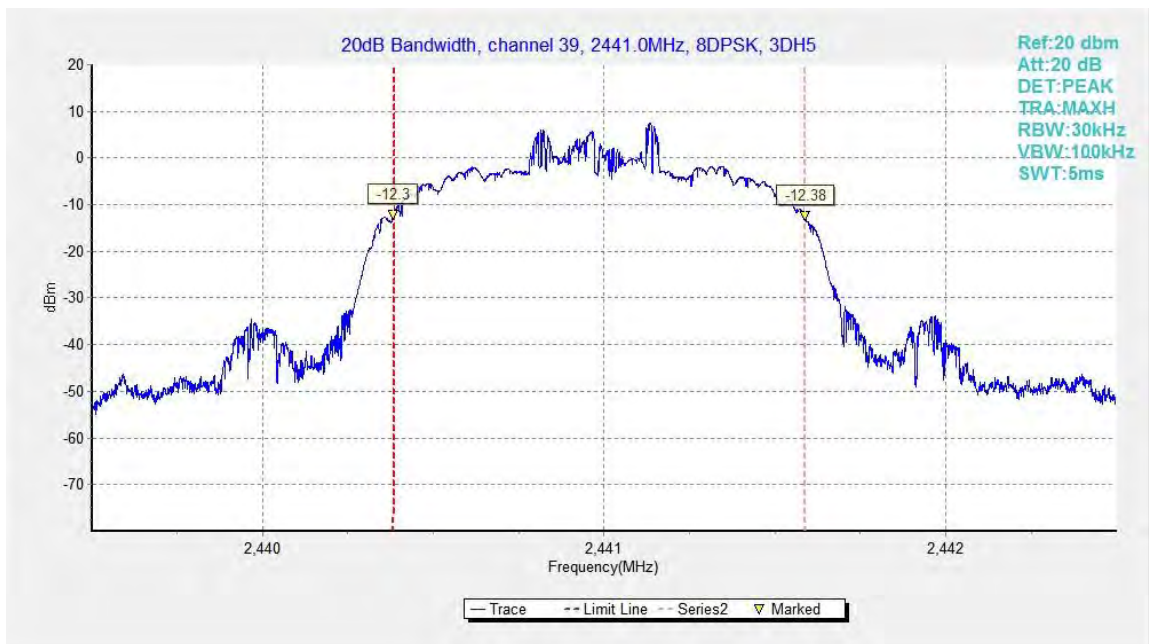

Fig.89. 20dB Bandwidth: 8DPSK, Channel 39



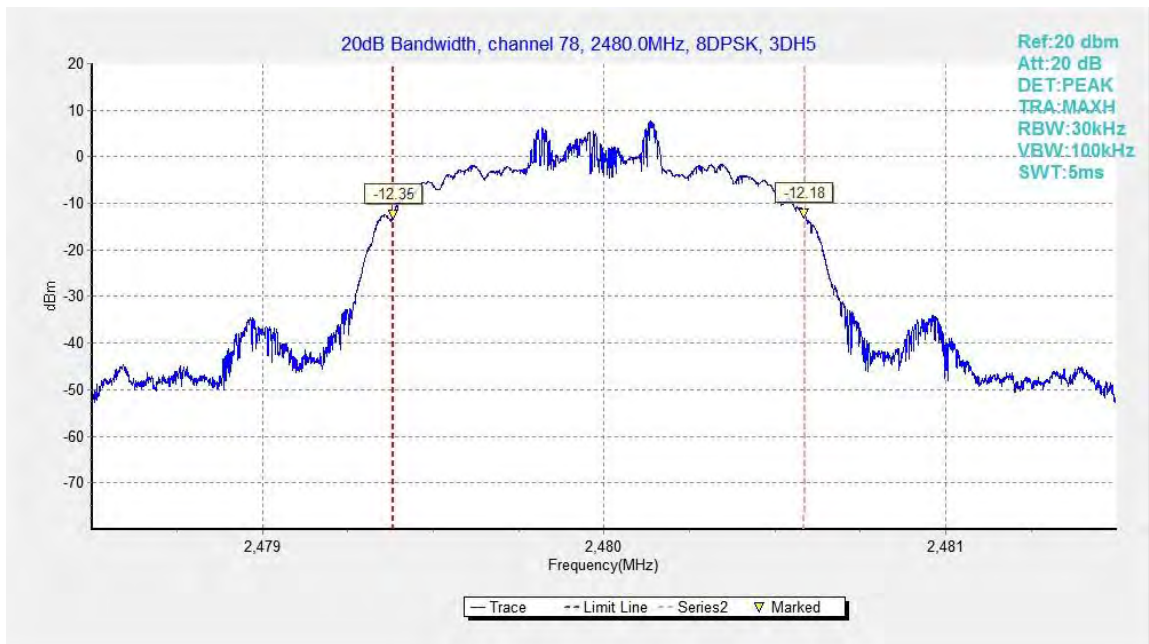

Fig.90. 20dB Bandwidth: 8DPSK, Channel 78

## B.9. Carrier Frequency Separation

**Method of Measurement: See ANSI C63.10-clause 7.8.2**

The EUT must have its hopping function enabled. Use the following spectrum analyzer settings:

- Span = 3MHz
- RBW=300kHz
- VBW=300kHz
- Sweep = auto
- Detector function = peak
- Trace = max hold
- Allow the trace to stabilize

Search the peak marks of the middle frequency and adjacent channel, then record the separation between them.

\* Comment: This limit should be over 25 kHz or  $(2/3) * 20\text{dB}$  bandwidth, whichever is greater.

### Measurement Limit:

Standard	Limit(kHz)
FCC 47 CFR Part 15.247(a)(1)	over 25 kHz or $(2/3) * 20\text{dB}$ bandwidth

### Measurement Result:

#### For GFSK

Channel	Carrier frequency separation (kHz)		Conclusion
39	Fig.91	971.25	P

#### For $\pi/4$ DQPSK

Channel	Carrier frequency separation (kHz)		Conclusion
39	Fig.92	986.25	P

#### For 8DPSK

Channel	Carrier frequency separation (kHz)		Conclusion
39	Fig.93	953.25	P

**Conclusion: PASS**

**Test graphs as below:**

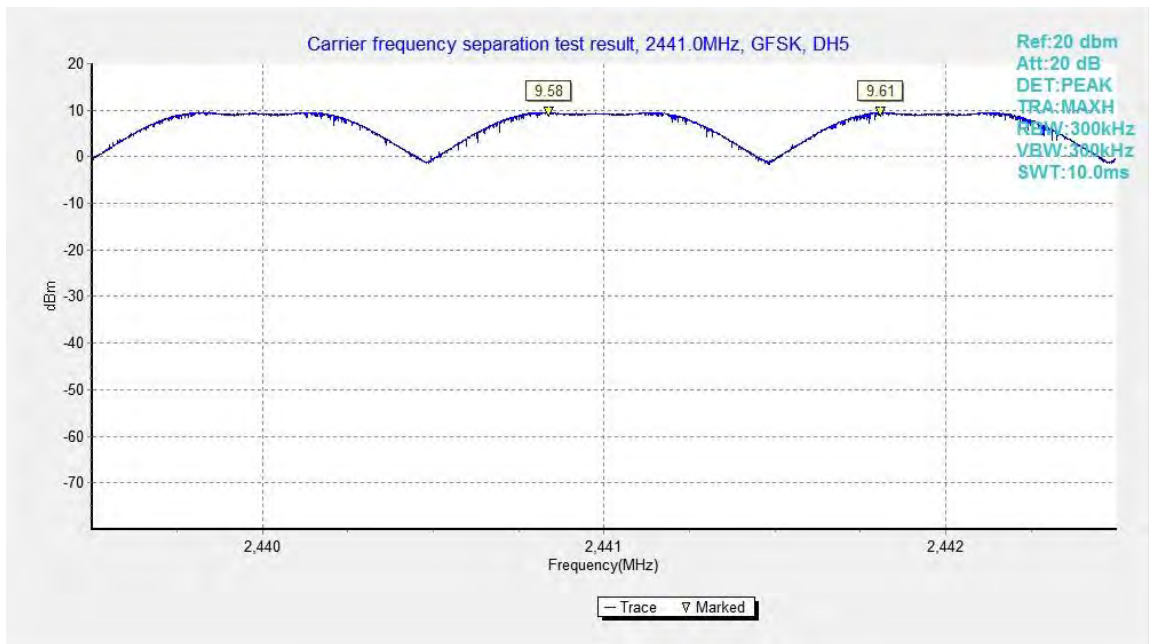

Fig.91. Carrier frequency separation measurement: GFSK, Channel 39

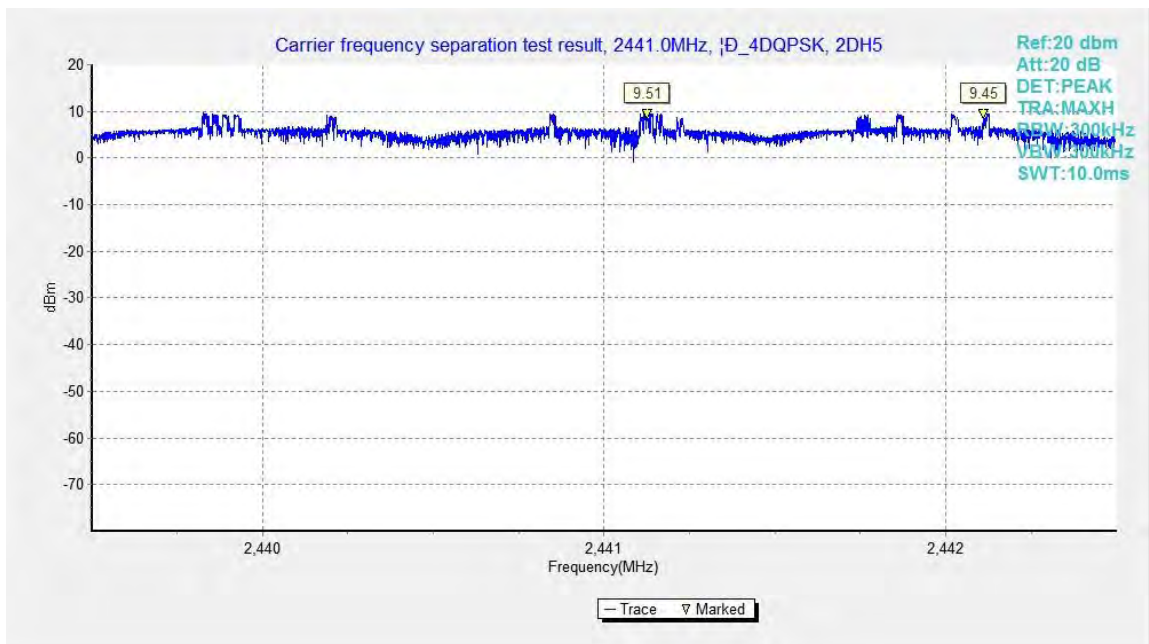

Fig.92. Carrier frequency separation measurement:  $\pi/4$  DQPSK, Channel 39

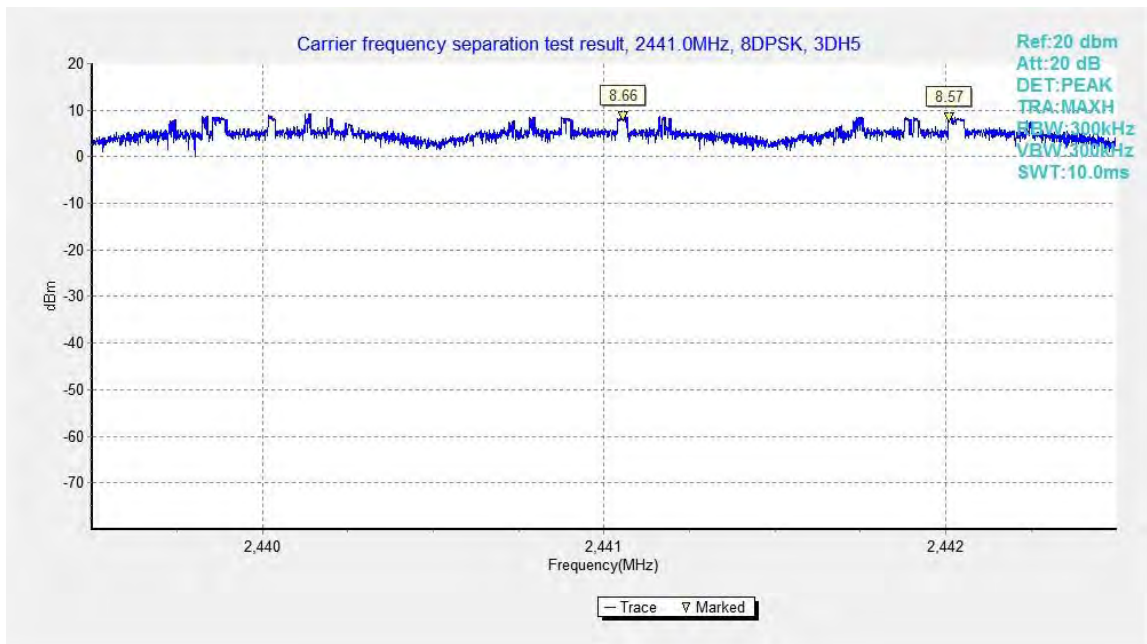

Fig.93. Carrier frequency separation measurement: 8DPSK, Channel 39

## B.10. Number of Hopping Channels

### Method of Measurement: See ANSI C63.10-clause 7.8.3

The EUT must have its hopping function enabled. Use the following spectrum analyzer settings:

- Span = the frequency band of operation
- RBW = 500kHz
- VBW = 500kHz
- Sweep = auto
- Detector function = peak
- Trace = max hold
- Allow the trace to stabilize

It might prove necessary to break the span up into subranges to show clearly all of the hopping frequencies. Compliance of an EUT with the appropriate regulatory limit shall be determined for the number of hopping channels. A plot of the data shall be included in the test report.

#### Measurement Limit:

Standard	Limit
FCC 47 CFR Part 15.247(a) (1)(iii)	At least 15 non-overlapping channels

#### Measurement Result:

##### For GFSK

Channel	Number of hopping channels	Conclusion
0~39	Fig.94	79 P
40~78	Fig.95	

##### For $\pi/4$ DQPSK

Channel	Number of hopping channels	Conclusion
0~39	Fig.96	79 P
40~78	Fig.97	

##### For 8DPSK

Channel	Number of hopping channels	Conclusion
0~39	Fig.98	79 P
40~78	Fig.99	

**Conclusion: PASS**

**Test graphs as below:**

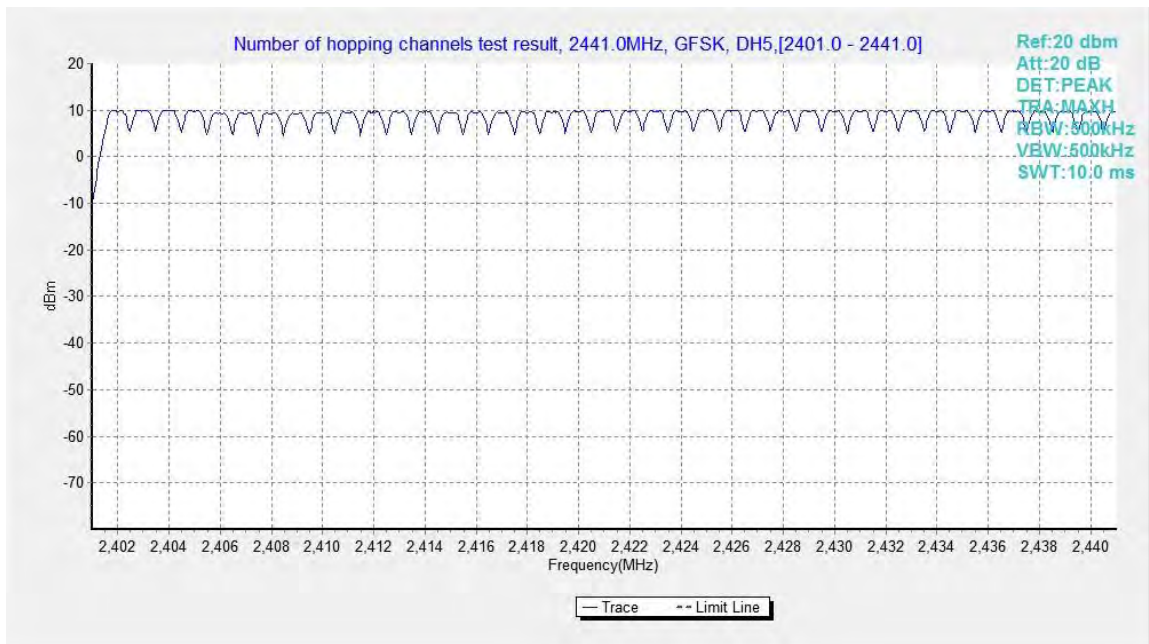

Fig.94. Number of hopping frequencies: GFSK, Channel 0 - 39

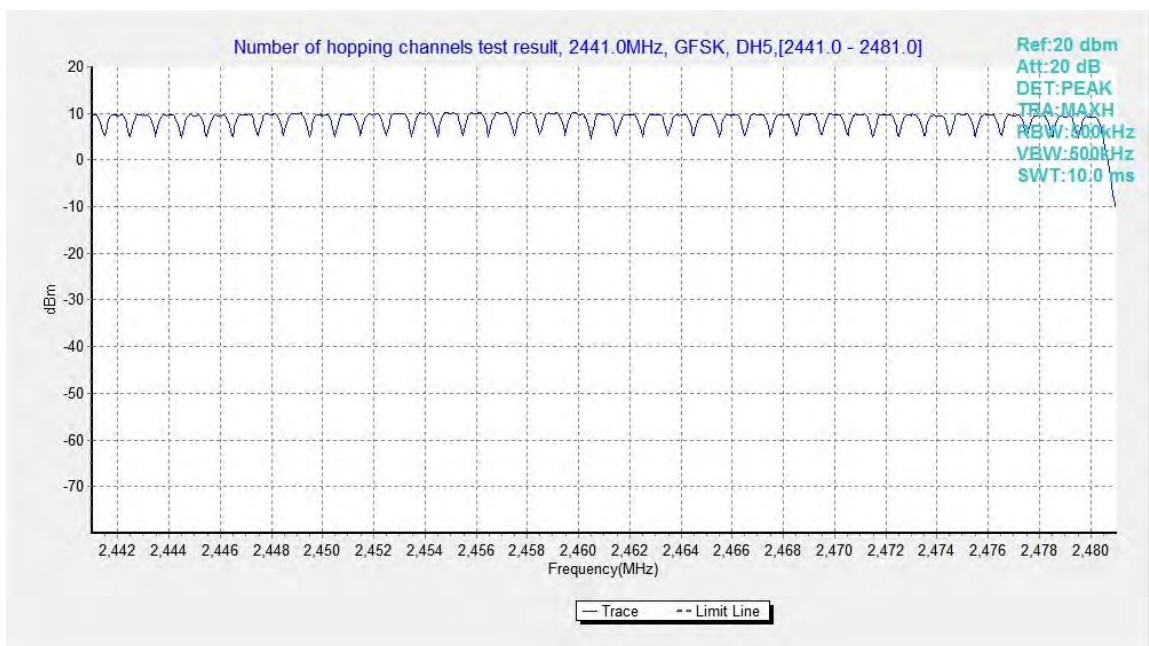

Fig.95. Number of hopping frequencies: GFSK, Channel 40 - 78

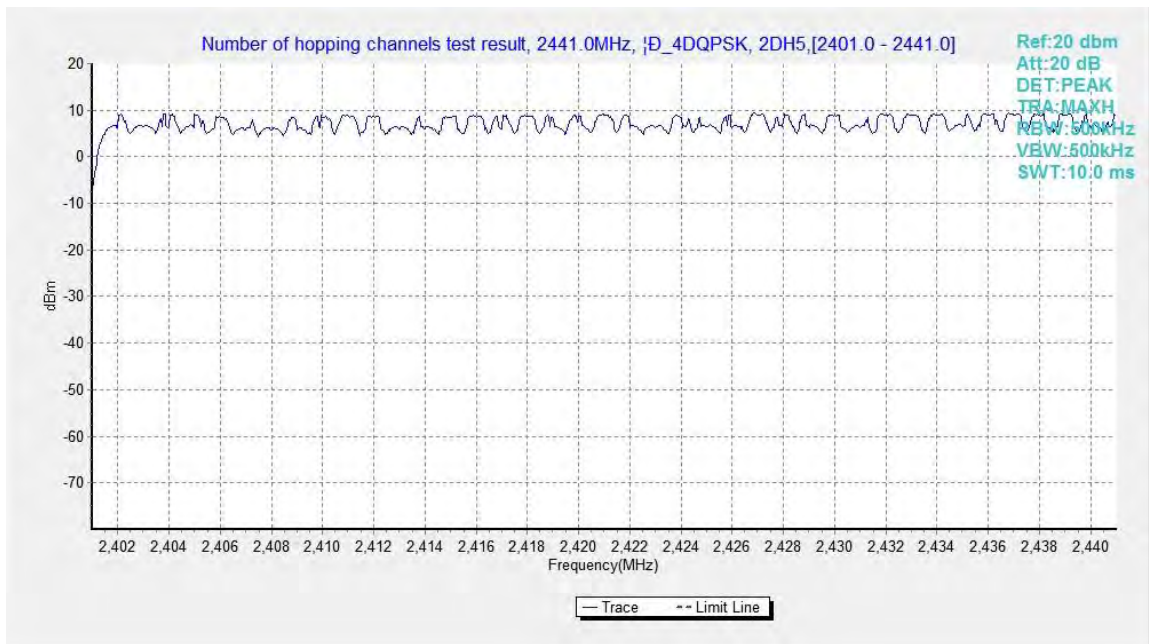

Fig.96. Number of hopping frequencies:  $\pi/4$  DQPSK, Channel 0 - 39

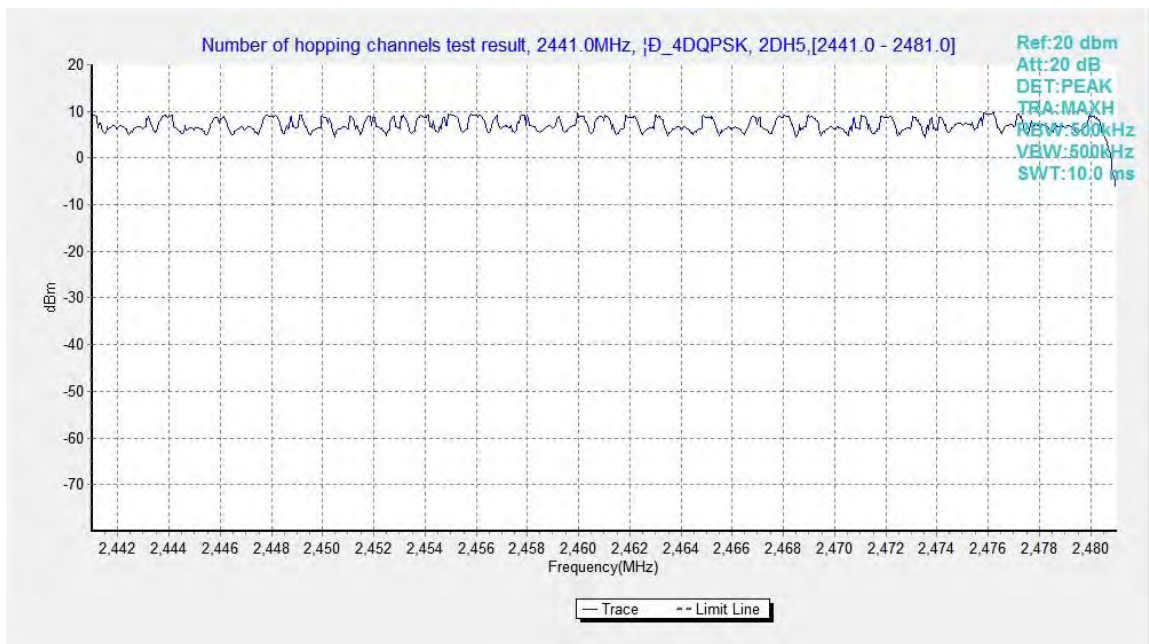

Fig.97. Number of hopping frequencies:  $\pi/4$  DQPSK, Channel 40 - 78

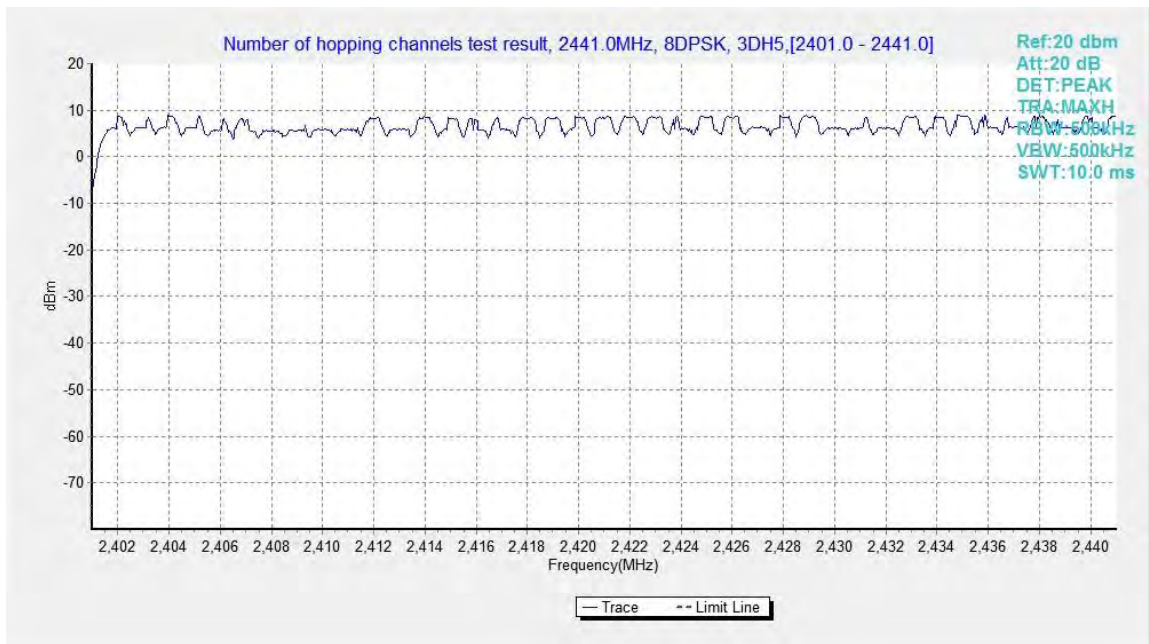

Fig.98. Number of hopping frequencies: 8DPSK, Channel 0 - 39

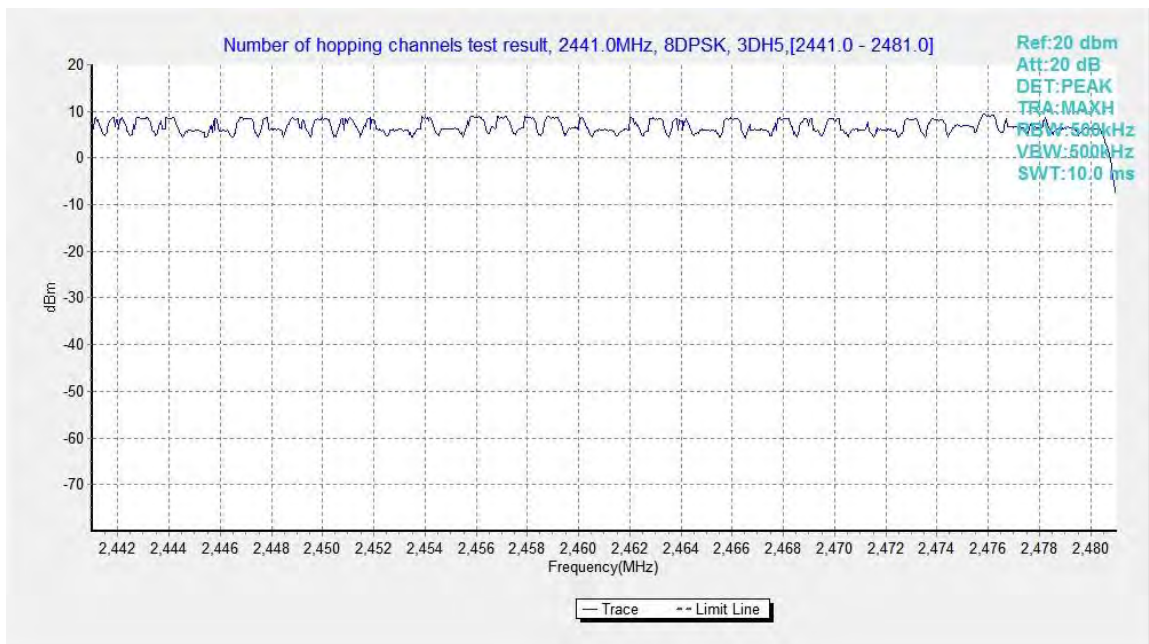

Fig.99. Number of hopping frequencies: 8DPSK, Channel 40 - 78





Based on the exploratory tests of the EUT, the one EUT cable configuration and arrangement and mode of operation that produced the emission with the highest amplitude relative to the limit is selected for the final measurement, while applying the appropriate modulating signal to the EUT. If the EUT is relocated from an exploratory test site to a final test site, the highest emissions shall be remaximized at the final test location before final ac power-line conducted emission measurements are performed. The final test on all current-carrying conductors of all of the power cords to the equipment that comprises the EUT (but not the cords associated with other non-EUT equipment in the system) is then performed for the full frequency range for which the EUT is being tested for compliance without further variation of the EUT arrangement, cable positions, or EUT mode of operation. If the EUT is composed of equipment units that have their own separate ac power connections (e.g., floor-standing equipment with independent power cords for each shelf that are able to connect directly to the ac power network), then each current-carrying conductor of one unit is measured while the other units are connected to a second (or more) LISN(s). All units shall be measured separately. If a power strip is provided by the manufacturer, to supply all of the units making up the EUT, only the conductors in the power cord of the power strip shall be measured.

**Test Condition:**

Voltage (V)	Frequency (Hz)
120	60

**Measurement Result and limit:**

**EUT ID: EUT1**

Bluetooth (Quasi-peak Limit)

Frequency range (MHz)	Quasi-peak Limit (dB $\mu$ V)	Result (dB $\mu$ V)		Conclusion
		With charger		
		bluetooth	Idle	
0.15 to 0.5	66 to 56	Fig.B.11.1	Fig.B.11.2	<b>P</b>
0.5 to 5	56			
5 to 30	60			

NOTE: The limit decreases linearly with the logarithm of the frequency in the range 0.15 MHz to 0.5 MHz.

Bluetooth (Average Limit)

Frequency range (MHz)	Average Limit (dB $\mu$ V)	Result (dB $\mu$ V)		Conclusion
		With charger		
		bluetooth	Idle	
0.15 to 0.5	56 to 46	Fig.B.11.1	Fig.B.11.2	<b>P</b>
0.5 to 5	46			
5 to 30	50			

NOTE: The limit decreases linearly with the logarithm of the frequency in the range 0.15 MHz to 0.5 MHz.

**Conclusion: Pass**

**Test graphs as below:**

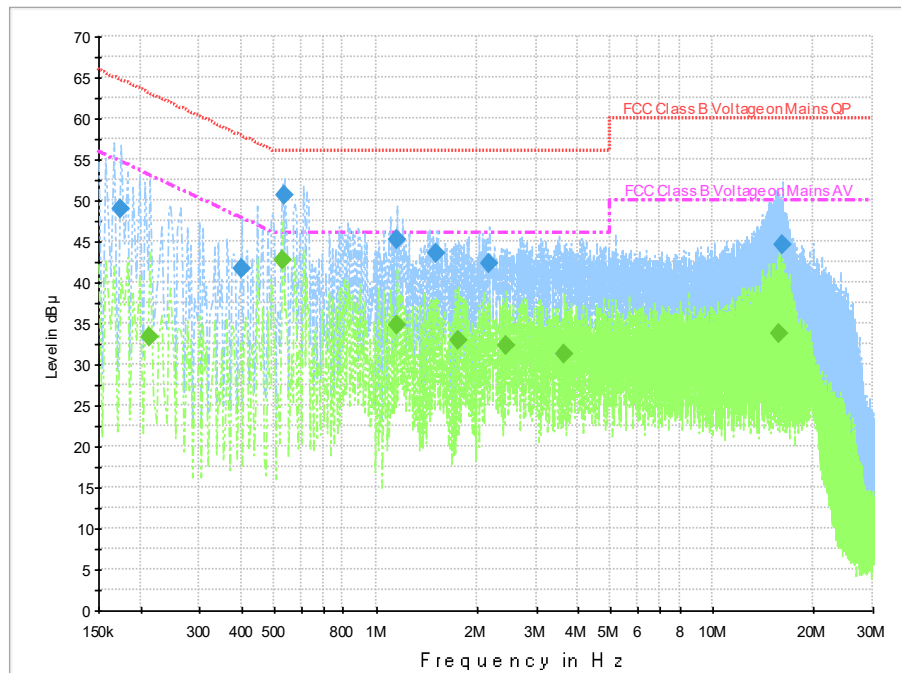

**Fig.B.11.1 AC Powerline Conducted Emission- bluetooth**

Note: The graphic result above is the maximum of the measurements for both phase line and neutral line.

**Final Result 1**

Frequency (MHz)	QuasiPeak (dBuV)	Bandwidth (kHz)	Filter	Line	Corr. (dB)	Margin (dB)	Limit (dBuV)	Comment
0.174000	49.0	9.000	On	N	19.7	15.8	64.8	
0.398000	41.7	9.000	On	L1	19.7	16.2	57.9	
0.538000	50.7	9.000	On	L1	19.7	5.3	56.0	
1.150000	45.2	9.000	On	L1	19.7	10.8	56.0	
1.518000	43.5	9.000	On	L1	19.6	12.5	56.0	
2.182000	42.4	9.000	On	L1	19.6	13.6	56.0	

**Final Result 2**

Frequency (MHz)	QuasiPeak (dBuV)	Bandwidth (kHz)	Filter	Line	Corr. (dB)	Margin (dB)	Limit (dBuV)	Comment
0.214000	33.4	9.000	On	L1	19.7	19.7	53.0	
0.526000	42.7	9.000	On	L1	19.7	3.3	46.0	
1.154000	34.9	9.000	On	L1	19.7	11.1	46.0	
1.766000	33.0	9.000	On	L1	19.6	13.0	46.0	
2.430000	32.2	9.000	On	L1	19.6	13.8	46.0	
3.618000	31.2	9.000	On	L1	19.6	14.8	46.0	

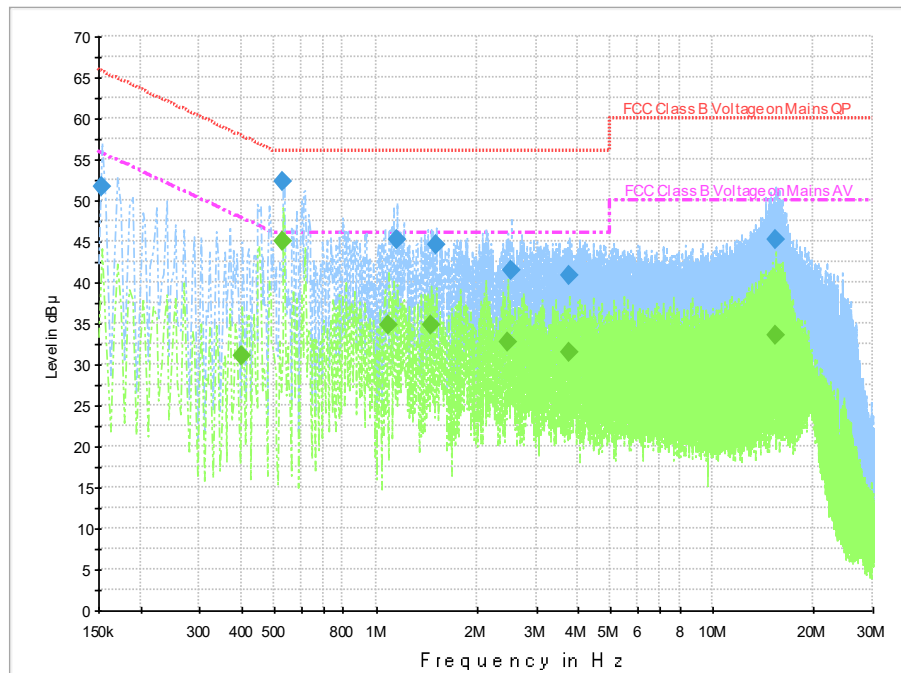

**Fig.B.11.2 AC Powerline Conducted Emission-Idle**

Note: The graphic result above is the maximum of the measurements for both phase line and neutral line.

**Final Result 1**

Frequency (MHz)	QuasiPeak (dBuV)	Bandwidth (kHz)	Filter	Line	Corr. (dB)	Margin (dB)	Limit (dBuV)	Comment
0.154000	51.6	9.000	On	L1	19.9	14.2	65.8	
0.530000	52.4	9.000	On	L1	19.7	3.6	56.0	
1.158000	45.2	9.000	On	L1	19.7	10.8	56.0	
1.510000	44.5	9.000	On	L1	19.6	11.5	56.0	
2.522000	41.5	9.000	On	L1	19.6	14.5	56.0	
3.742000	40.7	9.000	On	L1	19.6	15.3	56.0	

**Final Result 2**

Frequency (MHz)	QuasiPeak (dBuV)	Bandwidth (kHz)	Filter	Line	Corr. (dB)	Margin (dB)	Limit (dBuV)	Comment
0.402000	31.1	9.000	On	L1	19.7	16.7	47.8	
0.530000	45.0	9.000	On	L1	19.7	1.0	46.0	
1.094000	34.8	9.000	On	L1	19.6	11.2	46.0	
1.462000	34.8	9.000	On	L1	19.7	11.2	46.0	
2.466000	32.8	9.000	On	L1	19.6	13.2	46.0	
3.742000	31.5	9.000	On	L1	19.6	14.5	46.0	

## ANNEX C: Accreditation Certificate

<p>United States Department of Commerce National Institute of Standards and Technology</p>  	
<hr/> <b>Certificate of Accreditation to ISO/IEC 17025:2017</b> <hr/>	
NVLAP LAB CODE: 600118-0	
<b>Telecommunication Technology Labs, CAICT</b> Beijing China	
<i>is accredited by the National Voluntary Laboratory Accreditation Program for specific services, listed on the Scope of Accreditation, for:</i>	
<b>Electromagnetic Compatibility &amp; Telecommunications</b>	
<i>This laboratory is accredited in accordance with the recognized International Standard ISO/IEC 17025:2017. This accreditation demonstrates technical competence for a defined scope and the operation of a laboratory quality management system (refer to joint ISO-ILAC-IAF Communique dated January 2009).</i>	
2022-10-01 through 2023-09-30 <i>Effective Dates</i>	  <i>For the National Voluntary Laboratory Accreditation Program</i>

\*\*\*END OF REPORT\*\*\*