



FCC Test Report

APPLICANT : CT Asia
EQUIPMENT : Smartphone
BRAND NAME : BLU
MODEL NAME : ADVANCE 4.0 L
FCC ID : YHLBLUADVANCE4L
STANDARD : FCC 47 CFR FCC Part 15 Subpart B
CLASSIFICATION : Certification

The product was received on Mar. 24, 2015 and testing was completed on Apr. 22, 2015. We, SPORTON INTERNATIONAL (SHENZHEN) INC., would like to declare that the tested sample has been evaluated in accordance with the test procedures given in ANSI C63.4-2009 and has been in compliance with the applicable technical standards.

The test results in this report apply exclusively to the tested model / sample. Without written approval of SPORTON INTERNATIONAL (SHENZHEN) INC., the test report shall not be reproduced except in full.

Reviewed by: Louis Wu / Manager

Approved by: Jones Tsai / Manager



SPORTON INTERNATIONAL (SHENZHEN) INC.

**1F & 2F, Building A, Morning Business Center, No. 4003 ShiGu Rd., Xili Town,
Nanshan District, Shenzhen, Guangdong, P. R. China**



TABLE OF CONTENTS

REVISION HISTORY..... 3

SUMMARY OF TEST RESULT 4

1. GENERAL DESCRIPTION 5

 1.1. Applicant..... 5

 1.2. Manufacturer 5

 1.3. Product Feature of Equipment Under Test 5

 1.4. Product Specification subjective to this standard..... 6

 1.5. Modification of EUT..... 6

 1.6. Test Location..... 7

 1.7. Applicable Standards 7

2. TEST CONFIGURATION OF EQUIPMENT UNDER TEST..... 8

 2.1. Test Mode 8

 2.2. Connection Diagram of Test System 10

 2.3. Support Unit used in test configuration and system..... 11

 2.4. EUT Operation Test Setup..... 12

3. TEST RESULT..... 13

 3.1. Test of AC Conducted Emission Measurement 13

 3.2. Test of Radiated Emission Measurement 19

4. LIST OF MEASURING EQUIPMENT 23

5. UNCERTAINTY OF EVALUATION 24

APPENDIX A. SETUP PHOTOGRAPHS



SUMMARY OF TEST RESULT

Report Section	FCC Rule	Description	Limit	Result	Remark
3.1	15.107	AC Conducted Emission	< 15.107 limits	PASS	Under limit 8.75 dB at 0.510 MHz
3.2	15.109	Radiated Emission	< 15.109 limits	PASS	Under limit 1.48 dB at 199.830 MHz for Quasi-Peak



1. General Description

1.1. Applicant

CT Asia

Unit 01, 15/F, Seaview Centre, 139-141 Hoi bun road, Kwun Tong, Kowloon, Hongkong

1.2. Manufacturer

Tinno Mobile Technology Corp.

4/F, H-3 Building, OCT Eastern industrial Park, No.1 XiangShan East Road.,Nan Shan District, Shenzhen, P.R. China

1.3. Product Feature of Equipment Under Test

Product Feature	
Equipment	Smartphone
Brand Name	BLU
Model Name	ADVANCE 4.0 L
FCC ID	YHLBLUADVANCE4L
EUT supports Radios application	GSM/GPRS/EGPRS/WCDMA/HSPA/HSPA+(Downlink Only) WLAN 2.4GHz 802.11b/g/n HT20/HT40/ Bluetooth v3.0 + EDR/Bluetooth v4.0 LE
IMEI Number	Conduction: 353919026689699/353924026689699 Radiation: 353919026689681/353924026689681
HW Version	V1.0
SW Version	S4050AP_PR_4.4_BLU_US_03_01
EUT Stage	Pre-Production

Remark: The above EUT's information was declared by manufacturer. Please refer to the specifications or user's manual for more detailed description.

1.4. Product Specification subjective to this standard

Product Specification subjective to this standard	
Tx Frequency	GSM850: 824.2 MHz ~ 848.8 MHz GSM1900: 1850.2 MHz ~ 1909.8MHz WCDMA Band V: 826.4 MHz ~ 846.6 MHz WCDMA Band IV : 1712.4 MHz ~ 1752.6 MHz WCDMA Band II: 1852.4 MHz ~ 1907.6 MHz 802.11b/g/n: 2412 MHz ~ 2462 MHz Bluetooth: 2402 MHz ~ 2480 MHz
Rx Frequency	GSM850: 869.2 MHz ~ 893.8 MHz GSM1900: 1930.2 MHz ~ 1989.8 MHz WCDMA Band V: 871.4 MHz ~ 891.6 MHz WCDMA Band IV : 2112.4 MHz ~ 2152.6 MHz WCDMA Band II: 1932.4 MHz ~ 1987.6 MHz 802.11b/g/n: 2412 MHz ~ 2462 MHz Bluetooth: 2402 MHz ~ 2480 MHz GPS : 1.57542 GHz
Antenna Type	WWAN : PIFA Antenna WLAN : PIFA Antenna Bluetooth : PIFA Antenna GPS : PIFA Antenna
Type of Modulation	GSM: GMSK GPRS: GMSK EDGE(MCS 0-4): GMSK / (MCS 5-9): 8PSK WCDMA: QPSK (Uplink) HSDPA: QPSK (Uplink) HSUPA: QPSK (Uplink) HSPA+ : 16QAM (Downlink Only) 802.11b : DSSS (DBPSK / DQPSK / CCK) 802.11g/n : OFDM (BPSK / QPSK / 16QAM / 64QAM) Bluetooth LE : GFSK Bluetooth (1Mbps) : GFSK Bluetooth (2Mbps) : $\pi/4$ -DQPSK Bluetooth (3Mbps) : 8-DPSK GPS : BPSK

1.5. Modification of EUT

No modifications are made to the EUT during all test items.



1.6. Test Location

Test Site	SPORTON INTERNATIONAL (SHENZHEN) INC.	
Test Site Location	1F & 2F, Building A, Morning Business Center, No. 4003 ShiGu Rd., Xili Town, Nanshan District, Shenzhen, Guangdong, P. R. China TEL: +86-755-8637-9589 FAX: +86-755-8637-9595	
Test Site No.	Sporton Site No.	
	CO01-SZ	

Test Site	SPORTON INTERNATIONAL (SHENZHEN) INC.	
Test Site Location	No. 3 Building, the third floor of south, Shahe River west, Fengzeyuan warehouse, Nanshan District, Shenzhen, Guangdong, P. R. China TEL: +86-755- 3320-2398	
Test Site No.	Sporton Site No.	FCC Registration No.
	03CH01-SZ	831040

1.7. Applicable Standards

According to the specifications of the manufacturer, the EUT must comply with the requirements of the following standards:

- ♦ FCC 47 CFR FCC Part 15 Subpart B
- ♦ ANSI C63.4-2009

Remark: All test items were verified and recorded according to the standards and without any deviation during the test.

2. Test Configuration of Equipment Under Test

2.1. Test Mode

The EUT has been associated with peripherals pursuant to ANSI C63.4-2009 and configuration operated in a manner tended to maximize its emission characteristics in a typical application.

Frequency range investigated: conduction (150 kHz to 30 MHz), radiation (30MHz to the 5th harmonic of the highest fundamental frequency or to 40 GHz, whichever is lower).

The following tables are showing the test modes as the worst cases and recorded in this report.

Item	EUT Configuration	Test Condition		
		EMI AC	EMI RE<1G	EMI RE≥1G
1.	Charging Mode (EUT with adapter)	<input checked="" type="checkbox"/>	<input checked="" type="checkbox"/>	Note1
2.	Data application transferred mode (EUT with notebook)	<input checked="" type="checkbox"/>	<input checked="" type="checkbox"/>	<input checked="" type="checkbox"/>

Abbreviations:

- EMI AC: AC conducted emissions
- EMI RE ≥ 1G: EUT radiated emissions ≥ 1GHz
- EMI RE < 1G: EUT radiated emissions < 1GHz

Note 1: Testing for this mode is not required or not the worst case.

Remark: For signal above 1GHz, the worst case was test item 2.



Test Items	EUT Configure Mode	Function Type
AC Conducted Emission	1/2	Mode 1: GSM850 Idle + Bluetooth Idle + WLAN Idle + USB Cable (Charging from Adapter) + Earphone + Camera + SIM 1 Mode 2: GSM1900 Idle + Bluetooth Idle + WLAN Idle + Earphone + USB Cable (Charging from Adapter) + MPEG4 + SIM 1 Mode 3: WCDMA Band V Idle + Bluetooth Idle + WLAN Idle + Earphone + USB Cable (Data Link with Notebook) + GPS Rx + SIM 1
Radiated Emissions < 1GHz	1/2	Mode 1: GSM850 Idle + Bluetooth Idle + WLAN Idle + USB Cable (Charging from Adapter) + Earphone + Camera + SIM 1 Mode 2: GSM1900 Idle + Bluetooth Idle + WLAN Idle + Earphone + USB Cable (Charging from Adapter) + MPEG4 + SIM 1 Mode 3: WCDMA Band V Idle + Bluetooth Idle + WLAN Idle + Earphone + USB Cable (Data Link with Notebook) + GPS Rx + SIM 1
Radiated Emissions ≥ 1GHz	2	Mode 1: WCDMA Band V Idle + Bluetooth Idle + WLAN Idle + Earphone + USB Cable (Data Link with Notebook) + GPS Rx + SIM 1

Remark:

1. The worst case of AC is mode 1; and the USB Link mode of AC is mode 3; the test data of these modes are reported.
2. The worst case of RE < 1G is mode 3; only the test data of this mode was reported.
3. Link with Notebook means data application transferred mode between EUT and Notebook.

2.2. Connection Diagram of Test System

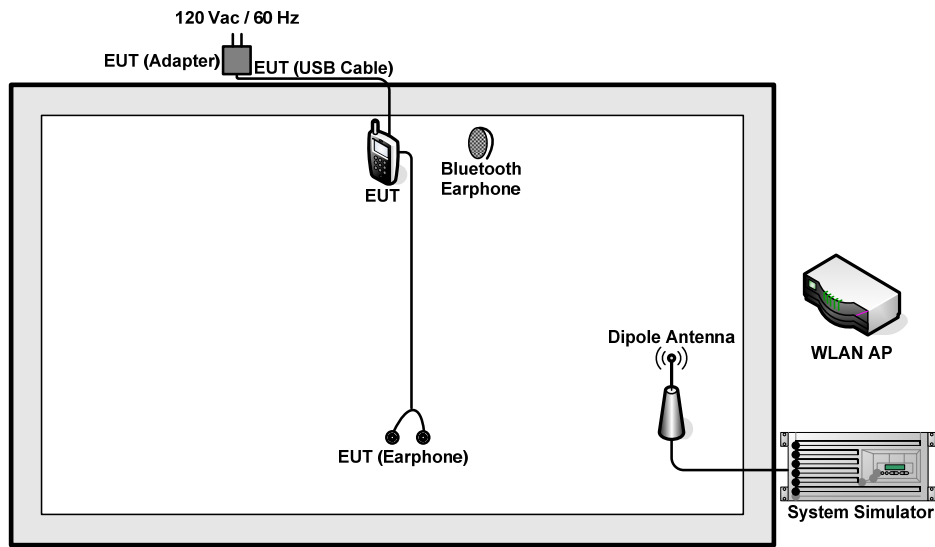

<Fig.1>

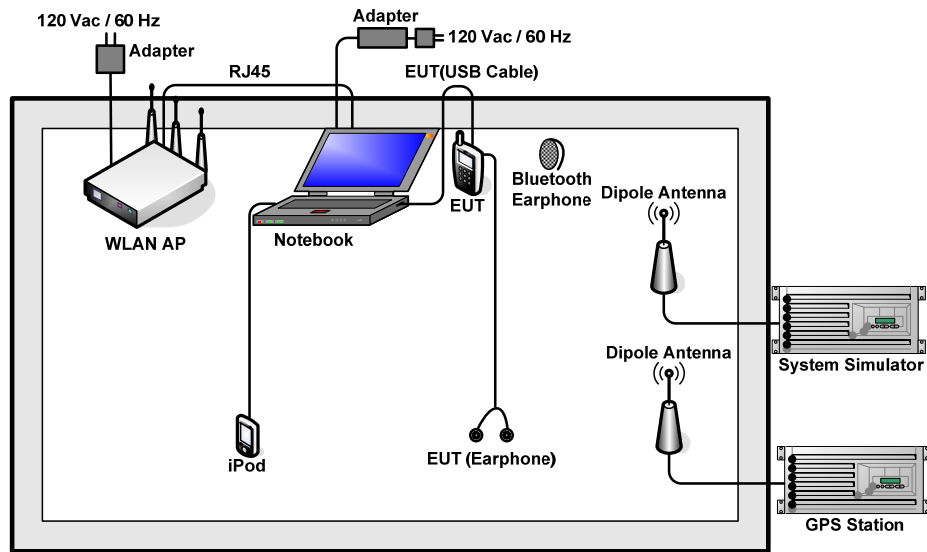

<Fig.2>



2.3. Support Unit used in test configuration and system

Item	Equipment	Trade Name	Model Name	FCC ID	Data Cable	Power Cord
1.	System Simulator	R&S	CMU 200	N/A	N/A	Unshielded, 1.8 m
2.	GPS Station	ADIVIC	MP9000	N/A	N/A	Unshielded, 1.8 m
3.	WLAN AP	D-link	DIR-815	KA2IR815A1	N/A	Unshielded, 1.8 m
4.	WLAN AP	ASUSTek	RT-AC66U	MSQ-RTAC66U	N/A	Unshielded, 2.7m
5.	Notebook	Lenovo	E540	FCC DoC	N/A	AC I/P: Unshielded, 1.2m DC O/P: Shielded, 1.8 m
6.	Bluetooth Earphone	Lenovo	LBH301	N/A	N/A	N/A
7.	Bluetooth Earphone	Nokia	BH-108	PYAHS-107W	N/A	N/A
8.	SD Card	SanDisk	4G class 4	FCC DoC	N/A	N/A
9.	iPod	Apple	MC525 ZP/A	FCC DoC	Shielded, 1.0 m	N/A
10.	iPod nano 8GB	Apple	MC690 ZP/A	FCC DoC	Shielded, 1.2 m	N/A



2.4. EUT Operation Test Setup

The EUT was in GSM or WCDMA idle mode during the testing. The EUT was synchronized to the BCCH, and is in continuous receiving mode by setting system simulator's paging reorganization.

At the same time, the EUT was attached to the Bluetooth earphone or WLAN AP, and the following programs installed in the EUT were programmed during the test.

1. Execute the program, "Winthrax" under WIN7 installed in notebook for files transfer with EUT via USB cable.
2. Turn on GPS function to make the EUT receive continuous signals from GPS station.
3. Execute "Video Player" to play MPEG4 files.
4. Turn on camera to capture images

3. Test Result

3.1. Test of AC Conducted Emission Measurement

3.1.1 Limits of AC Conducted Emission

For equipment that is designed to be connected to the public utility (AC) power line, the radio frequency voltage that is conducted back onto the AC power line on any frequency or frequencies within the band 150 kHz to 30 MHz shall not exceed the limits in the following table.

Frequency of emission (MHz)	Conducted limit (dBuV)	
	Quasi-peak	Average
0.15-0.5	66 to 56*	56 to 46*
0.5-5	56	46
5-30	60	50

*Decreases with the logarithm of the frequency.

3.1.2 Measuring Instruments

The measuring equipment is listed in the section 4 of this test report.

3.1.3 Test Procedure

1. The EUT was placed 0.4 meter from the conducting wall of the shielding room was kept at least 80 centimeters from any other grounded conducting surface.
2. Connect EUT to the power mains through a line impedance stabilization network (LISN).
3. All the support units are connecting to the other LISN.
4. The LISN provides 50 ohm coupling impedance for the measuring instrument.
5. The FCC states that a 50 ohm, 50 microhenry LISN should be used.
6. Both sides of AC line were checked for maximum conducted interference.
7. The frequency range from 150 kHz to 30 MHz was searched.
8. Set the test-receiver system to Peak Detect Function and specified bandwidth (IF Bandwidth = 9kHz) with Maximum Hold Mode. Then measurement is also conducted by Average Detector and Quasi-Peak Detector Function respectively.

3.1.4 Test Setup

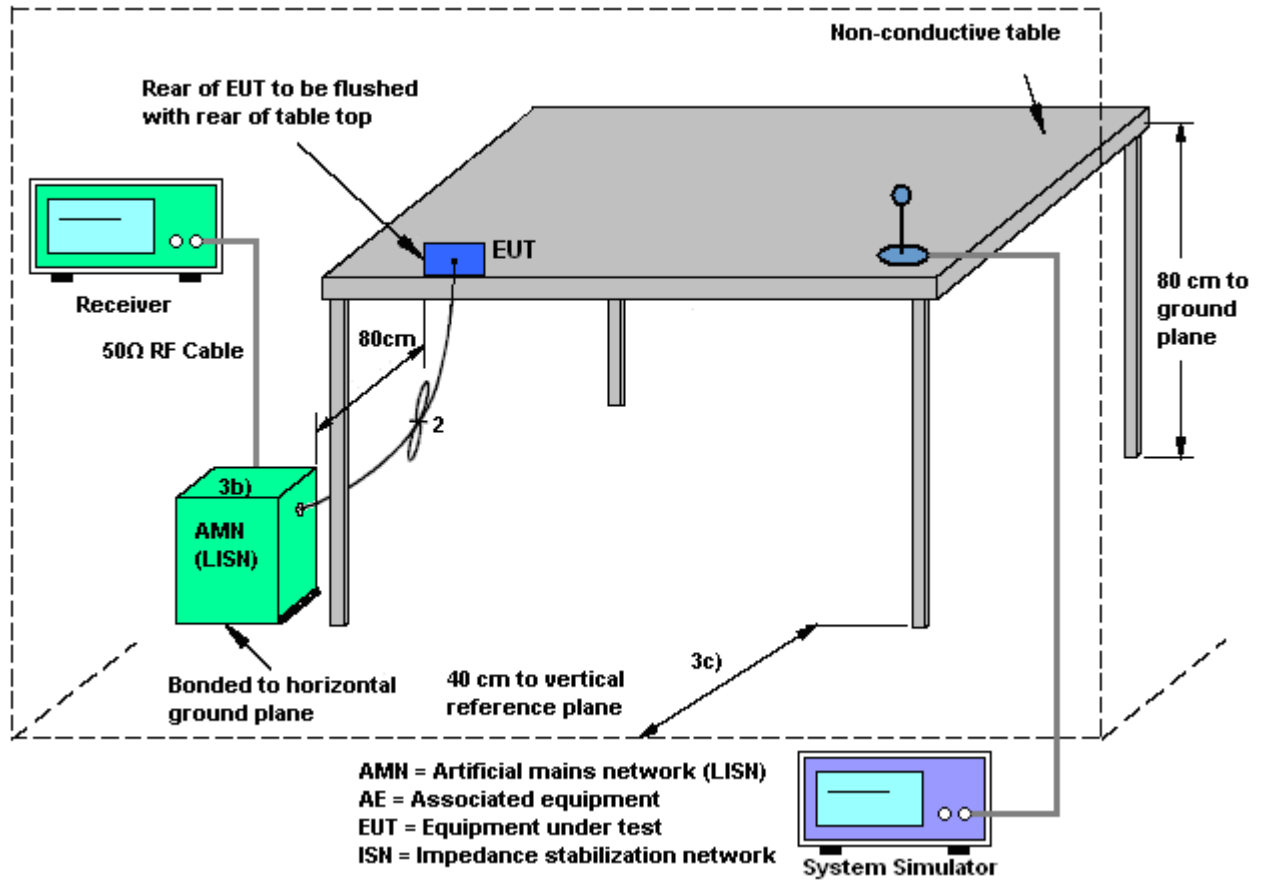



3.1.5 Test Result of AC Conducted Emission

Test Mode :	Mode 1	Temperature :	21~22°C
Test Engineer :	Jack Tian	Relative Humidity :	41~42%
Test Voltage :	120Vac / 60Hz	Phase :	Line
Function Type :	GSM850 Idle + Bluetooth Idle + WLAN Idle + USB Cable (Charging from Adapter) + Earphone + Camera + SIM 1		

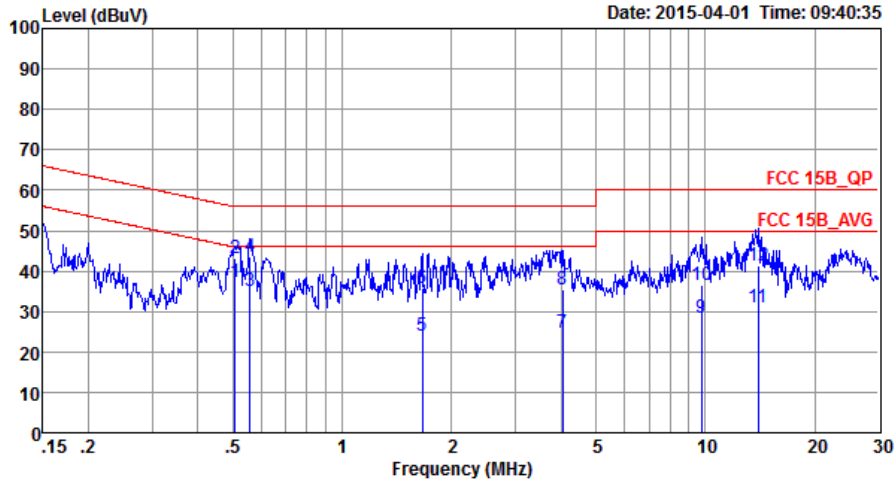

Site : CO01-SZ
 Condition: FCC 15B_QP LISN_L_20140304 LINE
 Project : (FC)532405
 Mode : Mode 1

	Freq	Level	Over	Limit	Read	LISN	Cable	
	MHz	dBuV	Limit	Line	Level	Factor	Loss	Remark
			dB	dBuV	dBuV	dB	dB	
1 *	0.51	37.25	-8.75	46.00	26.80	0.29	10.16	Average
2	0.51	43.05	-12.95	56.00	32.60	0.29	10.16	QP
3	0.56	35.01	-10.99	46.00	24.60	0.26	10.15	Average
4	0.56	43.71	-12.29	56.00	33.30	0.26	10.15	QP
5	1.66	23.81	-22.19	46.00	13.40	0.23	10.18	Average
6	1.66	35.61	-20.39	56.00	25.20	0.23	10.18	QP
7	4.05	24.90	-21.10	46.00	14.30	0.37	10.23	Average
8	4.05	35.60	-20.40	56.00	25.00	0.37	10.23	QP
9	9.76	28.45	-21.55	50.00	17.50	0.63	10.32	Average
10	9.76	36.65	-23.35	60.00	25.70	0.63	10.32	QP
11	13.99	31.10	-18.90	50.00	19.30	1.31	10.49	Average
12	13.99	41.50	-18.50	60.00	29.70	1.31	10.49	QP



Test Mode :	Mode 1	Temperature :	21~22°C
Test Engineer :	Jack Tian	Relative Humidity :	41~42%
Test Voltage :	120Vac / 60Hz	Phase :	Neutral
Function Type :	GSM850 Idle + Bluetooth Idle + WLAN Idle + USB Cable (Charging from Adapter) + Earphone + Camera + SIM 1		

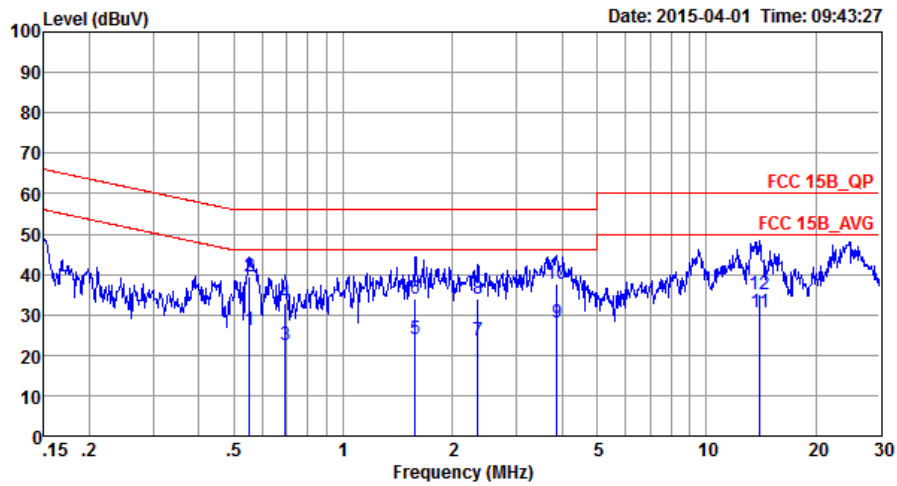

Site : C001-SZ
 Condition: FCC 15B_QP LISN_N_20140304 NEUTRAL
 Project : (FC)532405
 Mode : Mode 1

	Freq	Level	Over Limit	Limit Line	Read Level	LISN Factor	Cable Loss	Remark
	MHz	dBuV	dB	dBuV	dBuV	dB	dB	
1	0.55	26.21	-19.79	46.00	15.70	0.36	10.15	Average
2 *	0.55	39.61	-16.39	56.00	29.10	0.36	10.15	QP
3	0.69	22.60	-23.40	46.00	12.20	0.25	10.15	Average
4	0.69	32.70	-23.30	56.00	22.30	0.25	10.15	QP
5	1.58	23.93	-22.07	46.00	13.39	0.36	10.18	Average
6	1.58	33.83	-22.17	56.00	23.29	0.36	10.18	QP
7	2.35	23.59	-22.41	46.00	13.00	0.39	10.20	Average
8	2.35	33.99	-22.01	56.00	23.40	0.39	10.20	QP
9	3.88	28.08	-17.92	46.00	17.39	0.46	10.23	Average
10	3.88	37.58	-18.42	56.00	26.89	0.46	10.23	QP
11	14.06	30.47	-19.53	50.00	18.49	1.48	10.50	Average
12	14.06	35.07	-24.93	60.00	23.09	1.48	10.50	QP



Test Mode :	Mode 3	Temperature :	21~22°C
Test Engineer :	Jack Tian	Relative Humidity :	41~42%
Test Voltage :	120Vac / 60Hz	Phase :	Line
Function Type :	WCDMA Band V Idle + Bluetooth Idle + WLAN Idle + Earphone + USB Cable (Data Link with Notebook) + GPS Rx + SIM 1		

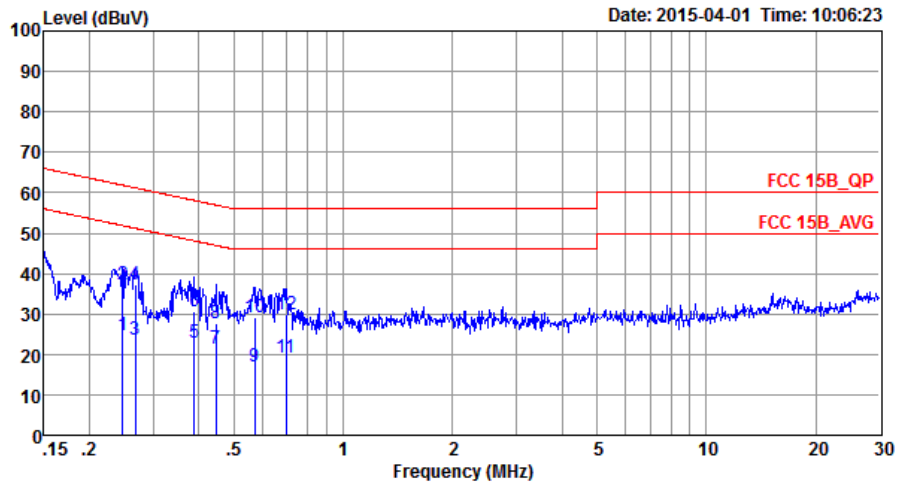

Site : C001-SZ
 Condition: FCC 15B_QP LISN_L_20140304 LINE
 Project : (FC)532405
 Mode : Mode 3

	Freq	Level	Over Limit	Limit Line	Read Level	LISN Factor	Cable Loss	Remark
	MHz	dBuV	dB	dBuV	dBuV	dB	dB	
1	0.25	24.58	-27.28	51.86	14.09	0.24	10.25	Average
2	0.25	37.28	-24.58	61.86	26.79	0.24	10.25	QP
3	0.27	23.57	-27.63	51.20	13.09	0.25	10.23	Average
4 *	0.27	37.27	-23.93	61.20	26.79	0.25	10.23	QP
5	0.39	22.85	-25.23	48.08	12.40	0.28	10.17	Average
6	0.39	30.75	-27.33	58.08	20.30	0.28	10.17	QP
7	0.45	21.35	-25.58	46.93	10.90	0.29	10.16	Average
8	0.45	27.75	-29.18	56.93	17.30	0.29	10.16	QP
9	0.57	17.11	-28.89	46.00	6.71	0.25	10.15	Average
10	0.57	29.01	-26.99	56.00	18.61	0.25	10.15	QP
11	0.70	19.33	-26.67	46.00	9.00	0.18	10.15	Average
12	0.70	30.03	-25.97	56.00	19.70	0.18	10.15	QP



Test Mode :	Mode 3	Temperature :	21~22°C
Test Engineer :	Jack Tian	Relative Humidity :	41~42%
Test Voltage :	120Vac / 60Hz	Phase :	Neutral
Function Type :	WCDMA Band V Idle + Bluetooth Idle + WLAN Idle + Earphone + USB Cable (Data Link with Notebook) + GPS Rx + SIM 1		

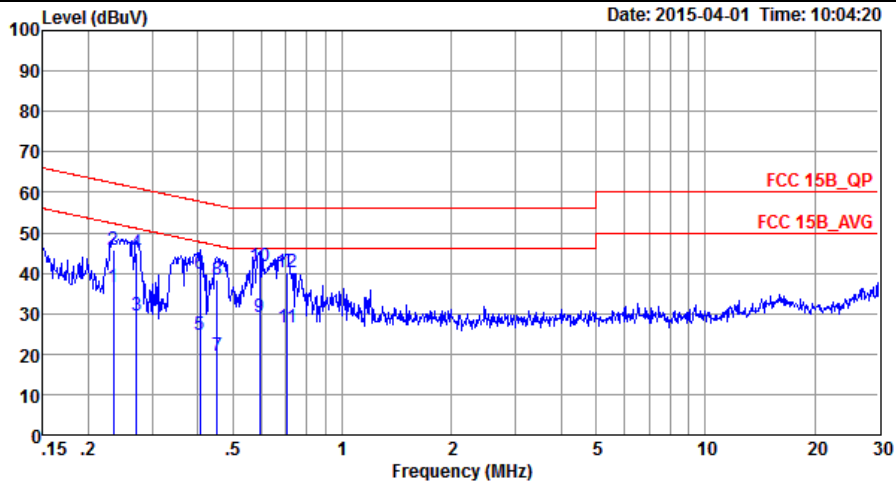

Site : C001-SZ
 Condition: FCC 15B_QP LISN_N_20140304 NEUTRAL
 Project : (FC)532405
 Mode : Mode 3

	Freq	Level	Over Limit	Limit Line	Read Level	LISN Factor	Cable Loss	Remark
	MHz	dBuV	dB	dBuV	dBuV	dB	dB	
1	0.23	36.39	-15.91	52.30	25.79	0.34	10.26	Average
2	0.23	45.69	-16.61	62.30	35.09	0.34	10.26	QP
3	0.27	29.67	-21.40	51.07	19.10	0.35	10.22	Average
4	0.27	44.97	-16.10	61.07	34.40	0.35	10.22	QP
5	0.41	24.56	-23.17	47.73	14.00	0.39	10.17	Average
6	0.41	39.96	-17.77	57.73	29.40	0.39	10.17	QP
7	0.45	19.56	-27.29	46.85	9.00	0.40	10.16	Average
8	0.45	38.26	-18.59	56.85	27.70	0.40	10.16	QP
9	0.59	29.08	-16.92	46.00	18.60	0.33	10.15	Average
10 *	0.59	41.68	-14.32	56.00	31.20	0.33	10.15	QP
11	0.70	26.40	-19.60	46.00	16.00	0.25	10.15	Average
12	0.70	40.20	-15.80	56.00	29.80	0.25	10.15	QP



3.2. Test of Radiated Emission Measurement

3.2.1. Limit of Radiated Emission

The emissions from an unintentional radiator shall not exceed the field strength levels specified in the following table:

Frequency (MHz)	Field Strength (microvolts/meter)	Measurement Distance (meters)
30 – 88	100	3
88 – 216	150	3
216 - 960	200	3
Above 960	500	3

3.2.2. Measuring Instruments

The measuring equipment is listed in the section 4 of this test report.

3.2.3. Test Procedures

1. The EUT was placed on a turntable with 0.8 meter above ground.
2. The EUT was set 3 meters from the interference receiving antenna, which was mounted on the top of a variable height antenna tower.
3. The table was rotated 360 degrees to determine the position of the highest radiation.
4. The antenna is a Bi-Log antenna and its height is adjusted between one to four meters above ground to find the maximum value of the field strength for both horizontal polarization and vertical polarization of the antenna.
5. For each suspected emission, the EUT was arranged to its worst case and then tune the antenna tower (from 1 m to 4 m) and turntable (from 0 degree to 360 degrees) to find the maximum reading.
6. Set the test-receiver system to Peak Detect Function and specified bandwidth with Maximum Hold Mode (RBW=120kHz/VBW=300kHz for frequency below 1GHz; RBW=1MHz VBW=3MHz (Peak), RBW=1MHz/VBW=10Hz (Average) for frequency above 1GHz).
7. If the emission level of the EUT in peak mode was 3 dB lower than the limit specified, peak values of EUT will be reported. Otherwise, the emission will be repeated by using the quasi-peak method and reported.
8. Emission level (dBµV/m) = 20 log Emission level (µV/m)
9. Corrected Reading: Antenna Factor + Cable Loss + Read Level - Preamp Factor = Level

3.2.4. Test Setup of Radiated Emission

For radiated emissions from 30MHz to 1GHz

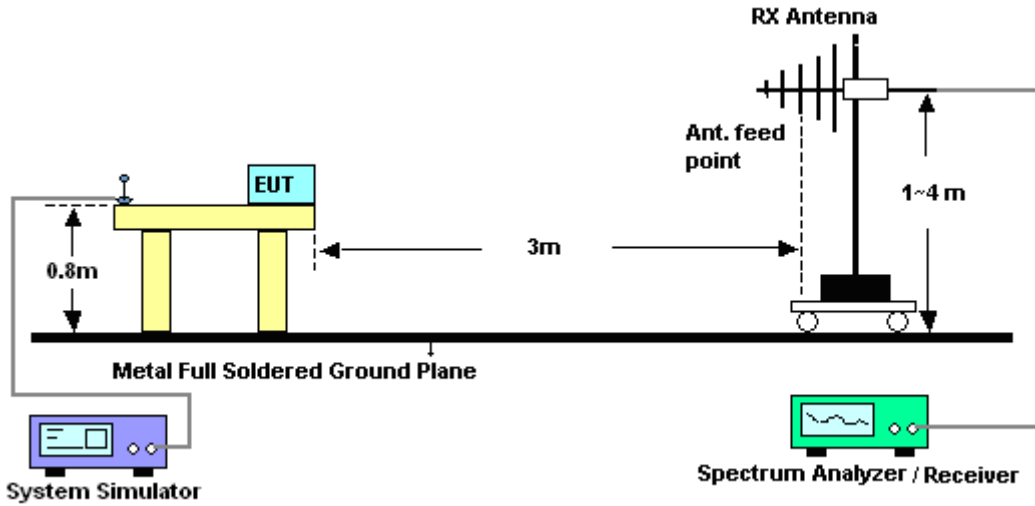

For radiated emissions above 1GHz

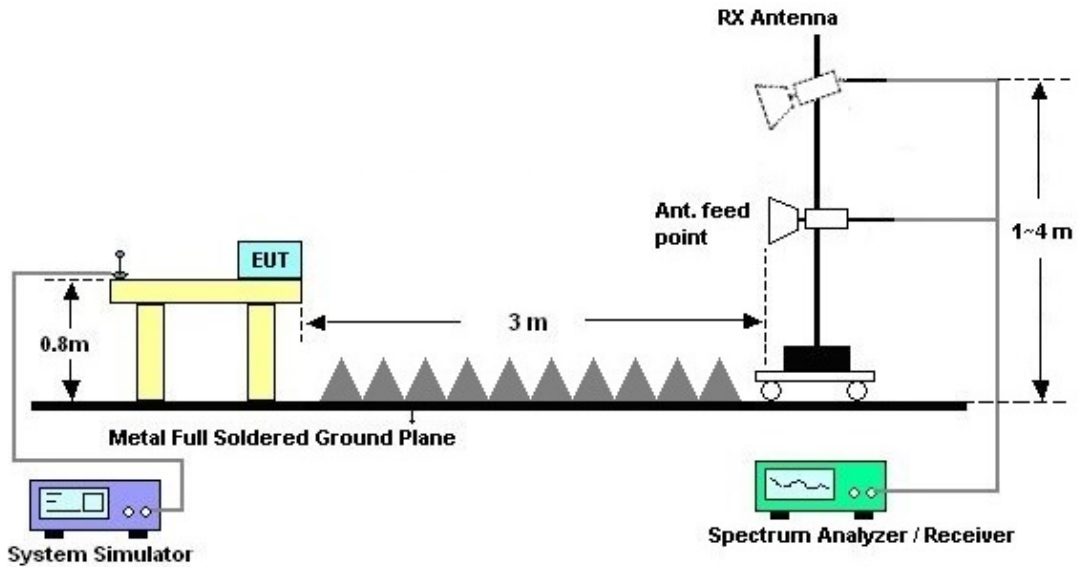



3.2.5. Test Result of Radiated Emission

Test Mode :	Mode 3	Temperature :	24~25°C
Test Engineer :	Leo Liao	Relative Humidity :	50~52%
Test Distance :	3m	Polarization :	Horizontal
Function Type :	WCDMA Band V Idle + Bluetooth Idle + WLAN Idle + Earphone + USB Cable (Data Link with Notebook) + GPS Rx + SIM 1		
Remark :	#7 is system simulator signal which can be ignored.		

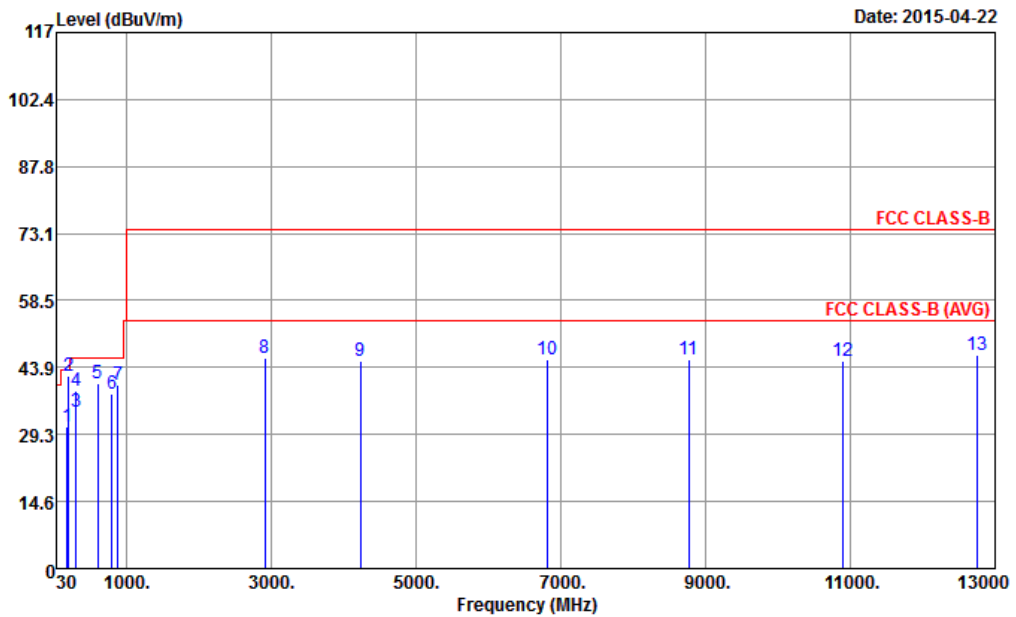

Site : 03CH01-SZ
 Condition : FCC CLASS-B 3m LF_ANT_141107 HORIZONTAL
 Project : (FC)532405
 Mode : Mode 3

	Freq	Level	Over Limit	Limit Line	ReadAntenna Level	Antenna Factor	Cable Loss	Preamp Factor	A/Pos	T/Pos	Remark
	MHz	dBuV/m	dB	dBuV/m	dBuV	dB/m	dB	dB	cm	deg	
1	176.88	31.02	-12.48	43.50	42.69	11.63	2.07	25.37	---	---	Peak
2	199.83	42.02	-1.48	43.50	53.47	11.60	2.20	25.25	100	230	QP
3	299.19	34.16	-11.84	46.00	42.37	14.10	2.73	25.04	---	---	Peak
4	307.70	38.89	-7.11	46.00	47.02	14.20	2.77	25.10	---	---	Peak
5	599.60	40.41	-5.59	46.00	43.21	19.70	3.94	26.44	---	---	Peak
6	799.80	38.22	-7.78	46.00	37.30	22.50	4.59	26.17	---	---	Peak
7	881.00	39.96			39.24	21.77	4.88	25.93	---	---	Peak
8	2912.00	45.81	-28.19	74.00	31.89	33.02	9.68	28.78	---	---	Peak
9	4230.00	45.35	-28.65	74.00	26.98	34.04	12.34	28.01	---	---	Peak
10	6812.00	45.59	-28.41	74.00	22.22	36.18	14.52	27.33	---	---	Peak
11	8766.00	45.61	-28.39	74.00	18.43	36.52	16.78	26.12	---	---	Peak
12	10892.00	45.25	-28.75	74.00	13.42	38.74	17.62	24.53	---	---	Peak
13	12760.00	46.58	-27.42	74.00	13.14	39.14	18.70	24.40	100	215	Peak



Test Mode :	Mode 3	Temperature :	24~25°C
Test Engineer :	Leo Liao	Relative Humidity :	50~52%
Test Distance :	3m	Polarization :	Vertical
Function Type :	WCDMA Band V Idle + Bluetooth Idle + WLAN Idle + Earphone + USB Cable (Data Link with Notebook) + GPS Rx + SIM 1		
Remark :	#7 is system simulator signal which can be ignored.		

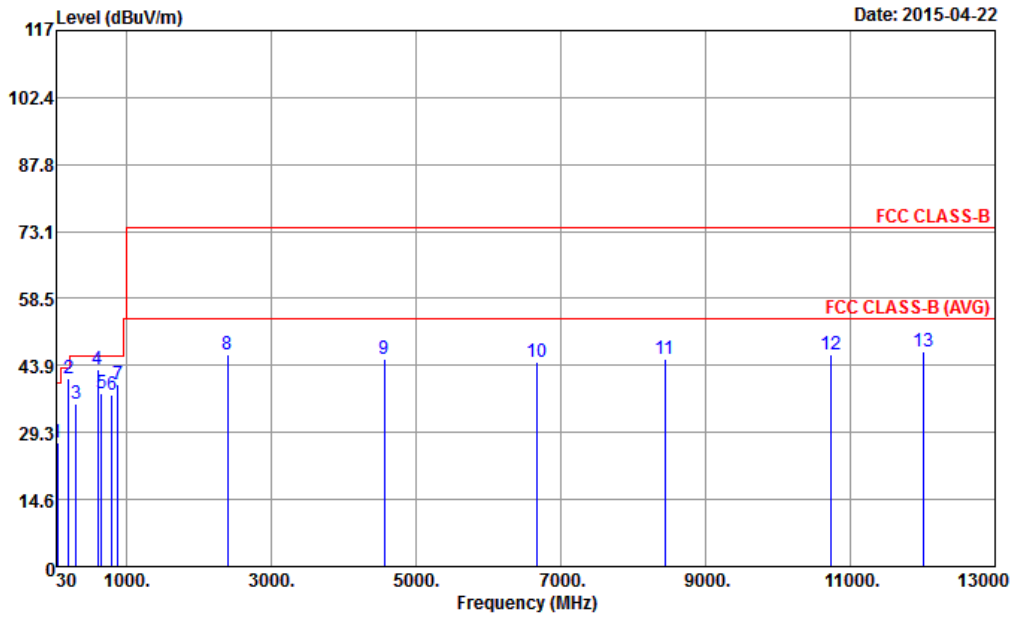

Site : 03CH01-SZ
 Condition : FCC CLASS-B 3m LF_ANT_141107 VERTICAL
 Project : (FC)532405
 Mode : Mode 3

	Freq	Level	Over	Limit	ReadAntenna	Cable	Preamp	A/Pos	T/Pos	Remark	
	MHz	dBuV/m	dB	dBuV/m	dBuV	dB/m	dB	dB	cm	deg	
1	45.66	26.94	-13.06	40.00	39.90	11.99	1.03	25.98	---	---	Peak
2	199.83	41.04	-2.46	43.50	52.49	11.60	2.20	25.25	100	270	QP
3	299.19	35.41	-10.59	46.00	43.62	14.10	2.73	25.04	---	---	Peak
4	599.60	42.97	-3.03	46.00	45.77	19.70	3.94	26.44	---	---	Peak
5	658.40	37.73	-8.27	46.00	39.84	20.05	4.24	26.40	---	---	Peak
6	799.80	37.58	-8.42	46.00	36.66	22.50	4.59	26.17	---	---	Peak
7	881.70	39.87			39.14	21.77	4.89	25.93	---	---	Peak
8	2396.00	46.21	-27.79	74.00	34.27	32.60	8.60	29.26	---	---	Peak
9	4558.00	45.15	-28.85	74.00	26.50	34.23	12.78	28.36	---	---	Peak
10	6666.00	44.70	-29.30	74.00	21.48	36.24	14.50	27.52	---	---	Peak
11	8440.00	45.31	-28.69	74.00	19.13	36.23	16.18	26.23	---	---	Peak
12	10742.00	46.34	-27.66	74.00	15.06	38.64	17.17	24.53	---	---	Peak
13	12020.00	46.92	-27.08	74.00	13.56	39.49	18.13	24.26	100	236	Peak



4. List of Measuring Equipment

Instrument	Manufacturer	Model No.	Serial No.	Characteristics	Calibration Date	Test Date	Due Date	Remark
EMI Test Receiver&SA	Agilent Technologies	N9038A	MY52260185	20Hz~26.5GHz	May 26, 2014	Apr. 22, 2015	May 25, 2015	Radiation (03CH01-SZ)
Spectrum Analyzer	R&S	FSV40	101041	10kHz~40GHz; Max 30dBm	Sep. 25, 2014	Apr. 22, 2015	Sep. 24, 2015	Radiation (03CH01-SZ)
Bilog Antenna	TeseQ	CBL6112D	23188	30MHz~2GHz	Nov. 07, 2014	Apr. 22, 2015	Nov. 06, 2015	Radiation (03CH01-SZ)
Double Ridge Horn Antenna	ETS-Lindgren	3117	00119436	1GHz~18GHz	Oct. 15, 2014	Apr. 22, 2015	Oct. 14, 2015	Radiation (03CH01-SZ)
Amplifier	ADVANTEST	BB525C	E9007003	9kHz~3000MHz / 30 dB	Jan. 28, 2015	Apr. 22, 2015	Jan. 27, 2016	Radiation (03CH01-SZ)
Amplifier	MITEQ	AMF-7D-0010 1800-30-10P-R	1707137	1GHz~18GHz	May 08, 2014	Apr. 22, 2015	May 07, 2015	Radiation (03CH01-SZ)
AC Power Source	Chroma	61601	61601000198 5	N/A	NCR	Apr. 22, 2015	NCR	Radiation (03CH01-SZ)
Turn Table	EM	EM1000	N/A	0~360 degree	NCR	Apr. 22, 2015	NCR	Radiation (03CH01-SZ)
Antenna Mast	EM	EM1000	N/A	1 m~4 m	NCR	Apr. 22, 2015	NCR	Radiation (03CH01-SZ)
EMI TEST Receiver	R&S	ESC17	100768	9kHz~3GHz	May 04, 2014	Apr. 01, 2015	May 03, 2015	Conduction (CO01-SZ)
AC LISN	EMCO	3816/2SH	00103912	9kHz~30MHz	Feb. 02, 2015	Apr. 01, 2015	Feb. 01, 2016	Conduction (CO01-SZ)
AC LISN (for auxiliary equipment)	EMCO	3816/2SH	00103892	9kHz~30MHz	Feb. 02, 2015	Apr. 01, 2015	Feb. 01, 2016	Conduction (CO01-SZ)
AC Power Source	Chroma	61602	61602000089 1	100Vac~250Vac	Sep. 29, 2014	Apr. 01, 2015	Sep. 28, 2015	Conduction (CO01-SZ)



5. Uncertainty of Evaluation

Uncertainty of Conducted Emission Measurement (150 kHz ~ 30 MHz)

Measuring Uncertainty for a Level of Confidence of 95% ($U = 2Uc(y)$)	2.3dB
---	-------

Uncertainty of Radiated Emission Measurement (30 MHz ~ 1000 MHz)

Measuring Uncertainty for a Level of Confidence of 95% ($U = 2Uc(y)$)	3.9dB
---	-------