



## Version

Version No.	Date	Description
V1.0	Oct. 15, 2018	Original



**Shenzhen UnionTrust Quality and Technology Co., Ltd.**

Address: 16/F, Block A, Building 6, Baoneng Science and Technology Park, Qingxiang Road No.1, Longhua New District, Shenzhen, China  
Tel: +86-755-28230888      Fax: +86-755-28230886      E-mail: [info@uttlab.com](mailto:info@uttlab.com)      [Http://www.uttlab.com](http://www.uttlab.com)

## Contents

	Page
<b>1 GENERAL INFORMATION .....</b>	<b>5</b>
<b>1.1 STATEMENT OF COMPLIANCE.....</b>	<b>5</b>
<b>1.2 EUT DESCRIPTION.....</b>	<b>6</b>
1.2.1 General Description.....	6
1.2.2 Wireless Technologies.....	6
1.2.3 List of Accessory.....	6
<b>1.3 MAXIMUM CONDUCTED POWER .....</b>	<b>7</b>
<b>1.4 OTHER INFORMATION.....</b>	<b>8</b>
<b>1.5 TESTING LOCATION .....</b>	<b>8</b>
<b>1.6 TEST FACILITY .....</b>	<b>8</b>
<b>1.7 GUIDANCE STANDARD .....</b>	<b>9</b>
<b>2 SPECIFIC ABSORPTION RATE (SAR).....</b>	<b>10</b>
<b>2.1 INTRODUCTION .....</b>	<b>10</b>
<b>2.2 SAR DEFINITION.....</b>	<b>10</b>
<b>2.3 SAR LIMITS .....</b>	<b>10</b>
<b>3 SAR MEASUREMENT SYSTEM .....</b>	<b>11</b>
<b>3.1 SPEAG DASY SYSTEM .....</b>	<b>11</b>
3.1.1 Robot .....	11
3.1.2 Probe .....	12
3.1.3 Data Acquisition Electronics (DAE) .....	12
3.1.4 Phantom .....	13
3.1.5 Device Holder .....	14
3.1.6 System Validation Dipoles.....	14
<b>3.2 SAR SCAN PROCEDURE.....</b>	<b>15</b>
3.2.1 SAR Reference Measurement (drift) .....	15
3.2.2 Area Scan.....	15
3.2.3 Zoom Scan .....	15
3.2.4 SAR Drift Measurement.....	16
<b>3.3 TEST EQUIPMENT .....</b>	<b>17</b>
<b>3.4 MEASUREMENT UNCERTAINTY.....</b>	<b>18</b>
<b>3.5 TISSUE DIELECTRIC PARAMETER MEASUREMENT &amp; SYSTEM VERIFICATION .....</b>	<b>19</b>
3.5.1 Tissue Simulating Liquids.....	19
3.5.2 System Check Description .....	21
3.5.3 Tissue Verification.....	22
3.5.4 System Verification .....	22
<b>4 SAR MEASUREMENT EVALUATION.....</b>	<b>23</b>
<b>4.1 EUT CONFIGURATION AND SETTING.....</b>	<b>23</b>
4.1.1 GSM Configuration and Testing .....	23
<b>4.2 EUT TESTING POSITION.....</b>	<b>23</b>
4.2.1 Head Exposure Conditions.....	23
4.2.2 Body-worn Accessory Exposure Conditions .....	25
<b>4.3 MEASURED CONDUCTED POWER RESULT .....</b>	<b>26</b>
4.3.1 Conducted Power of GSM Band .....	26
4.3.2 Conducted Power of BT .....	26
<b>4.4 SAR TEST EXCLUSION EVALUATIONS .....</b>	<b>27</b>
4.4.1 Standalone SAR Test Exclusion Considerations.....	27
4.4.2 Estimated SAR Calculation .....	28
<b>4.5 SAR TESTING RESULTS.....</b>	<b>29</b>
4.5.1 SAR Test Reduction Considerations .....	29
4.5.2 SAR Results for Head Exposure Condition.....	30

4.5.3 SAR Results for Body-worn Exposure Condition (Separation Distance is 1.0 cm) ..... 30

**4.6 SAR MEASUREMENT VARIABILITY ..... 31**

4.6.1 Repeated Measurement..... 31

**4.7 SIMULTANEOUS MULTI-BAND TRANSMISSION EVALUATION ..... 32**

4.7.1 Simultaneous Transmission SAR Test Exclusion Considerations..... 32

4.7.2 Simultaneous Transmission Possibilities..... 33

4.7.3 Max. Standalone SAR ..... 33

4.7.4 Sum of SAR..... 33

- Appendix A. SAR Plots of System Verification**
- Appendix B. SAR Plots of SAR Measurement**
- Appendix C. Calibration Certificate for Probe and Dipole**
- Appendix D. Photographs of EUT and Setup**

# 1 General Information

## 1.1 Statement of Compliance

The maximum results of Specific Absorption Rate (SAR) found during testing for the EUT are as follows:

Equipment Class	Mode	Highest Reported Head SAR <sub>1g</sub> (W/kg)	Highest Reported Body-worn SAR <sub>1g</sub> (1.0 cm Gap) (W/kg)
PCE	GSM850	1.17	1.24
	GSM1900	0.57	0.77
DSS	Bluetooth	N/A	N/A
Highest Simultaneous Transmission SAR		Head (W/kg)	Body-worn (W/kg)
PCE + DSS		1.41	1.36

## 1.2 EUT Description

### 1.2.1 General Description

Product Name	Feature Phone
Trade mark	BLU
Model No.(EUT)	A100
FCC ID	YHLBLUA100
IMEI Code	869748022389948 869748022389955
Tx Frequency Bands (Unit: MHz)	GSM850: 824.2 ~ 848.8 GSM1900: 1850.2 ~ 1909.8 Bluetooth: 2402 ~ 2480
Device Class	B
Antenna Type	Fixed Internal Antenna
EUT Stage	Identical Prototype

### 1.2.2 Wireless Technologies

GSM	Voice GPRS (Multi-Slot Class: 12-4UP)
Bluetooth	Bluetooth V2.1+EDR
Dual SIM	SIM 1: GSM SIM 2: GSM Note : This device support dual SIM but they share the same antenna. Since these two SIM are used for subscriber identification only and it is not related to RF identity, only SIM1 was used for SAR testing.

### 1.2.3 List of Accessory

Battery	Brand Name	BLU
	Model Name	N5C600T
	Power Rating	3.7Vdc, 600mAh
	Type	Li-ion

### 1.3 Maximum Conducted Power

The maximum conducted average power (Unit: dBm) including tune-up tolerance is shown as below.

Mode	GSM850	GSM1900
GSM (GMSK, 1Tx-slot)	32.0	29.0
GPRS (GMSK, 1Tx-slot)	32.0	29.0
GPRS (GMSK, 2Tx-slot)	30.5	27.0
GPRS (GMSK, 3Tx-slot)	28.5	25.5
GPRS (GMSK, 4Tx-slot)	26.5	23.5

Mode		2.4G Bluetooth
BT	GFSK	7.5
	$\pi/4$ -DQPSK	7.0
	8-DPSK	7.0

### 1.4 Other Information

Sample Received Date:	Oct. 02, 2018
Sample tested Date:	Oct. 12, 2018 ~ Oct. 13, 2018

### 1.5 Testing Location

Shenzhen UnionTrust Quality and Technology Co., Ltd.	
Address: Address: 16/F, Block A, Building 6, Baoneng Science and Technology Park, Qingxiang Road No.1, Longhua New District, Shenzhen, China	
Telephone: +86-755-28230888	Fax: +86-755-28230886
Mail: <a href="mailto:info@uttlab.com">info@uttlab.com</a>	Website: <a href="http://www.uttlab.com">Http://www.uttlab.com</a>

### 1.6 Test Facility

The test facility is recognized, certified, or accredited by the following organizations:

**CNAS-Lab Code: L9069**

The measuring equipment utilized to perform the tests documented in this report has been calibrated once a year or in accordance with the manufacturer's recommendations, and is traceable under the ISO/IEC/EN 17025 to international or national standards. Equipment has been calibrated by accredited calibration laboratories.

**IC-Registration No.: 21600-1**

The 3m Semi-anechoic chamber of Shenzhen UnionTrust Quality and Technology Co., Ltd. has been registered by Certification and Engineering Bureau of Industry Canada for radio equipment testing with Registration No.: 21600-1.

**A2LA-Lab Certificate No.: 4312.01**

Shenzhen UnionTrust Quality and Technology Co., Ltd. has been accredited by A2LA for technical competence in the field of electrical testing, and proved to be in compliance with ISO/IEC 17025: 2005 General Requirements for the Competence of Testing and Calibration Laboratories and any additional program requirements in the identified field of testing.

**FCC Accredited Lab.**

**Designation Number: CN1194**

**Test Firm Registration Number: 259480**

**Shenzhen UnionTrust Quality and Technology Co., Ltd.**



## 1.7 Guidance Standard

The tests documented in this report were performed in accordance with FCC 47 CFR Part 2 §2.1093, IEEE Std 1528-2013, ANSI/IEEE C95.1-1992, the following FCC Published RF exposure KDB procedures:

KDB 865664 D01 v01r04

KDB 865664 D02 v01r02

KDB 447498 D01 v06

KDB 648474 D04 v01r03

KDB 941225 D01 v03r01

The equipment have been tested by **Shenzhen UnionTrust Quality and Technology Co., Ltd.**, and found compliance with the requirement of the above standards.

## 2 Specific Absorption Rate (SAR)

### 2.1 Introduction

SAR is related to the rate at which energy is absorbed per unit mass in an object exposed to a radio field. The SAR distribution in a biological body is complicated and is usually carried out by experimental techniques or numerical modeling, by appropriate techniques, to produce specific absorption rates (SARs) as averaged over the whole-body, any 1 g or any 10 g of tissue (defined as a tissue volume in the shape of a cube). All SAR values are to be averaged over any six-minute period. When portable device was used within 20 cm of the user's body, SAR evaluation of the device will be required. The SAR limit in chapter 2.3.

### 2.2 SAR Definition

The SAR definition is the time derivative (rate) of the incremental energy (dW) absorbed by (dissipated in) an incremental mass (dm) contained in a volume element (dv) of a given density (ρ). The equation description is as below:

$$SAR = \frac{d}{dt} \left( \frac{dW}{dm} \right) = \frac{d}{dt} \left( \frac{dW}{\rho dv} \right)$$

SAR is expressed in units of Watts per kilogram (W/kg)

SAR measurement can be related to the electrical field in the tissue by

$$SAR = \frac{\sigma |E|^2}{\rho}$$

Where: σ is the conductivity of the tissue, ρ is the mass density of the tissue and E is the RMS electrical field strength.

### 2.3 SAR Limits

(A) Limits for Occupational/Controlled Exposure (W/kg)

Whole-Body	Partial-Body	Hands, Wrists, Feet and Ankles
0.4	8.0	20.0

(B) Limits for General Population/Uncontrolled Exposure (W/kg)

Whole-Body	Partial-Body	Hands, Wrists, Feet and Ankles
0.08	1.6	4.0

**Note:**

1. Whole-Body SAR is averaged over the entire body, partial-body SAR is averaged over any 1 gram of tissue defined as a tissue volume in the shape of a cube. SAR for hands, wrists, feet and ankles is averaged over any 10 grams of tissue defined as a tissue volume in the shape of a cube.
2. At frequencies above 6.0 GHz, SAR limits are not applicable and MPE limits for power density should be applied at 5 cm or more from the transmitting device.
3. The SAR limit is specified in FCC 47 CFR Part 2 §2.1093, ANSI/IEEE C95.1-1992.

**Shenzhen UnionTrust Quality and Technology Co., Ltd.**

## 3 SAR Measurement System

### 3.1 SPEAG DASY System

DASY system consists of high precision robot, probe alignment sensor, phantom, robot controller, controlled measurement server and near-field probe. The robot includes six axes that can move to the precision position of the DASY5 software defined. The DASY software can define the area that is detected by the probe. The robot is connected to controlled box. Controlled measurement server is connected to the controlled robot box. The DAE includes amplifier, signal multiplexing, AD converter, offset measurement and surface detection. It is connected to the Electro-optical coupler (ECO). The ECO performs the conversion from the optical into digital electric signal of the DAE and transfers data to the PC.

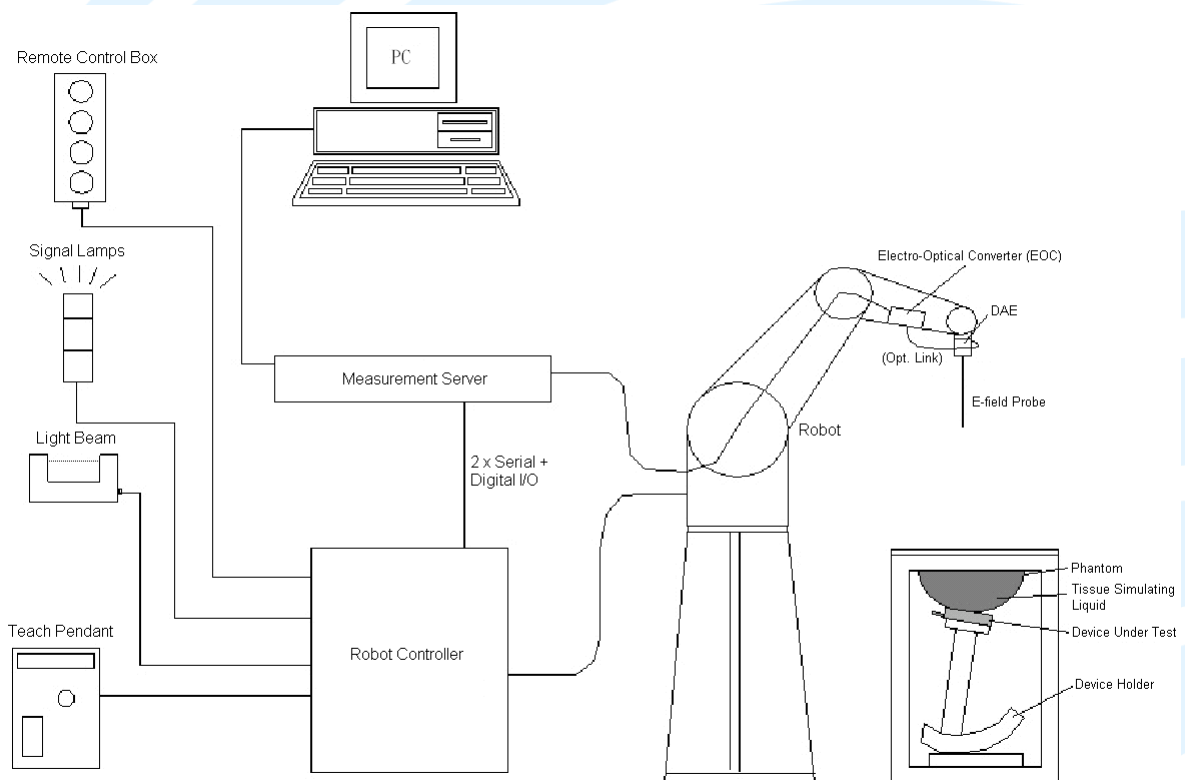

DASY Measurement System

#### 3.1.1 Robot

The DASY system uses the high precision robots from Stäubli SA (France). For the 6-axis controller system, the robot controller version (DASY5: CS8c) from Stäubli is used. The Stäubli robot series have many features that are important for our application:

- High precision (repeatability  $\pm 0.035$  mm)
- High reliability (industrial design)
- Jerk-free straight movements
- Low ELF interference (the closed metallic construction shields against motor control fields)

### **Shenzhen UnionTrust Quality and Technology Co., Ltd.**

Address: 16/F, Block A, Building 6, Baoneng Science and Technology Park, Qingxiang Road No.1, Longhua New District, Shenzhen, China  
Tel: +86-755-28230888 Fax: +86-755-28230886 E-mail: info@uttlab.com [Http://www.uttlab.com](http://www.uttlab.com)

### 3.1.2 Probe

The SAR measurement is conducted with the dosimetric probe. The probe is specially designed and calibrated for use in liquid with high permittivity. The dosimetric probe has special calibration in liquid at different frequency.

<b>Model</b>	EX3DV4	
<b>Construction</b>	Symmetrical design with triangular core. Built-in shielding against static charges. PEEK enclosure material (resistant to organic solvents, e.g., DGBE).	
<b>Frequency</b>	10 MHz to 6 GHz Linearity: $\pm 0.2$ dB	
<b>Directivity</b>	$\pm 0.3$ dB in HSL (rotation around probe axis) $\pm 0.5$ dB in tissue material (rotation normal to probe axis)	
<b>Dynamic Range</b>	10 $\mu$ W/g to 100 mW/g Linearity: $\pm 0.2$ dB (noise: typically $< 1$ $\mu$ W/g)	
<b>Dimensions</b>	Overall length: 337 mm (Tip: 20 mm) Tip diameter: 2.5 mm (Body: 12 mm) Typical distance from probe tip to dipole centers: 1 mm	

<b>Model</b>	ES3DV3	
<b>Construction</b>	Symmetrical design with triangular core. Interleaved sensors. Built-in shielding against static charges. PEEK enclosure material (resistant to organic solvents, e.g., DGBE).	
<b>Frequency</b>	10 MHz to 4 GHz Linearity: $\pm 0.2$ dB	
<b>Directivity</b>	$\pm 0.2$ dB in HSL (rotation around probe axis) $\pm 0.3$ dB in tissue material (rotation normal to probe axis)	
<b>Dynamic Range</b>	5 $\mu$ W/g to 100 mW/g Linearity: $\pm 0.2$ dB	
<b>Dimensions</b>	Overall length: 337 mm (Tip: 20 mm) Tip diameter: 3.9 mm (Body: 12 mm) Distance from probe tip to dipole centers: 2.0 mm	

### 3.1.3 Data Acquisition Electronics (DAE)

<b>Model</b>	DAE3, DAE4	
<b>Construction</b>	Signal amplifier, multiplexer, A/D converter and control logic. Serial optical link for communication with DASY embedded system (fully remote controlled). Two step probe touch detector for mechanical surface detection and emergency robot stop.	
<b>Measurement Range</b>	-100 to +300 mV (16 bit resolution and two range settings: 4mV, 400mV)	
<b>Input Offset Voltage</b>	$< 5\mu$ V (with auto zero)	
<b>Input Bias Current</b>	$< 50$ fA	
<b>Dimensions</b>	60 x 60 x 68 mm	

### 3.1.4 Phantom

<b>Model</b>	Twin SAM	
<b>Construction</b>	The shell corresponds to the specifications of the Specific Anthropomorphic Mannequin (SAM) phantom defined in IEEE 1528 and IEC 62209-1. It enables the dosimetric evaluation of left and right hand phone usage as well as body mounted usage at the flat phantom region. A cover prevents evaporation of the liquid. Reference markings on the phantom allow the complete setup of all predefined phantom positions and measurement grids by teaching three points with the robot.	
<b>Material</b>	Vinylester, glass fiber reinforced (VE-GF)	
<b>Shell Thickness</b>	$2 \pm 0.2$ mm ( $6 \pm 0.2$ mm at ear point)	
<b>Dimensions</b>	Length: 1000 mm Width: 500 mm Height: adjustable feet	
<b>Filling Volume</b>	approx. 25 liters	

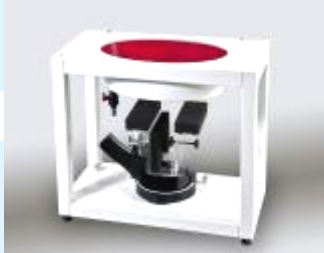
<b>Model</b>	ELI	
<b>Construction</b>	Phantom for compliance testing of handheld and body-mounted wireless devices in the frequency range of 30 MHz to 6 GHz. ELI is fully compatible with the IEC 62209-2 standard and all known tissue simulating liquids. ELI has been optimized regarding its performance and can be integrated into our standard phantom tables. A cover prevents evaporation of the liquid. Reference markings on the phantom allow installation of the complete setup, including all predefined phantom positions and measurement grids, by teaching three points. The phantom is compatible with all SPEAG dosimetric probes and dipoles.	
<b>Material</b>	Vinylester, glass fiber reinforced (VE-GF)	
<b>Shell Thickness</b>	$2.0 \pm 0.2$ mm (bottom plate)	
<b>Dimensions</b>	Major axis: 600 mm Minor axis: 400 mm	
<b>Filling Volume</b>	approx. 30 liters	

### 3.1.5 Device Holder

<b>Model</b>	Mounting Device	
<b>Construction</b>	In combination with the Twin SAM Phantom or ELI4, the Mounting Device enables the rotation of the mounted transmitter device in spherical coordinates. Rotation point is the ear opening point. Transmitter devices can be easily and accurately positioned according to IEC, IEEE, FCC or other specifications. The device holder can be locked for positioning at different phantom sections (left head, right head, flat).	
<b>Material</b>	POM	

<b>Model</b>	Laptop Extensions Kit	
<b>Construction</b>	Simple but effective and easy-to-use extension for Mounting Device that facilitates the testing of larger devices according to IEC 62209-2 (e.g., laptops, cameras, etc.). It is lightweight and fits easily on the upper part of the Mounting Device in place of the phone positioner.	
<b>Material</b>	POM, Acrylic glass, Foam	

### 3.1.6 System Validation Dipoles

<b>Model</b>	D-Serial	
<b>Construction</b>	Symmetrical dipole with 1/4 balun. Enables measurement of feed point impedance with NWA. Matched for use near flat phantoms filled with tissue simulating solutions.	
<b>Frequency</b>	750 MHz to 5800 MHz	
<b>Return Loss</b>	> 20 dB	
<b>Power Capability</b>	> 100 W (f < 1GHz), > 40 W (f > 1GHz)	



### 3.2 SAR Scan Procedure

#### 3.2.1 SAR Reference Measurement (drift)

Prior to the SAR test, local SAR shall be measured at a stationary reference point where the SAR exceeds the lower detection limit of the measurement system.

#### 3.2.2 Area Scan

Measurement procedures for evaluating the SAR of wireless device start with a coarse measurement grid to determine the approximate location of the local peak SAR values. This is known as the area-scan procedure. All antennas and radiating structures that may contribute to the measured SAR or influence the SAR distribution must be included in the area scan. The area scan measurement resolution must enable the extrapolation algorithms of the SAR system to correctly identify the peak SAR location(s) for subsequent zoom scan measurements to correctly determine the 1-g SAR. Area scans are performed at a constant distance from the phantom surface, determined by the measurement frequencies. When a measured peak is closer than ½ the zoom scan volume dimension (x, y) from the edge of the area scan region, unless the entire peak and gram-averaging volume are both captured within the zoom scan volume, the area scan must be repeated by shifting and expanding the area scan region to ensure all peaks are away from the area scan boundary. The area scan resolutions specified in the table below must be applied to the SAR measurements.

	≤ 3 GHz	> 3 GHz
Maximum distance from closest measurement point (geometric center of probe sensors) to phantom surface	5 mm ± 1 mm	½·δ·ln(2) mm ± 0.5 mm
Maximum probe angle from probe axis to phantom surface normal at the measurement location	30° ± 1°	20° ± 1°
Maximum area scan spatial resolution: Δx <sub>Area</sub> , Δy <sub>Area</sub>	≤ 2 GHz: ≤ 15 mm 2 – 3 GHz: ≤ 12 mm	3 – 4 GHz: ≤ 12 mm 4 – 6 GHz: ≤ 10 mm
	When the x or y dimension of the test device, in the measurement plane orientation, is smaller than the above, the measurement resolution must be ≤ the corresponding x or y dimension of the test device with at least one measurement point on the test device.	

#### 3.2.3 Zoom Scan

To evaluate the peak spatial-average SAR values with respect to 1 g or 10 g cubes, fine resolution volume scans, called zoom scans, are performed at the peak SAR locations identified during the area scan. If the cube volume within the zoom scan chosen to calculate the peak spatial-average SAR touches any boundary of the zoom-scan volume, the zoom scan shall be repeated with the center of the zoom-scan volume shifted to the new maximum SAR location. For any secondary peaks found in the area scan that are within 2 dB of the maximum peak and are not within this zoom scan, the zoom scan shall be performed for such peaks, unless the peak spatial-average SAR at the location of the maximum peak is more than 2 dB below the applicable SAR limit (i.e., 1 W/kg for a 1.6 W/kg 1 g limit, or 1.26 W/kg for a 2 W/kg 10 g limit). The zoom scan resolutions specified in the table below must be applied to the SAR measurements.

### Shenzhen UnionTrust Quality and Technology Co., Ltd.

		$\leq 3$ GHz	$> 3$ GHz	
Maximum zoom scan spatial resolution: $\Delta x_{Zoom}, \Delta y_{Zoom}$		$\leq 2$ GHz: $\leq 8$ mm 2 – 3 GHz: $\leq 5$ mm*	3 – 4 GHz: $\leq 5$ mm* 4 – 6 GHz: $\leq 4$ mm*	
Maximum zoom Scan spatial resolution, normal to phantom surface	uniform grid: $\Delta Z_{Zoom}(n)$	$\leq 5$ mm	3 – 4 GHz: $\leq 4$ mm 4 – 5 GHz: $\leq 3$ mm 5 – 6 GHz: $\leq 2$ mm	
	graded grid	$\Delta Z_{Zoom}(1)$ : between 1 <sup>ST</sup> two points closest to phantom surface	$\leq 4$ mm	3 – 4 GHz: $\leq 3$ mm 4 – 5 GHz: $\leq 2.5$ mm 5 – 6 GHz: $\leq 2$ mm
		$\Delta Z_{Zoom}(n>1)$ : between subsequent points	$\leq 1.5 \cdot \Delta Z_{Zoom}(n-1)$ mm	
Minimum zoom scan volume	x, y, z	$\geq 30$ mm	3 – 4 GHz: $\geq 28$ mm 4 – 5 GHz: $\geq 25$ mm 5 – 6 GHz: $\geq 22$ mm	
Note: $\delta$ is the penetration depth of a plane-wave at normal incidence to the tissue medium; see IEEE Std 1528-2013 for details. * When zoom scan is required and the reported SAR from the area scan based 1-g SAR estimation procedures of KDB Publication 447498 is $\leq 1.4$ W/kg, $\leq 8$ mm, $\leq 7$ mm and $\leq 5$ mm zoom scan resolution may be applied, respectively, for 2 GHz to 3 GHz, 3 GHz to 4 GHz and 4 GHz to 6 GHz.				

### 3.2.4 SAR Drift Measurement

The local SAR (or conducted power) shall be measured at exactly the same location as in 3.2.1 section. The absolute value of the measurement drift (the difference between the SAR measured in 3.2.1 and 3.2.4 section) shall be recorded. The SAR drift shall be kept within  $\pm 5\%$ .



### 3.3 Test Equipment

Equipment	Manufacturer	Model	SN	Cal. Date	Cal. Interval
System Validation Dipole	SPEAG	D835V2	4d139	Sep. 06, 2018	3 Year
System Validation Dipole	SPEAG	D1900V2	5d159	Sep. 11, 2018	3 Year
Dosimetric E-Field Probe	SPEAG	EX3DV4	3873	Aug. 31, 2018	1 Year
Data Acquisition Electronics	SPEAG	DAE4	1341	Aug. 28, 2018	1 Year
Wideband Radio Communication Tester	R&S	CMW500	116254	Jun. 08, 2018	1 Year
ENA Series Network Analyzer	Agilent	8753ES	MY40000519	Apr. 14, 2018	1 Year
Dielectric Assessment Kit	SPEAG	DAK-3.5	1056	N/A	N/A
USB/GPIB Interface	Agilent	82357B	N10149	N/A	N/A
EXG-B RF Analog Signal Generator	KEYSIGHT	N5171B	MY53051777	Dec. 10, 2017	1 Year
USB Wideband Power Sensor	KEYSIGHT	U2021XA	MY55430035	Dec. 10, 2017	1 Year
USB Wideband Power Sensor	KEYSIGHT	U2021XA	MY55430023	Dec. 10, 2017	1 Year
Thermometer	Shanghai Gao Zhi Precision Instrument Co., Ltd.	HB6801	120100323	Mar. 29, 2018	1 Year
Coupler	REBES	TC-05180-10 S	161221001	09. 17, 2018	1 Year
Amplifier	SATIMO	Amplifier	MODU-023-A-0003	N/A	N/A

### 3.4 Measurement Uncertainty

Per KDB 865664 D01 SAR Measurement 100 MHz to 6 GHz, when the highest measured 1-g SAR within a frequency band is  $< 1.5$  W/kg, the extensive SAR measurement uncertainty analysis described in IEEE Std 1528-2013 is not required in SAR reports submitted for equipment approval.



### 3.5 Tissue Dielectric Parameter Measurement & System Verification

#### 3.5.1 Tissue Simulating Liquids

The temperature of the tissue-equivalent medium used during measurement must also be within 18 °C to 25 °C and within ± 2 °C of the temperature when the tissue parameters are characterized. The dielectric parameters must be measured before the tissue-equivalent medium is used in a series of SAR measurements. The parameters should be re-measured after each 3 - 4 days of use; or earlier if the dielectric parameters can become out of tolerance.

The depth of tissue-equivalent liquid in a phantom must be ≥ 15.0 cm with ≤ ± 0.5 cm variation for SAR measurements ≤ 3 GHz and ≥ 10.0 cm with ≤ ± 0.5 cm variation for measurements > 3 GHz. The nominal dielectric values of the tissue simulating liquids in the phantom and the tolerance of 5% are listed in Table-3.1.



Photo of Liquid Height

Table-3.1 Tissue Dielectric Parameters for Head and Body

Target Frequency (MHz)	Head		Body	
	$\epsilon_r$	$\sigma$ (S/m)	$\epsilon_r$	$\sigma$ (S/m)
750	41.9	0.89	55.5	0.96
835	41.5	0.90	55.2	0.97
900	41.5	0.97	55.0	1.05
1450	40.5	1.20	54.0	1.30
1640	40.3	1.29	53.8	1.40
1750	40.1	1.37	53.4	1.49
1800	40.0	1.40	53.3	1.52
1900	40.0	1.40	53.3	1.52
2000	40.0	1.40	53.3	1.52
2300	39.5	1.67	52.9	1.81
2450	39.2	1.80	52.7	1.95
2600	39.0	1.96	52.5	2.16
3500	37.9	2.91	51.3	3.31
5200	36.0	4.66	49.0	5.30
5300	35.9	4.76	48.9	5.42
5500	35.6	4.96	48.6	5.65
5600	35.5	5.07	48.5	5.77
5800	35.3	5.27	48.2	6.00

( $\epsilon_r$  = relative permittivity,  $\sigma$  = conductivity and  $\rho = 1000 \text{ kg/m}^3$ )

The following table gives the recipes for tissue simulating liquids.

Table-3.2 Recipes of Tissue Simulating Liquid

Tissue Type	Bactericide	DGBE	HEC	NaCl	Sucrose	Triton X-100	Water	Diethylene Glycol Mono-hexylether
H750	0.2	-	0.2	1.4	57.0	-	41.1	-
H835	0.1	-	1.0	1.4	57.0	-	40.5	-
H900	0.1	-	1.0	1.5	56.5	-	40.9	-
H1450	-	45.5	-	0.7	-	-	53.8	-
H1640	-	45.8	-	0.5	-	-	53.7	-
H1750	-	44.5	-	0.3	-	-	55.2	-
H1800	-	44.9	-	0.2	-	-	54.9	-
H1900	-	44.9	-	0.2	-	-	54.9	-
H2000	-	50	-	-	-	-	50	-
H2300	-	44.9	-	0.1	-	-	55.0	-
H2450	-	45.0	-	0.1	-	-	54.9	-
H2600	-	45.1	-	0.1	-	-	54.8	-
H3500	-	8.0	-	0.2	-	20.0	71.8	-
H5G	-	-	-	-	-	17.2	65.52	17.3
B750	0.2	-	0.2	0.8	48.8	-	50.0	-
B835	0.2	-	0.2	0.9	48.5	-	50.2	-
B900	0.2	-	0.2	0.9	48.2	-	50.5	-
B1450	-	34.0	-	0.3	-	-	65.7	-
B1640	-	32.5	-	0.3	-	-	67.2	-
B1750	-	29.4	-	0.4	-	-	70.2	-
B1800	-	29.5	-	0.4	-	-	70.1	-
B1900	-	29.5	-	0.3	-	-	70.2	-
B2000	-	30.0	-	0.2	-	-	69.8	-
B2300	-	31.0	-	0.1	-	-	68.9	-
B2450	-	31.4	-	0.1	-	-	68.5	-
B2600	-	31.8	-	0.1	-	-	68.1	-
B3500	-	28.8	-	0.1	-	-	71.1	-
B5G	-	-	-	-	-	10.7	78.6	10.7

### 3.5.2 System Check Description

The system check procedure provides a simple, fast, and reliable test method that can be performed daily or before every SAR measurement. The objective here is to ascertain that the measurement system has acceptable accuracy and repeatability. This test requires a flat phantom and a radiating source. The system verification setup is shown as below.

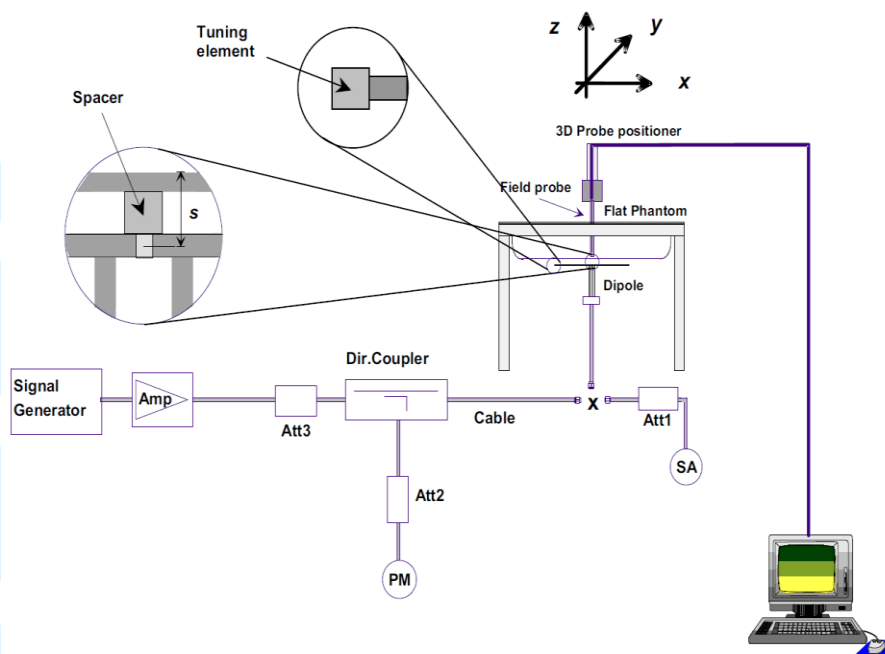

System Verification Setup

### 3.5.3 Tissue Verification

The measuring results for tissue simulating liquid are shown as below.

Test Date	Tissue Type	Frequency (MHz)	Liquid Temp. (°C)	Measured Conductivity ( $\sigma$ )	Measured Permittivity ( $\epsilon_r$ )	Target Conductivity ( $\sigma$ )	Target Permittivity ( $\epsilon_r$ )	Conductivity Deviation (%)	Permittivity Deviation (%)
Oct. 12, 2018	Head	835	22.8	21.8	0.928	43.145	0.90	41.50	3.11
Oct. 13, 2018	Head	1900	22.9	21.9	1.413	41.330	1.40	40.00	0.93
Oct. 12, 2018	Body	835	22.8	21.8	0.992	55.615	0.97	55.20	2.27
Oct. 13, 2018	Body	1900	22.9	21.9	1.550	52.906	1.52	53.30	1.97

**Note:**

The dielectric properties of the tissue simulating liquid must be measured within 24 hours before the SAR testing and within  $\pm 5\%$  of the target values. The variation of the liquid temperature must be within  $\pm 2\text{ }^\circ\text{C}$  during the test.

### 3.5.4 System Verification

The measuring result for system verification is tabulated as below.

Test Date	Tissue Type	Frequency (MHz)	1W Target SAR-1g (W/kg)	Measured SAR-1g (W/kg)	Normalized to 1W SAR-1g (W/kg)	Deviation (%)	Dipole S/N	Probe S/N	DAE S/N
Oct. 12, 2018	Head	835	9.51	2.56	10.24	7.68	4d139	3873	1341
Oct. 13, 2018	Head	1900	39.80	10.80	43.20	8.54	5d159	3873	1341
Oct. 12, 2018	Body	835	9.70	2.38	9.52	-1.86	4d139	3873	1341
Oct. 13, 2018	Body	1900	40.20	10.70	42.80	6.47	5d159	3873	1341

**Note:**

Comparing to the reference SAR value, the validation data should be within its specification of 10%. The result indicates the system check can meet the variation criterion and the plots can be referred to Appendix A of this report.

## 4 SAR Measurement Evaluation

### 4.1 EUT Configuration and Setting

#### Connections between EUT and System Simulator

For WWAN SAR testing, the EUT was linked and controlled by base station emulator. Communication between the EUT and the emulator was established by air link. The distance between the EUT and the communicating antenna of the emulator is larger than 50 cm and the output power radiated from the emulator antenna is at least 30 dB smaller than the output power of EUT. The EUT was set from the emulator to radiate maximum output power during SAR testing.

#### 4.1.1 GSM Configuration and Testing

GSM (GMSK: CS1) voice mode transmits with 1 time slot. GPRS (GMSK: CS1) may transmit up to 4 time slots in the 8 time-slot frame according to the multislot class implemented in a device.

### 4.2 EUT Testing Position

#### 4.2.1 Head Exposure Conditions

RF Exposure Conditions	Test Position	Separation Distance	SAR test exclusion
Head	Right Cheek	0 cm	N/A
	Right Tilted		
	Left Cheek		
	Left Tilted		

Note:

1. Head exposure for voice mode of handset is limited to next to the ear exposure conditions.
2. Devices that are designed to transmit next to the ear must be tested using the SAM phantom.
3. Other head exposure conditions, for example, in-front-of the face, should be tested using a flat phantom according to the required published RF exposure KDB procedures.
4. When data mode operates in next to the ear configurations, either data alone or in conjunction with voice transmissions, SAR evaluation is required for such use conditions.
5. When device supports VoIP, SAR evaluation for head Exposure Conditions using the most appropriate wireless data mode configurations is required.

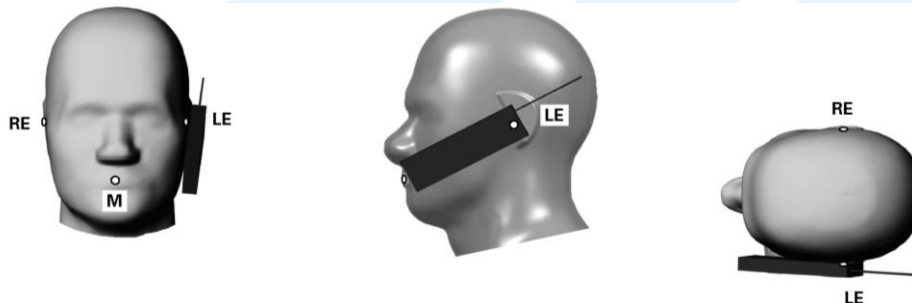

Fig-4.1 Cheek Position

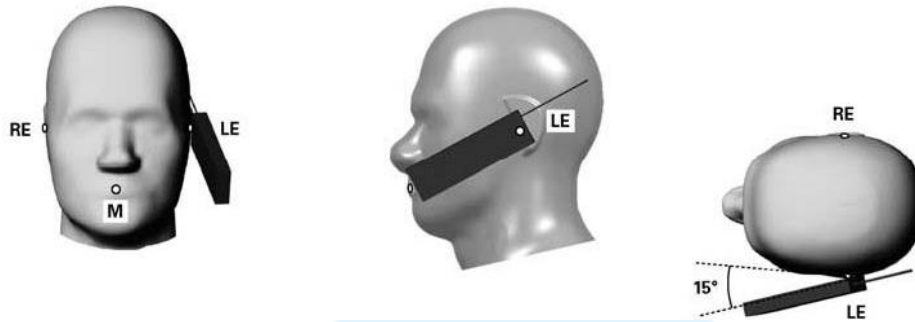

Fig-4.2 Tilted Position

Define two imaginary lines on the handset

- The vertical centerline passes through two points on the front side of the handset - the midpoint of the width  $w_t$  of the handset at the level of the acoustic output, and the midpoint of the width  $w_b$  of the bottom of the handset.
- The horizontal line is perpendicular to the vertical centerline and passes through the center of the acoustic output. The horizontal line is also tangential to the face of the handset at point A.
- The two lines intersect at point A. Note that for many handsets, point A coincides with the center of the acoustic output; however, the acoustic output may be located elsewhere on the horizontal line. Also note that the vertical centerline is not necessarily parallel to the front face of the handset, especially for clamshell handsets, handsets with flip covers, and other irregularly shaped handsets.

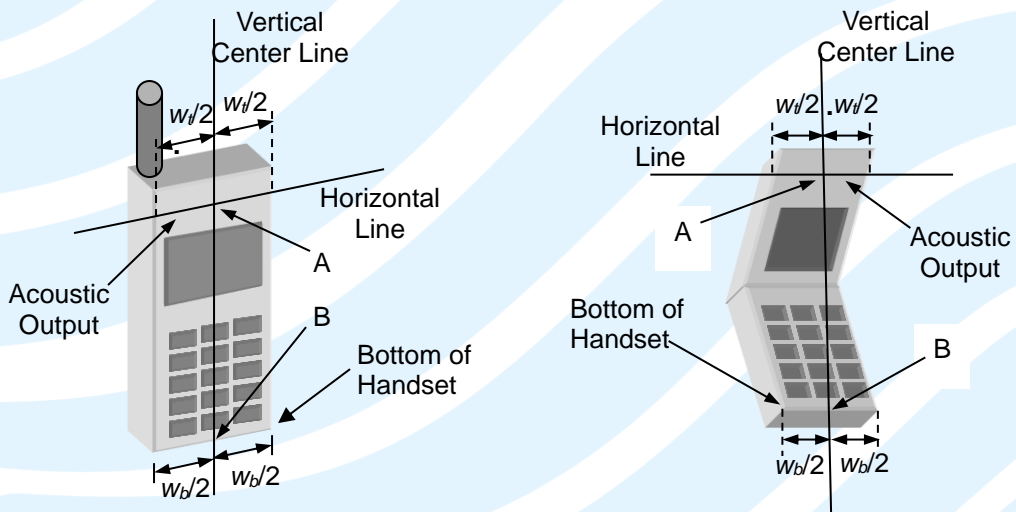

Fig-4.3 Handset Vertical and Horizontal Reference Lines



### 4.2.2 Body-worn Accessory Exposure Conditions

RF Exposure Conditions	Test Position	Separation Distance	SAR test exclusion
Body-worn	Front Face	0 ~ 2.5 cm	N/A
	Rear Face		

Note:

1. Body-worn accessories that do not contain metallic or conductive components may be tested according to worst-case exposure configurations, typically according to the smallest test separation distance required for the group of body-worn accessories with similar operating and exposure characteristics. All body-worn accessories containing metallic components are tested in conjunction with the host device.
2. Body-worn accessory SAR compliance is based on a single minimum test separation distance for all wireless and operating modes applicable to each body-worn accessory used by the host, and according to the relevant voice and/or data mode transmissions and operations. If a body-worn accessory supports voice only operations in its normal and expected use conditions, testing of data mode for body-worn compliance is not required.
3. A conservative minimum test separation distance for supporting off-the-shelf body-worn accessories that may be acquired by users of consumer handsets should be used to test for body-worn accessory SAR compliance. This distance is determined by the handset manufacturer according to the typical body-worn accessories users may acquire at the time of equipment certification, but not more than 2.5 cm, to enable users to purchase aftermarket body-worn accessories with the required minimum separation.
4. Devices that are designed to operate on the body of users using lanyards and straps or without requiring additional body-worn accessories must be tested for SAR compliance using a conservative minimum test separation distance  $\leq 5$  mm to support compliance.
5. When device supports VoIP, SAR evaluation for body-worn accessory Exposure Conditions using the most appropriate wireless data mode configurations is required.
6. Body-worn accessory exposure is typically related to voice mode operations when handsets are carried in body-worn accessories.
7. When the reported SAR for a body-worn accessory, measured without a headset connected to the handset, is  $> 1.2$  W/kg, the highest reported SAR configuration for that wireless mode and frequency band should be repeated for the body-worn accessory with a headset attached to the handset.

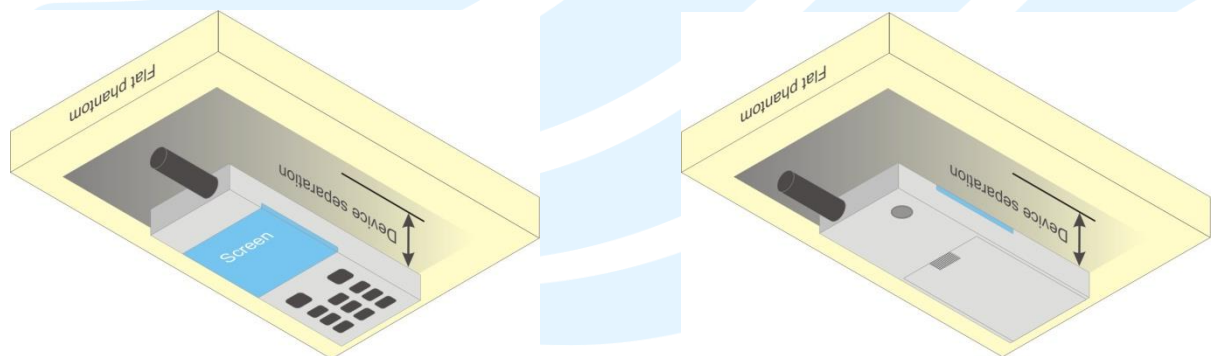

Fig-4.4 Body Worn Position

## 4.3 Measured Conducted Power Result

### 4.3.1 Conducted Power of GSM Band

The measuring conducted average power (Unit: dBm) is shown as below.

Band	GSM850			GSM1900		
Channel	128	190	251	512	661	810
Frequency (MHz)	824.2	836.6	848.8	1850.2	1880.0	1909.8
<b>Maximum Burst-Averaged Output Power</b>						
GSM (GMSK, 1Tx-slot)	31.67	31.69	<b>31.82</b>	<b>28.45</b>	28.33	28.08
GPRS (GMSK, 1Tx-slot)	31.63	31.67	31.81	28.44	28.33	28.14
GPRS (GMSK, 2Tx-slot)	29.34	29.53	29.70	26.47	26.30	26.32
GPRS (GMSK, 3Tx-slot)	27.41	27.68	27.93	24.87	24.76	24.81
GPRS (GMSK, 4Tx-slot)	25.51	25.74	26.02	22.88	22.65	22.65
<b>Maximum Frame-Averaged Output Power</b>						
GSM (GMSK, 1Tx-slot)	22.67	22.69	22.82	19.45	19.33	19.08
GPRS (GMSK, 1Tx-slot)	22.63	22.67	22.81	19.44	19.33	19.14
GPRS (GMSK, 2Tx-slot)	23.34	23.53	<b>23.70</b>	20.47	20.30	20.32
GPRS (GMSK, 3Tx-slot)	23.15	23.42	23.67	<b>20.61</b>	20.50	20.55
GPRS (GMSK, 4Tx-slot)	22.51	22.74	23.02	19.88	19.65	19.65

**Note:**

- SAR testing was performed on the maximum frame-averaged power mode.
- The frame-averaged power is linearly proportion to the slot number configured and it is linearly scaled the maximum burst-averaged power based on time slots. The calculated method is shown as below:

$$\text{Frame-averaged power} = 10 \times \log (\text{Burst-averaged power mW} \times \text{Slot used} / 8)$$

### 4.3.2 Conducted Power of BT

Mode	Channel	Frequency (MHz)	Average Power (dBm)
BT	GFSK	0	6.86
		39	6.72
		78	6.80
	π/4-DQPSK	0	6.18
		39	6.05
		78	6.10
	8-DPSK	0	6.18
		39	6.04
		78	6.10

## 4.4 SAR Test Exclusion Evaluations

### 4.4.1 Standalone SAR Test Exclusion Considerations

According to KDB 447498 D01, the SAR test exclusion condition is based on source-based time-averaged maximum conducted output power, adjusted for tune-up tolerance, and the minimum test separation distance required for the exposure conditions. The 1-g and 10-g SAR test exclusion thresholds are determined by the following:

- a) For 100 MHz to 6 GHz and test separation distances  $\leq 50$  mm:

$$\frac{\text{Max. Tune up Power}_{(mW)}}{\text{Min. Test Separation Distance}_{(mm)}} \times \sqrt{f_{(GHz)}} \leq 3.0 \text{ for SAR-1g, } \leq 7.5 \text{ for SAR-10g}$$

When the minimum test separation distance is  $< 5$  mm, a distance of 5 mm is applied to determine SAR test exclusion.

- b) For 100 MHz to 1500 MHz and test separation distances  $> 50$  mm:

$$\{[\text{Threshold for 50 mm in step a)}] + [( \text{test separation distance} - 50 \text{ mm}) \cdot (f_{(MHz)}/150)]\} \text{ mW}$$

- c) For  $> 1500$  MHz and  $\leq 6$  GHz and test separation distances  $> 50$  mm:

$$\{[\text{Threshold for 50 mm in step a)}] + [( \text{test separation distance} - 50 \text{ mm}) \cdot 10]\} \text{ mW}$$

When the calculated result in step a) is  $\leq 3.0$  for SAR-1g exposure condition, or  $\leq 7.5$  for SAR-10g exposure condition, the SAR testing exclusion is applied.

When the device output power is less than the calculated result (power threshold, mW) shown in in step b) and c), the SAR testing exclusion is applied.

Mode	Max. Tune-up Power (dBm)	Max. Tune-up Power (mW)	Head			Body-Worn		
			Ant. to Surface (mm)	Calculated Result	Require SAR Testing?	Ant. to Surface (mm)	Calculated Result	Require SAR Testing?
BT	7.5	5.62	5	1.8	No	10	0.9	No

#### 4.4.2 Estimated SAR Calculation

According to KDB 447498 D01, when an antenna qualifies for the standalone SAR test exclusion and also transmits simultaneously with other antennas, the standalone SAR value must be estimated according to the following to determine the simultaneous transmission SAR test exclusion criteria:

a) For test separation distances  $\leq 50$  mm:

$$Estimated\ SAR = \frac{Max.\ Tune\ up\ Power_{(mW)}}{Min.\ Test\ Separation\ Distance_{(mm)}} \times \frac{\sqrt{f(GHz)}}{x}$$

Where  $x = 7.5$  for 1-g SAR and  $x = 18.75$  for 10-g SAR.

b) For test separation distances  $> 50$  mm, 0.4 W/kg for 1-g SAR and 1.0 W/kg for 10-g SAR.

Mode / Band	Frequency (GHz)	Max. Tune-up Power (dBm)	Test Position	Separation Distance (mm)	Estimated SAR (W/kg)
BT (DSS)	2.48	7.5	Head	5	0.24
BT (DSS)	2.48	7.5	Body-worn	10	0.12

## 4.5 SAR Testing Results

### 4.5.1 SAR Test Reduction Considerations

#### KDB 447498 D01 General RF Exposure Guidance

Testing of other required channels within the operating mode of a frequency band is not required when the *reported* SAR for the mid-band or highest output power channel is:

- a)  $\leq 0.8$  W/kg or 2.0 W/kg, for 1-g or 10-g respectively, when the transmission band is  $\leq 100$  MHz
- b)  $\leq 0.6$  W/kg or 1.5 W/kg, for 1-g or 10-g respectively, when the transmission band is between 100 MHz and 200 MHz
- c)  $\leq 0.4$  W/kg or 1.0 W/kg, for 1-g or 10-g respectively, when the transmission band is  $\geq 200$  MHz

#### KDB 941225 D01 3G SAR Procedures

##### a) GSM SAR Test Reduction

SAR test reduction for GPRS and EDGE modes is determined by the source-based time-averaged output power specified for production units, including tune-up tolerance. The data mode with highest specified time-averaged output power should be tested for SAR compliance in the applicable exposure conditions. For modes with the same specified maximum output power and tolerance, the higher number time-slot configuration should be tested. The GMSK EDGE configurations are grouped with GPRS and considered with respect to time-averaged maximum output power to determine compliance. The 3G SAR test reduction procedure is applied to 8-PSK EDGE with GMSK GPRS/EDGE as the primary mode.

#### 4.5.2 SAR Results for Head Exposure Condition

Plot No.	Band	Mode	Test Position	Ch.	Max. Tune-up Power (dBm)	Measured Conducted Power (dBm)	Power Drift (dB)	Measured SAR-1g (W/kg)	Scaling Factor	Scaled SAR-1g (W/kg)
	GSM850	GSM	Right Cheek	251	32.0	31.81	-0.16	1.03	1.04	1.08
	GSM850	GSM	Right Tilted	251	32.0	31.81	-0.04	0.464	1.04	0.48
	GSM850	GSM	Left Cheek	251	32.0	31.81	-0.01	0.956	1.04	1.00
	GSM850	GSM	Left Tilted	251	32.0	31.81	-0.12	0.552	1.04	0.58
	GSM850	GSM	Right Cheek	128	32.0	31.67	-0.03	0.818	1.08	0.88
	GSM850	GSM	Right Cheek	190	32.0	31.69	-0.04	0.932	1.07	1.00
	GSM850	GSM	Left Cheek	128	32.0	31.67	0.02	0.973	1.08	1.05
1	GSM850	GSM	Left Cheek	190	32.0	31.69	0.03	1.09	1.07	1.17
2	GSM1900	GSM	Right Cheek	512	29.0	28.45	-0.07	0.502	1.14	0.57
	GSM1900	GSM	Right Tilted	512	29.0	28.45	-0.01	0.3	1.14	0.34
	GSM1900	GSM	Left Cheek	512	29.0	28.45	0.03	0.37	1.14	0.42
	GSM1900	GSM	Left Tilted	512	29.0	28.45	0.15	0.243	1.14	0.28

#### 4.5.3 SAR Results for Body-worn Exposure Condition (Separation Distance is 1.0 cm)

Plot No.	Band	Mode	Test Position	Ch.	Max. Tune-up Power (dBm)	Measured Conducted Power (dBm)	Power Drift (dB)	Measured SAR-1g (W/kg)	Scaling Factor	Scaled SAR-1g (W/kg)
	GSM850	GSM	Front Face	251	32.0	31.81	0.00	0.841	1.04	0.88
3	GSM850	GSM	Rear Face	251	32.0	31.81	-0.12	1.19	1.04	1.24
	GSM850	GSM	Front Face	128	32.0	31.67	0.01	0.701	1.08	0.76
	GSM850	GSM	Front Face	190	32.0	31.69	0.09	0.804	1.07	0.86
	GSM850	GSM	Rear Face	128	32.0	31.67	-0.04	1.02	1.08	1.10
	GSM850	GSM	Rear Face	190	32.0	31.69	0.02	1.12	1.07	1.20
	GSM850	GSM	Rear Face	251	32.0	31.81	-0.12	1.13	1.04	1.18
4	GSM1900	GSM	Front Face	512	29.0	28.45	0.08	0.471	1.14	0.53
	GSM1900	GSM	Rear Face	512	29.0	28.45	0.00	0.681	1.14	0.77



## 4.6 SAR Measurement Variability

### 4.6.1 Repeated Measurement

According to KDB 865664 D01, SAR measurement variability was assessed for each frequency band, which is determined by the SAR probe calibration point and tissue-equivalent medium used for the device measurements. When both head and body tissue-equivalent media are required for SAR measurements in a frequency band, the variability measurement procedures should be applied to the tissue medium with the highest measured SAR, using the highest measured SAR configuration for that tissue-equivalent medium. Alternatively, if the highest measured SAR for both head and body tissue-equivalent media are  $\leq 1.45$  W/kg and the ratio of these highest SAR values, i.e., largest divided by smallest value, is  $\leq 1.10$ , the highest SAR configuration for either head or body tissue-equivalent medium may be used to perform the repeated measurement. These additional measurements are repeated after the completion of all measurements requiring the same head or body tissue-equivalent medium in a frequency band. The test device should be returned to ambient conditions (normal room temperature) with the battery fully charged before it is re-mounted on the device holder for the repeated measurement(s) to minimize any unexpected variations in the repeated results.

SAR repeated measurement procedure:

1. When the highest measured SAR is  $< 0.80$  W/kg, repeated measurement is not required.
2. When the highest measured SAR is  $\geq 0.80$  W/kg, repeat that measurement once.
3. If the ratio of largest to smallest SAR for the original and first repeated measurements is  $> 1.20$ , or when the original or repeated measurement is  $\geq 1.45$  W/kg, perform a second repeated measurement.
4. If the ratio of largest to smallest SAR for the original, first and second repeated measurements is  $> 1.20$ , and the original, first or second repeated measurement is  $\geq 1.5$  W/kg, perform a third repeated measurement.

Band	Mode	Test Position	Ch.	Original Measured SAR-1g (W/kg)	1st Repeated SAR-1g (W/kg)	L/S Ratio	2nd Repeated SAR-1g (W/kg)	L/S Ratio	3rd Repeated SAR-1g (W/kg)	L/S Ratio
Body-worn Exposure Condition										
GSM850	GSM	Rear Face	251	1.19	1.13	1.05	N/A	N/A	N/A	N/A

## 4.7 Simultaneous Multi-band Transmission Evaluation

### 4.7.1 Simultaneous Transmission SAR Test Exclusion Considerations

a) Sum of SAR

Simultaneous transmission SAR test exclusion is determined for each operating configuration and exposure condition according to the reported standalone SAR of each applicable simultaneous transmitting antenna. When the sum of SAR<sub>1g</sub> of all simultaneously transmitting antennas in an operating mode and exposure condition combination is within the SAR limit (SAR<sub>1g</sub> 1.6 W/kg), the simultaneous transmission SAR is not required. When the sum of SAR<sub>1g</sub> is greater than the SAR limit (SAR<sub>1g</sub> 1.6 W/kg), SAR test exclusion is determined by the SPLSR.

b) SAR to Peak Location Separation Ratio

The simultaneous transmitting antennas in each operating mode and exposure condition combination are considered one pair at a time to determine the SPLSR.

$$SPLSR = (SAR_1 + SAR_2)^{1.5}/R_i$$

The ratio is rounded to two decimal digits, and must be  $\leq 0.04$  for all antenna pairs in the configuration to qualify for 1-g SAR test exclusion. When 10-g SAR applies, the ratio must be  $\leq 0.10$ .

SAR<sub>1</sub> and SAR<sub>2</sub> are the highest reported or estimated SAR values for each antenna in the pair, and R<sub>i</sub> is the separation distance in mm between the peak SAR locations for the antenna pair

$$\text{peak location separation distance} = \sqrt{(x_1 - x_2)^2 + (y_1 - y_2)^2 + (z_1 - z_2)^2}$$

Where (x<sub>1</sub>, y<sub>1</sub>, z<sub>1</sub>) and (x<sub>2</sub>, y<sub>2</sub>, z<sub>2</sub>) are the coordinates of the extrapolated peak SAR locations in the area or zoom scans.

When standalone test exclusion applies, SAR is estimated; the peak location is assumed to be at the feed-point or geometric center of the antenna. Due to curvatures on the SAM phantom, when SAR is estimated for one of the antennas in an antenna pair, the measured peak SAR location will be translated onto the test device to determine the peak location separation for the antenna pair.

When SAR is estimated for both antennas, the peak location separation should be determined by the closest physical separation of the antennas, according to the feed-point or geometric center of the antennas.

c) Volume Scan

When the SPLSR is  $\leq 0.04$  for 1-g SAR and  $\leq 0.10$  for 10-g SAR, the simultaneous transmission SAR is not required. Otherwise, the enlarged zoom scan and volume scan post-processing procedures will be performed.



### 4.7.2 Simultaneous Transmission Possibilities

The simultaneous transmission possibilities for this device are listed as below.

Simultaneous Transmission Configurations	Head (Voice / VoIP)	Body-worn (Voice / VoIP)
GSM (Voice / Data) + BT (Data)	Yes	Yes

### 4.7.3 Max. Standalone SAR

#### WWAN

Position		GSM	
		850	1900
Head	Right Cheek	1.08	0.57
	Right Tilted	0.48	0.34
	Left Cheek	1.17	0.42
	Left Tilted	0.58	0.28
Body-worn	Front Face	0.88	0.53
	Rear Face	1.24	0.77

### 4.7.4 Sum of SAR

#### WWAN + BT (DSS)

Position		Highest Simultaneous Transmission SAR	GSM	
			850	1900
Head	Right Cheek	1.41	1.32	0.81
	Right Tilted		0.72	0.58
	Left Cheek		1.41	0.66
	Left Tilted		0.82	0.52
Body-worn	Front Face	1.36	1.00	0.65
	Rear Face		1.36	0.89

\*\*\* End of Report \*\*\*

The test report is effective only with both signature and specialized stamp. The result(s) shown in this report refer only to the sample(s) tested. Without written approval of UnionTrust, this report can't be reproduced except in full.



## **Appendix A. SAR Plots of System Verification**

The plots for system verification with largest deviation for each SAR system combination are shown as follows.



## Appendix B. SAR Plots of SAR Measurement

The SAR plots for highest measured SAR in each exposure configuration, wireless mode and frequency band combination, and measured SAR > 1.5 W/kg are shown as follows.



## **Appendix C. Calibration Certificate for Probe and Dipole**

The calibration certificates are shown as follows.



**Appendix D. Photographs of EUT and Setup**

