

FCC RF Test Report

APPLICANT : CT Asia
EQUIPMENT : GSM mobile phone
BRAND NAME : ACE
MODEL NAME : Caracas Pro
FCC ID : YHLACECCSPR
STANDARD : FCC Part 15 Subpart C §15.247
CLASSIFICATION : Digital Spread Spectrum (DSS)

The product was received on Dec. 13, 2011 and completely tested on Jan. 10, 2011. We, SPORTON INTERNATIONAL (KUNSHAN) INC., would like to declare that the tested sample has been evaluated in accordance with the procedures given in ANSI C63.4-2003 and shown the compliance with the applicable technical standards.

The test results in this report apply exclusively to the tested model / sample. Without written approval of SPORTON INTERNATIONAL (KUNSHAN) INC., the test report shall not be reproduced except in full.

Reviewed by:



Jones Tsai / Manager



SPORTON INTERNATIONAL (KUNSHAN) INC.
No. 3-2, PingXiang Road, Kunshan, Jiangsu Province, P.R.C.



TABLE OF CONTENTS

REVISION HISTORY..... 3

SUMMARY OF TEST RESULT 4

1 GENERAL DESCRIPTION..... 5

 1.1 Applicant 5

 1.2 Manufacturer..... 5

 1.3 Feature of Equipment Under Test 5

 1.4 Testing Site 6

 1.5 Applied Standards 6

 1.6 Ancillary Equipment List 7

2 TEST CONFIGURATION OF EQUIPMENT UNDER TEST..... 8

 2.1 RF Output Power 8

 2.2 Test Mode..... 9

 2.3 Connection Diagram of Test System..... 10

 2.4 RF Utility 10

3 TEST RESULT 11

 3.1 Number of Channel Measurement 11

 3.2 20dB and 99% Bandwidth Measurement 13

 3.3 Hopping Channel Separation Measurement 20

 3.4 Dwell Time Measurement..... 27

 3.5 Peak Output Power Measurement 29

 3.6 Band Edges Measurement..... 32

 3.7 Spurious Emission Measurement..... 43

 3.8 AC Conducted Emission Measurement..... 47

 3.9 Radiated Emission Measurement..... 51

 3.10 Antenna Requirements..... 60

4 LIST OF MEASURING EQUIPMENT..... 61

5 UNCERTAINTY OF EVALUATION..... 62

APPENDIX A. PHOTOGRAPHS OF EUT

APPENDIX B. SETUP PHOTOGRAPHS



SUMMARY OF TEST RESULT

Report Section	FCC Rule	Description	Limit	Result	Remark
3.1	15.247(a)(1)	Number of Channels	≥ 15Chs	Pass	-
3.2	15.247(a)(1)	20dB Bandwidth	NA	Pass	-
3.3	15.247(a)(1)	Channel Separation	≥ 2/3 of 20dB BW	Pass	-
3.4	15.247(a)(1)	Dwell Time of Each Channel	≤ 0.4sec in 31.6sec period	Pass	-
3.5	15.247(b)(1)	Peak Output Power	≤ 125 mW	Pass	-
3.6	15.247(d)	Frequency Band Edges	≤ 20dBc	Pass	-
3.7	15.247(d)	Spurious Emission	< 20 dBc	Pass	-
3.8	15.207	AC Conducted Emission	15.207(a)	Pass	Under limit 12.74 dB at 3.42 MHz
3.9	15.247(d)	Transmitter Radiated Emission	15.209(a) & 15.247(d)	Pass	Under limit 6.9 dB at 102.36 MHz
3.10	15.203 & 15.247(b)	Antenna Requirement	N/A	Pass	-

1 General Description

1.1 Applicant

CT Asia

RMA2011, 20/F, GOLDEN CENTRAL TOWER, NO.3037# JINTIAN ROAD, FUTIAN DISTRICT

1.2 Manufacturer

Shenzhen SanmengCommunication Technolo GY CO., LTD

1503, Blk. East, Shengtang Bldg.Tairan 9th Road, Chegongmiao, Futian District, Shenzhen, Guangdong

1.3 Feature of Equipment Under Test

Product Feature & Specification	
Equipment	GSM mobile phone
Brand Name	ACE
Model Name	Caracas Pro
FCC ID	YHLACECCSPR
Tx/Rx Frequency Range	2402 MHz ~ 2480 MHz
Number of Channels	79
Carrier Frequency of Each Channel	2402+n*1 MHz; n=0~78
Channel Spacing	1 MHz
Maximum Output Power to Antenna	Bluetooth (1Mbps) : 9.84 dBm (0.00963 W) Bluetooth EDR (2Mbps) : 9.60 dBm (0.00912 W) Bluetooth EDR (3Mbps) : 9.80 dBm (0.00954 W)
Antenna Type	Dipole Antenna with gain -1 dBi
HW Version	HEXING36_10A_GEMINI_HW
SW Version	E200_BLU_LEN_BT_FM_FL_SC_004_V017
Type of Modulation	Bluetooth (1Mbps) : GFSK Bluetooth EDR (2Mbps) : $\pi/4$ -DQPSK Bluetooth EDR (3Mbps) : 8-DPSK
EUT Stage	Identical Prototype

Remark:

1. For other wireless features of this EUT, test report will be issued separately.
2. This test report recorded only product characteristics and test results of Digital Spread Spectrum (DSS).
3. The above EUT's information was declared by manufacturer. Please refer to the specifications or user's manual for more detailed description.
4. There are two different types of EUT. They are single SIM card mobile and dual SIM card mobile. The others are the same including circuit design, PCB board, structure and all components. It is special to declare. After pre-scan two types of EUT, we found test result of the sample that dual SIM was the worst, so we choose dual SIM card mobile to perform all test. For the dual SIM card

mobile, after pre-scan two SIM cards, we found test result with SIM1 card was the worst, so we choose SIM1 card to perform all test.

1.4 Testing Site

Test Site	SPORTON INTERNATIONAL (KUNSHAN) INC.		
Test Site Location	No. 3-2, PingXiang Road, Kunshan, Jiangsu Province, P.R.C. TEL: +86-0512-5790-0158 FAX: +86-0512-5790-0958		
Test Site No.	Sporton Site No.		
	TH01-KS	CO01-KS	03CH01-KS

1.5 Applied Standards

According to the specifications of the manufacturer, the EUT must comply with the requirements of the following standards:

- ♦ FCC Part 15 Subpart C §15.247
- ♦ FCC Public Notice DA 00-705
- ♦ ANSI C63.4-2003

Remark:

1. All test items were verified and recorded according to the standards and without any deviation during the test.
2. This EUT has also been tested and complied with the requirements of FCC Part 15, Subpart B (certification), recorded in a separate test report.



1.6 Ancillary Equipment List

Item	Equipment	Trade Name	Model Name	FCC ID	Data Cable	Power Cord
1.	Bluetooth Base Station	R&S	CBT	N/A	N/A	Unshielded, 1.8 m
2.	System Simulator	R&S	CMU 200	N/A	N/A	Unshielded, 1.8 m
3.	Bluetooth Earphone	Nokia	BH-102	PYAHS-107W	N/A	N/A
4.	Router	D-Link	DIR-855	KA2DIR855A2	N/A	Unshielded, 1.8 m
5.	Notebook	Acer	Trave Imate 2413Lci	QDS-BRCM1016	N/A	AC I/P: Unshielded, 1.8 m DC O/P: Shielded, 1.8 m

2 Test Configuration of Equipment Under Test

2.1 RF Output Power

Preliminary tests were performed in different data rate and recorded the RF output power in the following table:

Channel	Frequency	Bluetooth RF Output Power					
		Data Rate / Modulation					
		GFSK		$\pi/4$ -DQPSK		8-DPSK	
		1Mbps		2Mbps		3Mbps	
Ch00	2402MHz	9.27	dBm	9.08	dBm	9.24	dBm
Ch39	2441MHz	9.72	dBm	9.46	dBm	9.62	dBm
Ch78	2480MHz	9.84	dBm	9.60	dBm	9.80	dBm

Remark:

1. The data rate was set in 1Mbps for all the test items due to the highest RF output power.
2. The EUT is programmed to transmit signals continuously for all testing.

2.2 Test Mode

The EUT has been associated with peripherals pursuant to ANSI C63.4-2003 and configuration operated in a manner tended to maximize its emission characteristics in a typical application. Frequency range investigated: conduction (150 kHz to 30 MHz), radiation (9 kHz to the 10th harmonic of the highest fundamental frequency or to 40 GHz, whichever is lower).

Pre-scanned tests were conducted to determine the final configuration from all possible combinations. The following tables are showing the test modes as the worst cases (H plane) and recorded in this report.

The following tables are showing the test modes as the worst cases and recorded in this report.

Test Cases			
Test Item	Data Rate / Modulation		
	Bluetooth 1Mbps GFSK	Bluetooth EDR 2Mbps $\pi/4$ -DQPSK	Bluetooth EDR 3Mbps 8-DPSK
Conducted TCs	Mode 1: CH00_2402 MHz Mode 2: CH39_2441 MHz Mode 3: CH78_2480 MHz	Mode 4: CH00_2402 MHz Mode 5: CH39_2441 MHz Mode 6: CH78_2480 MHz	Mode 7: CH00_2402 MHz Mode 8: CH39_2441 MHz Mode 9: CH78_2480 MHz
Radiated TCs	Mode 1: CH00_2402 MHz Mode 2: CH39_2441 MHz Mode 3: CH78_2480 MHz	N/A	N/A
AC Conducted Emission	Mode 1 :GSM 850 Idle + Bluetooth Link + WLAN Link + Adapter + Earphone + Camera		
Remark: 1. For radiated TCs, the data rate was set in 1Mbps due to the highest RF output power; only the data of these modes was reported. 2. For conducted emission, the worst case is mode 1; only the test data of this mode was reported.			

2.3 Connection Diagram of Test System

<Bluetooth Tx Mode>

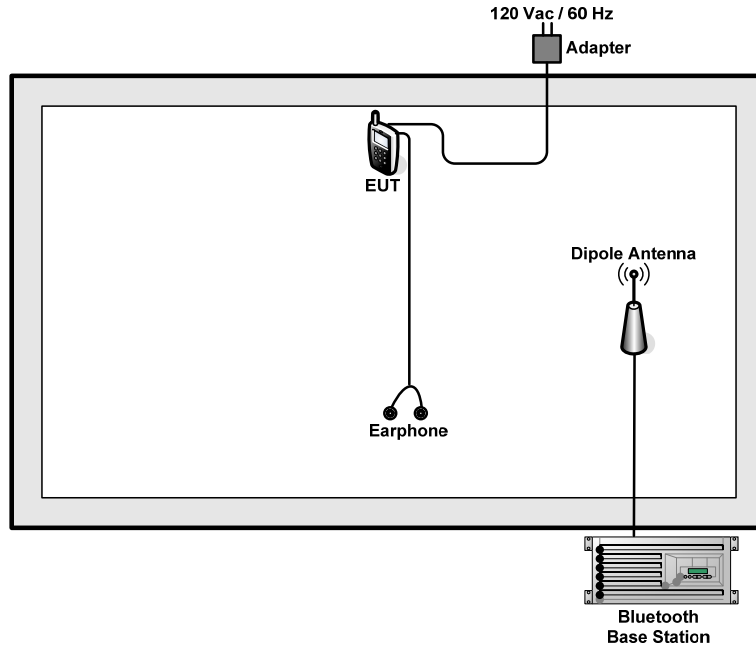

<AC Conducted Emission Mode>

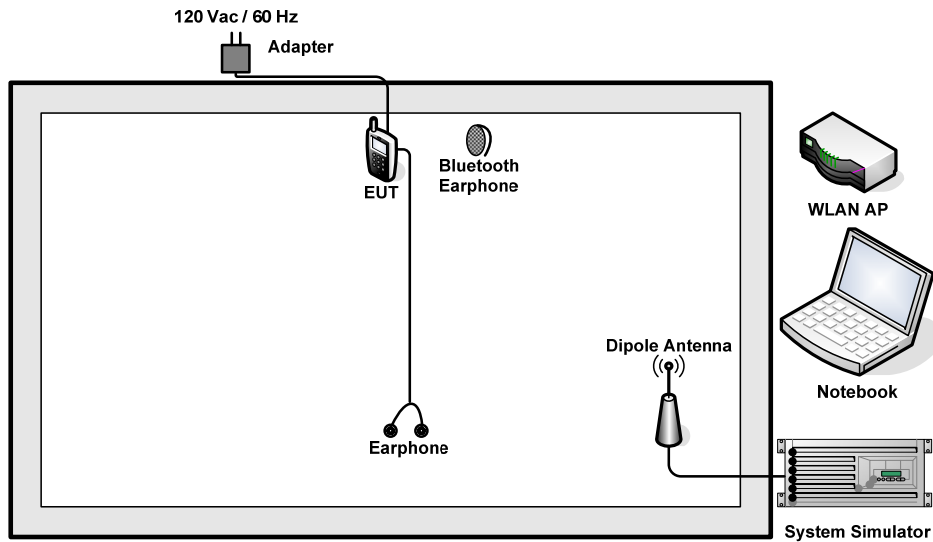

2.4 RF Utility

For Bluetooth function, the RF utility, “*#336633#” was installed in EUT which was programmed in order to make the EUT into the engineering modes to contact with Bluetooth base station for transmitting and receiving signals continuously.

3 Test Result

3.1 Number of Channel Measurement

3.1.1 Limits of Number of Hopping Frequency

Frequency hopping systems in the 2400-2483.5 MHz band shall use at least 15 channels.

3.1.2 Measuring Instruments

See list of measuring instruments of this test report.

3.1.3 Test Procedure

1. The testing follows FCC Public Notice DA 00-705 Measurement Guidelines.
2. The RF output of EUT was connected to the spectrum analyzer by a low loss cable.
3. The modulation types of EUT are irrelevant to number of hopping channels deviation.
4. The EUT must have its hopping function enabled. Use the following spectrum analyzer settings:
Span = the frequency band of operation; RBW \geq 1% of the span; VBW \geq RBW; Sweep = auto;
Detector function = peak; Trace = max hold.
5. The number of hopping frequency used is defined as the device has the numbers of total channel.

3.1.4 Test Setup

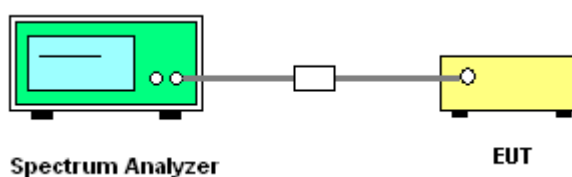

3.1.5 Test Result of Number of Hopping Frequency

Test Mode :	Mode 1~3	Temperature :	24~25°C
Test Engineer :	Zhi Lu	Relative Humidity :	47~48%
Number of Hopping Channels (Channel)		Limits (Channel)	Pass/Fail
79		> 15	Pass



Number of Hopping Channel Plot on Channel 00 - 78

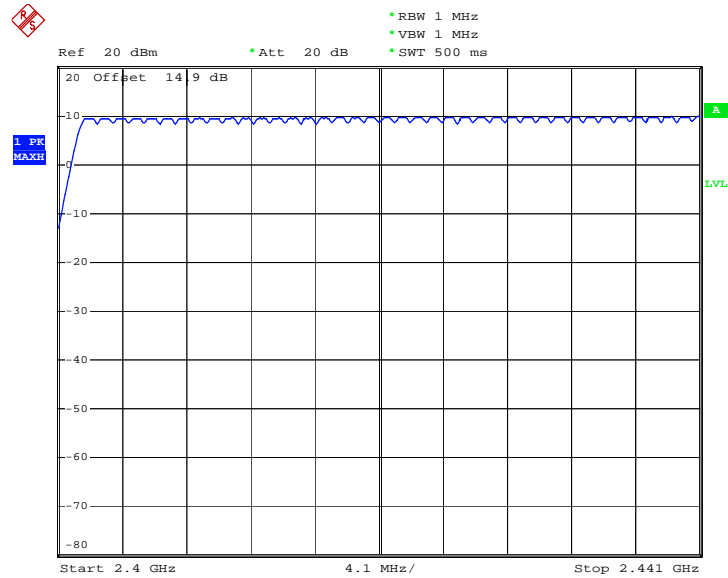

Date: 21.DEC.2011 17:47:13

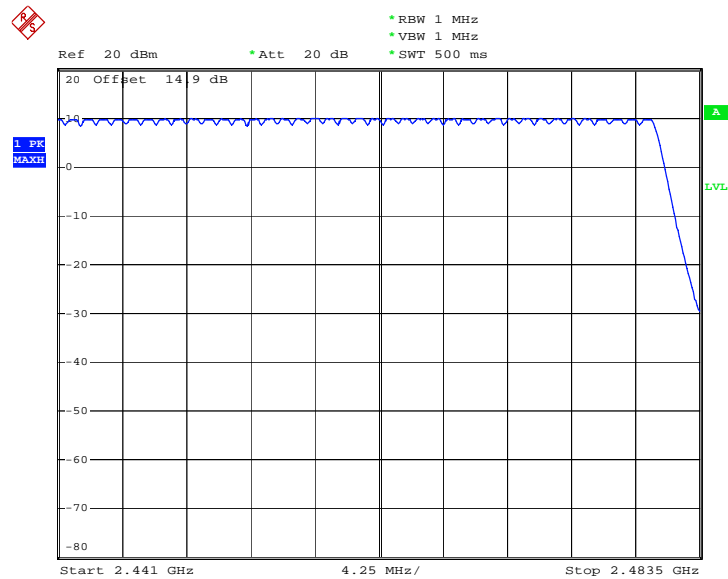

Date: 21.DEC.2011 17:52:20

3.2 20dB Bandwidth Measurement

3.2.1 Limit of 20dB Bandwidth

N/A

3.2.2 Measuring Instruments

See list of measuring instruments of this test report.

3.2.3 Test Procedures

1. The testing follows FCC Public Notice DA 00-705 Measurement Guidelines.
2. The RF output of EUT was connected to the spectrum analyzer by a low loss cable.
3. The EUT should be transmitting at its maximum data rate as the worst cases.
4. Use the following spectrum analyzer settings:
Span = approximately 2 to 3 times the 20 dB bandwidth, centered on a hopping channel;
RBW \geq 1% of the 20 dB bandwidth; VBW \geq RBW; Sweep = auto; Detector function = peak;
Trace = max hold.
5. The marker-delta reading at this point is the 20 dB bandwidth of the emission.

3.2.4 Test Setup

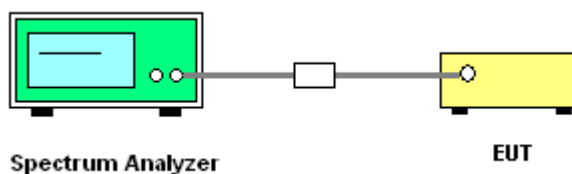

3.2.5 Test Result of 20dB Bandwidth

Test Mode :	Mode 1, 2, 3	Temperature :	24~25°C
Test Engineer :	Zhi Lu	Relative Humidity :	47~48%

Channel	Frequency (MHz)	20dB Bandwidth (MHz)
00	2402	0.912
39	2441	0.940
78	2480	0.856

20 dB Bandwidth Plot on Channel 00

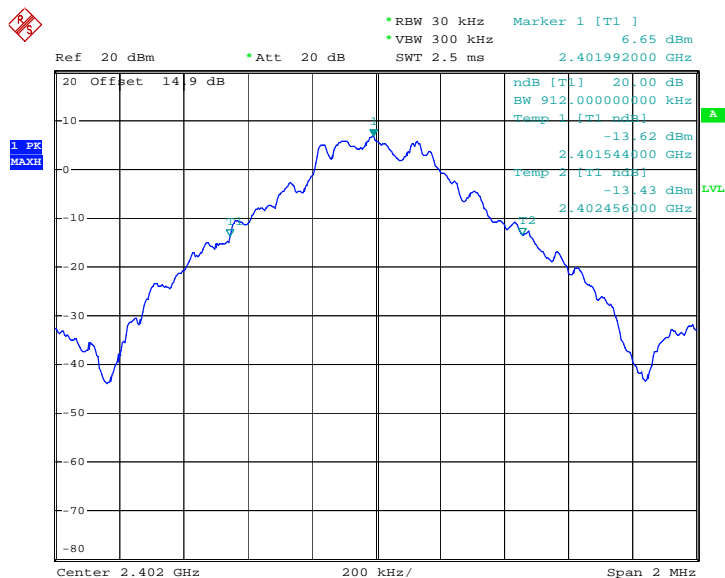

Date: 21.DEC.2011 17:11:03



20 dB Bandwidth Plot on Channel 39

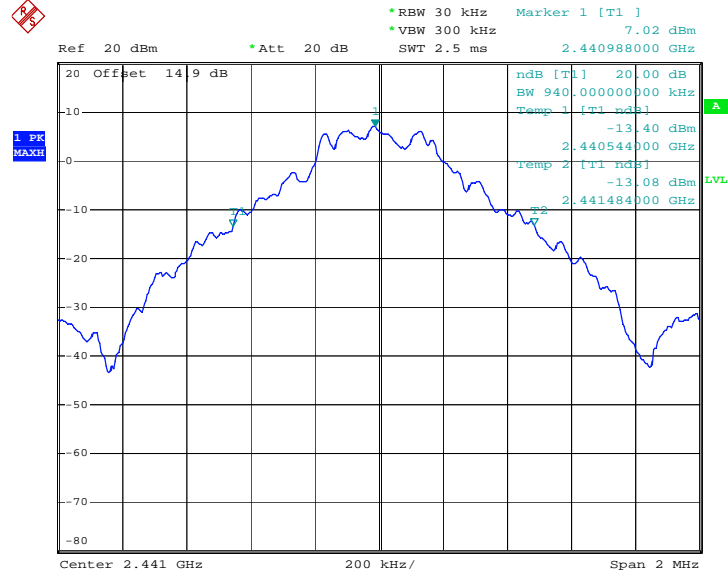

Date: 21.DEC.2011 17:11:30

20 dB Bandwidth Plot on Channel 78

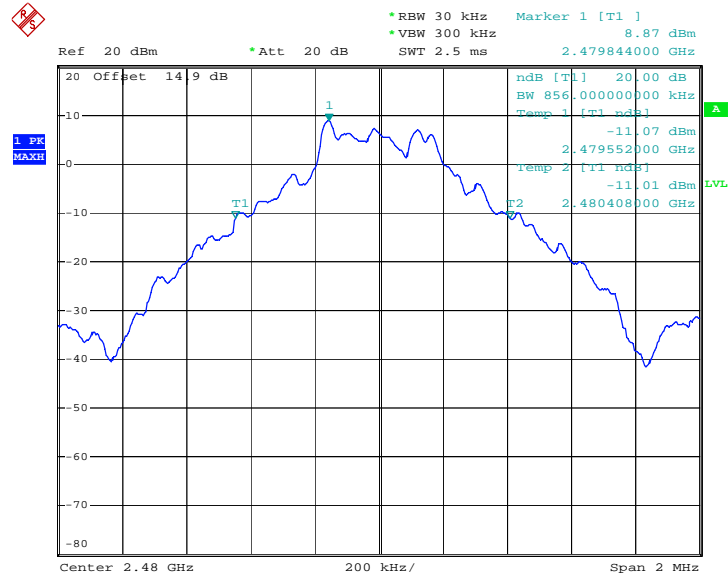

Date: 21.DEC.2011 17:11:55



Test Mode :	Mode 4, 5, 6	Temperature :	24~25°C
Test Engineer :	Zhi Lu	Relative Humidity :	47~48%

Channel	Frequency (MHz)	20dB Bandwidth (MHz)
00	2402	1.266
39	2441	1.266
78	2480	1.224

20 dB Bandwidth Plot on Channel 00

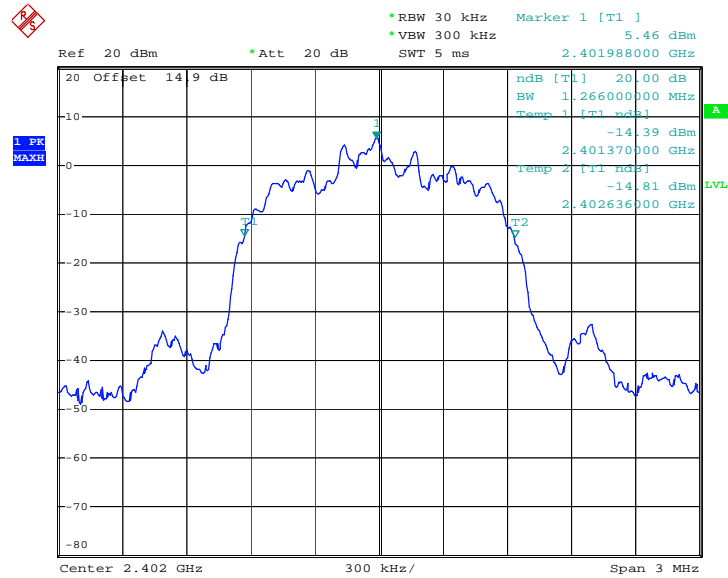

Date: 21.DEC.2011 17:12:16



Test Mode :	Mode 7, 8, 9	Temperature :	24~25°C
Test Engineer :	Zhi Lu	Relative Humidity :	47~48%

Channel	Frequency (MHz)	20dB Bandwidth (MHz)
00	2402	1.284
39	2441	1.296
78	2480	1.284

20 dB Bandwidth Plot on Channel 00

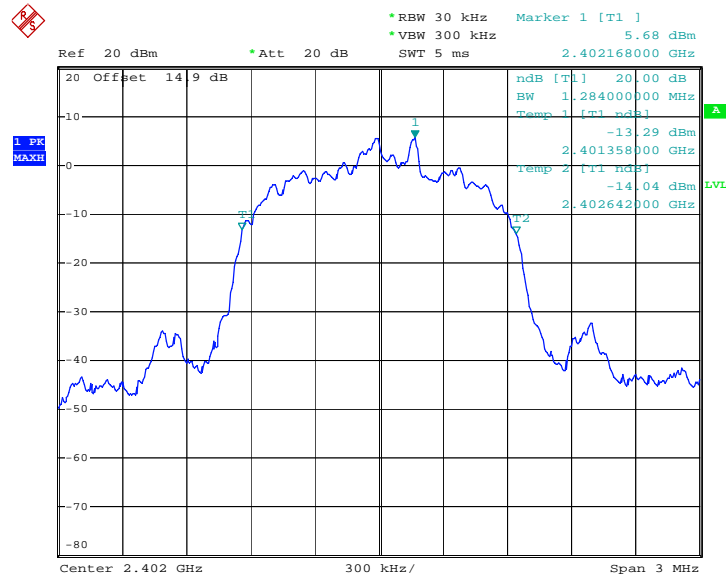

Date: 21.DEC.2011 17:13:37



20 dB Bandwidth Plot on Channel 39

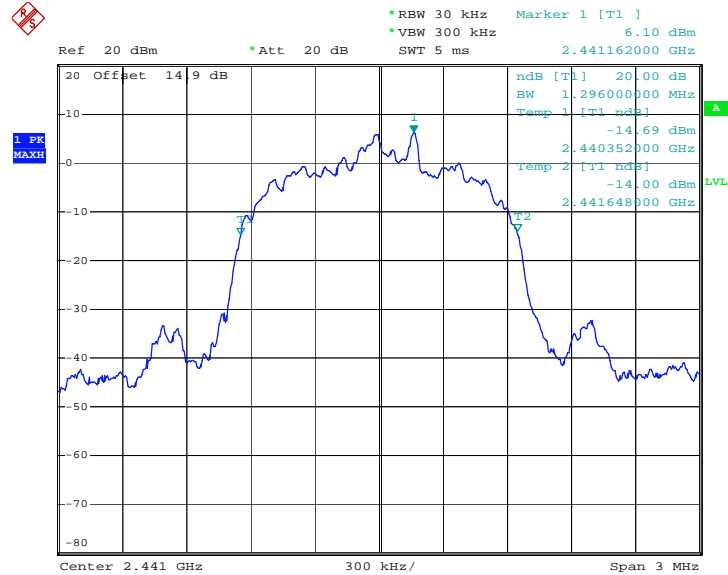

Date: 21.DEC.2011 17:14:01

20 dB Bandwidth Plot on Channel 78

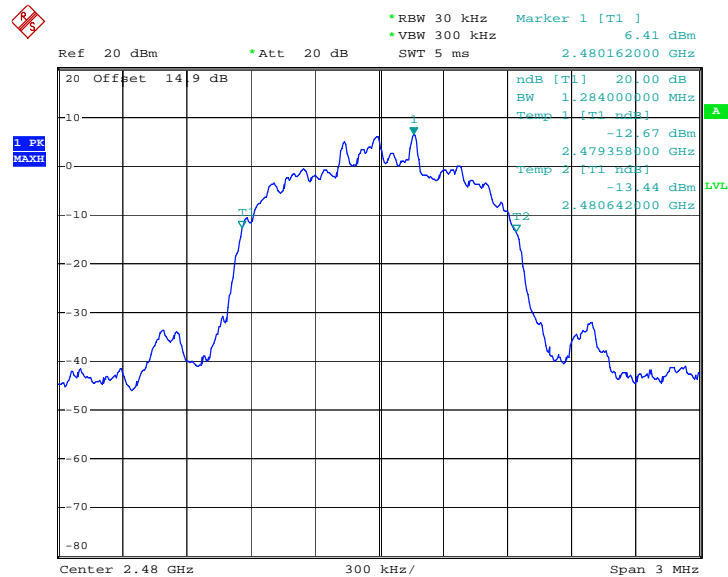

Date: 21.DEC.2011 17:14:33

3.3 Hopping Channel Separation Measurement

3.3.1 Limit of Hopping Channel Separation

Frequency hopping systems operating in the 2400-2483.5 MHz band may have hopping channel carrier frequencies that are separated by 25 kHz or two-thirds of the 20 dB bandwidth of the hopping channel, whichever is greater.

3.3.2 Measuring Instruments

See list of measuring instruments of this test report.

3.3.3 Test Procedures

1. Please refer FCC Public Notice DA 00-705 Measurement Guidelines.
2. The RF output of EUT was connected to the spectrum analyzer by a low loss cable.
3. The EUT should be transmitting at its maximum data rate as the worst cases.
4. Use the following spectrum analyzer settings:
Span = wide enough to capture the peaks of two adjacent channels; $RBW \geq 1\%$ of the span;
 $VBW \geq RBW$; Sweep = auto; Detector function = peak; Trace = max hold.
5. Use the marker-delta function to determine the separation between the peaks of the adjacent channels.

3.3.4 Test Setup

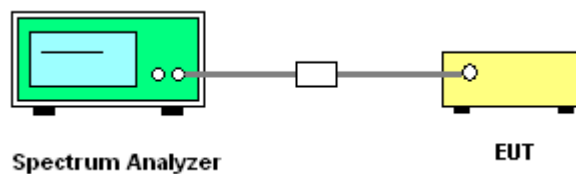



3.3.5 Test Result of Hopping Channel Separation

Test Mode :	Mode 1, 2, 3	Temperature :	24~25°C
Test Engineer :	Zhi Lu	Relative Humidity :	47~48%

Channel	Frequency (MHz)	Frequency Separation (MHz)	(2/3 of 20dB BW) Limits (MHz)	Pass/Fail
00	2402	1.002	0.608	Pass
39	2441	1.002	0.627	Pass
78	2480	1.002	0.571	Pass

Channel Separation Plot on Channel 00 - 01

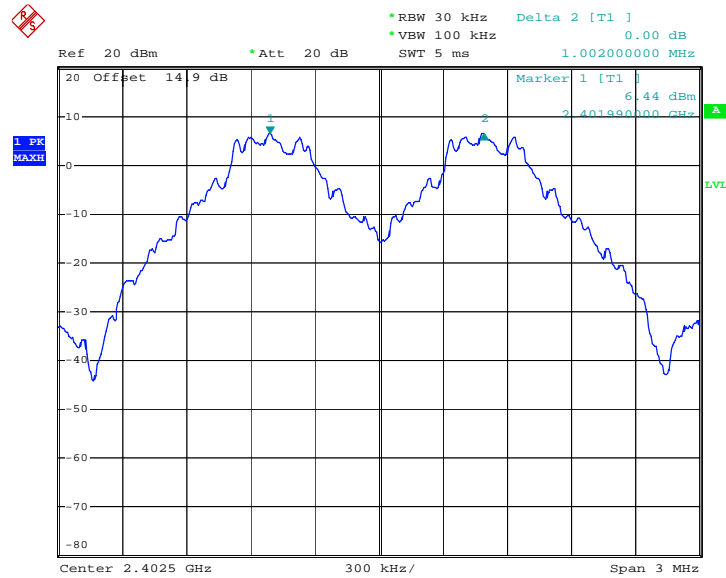

Date: 21.DEC.2011 17:00:35



Channel Separation Plot on Channel 39 - 40

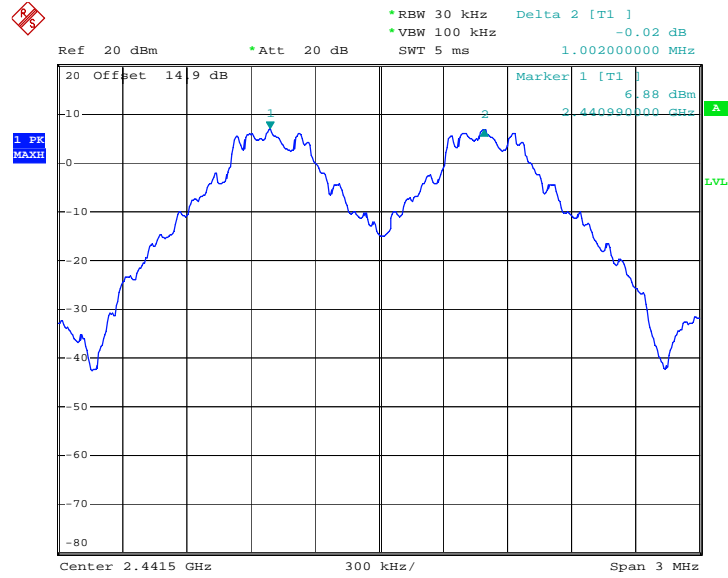

Date: 21.DEC.2011 17:01:15

Channel Separation Plot on Channel 77 - 78

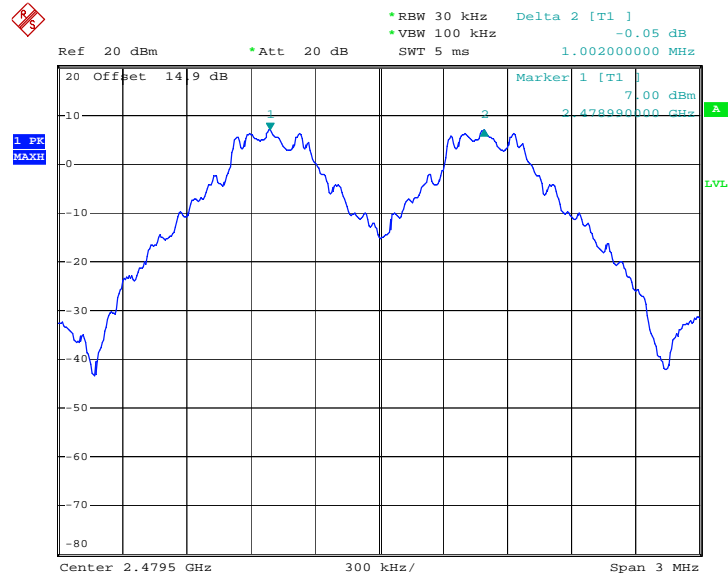

Date: 21.DEC.2011 17:01:54



Test Mode :	Mode 4, 5, 6	Temperature :	24~25°C
Test Engineer :	Zhi Lu	Relative Humidity :	47~48%

Channel	Frequency (MHz)	Frequency Separation (MHz)	(2/3 of 20dB BW) Limits (MHz)	Pass/Fail
00	2402	1.002	0.844	Pass
39	2441	1.008	0.844	Pass
78	2480	1.002	0.816	Pass

Channel Separation Plot on Channel 00 - 01

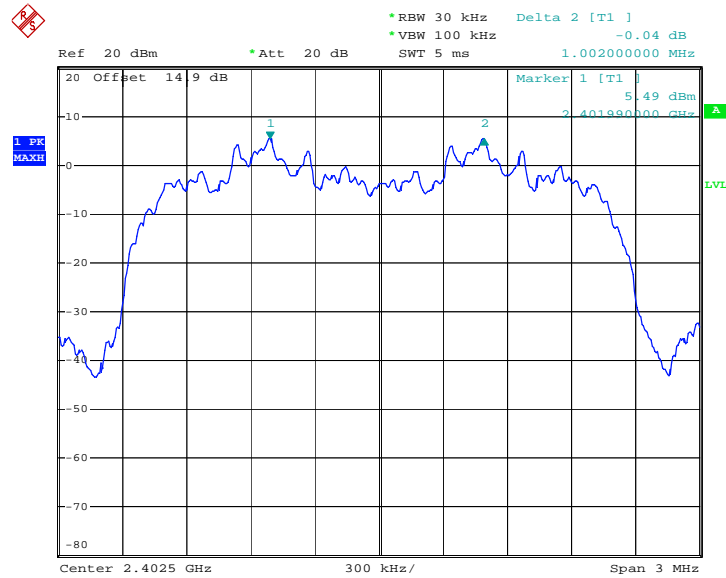

Date: 21.DEC.2011 17:03:21



Channel Separation Plot on Channel 39 - 40

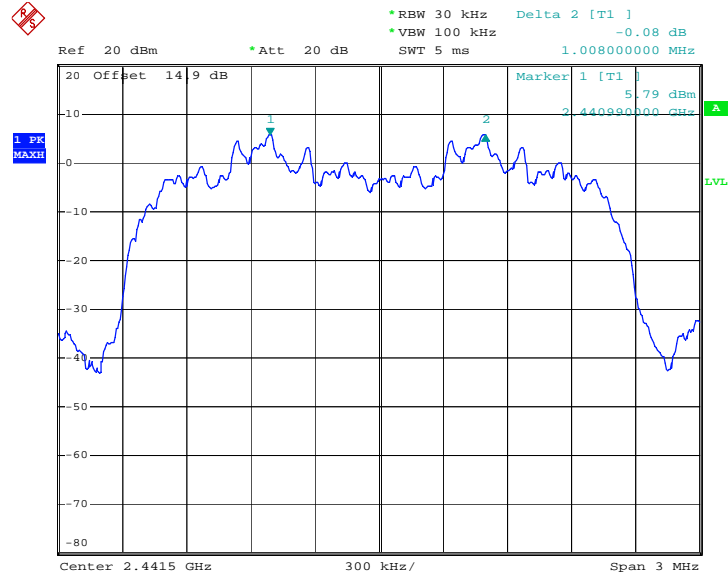

Date: 21.DEC.2011 17:04:02

Channel Separation Plot on Channel 77 - 78

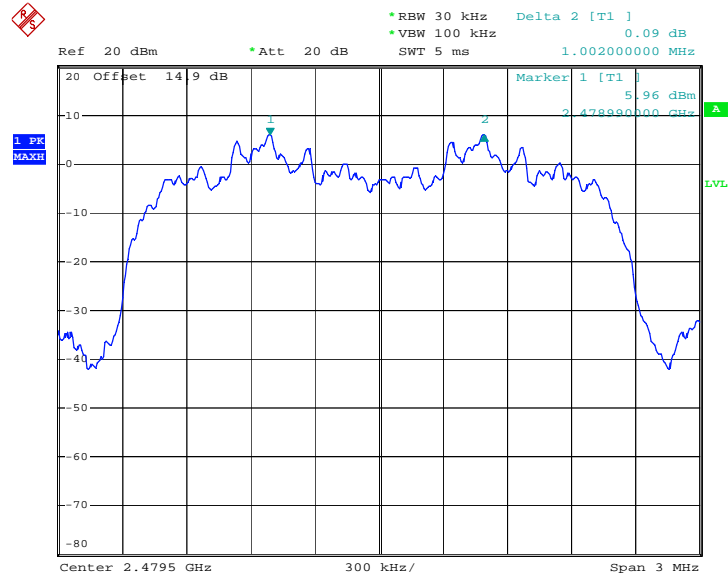

Date: 21.DEC.2011 17:05:00



Test Mode :	Mode 7, 8, 9	Temperature :	24~25°C
Test Engineer :	Zhi Lu	Relative Humidity :	47~48%

Channel	Frequency (MHz)	Frequency Separation (MHz)	(2/3 of 20dB BW) Limits (MHz)	Pass/Fail
00	2402	1.002	0.856	Pass
39	2441	1.002	0.864	Pass
78	2480	1.002	0.856	Pass

Channel Separation Plot on Channel 00 - 01

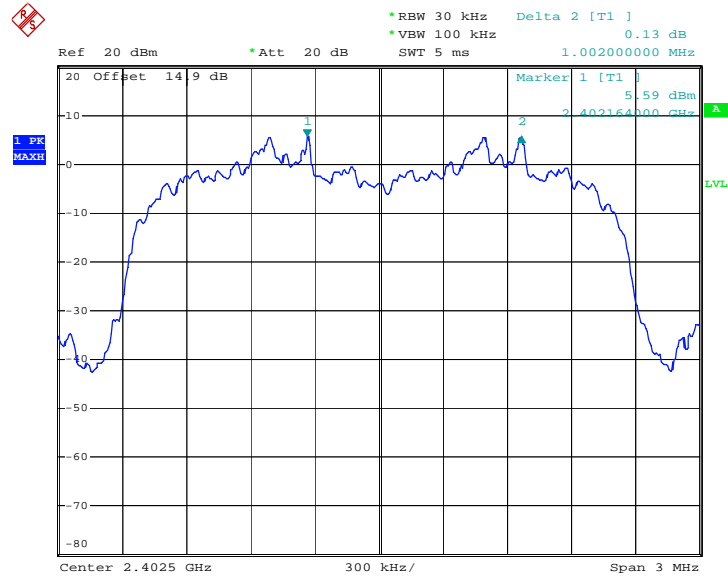

Date: 21.DEC.2011 17:06:21



Channel Separation Plot on Channel 39 - 40

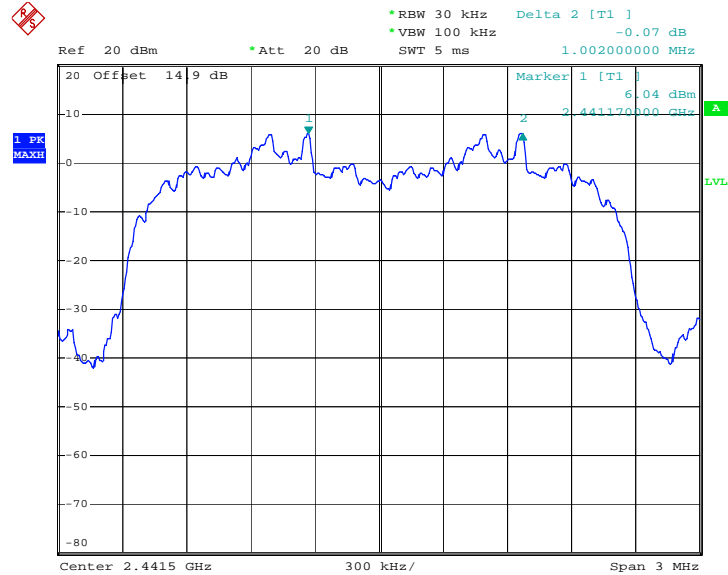

Date: 21.DEC.2011 17:07:48

Channel Separation Plot on Channel 77 - 78

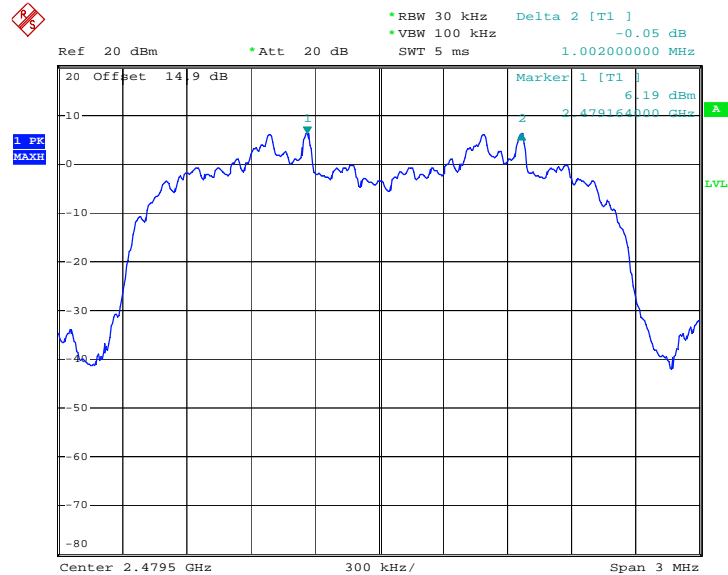

Date: 21.DEC.2011 17:08:27

3.4 Dwell Time Measurement

3.4.1 Limit of Dwell Time

The average time of occupancy on any channel shall not be greater than 0.4 seconds within a period of 0.4 seconds multiplied by the number of hopping channels employed.

3.4.2 Measuring Instruments

See list of measuring instruments of this test report.

3.4.3 Test Procedures

1. The testing follows FCC Public Notice DA 00-705 Measurement Guidelines.
2. The RF output of EUT was connected to the spectrum analyzer by a low loss cable.
3. The EUT should be transmitting at its maximum data rate as the worst cases.
4. The EUT must have its hopping function enabled. Use the following spectrum analyzer settings:
Span = zero span, centered on a hopping channel; RBW = 1 MHz; VBW ≥ RBW; Sweep = as necessary to capture the entire dwell time per hopping channel; Detector function = peak; Trace = max hold.
5. Use the marker-delta function to calculate the dwell time.

3.4.4 Test Setup

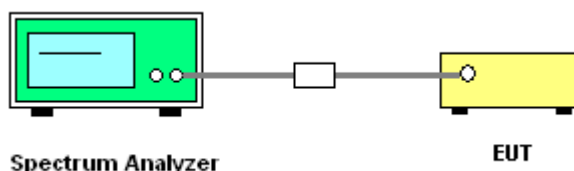

3.4.5 Test Result of Dwell Time

Test Mode :	Mode 2	Temperature :	24~25°C
Test Engineer :	Zhi Lu	Relative Humidity :	47~48%

Package Mode	Average Hopping Channel	Package Transfer Time (usec)	Dwell Time (sec)	Limits (sec)	Pass/Fail
DH5	3.20	2930.00	0.30	0.4	Pass

Remark:

1. Dwell Time=79(channels) x 0.4(s) x average hopping channel x package transfer time
2. 79 channels come from the Hopping Channel number.
3. Average Hopping Channel = hops/sweep time
4. t: Package Transfer Time(us)



DH5 Dwell Time (One Pulse) Plot on Channel 39

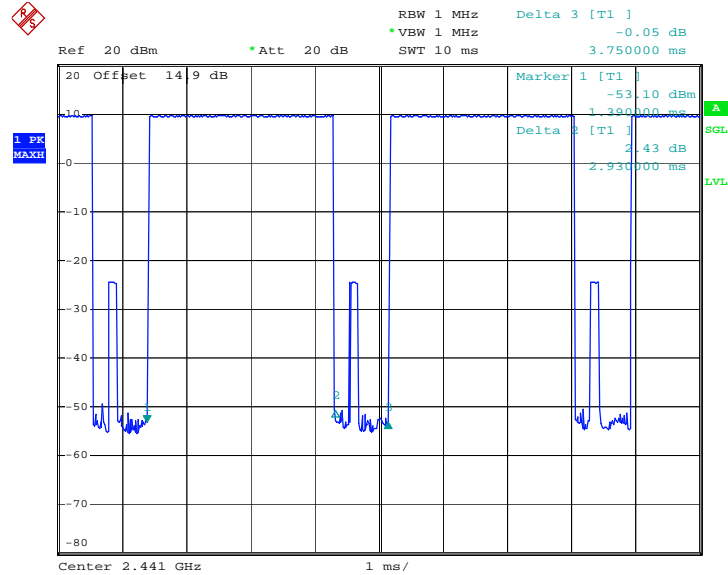

Date: 21.DEC.2011 16:56:44

DH5 Dwell Time (Count Pulses) Plot on Channel 39

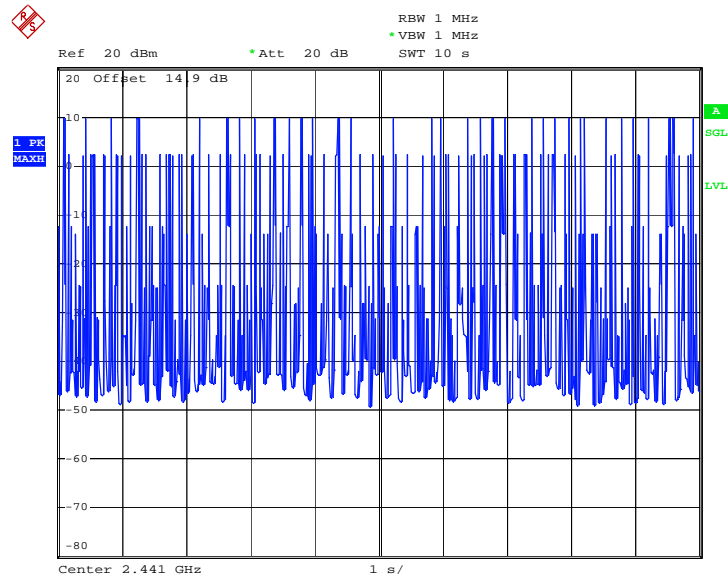

Date: 21.DEC.2011 17:09:13

3.5 Peak Output Power Measurement

3.5.1 Limit of Peak Output Power

Frequency hopping systems operating in the 2400-2483.5 MHz band may have hopping channel carrier frequencies that are separated by 25 kHz or two-thirds of the 20 dB bandwidth of the hopping channel, whichever is greater, provided the systems operate with an output power no greater than 125 mW (20.97dBm).

3.5.2 Measuring Instruments

See list of measuring instruments of this test report.

3.5.3 Test Procedures

1. The testing follows FCC Public Notice DA 00-705 Measurement Guidelines.
2. The RF output of EUT was connected to the spectrum analyzer by a low loss cable.

3.5.4 Test Setup

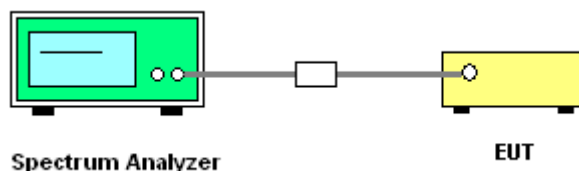

3.5.5 Test Result of Peak Output Power

Test Mode :	Mode 1, 2, 3	Temperature :	24~25°C	
Test Engineer :	Zhi Lu	Relative Humidity :	47~48%	

Channel	Frequency (MHz)	RF Power (dBm)		
		GFSK	Max. Limits (dBm)	Pass/Fail
		1 Mbps		
00	2402	9.27	20.97	Pass
39	2441	9.72	20.97	Pass
78	2480	9.84	20.97	Pass



Peak Output Power Plot on Channel 00

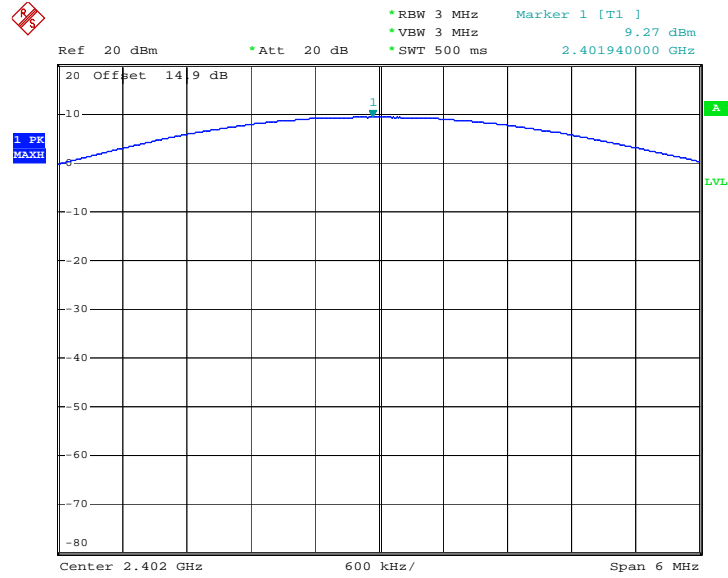

Date: 21.DEC.2011 16:45:11

Peak Output Power Plot on Channel 39

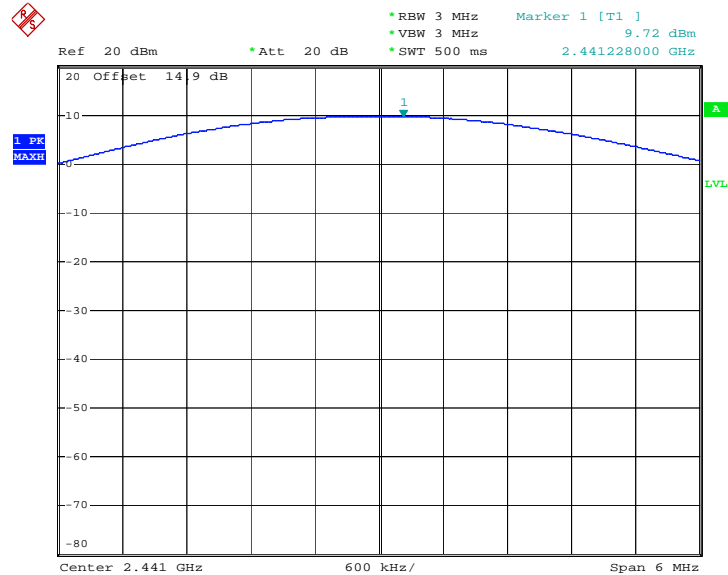

Date: 21.DEC.2011 16:46:27



Peak Output Power Plot on Channel 78

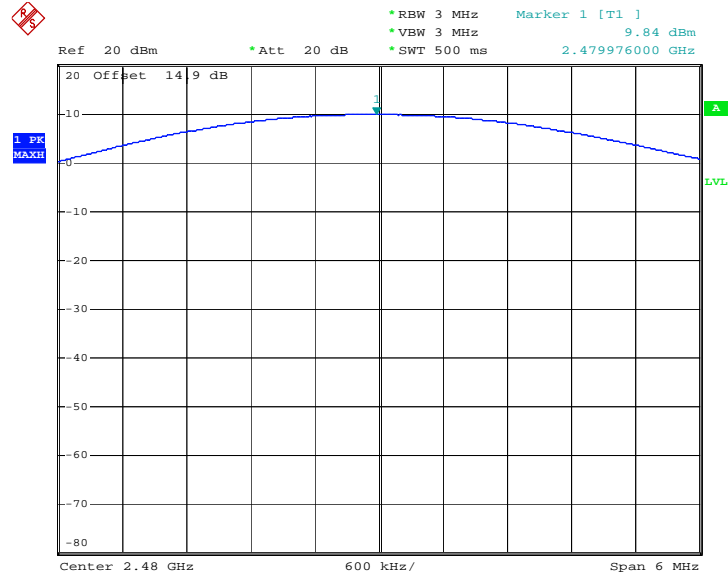

Date: 21.DEC.2011 16:47:43



3.6 Band Edges Measurement

3.6.1 Limit of Band Edges

In any 100 kHz bandwidth outside the intentional radiation frequency band, the radio frequency power shall be at least 20 dB below the highest level of the radiated power. In addition, radiated emissions which fall in the restricted bands must also comply with the radiated emission limits.

3.6.2 Measuring Instruments

See list of measuring instruments of this test report.

3.6.3 Test Procedures

1. The testing follows the guidelines in ANSI C63.4-2003 and FCC Public Notice DA 00-705 Measurement Guidelines.
2. RF antenna conducted test: Set RBW = 300kHz, Video bandwidth (VBW) \geq RBW. Band edge emissions must be at least 20 dB down from the highest emission level within the authorized band as measured with a 300k Hz RBW. Note: If the device complies with the use of power option 2 the attenuation under this paragraph shall be 30 dB instead of 20 dB.
3. Radiated emission test: Applies to band edge emissions that fall in the restricted bands listed in FCC Section 15.205. The maximum permitted average field strength is listed in FCC Section 15.209. A pre-amp is necessary for this measurement. For measurements above 1 GHz, set RBW = 1MHz, VBW = 1MHz, Sweep: Auto for Peak; set RBW = 1MHz, VBW = 10 Hz, Sweep: Auto for Average. If the emission is pulsed, modify the unit for continuous operation; use the settings shown above, then correct the reading by subtracting the peak-average correction factor, derived from the appropriate duty cycle calculation. See FCC Section 15.35(b) and (c).
4. In case the emission is fail due to the used RBW / VBW is too wide, marker-delta method of FCC Public Notice DA 00-705 will be followed.

3.6.4 Test Setup

<Radiated Band Edges>

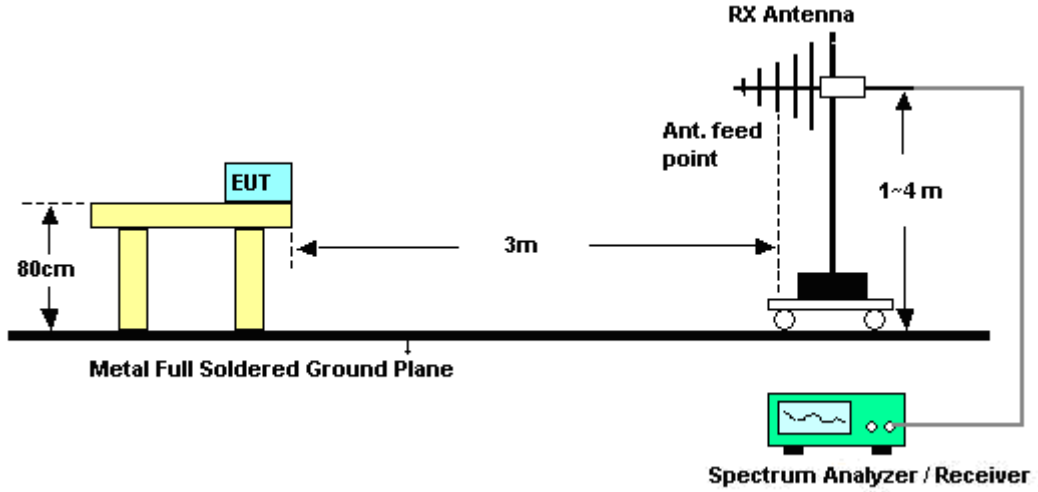

<Conducted Band Edges>

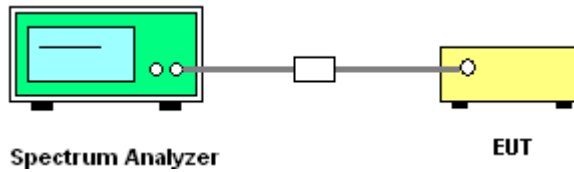



3.6.5 Test Result of Radiated Band Edges

Test Mode :	Mode 1	Temperature :	20~21°C
Test Channel :	00	Relative Humidity :	41~42%
		Test Engineer :	Cloud Peng

ANTENNA POLARITY : HORIZONTAL										
Frequency (MHz)	Level (dBuV/m)	Over Limit (dB)	Limit Line (dBuV/m)	Read Level (dBuV)	Antenna Factor (dB)	Cable Loss (dB)	Preamp Factor (dB)	Ant Pos (cm)	Table Pos (deg)	Remark
2316.08	45.2	-28.8	74	43.11	32.73	3.22	33.86	100	360	Peak
2316.08	32.38	-21.62	54	30.29	32.73	3.22	33.86	100	360	Average

ANTENNA POLARITY : VERTICAL										
Frequency (MHz)	Level (dBuV/m)	Over Limit (dB)	Limit Line (dBuV/m)	Read Level (dBuV)	Antenna Factor (dB)	Cable Loss (dB)	Preamp Factor (dB)	Ant Pos (cm)	Table Pos (deg)	Remark
2357.69	45.5	-28.5	74	43.29	32.81	3.38	33.98	122	0	Peak
2357.69	32.66	-21.34	54	30.45	32.81	3.38	33.98	122	0	Average



Test Mode :	Mode 3	Temperature :	20~21°C
Test Channel :	78	Relative Humidity :	41~42%
		Test Engineer :	Cloud Peng

ANTENNA POLARITY : HORIZONTAL										
Frequency (MHz)	Level (dBuV/m)	Over Limit (dB)	Limit Line (dBuV/m)	Read Level (dBuV)	Antenna Factor (dB)	Cable Loss (dB)	Preamp Factor (dB)	Ant Pos (cm)	Table Pos (deg)	Remark
2484.52	39.71	-34.29	74	37.22	33.01	3.68	34.2	200	350	Peak
2484.52	25.94	-28.06	54	23.45	33.01	3.68	34.2	200	350	Average

Summary results of marker-delta method:

Test mode	Maximum field strength of the fundamental emission (dBµV/m)	Delta Result (dB)	Average Result (dBµV/m)	Average Limit (dBµV/m)	Margin (dB)	Result
Single Carrier Mode	78.68	53.05	25.63	54	-28.37	Pass
Hopping Mode	78.68	52.74	25.94	54	-28.06	Pass

Note : Average result = Maximum field strength – Delta result

ANTENNA POLARITY : VERTICAL										
Frequency (MHz)	Level (dBuV/m)	Over Limit (dB)	Limit Line (dBuV/m)	Read Level (dBuV)	Antenna Factor (dB)	Cable Loss (dB)	Preamp Factor (dB)	Ant Pos (cm)	Table Pos (deg)	Remark
2483.92	39.42	-34.58	74	36.93	33.01	3.68	34.2	120	0	Peak
2483.92	27.56	-26.44	54	25.07	33.01	3.68	34.2	120	0	Average

Summary results of marker-delta method:

Test mode	Maximum field strength of the fundamental emission (dBµV/m)	Delta Result (dB)	Average Result (dBµV/m)	Average Limit (dBµV/m)	Margin (dB)	Result
Single Carrier Mode	76.88	50.27	26.61	54	-27.39	Pass
Hopping Mode	76.88	49.32	27.56	54	-26.44	Pass

Note : Average result = Maximum field strength – Delta result



Test Mode :	Mode 3	Temperature :	20~21°C
Test Channel :	78	Relative Humidity :	41~42%
Test Engineer :	Cloud Peng	Polarization :	Horizontal

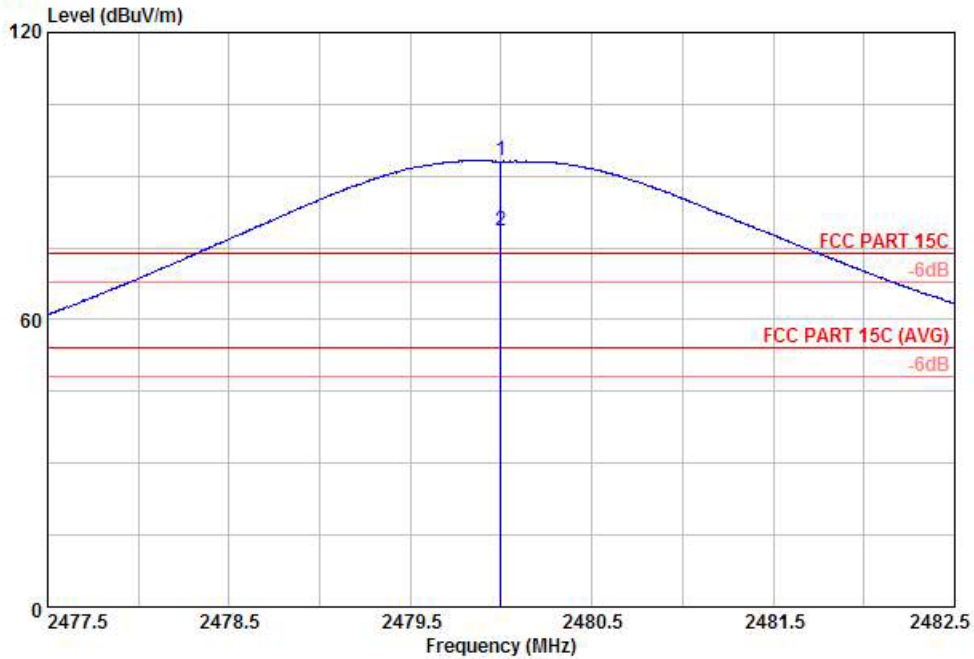

Site : 03CH01-KS
 Condition: FCC PART 15C 3m HF ANT-100803 HORIZONTAL
 Project : (FR) 1D1302
 Mode : mode 3
 Plane : H

	Freq	Level	Over Limit	Limit Line	ReadAntenna Level	Antenna Factor	Cable Loss	Preamp Factor	Ant Pos	Table Pos	Remark
	MHz	dBuV/m	dB	dBuV/m	dBuV	dB/m	dB	dB	cm	deg	
1 X	2480.00	93.15	19.15	74.00	90.66	33.01	3.68	34.20	192	359	Peak
2 X	2480.00	78.68	24.68	54.00	76.19	33.01	3.68	34.20	192	359	Average

* Maximum field strength of the fundamental emission



Test Mode :	Mode 3	Temperature :	20~21°C
Test Channel :	78	Relative Humidity :	41~42%
Test Engineer :	Cloud Peng	Polarization :	Horizontal

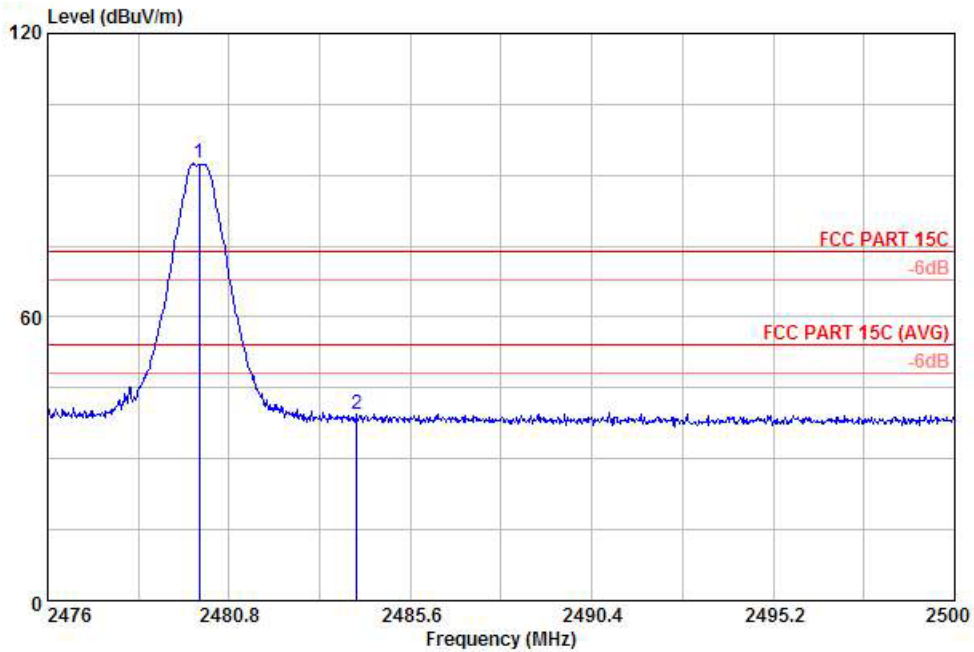

Site : 03CH01-KS
 Condition: FCC PART 15C 3m HF ANI-100803 HORIZONTAL
 Project : (FR) 1D1302
 Mode : mode 3
 Plane : H

	Freq	Level	Over	Limit	ReadAntenna	Cable	Preamp	Ant	Table	
	MHz	dBuV/m	dB	dBuV/m	Level Factor	Loss	Factor	Pos	Pos	Remark
					dBuV	dB	dB	cm	deg	
1 X	2480.00	92.58	18.58	74.00	90.09	3.68	34.20	200	360	Peak
2	2484.18	39.53	-34.47	74.00	37.04	3.68	34.20	200	355	Peak

* Marker-Delta Method (RBW/VBW=100KHz): 53.05 dB , single carrier Mode



Test Mode :	Mode 3	Temperature :	20~21°C
Test Channel :	78	Relative Humidity :	41~42%
Test Engineer :	Cloud Peng	Polarization :	Horizontal

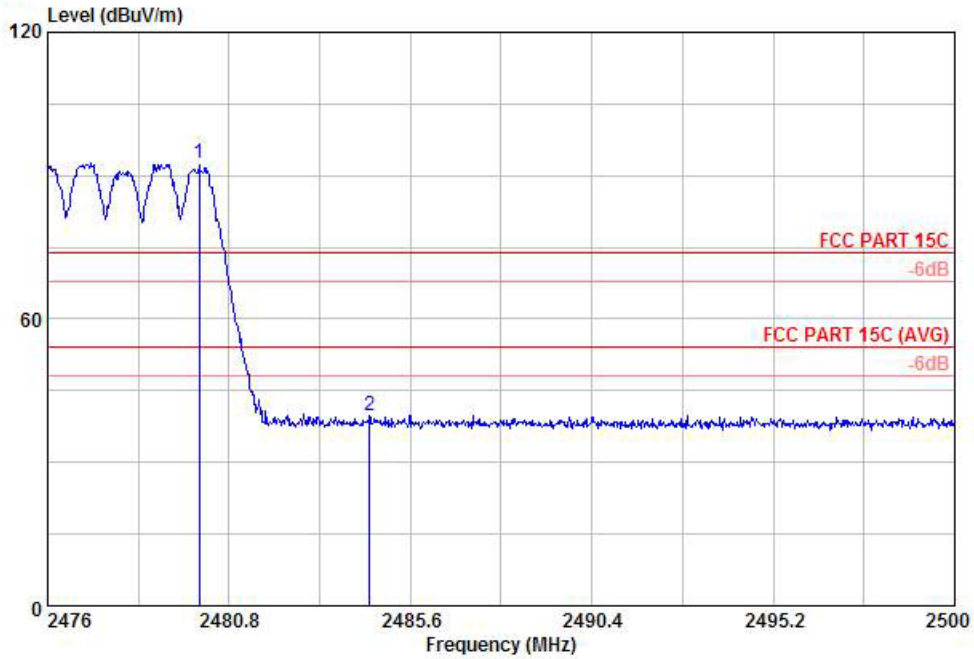

Site : 03CH01-KS
 Condition: FCC PART 15C 3m HF ANI-100803 HORIZONTAL
 Project : (FR) 1D1302
 Mode : mode 3
 Plane : H

	Freq	Level	Over	Limit	ReadAntenna	Cable	Preamp	Ant	Table	
	MHz	dBuV/m	dB	dBuV/m	dBuV	Loss	Factor	Pos	Pos	Remark
					dB/m	dB	dB	cm	deg	
1 X	2480.00	92.45	18.45	74.00	89.96	3.68	34.20	195	359	Peak
2	2484.52	39.71	-34.29	74.00	37.22	3.68	34.20	200	350	Peak

* Marker-Delta Method (RBW/VBW=100KHz): 52.74 dB , Hopping Mode



Test Mode :	Mode 3	Temperature :	20~21°C
Test Channel :	78	Relative Humidity :	41~42%
Test Engineer :	Cloud Peng	Polarization :	Vertical

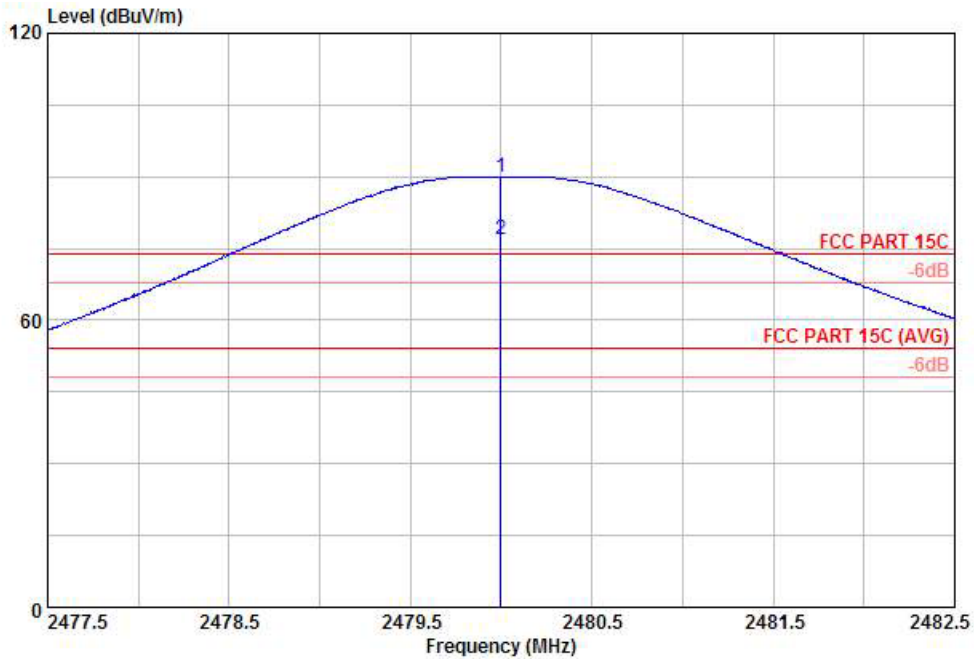

Site : 03CH01-KS
 Condition: FCC PART 15C 3m HF ANI-100803 VERTICAL
 Project : (FR) 1D1302
 Mode : mode 3
 Plane : H

	Freq	Level	Over	Limit	ReadAntenna	Cable	Preamp	Ant	Table	
	MHz	dBuV/m	dB	dBuV/m	Level	Loss	Factor	Pos	Pos	Remark
					Factor			cm	deg	
1 X	2480.00	90.07	16.07	74.00	87.58	33.01	3.68	34.20	101	125 Peak
2 X	2480.00	76.88	22.88	54.00	74.39	33.01	3.68	34.20	101	125 Average

* Maximum field strength of the fundamental emission



Test Mode :	Mode 3	Temperature :	20~21°C
Test Channel :	78	Relative Humidity :	41~42%
Test Engineer :	Cloud Peng	Polarization :	Vertical

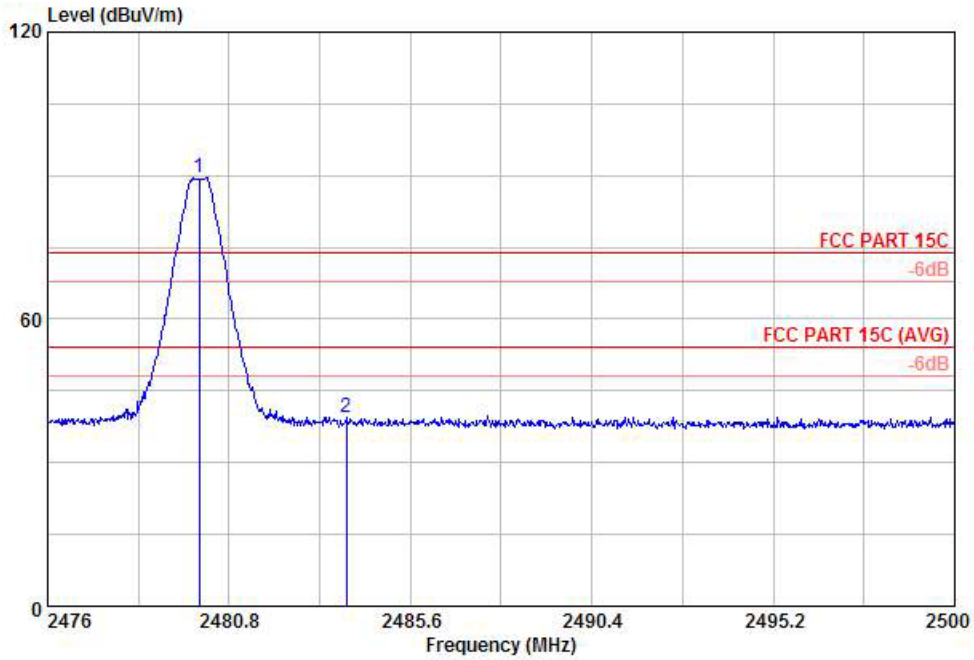

Site : 03CH01-KS
 Condition: FCC PART 15C 3m HF ANT-100803 VERTICAL
 Project : (FR) 1D1302
 Mode : mode 3
 Plane : H

	Freq	Level	Over Limit	Limit Line	ReadAntenna Level	Antenna Factor	Cable Loss	Preamp Factor	Ant Pos	Table Pos	Remark
	MHz	dBUV/m	dB	dBUV/m	dBuV	dB/m	dB	dB	cm	deg	
1 X	2480.00	89.64	15.64	74.00	87.15	33.01	3.68	34.20	100	130	Peak
2	2483.90	39.37	-34.63	74.00	36.88	33.01	3.68	34.20	113	122	Peak

* Marker-Delta Method (RBW/VBW=100KHz): 50.27 dB , single carrier Mode



Test Mode :	Mode 3	Temperature :	20~21°C
Test Channel :	78	Relative Humidity :	41~42%
Test Engineer :	Cloud Peng	Polarization :	Vertical

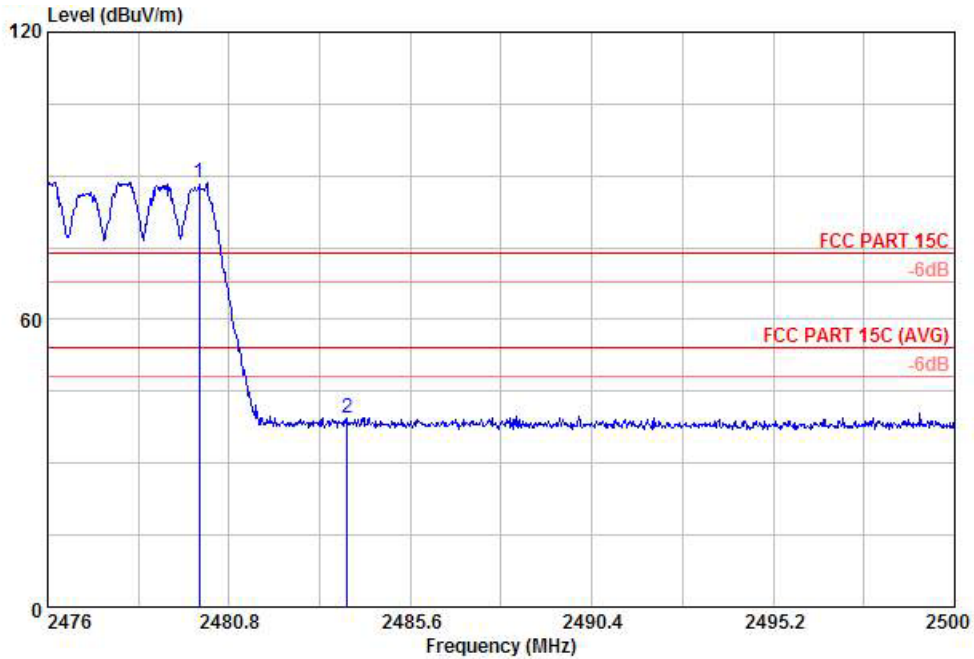

Site : 03CH01-KS
 Condition: FCC PART 15C 3m HF ANT-100803 VERTICAL
 Project : (FR) 1D1302
 Mode : mode 3
 Plane : H

	Freq	Level	Over Limit	Limit Line	ReadAntenna Level	Antenna Factor	Cable Loss	Preamp Factor	Ant Pos	Table Pos	Remark
	MHz	dBuV/m	dB	dBuV/m	dBuV	dB/m	dB	dB	cm	deg	
1 X	2480.00	88.74	14.74	74.00	86.25	33.01	3.68	34.20	102	122	Peak
2	2483.92	39.42	-34.58	74.00	36.93	33.01	3.68	34.20	120	0	Peak

* Marker-Delta Method (RBW/VBW=100KHz): 49.32 dB , Hopping Mode



3.6.6 Test Result of Conducted Band Edges

Test Mode :	Mode 1 and 3	Temperature :	24~25°C
Test Channel :	00 and 78	Relative Humidity :	47~48%
		Test Engineer :	Zhi Lu

Low Band Edge Plot on Channel 00

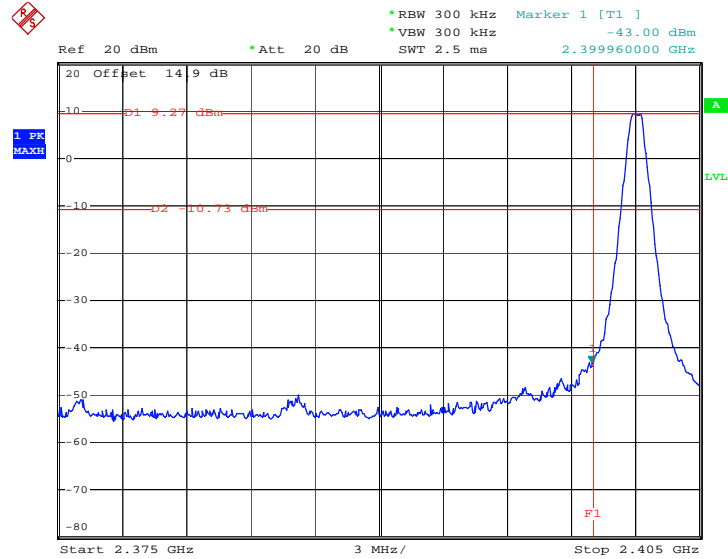

Date: 21.DEC.2011 17:15:28

High Band Edge Plot on Channel 78

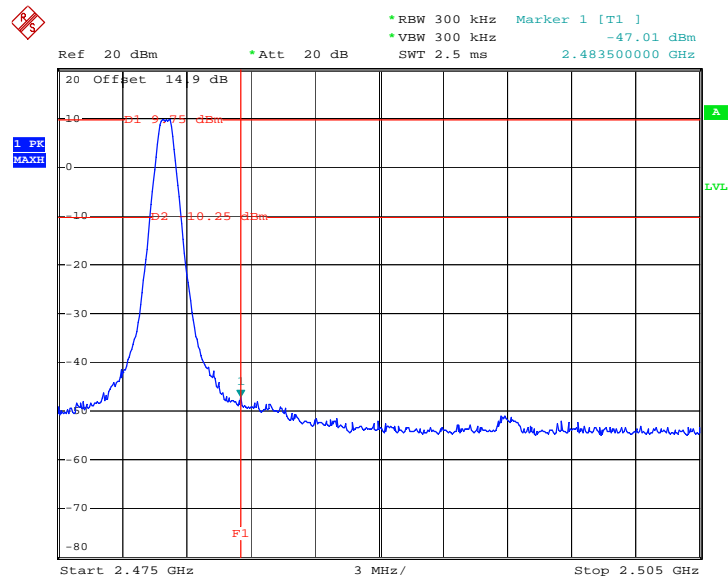

Date: 21.DEC.2011 17:16:31

3.7 Spurious Emission Measurement

3.7.1 Limit of Spurious Emission Measurement

All harmonics/spurious must be at least 20 dB down from the highest emission level within the authorized band.

3.7.2 Measuring Instruments

See list of measuring instruments of this test report.

3.7.3 Test Procedure

1. The transmitter output was connected to the spectrum analyzer via a low lose cable.
2. Set RBW = 100 kHz, Video bandwidth (VBW) \geq RBW, scan up through 10th harmonic. All harmonics / spurs must be at least 20 dB down from the highest emission level within the authorized band as measured with a 100 kHz RBW.

3.7.4 Test Setup

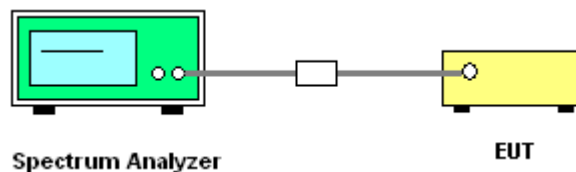



3.7.5 Test Result

Test Mode :	Mode 1	Temperature :	24~25°C
Test Channel :	00	Relative Humidity :	47~48%
		Test Engineer :	Zhi Lu

Conducted Spurious Emission Plot between 30MHz ~ 3 GHz

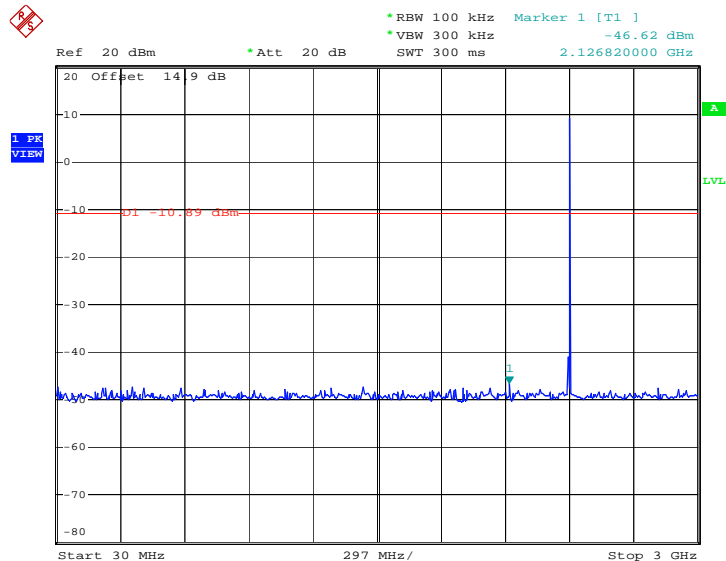

Date: 21.DEC.2011 17:26:41

Conducted Spurious Emission Plot between 3 GHz ~ 25 GHz

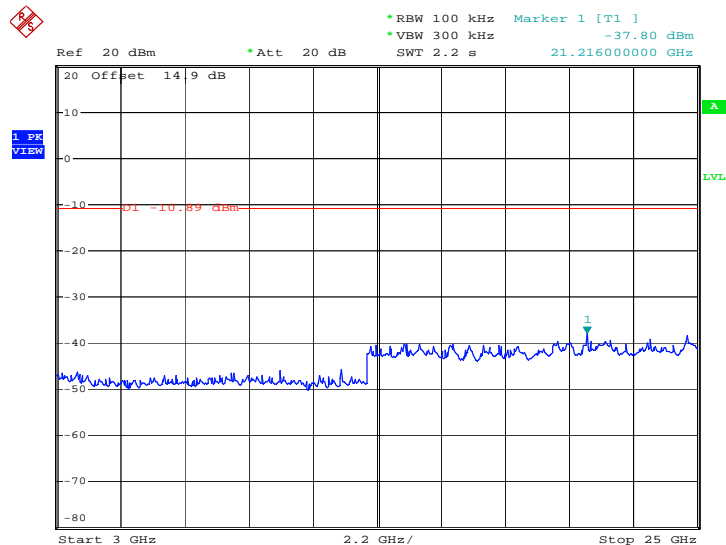

Date: 21.DEC.2011 17:26:53



Test Mode :	Mode 2	Temperature :	24~25°C
Test Channel :	39	Relative Humidity :	47~48%
		Test Engineer :	Zhi Lu

Conducted Spurious Emission Plot between 30MHz ~ 3 GHz

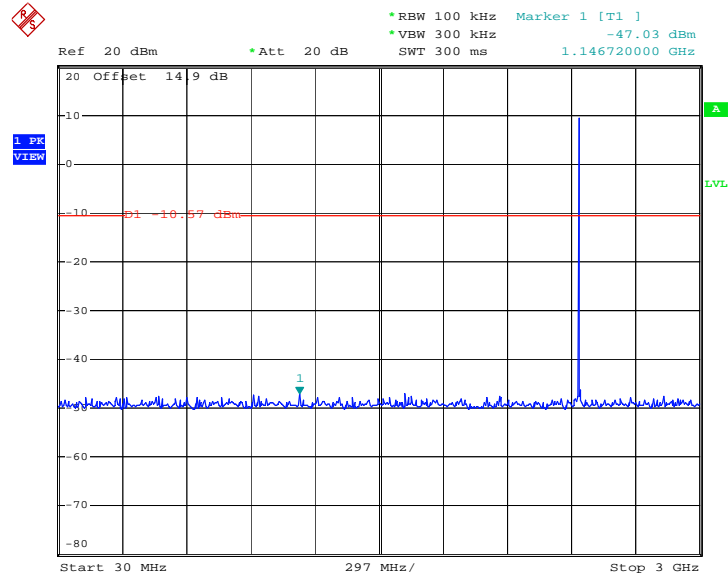

Date: 21.DEC.2011 17:27:45

Conducted Spurious Emission Plot between 3 GHz ~ 25 GHz

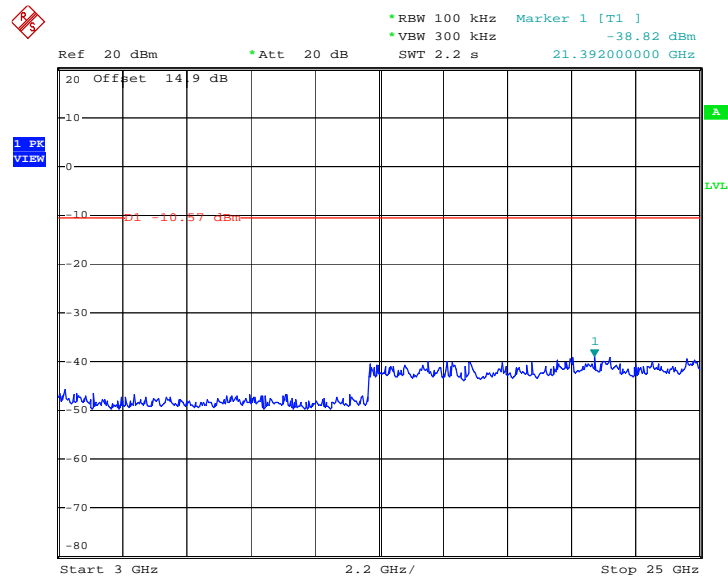

Date: 21.DEC.2011 17:27:57



Test Mode :	Mode 3	Temperature :	24~25°C
Test Channel :	78	Relative Humidity :	47~48%
		Test Engineer :	Zhi Lu

Conducted Spurious Emission Plot between 30MHz ~ 3 GHz

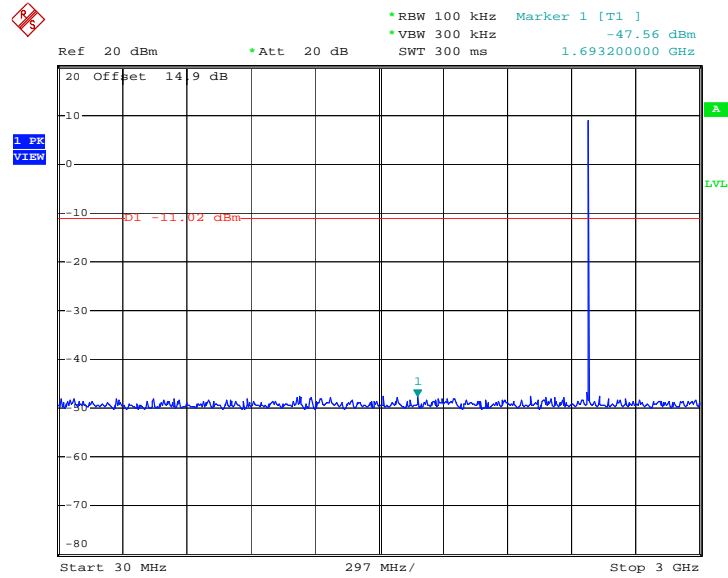

Date: 21.DEC.2011 17:28:49

Conducted Spurious Emission Plot between 3 GHz ~ 25 GHz

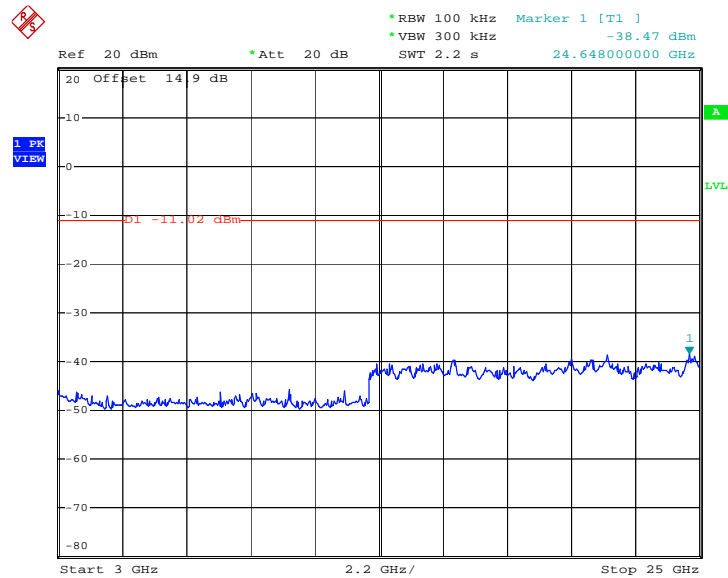

Date: 21.DEC.2011 17:29:01

3.8 AC Conducted Emission Measurement

3.8.1 Limit of AC Conducted Emission

For equipment that is designed to be connected to the public utility (AC) power line, the radio frequency voltage that is conducted back onto the AC power line on any frequency or frequencies within the band 150 kHz to 30 MHz shall not exceed the limits in the following table.

Frequency of emission (MHz)	Conducted limit (dBuV)	
	Quasi-peak	Average
0.15-0.5	66 to 56*	56 to 46*
0.5-5	56	46
5-30	60	50

*Decreases with the logarithm of the frequency.

3.8.2 Measuring Instruments

See list of measuring instruments of this test report.

3.8.3 Test Procedures

1. Please follow the guidelines in ANSI C63.4-2003.
2. The EUT was placed 0.4 meter from the conducting wall of the shielding room was kept at least 80 centimeters from any other grounded conducting surface.
3. Connect EUT to the power mains through a line impedance stabilization network (LISN).
4. All the support units are connecting to the other LISN.
5. The LISN provides 50 ohm coupling impedance for the measuring instrument.
6. The FCC states that a 50 ohm, 50 microhenry LISN should be used.
7. Both sides of AC line were checked for maximum conducted interference.
8. The frequency range from 150 kHz to 30 MHz was searched.
9. Set the test-receiver system to Peak Detect Function and specified bandwidth with Maximum Hold Mode.

3.8.4 Test Setup

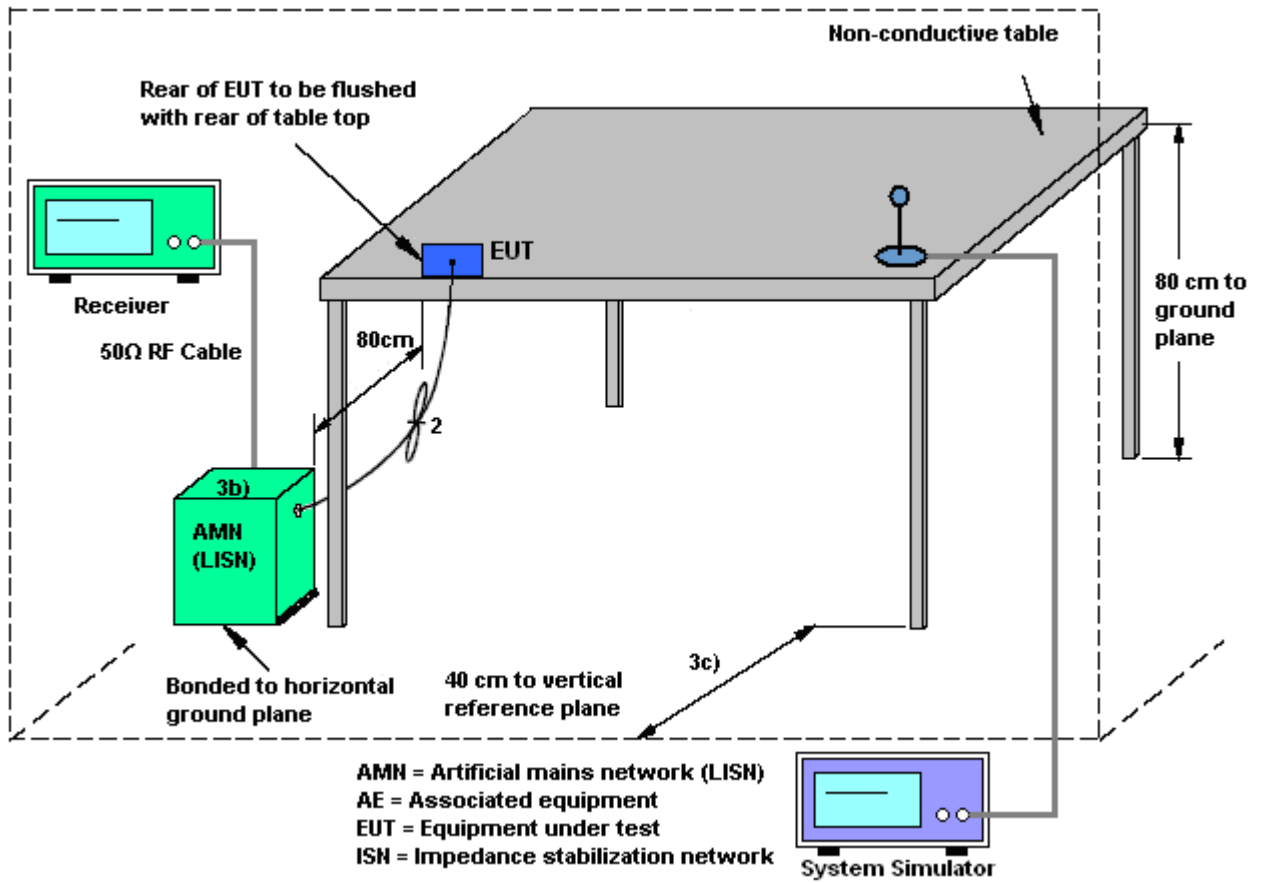



3.8.5 Test Result of AC Conducted Emission

Test Mode :	Mode 1	Temperature :	21~22°C
Test Engineer :	Alva Guo	Relative Humidity :	41~42%
Test Voltage :	120Vac / 60Hz	Phase :	Line
Function Type :	GSM 850 Idle + Bluetooth Link + WLAN Link + Adapter + Earphone + Camera		
Remark :	All emissions not reported here are more than 10 dB below the prescribed limit.		

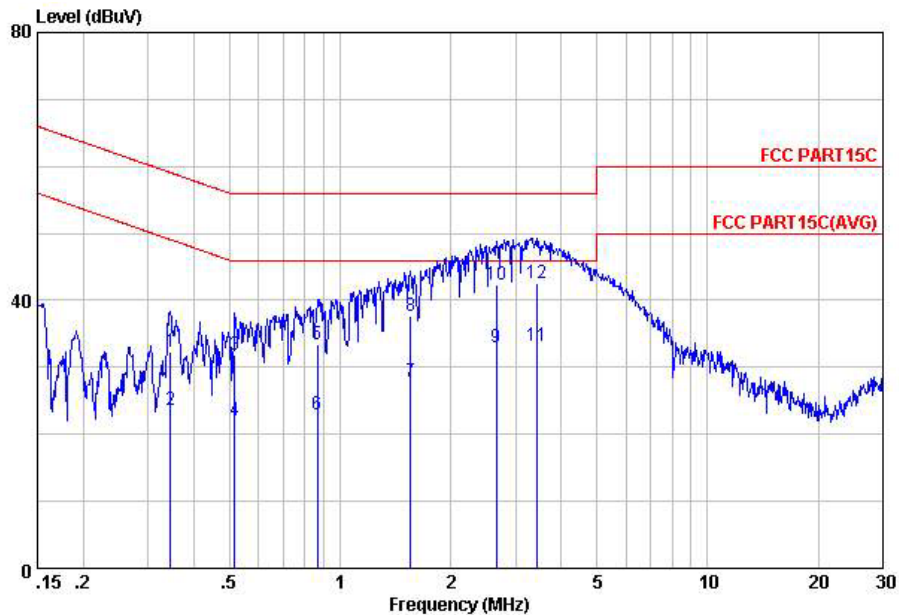

Site : C001-KS
 Condition: FCC PART15C LISN-100807 LINE
 Project : (FR) 1D1302
 mode : Mode 1

	Freq	Level	Over	Limit	Read	LISN	Cable	Remark
	MHz	dBuV	Limit	Line	Level	Factor	Loss	
			dB	dBuV	dBuV	dB	dB	
1	0.34	32.20	-26.89	59.09	22.10	-0.08	10.18	QP
2	0.34	23.70	-25.39	49.09	13.60	-0.08	10.18	Average
3	0.52	31.83	-24.17	56.00	21.70	-0.08	10.21	QP
4	0.52	22.03	-23.97	46.00	11.90	-0.08	10.21	Average
5	0.87	33.45	-22.55	56.00	23.30	-0.10	10.25	QP
6	0.87	23.05	-22.95	46.00	12.90	-0.10	10.25	Average
7	1.55	27.90	-18.10	46.00	17.71	-0.11	10.30	Average
8	1.55	37.60	-18.40	56.00	27.41	-0.11	10.30	QP
9	2.66	33.04	-12.96	46.00	22.79	-0.11	10.36	Average
10	2.66	42.34	-13.66	56.00	32.09	-0.11	10.36	QP
11	3.42	33.26	-12.74	46.00	23.00	-0.12	10.38	Average
12	3.42	42.46	-13.54	56.00	32.20	-0.12	10.38	QP



Test Mode :	Mode 1	Temperature :	21~22°C
Test Engineer :	Alva Guo	Relative Humidity :	41~42%
Test Voltage :	120Vac / 60Hz	Phase :	Neutral
Function Type :	GSM 850 Idle + Bluetooth Link + WLAN Link + Adapter + Earphone + Camera		
Remark :	All emissions not reported here are more than 10 dB below the prescribed limit.		

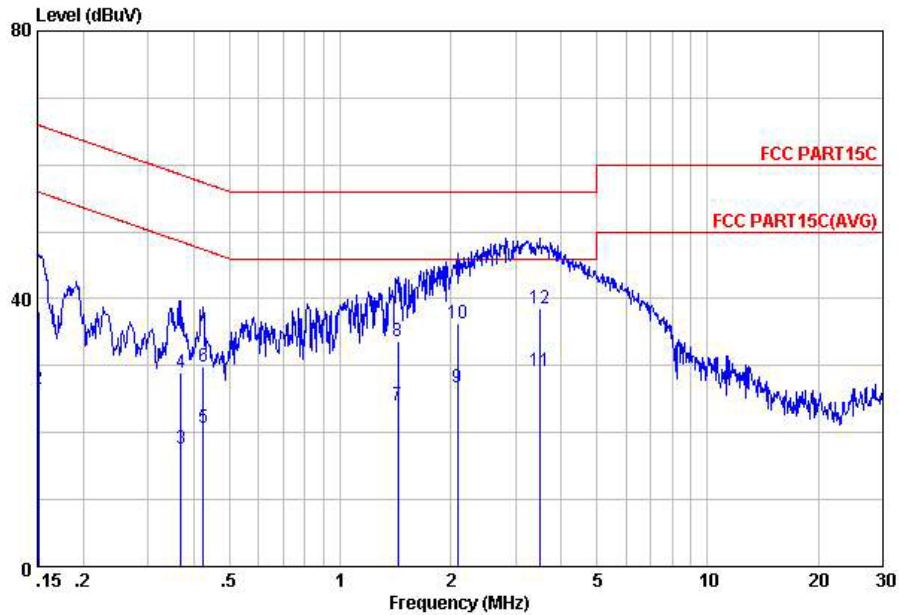

Site : C001-KS
 Condition: FCC PART15C LISN-100807 NEUTRAL
 Project : (FR) 1D1302
 mode : Mode 1

	Freq	Level	Over	Limit	Read	LISN	Cable	Remark
	MHz	dBuV	Limit	Line	Level	Factor	Loss	
			dB	dBuV	dBuV	dB	dB	
1	0.15	38.15	-27.81	65.96	28.10	-0.09	10.14	QP
2	0.15	26.45	-29.51	55.96	16.40	-0.09	10.14	Average
3	0.37	17.61	-30.91	48.52	7.51	-0.08	10.18	Average
4	0.37	29.01	-29.51	58.52	18.91	-0.08	10.18	QP
5	0.42	20.72	-26.65	47.37	10.60	-0.08	10.20	Average
6	0.42	29.82	-27.55	57.37	19.70	-0.08	10.20	QP
7	1.43	24.00	-22.00	46.00	13.80	-0.10	10.30	Average
8	1.43	33.60	-22.40	56.00	23.40	-0.10	10.30	QP
9	2.09	26.82	-19.18	46.00	16.60	-0.11	10.33	Average
10	2.09	36.22	-19.78	56.00	26.00	-0.11	10.33	QP
11	3.51	29.26	-16.74	46.00	19.00	-0.12	10.38	Average
12	3.51	38.56	-17.44	56.00	28.30	-0.12	10.38	QP

3.9 Radiated Emission Measurement

3.9.1 Limit of Radiated Emission

In any 100 kHz bandwidth outside the intentional radiator frequency band, all harmonics/spurious must be at least 20 dB below the highest emission level within the authorized band. In addition, radiated emissions which fall in the restricted bands must also comply with the FCC section 15.209 limits as below.

Frequency (MHz)	Field Strength (microvolts/meter)	Measurement Distance (meters)
0.009 – 0.490	2400/F(kHz)	300
0.490 – 1.705	24000/F(kHz)	30
1.705 – 30.0	30	30
30 – 88	100	3
88 – 216	150	3
216 - 960	200	3
Above 960	500	3

3.9.2 Measuring Instruments

See list of measuring instruments of this test report.

3.9.3 Test Procedures

1. The testing follows the guidelines in FCC Public Notice DA 00-705 Measurement Guidelines.
2. Use the following spectrum analyzer settings:
 - (1) Span = wide enough to fully capture the emission being measured; RBW = 1 MHz for $f \geq 1$ GHz, 100 kHz for $f < 1$ GHz; VBW \geq RBW; Sweep = auto; Detector function = peak; Trace = max hold.
 - (2) Above 18 GHz shall be extrapolated to the specified distance using an extrapolation factor of 20 dB/decade from 3m to 1m.
 Distance extrapolation factor = $20 \log(\text{specific distance [3m]} / \text{test distance [1m]})$ (dB)
3. Follow the guidelines in ANSI C63.4-2003 with respect to maximizing the emission by rotating the EUT, measuring the emission for three EUT orthogonal planes, and adjusting the measurement antenna height and polarization. A pre-amp and a high pass filter are used for this test in order to get the good signal level.
4. Measured average value for the peak value is greater than 54 dBuV/m

3.9.4 Test Setup

For radiated emissions below 30MHz

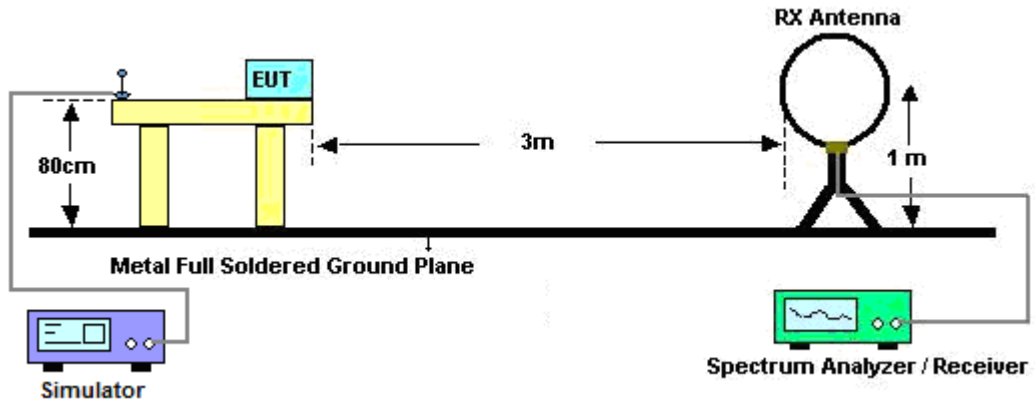

For radiated emissions from 30MHz to 1GHz

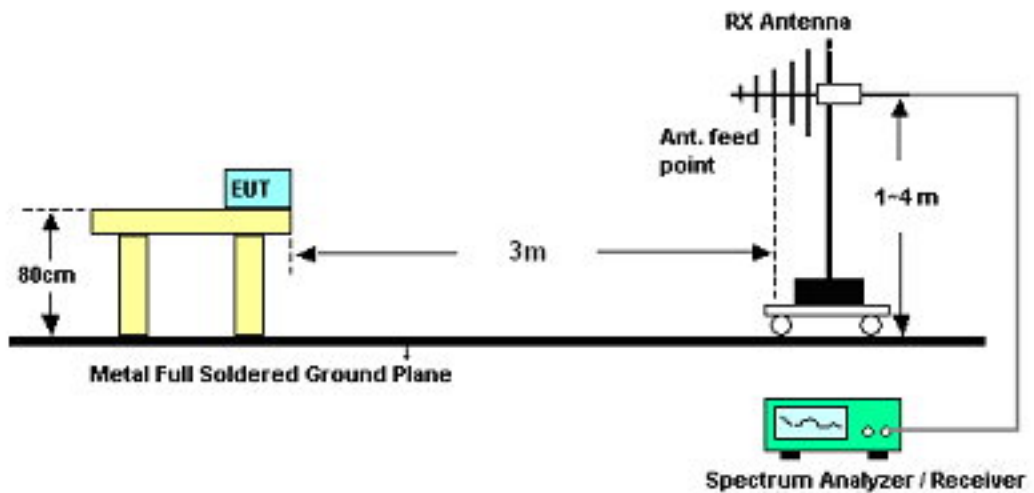

For radiated emissions above 1GHz

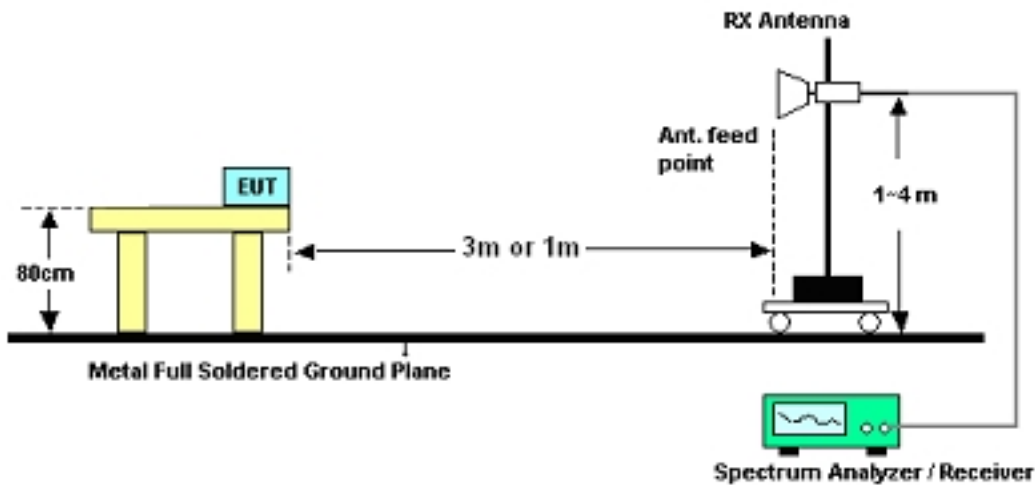

3.9.5 Test Results of Radiated Emissions (9 kHz ~ 30 MHz)

Test Engineer :	Cloud Peng	Temperature :	20~21°C	
		Relative Humidity :	41~42%	
Frequency (MHz)	Level (dBuV)	Over Limit (dB)	Limit Line (dBuV)	Remark
-	-	-	-	See Note

Note:

The amplitude of spurious emissions that are attenuated by more than 20dB below the permissible value has no need to be reported.

Distance extrapolation factor = 40 log (specific distance / test distance) (dB);

Limit line = specific limits (dBuV) + distance extrapolation factor.



3.9.6 Test Result of Radiated Emission (30 MHz ~ 10th Harmonic)

Test Mode :	Mode 1	Temperature :	20~21°C
Test Channel :	00	Relative Humidity :	41~42%
Test Engineer :	Cloud Peng	Polarization :	Horizontal
Remark :	2402 MHz is Fundamental Signals which can be ignored.		

Frequency (MHz)	Level (dBuV/m)	Over Limit (dB)	Limit Line (dBuV/m)	Read Level (dBuV)	Antenna Factor (dB)	Cable Loss (dB)	Preamp Factor (dB)	Ant Pos (cm)	Table Pos (deg)	Remark
66.99	23.22	-16.78	40	47.74	5.25	0.33	30.1	-	-	Peak
102.9	35.84	-7.66	43.5	54.51	10.87	0.42	29.96	100	0	Peak
138.81	21.46	-22.04	43.5	40	10.97	0.49	30	-	-	Peak
545.7	21.65	-24.35	46	31.9	18.43	1	29.68	-	-	Peak
836.9	22.32	-23.68	46	30.33	20.37	1.27	29.65	-	-	Peak
951	30.04	-23.96	54	37.52	20.73	1.33	29.54	-	-	Peak
2316.08	45.2	-28.8	74	43.11	32.73	3.22	33.86	100	360	Peak
2316.08	32.38	-21.62	54	30.29	32.73	3.22	33.86	100	360	Average
2402	96.24	-	-	93.96	32.86	3.47	34.05	101	292	Peak
2402	77.61	-	-	75.33	32.86	3.47	34.05	101	292	Average
2483.66	45.06	-28.94	74	42.57	33.01	3.68	34.2	105	299	Peak
2483.66	32.8	-21.2	54	30.31	33.01	3.68	34.2	105	299	Average
4804	52.1	-21.9	74	44.23	35.17	4.97	32.27	124	303	Peak
4804	43.22	-10.78	54	35.35	35.17	4.97	32.27	124	303	Average



Test Mode :	Mode 1	Temperature :	20~21°C
Test Channel :	00	Relative Humidity :	41~42%
Test Engineer :	Cloud Peng	Polarization :	Vertical
Remark :	2402 MHz is Fundamental Signals which can be ignored.		

Frequency (MHz)	Level (dBuV/m)	Over Limit (dB)	Limit Line (dBuV/m)	Read Level (dBuV)	Antenna Factor (dB)	Cable Loss (dB)	Preamp Factor (dB)	Ant Pos (cm)	Table Pos (deg)	Remark
37.29	32.06	-7.94	40	48.18	13.7	0.24	30.06	122	164	Peak
60.24	31.23	-8.77	40	55.76	5.3	0.31	30.14	-	-	Peak
101.55	31.42	-12.08	43.5	50.23	10.74	0.41	29.96	-	-	Peak
541.5	22.36	-23.64	46	32.73	18.33	0.99	29.69	-	-	Peak
791.4	22.29	-23.71	46	30.77	19.86	1.24	29.58	-	-	Peak
936.3	31.25	-14.75	46	38.79	20.67	1.32	29.53	-	-	Peak
2357.69	45.5	-28.5	74	43.29	32.81	3.38	33.98	122	0	Peak
2357.69	32.66	-21.34	54	30.45	32.81	3.38	33.98	122	0	Average
2402	90.87	-	-	88.59	32.86	3.47	34.05	126	8	Peak
2402	77.16	-	-	74.88	32.86	3.47	34.05	126	8	Average
2488.41	46.62	-27.38	74	44.08	33.05	3.72	34.23	134	213	Peak
2488.41	33.91	-20.09	54	31.37	33.05	3.72	34.23	134	213	Average
4804	52.02	-21.98	74	44.15	35.17	4.97	32.27	114	28	Peak
4804	43.76	-10.24	54	35.89	35.17	4.97	32.27	114	28	Average



Test Mode :	Mode 2	Temperature :	20~21°C
Test Channel :	39	Relative Humidity :	41~42%
Test Engineer :	Cloud Peng	Polarization :	Horizontal
Remark :	2441 MHz is Fundamental Signals which can be ignored.		

Frequency (MHz)	Level (dBuV/m)	Over Limit (dB)	Limit Line (dBuV/m)	Read Level (dBuV)	Antenna Factor (dB)	Cable Loss (dB)	Preamp Factor (dB)	Ant Pos (cm)	Table Pos (deg)	Remark
67.26	22.66	-17.34	40	47.18	5.25	0.33	30.1	-	-	Peak
102.63	36.39	-7.11	43.5	55.06	10.87	0.42	29.96	103	345	Peak
208.2	23.13	-20.37	43.5	43.14	9.39	0.6	30	-	-	Peak
571.6	23.93	-22.07	46	34.02	18.54	1.03	29.66	-	-	Peak
844.6	24.69	-21.31	46	32.6	20.46	1.28	29.65	-	-	Peak
936.3	30.61	-15.39	46	38.15	20.67	1.32	29.53	-	-	Peak
2325.96	45.07	-28.93	74	42.94	32.76	3.27	33.9	197	100	Peak
2325.96	32.15	-21.85	54	30.02	32.76	3.27	33.9	197	100	Average
2441	80.63	-	-	78.23	32.95	3.6	34.15	200	16	Average
2441	95.72	-	-	93.32	32.95	3.6	34.15	200	16	Peak
2486.51	45.18	-28.82	74	42.69	33.01	3.68	34.2	179	342	Peak
2486.51	33.06	-20.94	54	30.57	33.01	3.68	34.2	179	342	Average
4882	51.95	-22.05	74	44.06	35.18	4.98	32.27	100	31	Peak
4882	42.83	-11.17	54	34.94	35.18	4.98	32.27	100	31	Average



Test Mode :	Mode 2	Temperature :	20~21°C
Test Channel :	39	Relative Humidity :	41~42%
Test Engineer :	Cloud Peng	Polarization :	Vertical
Remark :	2441 MHz is Fundamental Signals which can be ignored.		

Frequency (MHz)	Level (dBuV/m)	Over Limit (dB)	Limit Line (dBuV/m)	Read Level (dBuV)	Antenna Factor (dB)	Cable Loss (dB)	Preamp Factor (dB)	Ant Pos (cm)	Table Pos (deg)	Remark
37.29	32.9	-7.1	40	49.02	13.7	0.24	30.06	200	10	Peak
60.78	31.5	-8.5	40	56.04	5.28	0.31	30.13	-	-	Peak
102.09	31.73	-11.77	43.5	50.54	10.74	0.41	29.96	-	-	Peak
546.4	21.11	-24.89	46	31.36	18.43	1	29.68	-	-	Peak
878.2	23.29	-22.71	46	31.08	20.47	1.29	29.55	-	-	Peak
939.8	30.45	-15.55	46	37.96	20.69	1.33	29.53	-	-	Peak
2382.58	46.01	-27.99	74	43.77	32.83	3.42	34.01	110	360	Peak
2382.58	32.53	-21.47	54	30.29	32.83	3.42	34.01	110	360	Average
2441	76.3	-	-	73.9	32.95	3.6	34.15	101	264	Average
2441	90.03	-	-	87.63	32.95	3.6	34.15	101	264	Peak
2485.18	44.78	-29.22	74	42.29	33.01	3.68	34.2	103	267	Peak
2485.18	32.62	-21.38	54	30.13	33.01	3.68	34.2	103	267	Average
4882	51.25	-22.75	74	43.36	35.18	4.98	32.27	137	312	Peak
4882	43.09	-10.91	54	35.2	35.18	4.98	32.27	137	312	Average



Test Mode :	Mode 3	Temperature :	20~21°C
Test Channel :	78	Relative Humidity :	41~42%
Test Engineer :	Cloud Peng	Polarization :	Horizontal
Remark :	2480 MHz is Fundamental Signals which can be ignored.		

Frequency (MHz)	Level (dBuV/m)	Over Limit (dB)	Limit Line (dBuV/m)	Read Level (dBuV)	Antenna Factor (dB)	Cable Loss (dB)	Preamp Factor (dB)	Ant Pos (cm)	Table Pos (deg)	Remark
102.36	36.6	-6.9	43.5	55.27	10.87	0.42	29.96	111	344	Peak
134.49	22.07	-21.43	43.5	40.28	11.3	0.48	29.99	-	-	Peak
207.93	18.22	-25.28	43.5	38.28	9.34	0.6	30	-	-	Peak
543.6	21.93	-24.07	46	32.24	18.37	1	29.68	-	-	Peak
758.5	22.07	-23.93	46	30.54	19.89	1.19	29.55	-	-	Peak
936.3	29.51	-16.49	46	37.05	20.67	1.32	29.53	-	-	Peak
2310	44.89	-29.11	74	42.8	32.73	3.22	33.86	103	264	Peak
2310	32.1	-21.9	54	30.01	32.73	3.22	33.86	103	264	Average
2480	93.15	-	-	90.66	33.01	3.68	34.2	192	359	Peak
2480	78.68	-	-	76.19	33.01	3.68	34.2	192	359	Average
2484.52	39.71	-34.29	74	37.22	33.01	3.68	34.2	200	350	Peak
2484.52	25.94	-28.06	54	23.45	33.01	3.68	34.2	200	350	Average
4960	50.39	-23.61	74	42.45	35.2	5	32.26	119	298	Peak
4960	39.53	-14.47	54	31.59	35.2	5	32.26	119	298	Average



Test Mode :	Mode 3	Temperature :	20~21°C
Test Channel :	78	Relative Humidity :	41~42%
Test Engineer :	Cloud Peng	Polarization :	Vertical
Remark :	2480 MHz is Fundamental Signals which can be ignored.		

Frequency (MHz)	Level (dBuV/m)	Over Limit (dB)	Limit Line (dBuV/m)	Read Level (dBuV)	Antenna Factor (dB)	Cable Loss (dB)	Preamp Factor (dB)	Ant Pos (cm)	Table Pos (deg)	Remark
37.02	32.23	-7.77	40	47.87	14.19	0.24	30.07	100	360	Peak
60.51	31.24	-8.76	40	55.77	5.3	0.31	30.14	-	-	Peak
102.36	31.73	-11.77	43.5	50.4	10.87	0.42	29.96	-	-	Peak
751.5	22.01	-23.99	46	30.47	19.9	1.18	29.54	-	-	Peak
842.5	23.27	-22.73	46	31.2	20.44	1.28	29.65	-	-	Peak
939.8	31.7	-14.3	46	39.21	20.69	1.33	29.53	-	-	Peak
2378	44.69	-29.31	74	42.45	32.83	3.42	34.01	100	120	Peak
2378	32.24	-21.76	54	30	32.83	3.42	34.01	100	120	Average
2480	90.07	-	-	87.58	33.01	3.68	34.2	101	125	Peak
2480	76.88	-	-	74.39	33.01	3.68	34.2	101	125	Average
2483.92	39.42	-34.58	74	36.93	33.01	3.68	34.2	120	0	Peak
2483.92	27.56	-26.44	54	25.07	33.01	3.68	34.2	120	0	Average



3.10 Antenna Requirements

3.10.1 Standard Applicable

If directional gain of transmitting antennas is greater than 6dBi, the power shall be reduced by the same level in dB comparing to gain minus 6dBi. The use of a permanently attached antenna or of an antenna that uses a unique coupling to the intentional radiator shall be considered sufficient to comply with the FCC rule.

3.10.2 Antenna Connected Construction

The antennas type used in this product is Dipole Antenna without connector and it is considered to meet antenna requirement.

3.10.3 Antenna Gain

The antenna peak gain of EUT is less than 6 dBi. Therefore, it is not necessary to reduce maximum peak output power limit.



4 List of Measuring Equipment

Instrument	Manufacturer	Model No.	Serial No.	Characteristics	Calibration Date	Test Date	Due Date	Remark
Spectrum Analyzer	R&S	FSP40	100319	9kHz~40GHz	Dec. 30, 2011	Jan. 10, 2012	Dec. 29, 2012	Conducted (TH01-KS)
System Simulator	R&S	CMU200	837587/066	2G Full-Band	Dec. 30, 2011	Jan. 10, 2012	Dec. 29, 2012	Conducted (TH01-KS)
DC Power Supply	TOPWARD	GPS-3030D	E1884515	N/A	Aug. 23, 2011	Jan. 10, 2012	Aug. 22, 2012	Conducted (TH01-KS)
Thermal Chamber	Ten Billion	TTC-B3S	TBN-960502	N/A	Dec. 30, 2011	Jan. 10, 2012	Dec. 29, 2012	Conducted (TH01-KS)
EMI Receiver	R&S	ESCI7	100768	9kHz~7GHz	Jun. 02, 2011	Jan. 09, 2012	Jun. 01, 2012	Conduction (CO01-KS)
LISN	MessTec	AN3016	60103	9kHz~30MHz	Dec. 30, 2011	Jan. 09, 2012	Dec. 29, 2012	Conduction (CO01-KS)
LISN	MessTec	AN3016	60105	9kHz~30MHz	Dec. 30, 2011	Jan. 09, 2012	Dec. 29, 2012	Conduction (CO01-KS)
AC Power Source	Chroma	61602	ABP000000811	N/A	Nov. 16, 2011	Jan. 09, 2012	Nov. 15, 2012	Conduction (CO01-KS)
System Simulator	R&S	CMU200	837587/066	Full-Band	Dec. 30, 2011	Jan. 09, 2012	Dec. 29, 2012	Conduction (CO01-KS)
EMI Test Receiver	R&S	ESCI	100534	9kHz~3GHz	Nov. 09, 2011	Jan. 10, 2012	Nov. 08, 2012	Radiation (03CH01-KS)
Spectrum Analyzer	R&S	FSP40	100319	9kHz~40GHz	Dec. 30, 2011	Jan. 10, 2012	Dec. 29, 2012	Radiation (03CH01-KS)
Bilog Antenna	SCHAFFNER	CBL6112D	23182	25MHz~2GHz	Dec. 08, 2011	Jan. 10, 2012	Dec. 07, 2012	Radiation (03CH01-KS)
Loop Antenna	R&S	HFH2-Z2	860004/00	9 kHz~30 MHz	Jul. 28, 2011	Jan. 10, 2012	Jul. 27, 2012	Radiation (03CH01-KS)
Double Ridge Horn Antenna	EMCO	3117	00075959	1GHz~18GHz	Jan. 06, 2012	Jan. 10, 2012	Jan. 05, 2013	Radiation (03CH01-KS)
Amplifier	Wireless	FPA-6592G	060004	30MHz~2GHz	Dec. 30, 2011	Jan. 10, 2012	Dec. 29, 2012	Radiation (03CH01-KS)
Amplifier	Agilent	8449B	3008A02370	1GHz~26.5GHz	Dec. 30, 2011	Jan. 10, 2012	Dec. 29, 2012	Radiation (03CH01-KS)
Active Horn Antenna	com-power	AHA-118	701023	1GHz~18GHz	Nov. 07, 2011	Jan. 10, 2012	Nov. 06, 2012	Radiation (03CH01-KS)
SHF-EHF Horn	Schwarzbeck	BBHA 9170	BBHA170249	15GHz~40GHz	Oct. 11, 2011	Jan. 10, 2012	Oct.10, 2012	Radiation (03CH01-KS)
Bluetooth Base Station	R&S	CBT	100783	N/A	Aug. 18, 2011	Jan. 10, 2012	Aug. 17, 2012	Radiation (03CH01-KS)

5 Uncertainty of Evaluation

Uncertainty of Conducted Emission Measurement (150 kHz ~ 30 MHz)

Contribution	Uncertainty of X_i		$u(X_i)$
	dB	Probability Distribution	
Receiver Reading	0.10	Normal (k=2)	0.05
Cable Loss	0.10	Normal (k=2)	0.05
AMN Insertion Loss	2.50	Rectangular	0.63
Receiver Specification	1.50	Rectangular	0.43
Site Imperfection	1.39	Rectangular	0.80
Mismatch	+0.34 / -0.35	U-Shape	0.24
Combined Standard Uncertainty $U_c(y)$	1.13		
Measuring Uncertainty for a Level of Confidence of 95% ($U = 2U_c(y)$)	2.26		

Uncertainty of Radiated Emission Measurement (30 MHz ~ 1000 MHz)

Contribution	Uncertainty of X_i		$u(X_i)$
	dB	Probability Distribution	
Receiver Reading	0.41	Normal (k=2)	0.21
Antenna Factor Calibration	0.83	Normal (k=2)	0.42
Cable Loss Calibration	0.25	Normal (k=2)	0.13
Pre-Amplifier Gain Calibration	0.27	Normal (k=2)	0.14
RCV/SPA Specification	2.50	Rectangular	0.72
Antenna Factor Interpolation for Frequency	1.00	Rectangular	0.29
Site Imperfection	1.43	Rectangular	0.83
Mismatch	+0.39 / -0.41	U-Shape	0.28
Combined Standard Uncertainty $U_c(y)$	1.27		
Measuring Uncertainty for a Level of Confidence of 95% ($U = 2U_c(y)$)	2.54		



Uncertainty of Radiated Emission Measurement (1 GHz ~ 40 GHz)

Contribution	Uncertainty of X_i		$u(X_i)$	C_i	$C_i * u(X_i)$
	dB	Probability Distribution			
Receiver Reading	±0.10	Normal (k=2)	0.10	1	0.10
Antenna Factor Calibration	±1.70	Normal (k=2)	0.85	1	0.85
Cable Loss Calibration	±0.50	Normal (k=2)	0.25	1	0.25
Receiver Correction	±2.00	Rectangular	1.15	1	1.15
Antenna Factor Directional	±1.50	Rectangular	0.87	1	0.87
Site Imperfection	±2.80	Triangular	1.14	1	1.14
Mismatch Receiver VSWR $\Gamma_1 = 0.197$ Antenna VSWR $\Gamma_2 = 0.194$ Uncertainty = $20\text{Log}(1-\Gamma_1*\Gamma_2)$	+0.34 / -0.35	U-Shape	0.244	1	0.244
Combined Standard Uncertainty $U_c(y)$	2.36				
Measuring Uncertainty for a Level of Confidence of 95% ($U = 2U_c(y)$)	4.72				



Appendix A. Photographs of EUT

Please refer to Sporton report number EP1D1302 as below.