

## FCC Test Report

**Report No.:** RF151102C18

**FCC ID:** YHI-NW121

**Test Model:** NW-121

**Received Date:** Nov. 02, 2015

**Test Date:** Nov. 21, 2015 ~ Dec. 15, 2015

**Issued Date:** Dec. 22, 2015

**Applicant:** NEXCOM International Co., Ltd.

**Address:** 9F, No. 920, Chung-Cheng Rd., Zhonghe Dist., New Taipei City 235, Taiwan

**Issued By:** Bureau Veritas Consumer Products Services (H.K.) Ltd., Taoyuan Branch

**Lab Address:** No. 47-2, 14th Ling, Chia Pau Vil., Lin Kou Dist., New Taipei City, Taiwan  
( R.O.C )

**Test Location :** No.215, Sec. 3, Beixin Rd., Xindian Dist., New Taipei City 231, Taiwan,  
R.O.C



This report is for your exclusive use. Any copying or replication of this report to or for any other person or entity, or use of our name or trademark, is permitted only with our prior written permission. This report sets forth our findings solely with respect to the test samples identified herein. The results set forth in this report are not indicative or representative of the quality or characteristics of the lot from which a test sample was taken or any similar or identical product unless specifically and expressly noted. Our report includes all of the tests requested by you and the results thereof based upon the information that you provided to us. You have 60 days from date of issuance of this report to notify us of any material error or omission caused by our negligence, provided, however, that such notice shall be in writing and shall specifically address the issue you wish to raise. A failure to raise such issue within the prescribed time shall constitute your unqualified acceptance of the completeness of this report, the tests conducted and the correctness of the report contents. Unless specifically mentioned, the uncertainty of measurement has been explicitly taken into account to declare the compliance or non-compliance to the specification.

## Table of Contents

<b>Release Control Record</b> .....	<b>4</b>
<b>1 Certificate of Conformity</b> .....	<b>5</b>
<b>2 Summary of Test Results</b> .....	<b>6</b>
2.1 Measurement Uncertainty.....	6
2.2 Modification Record .....	6
<b>3 General Information</b> .....	<b>7</b>
3.1 General Description of EUT .....	7
3.2 Description of Test Modes.....	8
3.2.1 Test Mode Applicability and Tested Channel Detail.....	9
3.3 Duty Cycle of Test Signal .....	11
3.4 Description of Support Units .....	13
3.4.1 Configuration of System under Test .....	13
3.5 General Description of Applied Standards.....	13
<b>4 Test Types and Results</b> .....	<b>14</b>
4.1 Radiated Emission and Bandedge Measurement .....	14
4.1.1 Limits of Radiated Emission and Bandedge Measurement .....	14
4.1.2 Test Instruments .....	15
4.1.3 Test Procedures.....	16
4.1.4 Deviation from Test Standard .....	16
4.1.5 Test Set Up .....	17
4.1.6 EUT Operating Conditions.....	17
4.1.7 Test Results .....	18
4.2 Conducted Emission Measurement.....	44
4.2.1 Limits of Conducted Emission Measurement .....	44
4.2.2 Test Instruments .....	44
4.2.3 Test Procedures.....	45
4.2.4 Deviation from Test Standard .....	45
4.2.5 Test Setup.....	45
4.2.6 EUT Operating Conditions.....	45
4.2.7 Test Results .....	46
4.3 6 dB Bandwidth Measurement.....	50
4.3.1 Limits of 6 dB Bandwidth Measurement.....	50
4.3.2 Test Setup.....	50
4.3.3 Test Instruments .....	50
4.3.4 Test Procedure .....	50
4.3.5 Deviation from Test Standard .....	50
4.3.6 EUT Operating Conditions.....	50
4.3.7 Test Result .....	51
4.4 Conducted Output Power Measurement .....	55
4.4.1 Limits of Conducted Output Power Measurement.....	55
4.4.2 Test Setup.....	55
4.4.3 Test Instruments .....	55
4.4.4 Test Procedures.....	55
4.4.5 Deviation from Test Standard .....	55
4.4.6 EUT Operating Conditions.....	55
4.4.7 Test Results .....	56
4.5 Power Spectral Density Measurement .....	58
4.5.1 Limits of Power Spectral Density Measurement.....	58
4.5.2 Test Setup.....	58
4.5.3 Test Instruments .....	58
4.5.4 Test Procedure .....	58
4.5.5 Deviation from Test Standard .....	58
4.5.6 EUT Operating Condition .....	58



4.5.7 Test Results .....	59
4.6 Conducted Out of Band Emission Measurement .....	65
4.6.1 Limits of Conducted Out of Band Emission Measurement.....	65
4.6.2 Test Setup.....	65
4.6.3 Test Instruments .....	65
4.6.4 Test Procedure .....	65
4.6.5 Deviation from Test Standard .....	65
4.6.6 EUT Operating Condition .....	65
4.6.7 Test Results .....	66
<b>5 Pictures of Test Arrangements.....</b>	<b>114</b>
<b>Appendix – Information on the Testing Laboratories .....</b>	<b>115</b>



A D T

### Release Control Record

Issue No.	Description	Date Issued
RF151102C18	Original Release	Dec. 22, 2015

## 1 Certificate of Conformity

**Product:** 3x3 11ac/n/g/b/a 2.4/5GHz WiFi Module

**Brand:** NEXCOM

**Test Model:** NW-121

**Sample Status:** Identical Prototype

**Applicant:** NEXCOM International Co., Ltd.

**Test Date:** Nov. 21, 2015 ~ Dec. 15, 2015

**Standards:** 47 CFR FCC Part 15, Subpart C (Section 15.247)  
ANSI C63.10:2013

The above equipment has been tested by **Bureau Veritas Consumer Products Services (H.K.) Ltd., Taoyuan Branch**, and found compliance with the requirement of the above standards. The test record, data evaluation & Equipment Under Test (EUT) configurations represented herein are true and accurate accounts of the measurements of the sample's EMC characteristics under the conditions specified in this report.

**Prepared by :** Rona Chen , **Date:** Dec. 22, 2015  
Rona Chen / Specialist

**Approved by :** Stanley Wu , **Date:** Dec. 22, 2015  
Stanley Wu / Assistant Manager

## 2 Summary of Test Results

47 CFR FCC Part 15, Subpart C (Section 15.247)			
FCC Clause	Test Item	Result	Remarks
15.207	AC Power Conducted Emission	Pass	Meet the requirement of limit. Minimum passing margin is -12.13 dB at 0.18519 MHz.
15.205 / 15.209 / 15.247(d)	Radiated Emissions and Band Edge Measurement	Pass	Meet the requirement of limit. Minimum passing margin is -1.00 dB at 2486 MHz.
15.247(d)	Antenna Port Emission	Pass	Meet the requirement of limit.
15.247(a)(2)	6 dB Bandwidth	Pass	Meet the requirement of limit.
15.247(b)	Conducted power	Pass	Meet the requirement of limit.
15.247(e)	Power Spectral Density	Pass	Meet the requirement of limit.
15.203	Antenna Requirement	Pass	No antenna connector is used.

### 2.1 Measurement Uncertainty

Where relevant, the following measurement uncertainty levels have been estimated for tests performed on the EUT:

The listed uncertainties are the worst case uncertainty for the entire range of measurement. Please note that the uncertainty values are provided for informational purposes only and are not used in determining the PASS/FAIL results.

Measurement	Frequency	Expanded Uncertainty (k=2) (±)
Conducted Emissions at mains ports	150 kHz ~ 30 MHz	2.44 dB
Radiated Emissions up to 1 GHz	30 MHz ~ 200 MHz	2.0153 dB
	200 MHz ~ 1000 MHz	2.0224 dB
Radiated Emissions above 1 GHz	1 GHz ~ 18 GHz	1.0121 dB
	18 GHz ~ 40 GHz	1.1508 dB

### 2.2 Modification Record

There were no modifications required for compliance.

### 3 General Information

#### 3.1 General Description of EUT

<b>Product</b>	3x3 11ac/n/g/b/a 2.4/5GHz WiFi Module
<b>Brand</b>	NEXCOM
<b>Test Model</b>	NW-121
<b>Status of EUT</b>	Identical Prototype
<b>Power Supply Rating</b>	3.3 Vdc (Host equipment)
<b>Modulation Type</b>	CCK, DQPSK, DBPSK for DSSS 64QAM, 16QAM, QPSK, BPSK for OFDM
<b>Modulation Technology</b>	DSSS, OFDM
<b>Transfer Rate</b>	802.11b: 11.0 / 5.5 / 2.0 / 1.0 Mbps 802.11g: 54.0 / 48.0 / 36.0 / 24.0 / 18.0 / 12.0 / 9.0 / 6.0 Mbps 802.11n: up to MCS23
<b>Operating Frequency</b>	2412 ~ 2462 MHz
<b>Number of Channel</b>	11 for 802.11b, 802.11g, 802.11n (HT20) 7 for 802.11n (HT40)
<b>Output Power</b>	332.387 mW
<b>Antenna Type</b>	PIFA antenna with 4.65 dBi gain Dipole antenna with 1.93 dBi gain
<b>Antenna Connector</b>	N/A
<b>Accessory Device</b>	N/A
<b>Data Cable Supplied</b>	N/A

Note:

1. The EUT incorporates a MIMO function. Physically, the EUT provides 3 completed transmitters and 3 receivers.

Modulation Mode	TX Function
802.11b	3TX
802.11g	3TX
802.11n (HT20)	3TX
802.11n (HT40)	3TX

2. The EUT contains following accessory devices.

Product	Brand	Model	Description
Antenna 1	ARISTOTLE	RFA-25-AP250-70-50	PIFA
Antenna 2	WIESON	GY121L049S-XXX	Dipole

3. The above EUT information is declared by manufacturer and for more detailed features description, please refer to the manufacturer's specifications or user's manual.

### 3.2 Description of Test Modes

11 channels are provided for 802.11b, 802.11g and 802.11n (HT20):

Channel	Frequency (MHz)	Channel	Frequency (MHz)
1	2412	7	2442
2	2417	8	2447
3	2422	9	2452
4	2427	10	2457
5	2432	11	2462
6	2437		

7 channels are provided for 802.11n (HT40):

Channel	Frequency (MHz)	Channel	Frequency (MHz)
3	2422	7	2442
4	2427	8	2447
5	2432	9	2452
6	2437		



### 3.2.1 Test Mode Applicability and Tested Channel Detail

EUT Configure Mode	Applicable To				Description
	RE $\geq$ 1G	RE<1G	PLC	APCM	
A	√	√	√	√	EUT with PIFA Antenna
B	√	√	√	√	EUT with Dipole Antenna

Where **RE $\geq$ 1G**: Radiated Emission above 1 GHz      **RE<1G**: Radiated Emission below 1 GHz  
**PLC**: Power Line Conducted Emission      **APCM**: Antenna Port Conducted Measurement

#### **Radiated Emission Test (Above 1 GHz):**

- Pre-Scan has been conducted to determine the worst-case mode from all possible combinations between available modulations, data rates and antenna ports (if EUT with antenna diversity architecture).
- Following channel(s) was (were) selected for the final test as listed below.

EUT Configure Mode	Mode	Available Channel	Tested Channel	Modulation Technology	Modulation Type	Data Rate (Mbps)
A, B	802.11b	1 to 11	1, 6, 11	DSSS	DBPSK	1.0
	802.11g	1 to 11	1, 6, 11	OFDM	BPSK	6.0
	802.11n (HT20)	1 to 11	1, 6, 11	OFDM	BPSK	MCS0
	802.11n (HT40)	3 to 9	3, 6, 9	OFDM	BPSK	MCS0

#### **Radiated Emission Test (Below 1 GHz):**

- Pre-Scan has been conducted to determine the worst-case mode from all possible combinations between available modulations, data rates and antenna ports (if EUT with antenna diversity architecture).
- Following channel(s) was (were) selected for the final test as listed below.

EUT Configure Mode	Mode	Available Channel	Tested Channel	Modulation Technology	Modulation Type	Data Rate (Mbps)
A	802.11n (HT40)	3 to 9	9	OFDM	BPSK	MCS0
B	802.11n (HT20)	1 to 11	11	OFDM	BPSK	MCS0

#### **Power Line Conducted Emission Test:**

- Pre-Scan has been conducted to determine the worst-case mode from all possible combinations between available modulations, data rates and antenna ports (if EUT with antenna diversity architecture).
- Following channel(s) was (were) selected for the final test as listed below.

EUT Configure Mode	Mode	Available Channel	Tested Channel	Modulation Technology	Modulation Type	Data Rate (Mbps)
A	802.11n (HT40)	3 to 9	9	OFDM	BPSK	MCS0
B	802.11n (HT20)	1 to 11	11	OFDM	BPSK	MCS0

**Bandedge Measurement:**

- Pre-Scan has been conducted to determine the worst-case mode from all possible combinations between available modulations, data rates and antenna ports (if EUT with antenna diversity architecture).
- Following channel(s) was (were) selected for the final test as listed below.

EUT Configure Mode	Mode	Available Channel	Tested Channel	Modulation Technology	Modulation Type	Data Rate (Mbps)
A, B	802.11b	1 to 11	1, 11	DSSS	DBPSK	1.0
	802.11g	1 to 11	1, 11	OFDM	BPSK	6.0
	802.11n (HT20)	1 to 11	1, 11	OFDM	BPSK	MCS0
	802.11n (HT40)	3 to 9	3, 9	OFDM	BPSK	MCS0

**Antenna Port Conducted Measurement:**

- This item includes all test value of each mode, but only includes spectrum plot of worst value of each mode.
- Pre-Scan has been conducted to determine the worst-case mode from all possible combinations between available modulations, data rates and antenna ports (if EUT with antenna diversity architecture).
- Following channel(s) was (were) selected for the final test as listed below.

EUT Configure Mode	Mode	Available Channel	Tested Channel	Modulation Technology	Modulation Type	Data Rate (Mbps)
A, B	802.11b	1 to 11	1, 6, 11	DSSS	DBPSK	1.0
	802.11g	1 to 11	1, 6, 11	OFDM	BPSK	6.0
	802.11n (HT20)	1 to 11	1, 6, 11	OFDM	BPSK	MCS0
	802.11n (HT40)	3 to 9	3, 6, 9	OFDM	BPSK	MCS0

**Test Condition:**

Applicable To	Environmental Conditions	Input Power	Tested by
RE≥1G	25 deg. C, 65 % RH	120 Vac, 60 Hz	Charles Hsiao
RE<1G	25 deg. C, 65 % RH	120 Vac, 60 Hz	Charles Hsiao
PLC	25 deg. C, 65 % RH	120 Vac, 60 Hz	Toby Tian
APCM	25 deg. C, 65 % RH	3.3 Vdc	Taylor Liu

### 3.3 Duty Cycle of Test Signal

#### Mode A

**802.11b:** Duty cycle of test signal is  $\leq 100\%$ , duty factor is not required.

**802.11g:** Duty cycle =  $2.026/2.114 = 0.958$ , Duty factor =  $10 * \log(1/0.958) = 0.18$

**802.11n (HT20):** Duty cycle =  $0.655/0.743 = 0.881$ , Duty factor =  $10 * \log(1/0.881) = 0.55$

**802.11n (HT40):** Duty cycle =  $0.313/0.434 = 0.723$ , Duty factor =  $10 * \log(1/0.723) = 1.41$

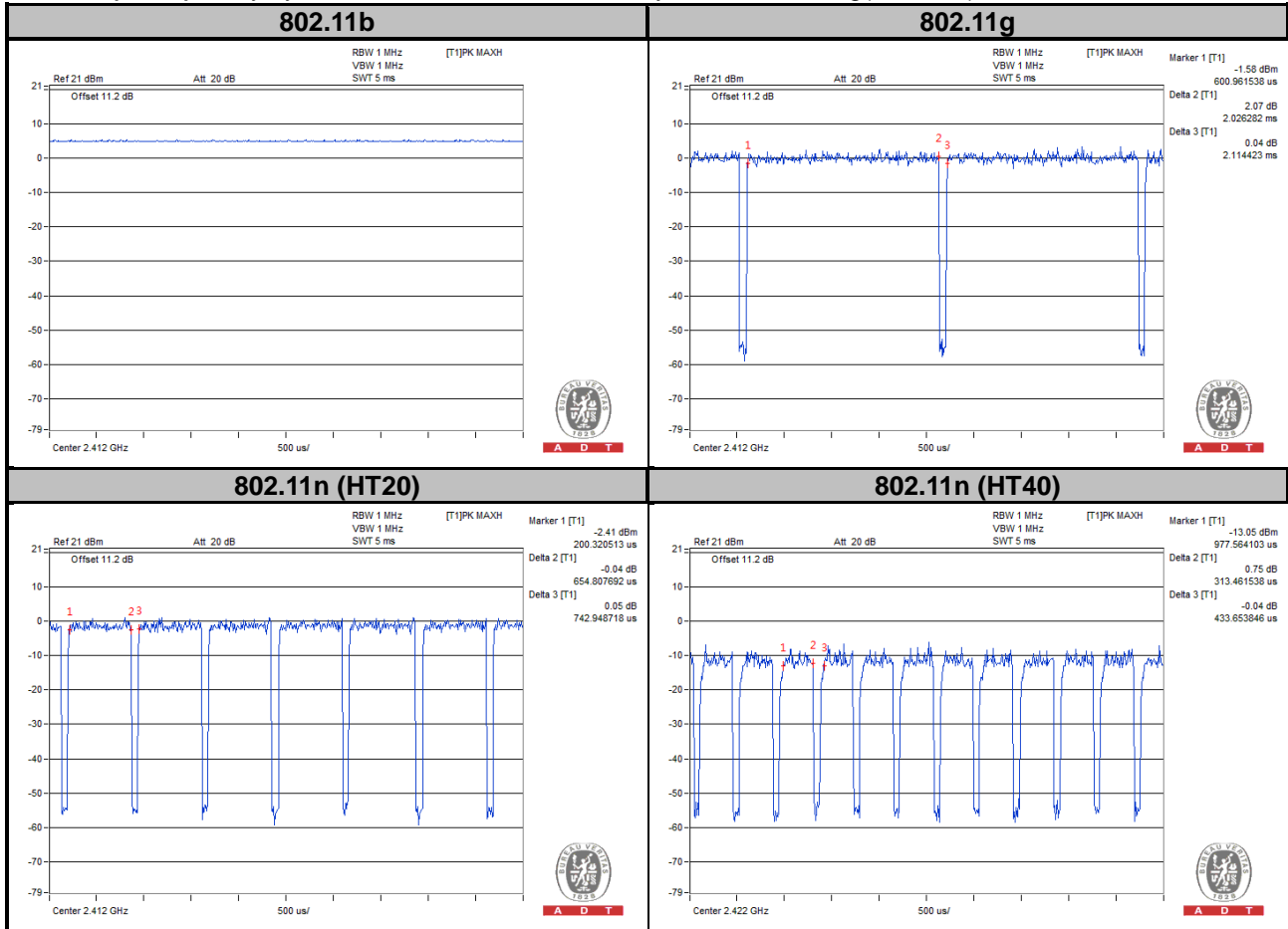

**Mode B**

**802.11b:** Duty cycle of test signal is  $\leq 100\%$ , duty factor is not required.

**802.11g:** Duty cycle =  $2.026/2.114 = 0.958$ , Duty factor =  $10 * \log(1/0.958) = 0.18$

**802.11n (HT20):** Duty cycle =  $0.655/0.743 = 0.881$ , Duty factor =  $10 * \log(1/0.881) = 0.55$

**802.11n (HT40):** Duty cycle =  $0.321/0.426 = 0.755$ , Duty factor =  $10 * \log(1/0.755) = 1.22$

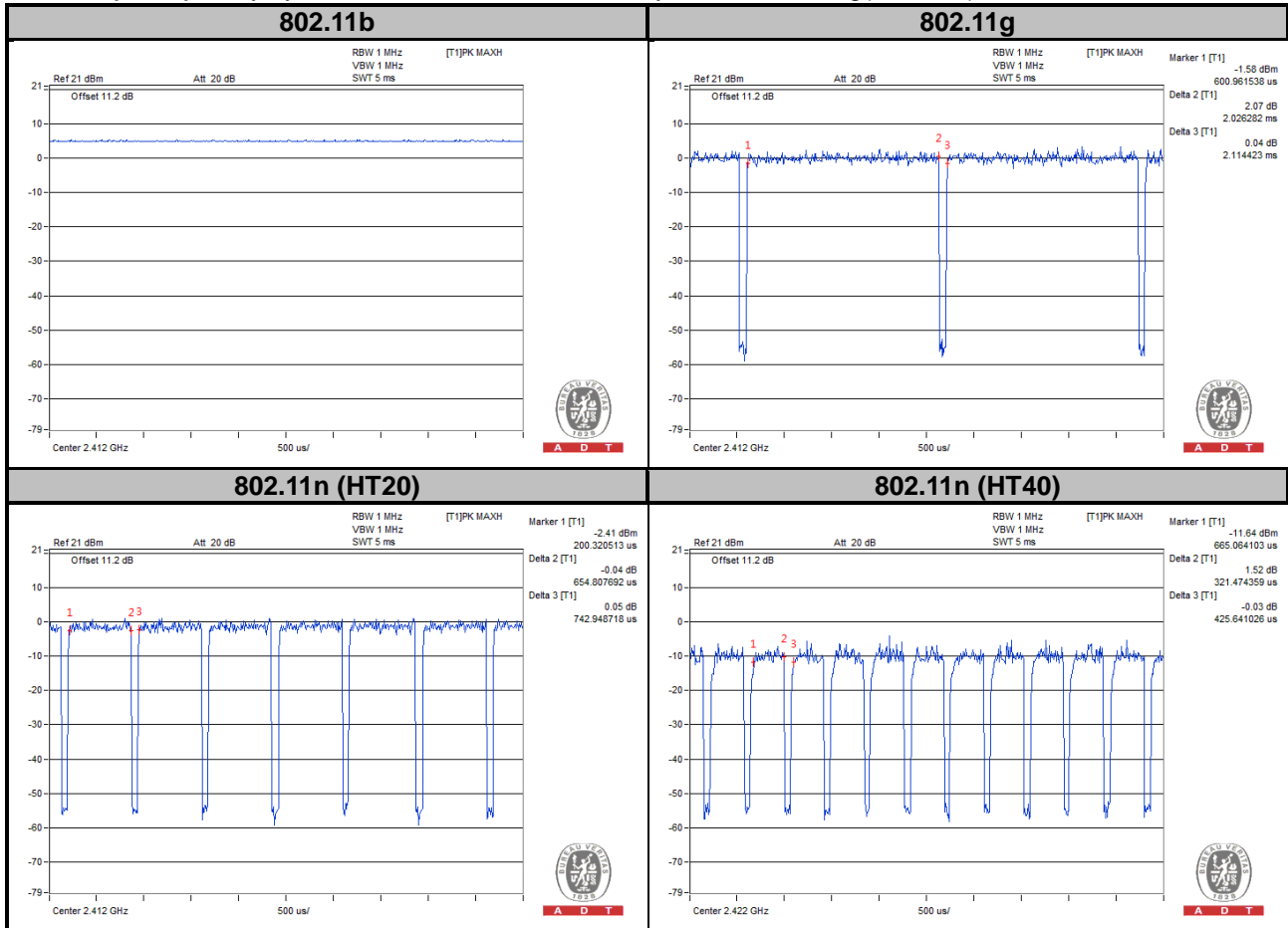

### 3.4 Description of Support Units

The EUT has been tested as an independent unit together with other necessary accessories or support units. The following support units or accessories were used to form a representative test configuration during the tests.

No.	Product	Brand	Model No.	Serial No.	FCC ID
1.	Notebook	DELL	E6420	D3T96R1	N/A

Note:

1. All power cords of the above support units are non-shielded (1.8m).

#### 3.4.1 Configuration of System under Test

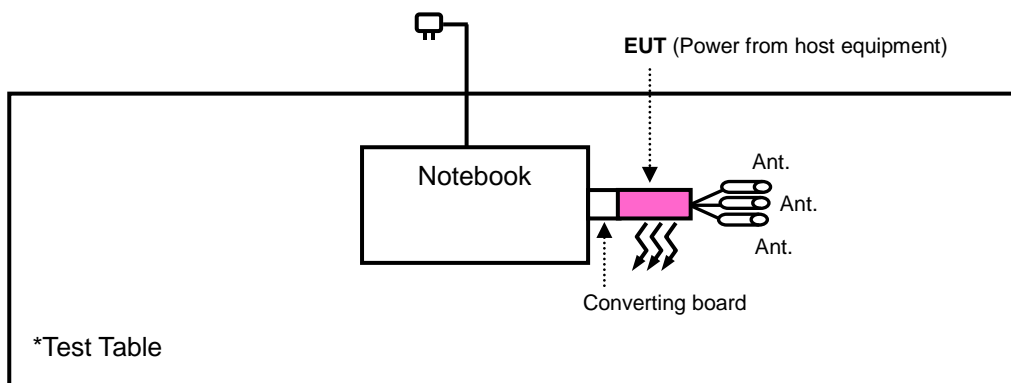

### 3.5 General Description of Applied Standards

The EUT is a RF Product. According to the specifications of the manufacturer, it must comply with the requirements of the following standards:

**FCC Part 15, Subpart C (15.247)**

**558074 D01 DTS Meas Guidance v03r03**

**662911 D01 Multiple Transmitter Output v02r01**

ANSI C63.10-2013

All test items have been performed and recorded as per the above standards.

**NOTE:** The EUT has been verified to comply with the requirements of FCC Part 15, Subpart B, Class B (DoC). The test report has been issued separately.

## 4 Test Types and Results

### 4.1 Radiated Emission and Bandedge Measurement

#### 4.1.1 Limits of Radiated Emission and Bandedge Measurement

Radiated emissions which fall in the restricted bands must comply with the radiated emission limits specified as below table. Other emissions shall be at least 20 dB below the highest level of the desired power:

Frequencies (MHz)	Field Strength (microvolts/meter)	Measurement Distance (meters)
0.009 ~ 0.490	2400/F (kHz)	300
0.490 ~ 1.705	24000/F (kHz)	30
1.705 ~ 30.0	30	30
30 ~ 88	100	3
88 ~ 216	150	3
216 ~ 960	200	3
Above 960	500	3

**NOTE:**

1. The lower limit shall apply at the transition frequencies.
2. Emission level (dBuV/m) = 20 log Emission level (uV/m).
3. For frequencies above 1000 MHz, the field strength limits are based on average detector, however, the peak field strength of any emission shall not exceed the maximum permitted average limits, specified above by more than 20 dB under any condition of modulation.

**4.1.2 Test Instruments**

<b>Description &amp; Manufacturer</b>	<b>Model No.</b>	<b>Serial No.</b>	<b>Date of Calibration</b>	<b>Due Date of Calibration</b>
Test Receiver Agilent Technologies	N9038A	MY52260177	May 19, 2015	May 18, 2016
Spectrum Analyzer Agilent	N9010A	MY52220207	Sep. 11, 2015	Sep. 10, 2016
BILOG Antenna SCHWARZBECK	VULB9168	9168-472	Feb. 04, 2015	Feb. 04, 2016
HORN Antenna SCHWARZBECK	BBHA 9170	9170-480	Feb. 04, 2015	Feb. 04, 2016
HORN Antenna ETS-Lindgren	3117	00143293	Jan. 05, 2015	Jan. 04, 2016
Bluetooth Tester	CBT	100980	Apr. 27, 2015	Apr. 26, 2017
Loop Antenna	EM-6879	269	Jul. 31, 2015	Jul. 30, 2016
Agilent Communications Tester-Wireless	8960 Series 10	MY53201073	Jul. 03, 2015	Jul. 02, 2017
Preamplifier Agilent	310N	187226	Jun. 29, 2015	Jun. 28, 2016
Preamplifier Agilent	83017A	MY39501357	Jun. 29, 2015	Jun. 28, 2016
Power Meter Anritsu	ML2495A	1232002	Sep. 21, 2015	Sep. 20, 2016
Power Sensor Anritsu	MA2411B	1207325	Sep. 21, 2015	Sep. 20, 2016
RF signal cable ETS-LINDGREN	5D-FB	Cable-CH1-01(R FC-SMS-100-SM S-120+RFC-SMS -100-SMS-400)	Jun. 27, 2015	Jun. 26, 2016
RF signal cable ETS-LINDGREN	8D-FB	Cable-CH1-02(R FC-SMS-100-SM S-24)	Jun. 27, 2015	Jun. 26, 2016
Software BV ADT	E3 8.130425b	NA	NA	NA
Antenna Tower MF	NA	NA	NA	NA
Turn Table MF	NA	NA	NA	NA
Antenna Tower & Turn Table Controller MF	MF-7802	NA	NA	NA

- Note: 1. The calibration interval of the above test instruments is 12 months and the calibrations are traceable to NML/ROC and NIST/USA.
2. The test was performed in HsinTien Chamber 1.
3. The horn antenna and preamplifier (model: 83017A) are used only for the measurement of emission frequency above 1 GHz if tested.
4. The FCC Site Registration No. is 149147.
5. The IC Site Registration No. is IC7450I-1.

#### 4.1.3 Test Procedures

- a. The EUT was placed on the top of a rotating table 0.8 meters (for below 1 GHz) / 1.5 meters (for above 1 GHz) above the ground at 3 meter chamber room for test. The table was rotated 360 degrees to determine the position of the highest radiation.
- b. The EUT was set 3 meters away from the interference-receiving antenna, which was mounted on the top of a variable-height antenna tower.
- c. The height of antenna is varied from one meter to four meters above the ground to determine the maximum value of the field strength. Both horizontal and vertical polarizations of the antenna are set to make the measurement.
- d. For each suspected emission, the EUT was arranged to its worst case and then the antenna was tuned to heights from 1 meter to 4 meters and the rotatable table was turned from 0 degrees to 360 degrees to find the maximum reading.
- e. The test-receiver system was set to quasi-peak detect function and specified bandwidth with maximum hold mode when the test frequency is below 1 GHz.
- f. The test-receiver system was set to peak and average detected function and specified bandwidth with maximum hold mode when the test frequency is above 1 GHz. If the peak reading value also meets average limit, measurement with the average detector is unnecessary.

**Note:**

1. The resolution bandwidth and video bandwidth of test receiver/spectrum analyzer is 120 kHz for Quasi-peak detection (QP) at frequency below 1 GHz.
2. The resolution bandwidth of test receiver/spectrum analyzer is 1 MHz and the video bandwidth is 3 MHz for Peak detection (PK) at frequency above 1 GHz.
3. The resolution bandwidth of test receiver/spectrum analyzer is 1 MHz and the video bandwidth is 3 MHz for RMS Average (Duty cycle < 98 %) for Average detection (AV) at frequency above 1 GHz, then the measurement results was added to a correction factor ( $10 \log(1/\text{duty cycle})$ ).
4. The resolution bandwidth of test receiver/spectrum analyzer is 1MHz and the video bandwidth is 10 Hz (Duty cycle  $\geq 98$  %) for Average detection (AV) at frequency above 1 GHz.
5. All modes of operation were investigated and the worst-case emissions are reported.

#### 4.1.4 Deviation from Test Standard

No deviation.



#### 4.1.5 Test Set Up

##### <Frequency Range below 1 GHz>

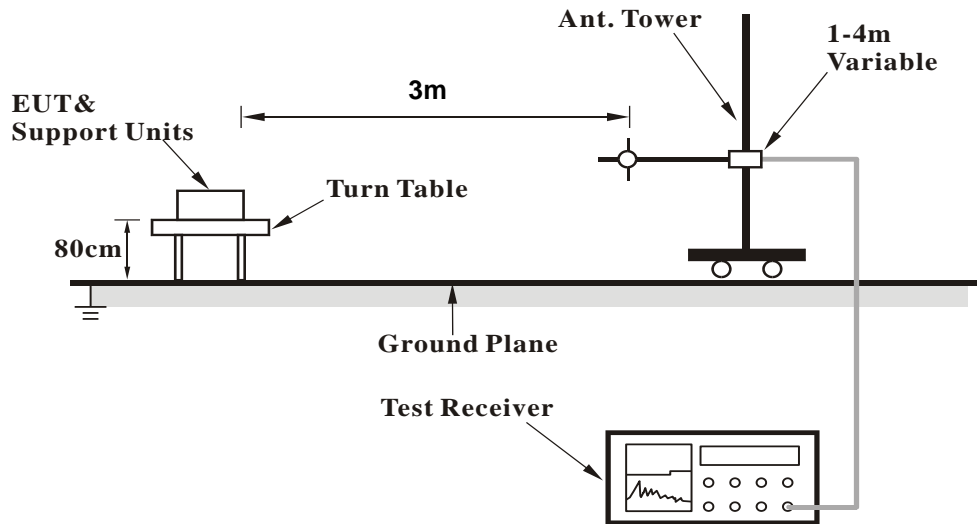

##### <Frequency Range above 1 GHz>

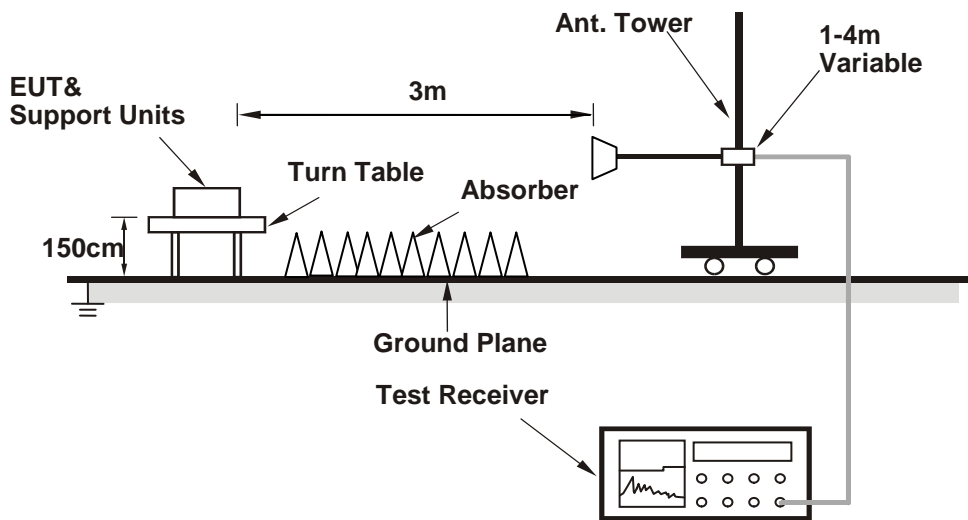

For the actual test configuration, please refer to the attached file (Test Setup Photo).

#### 4.1.6 EUT Operating Conditions

- Placed the EUT on a testing table.
- Use the software to control the EUT under transmission condition continuously at specific channel frequency.

**4.1.7 Test Results**
**Above 1 GHz Data :**
**Mode A**
**802.11b**

EUT TEST CONDITION		MEASUREMENT DETAIL	
CHANNEL	Channel 1	FREQUENCY RANGE	1 GHz ~ 25 GHz
INPUT POWER	120 Vac, 60 Hz	DETECTOR FUNCTION	Peak (PK) Average (AV)
ENVIRONMENTAL CONDITIONS	25 deg. C, 65 % RH	TESTED BY	Charles Hsiao

**ANTENNA POLARITY & TEST DISTANCE: HORIZONTAL AT 3 M**

FREQ. (MHz)	EMISSION LEVEL (dBuV/m)	READ LEVEL (dBuV)	LIMIT (dBuV/m)	MARGIN (dB)	ANTENNA FACTOR (dB/m)	CABLE LOSS (dB)	PREAMP FACTOR (dB)	ANTENNA HEIGHT (cm)	TABLE ANGLE (Degree)	REMARK
2390	43.15	41.42	54	-10.85	31.8	5.4	35.47	125	198	Average
2390	59.29	57.56	74	-14.71	31.8	5.4	35.47	125	198	Peak
2412	105.39	103.62			31.81	5.43	35.47	268	207	Average
2412	108.47	106.7			31.81	5.43	35.47	268	207	Peak
2496	40.57	38.55	54	-13.43	31.9	5.53	35.41	268	207	Average
2496	55.57	53.55	74	-18.43	31.9	5.53	35.41	268	207	Peak

**ANTENNA POLARITY & TEST DISTANCE: VERTICAL AT 3 M**

FREQ. (MHz)	EMISSION LEVEL (dBuV/m)	READ LEVEL (dBuV)	LIMIT (dBuV/m)	MARGIN (dB)	ANTENNA FACTOR (dB/m)	CABLE LOSS (dB)	PREAMP FACTOR (dB)	ANTENNA HEIGHT (cm)	TABLE ANGLE (Degree)	REMARK
2390	46.72	44.99	54	-7.28	31.8	5.4	35.47	147	344	Average
2390	59.81	58.08	74	-14.19	31.8	5.4	35.47	147	344	Peak
2412	109.66	107.89			31.81	5.43	35.47	144	360	Average
2412	112.81	111.04			31.81	5.43	35.47	144	360	Peak
2494	40.72	38.7	54	-13.28	31.9	5.53	35.41	144	360	Average
2494	56.01	53.99	74	-17.99	31.9	5.53	35.41	144	360	Peak
4824	49.51	41.38	54	-4.49	33.97	8.26	34.1	100	92	Average
4824	52.87	44.74	74	-21.13	33.97	8.26	34.1	100	92	Peak

**REMARKS:**

- Emission Level = Read Level + Antenna Factor + Cable Loss - Preamp Factor  
Margin value = Emission level – Limit value
- 2412 MHz: Fundamental frequency.



A D T

EUT TEST CONDITION		MEASUREMENT DETAIL	
CHANNEL	Channel 6	FREQUENCY RANGE	1 GHz ~ 25 GHz
INPUT POWER	120 Vac, 60 Hz	DETECTOR FUNCTION	Peak (PK) Average (AV)
ENVIRONMENTAL CONDITIONS	25 deg. C, 65 % RH	TESTED BY	Charles Hsiao

ANTENNA POLARITY & TEST DISTANCE: HORIZONTAL AT 3 M										
FREQ. (MHz)	EMISSION LEVEL (dBuV/m)	READ LEVEL (dBuV)	LIMIT (dBuV/m)	MARGIN (dB)	ANTENNA FACTOR (dB/m)	CABLE LOSS (dB)	PREAMP FACTOR (dB)	ANTENNA HEIGHT (cm)	TABLE ANGLE (Degree)	REMARK
2328	39.65	38.14	54	-14.35	31.73	5.3	35.52	272	214	Average
2328	55.93	54.42	74	-18.07	31.73	5.3	35.52	272	214	Peak
2437	106.68	104.83			31.85	5.46	35.46	272	214	Average
2437	109.35	107.5			31.85	5.46	35.46	272	214	Peak
2488	40.06	38.05	54	-13.94	31.9	5.53	35.42	272	214	Average
2488	56.27	54.26	74	-17.73	31.9	5.53	35.42	272	214	Peak

ANTENNA POLARITY & TEST DISTANCE: VERTICAL AT 3 M										
FREQ. (MHz)	EMISSION LEVEL (dBuV/m)	READ LEVEL (dBuV)	LIMIT (dBuV/m)	MARGIN (dB)	ANTENNA FACTOR (dB/m)	CABLE LOSS (dB)	PREAMP FACTOR (dB)	ANTENNA HEIGHT (cm)	TABLE ANGLE (Degree)	REMARK
2372	41.27	39.61	54	-12.73	31.78	5.37	35.49	144	0	Average
2372	55.31	53.65	74	-18.69	31.78	5.37	35.49	144	0	Peak
2437	110.91	109.06			31.85	5.46	35.46	144	0	Average
2437	112.96	111.11			31.85	5.46	35.46	144	0	Peak
2484	40.54	38.58	54	-13.46	31.88	5.5	35.42	144	0	Average
2484	55.66	53.7	74	-18.34	31.88	5.5	35.42	144	0	Peak
4874	48.06	39.87	54	-5.94	33.98	8.27	34.06	140	172	Average
4874	52.92	44.73	74	-21.08	33.98	8.27	34.06	140	172	Peak

## REMARKS:

- Emission Level = Read Level + Antenna Factor + Cable Loss - Preamp Factor  
Margin value = Emission level – Limit value
- 2437 MHz: Fundamental frequency.



A D T

EUT TEST CONDITION		MEASUREMENT DETAIL	
CHANNEL	Channel 11	FREQUENCY RANGE	1 GHz ~ 25 GHz
INPUT POWER	120 Vac, 60 Hz	DETECTOR FUNCTION	Peak (PK) Average (AV)
ENVIRONMENTAL CONDITIONS	25 deg. C, 65 % RH	TESTED BY	Charles Hsiao

ANTENNA POLARITY & TEST DISTANCE: HORIZONTAL AT 3 M										
FREQ. (MHz)	EMISSION LEVEL (dBuV/m)	READ LEVEL (dBuV)	LIMIT (dBuV/m)	MARGIN (dB)	ANTENNA FACTOR (dB/m)	CABLE LOSS (dB)	PREAMP FACTOR (dB)	ANTENNA HEIGHT (cm)	TABLE ANGLE (Degree)	REMARK
2374	39.73	38.07	54	-14.27	31.78	5.37	35.49	169	204	Average
2374	55.94	54.28	74	-18.06	31.78	5.37	35.49	169	204	Peak
2462	106.04	104.11			31.87	5.5	35.44	169	204	Average
2462	109.23	107.3			31.87	5.5	35.44	169	204	Peak
2488	42.95	40.94	54	-11.05	31.9	5.53	35.42	148	73	Average
2488	57.87	55.86	74	-16.13	31.9	5.53	35.42	148	73	Peak

ANTENNA POLARITY & TEST DISTANCE: VERTICAL AT 3 M										
FREQ. (MHz)	EMISSION LEVEL (dBuV/m)	READ LEVEL (dBuV)	LIMIT (dBuV/m)	MARGIN (dB)	ANTENNA FACTOR (dB/m)	CABLE LOSS (dB)	PREAMP FACTOR (dB)	ANTENNA HEIGHT (cm)	TABLE ANGLE (Degree)	REMARK
2380	38.32	36.66	54	-15.68	31.78	5.37	35.49	114	178	Average
2380	56.36	54.7	74	-17.64	31.78	5.37	35.49	114	178	Peak
2462	109.94	108.01			31.87	5.5	35.44	114	178	Average
2462	112.26	110.33			31.87	5.5	35.44	114	178	Peak
2484	46.34	44.38	54	-7.66	31.88	5.5	35.42	107	259	Average
2484	63.61	61.65	74	-10.39	31.88	5.5	35.42	107	259	Peak
4924	47.92	39.67	54	-6.08	33.99	8.28	34.02	173	70	Average
4924	52.63	44.38	74	-21.37	33.99	8.28	34.02	173	70	Peak

## REMARKS:

- Emission Level = Read Level + Antenna Factor + Cable Loss - Preamp Factor  
Margin value = Emission level – Limit value
- 2462 MHz: Fundamental frequency.

**802.11g**

EUT TEST CONDITION		MEASUREMENT DETAIL	
<b>CHANNEL</b>	Channel 1	<b>FREQUENCY RANGE</b>	1 GHz ~ 25 GHz
<b>INPUT POWER</b>	120 Vac, 60 Hz	<b>DETECTOR FUNCTION</b>	Peak (PK) Average (AV)
<b>ENVIRONMENTAL CONDITIONS</b>	25 deg. C, 65 % RH	<b>TESTED BY</b>	Charles Hsiao

**ANTENNA POLARITY & TEST DISTANCE: HORIZONTAL AT 3 M**

FREQ. (MHz)	EMISSION LEVEL (dBuV/m)	READ LEVEL (dBuV)	LIMIT (dBuV/m)	MARGIN (dB)	ANTENNA FACTOR (dB/m)	CABLE LOSS (dB)	PREAMP FACTOR (dB)	ANTENNA HEIGHT (cm)	TABLE ANGLE (Degree)	REMARK
2390	48.84	47.11	54	-5.16	31.8	5.4	35.47	128	82	Average
2390	64.18	62.45	74	-9.82	31.8	5.4	35.47	128	82	Peak
2412	99.2	97.43			31.81	5.43	35.47	128	82	Average
2412	106.92	105.15			31.81	5.43	35.47	128	82	Peak
2484	40.92	38.96	54	-13.08	31.88	5.5	35.42	128	82	Average
2484	51.66	49.7	74	-22.34	31.88	5.5	35.42	128	82	Peak

**ANTENNA POLARITY & TEST DISTANCE: VERTICAL AT 3 M**

FREQ. (MHz)	EMISSION LEVEL (dBuV/m)	READ LEVEL (dBuV)	LIMIT (dBuV/m)	MARGIN (dB)	ANTENNA FACTOR (dB/m)	CABLE LOSS (dB)	PREAMP FACTOR (dB)	ANTENNA HEIGHT (cm)	TABLE ANGLE (Degree)	REMARK
2390	52.8	51.07	54	-1.2	31.8	5.4	35.47	101	198	Average
2390	68.35	66.62	74	-5.65	31.8	5.4	35.47	101	198	Peak
2412	102	100.23			31.81	5.43	35.47	101	198	Average
2412	109.27	107.5			31.81	5.43	35.47	101	198	Peak
2486	41.5	39.51	54	-12.5	31.88	5.53	35.42	101	198	Average
2486	51.93	49.94	74	-22.07	31.88	5.53	35.42	101	198	Peak

**REMARKS:**

- Emission Level = Read Level + Antenna Factor + Cable Loss - Preamp Factor  
Margin value = Emission level – Limit value
- 2412 MHz: Fundamental frequency.



EUT TEST CONDITION		MEASUREMENT DETAIL	
CHANNEL	Channel 6	FREQUENCY RANGE	1 GHz ~ 25 GHz
INPUT POWER	120 Vac, 60 Hz	DETECTOR FUNCTION	Peak (PK) Average (AV)
ENVIRONMENTAL CONDITIONS	25 deg. C, 65 % RH	TESTED BY	Charles Hsiao

ANTENNA POLARITY & TEST DISTANCE: HORIZONTAL AT 3 M										
FREQ. (MHz)	EMISSION LEVEL (dBuV/m)	READ LEVEL (dBuV)	LIMIT (dBuV/m)	MARGIN (dB)	ANTENNA FACTOR (dB/m)	CABLE LOSS (dB)	PREAMP FACTOR (dB)	ANTENNA HEIGHT (cm)	TABLE ANGLE (Degree)	REMARK
2360	41.08	39.45	54	-12.92	31.76	5.37	35.5	180	272	Average
2360	52.76	51.13	74	-21.24	31.76	5.37	35.5	180	272	Peak
2437	101.17	99.32			31.85	5.46	35.46	180	272	Average
2437	108.72	106.87			31.85	5.46	35.46	180	272	Peak
2490	41.21	39.2	54	-12.79	31.9	5.53	35.42	180	272	Average
2490	51.64	49.63	74	-22.36	31.9	5.53	35.42	180	272	Peak

ANTENNA POLARITY & TEST DISTANCE: VERTICAL AT 3 M										
FREQ. (MHz)	EMISSION LEVEL (dBuV/m)	READ LEVEL (dBuV)	LIMIT (dBuV/m)	MARGIN (dB)	ANTENNA FACTOR (dB/m)	CABLE LOSS (dB)	PREAMP FACTOR (dB)	ANTENNA HEIGHT (cm)	TABLE ANGLE (Degree)	REMARK
2386	42.58	40.87	54	-11.42	31.8	5.4	35.49	193	0	Average
2386	53.34	51.63	74	-20.66	31.8	5.4	35.49	193	0	Peak
2437	105.09	103.24			31.85	5.46	35.46	193	0	Average
2437	112.46	110.61			31.85	5.46	35.46	193	0	Peak
2490	43.18	41.17	54	-10.82	31.9	5.53	35.42	193	0	Average
2490	53.95	51.94	74	-20.05	31.9	5.53	35.42	193	0	Peak

## REMARKS:

- Emission Level = Read Level + Antenna Factor + Cable Loss - Preamp Factor  
Margin value = Emission level – Limit value
- 2437 MHz: Fundamental frequency.



A D T

EUT TEST CONDITION		MEASUREMENT DETAIL	
CHANNEL	Channel 11	FREQUENCY RANGE	1 GHz ~ 25 GHz
INPUT POWER	120 Vac, 60 Hz	DETECTOR FUNCTION	Peak (PK) Average (AV)
ENVIRONMENTAL CONDITIONS	25 deg. C, 65 % RH	TESTED BY	Charles Hsiao

ANTENNA POLARITY & TEST DISTANCE: HORIZONTAL AT 3 M										
FREQ. (MHz)	EMISSION LEVEL (dBuV/m)	READ LEVEL (dBuV)	LIMIT (dBuV/m)	MARGIN (dB)	ANTENNA FACTOR (dB/m)	CABLE LOSS (dB)	PREAMP FACTOR (dB)	ANTENNA HEIGHT (cm)	TABLE ANGLE (Degree)	REMARK
2390	40.66	38.93	54	-13.34	31.8	5.4	35.47	155	281	Average
2390	52.14	50.41	74	-21.86	31.8	5.4	35.47	155	281	Peak
2462	97.38	95.45			31.87	5.5	35.44	155	281	Average
2462	105.99	104.06			31.87	5.5	35.44	155	281	Peak
2484	45.87	43.91	54	-8.13	31.88	5.5	35.42	155	281	Average
2484	59.24	57.28	74	-14.76	31.88	5.5	35.42	155	281	Peak

ANTENNA POLARITY & TEST DISTANCE: VERTICAL AT 3 M										
FREQ. (MHz)	EMISSION LEVEL (dBuV/m)	READ LEVEL (dBuV)	LIMIT (dBuV/m)	MARGIN (dB)	ANTENNA FACTOR (dB/m)	CABLE LOSS (dB)	PREAMP FACTOR (dB)	ANTENNA HEIGHT (cm)	TABLE ANGLE (Degree)	REMARK
2314	40.96	39.47	54	-13.04	31.71	5.3	35.52	154	6	Average
2314	51.8	50.31	74	-22.2	31.71	5.3	35.52	154	6	Peak
2462	102.78	100.85			31.87	5.5	35.44	154	6	Average
2462	109.76	107.83			31.87	5.5	35.44	154	6	Peak
2484	52.62	50.66	54	-1.38	31.88	5.5	35.42	154	6	Average
2484	68.24	66.28	74	-5.76	31.88	5.5	35.42	154	6	Peak

## REMARKS:

- Emission Level = Read Level + Antenna Factor + Cable Loss - Preamp Factor  
Margin value = Emission level – Limit value
- 2462 MHz: Fundamental frequency.

**802.11n (HT20)**

EUT TEST CONDITION		MEASUREMENT DETAIL	
CHANNEL	Channel 1	FREQUENCY RANGE	1 GHz ~ 25 GHz
INPUT POWER	120 Vac, 60 Hz	DETECTOR FUNCTION	Peak (PK) Average (AV)
ENVIRONMENTAL CONDITIONS	25 deg. C, 65 % RH	TESTED BY	Charles Hsiao

**ANTENNA POLARITY & TEST DISTANCE: HORIZONTAL AT 3 M**

FREQ. (MHz)	EMISSION LEVEL (dBuV/m)	READ LEVEL (dBuV)	LIMIT (dBuV/m)	MARGIN (dB)	ANTENNA FACTOR (dB/m)	CABLE LOSS (dB)	PREAMP FACTOR (dB)	ANTENNA HEIGHT (cm)	TABLE ANGLE (Degree)	REMARK
2390	42.34	40.61	54	-11.66	31.8	5.4	35.47	145	207	Average
2390	54.54	52.81	74	-19.46	31.8	5.4	35.47	145	207	Peak
2412	97.14	95.37			31.81	5.43	35.47	145	207	Average
2412	105.18	103.41			31.81	5.43	35.47	145	207	Peak
2496	41.2	39.18	54	-12.8	31.9	5.53	35.41	145	207	Average
2496	51.79	49.77	74	-22.21	31.9	5.53	35.41	145	207	Peak

**ANTENNA POLARITY & TEST DISTANCE: VERTICAL AT 3 M**

FREQ. (MHz)	EMISSION LEVEL (dBuV/m)	READ LEVEL (dBuV)	LIMIT (dBuV/m)	MARGIN (dB)	ANTENNA FACTOR (dB/m)	CABLE LOSS (dB)	PREAMP FACTOR (dB)	ANTENNA HEIGHT (cm)	TABLE ANGLE (Degree)	REMARK
2390	52.48	50.75	54	-1.52	31.8	5.4	35.47	144	359	Average
2390	67	65.27	74	-7	31.8	5.4	35.47	144	359	Peak
2412	100.75	98.98			31.81	5.43	35.47	144	359	Average
2412	108.97	107.2			31.81	5.43	35.47	144	359	Peak
2488	41.33	39.32	54	-12.67	31.9	5.53	35.42	144	359	Average
2488	52.52	50.51	74	-21.48	31.9	5.53	35.42	144	359	Peak

**REMARKS:**

- Emission Level = Read Level + Antenna Factor + Cable Loss - Preamp Factor  
Margin value = Emission level – Limit value
- 2412 MHz: Fundamental frequency.





EUT TEST CONDITION		MEASUREMENT DETAIL	
CHANNEL	Channel 6	FREQUENCY RANGE	1 GHz ~ 25 GHz
INPUT POWER	120 Vac, 60 Hz	DETECTOR FUNCTION	Peak (PK) Average (AV)
ENVIRONMENTAL CONDITIONS	25 deg. C, 65 % RH	TESTED BY	Charles Hsiao

**ANTENNA POLARITY & TEST DISTANCE: HORIZONTAL AT 3 M**

FREQ. (MHz)	EMISSION LEVEL (dBuV/m)	READ LEVEL (dBuV)	LIMIT (dBuV/m)	MARGIN (dB)	ANTENNA FACTOR (dB/m)	CABLE LOSS (dB)	PREAMP FACTOR (dB)	ANTENNA HEIGHT (cm)	TABLE ANGLE (Degree)	REMARK
2332	41.06	39.52	54	-12.94	31.73	5.33	35.52	242	272	Average
2332	52.54	51	74	-21.46	31.73	5.33	35.52	242	272	Peak
2437	101.97	100.12			31.85	5.46	35.46	242	272	Average
2437	109.28	107.43			31.85	5.46	35.46	242	272	Peak
2490	41.23	39.22	54	-12.77	31.9	5.53	35.42	242	272	Average
2490	52.43	50.42	74	-21.57	31.9	5.53	35.42	242	272	Peak

**ANTENNA POLARITY & TEST DISTANCE: VERTICAL AT 3 M**

FREQ. (MHz)	EMISSION LEVEL (dBuV/m)	READ LEVEL (dBuV)	LIMIT (dBuV/m)	MARGIN (dB)	ANTENNA FACTOR (dB/m)	CABLE LOSS (dB)	PREAMP FACTOR (dB)	ANTENNA HEIGHT (cm)	TABLE ANGLE (Degree)	REMARK
2388	44.16	42.45	54	-9.84	31.8	5.4	35.49	142	0	Average
2388	55.06	53.35	74	-18.94	31.8	5.4	35.49	142	0	Peak
2437	105.74	103.89			31.85	5.46	35.46	142	0	Average
2437	113.06	111.21			31.85	5.46	35.46	142	0	Peak
2492	43.47	41.45	54	-10.53	31.9	5.53	35.41	142	0	Average
2492	54.26	52.24	74	-19.74	31.9	5.53	35.41	142	0	Peak

## REMARKS:

- Emission Level = Read Level + Antenna Factor + Cable Loss - Preamp Factor  
Margin value = Emission level – Limit value
- 2437 MHz: Fundamental frequency.



A D T

EUT TEST CONDITION		MEASUREMENT DETAIL	
CHANNEL	Channel 11	FREQUENCY RANGE	1 GHz ~ 25 GHz
INPUT POWER	120 Vac, 60 Hz	DETECTOR FUNCTION	Peak (PK) Average (AV)
ENVIRONMENTAL CONDITIONS	25 deg. C, 65 % RH	TESTED BY	Charles Hsiao

ANTENNA POLARITY & TEST DISTANCE: HORIZONTAL AT 3 M										
FREQ. (MHz)	EMISSION LEVEL (dBuV/m)	READ LEVEL (dBuV)	LIMIT (dBuV/m)	MARGIN (dB)	ANTENNA FACTOR (dB/m)	CABLE LOSS (dB)	PREAMP FACTOR (dB)	ANTENNA HEIGHT (cm)	TABLE ANGLE (Degree)	REMARK
2364	40.47	38.84	54	-13.53	31.76	5.37	35.5	109	166	Average
2364	51.97	50.34	74	-22.03	31.76	5.37	35.5	109	166	Peak
2462	95.92	93.99			31.87	5.5	35.44	109	166	Average
2462	103.8	101.87			31.87	5.5	35.44	109	166	Peak
2484	44.4	42.44	54	-9.6	31.88	5.5	35.42	109	166	Average
2484	56.9	54.94	74	-17.1	31.88	5.5	35.42	109	166	Peak

ANTENNA POLARITY & TEST DISTANCE: VERTICAL AT 3 M										
FREQ. (MHz)	EMISSION LEVEL (dBuV/m)	READ LEVEL (dBuV)	LIMIT (dBuV/m)	MARGIN (dB)	ANTENNA FACTOR (dB/m)	CABLE LOSS (dB)	PREAMP FACTOR (dB)	ANTENNA HEIGHT (cm)	TABLE ANGLE (Degree)	REMARK
2384	40.88	39.19	54	-13.12	31.78	5.4	35.49	123	0	Average
2384	51.89	50.2	74	-22.11	31.78	5.4	35.49	123	0	Peak
2462	100.84	98.91			31.87	5.5	35.44	123	0	Average
2462	107.96	106.03			31.87	5.5	35.44	123	0	Peak
2484	52.85	50.89	54	-1.15	31.88	5.5	35.42	123	0	Average
2484	66.97	65.01	74	-7.03	31.88	5.5	35.42	123	0	Peak

## REMARKS:

- Emission Level = Read Level + Antenna Factor + Cable Loss - Preamp Factor  
Margin value = Emission level – Limit value
- 2462 MHz: Fundamental frequency.

**802.11n (HT40)**

EUT TEST CONDITION		MEASUREMENT DETAIL	
CHANNEL	Channel 3	FREQUENCY RANGE	1 GHz ~ 25 GHz
INPUT POWER	120 Vac, 60 Hz	DETECTOR FUNCTION	Peak (PK) Average (AV)
ENVIRONMENTAL CONDITIONS	25 deg. C, 65 % RH	TESTED BY	Charles Hsiao

**ANTENNA POLARITY & TEST DISTANCE: HORIZONTAL AT 3 M**

FREQ. (MHz)	EMISSION LEVEL (dBuV/m)	READ LEVEL (dBuV)	LIMIT (dBuV/m)	MARGIN (dB)	ANTENNA FACTOR (dB/m)	CABLE LOSS (dB)	PREAMP FACTOR (dB)	ANTENNA HEIGHT (cm)	TABLE ANGLE (Degree)	REMARK
2388	43.1	41.39	54	-10.9	31.8	5.4	35.49	145	207	Average
2388	54.8	53.09	74	-19.2	31.8	5.4	35.49	145	207	Peak
2422	91.64	89.84			31.83	5.43	35.46	145	207	Average
2422	99.85	98.05			31.83	5.43	35.46	145	207	Peak
2492	41.35	39.33	54	-12.65	31.9	5.53	35.41	145	207	Average
2492	52.7	50.68	74	-21.3	31.9	5.53	35.41	145	207	Peak

**ANTENNA POLARITY & TEST DISTANCE: VERTICAL AT 3 M**

FREQ. (MHz)	EMISSION LEVEL (dBuV/m)	READ LEVEL (dBuV)	LIMIT (dBuV/m)	MARGIN (dB)	ANTENNA FACTOR (dB/m)	CABLE LOSS (dB)	PREAMP FACTOR (dB)	ANTENNA HEIGHT (cm)	TABLE ANGLE (Degree)	REMARK
2390	51.35	49.62	54	-2.65	31.8	5.4	35.47	144	360	Average
2390	62.85	61.12	74	-11.15	31.8	5.4	35.47	144	360	Peak
2422	95.51	93.71			31.83	5.43	35.46	144	360	Average
2422	103.39	101.59			31.83	5.43	35.46	144	360	Peak
2486	41.72	39.73	54	-12.28	31.88	5.53	35.42	144	360	Average
2486	52.45	50.46	74	-21.55	31.88	5.53	35.42	144	360	Peak

**REMARKS:**

- Emission Level = Read Level + Antenna Factor + Cable Loss - Preamp Factor  
Margin value = Emission level – Limit value
- 2422 MHz: Fundamental frequency.



A D T

EUT TEST CONDITION		MEASUREMENT DETAIL	
CHANNEL	Channel 6	FREQUENCY RANGE	1 GHz ~ 25 GHz
INPUT POWER	120 Vac, 60 Hz	DETECTOR FUNCTION	Peak (PK) Average (AV)
ENVIRONMENTAL CONDITIONS	25 deg. C, 65 % RH	TESTED BY	Charles Hsiao

ANTENNA POLARITY & TEST DISTANCE: HORIZONTAL AT 3 M										
FREQ. (MHz)	EMISSION LEVEL (dBuV/m)	READ LEVEL (dBuV)	LIMIT (dBuV/m)	MARGIN (dB)	ANTENNA FACTOR (dB/m)	CABLE LOSS (dB)	PREAMP FACTOR (dB)	ANTENNA HEIGHT (cm)	TABLE ANGLE (Degree)	REMARK
2390	45.42	43.69	54	-8.58	31.8	5.4	35.47	119	201	Average
2390	57.95	56.22	74	-16.05	31.8	5.4	35.47	119	201	Peak
2437	93.83	91.98			31.85	5.46	35.46	119	201	Average
2437	101.61	99.76			31.85	5.46	35.46	119	201	Peak
2488	42.92	40.91	54	-11.08	31.9	5.53	35.42	119	201	Average
2488	55.31	53.3	74	-18.69	31.9	5.53	35.42	119	201	Peak

ANTENNA POLARITY & TEST DISTANCE: VERTICAL AT 3 M										
FREQ. (MHz)	EMISSION LEVEL (dBuV/m)	READ LEVEL (dBuV)	LIMIT (dBuV/m)	MARGIN (dB)	ANTENNA FACTOR (dB/m)	CABLE LOSS (dB)	PREAMP FACTOR (dB)	ANTENNA HEIGHT (cm)	TABLE ANGLE (Degree)	REMARK
2388	44.9	43.19	54	-9.1	31.8	5.4	35.49	138	346	Average
2388	59.06	57.35	74	-14.94	31.8	5.4	35.49	138	346	Peak
2437	97.98	96.13			31.85	5.46	35.46	138	346	Average
2437	105.56	103.71			31.85	5.46	35.46	138	346	Peak
2484	50.27	48.31	54	-3.73	31.88	5.5	35.42	138	346	Average
2484	61.58	59.62	74	-12.42	31.88	5.5	35.42	138	346	Peak

## REMARKS:

- Emission Level = Read Level + Antenna Factor + Cable Loss - Preamp Factor  
Margin value = Emission level – Limit value
- 2437 MHz: Fundamental frequency.



A D T

EUT TEST CONDITION		MEASUREMENT DETAIL	
CHANNEL	Channel 9	FREQUENCY RANGE	1 GHz ~ 25 GHz
INPUT POWER	120 Vac, 60 Hz	DETECTOR FUNCTION	Peak (PK) Average (AV)
ENVIRONMENTAL CONDITIONS	25 deg. C, 65 % RH	TESTED BY	Charles Hsiao

ANTENNA POLARITY & TEST DISTANCE: HORIZONTAL AT 3 M										
FREQ. (MHz)	EMISSION LEVEL (dBuV/m)	READ LEVEL (dBuV)	LIMIT (dBuV/m)	MARGIN (dB)	ANTENNA FACTOR (dB/m)	CABLE LOSS (dB)	PREAMP FACTOR (dB)	ANTENNA HEIGHT (cm)	TABLE ANGLE (Degree)	REMARK
2352	40.9	39.31	54	-13.1	31.76	5.33	35.5	106	277	Average
2352	51.45	49.86	74	-22.55	31.76	5.33	35.5	106	277	Peak
2452	90.49	88.62			31.85	5.46	35.44	106	277	Average
2452	98.81	96.94			31.85	5.46	35.44	106	277	Peak
2484	47.54	45.58	54	-6.46	31.88	5.5	35.42	106	277	Average
2484	60.35	58.39	74	-13.65	31.88	5.5	35.42	106	277	Peak

ANTENNA POLARITY & TEST DISTANCE: VERTICAL AT 3 M										
FREQ. (MHz)	EMISSION LEVEL (dBuV/m)	READ LEVEL (dBuV)	LIMIT (dBuV/m)	MARGIN (dB)	ANTENNA FACTOR (dB/m)	CABLE LOSS (dB)	PREAMP FACTOR (dB)	ANTENNA HEIGHT (cm)	TABLE ANGLE (Degree)	REMARK
2388	41.31	39.6	54	-12.69	31.8	5.4	35.49	140	29	Average
2388	53.18	51.47	74	-20.82	31.8	5.4	35.49	140	29	Peak
2452	94.61	92.74			31.85	5.46	35.44	140	29	Average
2452	102.46	100.59			31.85	5.46	35.44	140	29	Peak
2484	52.86	50.9	54	-1.14	31.88	5.5	35.42	140	29	Average
2484	65.67	63.71	74	-8.33	31.88	5.5	35.42	140	29	Peak

## REMARKS:

- Emission Level = Read Level + Antenna Factor + Cable Loss - Preamp Factor  
Margin value = Emission level – Limit value
- 2452 MHz: Fundamental frequency.

**Mode B**
**802.11b**

EUT TEST CONDITION		MEASUREMENT DETAIL	
CHANNEL	Channel 1	FREQUENCY RANGE	1 GHz ~ 25 GHz
INPUT POWER	120 Vac, 60 Hz	DETECTOR FUNCTION	Peak (PK) Average (AV)
ENVIRONMENTAL CONDITIONS	25 deg. C, 65 % RH	TESTED BY	Charles Hsiao

**ANTENNA POLARITY & TEST DISTANCE: HORIZONTAL AT 3 M**

FREQ. (MHz)	EMISSION LEVEL (dBuV/m)	READ LEVEL (dBuV)	LIMIT (dBuV/m)	MARGIN (dB)	ANTENNA FACTOR (dB/m)	CABLE LOSS (dB)	PREAMP FACTOR (dB)	ANTENNA HEIGHT (cm)	TABLE ANGLE (Degree)	REMARK
2382	45.2	43.51	54	-8.8	31.78	5.4	35.49	148	90	Average
2382	67.97	66.28	74	-6.03	31.78	5.4	35.49	148	90	Peak
2412	107.75	105.98			31.81	5.43	35.47	145	90	Average
2412	110.4	108.63			31.81	5.43	35.47	145	90	Peak
2492	40.27	38.25	54	-13.73	31.9	5.53	35.41	145	90	Average
2492	55.91	53.89	74	-18.09	31.9	5.53	35.41	145	90	Peak

**ANTENNA POLARITY & TEST DISTANCE: VERTICAL AT 3 M**

FREQ. (MHz)	EMISSION LEVEL (dBuV/m)	READ LEVEL (dBuV)	LIMIT (dBuV/m)	MARGIN (dB)	ANTENNA FACTOR (dB/m)	CABLE LOSS (dB)	PREAMP FACTOR (dB)	ANTENNA HEIGHT (cm)	TABLE ANGLE (Degree)	REMARK
2388	43.9	42.19	54	-10.1	31.8	5.4	35.49	102	211	Average
2388	62.51	60.8	74	-11.49	31.8	5.4	35.49	102	211	Peak
2412	106.8	105.03			31.81	5.43	35.47	102	211	Average
2412	109.6	107.83			31.81	5.43	35.47	102	211	Peak
2500	40.13	38.11	54	-13.87	31.9	5.53	35.41	102	211	Average
2500	55.56	53.54	74	-18.44	31.9	5.53	35.41	102	211	Peak

**REMARKS:**

- Emission Level = Read Level + Antenna Factor + Cable Loss - Preamp Factor  
Margin value = Emission level – Limit value
- 2412 MHz: Fundamental frequency.



A D T

EUT TEST CONDITION		MEASUREMENT DETAIL	
CHANNEL	Channel 6	FREQUENCY RANGE	1 GHz ~ 25 GHz
INPUT POWER	120 Vac, 60 Hz	DETECTOR FUNCTION	Peak (PK) Average (AV)
ENVIRONMENTAL CONDITIONS	25 deg. C, 65 % RH	TESTED BY	Charles Hsiao

ANTENNA POLARITY & TEST DISTANCE: HORIZONTAL AT 3 M										
FREQ. (MHz)	EMISSION LEVEL (dBuV/m)	READ LEVEL (dBuV)	LIMIT (dBuV/m)	MARGIN (dB)	ANTENNA FACTOR (dB/m)	CABLE LOSS (dB)	PREAMP FACTOR (dB)	ANTENNA HEIGHT (cm)	TABLE ANGLE (Degree)	REMARK
2382	40.88	39.19	54	-13.12	31.78	5.4	35.49	180	90	Average
2382	56.51	54.82	74	-17.49	31.78	5.4	35.49	180	90	Peak
2437	107.99	106.14			31.85	5.46	35.46	180	90	Average
2437	110.76	108.91			31.85	5.46	35.46	180	90	Peak
2484	40.38	38.42	54	-13.62	31.88	5.5	35.42	180	90	Average
2484	55.65	53.69	74	-18.35	31.88	5.5	35.42	180	90	Peak

ANTENNA POLARITY & TEST DISTANCE: VERTICAL AT 3 M										
FREQ. (MHz)	EMISSION LEVEL (dBuV/m)	READ LEVEL (dBuV)	LIMIT (dBuV/m)	MARGIN (dB)	ANTENNA FACTOR (dB/m)	CABLE LOSS (dB)	PREAMP FACTOR (dB)	ANTENNA HEIGHT (cm)	TABLE ANGLE (Degree)	REMARK
2376	40.95	39.29	54	-13.05	31.78	5.37	35.49	100	211	Average
2376	56.25	54.59	74	-17.75	31.78	5.37	35.49	100	211	Peak
2437	106.41	104.56			31.85	5.46	35.46	100	211	Average
2437	109.45	107.6			31.85	5.46	35.46	100	211	Peak
2488	40.63	38.62	54	-13.37	31.9	5.53	35.42	100	211	Average
2488	56.24	54.23	74	-17.76	31.9	5.53	35.42	100	211	Peak

## REMARKS:

- Emission Level = Read Level + Antenna Factor + Cable Loss - Preamp Factor  
Margin value = Emission level – Limit value
- 2437 MHz: Fundamental frequency.



A D T

EUT TEST CONDITION		MEASUREMENT DETAIL	
CHANNEL	Channel 11	FREQUENCY RANGE	1 GHz ~ 25 GHz
INPUT POWER	120 Vac, 60 Hz	DETECTOR FUNCTION	Peak (PK) Average (AV)
ENVIRONMENTAL CONDITIONS	25 deg. C, 65 % RH	TESTED BY	Charles Hsiao

ANTENNA POLARITY & TEST DISTANCE: HORIZONTAL AT 3 M										
FREQ. (MHz)	EMISSION LEVEL (dBuV/m)	READ LEVEL (dBuV)	LIMIT (dBuV/m)	MARGIN (dB)	ANTENNA FACTOR (dB/m)	CABLE LOSS (dB)	PREAMP FACTOR (dB)	ANTENNA HEIGHT (cm)	TABLE ANGLE (Degree)	REMARK
2360	41.13	39.5	54	-12.87	31.76	5.37	35.5	109	90	Average
2360	56.34	54.71	74	-17.66	31.76	5.37	35.5	109	90	Peak
2462	107.31	105.38			31.87	5.5	35.44	109	90	Average
2462	110.73	108.8			31.87	5.5	35.44	109	90	Peak
2488	43.23	41.22	54	-10.77	31.9	5.53	35.42	109	90	Average
2488	56.77	54.76	74	-17.23	31.9	5.53	35.42	109	90	Peak

ANTENNA POLARITY & TEST DISTANCE: VERTICAL AT 3 M										
FREQ. (MHz)	EMISSION LEVEL (dBuV/m)	READ LEVEL (dBuV)	LIMIT (dBuV/m)	MARGIN (dB)	ANTENNA FACTOR (dB/m)	CABLE LOSS (dB)	PREAMP FACTOR (dB)	ANTENNA HEIGHT (cm)	TABLE ANGLE (Degree)	REMARK
2376	40.95	39.29	54	-13.05	31.78	5.37	35.49	100	211	Average
2376	56.26	54.6	74	-17.74	31.78	5.37	35.49	100	211	Peak
2462	106.76	104.83			31.87	5.5	35.44	100	211	Average
2462	109.42	107.49			31.87	5.5	35.44	100	211	Peak
2498	43.13	41.11	54	-10.87	31.9	5.53	35.41	100	211	Average
2498	55.8	53.78	74	-18.2	31.9	5.53	35.41	100	211	Peak

## REMARKS:

- Emission Level = Read Level + Antenna Factor + Cable Loss - Preamp Factor  
Margin value = Emission level – Limit value
- 2462 MHz: Fundamental frequency.



**802.11g**

EUT TEST CONDITION		MEASUREMENT DETAIL	
CHANNEL	Channel 1	FREQUENCY RANGE	1 GHz ~ 25 GHz
INPUT POWER	120 Vac, 60 Hz	DETECTOR FUNCTION	Peak (PK) Average (AV)
ENVIRONMENTAL CONDITIONS	25 deg. C, 65 % RH	TESTED BY	Charles Hsiao

**ANTENNA POLARITY & TEST DISTANCE: HORIZONTAL AT 3 M**

FREQ. (MHz)	EMISSION LEVEL (dBuV/m)	READ LEVEL (dBuV)	LIMIT (dBuV/m)	MARGIN (dB)	ANTENNA FACTOR (dB/m)	CABLE LOSS (dB)	PREAMP FACTOR (dB)	ANTENNA HEIGHT (cm)	TABLE ANGLE (Degree)	REMARK
2390	52.8	51.07	54	-1.2	31.8	5.4	35.47	145	90	Average
2390	68.32	66.59	74	-5.68	31.8	5.4	35.47	145	90	Peak
2412	101.35	99.58			31.81	5.43	35.47	144	90	Average
2412	109.27	107.5			31.81	5.43	35.47	144	90	Peak
2490	40.93	38.92	54	-13.07	31.9	5.53	35.42	144	90	Average
2490	55.47	53.46	74	-18.53	31.9	5.53	35.42	144	90	Peak

**ANTENNA POLARITY & TEST DISTANCE: VERTICAL AT 3 M**

FREQ. (MHz)	EMISSION LEVEL (dBuV/m)	READ LEVEL (dBuV)	LIMIT (dBuV/m)	MARGIN (dB)	ANTENNA FACTOR (dB/m)	CABLE LOSS (dB)	PREAMP FACTOR (dB)	ANTENNA HEIGHT (cm)	TABLE ANGLE (Degree)	REMARK
2390	49.7	47.97	54	-4.3	31.8	5.4	35.47	102	238	Average
2390	65.13	63.4	74	-8.87	31.8	5.4	35.47	102	238	Peak
2412	100.65	98.88			31.81	5.43	35.47	102	211	Average
2412	108.22	106.45			31.81	5.43	35.47	102	211	Peak
2490	40.93	38.92	54	-13.07	31.9	5.53	35.42	102	211	Average
2490	56.7	54.69	74	-17.3	31.9	5.53	35.42	102	211	Peak

**REMARKS:**

- Emission Level = Read Level + Antenna Factor + Cable Loss - Preamp Factor  
Margin value = Emission level – Limit value
- 2412 MHz: Fundamental frequency.



A D T

EUT TEST CONDITION		MEASUREMENT DETAIL	
CHANNEL	Channel 6	FREQUENCY RANGE	1 GHz ~ 25 GHz
INPUT POWER	120 Vac, 60 Hz	DETECTOR FUNCTION	Peak (PK) Average (AV)
ENVIRONMENTAL CONDITIONS	25 deg. C, 65 % RH	TESTED BY	Charles Hsiao

ANTENNA POLARITY & TEST DISTANCE: HORIZONTAL AT 3 M										
FREQ. (MHz)	EMISSION LEVEL (dBuV/m)	READ LEVEL (dBuV)	LIMIT (dBuV/m)	MARGIN (dB)	ANTENNA FACTOR (dB/m)	CABLE LOSS (dB)	PREAMP FACTOR (dB)	ANTENNA HEIGHT (cm)	TABLE ANGLE (Degree)	REMARK
2378	42.65	40.99	54	-11.35	31.78	5.37	35.49	180	90	Average
2378	56.79	55.13	74	-17.21	31.78	5.37	35.49	180	90	Peak
2437	103.81	101.96			31.85	5.46	35.46	180	90	Average
2437	111.51	109.66			31.85	5.46	35.46	180	90	Peak
2486	41.71	39.72	54	-12.29	31.88	5.53	35.42	180	90	Average
2486	55.7	53.71	74	-18.3	31.88	5.53	35.42	180	90	Peak

ANTENNA POLARITY & TEST DISTANCE: VERTICAL AT 3 M										
FREQ. (MHz)	EMISSION LEVEL (dBuV/m)	READ LEVEL (dBuV)	LIMIT (dBuV/m)	MARGIN (dB)	ANTENNA FACTOR (dB/m)	CABLE LOSS (dB)	PREAMP FACTOR (dB)	ANTENNA HEIGHT (cm)	TABLE ANGLE (Degree)	REMARK
2354	42.6	41.01	54	-11.4	31.76	5.33	35.5	101	211	Average
2354	57.3	55.71	74	-16.7	31.76	5.33	35.5	101	211	Peak
2437	102.31	100.46			31.85	5.46	35.46	101	211	Average
2437	110.33	108.48			31.85	5.46	35.46	101	211	Peak
2498	42.23	40.21	54	-11.77	31.9	5.53	35.41	101	211	Average
2498	56.53	54.51	74	-17.47	31.9	5.53	35.41	101	211	Peak

## REMARKS:

- Emission Level = Read Level + Antenna Factor + Cable Loss - Preamp Factor  
Margin value = Emission level – Limit value
- 2437 MHz: Fundamental frequency.



A D T

EUT TEST CONDITION		MEASUREMENT DETAIL	
CHANNEL	Channel 11	FREQUENCY RANGE	1 GHz ~ 25 GHz
INPUT POWER	120 Vac, 60 Hz	DETECTOR FUNCTION	Peak (PK) Average (AV)
ENVIRONMENTAL CONDITIONS	25 deg. C, 65 % RH	TESTED BY	Charles Hsiao

ANTENNA POLARITY & TEST DISTANCE: HORIZONTAL AT 3 M										
FREQ. (MHz)	EMISSION LEVEL (dBuV/m)	READ LEVEL (dBuV)	LIMIT (dBuV/m)	MARGIN (dB)	ANTENNA FACTOR (dB/m)	CABLE LOSS (dB)	PREAMP FACTOR (dB)	ANTENNA HEIGHT (cm)	TABLE ANGLE (Degree)	REMARK
2358	41.03	39.4	54	-12.97	31.76	5.37	35.5	139	94	Average
2358	55.66	54.03	74	-18.34	31.76	5.37	35.5	139	94	Peak
2462	101.36	99.43			31.87	5.5	35.44	139	94	Average
2462	109.13	107.2			31.87	5.5	35.44	139	94	Peak
2484	52.68	50.72	54	-1.32	31.88	5.5	35.42	107	351	Average
2484	68.8	66.84	74	-5.2	31.88	5.5	35.42	107	351	Peak

ANTENNA POLARITY & TEST DISTANCE: VERTICAL AT 3 M										
FREQ. (MHz)	EMISSION LEVEL (dBuV/m)	READ LEVEL (dBuV)	LIMIT (dBuV/m)	MARGIN (dB)	ANTENNA FACTOR (dB/m)	CABLE LOSS (dB)	PREAMP FACTOR (dB)	ANTENNA HEIGHT (cm)	TABLE ANGLE (Degree)	REMARK
2388	41	39.29	54	-13	31.8	5.4	35.49	100	211	Average
2388	56.54	54.83	74	-17.46	31.8	5.4	35.49	100	211	Peak
2462	100.46	98.53			31.87	5.5	35.44	100	211	Average
2462	108.27	106.34			31.87	5.5	35.44	100	211	Peak
2484	51.68	49.72	54	-2.32	31.88	5.5	35.42	100	196	Average
2484	67.68	65.72	74	-6.32	31.88	5.5	35.42	100	196	Peak

## REMARKS:

- Emission Level = Read Level + Antenna Factor + Cable Loss - Preamp Factor  
Margin value = Emission level – Limit value
- 2462 MHz: Fundamental frequency.

**802.11n (HT20)**

EUT TEST CONDITION		MEASUREMENT DETAIL	
CHANNEL	Channel 1	FREQUENCY RANGE	1 GHz ~ 25 GHz
INPUT POWER	120 Vac, 60 Hz	DETECTOR FUNCTION	Peak (PK) Average (AV)
ENVIRONMENTAL CONDITIONS	25 deg. C, 65 % RH	TESTED BY	Charles Hsiao

**ANTENNA POLARITY & TEST DISTANCE: HORIZONTAL AT 3 M**

FREQ. (MHz)	EMISSION LEVEL (dBuV/m)	READ LEVEL (dBuV)	LIMIT (dBuV/m)	MARGIN (dB)	ANTENNA FACTOR (dB/m)	CABLE LOSS (dB)	PREAMP FACTOR (dB)	ANTENNA HEIGHT (cm)	TABLE ANGLE (Degree)	REMARK
2390	52.72	50.99	54	-1.28	31.8	5.4	35.47	111	121	Average
2390	67.05	65.32	74	-6.95	31.8	5.4	35.47	111	121	Peak
2412	101.55	99.78			31.81	5.43	35.47	142	90	Average
2412	108.37	106.6			31.81	5.43	35.47	142	90	Peak
2484	40.88	38.92	54	-13.12	31.88	5.5	35.42	142	90	Average
2484	55.55	53.59	74	-18.45	31.88	5.5	35.42	142	90	Peak

**ANTENNA POLARITY & TEST DISTANCE: VERTICAL AT 3 M**

FREQ. (MHz)	EMISSION LEVEL (dBuV/m)	READ LEVEL (dBuV)	LIMIT (dBuV/m)	MARGIN (dB)	ANTENNA FACTOR (dB/m)	CABLE LOSS (dB)	PREAMP FACTOR (dB)	ANTENNA HEIGHT (cm)	TABLE ANGLE (Degree)	REMARK
2390	50	48.27	54	-4	31.8	5.4	35.47	102	194	Average
2390	63.64	61.91	74	-10.36	31.8	5.4	35.47	102	194	Peak
2412	100.25	98.48			31.81	5.43	35.47	102	211	Average
2412	107.48	105.71			31.81	5.43	35.47	102	211	Peak
2490	41.23	39.22	54	-12.77	31.9	5.53	35.42	102	211	Average
2490	55.12	53.11	74	-18.88	31.9	5.53	35.42	102	211	Peak

**REMARKS:**

- Emission Level = Read Level + Antenna Factor + Cable Loss - Preamp Factor  
Margin value = Emission level – Limit value
- 2412 MHz: Fundamental frequency.



A D T

EUT TEST CONDITION		MEASUREMENT DETAIL	
CHANNEL	Channel 6	FREQUENCY RANGE	1 GHz ~ 25 GHz
INPUT POWER	120 Vac, 60 Hz	DETECTOR FUNCTION	Peak (PK) Average (AV)
ENVIRONMENTAL CONDITIONS	25 deg. C, 65 % RH	TESTED BY	Charles Hsiao

ANTENNA POLARITY & TEST DISTANCE: HORIZONTAL AT 3 M										
FREQ. (MHz)	EMISSION LEVEL (dBuV/m)	READ LEVEL (dBuV)	LIMIT (dBuV/m)	MARGIN (dB)	ANTENNA FACTOR (dB/m)	CABLE LOSS (dB)	PREAMP FACTOR (dB)	ANTENNA HEIGHT (cm)	TABLE ANGLE (Degree)	REMARK
2388	42.7	40.99	54	-11.3	31.8	5.4	35.49	140	90	Average
2388	56.66	54.95	74	-17.34	31.8	5.4	35.49	140	90	Peak
2437	104.41	102.56			31.85	5.46	35.46	140	90	Average
2437	112.91	111.06			31.85	5.46	35.46	140	90	Peak
2492	42.43	40.41	54	-11.57	31.9	5.53	35.41	140	90	Average
2492	55.19	53.17	74	-18.81	31.9	5.53	35.41	140	90	Peak

ANTENNA POLARITY & TEST DISTANCE: VERTICAL AT 3 M										
FREQ. (MHz)	EMISSION LEVEL (dBuV/m)	READ LEVEL (dBuV)	LIMIT (dBuV/m)	MARGIN (dB)	ANTENNA FACTOR (dB/m)	CABLE LOSS (dB)	PREAMP FACTOR (dB)	ANTENNA HEIGHT (cm)	TABLE ANGLE (Degree)	REMARK
2390	43.5	41.77	54	-10.5	31.8	5.4	35.47	101	211	Average
2390	56.47	54.74	74	-17.53	31.8	5.4	35.47	101	211	Peak
2437	103.81	101.96			31.85	5.46	35.46	101	211	Average
2437	111.26	109.41			31.85	5.46	35.46	101	211	Peak
2500	42.23	40.21	54	-11.77	31.9	5.53	35.41	101	211	Average
2500	56.03	54.01	74	-17.97	31.9	5.53	35.41	101	211	Peak

## REMARKS:

- Emission Level = Read Level + Antenna Factor + Cable Loss - Preamp Factor  
Margin value = Emission level – Limit value
- 2437 MHz: Fundamental frequency.



EUT TEST CONDITION		MEASUREMENT DETAIL	
CHANNEL	Channel 11	FREQUENCY RANGE	1 GHz ~ 25 GHz
INPUT POWER	120 Vac, 60 Hz	DETECTOR FUNCTION	Peak (PK) Average (AV)
ENVIRONMENTAL CONDITIONS	25 deg. C, 65 % RH	TESTED BY	Charles Hsiao

ANTENNA POLARITY & TEST DISTANCE: HORIZONTAL AT 3 M										
FREQ. (MHz)	EMISSION LEVEL (dBuV/m)	READ LEVEL (dBuV)	LIMIT (dBuV/m)	MARGIN (dB)	ANTENNA FACTOR (dB/m)	CABLE LOSS (dB)	PREAMP FACTOR (dB)	ANTENNA HEIGHT (cm)	TABLE ANGLE (Degree)	REMARK
2384	40.98	39.29	54	-13.02	31.78	5.4	35.49	121	98	Average
2384	55	53.31	74	-19	31.78	5.4	35.49	121	98	Peak
2462	100.06	98.13			31.87	5.5	35.44	121	98	Average
2462	107.25	105.32			31.87	5.5	35.44	121	98	Peak
<b>2486</b>	<b>53</b>	<b>51.01</b>	<b>54</b>	<b>-1</b>	<b>31.88</b>	<b>5.53</b>	<b>35.42</b>	<b>178</b>	<b>74</b>	<b>Average</b>
2486	66.88	64.89	74	-7.12	31.88	5.53	35.42	178	74	Peak

ANTENNA POLARITY & TEST DISTANCE: VERTICAL AT 3 M										
FREQ. (MHz)	EMISSION LEVEL (dBuV/m)	READ LEVEL (dBuV)	LIMIT (dBuV/m)	MARGIN (dB)	ANTENNA FACTOR (dB/m)	CABLE LOSS (dB)	PREAMP FACTOR (dB)	ANTENNA HEIGHT (cm)	TABLE ANGLE (Degree)	REMARK
2370	40.65	38.99	54	-13.35	31.78	5.37	35.49	100	211	Average
2370	54.8	53.14	74	-19.2	31.78	5.37	35.49	100	211	Peak
2462	99.41	97.48			31.87	5.5	35.44	100	211	Average
2462	106.26	104.33			31.87	5.5	35.44	100	211	Peak
2484	52.06	50.1	54	-1.94	31.88	5.5	35.42	100	205	Average
2484	66.02	64.06	74	-7.98	31.88	5.5	35.42	100	205	Peak

REMARKS:

- Emission Level = Read Level + Antenna Factor + Cable Loss - Preamp Factor  
Margin value = Emission level – Limit value
- 2462 MHz: Fundamental frequency.

**802.11n (HT40)**

EUT TEST CONDITION		MEASUREMENT DETAIL	
CHANNEL	Channel 3	FREQUENCY RANGE	1 GHz ~ 25 GHz
INPUT POWER	120 Vac, 60 Hz	DETECTOR FUNCTION	Peak (PK) Average (AV)
ENVIRONMENTAL CONDITIONS	25 deg. C, 65 % RH	TESTED BY	Charles Hsiao

**ANTENNA POLARITY & TEST DISTANCE: HORIZONTAL AT 3 M**

FREQ. (MHz)	EMISSION LEVEL (dBuV/m)	READ LEVEL (dBuV)	LIMIT (dBuV/m)	MARGIN (dB)	ANTENNA FACTOR (dB/m)	CABLE LOSS (dB)	PREAMP FACTOR (dB)	ANTENNA HEIGHT (cm)	TABLE ANGLE (Degree)	REMARK
2390	52.99	51.26	54	-1.01	31.8	5.4	35.47	112	45	Average
2390	66.34	64.61	74	-7.66	31.8	5.4	35.47	112	45	Peak
2422	94.06	92.26			31.83	5.43	35.46	142	90	Average
2422	101.87	100.07			31.83	5.43	35.46	142	90	Peak
2496	41.63	39.61	54	-12.37	31.9	5.53	35.41	142	90	Average
2496	55.48	53.46	74	-18.52	31.9	5.53	35.41	142	90	Peak

**ANTENNA POLARITY & TEST DISTANCE: VERTICAL AT 3 M**

FREQ. (MHz)	EMISSION LEVEL (dBuV/m)	READ LEVEL (dBuV)	LIMIT (dBuV/m)	MARGIN (dB)	ANTENNA FACTOR (dB/m)	CABLE LOSS (dB)	PREAMP FACTOR (dB)	ANTENNA HEIGHT (cm)	TABLE ANGLE (Degree)	REMARK
2390	52.4	50.67	54	-1.6	31.8	5.4	35.47	102	257	Average
2390	62.78	61.05	74	-11.22	31.8	5.4	35.47	102	257	Peak
2422	93.26	91.46			31.83	5.43	35.46	102	211	Average
2422	100.91	99.11			31.83	5.43	35.46	102	211	Peak
2484	41.38	39.42	54	-12.62	31.88	5.5	35.42	102	211	Average
2484	56.15	54.19	74	-17.85	31.88	5.5	35.42	102	211	Peak

**REMARKS:**

- Emission Level = Read Level + Antenna Factor + Cable Loss - Preamp Factor  
Margin value = Emission level – Limit value
- 2422 MHz: Fundamental frequency.



A D T

EUT TEST CONDITION		MEASUREMENT DETAIL	
CHANNEL	Channel 6	FREQUENCY RANGE	1 GHz ~ 25 GHz
INPUT POWER	120 Vac, 60 Hz	DETECTOR FUNCTION	Peak (PK) Average (AV)
ENVIRONMENTAL CONDITIONS	25 deg. C, 65 % RH	TESTED BY	Charles Hsiao

ANTENNA POLARITY & TEST DISTANCE: HORIZONTAL AT 3 M										
FREQ. (MHz)	EMISSION LEVEL (dBuV/m)	READ LEVEL (dBuV)	LIMIT (dBuV/m)	MARGIN (dB)	ANTENNA FACTOR (dB/m)	CABLE LOSS (dB)	PREAMP FACTOR (dB)	ANTENNA HEIGHT (cm)	TABLE ANGLE (Degree)	REMARK
2388	52.9	51.19	54	-1.1	31.8	5.4	35.49	100	85	Average
2388	66.09	64.38	74	-7.91	31.8	5.4	35.49	100	85	Peak
2437	99.31	97.46			31.85	5.46	35.46	178	90	Average
2437	106.56	104.71			31.85	5.46	35.46	178	90	Peak
2484	46.18	44.22	54	-7.82	31.88	5.5	35.42	178	90	Average
2484	56.71	54.75	74	-17.29	31.88	5.5	35.42	178	90	Peak

ANTENNA POLARITY & TEST DISTANCE: VERTICAL AT 3 M										
FREQ. (MHz)	EMISSION LEVEL (dBuV/m)	READ LEVEL (dBuV)	LIMIT (dBuV/m)	MARGIN (dB)	ANTENNA FACTOR (dB/m)	CABLE LOSS (dB)	PREAMP FACTOR (dB)	ANTENNA HEIGHT (cm)	TABLE ANGLE (Degree)	REMARK
2390	48.87	47.14	54	-5.13	31.8	5.4	35.47	103	226	Average
2390	61.21	59.48	74	-12.79	31.8	5.4	35.47	103	226	Peak
2437	98.31	96.46			31.85	5.46	35.46	100	211	Average
2437	105.76	103.91			31.85	5.46	35.46	100	211	Peak
2490	44.23	42.22	54	-9.77	31.9	5.53	35.42	100	211	Average
2490	57.11	55.1	74	-16.89	31.9	5.53	35.42	100	211	Peak

## REMARKS:

- Emission Level = Read Level + Antenna Factor + Cable Loss - Preamp Factor  
Margin value = Emission level – Limit value
- 2437 MHz: Fundamental frequency.





A D T

EUT TEST CONDITION		MEASUREMENT DETAIL	
CHANNEL	Channel 9	FREQUENCY RANGE	1 GHz ~ 25 GHz
INPUT POWER	120 Vac, 60 Hz	DETECTOR FUNCTION	Peak (PK) Average (AV)
ENVIRONMENTAL CONDITIONS	25 deg. C, 65 % RH	TESTED BY	Charles Hsiao

ANTENNA POLARITY & TEST DISTANCE: HORIZONTAL AT 3 M										
FREQ. (MHz)	EMISSION LEVEL (dBuV/m)	READ LEVEL (dBuV)	LIMIT (dBuV/m)	MARGIN (dB)	ANTENNA FACTOR (dB/m)	CABLE LOSS (dB)	PREAMP FACTOR (dB)	ANTENNA HEIGHT (cm)	TABLE ANGLE (Degree)	REMARK
2390	41.2	39.47	54	-12.8	31.8	5.4	35.47	155	96	Average
2390	55.58	53.85	74	-18.42	31.8	5.4	35.47	155	96	Peak
2452	94.26	92.39			31.85	5.46	35.44	155	96	Average
2452	101.13	99.26			31.85	5.46	35.44	155	96	Peak
2484	52.88	50.92	54	-1.12	31.88	5.5	35.42	174	92	Average
2484	64.72	62.76	74	-9.28	31.88	5.5	35.42	174	92	Peak

ANTENNA POLARITY & TEST DISTANCE: VERTICAL AT 3 M										
FREQ. (MHz)	EMISSION LEVEL (dBuV/m)	READ LEVEL (dBuV)	LIMIT (dBuV/m)	MARGIN (dB)	ANTENNA FACTOR (dB/m)	CABLE LOSS (dB)	PREAMP FACTOR (dB)	ANTENNA HEIGHT (cm)	TABLE ANGLE (Degree)	REMARK
2326	40.93	39.42	54	-13.07	31.73	5.3	35.52	100	211	Average
2326	54.94	53.43	74	-19.06	31.73	5.3	35.52	100	211	Peak
2452	92.31	90.44			31.85	5.46	35.44	100	211	Average
2452	100.35	98.48			31.85	5.46	35.44	100	211	Peak
2486	51.21	49.22	54	-2.79	31.88	5.53	35.42	100	219	Average
2486	63.89	61.9	74	-10.11	31.88	5.53	35.42	100	219	Peak

## REMARKS:

- Emission Level = Read Level + Antenna Factor + Cable Loss - Preamp Factor  
Margin value = Emission level – Limit value
- 2452 MHz: Fundamental frequency.

### 9 kHz ~ 30 MHz DATA:

The amplitude of spurious emissions attenuated more than 20 dB below the permissible value is not required to be report.

### 30 MHz ~ 1 GHz WORST-CASE DATA:

#### Mode A

#### 802.11n (HT40)

EUT TEST CONDITION		MEASUREMENT DETAIL	
CHANNEL	Channel 9	FREQUENCY RANGE	30 MHz ~ 1 GHz
INPUT POWER	120 Vac, 60 Hz	DETECTOR FUNCTION	Peak (PK)
ENVIRONMENTAL CONDITIONS	25 deg. C, 65 % RH	TESTED BY	Charles Hsiao

#### ANTENNA POLARITY & TEST DISTANCE: HORIZONTAL AT 3 M

FREQ. (MHz)	EMISSION LEVEL (dBuV/m)	READ LEVEL (dBuV)	LIMIT (dBuV/m)	MARGIN (dB)	ANTENNA FACTOR (dB/m)	CABLE LOSS (dB)	PREAMP FACTOR (dB)	ANTENNA HEIGHT (cm)	TABLE ANGLE (Degree)	REMARK
99.93	34.09	52.79	43.5	-9.41	12.28	1.28	32.26	158	124	Peak
200.1	41.45	61.02	43.5	-2.05	11.08	1.65	32.3	116	135	Peak
300	44.06	61.11	46	-1.94	13.06	2.03	32.14	157	186	Peak
499.5	38.78	51.9	46	-7.22	16.35	2.63	32.1	163	187	Peak
700.4	32.72	42.46	46	-13.28	19.24	3.11	32.09	112	175	Peak
896.4	32.4	38.98	46	-13.6	21.44	3.49	31.51	166	135	Peak

#### ANTENNA POLARITY & TEST DISTANCE: VERTICAL AT 3 M

FREQ. (MHz)	EMISSION LEVEL (dBuV/m)	READ LEVEL (dBuV)	LIMIT (dBuV/m)	MARGIN (dB)	ANTENNA FACTOR (dB/m)	CABLE LOSS (dB)	PREAMP FACTOR (dB)	ANTENNA HEIGHT (cm)	TABLE ANGLE (Degree)	REMARK
99.93	24	42.7	43.5	-19.5	12.28	1.28	32.26	163	159	Peak
200.1	31.35	50.92	43.5	-12.15	11.08	1.65	32.3	125	185	Peak
300	43.34	60.39	46	-2.66	13.06	2.03	32.14	133	168	Peak
499.5	29.58	42.7	46	-16.42	16.35	2.63	32.1	158	111	Peak
700.4	29.87	39.61	46	-16.13	19.24	3.11	32.09	175	196	Peak
898.5	28.68	35.23	46	-17.32	21.45	3.49	31.49	136	215	Peak

#### REMARKS:

- Emission Level = Read Level + Antenna Factor + Cable Loss - Preamp Factor  
Margin value = Emission level – Limit value

**Mode B**
**802.11n (HT20)**

EUT TEST CONDITION		MEASUREMENT DETAIL	
CHANNEL	Channel 11	FREQUENCY RANGE	30 MHz ~ 1 GHz
INPUT POWER	120 Vac, 60 Hz	DETECTOR FUNCTION	Peak (PK) Quasi-peak (QP)
ENVIRONMENTAL CONDITIONS	25 deg. C, 65 % RH	TESTED BY	Charles Hsiao

**ANTENNA POLARITY & TEST DISTANCE: HORIZONTAL AT 3 M**

FREQ. (MHz)	EMISSION LEVEL (dBuV/m)	READ LEVEL (dBuV)	LIMIT (dBuV/m)	MARGIN (dB)	ANTENNA FACTOR (dB/m)	CABLE LOSS (dB)	PREAMP FACTOR (dB)	ANTENNA HEIGHT (cm)	TABLE ANGLE (Degree)	REMARK
99.93	34.03	52.73	43.5	-9.47	12.28	1.28	32.26	113	254	Peak
199.29	41.92	61.49	43.5	-1.58	11.08	1.65	32.3	185	326	Peak
298.92	43.86	60.93	46	-2.14	13.04	2.03	32.14	167	176	QP
497.4	38.07	51.22	46	-7.93	16.32	2.63	32.1	175	188	Peak
700.4	30.96	40.7	46	-15.04	19.24	3.11	32.09	136	274	Peak
896.4	32.35	38.93	46	-13.65	21.44	3.49	31.51	166	175	Peak

**ANTENNA POLARITY & TEST DISTANCE: VERTICAL AT 3 M**

FREQ. (MHz)	EMISSION LEVEL (dBuV/m)	READ LEVEL (dBuV)	LIMIT (dBuV/m)	MARGIN (dB)	ANTENNA FACTOR (dB/m)	CABLE LOSS (dB)	PREAMP FACTOR (dB)	ANTENNA HEIGHT (cm)	TABLE ANGLE (Degree)	REMARK
99.93	23.29	41.99	43.5	-20.21	12.28	1.28	32.26	129	279	Peak
200.1	30.84	50.41	43.5	-12.66	11.08	1.65	32.3	145	245	Peak
298.92	42.84	59.91	46	-3.16	13.04	2.03	32.14	172	331	Peak
498.1	29.58	42.72	46	-16.42	16.33	2.63	32.1	125	174	Peak
700.4	29.31	39.05	46	-16.69	19.24	3.11	32.09	115	116	Peak
915.3	30.26	36.56	46	-15.74	21.54	3.53	31.37	198	175	Peak

**REMARKS:**

1. Emission Level = Read Level + Antenna Factor + Cable Loss - Preamp Factor

Margin value = Emission level – Limit value

## 4.2 Conducted Emission Measurement

### 4.2.1 Limits of Conducted Emission Measurement

Frequency (MHz)	Conducted Limit (dBuV)	
	Quasi-peak	Average
0.15 - 0.5	66 - 56	56 - 46
0.50 - 5.0	56	46
5.0 - 30.0	60	50

Note: 1. The lower limit shall apply at the transition frequencies.

2. The limit decreases in line with the logarithm of the frequency in the range of 0.15 to 0.50 MHz.

### 4.2.2 Test Instruments

Description & Manufacturer	Model No.	Serial No.	Date of Calibration	Due Date of Calibration
Test Receiver ROHDE & SCHWARZ	ESCI	100613	Nov. 16, 2015	Nov. 15, 2016
RF signal cable Woken	5D-FB	Cable-cond1-01	Dec. 26, 2014	Dec. 25, 2015
LISN ROHDE & SCHWARZ (EUT)	ESH3-Z5	835239/001	Feb. 26, 2015	Feb. 25, 2016
LISN ROHDE & SCHWARZ (Peripheral)	ESH3-Z5	100311	Jul. 24, 2015	Jul. 23, 2016
Software ADT	BV ADT_Cond_ V7.3.7.3	NA	NA	NA

Note: 1. The calibration interval of the above test instruments is 12 months and the calibrations are traceable to NML/ROC and NIST/USA.

2. The test was performed in HwaYa Shielded Room 1.

3. The VCCI Site Registration No. is C-2040.

#### 4.2.3 Test Procedures

- The EUT was placed 0.4 meters from the conducting wall of the shielded room with EUT being connected to the power mains through a line impedance stabilization network (LISN). Other support units were connected to the power mains through another LISN. The two LISNs provide 50 ohm/50 uH of coupling impedance for the measuring instrument.
- Both lines of the power mains connected to the EUT were checked for maximum conducted interference.
- The frequency range from 150 kHz to 30 MHz was searched. Emission levels under (Limit – 20 dB) was not recorded.

**NOTE:** All modes of operation were investigated and the worst-case emissions are reported.

#### 4.2.4 Deviation from Test Standard

No deviation.

#### 4.2.5 Test Setup

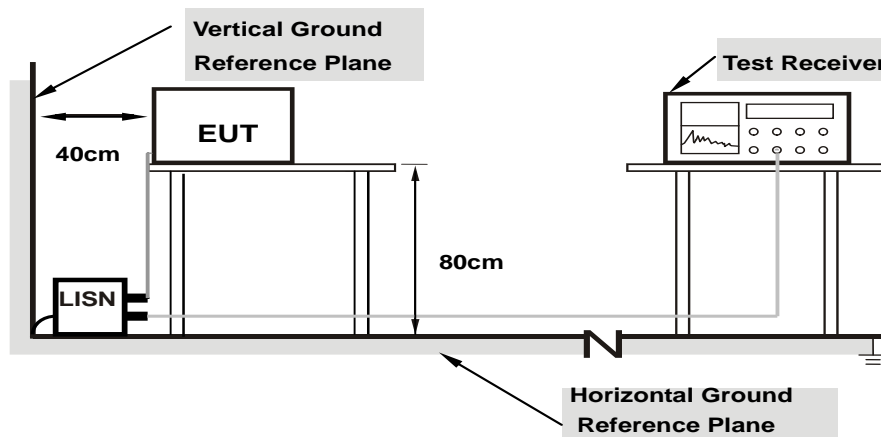

**Note: 1. Support units were connected to second LISN.**

For the actual test configuration, please refer to the attached file (Test Setup Photo).

#### 4.2.6 EUT Operating Conditions

- Placed the EUT on a testing table.
- Use the software to control the EUT under transmission condition continuously at specific channel frequency.

#### 4.2.7 Test Results

##### Mode A

Frequency Range	150kHz ~ 30MHz	Detector Function & Resolution Bandwidth	Quasi-Peak (QP) / Average (AV), 9kHz
Input Power	120Vac, 60Hz	Environmental Conditions	25°C, 65%RH
Tested by	Toby Tian	Test Date	2015/12/15

Phase Of Power : Line (L)										
No	Frequency (MHz)	Correction Factor (dB)	Reading Value (dBuV)		Emission Level (dBuV)		Limit (dBuV)		Margin (dB)	
			Q.P.	AV.	Q.P.	AV.	Q.P.	AV.	Q.P.	AV.
1	0.15760	9.82	31.47	15.84	41.29	25.66	65.59	55.59	-24.30	-29.93
<b>2</b>	<b>0.18519</b>	<b>9.83</b>	<b>42.29</b>	<b>25.50</b>	<b>52.12</b>	<b>35.33</b>	<b>64.25</b>	<b>54.25</b>	<b>-12.13</b>	<b>-18.92</b>
3	0.24796	9.85	34.99	19.94	44.84	29.79	61.83	51.83	-16.99	-22.04
4	0.36896	9.87	24.86	9.16	34.73	19.03	58.52	48.52	-23.79	-29.49
5	1.96424	10.00	25.38	15.17	35.38	25.17	56.00	46.00	-20.62	-20.83
6	3.98567	10.13	20.87	13.44	31.00	23.57	56.00	46.00	-25.00	-22.43

#### Remarks:

1. Q.P. and AV. are abbreviations of quasi-peak and average individually.
2. The emission levels of other frequencies were very low against the limit.
3. Margin value = Emission level – Limit value
4. Correction factor = Insertion loss + Cable loss
5. Emission Level = Correction Factor + Reading Value

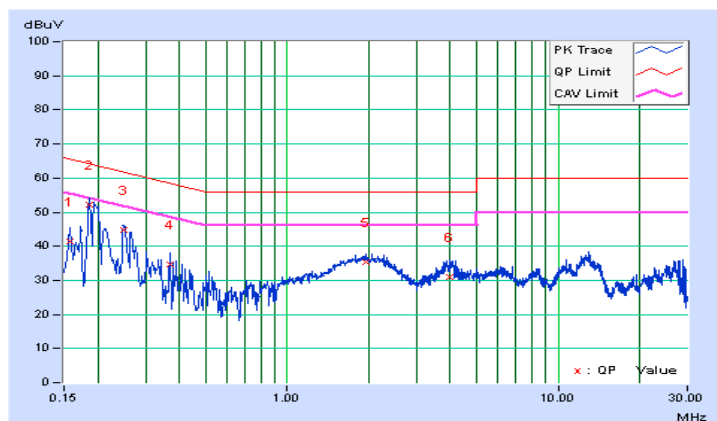

Frequency Range	150kHz ~ 30MHz	Detector Function & Resolution Bandwidth	Quasi-Peak (QP) / Average (AV), 9kHz
Input Power	120Vac, 60Hz	Environmental Conditions	25°C, 65%RH
Tested by	Toby Tian	Test Date	2015/12/15

Phase Of Power : Neutral (N)										
No	Frequency (MHz)	Correction Factor (dB)	Reading Value (dBuV)		Emission Level (dBuV)		Limit (dBuV)		Margin (dB)	
			Q.P.	AV.	Q.P.	AV.	Q.P.	AV.	Q.P.	AV.
1	0.15391	9.82	32.04	20.39	41.86	30.21	65.79	55.79	-23.93	-25.58
2	0.19717	9.83	40.34	25.07	50.17	34.90	63.73	53.73	-13.56	-18.83
3	0.25557	9.84	32.94	18.09	42.78	27.93	61.57	51.57	-18.79	-23.64
4	0.30249	9.86	27.81	10.50	37.67	20.36	60.17	50.17	-22.51	-29.82
5	2.07372	10.00	22.33	12.61	32.33	22.61	56.00	46.00	-23.67	-23.39
6	13.82718	10.65	21.32	14.07	31.97	24.72	60.00	50.00	-28.03	-25.28

Remarks:

1. Q.P. and AV. are abbreviations of quasi-peak and average individually.
2. The emission levels of other frequencies were very low against the limit.
3. Margin value = Emission level – Limit value
4. Correction factor = Insertion loss + Cable loss
5. Emission Level = Correction Factor + Reading Value

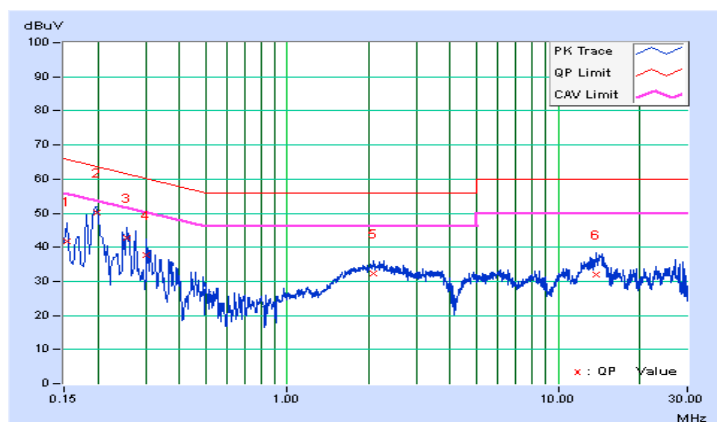

**Mode B**

Frequency Range	150kHz ~ 30MHz	Detector Function & Resolution Bandwidth	Quasi-Peak (QP) / Average (AV), 9kHz
Input Power	120Vac, 60Hz	Environmental Conditions	25°C, 65%RH
Tested by	Toby Tian	Test Date	2015/12/15

Phase Of Power : Line (L)										
No	Frequency (MHz)	Correction Factor (dB)	Reading Value (dBuV)		Emission Level (dBuV)		Limit (dBuV)		Margin (dB)	
			Q.P.	AV.	Q.P.	AV.	Q.P.	AV.	Q.P.	AV.
1	0.18519	9.83	41.15	24.73	50.98	34.56	64.25	54.25	-13.27	-19.69
2	0.26339	9.85	31.87	17.73	41.72	27.58	61.32	51.32	-19.60	-23.74
3	0.31422	9.86	29.11	14.50	38.97	24.36	59.86	49.86	-20.89	-25.50
4	0.38851	9.88	23.17	9.43	33.05	19.31	58.10	48.10	-25.05	-28.79
5	2.09718	10.01	24.05	14.22	34.06	24.23	56.00	46.00	-21.94	-21.77
6	12.54861	10.66	22.09	16.37	32.75	27.03	60.00	50.00	-27.25	-22.97

**Remarks:**

1. Q.P. and AV. are abbreviations of quasi-peak and average individually.
2. The emission levels of other frequencies were very low against the limit.
3. Margin value = Emission level – Limit value
4. Correction factor = Insertion loss + Cable loss
5. Emission Level = Correction Factor + Reading Value

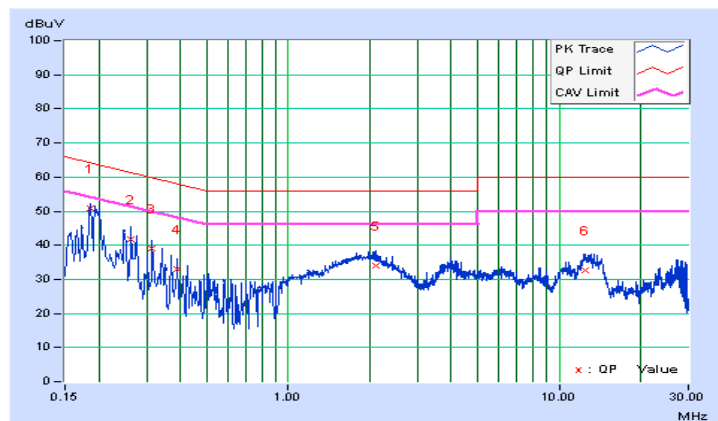



Frequency Range	150kHz ~ 30MHz	Detector Function & Resolution Bandwidth	Quasi-Peak (QP) / Average (AV), 9kHz
Input Power	120Vac, 60Hz	Environmental Conditions	25°C, 65%RH
Tested by	Toby Tian	Test Date	2015/12/15

Phase Of Power : Neutral (N)										
No	Frequency (MHz)	Correction Factor (dB)	Reading Value (dBuV)		Emission Level (dBuV)		Limit (dBuV)		Margin (dB)	
			Q.P.	AV.	Q.P.	AV.	Q.P.	AV.	Q.P.	AV.
1	0.18910	9.83	41.05	25.55	50.88	35.38	64.08	54.08	-13.20	-18.70
2	0.25932	9.84	32.42	17.55	42.26	27.39	61.45	51.45	-19.19	-24.06
3	0.30640	9.86	28.58	12.99	38.44	22.85	60.07	50.07	-21.63	-27.22
4	0.37287	9.87	22.99	9.16	32.86	19.03	58.44	48.44	-25.57	-29.40
5	2.44908	10.02	21.65	12.68	31.67	22.70	56.00	46.00	-24.33	-23.30
6	14.53880	10.68	21.53	14.20	32.21	24.88	60.00	50.00	-27.79	-25.12

Remarks:

1. Q.P. and AV. are abbreviations of quasi-peak and average individually.
2. The emission levels of other frequencies were very low against the limit.
3. Margin value = Emission level – Limit value
4. Correction factor = Insertion loss + Cable loss
5. Emission Level = Correction Factor + Reading Value

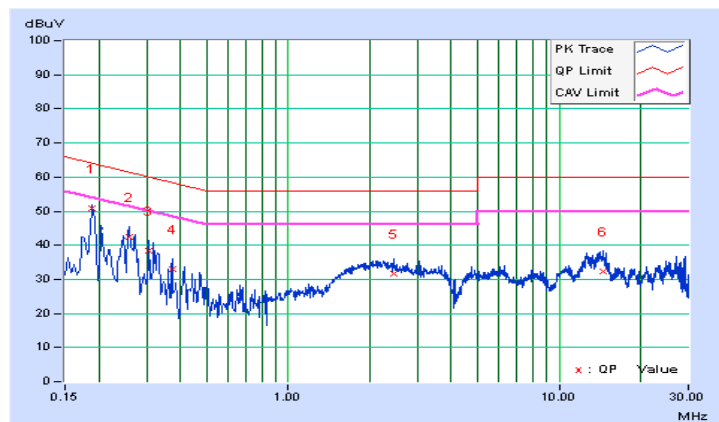

### 4.3 6 dB Bandwidth Measurement

#### 4.3.1 Limits of 6 dB Bandwidth Measurement

The minimum of 6 dB Bandwidth Measurement is 0.5 MHz.

#### 4.3.2 Test Setup

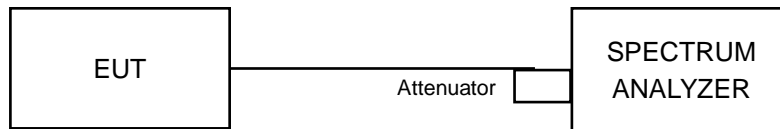

#### 4.3.3 Test Instruments

Refer to section 4.1.2 to get information of above instrument.

#### 4.3.4 Test Procedure

- Set resolution bandwidth (RBW) = 100 kHz
- Set the video bandwidth (VBW)  $\geq 3 \times$  RBW, Detector = Peak.
- Trace mode = max hold.
- Sweep = auto couple.
- Measure the maximum width of the emission that is constrained by the frequencies associated with the two amplitude points (upper and lower) that are attenuated by 6 dB relative to the maximum level measured in the fundamental emission

#### 4.3.5 Deviation from Test Standard

No deviation.

#### 4.3.6 EUT Operating Conditions

The software provided by client to enable the EUT under transmission condition continuously at lowest, middle and highest channel frequencies individually.

#### 4.3.7 Test Result

##### Mode A

##### 802.11b

Channel	Frequency (MHz)	6 db Bandwidth (MHz)			Minimum Limit (MHz)	Pass / Fail
		Chain 0	Chain 1	Chain 2		
1	2412	10.11	10.12	10.10	0.5	Pass
6	2437	10.11	10.11	10.11	0.5	Pass
11	2462	10.10	10.10	10.09	0.5	Pass

##### 802.11g

Channel	Frequency (MHz)	6 db Bandwidth (MHz)			Minimum Limit (MHz)	Pass / Fail
		Chain 0	Chain 1	Chain 2		
1	2412	16.36	16.38	16.38	0.5	Pass
6	2437	16.36	16.37	16.37	0.5	Pass
11	2462	16.40	16.39	16.40	0.5	Pass

##### 802.11n (HT20)

Channel	Frequency (MHz)	6 db Bandwidth (MHz)			Minimum Limit (MHz)	Pass / Fail
		Chain 0	Chain 1	Chain 2		
1	2412	17.56	17.58	17.57	0.5	Pass
6	2437	17.33	17.59	17.60	0.5	Pass
11	2462	17.57	17.59	17.59	0.5	Pass

##### 802.11n (HT40)

Channel	Frequency (MHz)	6 db Bandwidth (MHz)			Minimum Limit (MHz)	Pass / Fail
		Chain 0	Chain 1	Chain 2		
3	2422	36.17	36.32	35.80	0.5	Pass
6	2437	36.10	35.28	36.90	0.5	Pass
9	2452	36.09	36.27	35.83	0.5	Pass

### Spectrum Plot of Worst Value

#### 802.11b

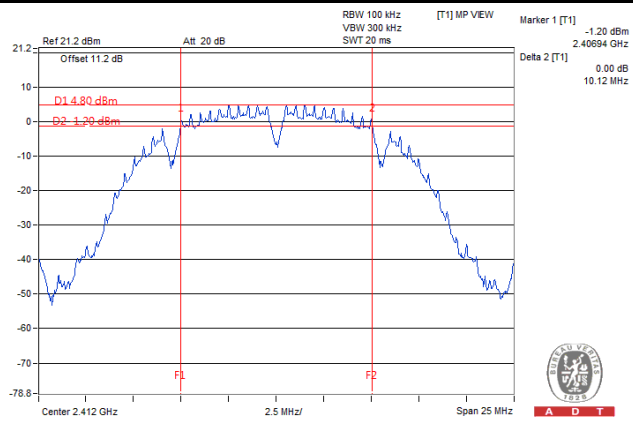

#### 802.11g

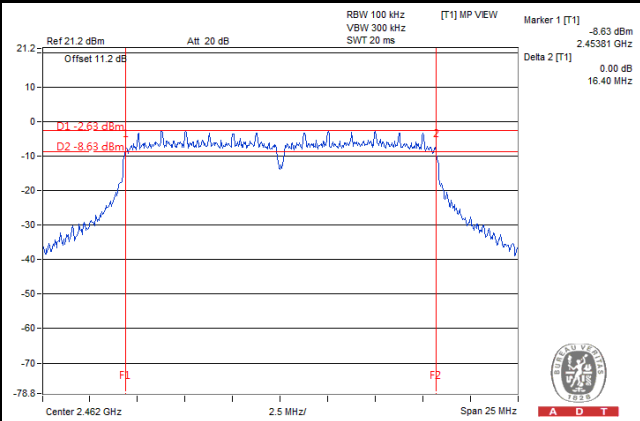

#### 802.11n (HT20)

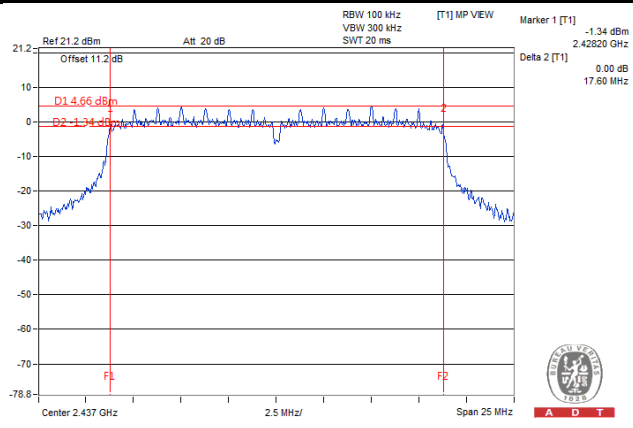

#### 802.11n (HT40)

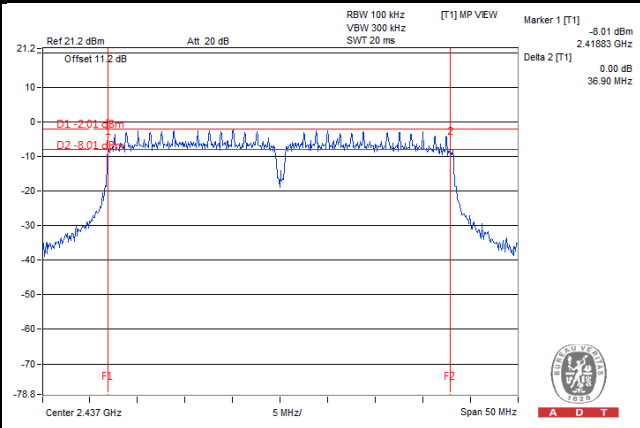

**Mode B**
**802.11b**

Channel	Frequency (MHz)	6 db Bandwidth (MHz)			Minimum Limit (MHz)	Pass / Fail
		Chain 0	Chain 1	Chain 2		
1	2412	10.11	10.12	10.10	0.5	Pass
6	2437	10.11	10.11	10.11	0.5	Pass
11	2462	10.10	10.10	10.09	0.5	Pass

**802.11g**

Channel	Frequency (MHz)	6 db Bandwidth (MHz)			Minimum Limit (MHz)	Pass / Fail
		Chain 0	Chain 1	Chain 2		
1	2412	16.36	16.38	16.38	0.5	Pass
6	2437	16.36	16.37	16.37	0.5	Pass
11	2462	16.37	16.37	16.39	0.5	Pass

**802.11n (HT20)**

Channel	Frequency (MHz)	6 db Bandwidth (MHz)			Minimum Limit (MHz)	Pass / Fail
		Chain 0	Chain 1	Chain 2		
1	2412	17.56	17.58	17.57	0.5	Pass
6	2437	17.33	17.59	17.60	0.5	Pass
11	2462	17.55	17.60	17.34	0.5	Pass

**802.11n (HT40)**

Channel	Frequency (MHz)	6 db Bandwidth (MHz)			Minimum Limit (MHz)	Pass / Fail
		Chain 0	Chain 1	Chain 2		
3	2422	36.08	36.40	35.84	0.5	Pass
6	2437	36.05	35.27	35.82	0.5	Pass
9	2452	36.10	36.32	35.88	0.5	Pass

### Spectrum Plot of Worst Value

#### 802.11b

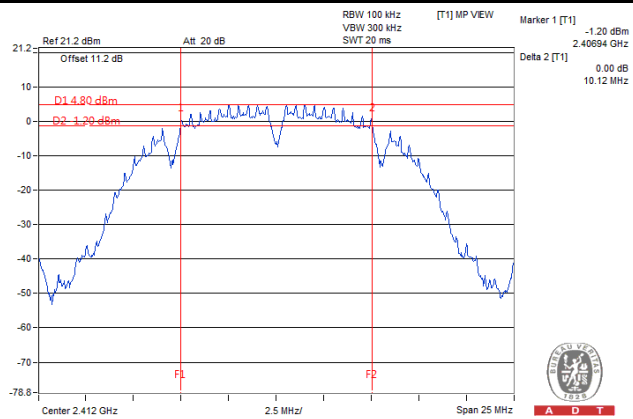

#### 802.11g

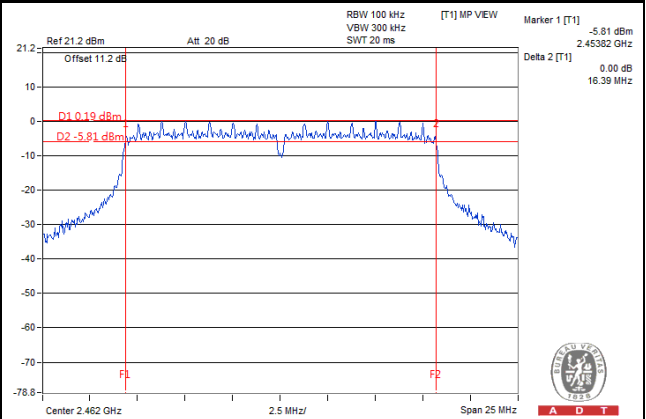

#### 802.11n (HT20)

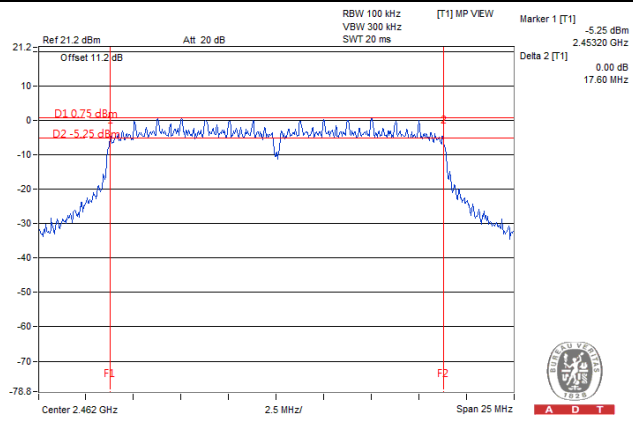

#### 802.11n (HT40)

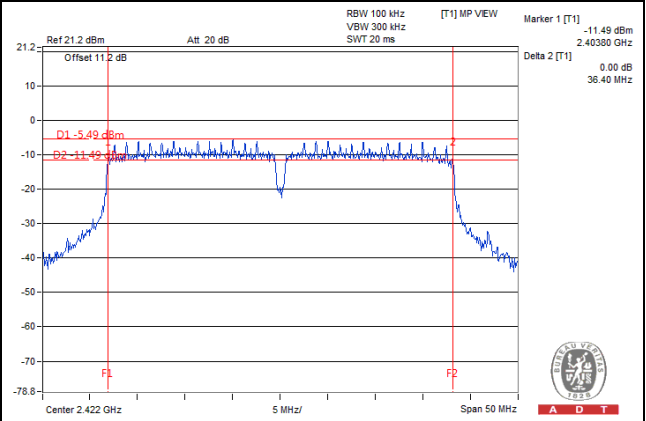

## 4.4 Conducted Output Power Measurement

### 4.4.1 Limits of Conducted Output Power Measurement

For systems using digital modulation in the 2400–2483.5 MHz bands: 1 Watt (30 dBm)

Per KDB 662911 D01 Multiple Transmitter Output Method of conducted output power measurement on IEEE 802.11 devices,

Array Gain = 0 dB (i.e., no array gain) for NANT  $\leq$  4;

Array Gain = 0 dB (i.e., no array gain) for channel widths  $\geq$  40 MHz for any NANT;

Array Gain =  $5 \log(\text{NANT}/\text{NSS})$  dB or 3 dB, whichever is less for 20 MHz channel widths with NANT  $\geq$  5.

For power measurements on all other devices: Array Gain =  $10 \log(\text{NANT}/\text{NSS})$  dB.

### 4.4.2 Test Setup

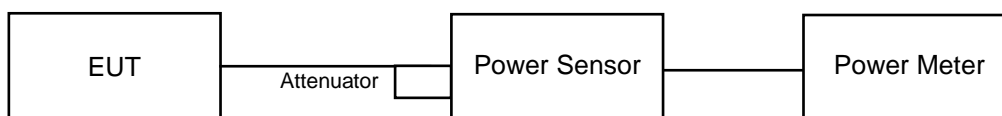

### 4.4.3 Test Instruments

Refer to section 4.1.2 to get information of above instrument.

### 4.4.4 Test Procedures

A peak power sensor was used on the output port of the EUT. A power meter was used to read the response of the peak power sensor. Record the power level.

### 4.4.5 Deviation from Test Standard

No deviation.

### 4.4.6 EUT Operating Conditions

The software provided by client to enable the EUT under transmission condition continuously at lowest, middle and highest channel frequencies individually.

## 4.4.7 Test Results

## Mode A

## 802.11b

Channel	Frequency (MHz)	Peak Power (dBm)			Total Power (mW)	Total Power (dBm)	Limit (dBm)	Pass / Fail
		Chain 0	Chain 1	Chain 2				
1	2412	13.71	16.18	16.38	108.443	20.35	30	Pass
6	2437	14.10	16.57	16.20	112.785	20.52	30	Pass
11	2462	13.96	16.51	16.14	110.775	20.44	30	Pass

## 802.11g

Channel	Frequency (MHz)	Peak Power (dBm)			Total Power (mW)	Total Power (dBm)	Limit (dBm)	Pass / Fail
		Chain 0	Chain 1	Chain 2				
1	2412	14.73	17.10	17.41	136.084	21.34	30	Pass
6	2437	18.71	21.00	21.02	326.668	25.14	30	Pass
11	2462	14.45	15.66	16.93	113.991	20.57	30	Pass

## 802.11n (HT20)

Channel	Frequency (MHz)	Peak Power (dBm)			Total Power (mW)	Total Power (dBm)	Limit (dBm)	Pass / Fail
		Chain 0	Chain 1	Chain 2				
1	2412	13.40	15.93	16.36	104.303	20.18	30	Pass
6	2437	18.82	21.11	21.04	<b>332.387</b>	<b>25.22</b>	30	Pass
11	2462	13.04	15.59	15.68	93.344	19.70	30	Pass

## 802.11n (HT40)

Channel	Frequency (MHz)	Peak Power (dBm)			Total Power (mW)	Total Power (dBm)	Limit (dBm)	Pass / Fail
		Chain 0	Chain 1	Chain 2				
3	2422	9.89	12.20	12.45	43.925	16.43	30	Pass
6	2437	15.01	17.21	17.49	140.402	21.47	30	Pass
9	2452	10.72	12.77	12.83	49.913	16.98	30	Pass



**Mode B**

**802.11b**

Channel	Frequency (MHz)	Peak Power (dBm)			Total Power (mW)	Total Power (dBm)	Limit (dBm)	Pass / Fail
		Chain 0	Chain 1	Chain 2				
1	2412	13.71	16.18	16.38	108.443	20.35	30	Pass
6	2437	14.10	16.57	16.20	112.785	20.52	30	Pass
11	2462	13.96	16.51	16.14	110.775	20.44	30	Pass

**802.11g**

Channel	Frequency (MHz)	Peak Power (dBm)			Total Power (mW)	Total Power (dBm)	Limit (dBm)	Pass / Fail
		Chain 0	Chain 1	Chain 2				
1	2412	14.73	17.10	17.41	136.084	21.34	30	Pass
6	2437	18.71	21.00	21.02	326.668	25.14	30	Pass
11	2462	14.92	15.01	17.67	121.220	20.84	30	Pass

**802.11n (HT20)**

Channel	Frequency (MHz)	Peak Power (dBm)			Total Power (mW)	Total Power (dBm)	Limit (dBm)	Pass / Fail
		Chain 0	Chain 1	Chain 2				
1	2412	13.40	15.93	16.36	104.303	20.18	30	Pass
6	2437	18.82	21.11	21.04	<b>332.387</b>	<b>25.22</b>	30	Pass
11	2462	14.66	14.43	17.11	108.379	20.35	30	Pass

**802.11n (HT40)**

Channel	Frequency (MHz)	Peak Power (dBm)			Total Power (mW)	Total Power (dBm)	Limit (dBm)	Pass / Fail
		Chain 0	Chain 1	Chain 2				
3	2422	11.28	10.92	14.14	51.729	17.14	30	Pass
6	2437	14.33	16.58	16.91	121.692	20.85	30	Pass
9	2452	11.58	11.29	13.83	52.001	17.16	30	Pass

## 4.5 Power Spectral Density Measurement

### 4.5.1 Limits of Power Spectral Density Measurement

The Maximum of Power Spectral Density Measurement is 8 dBm.

### 4.5.2 Test Setup

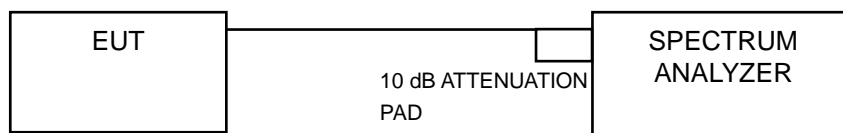

### 4.5.3 Test Instruments

Refer to section 4.1.2 to get information of above instrument.

### 4.5.4 Test Procedure

- a. Set analyzer center frequency to DTS channel center frequency.
- b. Set the span to 1.5 times the DTS bandwidth.
- c. Set the RBW to:  $3 \text{ kHz} \leq \text{RBW} \leq 100 \text{ kHz}$ .
- d. Set the VBW  $\geq 3 \times \text{RBW}$ .
- e. Detector = peak.
- f. Sweep time = auto couple.
- g. Trace mode = max hold.
- h. Allow trace to fully stabilize.
- i. Use the peak marker function to determine the maximum amplitude level within the RBW.

### 4.5.5 Deviation from Test Standard

No deviation.

### 4.5.6 EUT Operating Condition

The software provided by client to enable the EUT under transmission condition continuously at lowest, middle and highest channel frequencies individually.

#### 4.5.7 Test Results

##### Mode A

##### 802.11b

TX Chain	Channel	Freq. (MHz)	PSD (dBm)	10 log (N=3) dB	Total PSD (dBm)	Limit (dBm)	Pass / Fail
0	1	2412	-12.14	4.77	-7.37	4.58	Pass
	6	2437	-11.96	4.77	-7.19	4.58	Pass
	11	2462	-12.48	4.77	-7.71	4.58	Pass
1	1	2412	-9.15	4.77	-4.38	4.58	Pass
	6	2437	-8.37	4.77	-3.60	4.58	Pass
	11	2462	-8.60	4.77	-3.83	4.58	Pass
2	1	2412	-9.01	4.77	-4.24	4.58	Pass
	6	2437	-8.69	4.77	-3.92	4.58	Pass
	11	2462	-8.93	4.77	-4.16	4.58	Pass

**NOTE:** Directional gain = 4.65 dBi + 10log(3) = 9.42 dBi > 6 dBi , so the power density limit shall be reduced to 8-(9.42-6) = 4.58 dBm.

##### 802.11g

TX Chain	Channel	Freq. (MHz)	PSD (dBm)	10 log (N=3) dB	Total PSD (dBm)	Limit (dBm)	Pass / Fail
0	1	2412	-16.93	4.77	-12.16	4.58	Pass
	6	2437	-13.52	4.77	-8.75	4.58	Pass
	11	2462	-17.55	4.77	-12.78	4.58	Pass
1	1	2412	-13.64	4.77	-8.87	4.58	Pass
	6	2437	-9.29	4.77	-4.52	4.58	Pass
	11	2462	-13.89	4.77	-9.12	4.58	Pass
2	1	2412	-15.20	4.77	-10.43	4.58	Pass
	6	2437	-8.27	4.77	-3.50	4.58	Pass
	11	2462	-15.01	4.77	-10.24	4.58	Pass

**NOTE:** Directional gain = 4.65 dBi + 10log(3) = 9.42 dBi > 6 dBi , so the power density limit shall be reduced to 8-(9.42-6) = 4.58 dBm.

**802.11n (HT20)**

TX Chain	Channel	Freq. (MHz)	PSD (dBm)	10 log (N=3) dB	Total PSD (dBm)	Limit (dBm)	Pass / Fail
0	1	2412	-17.74	4.77	-12.97	4.58	Pass
	6	2437	-12.98	4.77	-8.21	4.58	Pass
	11	2462	-17.96	4.77	-13.19	4.58	Pass
1	1	2412	-14.99	4.77	-10.22	4.58	Pass
	6	2437	-9.98	4.77	-5.21	4.58	Pass
	11	2462	-15.82	4.77	-11.05	4.58	Pass
2	1	2412	-14.93	4.77	-10.16	4.58	Pass
	6	2437	-9.24	4.77	-4.47	4.58	Pass
	11	2462	-15.44	4.77	-10.67	4.58	Pass

**NOTE:** Directional gain = 4.65 dBi + 10log(3) = 9.42 dBi > 6 dBi , so the power density limit shall be reduced to 8-(9.42-6) = 4.58 dBm.

**802.11n (HT40)**

TX Chain	Channel	Freq. (MHz)	PSD (dBm)	10 log (N=3) dB	Total PSD (dBm)	Limit (dBm)	Pass / Fail
0	3	2422	-24.32	4.77	-19.55	4.58	Pass
	6	2437	-18.89	4.77	-14.12	4.58	Pass
	9	2452	-24.26	4.77	-19.49	4.58	Pass
1	3	2422	-21.68	4.77	-16.91	4.58	Pass
	6	2437	-9.64	4.77	-4.87	4.58	Pass
	9	2452	-22.21	4.77	-17.44	4.58	Pass
2	3	2422	-21.70	4.77	-16.93	4.58	Pass
	6	2437	-14.94	4.77	-10.17	4.58	Pass
	9	2452	-21.93	4.77	-17.16	4.58	Pass

**NOTE:** Directional gain = 4.65 dBi + 10log(3) = 9.42 dBi > 6 dBi , so the power density limit shall be reduced to 8-(9.42-6) = 4.58 dBm.

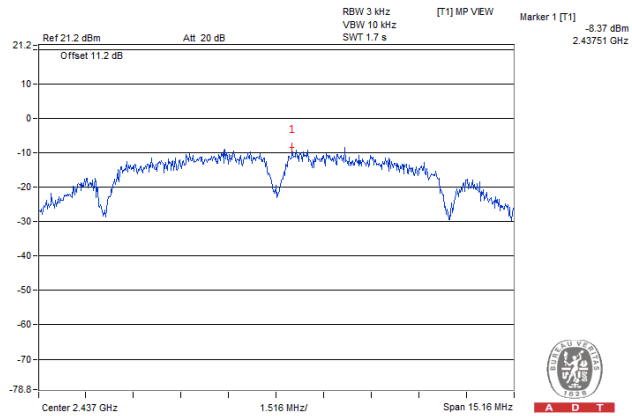
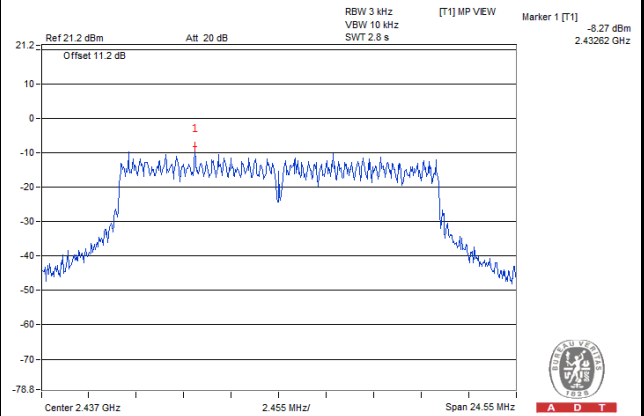
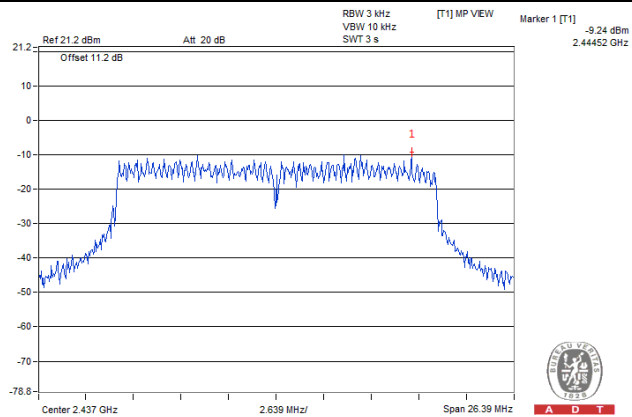
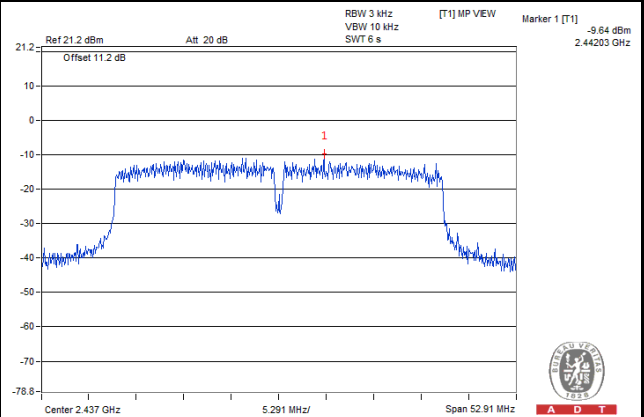
**Spectrum Plot of Worst Value****802.11b****802.11g****802.11n (HT20)****802.11n (HT40)**

**Mode B**
**802.11b**

TX Chain	Channel	Freq. (MHz)	PSD (dBm)	10 log (N=3) dB	Total PSD (dBm)	Limit (dBm)	Pass / Fail
0	1	2412	-12.14	4.77	-7.37	7.30	Pass
	6	2437	-11.96	4.77	-7.19	7.30	Pass
	11	2462	-12.48	4.77	-7.71	7.30	Pass
1	1	2412	-9.15	4.77	-4.38	7.30	Pass
	6	2437	-8.37	4.77	-3.60	7.30	Pass
	11	2462	-8.60	4.77	-3.83	7.30	Pass
2	1	2412	-9.01	4.77	-4.24	7.30	Pass
	6	2437	-8.69	4.77	-3.92	7.30	Pass
	11	2462	-8.93	4.77	-4.16	7.30	Pass

**NOTE:** Directional gain = 1.93 dBi + 10log(3) = 6.70 dBi > 6 dBi , so the power density limit shall be reduced to 8-(6.70-6) = 7.30 dBm.

**802.11g**

TX Chain	Channel	Freq. (MHz)	PSD (dBm)	10 log (N=3) dB	Total PSD (dBm)	Limit (dBm)	Pass / Fail
0	1	2412	-16.93	4.77	-12.16	7.30	Pass
	6	2437	-13.52	4.77	-8.75	7.30	Pass
	11	2462	-16.58	4.77	-11.81	7.30	Pass
1	1	2412	-13.64	4.77	-8.87	7.30	Pass
	6	2437	-9.29	4.77	-4.52	7.30	Pass
	11	2462	-13.33	4.77	-8.56	7.30	Pass
2	1	2412	-15.20	4.77	-10.43	7.30	Pass
	6	2437	-8.27	4.77	-3.50	7.30	Pass
	11	2462	-14.70	4.77	-9.93	7.30	Pass

**NOTE:** Directional gain = 1.93 dBi + 10log(3) = 6.70 dBi > 6 dBi , so the power density limit shall be reduced to 8-(6.70-6) = 7.30 dBm.

**802.11n (HT20)**

TX Chain	Channel	Freq. (MHz)	PSD (dBm)	10 log (N=3) dB	Total PSD (dBm)	Limit (dBm)	Pass / Fail
0	1	2412	-17.74	4.77	-12.97	7.30	Pass
	6	2437	-12.98	4.77	-8.21	7.30	Pass
	11	2462	-17.30	4.77	-12.53	7.30	Pass
1	1	2412	-14.99	4.77	-10.22	7.30	Pass
	6	2437	-9.98	4.77	-5.21	7.30	Pass
	11	2462	-14.64	4.77	-9.87	7.30	Pass
2	1	2412	-14.93	4.77	-10.16	7.30	Pass
	6	2437	-9.24	4.77	-4.47	7.30	Pass
	11	2462	-13.90	4.77	-9.13	7.30	Pass

**NOTE:** Directional gain = 1.93 dBi + 10log(3) = 6.70 dBi > 6 dBi , so the power density limit shall be reduced to 8-(6.70-6) = 7.30 dBm.

**802.11n (HT40)**

TX Chain	Channel	Freq. (MHz)	PSD (dBm)	10 log (N=3) dB	Total PSD (dBm)	Limit (dBm)	Pass / Fail
0	3	2422	-23.85	4.77	-19.08	7.30	Pass
	6	2437	-19.66	4.77	-14.89	7.30	Pass
	9	2452	-22.87	4.77	-18.10	7.30	Pass
1	3	2422	-19.91	4.77	-15.14	7.30	Pass
	6	2437	-11.58	4.77	-6.81	7.30	Pass
	9	2452	-20.37	4.77	-15.60	7.30	Pass
2	3	2422	-21.76	4.77	-16.99	7.30	Pass
	6	2437	-17.88	4.77	-13.11	7.30	Pass
	9	2452	-21.10	4.77	-16.33	7.30	Pass

**NOTE:** Directional gain = 1.93 dBi + 10log(3) = 6.70 dBi > 6 dBi , so the power density limit shall be reduced to 8-(6.70-6) = 7.30 dBm.

### Spectrum Plot of Worst Value

#### 802.11b

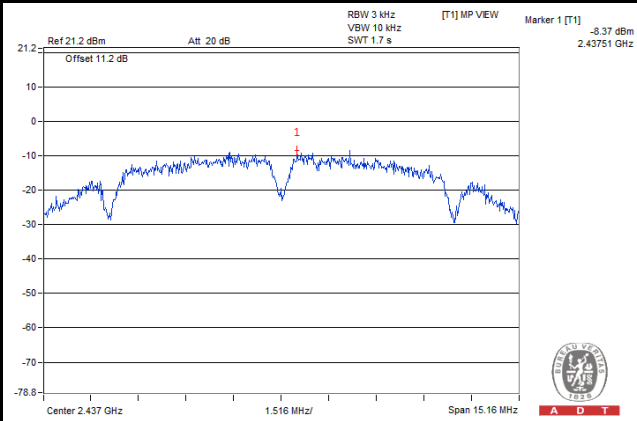

#### 802.11g

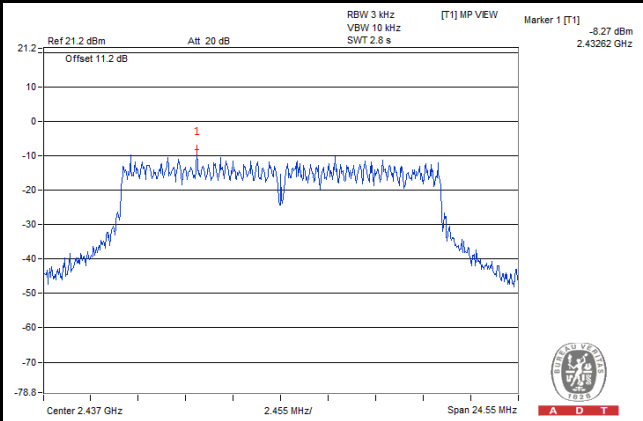

#### 802.11n (HT20)

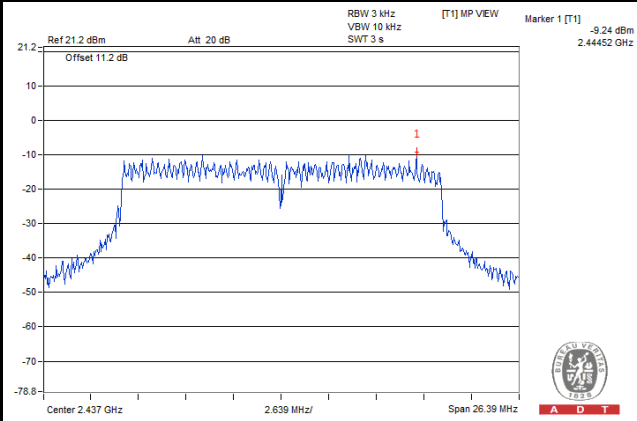

#### 802.11n (HT40)

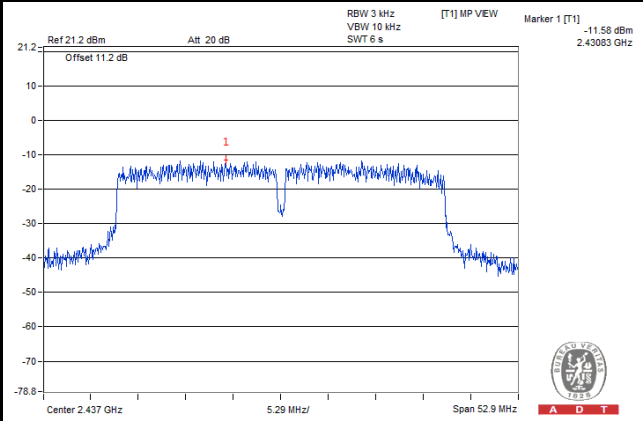



## 4.6 Conducted Out of Band Emission Measurement

### 4.6.1 Limits of Conducted Out of Band Emission Measurement

Below 20 dB of the highest emission level of operating band (in 100 kHz Resolution Bandwidth).

### 4.6.2 Test Setup

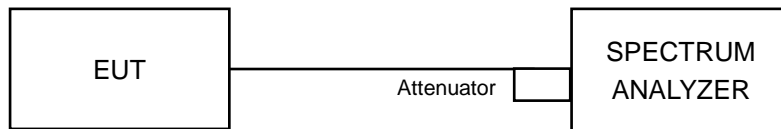

### 4.6.3 Test Instruments

Refer to section 4.1.2 to get information of above instrument.

### 4.6.4 Test Procedure

#### MEASUREMENT PROCEDURE REF

1. Set the RBW = 100 kHz.
2. Set the VBW  $\geq$  300 kHz.
3. Detector = peak.
4. Sweep time = auto couple.
5. Trace mode = max hold.
6. Allow trace to fully stabilize.
7. Use the peak marker function to determine the maximum power level in any 100 kHz band segment within the fundamental EBW.

#### MEASUREMENT PROCEDURE OOB

1. Set RBW = 100 kHz.
2. Set VBW  $\geq$  300 kHz.
3. Detector = peak.
4. Sweep = auto couple.
5. Trace Mode = max hold.
6. Allow trace to fully stabilize.
7. Use the peak marker function to determine the maximum amplitude level.

### 4.6.5 Deviation from Test Standard

No deviation.

### 4.6.6 EUT Operating Condition

The software provided by client to enable the EUT under transmission condition continuously at lowest, middle and highest channel frequencies individually.

### 4.6.7 Test Results

The conducted emission test is performed on each TX port of operating mode without summing or adding 10log (N) since the limit is relative emission limit.

The spectrum plots are attached on the following images. D1 line indicates the highest level, and D2 line indicates the 20 dB offset below D1. It shows compliance with the requirement.

**Mode A**  
**802.11b**  
**CHAIN 0**

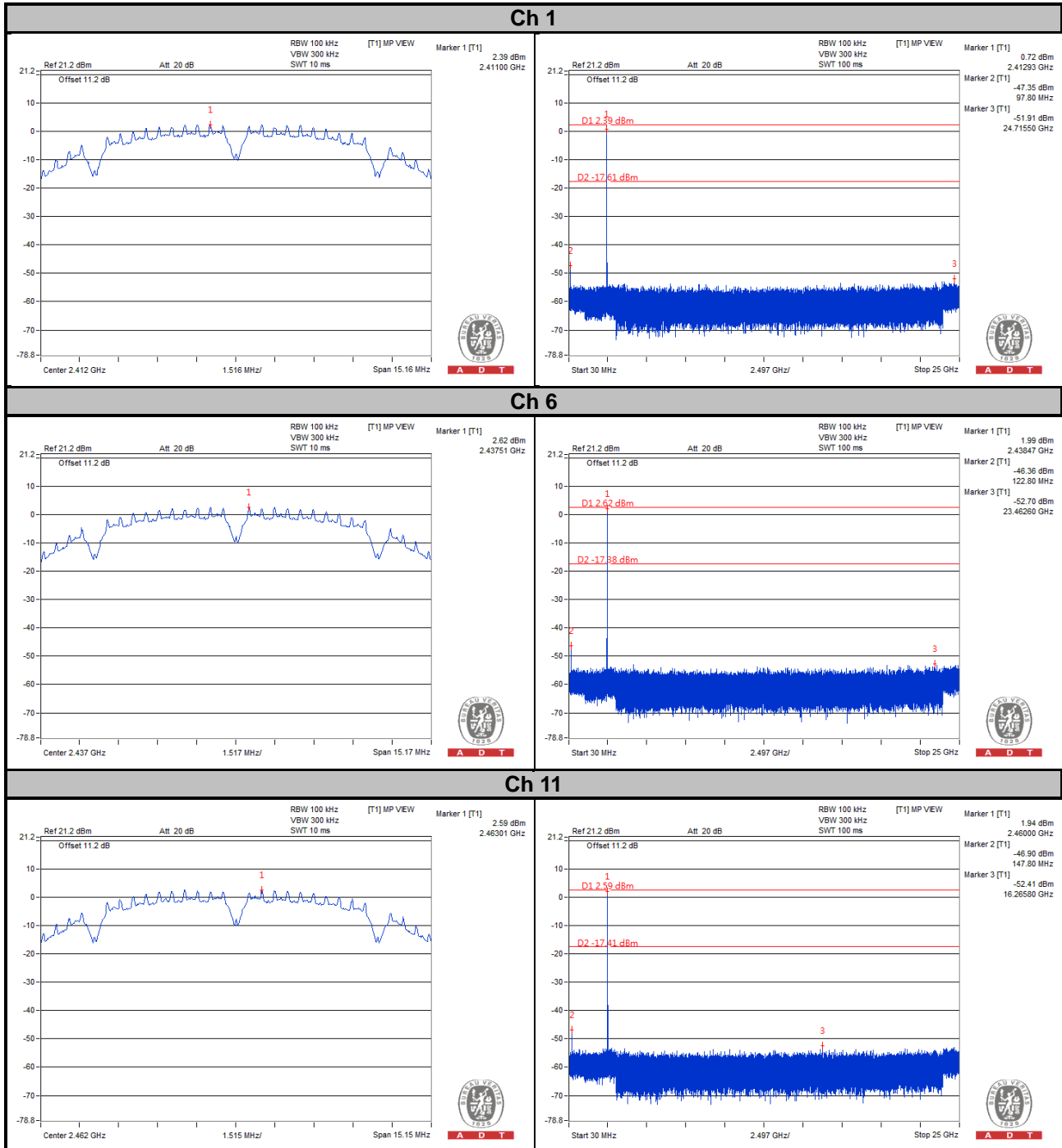

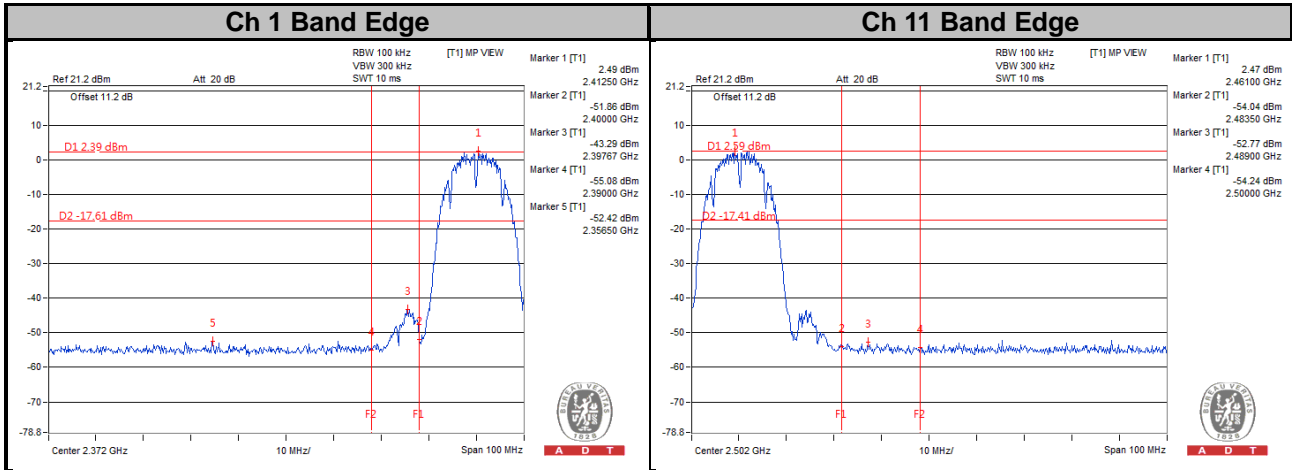

CHAIN 1

Ch 1

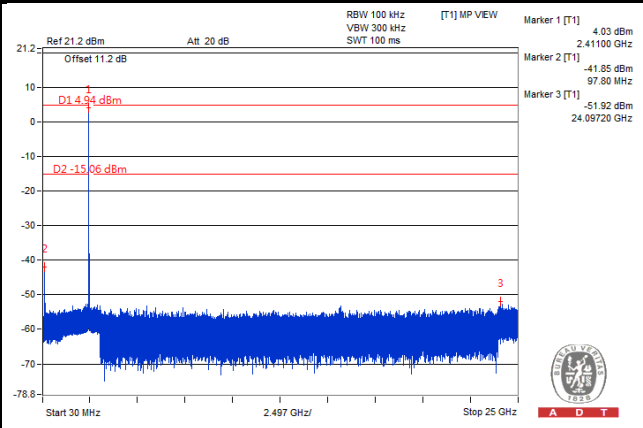
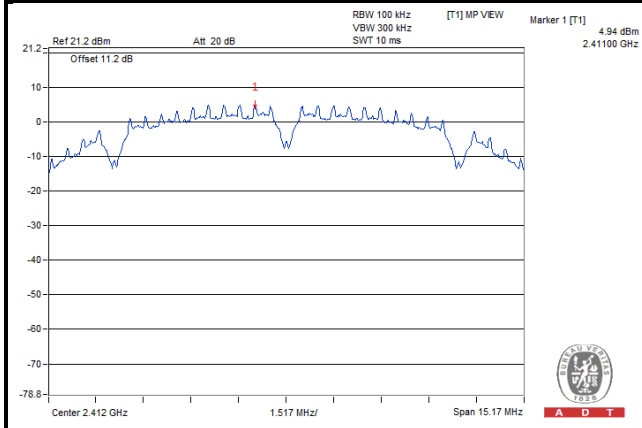

Ch 6

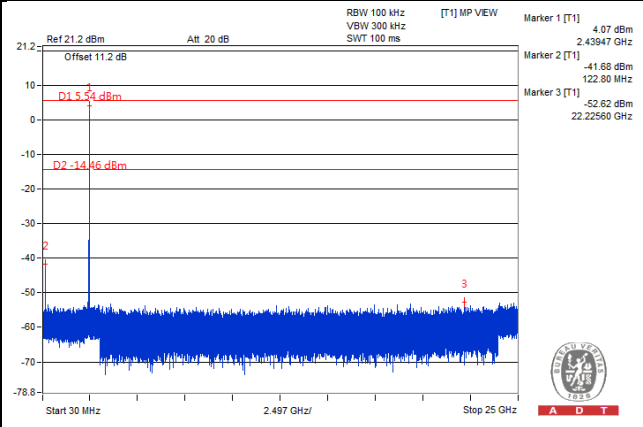
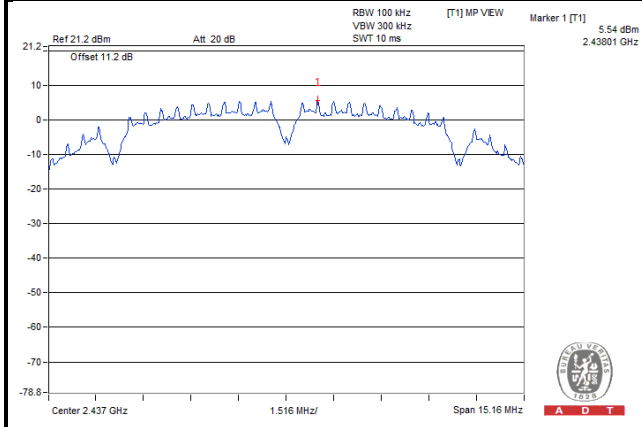

Ch 11

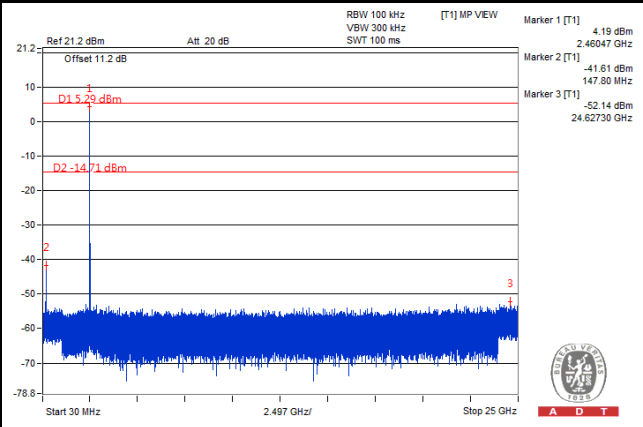
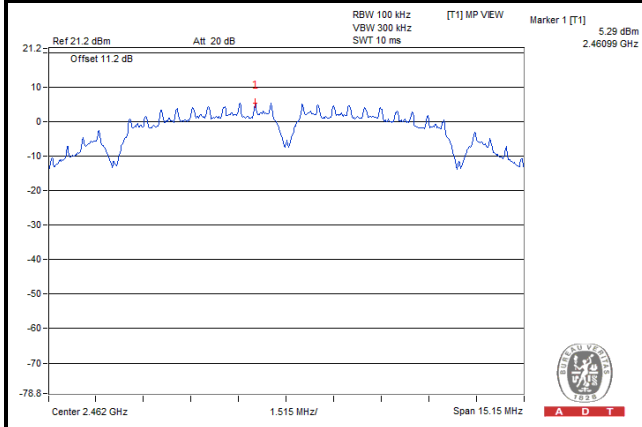

### Ch 1 Band Edge

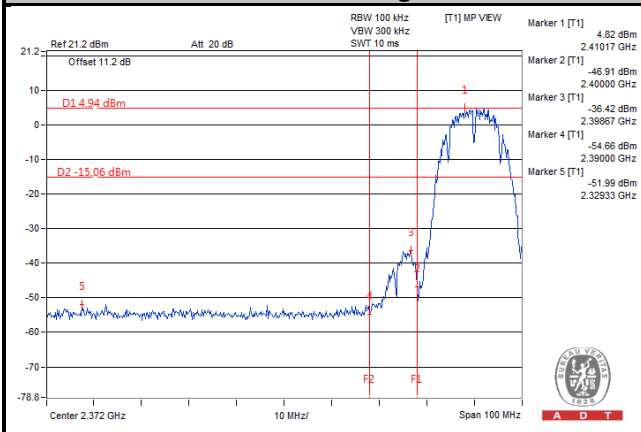

### Ch 11 Band Edge

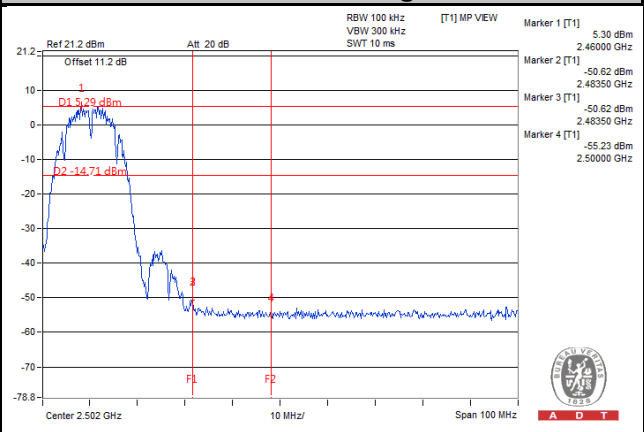

CHAIN 2

Ch 1

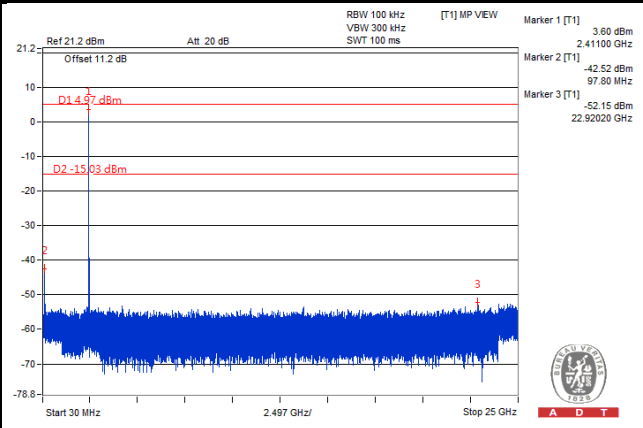
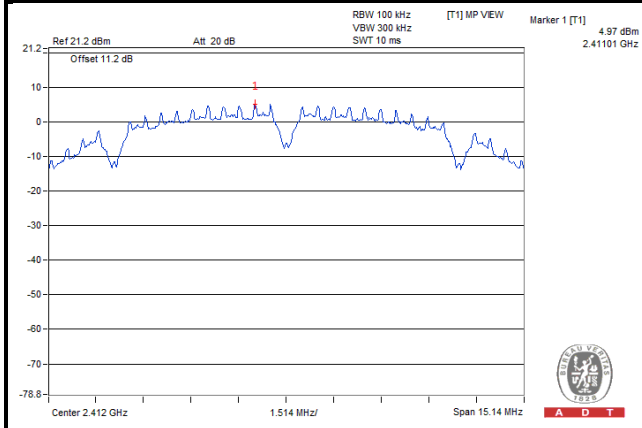

Ch 6

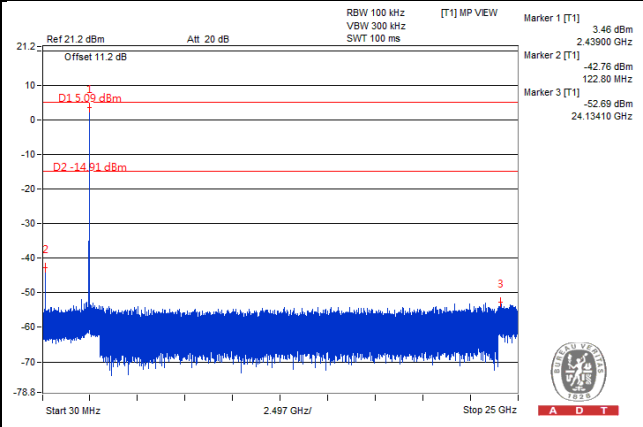
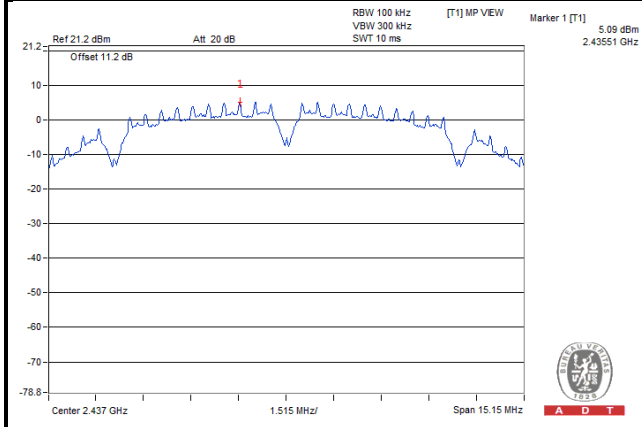

Ch 11

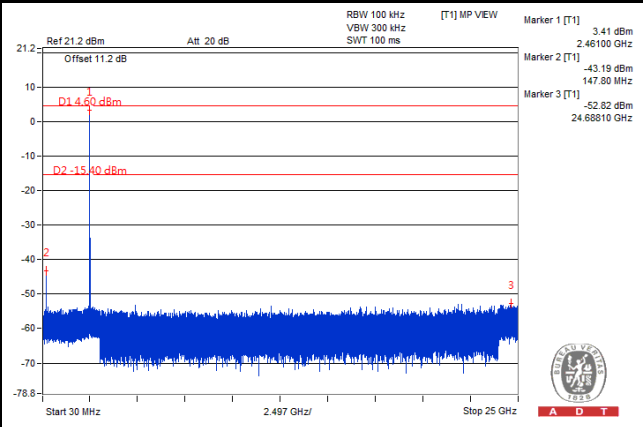
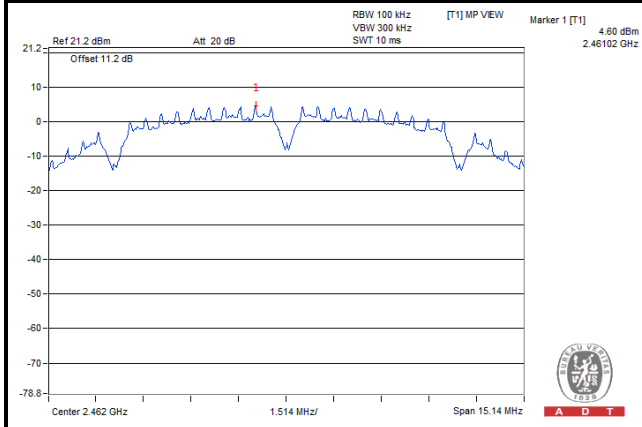

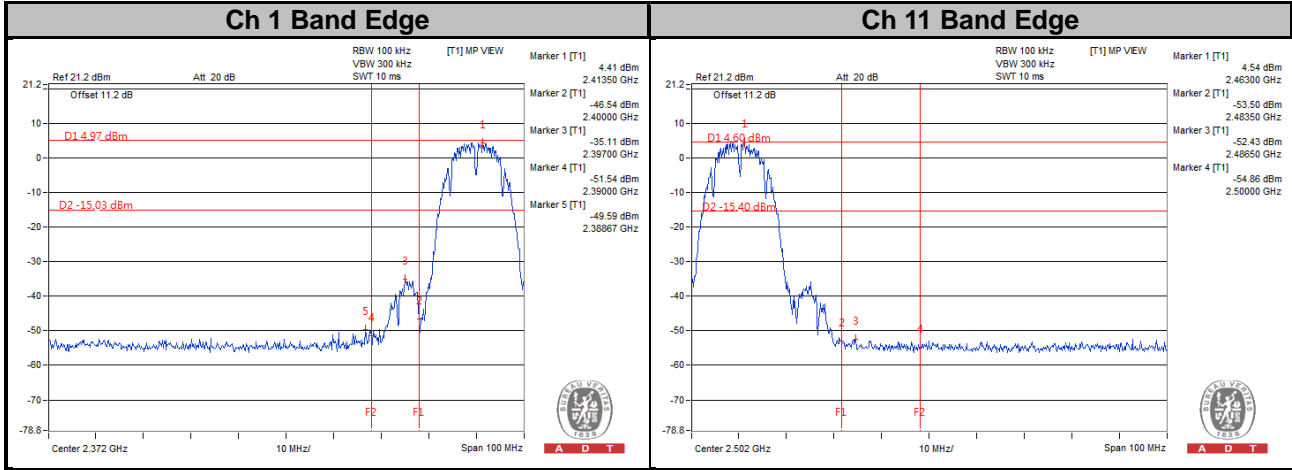

802.11g  
CHAIN 0

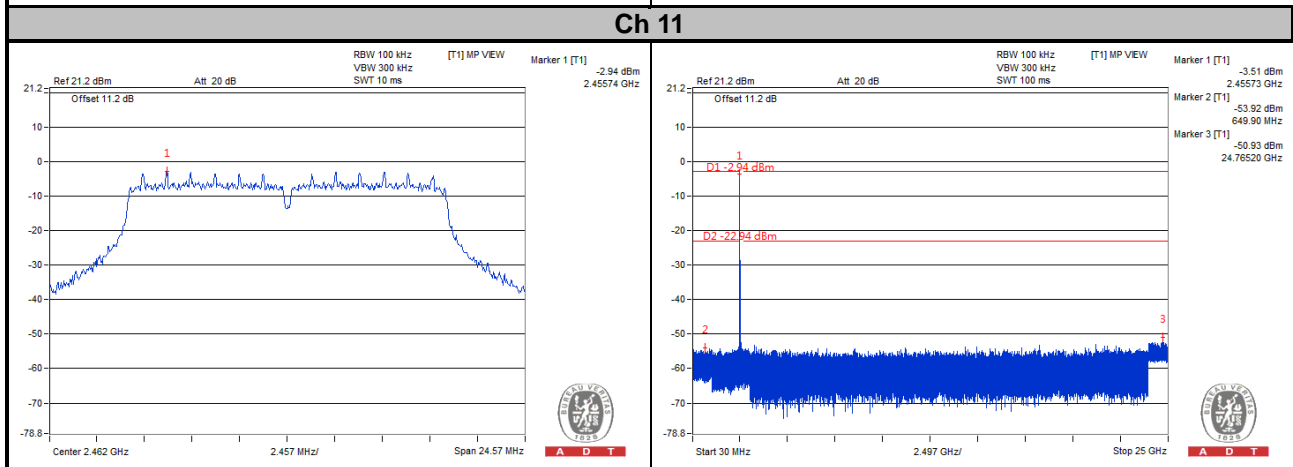
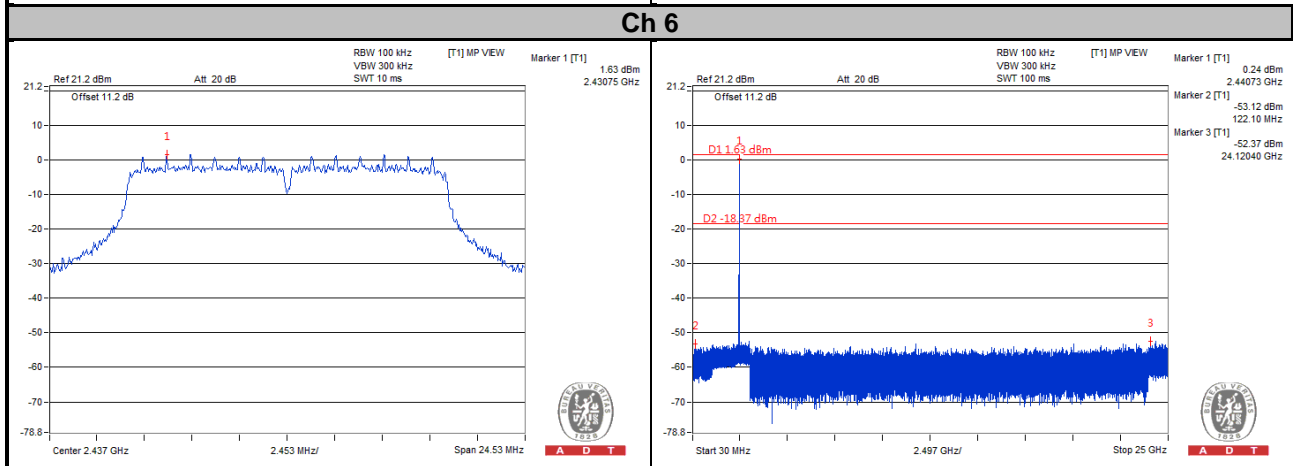
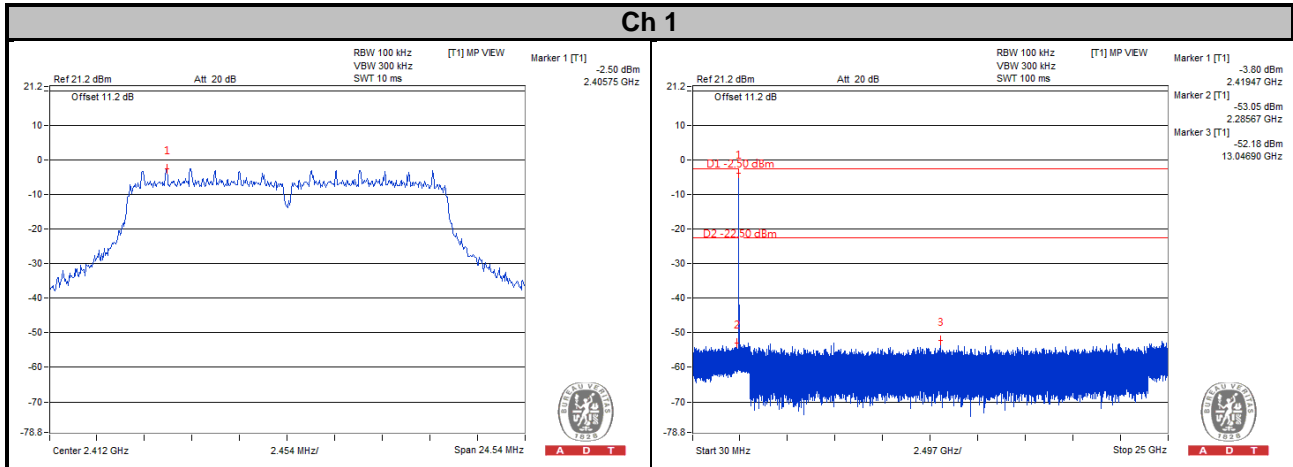



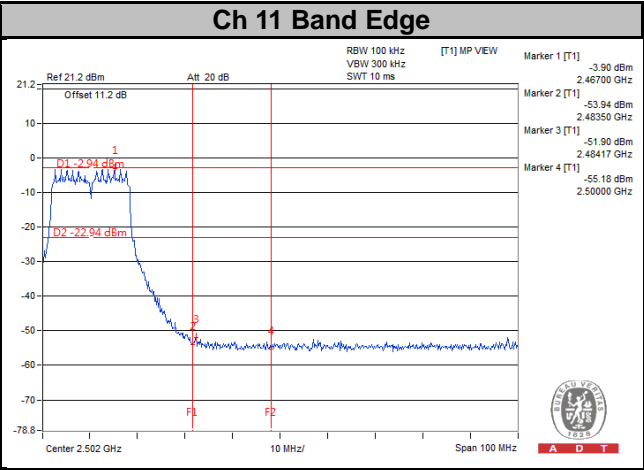
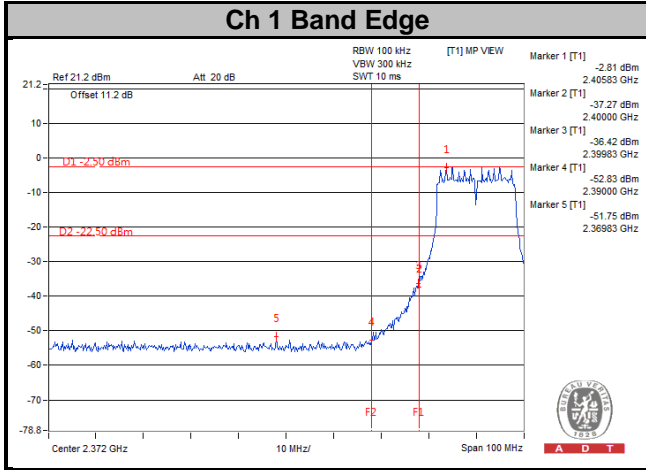

CHAIN 1

Ch 1

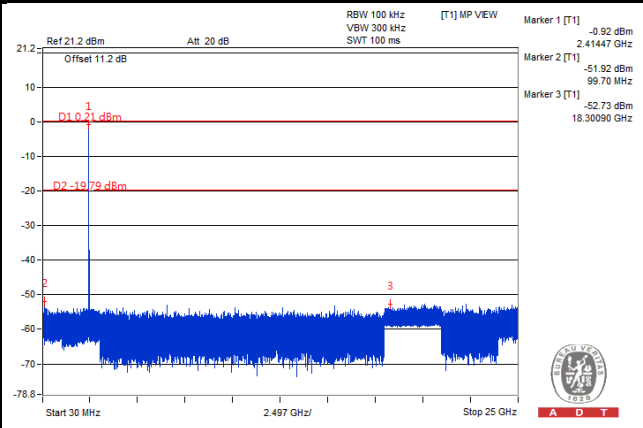
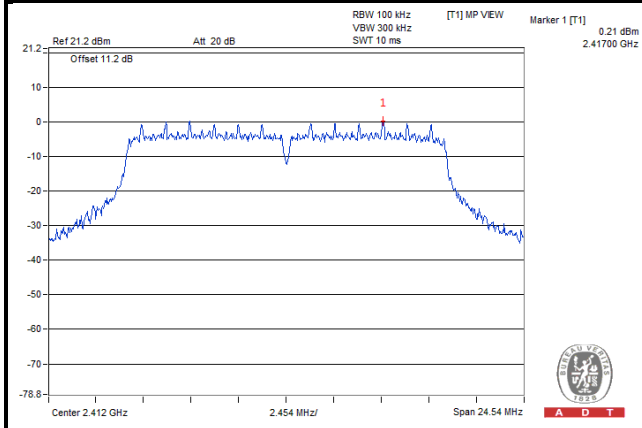

Ch 6

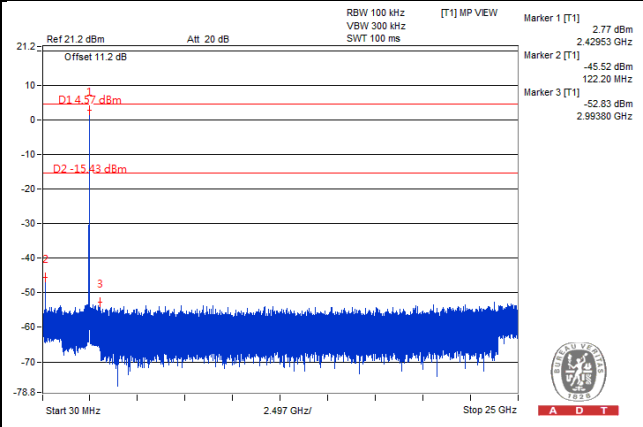
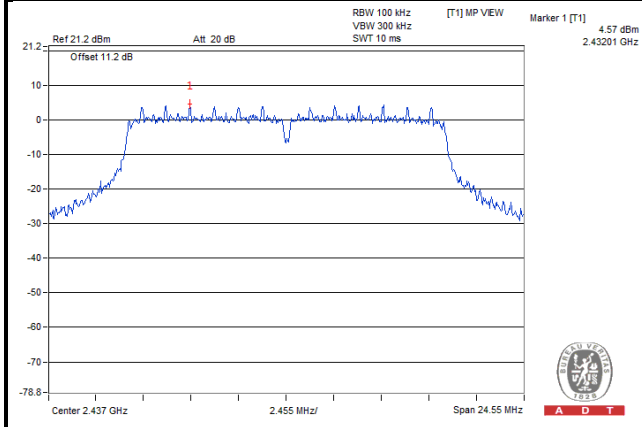

Ch 11

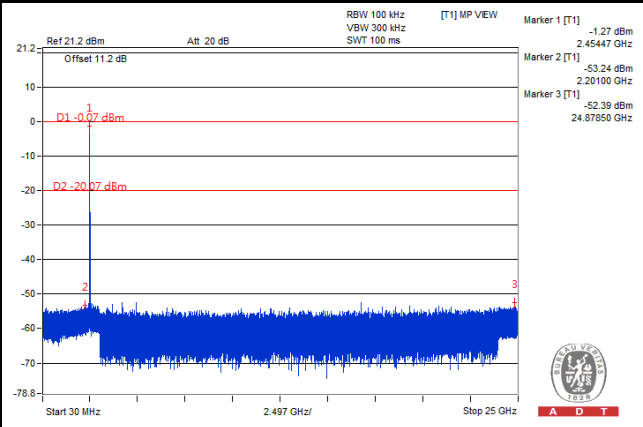
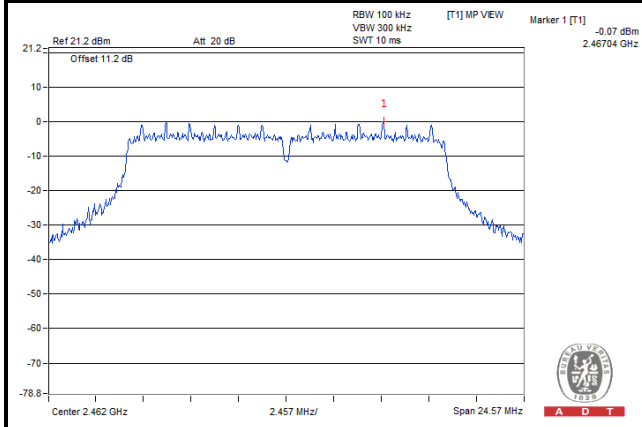

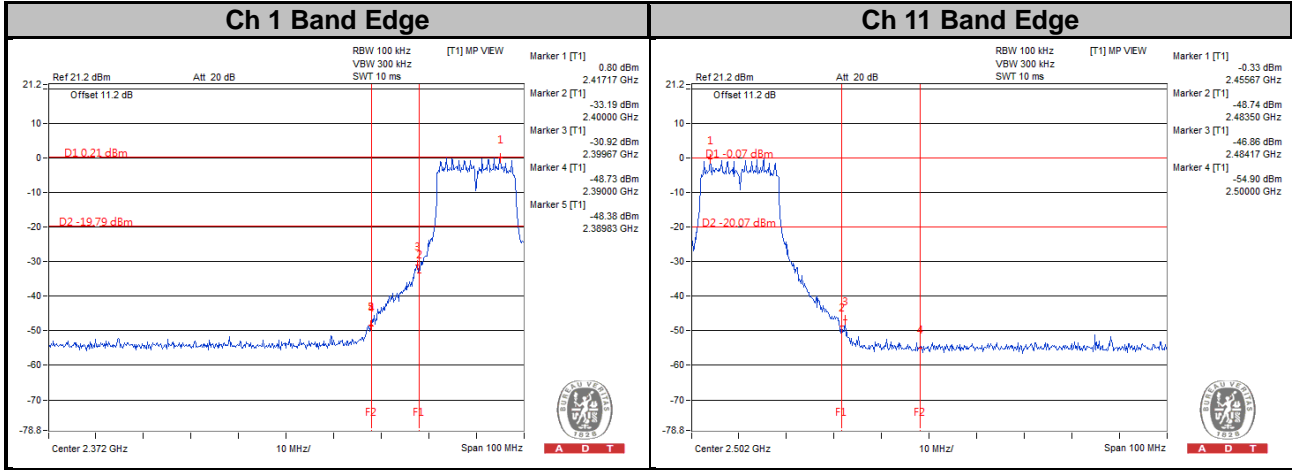

CHAIN 2

Ch 1

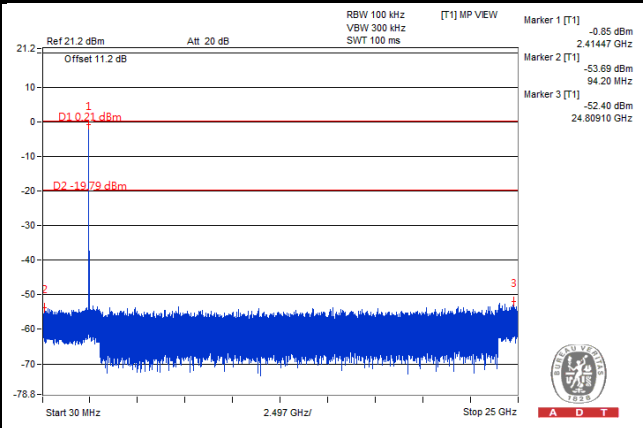
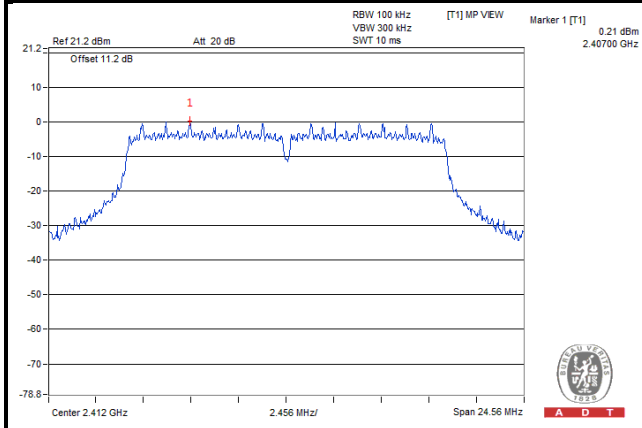

Ch 6

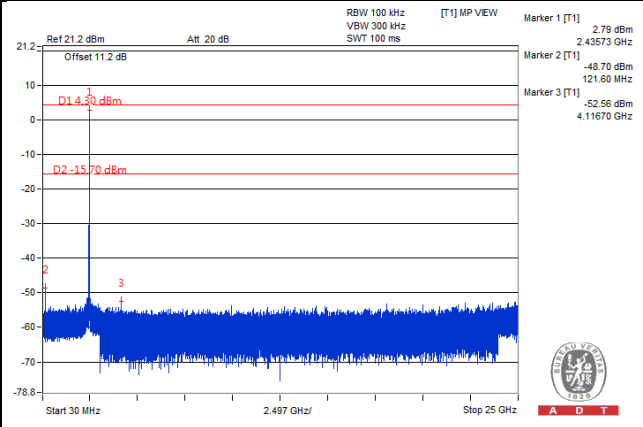
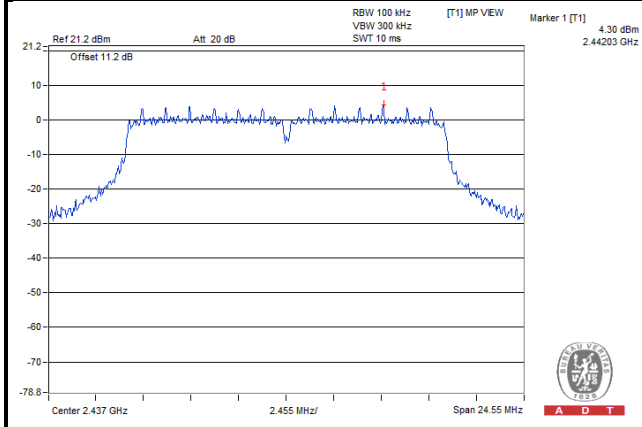

Ch 11

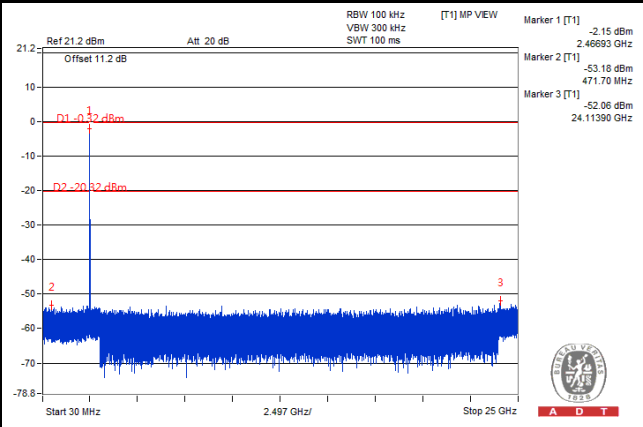
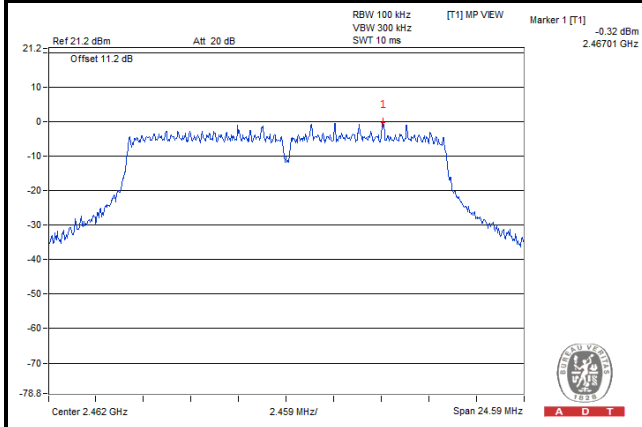

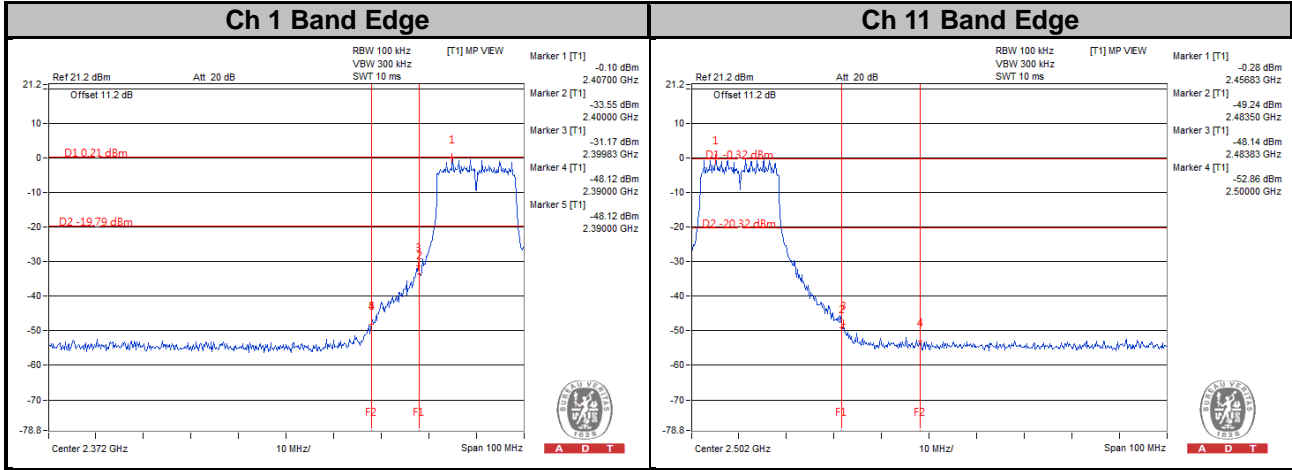

802.11n (HT20)  
CHAIN 0

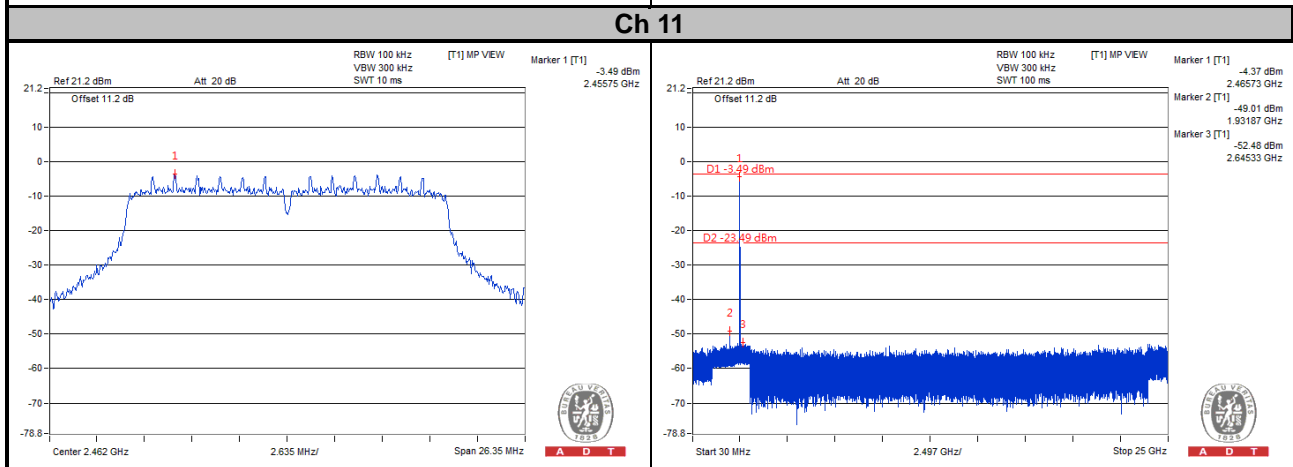
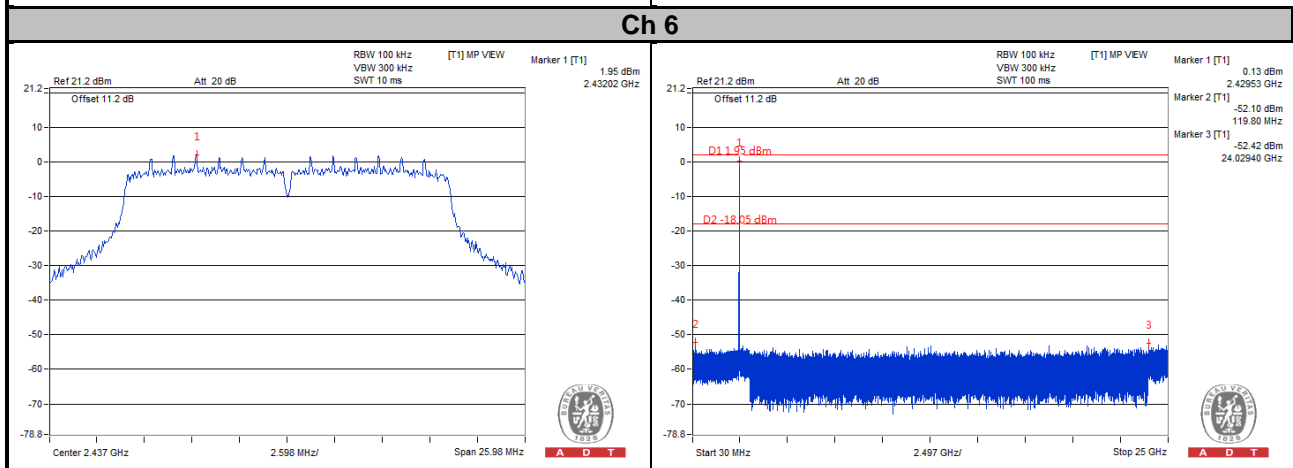
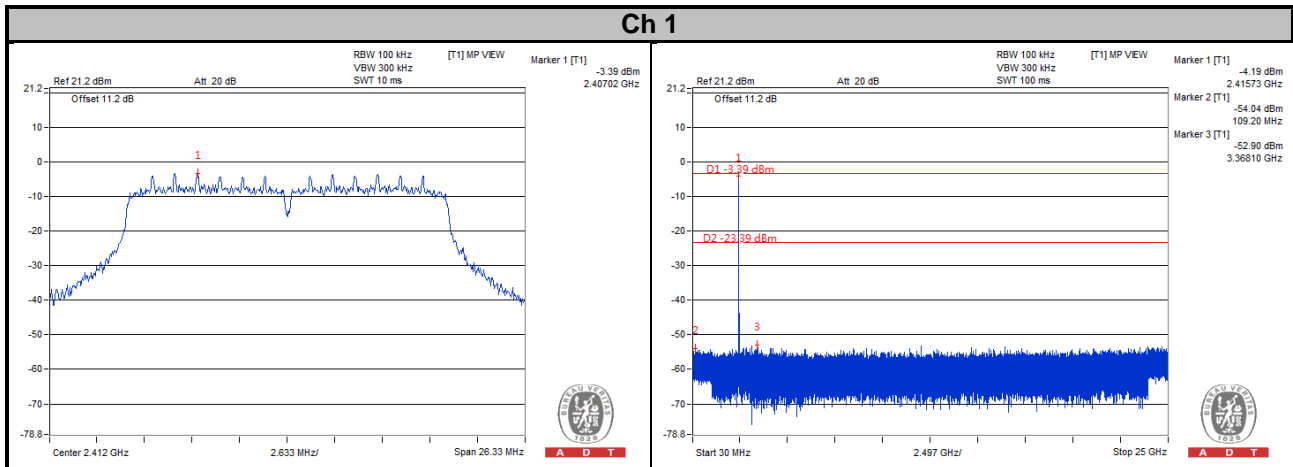

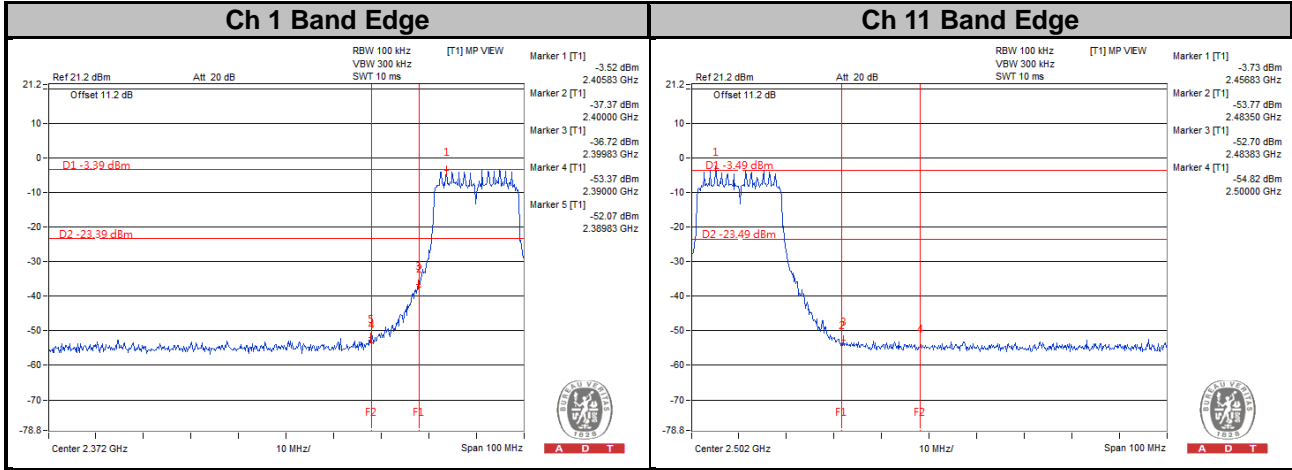

CHAIN 1

Ch 1

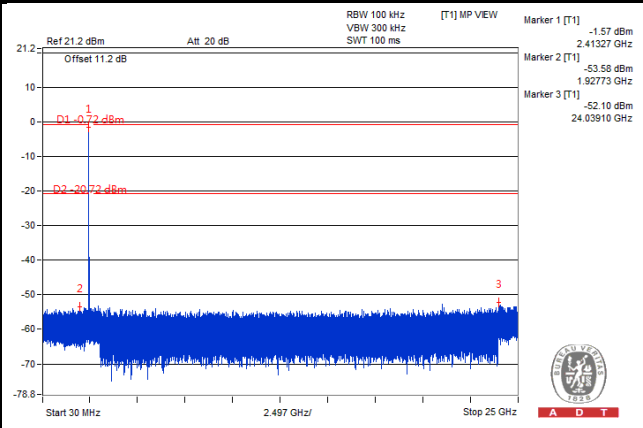
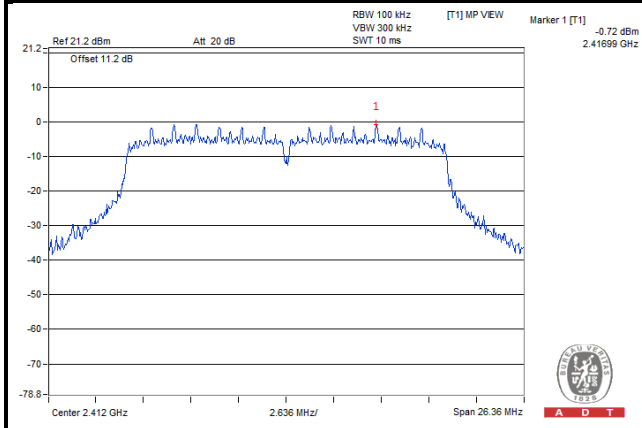

Ch 6

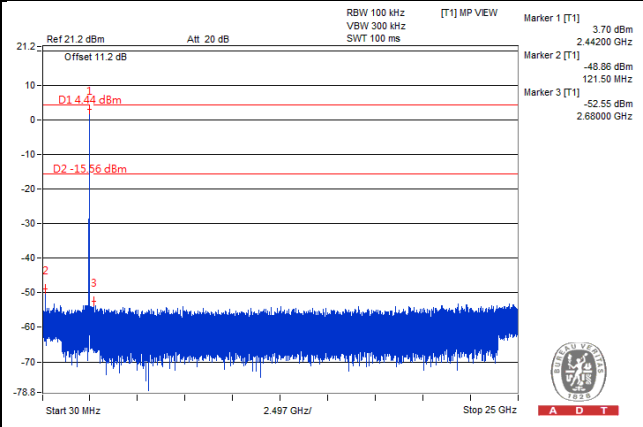
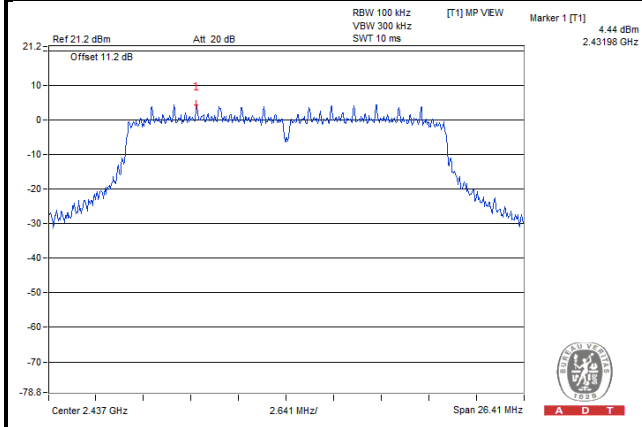

Ch 11

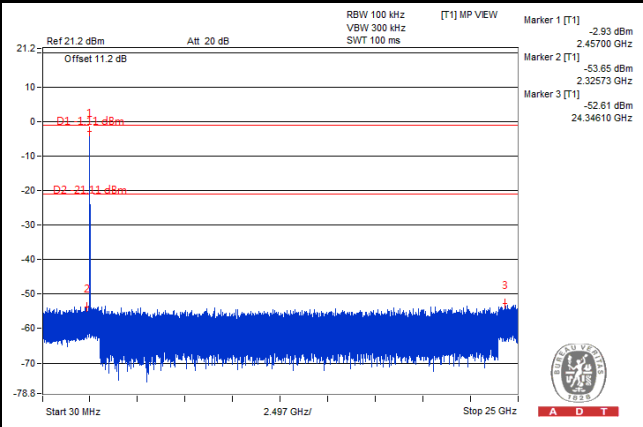
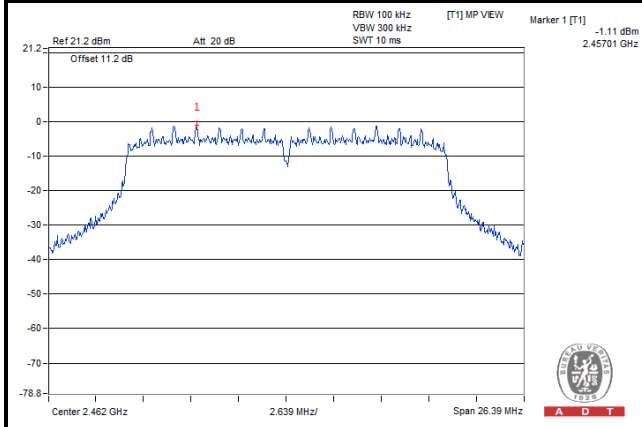



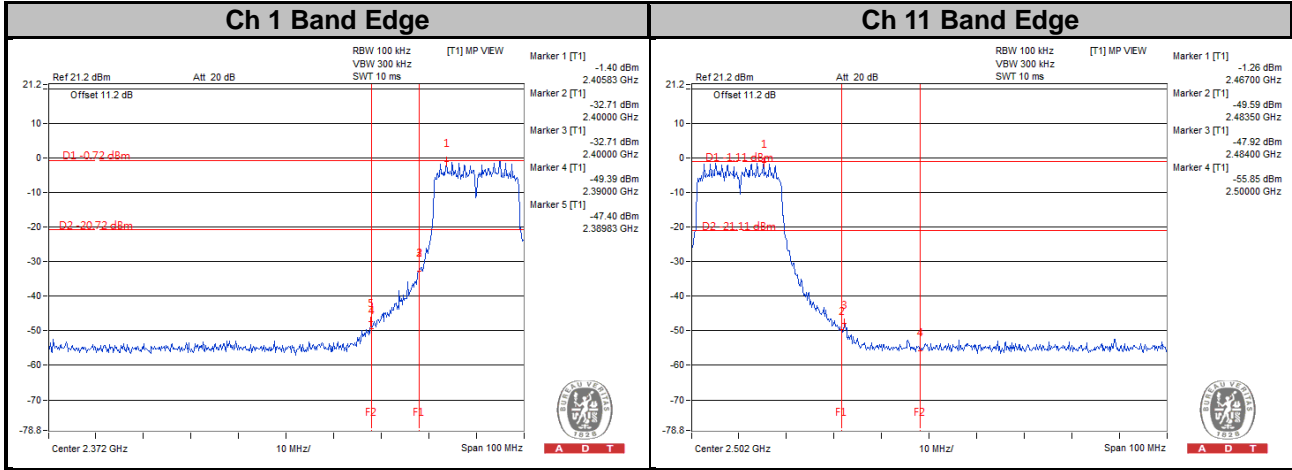

CHAIN 2

Ch 1

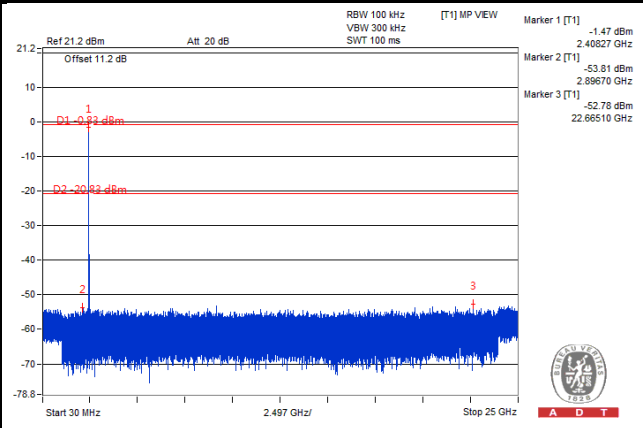
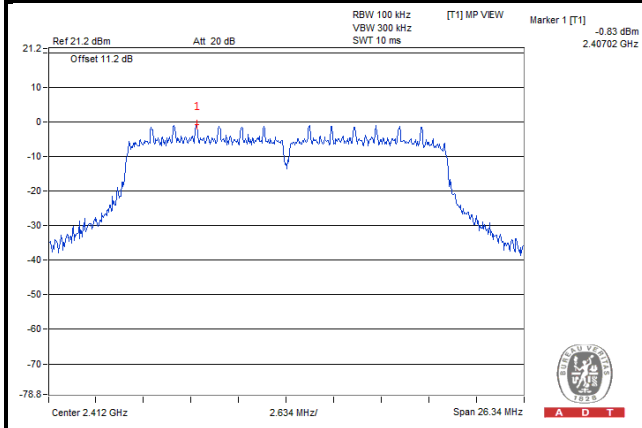

Ch 6

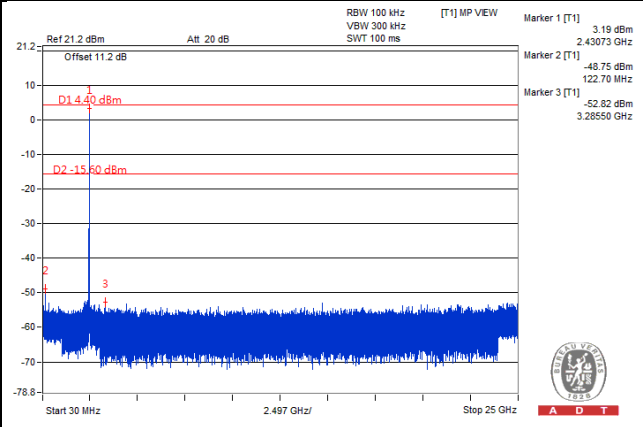
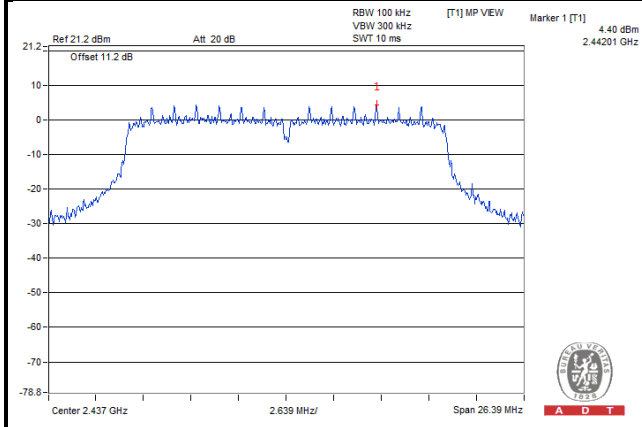

Ch 11

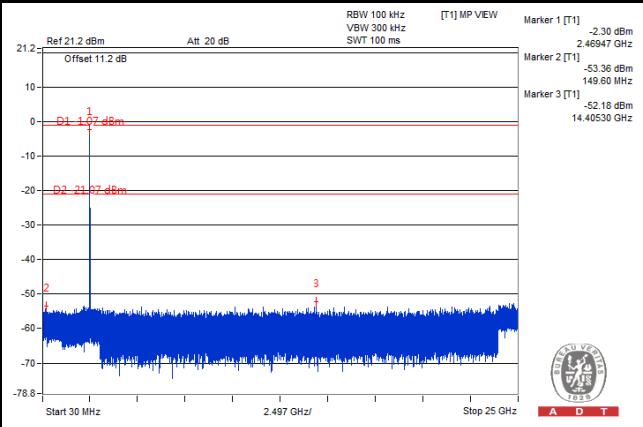
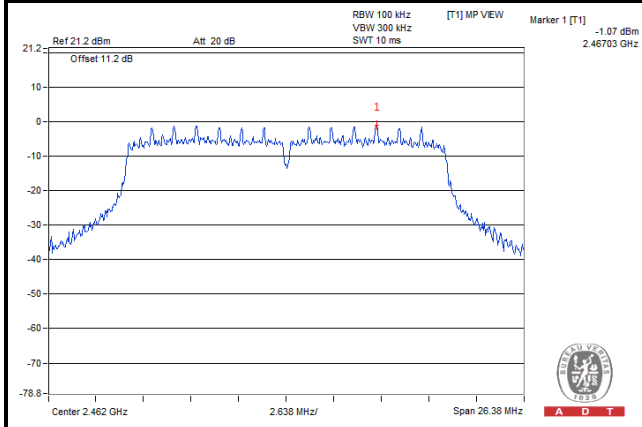

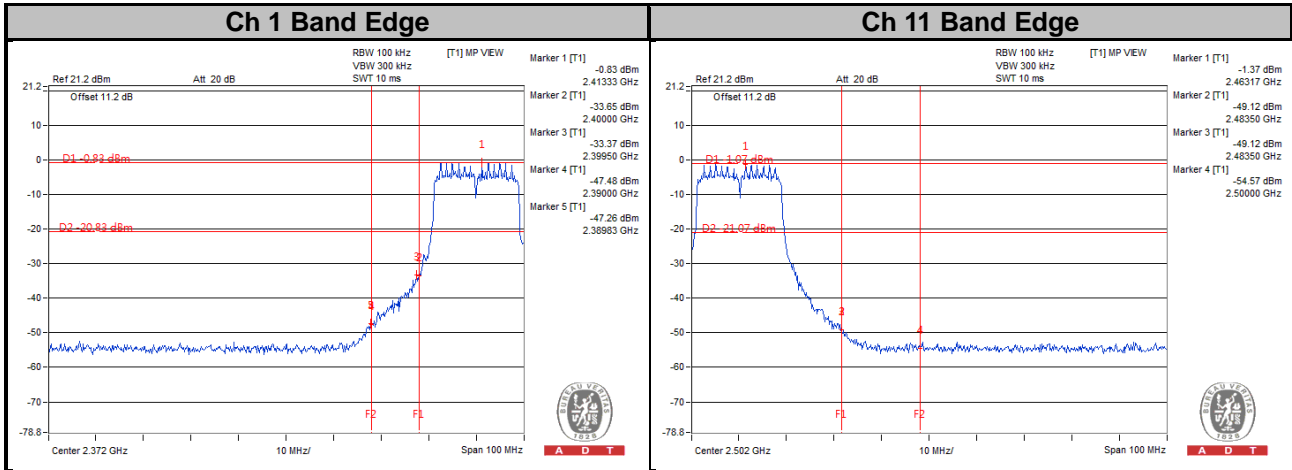

# 802.11n (HT40) CHAIN 0

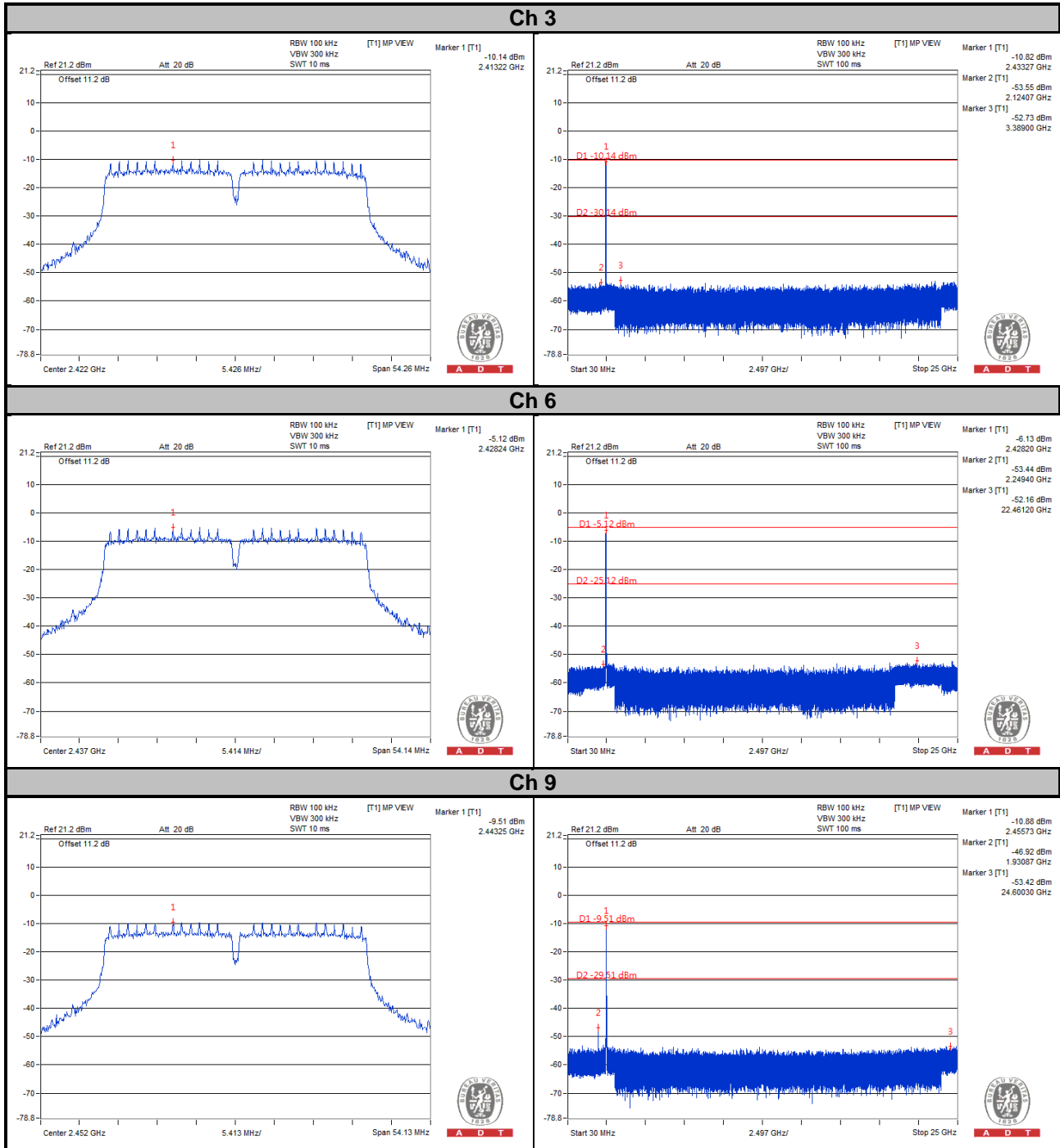

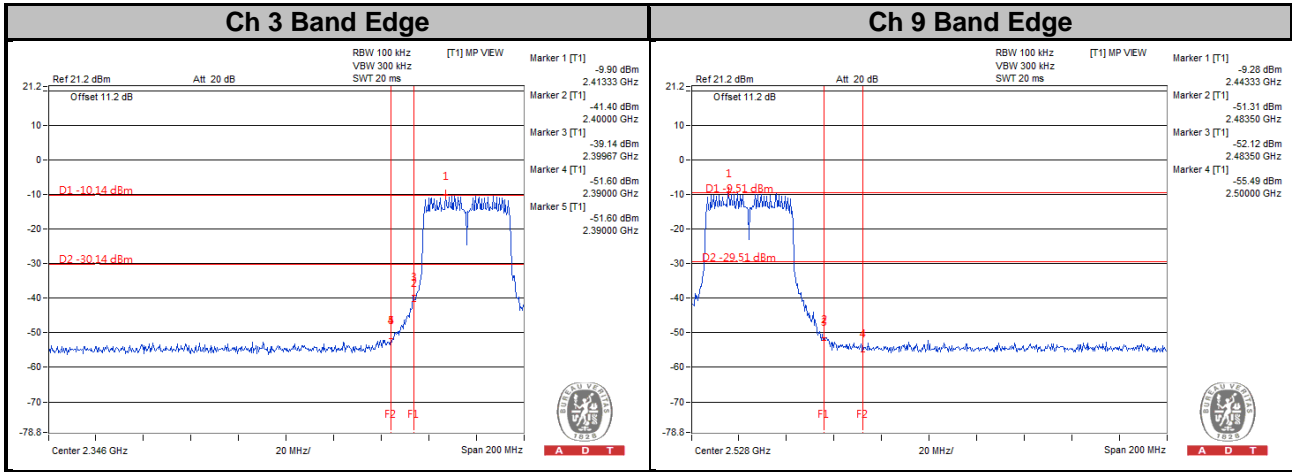

CHAIN 1

Ch 3

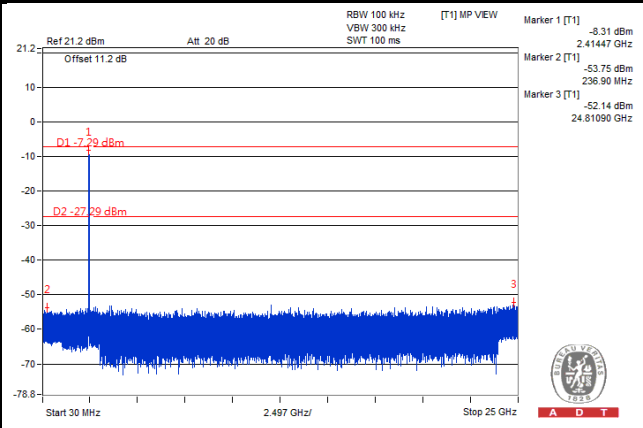
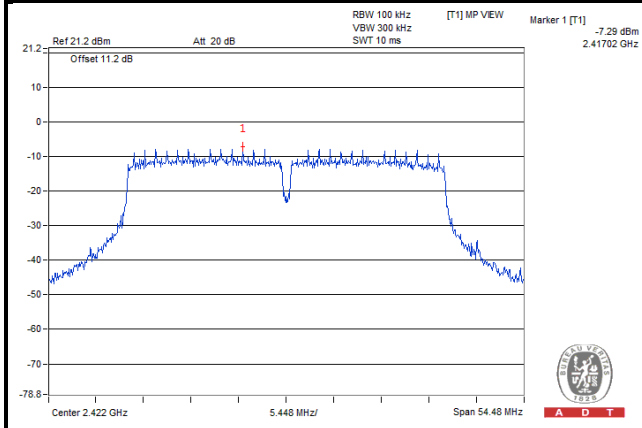

Ch 6

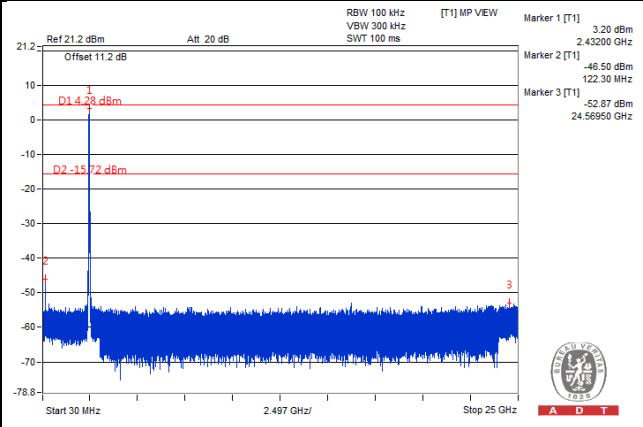
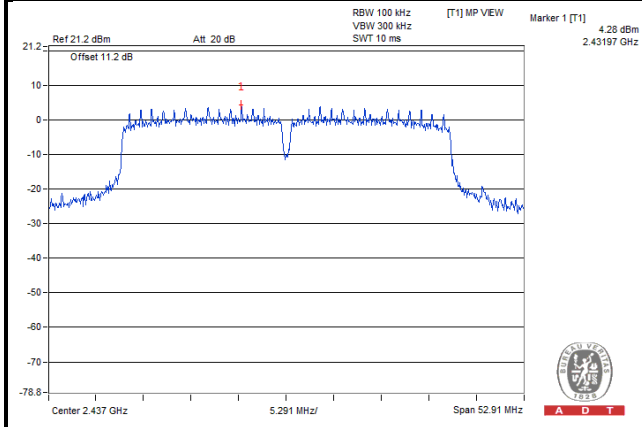

Ch 9

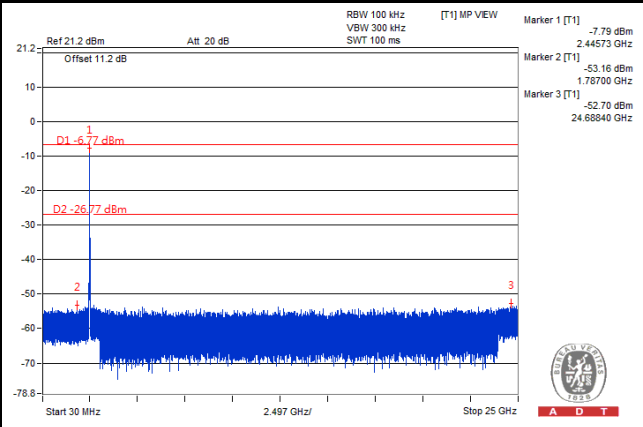
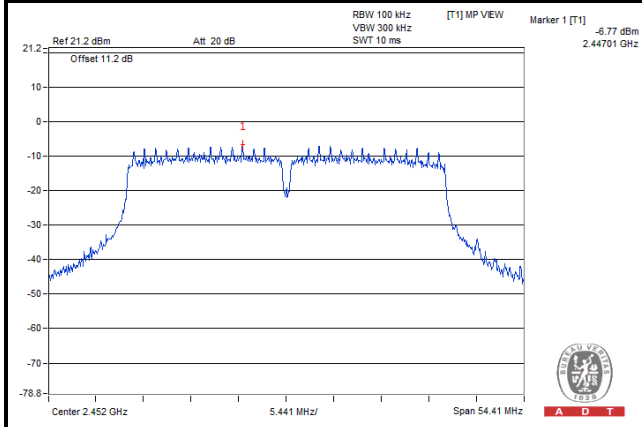

### Ch 3 Band Edge

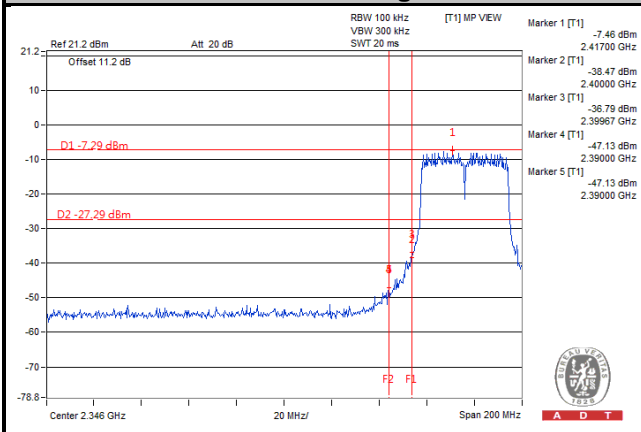

### Ch 9 Band Edge

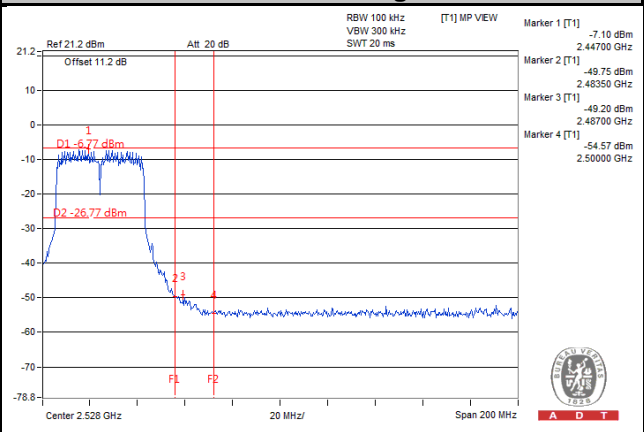

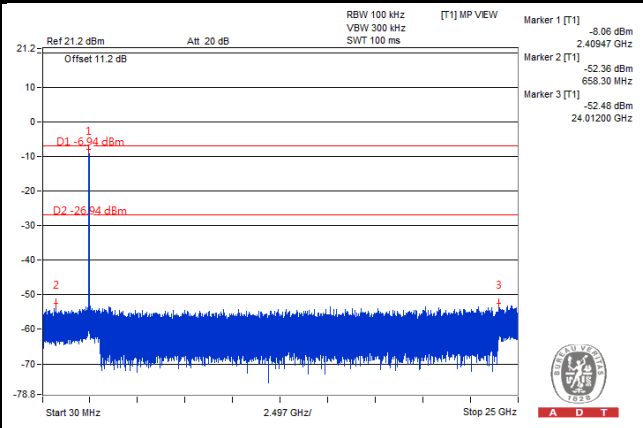
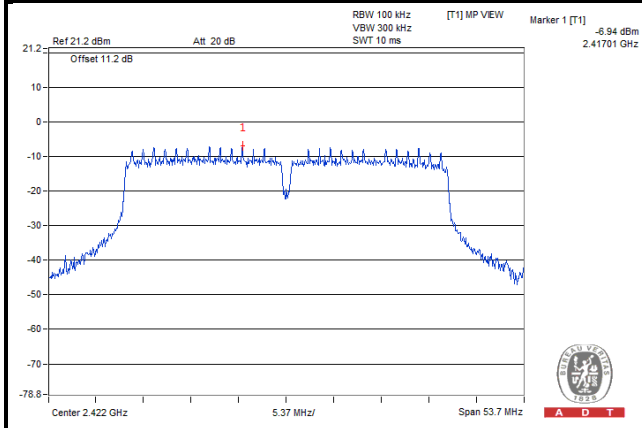
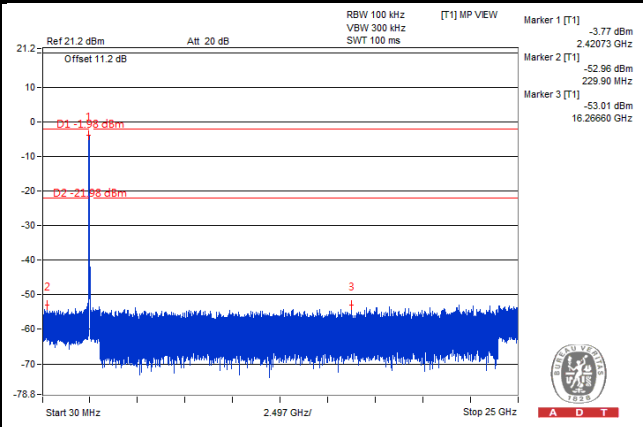
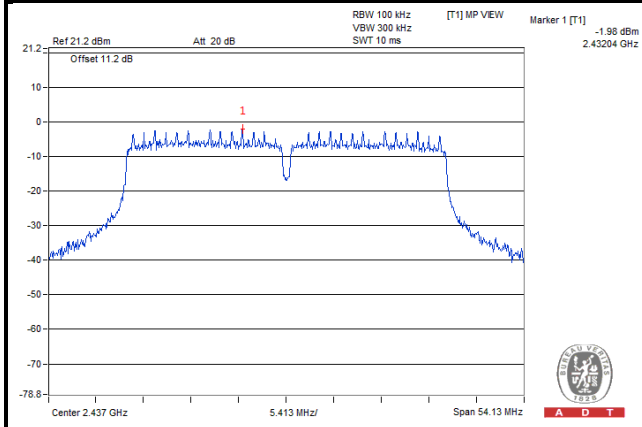
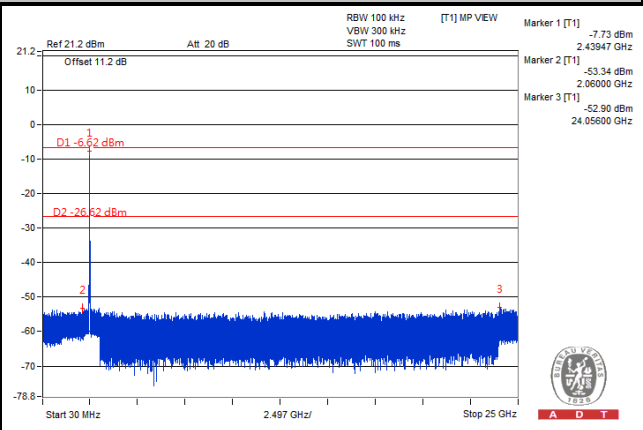
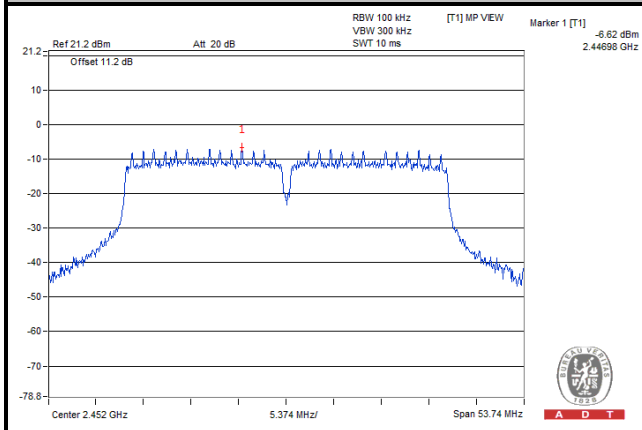
**CHAIN 2****Ch 3****Ch 6****Ch 9**



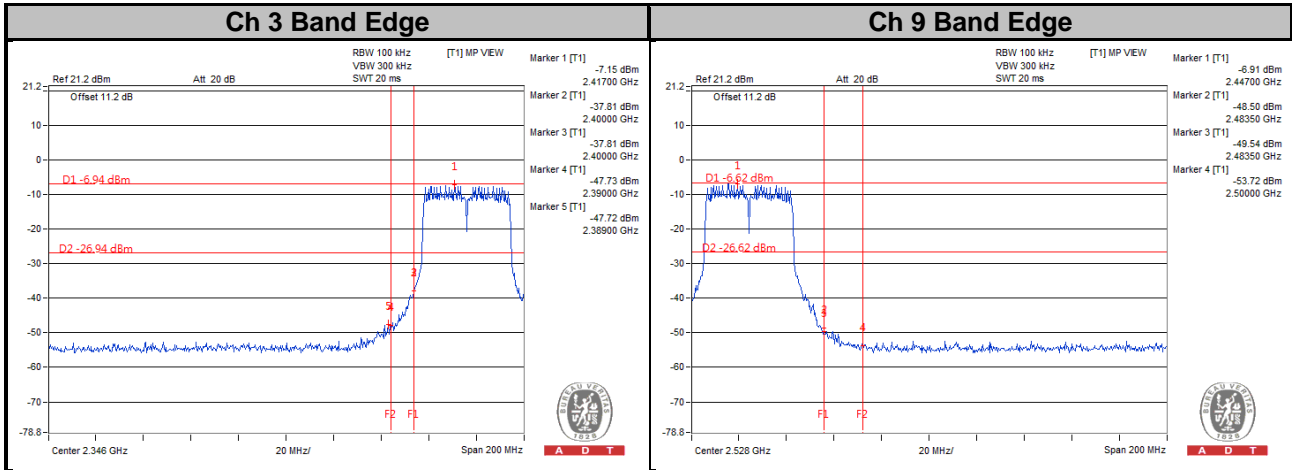

**Mode B**  
**802.11b**  
**CHAIN 0**

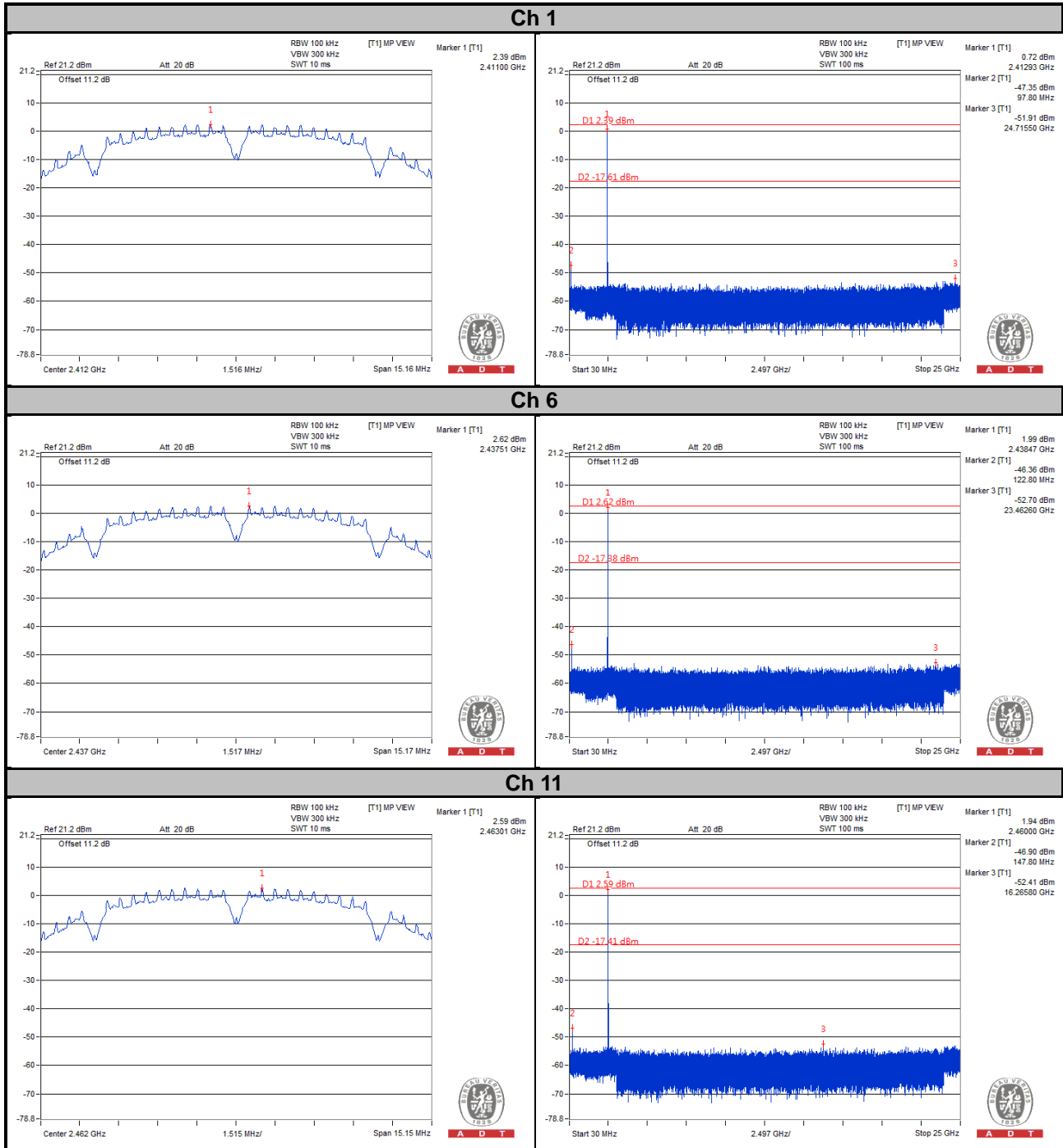

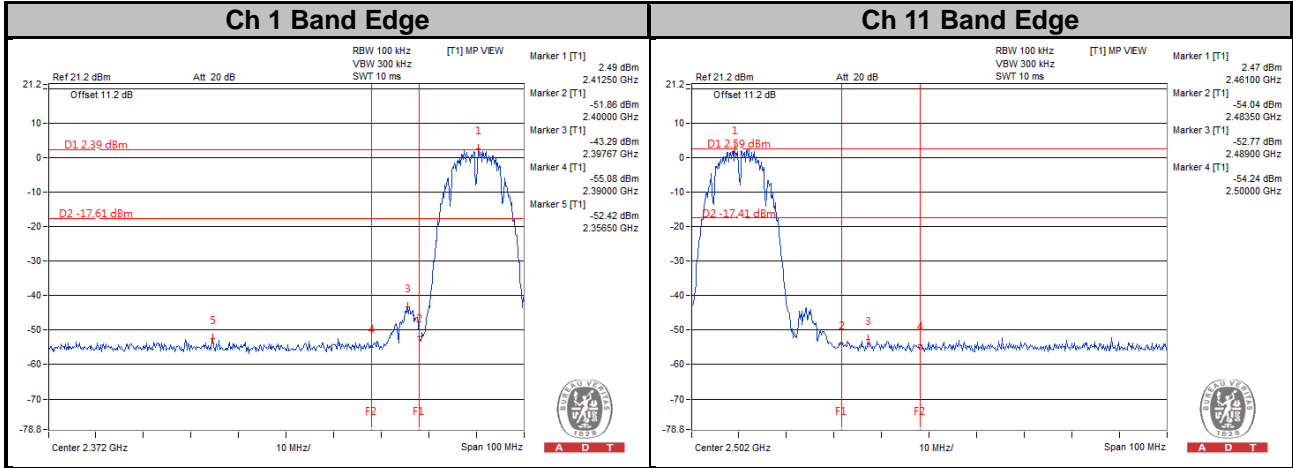

# CHAIN 1

## Ch 1

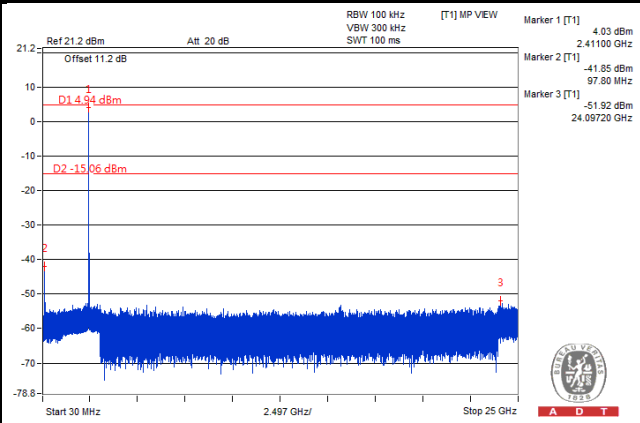
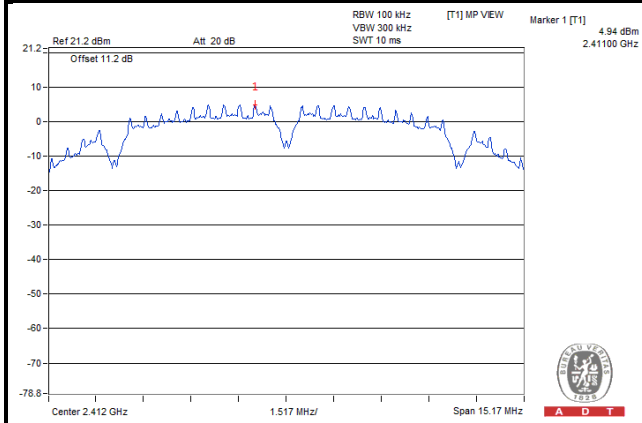

## Ch 6

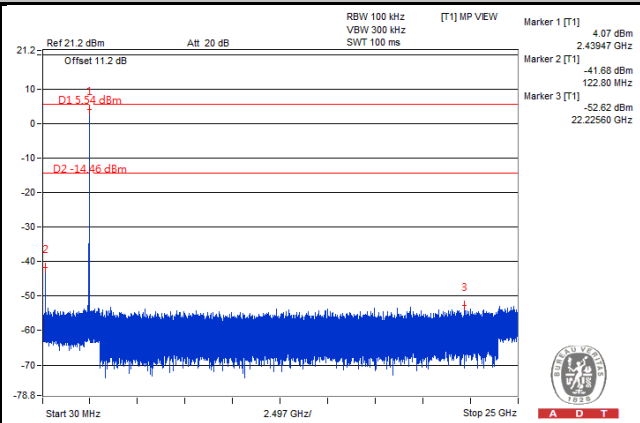
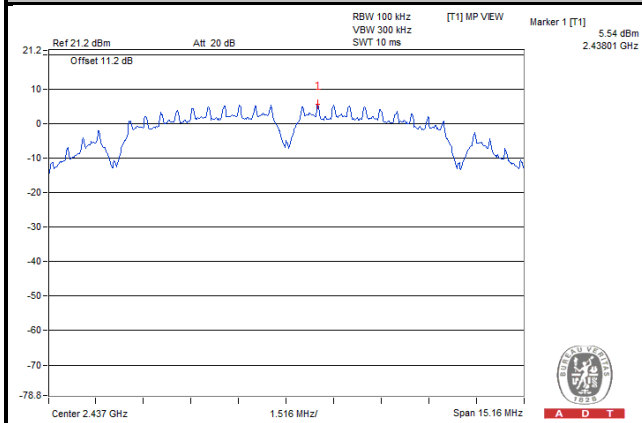

## Ch 11

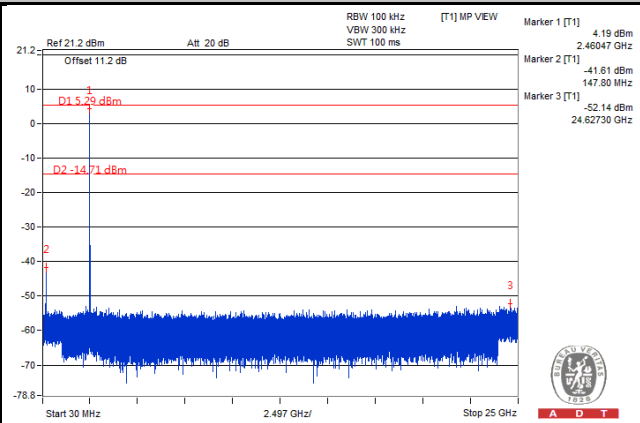
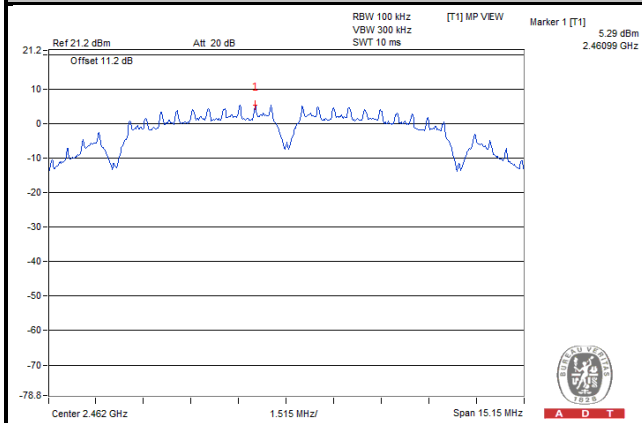

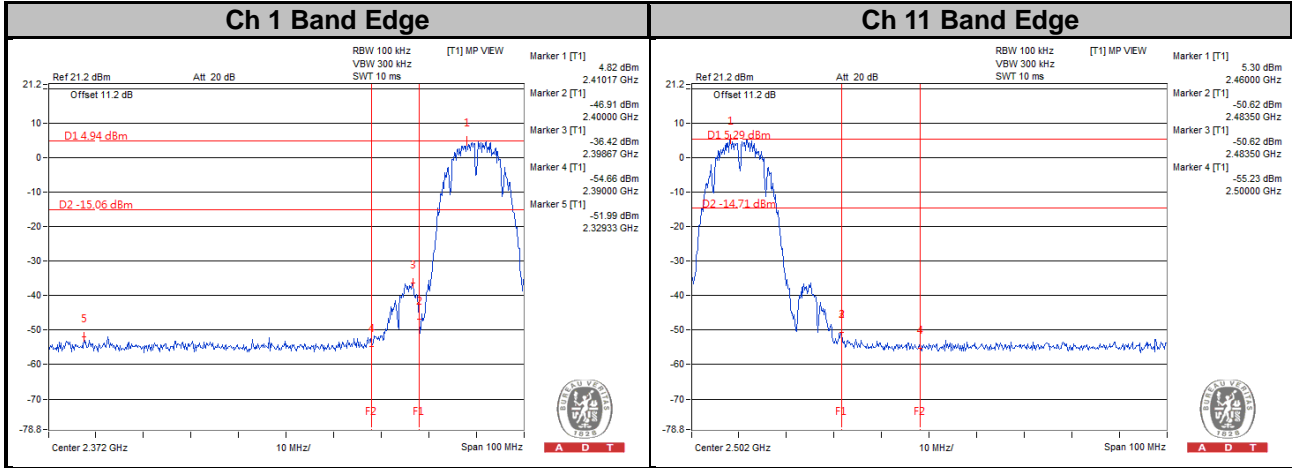

CHAIN 2

Ch 1

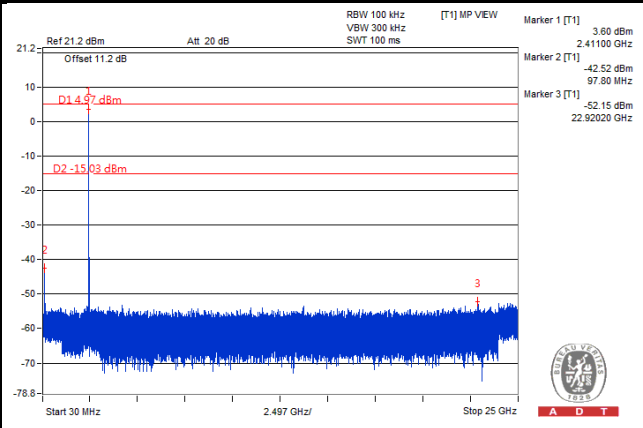
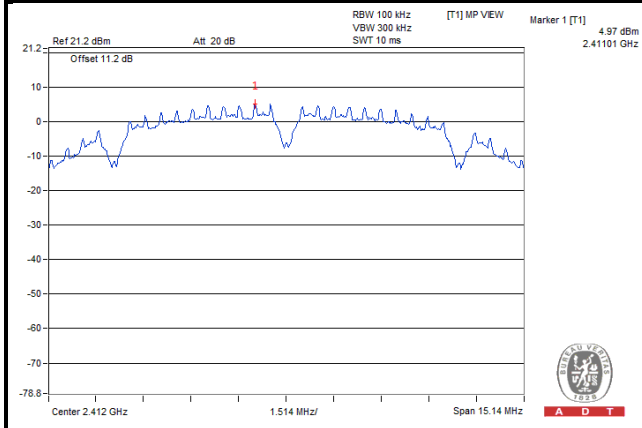

Ch 6

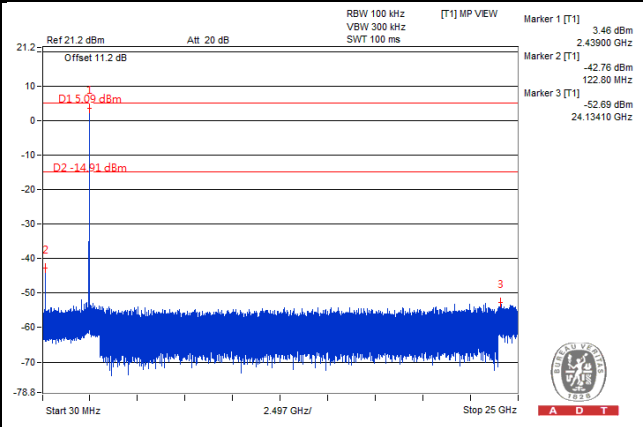
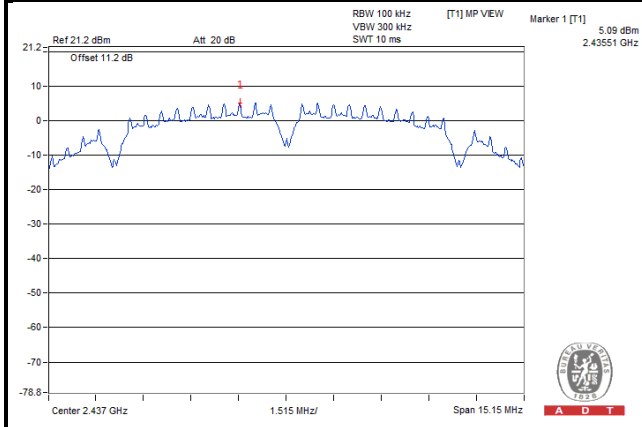

Ch 11

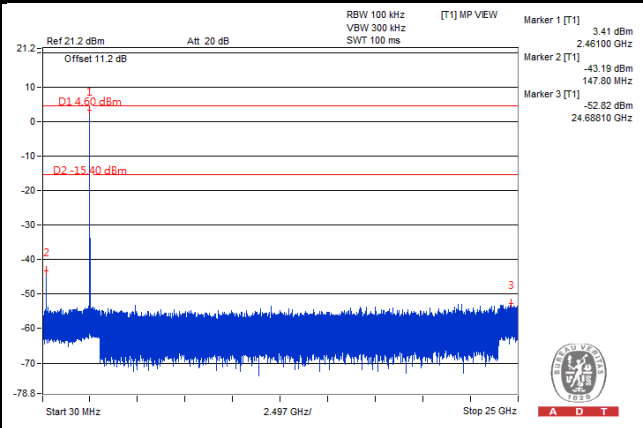
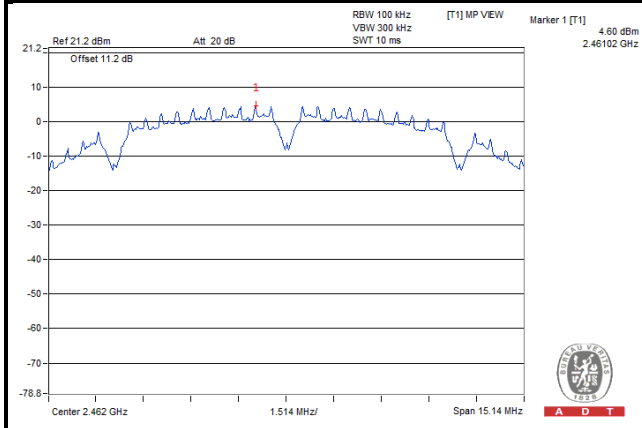

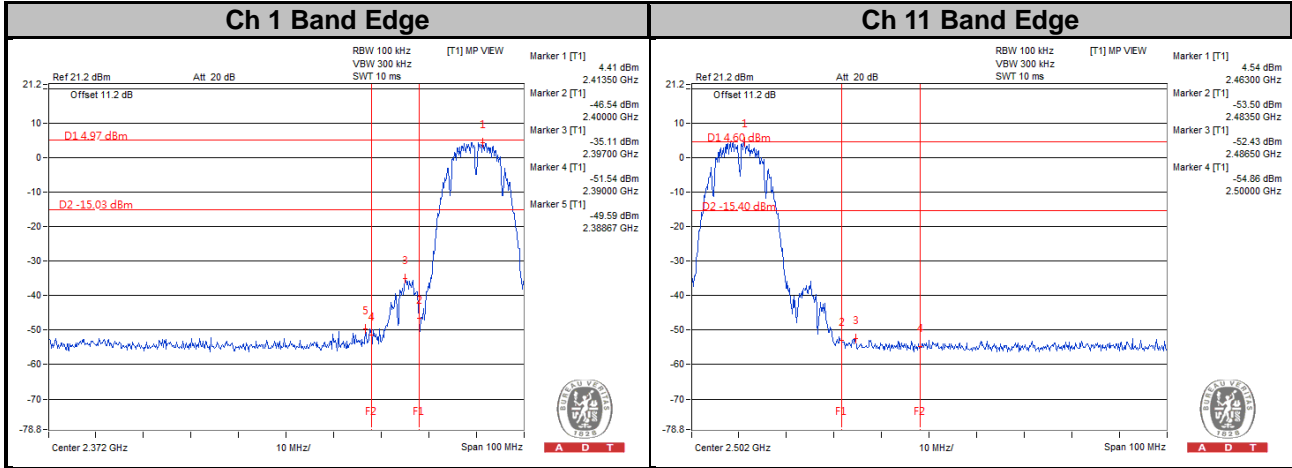

# 802.11g

## CHAIN 0

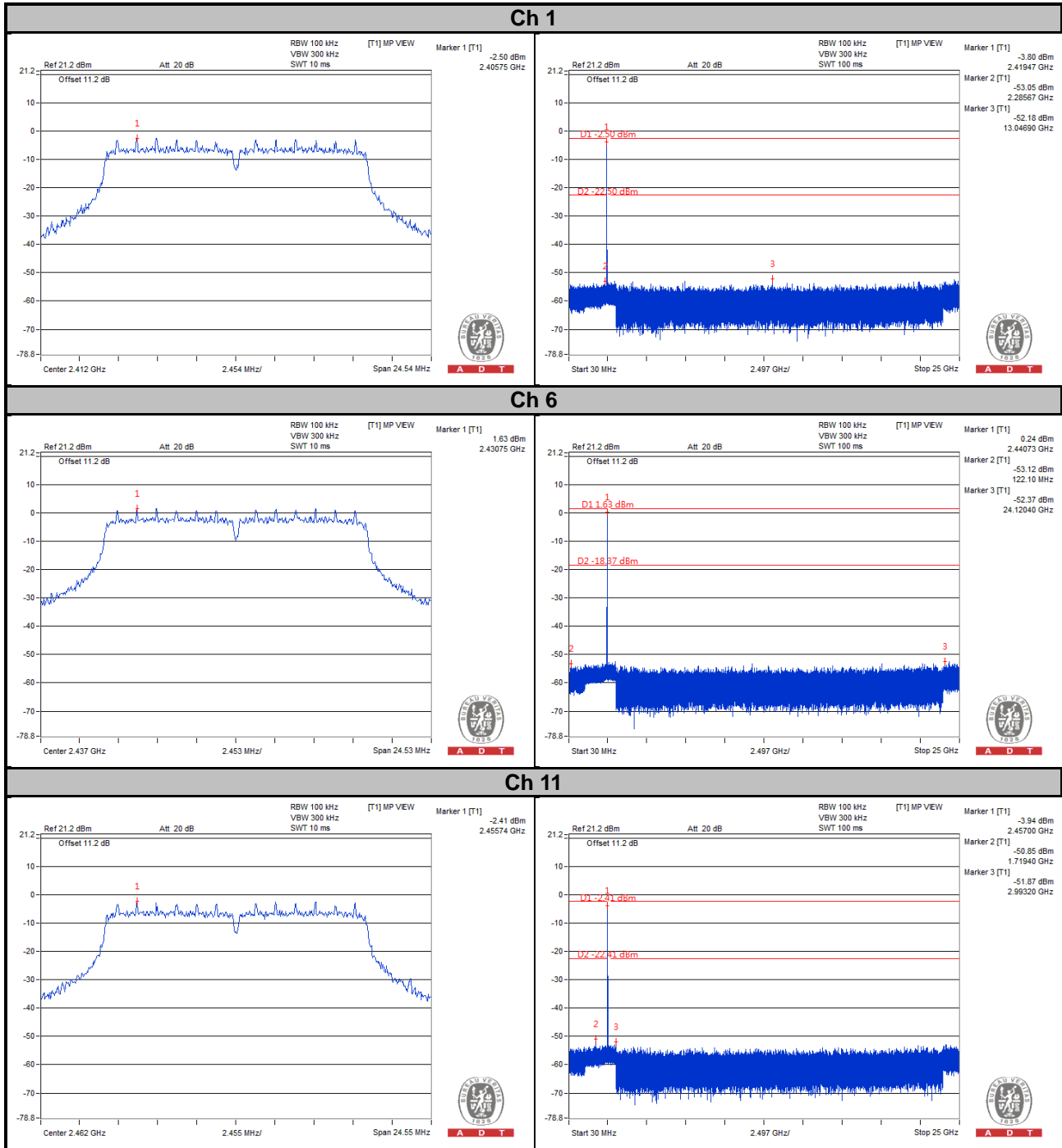



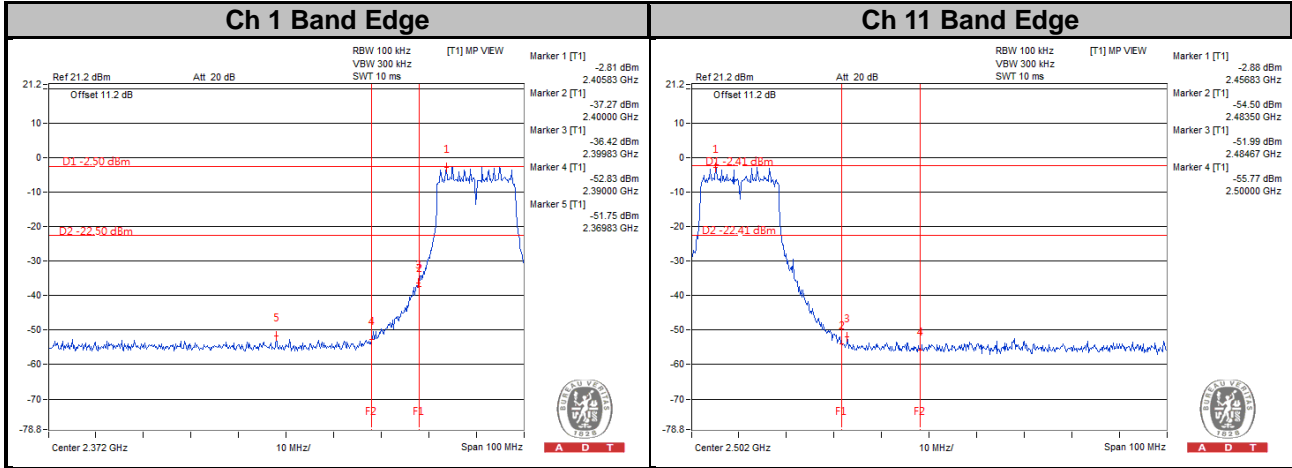

CHAIN 1

Ch 1

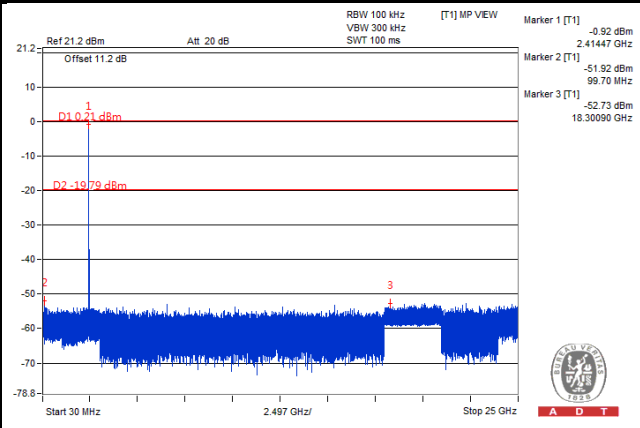
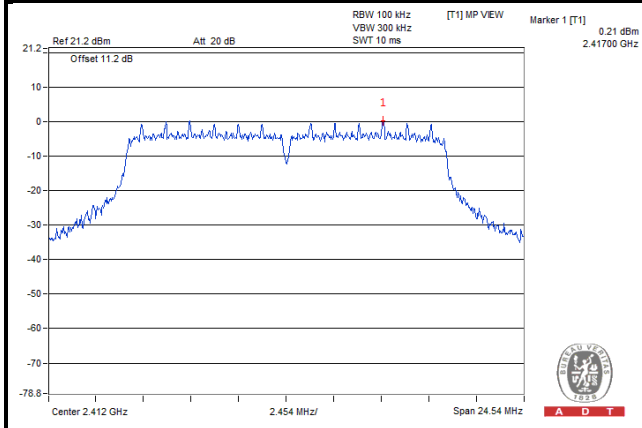

Ch 6

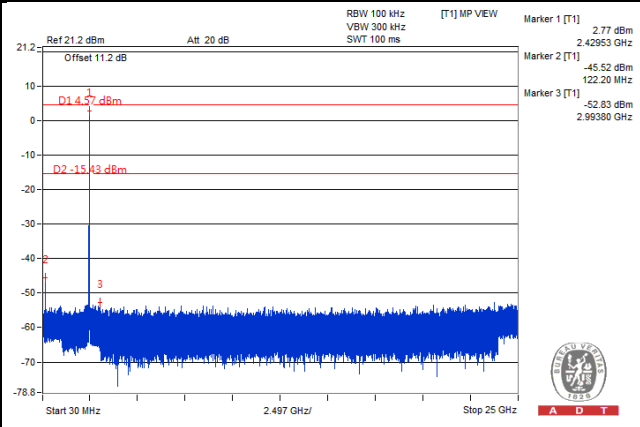
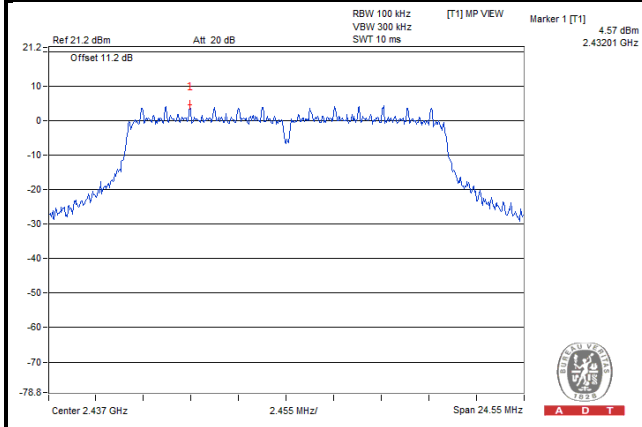

Ch 11

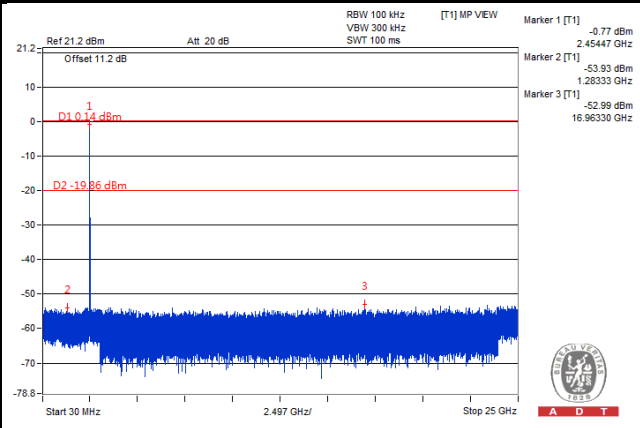
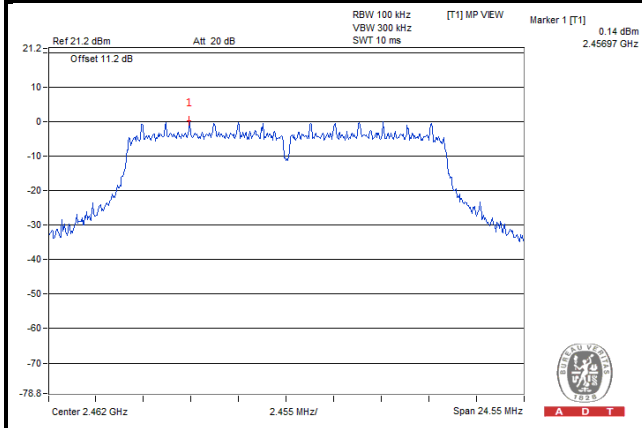

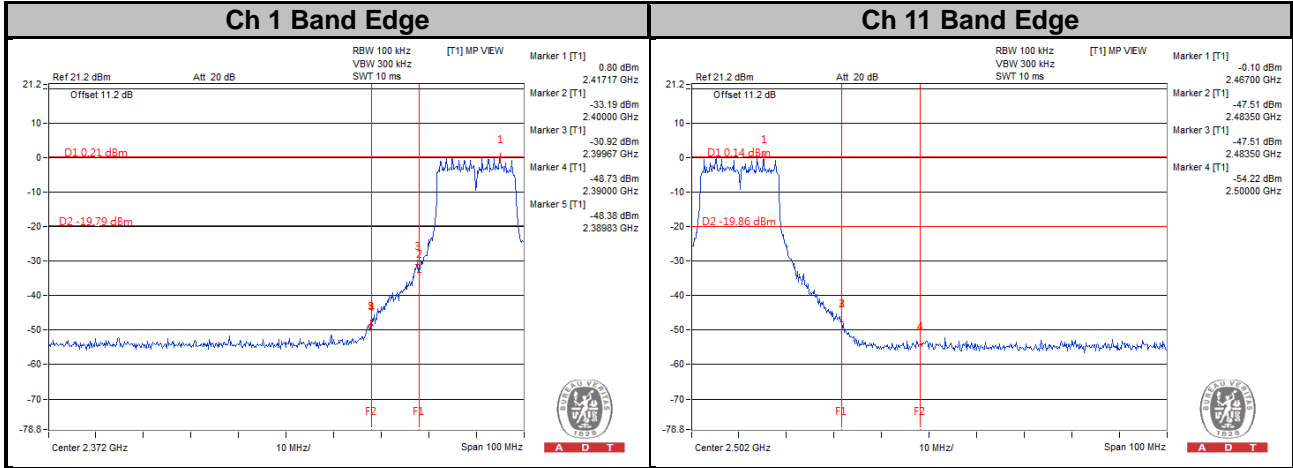

CHAIN 2

Ch 1

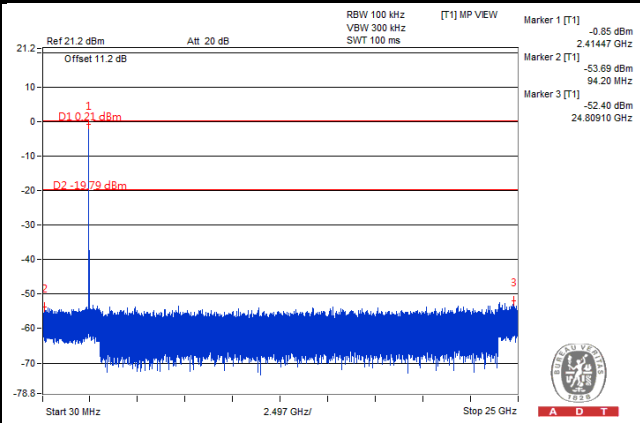
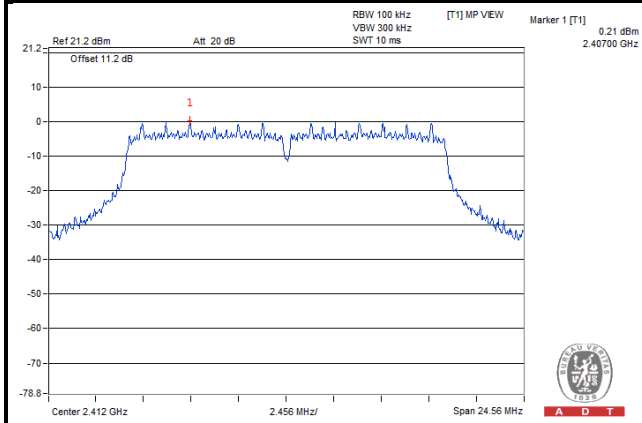

Ch 6

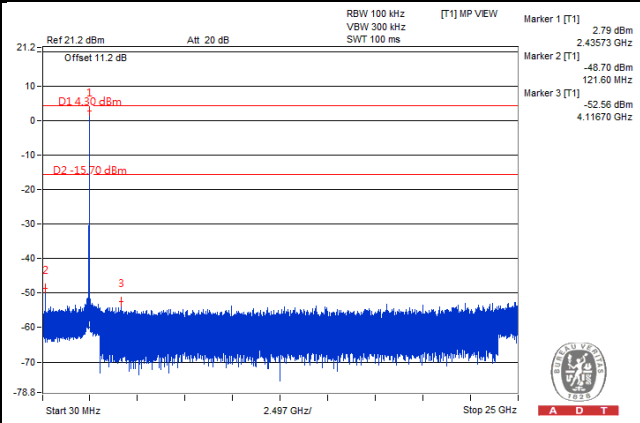
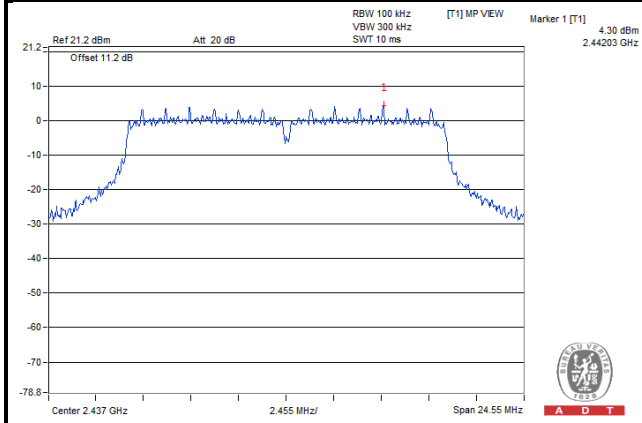

Ch 11

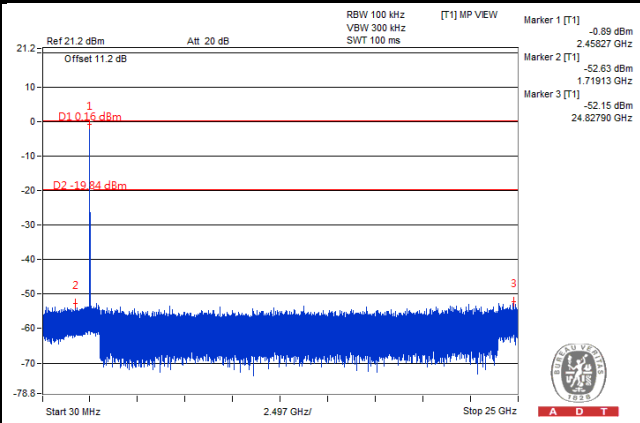
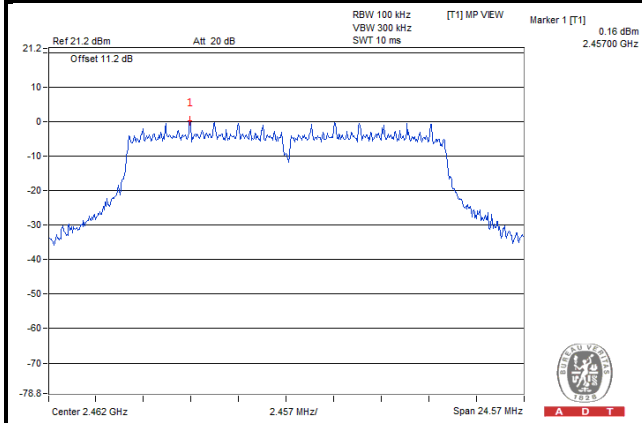

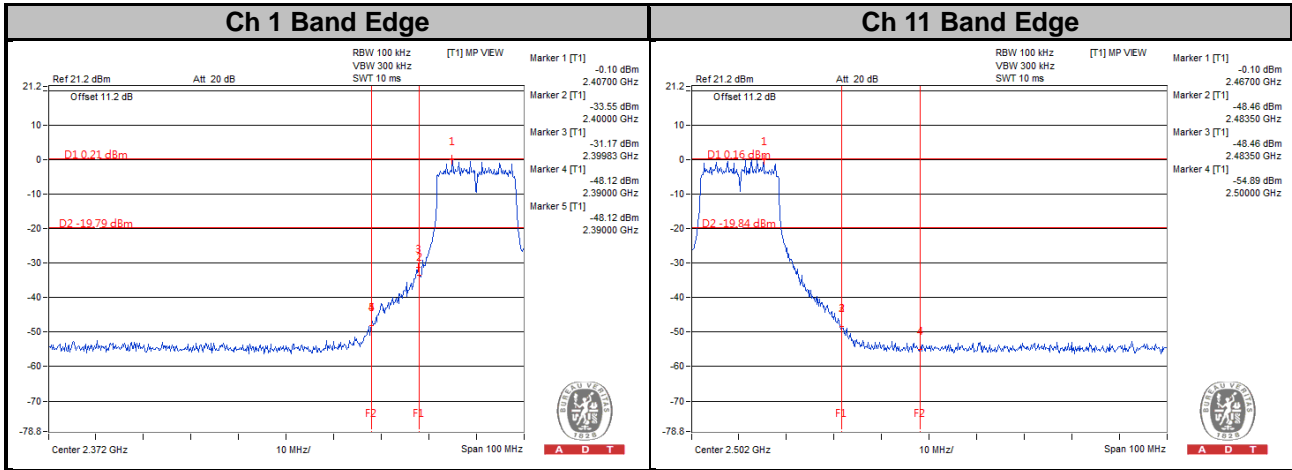

802.11n (HT20)  
CHAIN 0

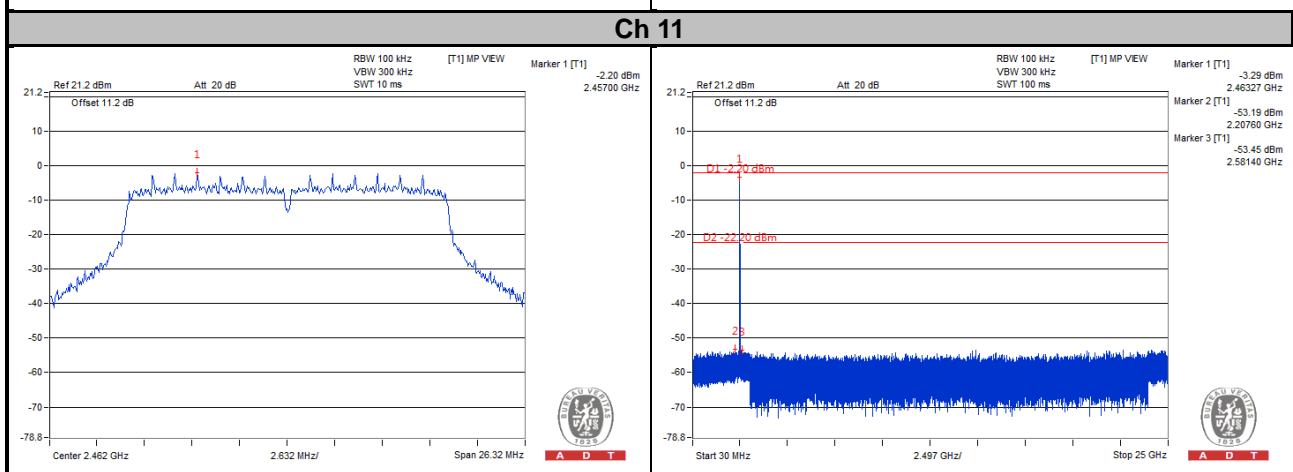
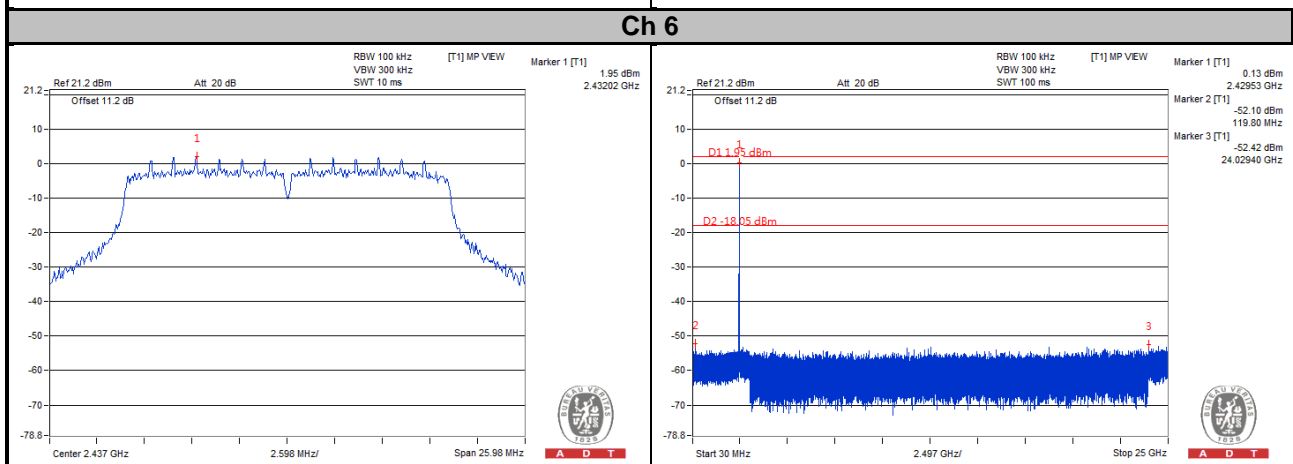
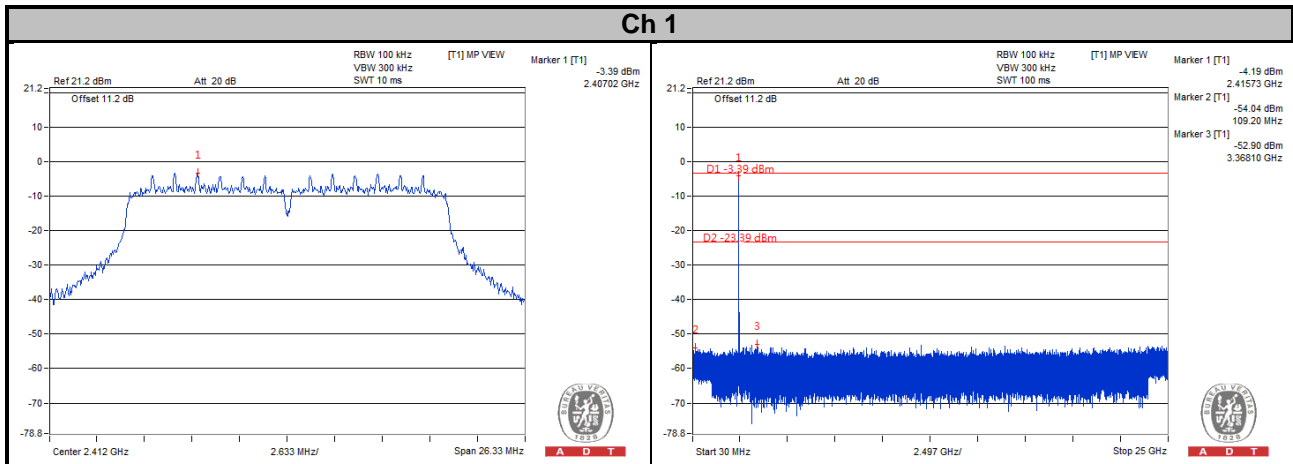

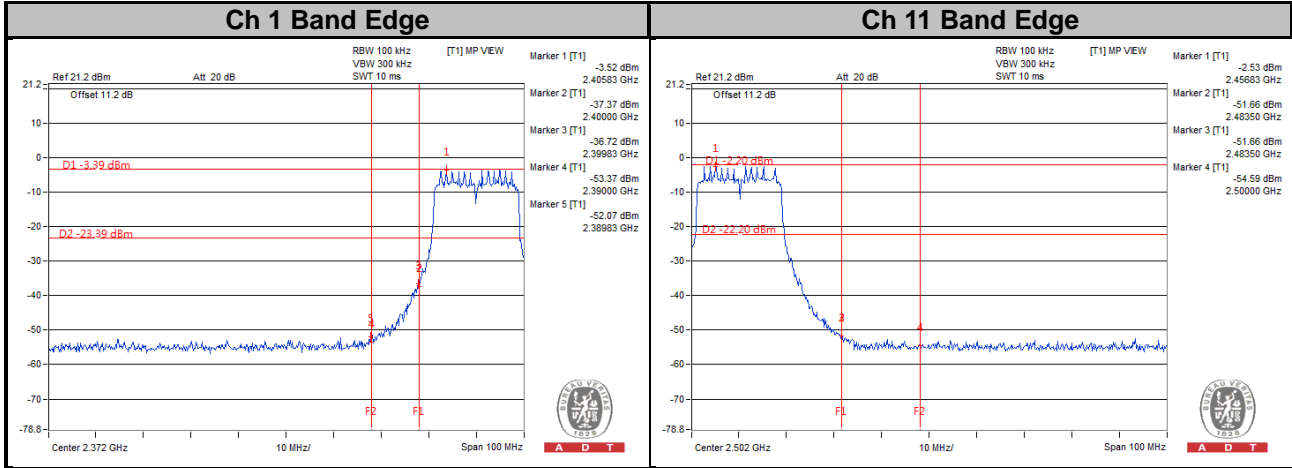

CHAIN 1

Ch 1

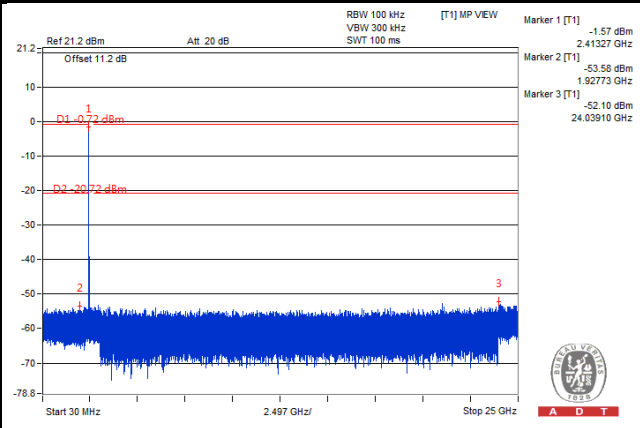
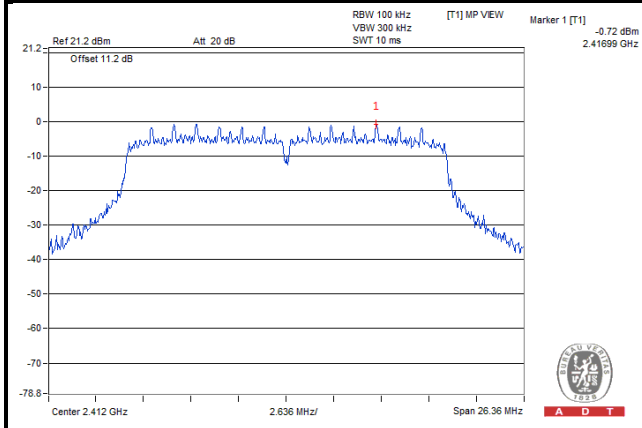

Ch 6

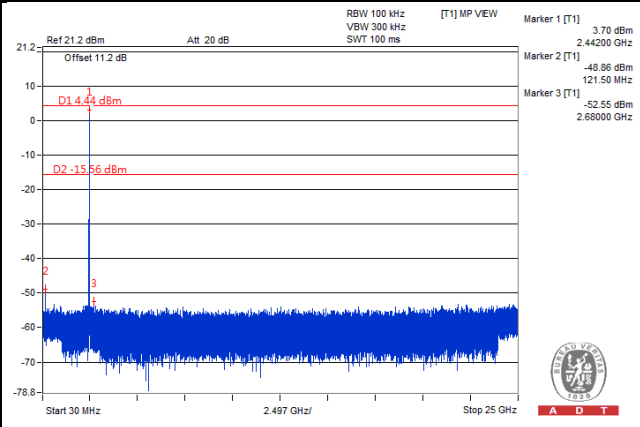
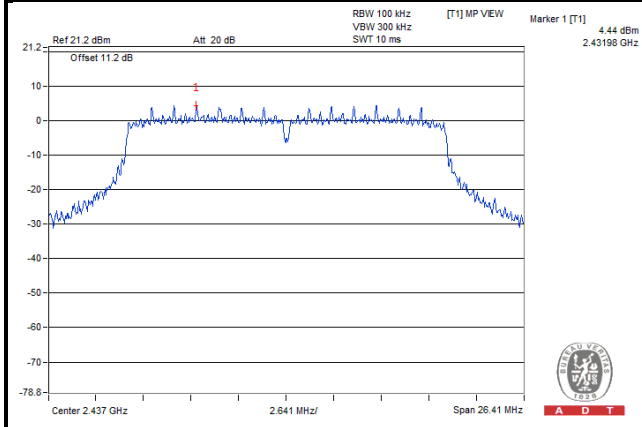

Ch 11

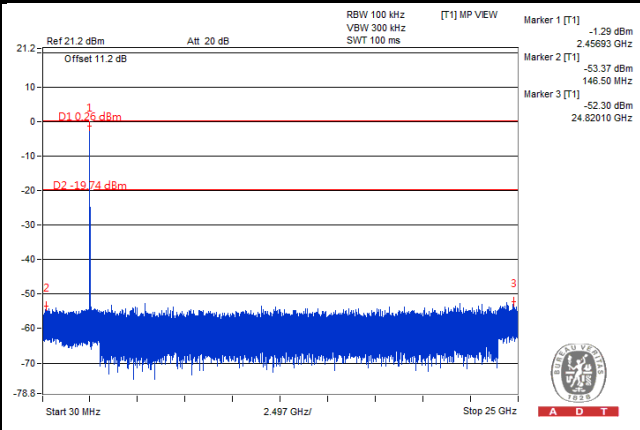
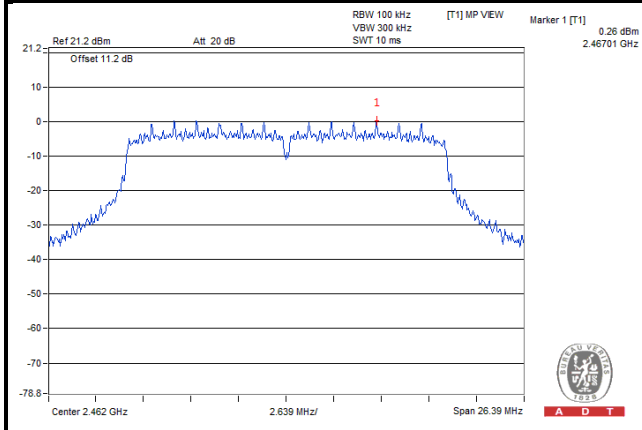



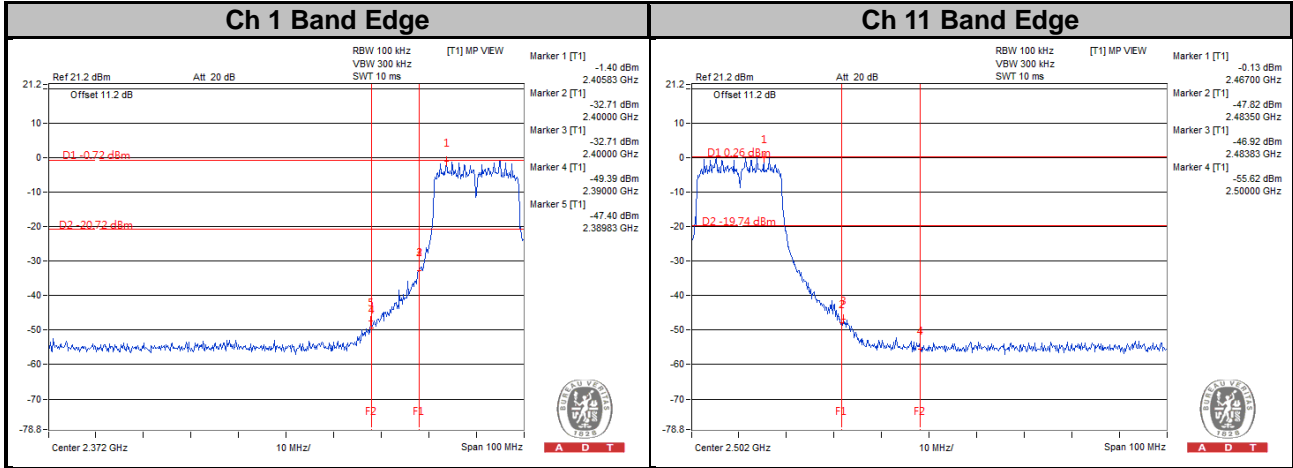

CHAIN 2

Ch 1

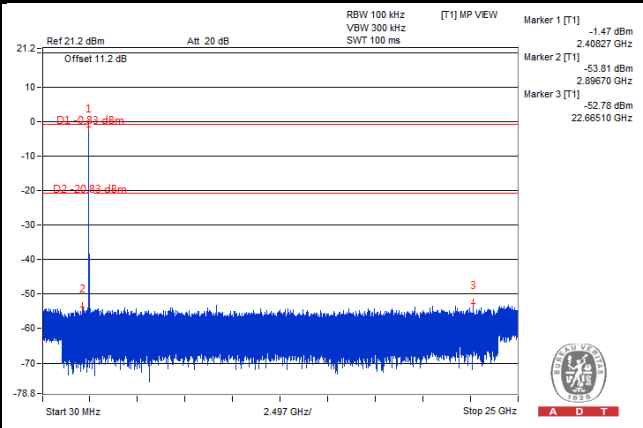
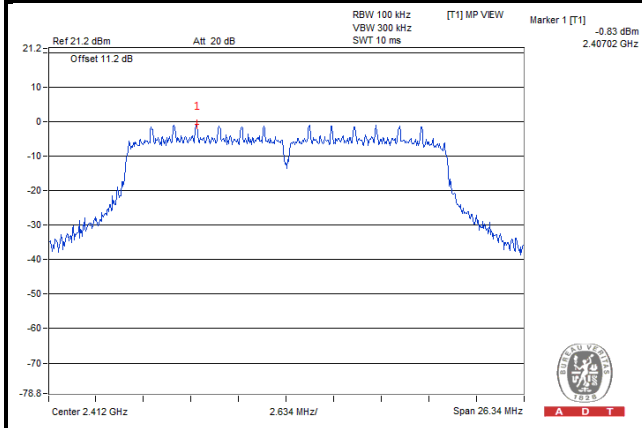

Ch 6

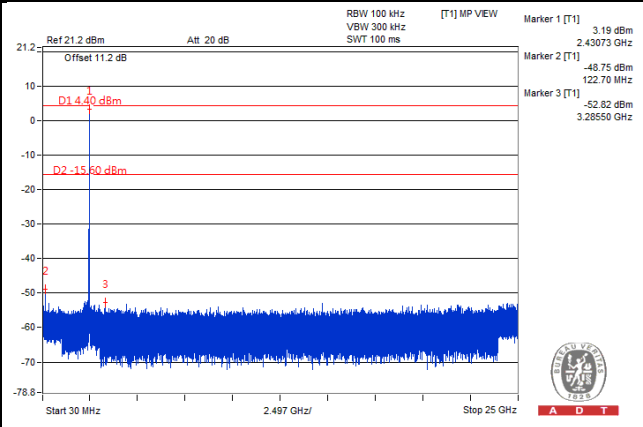
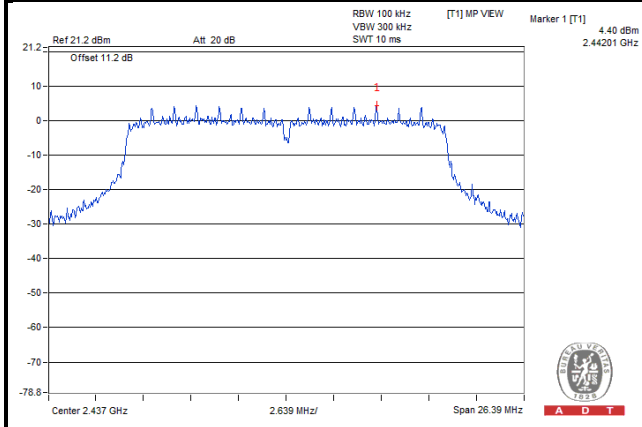

Ch 11

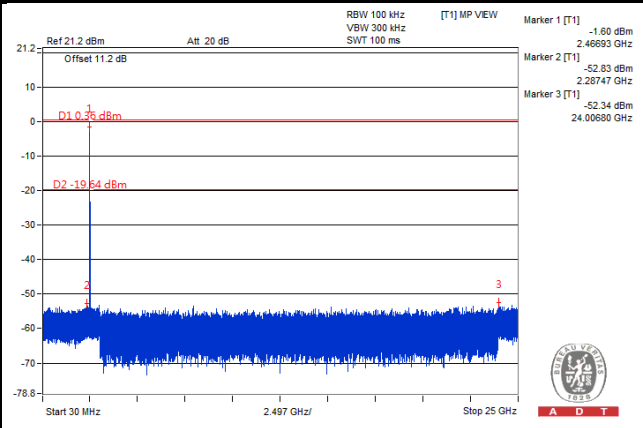
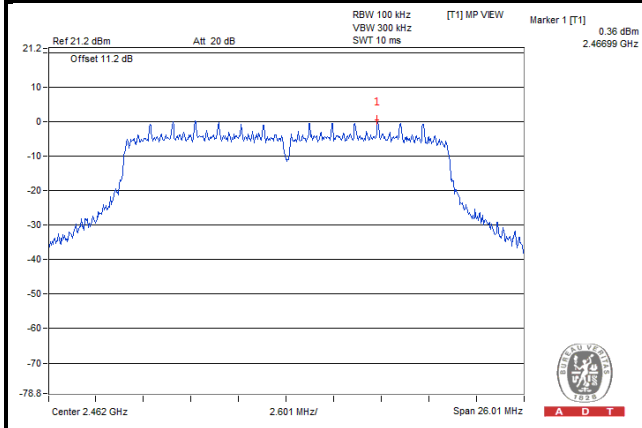

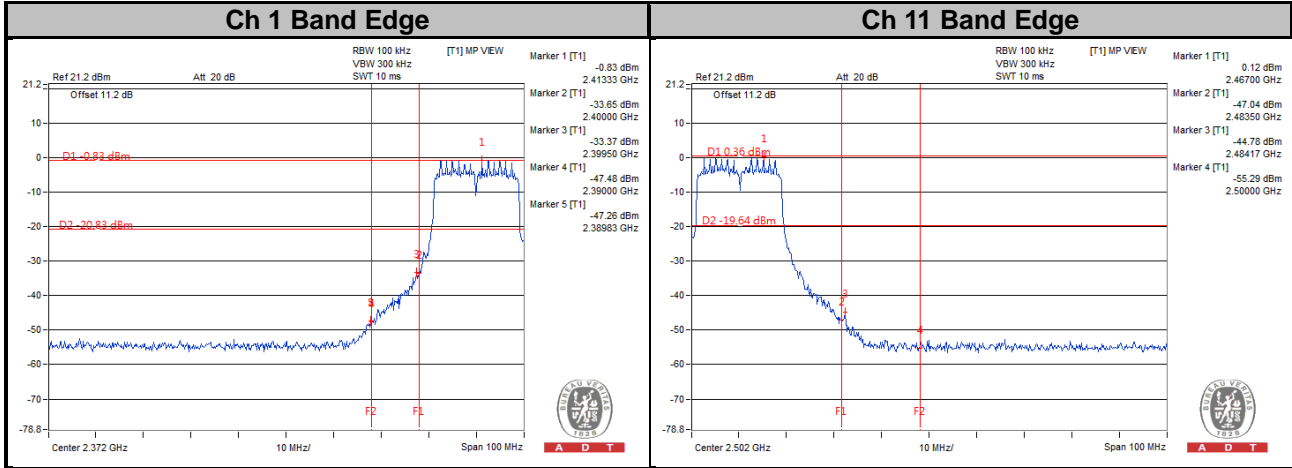

# 802.11n (HT40) CHAIN 0

## Ch 3

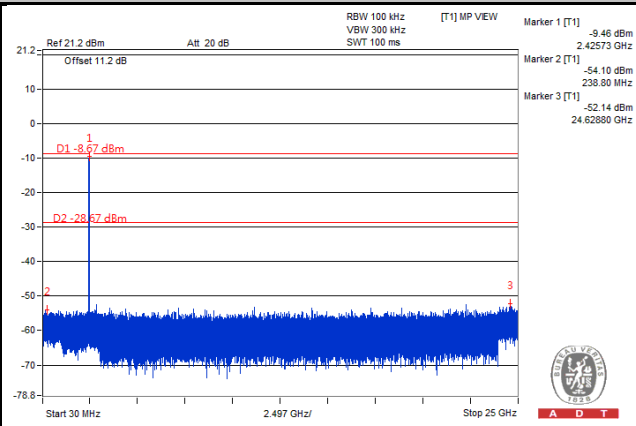
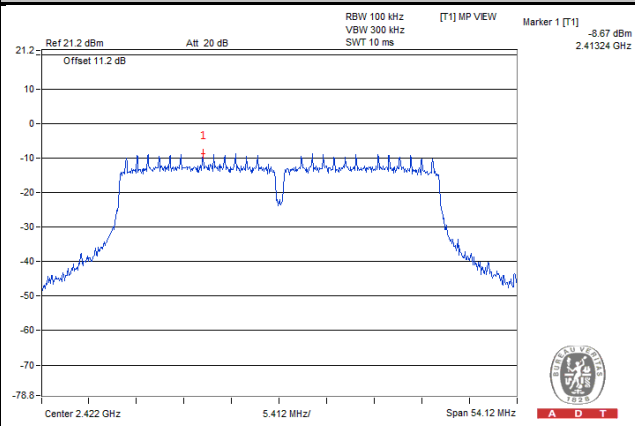

## Ch 6

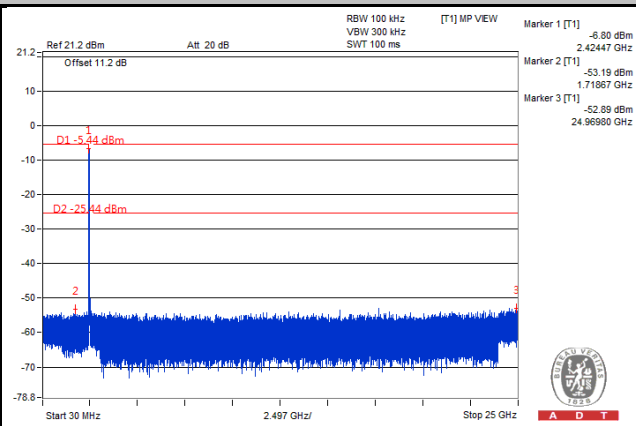
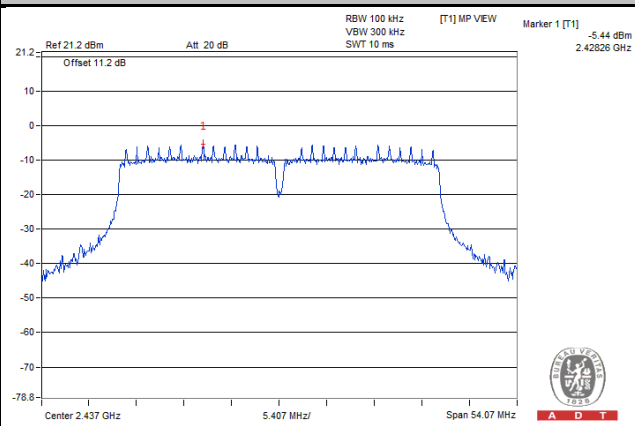

## Ch 9

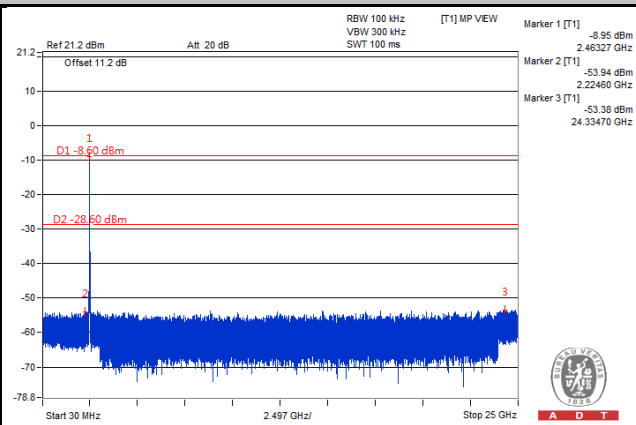
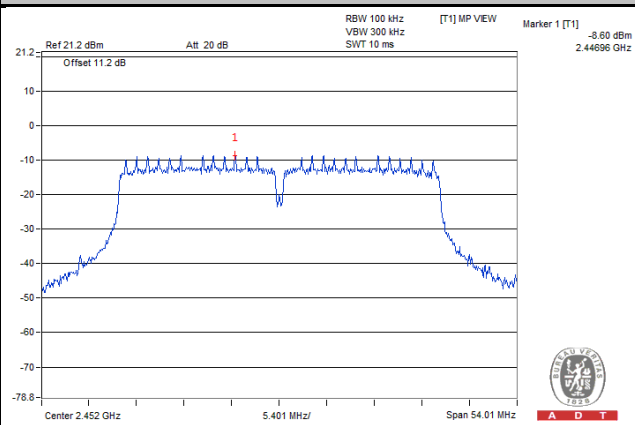

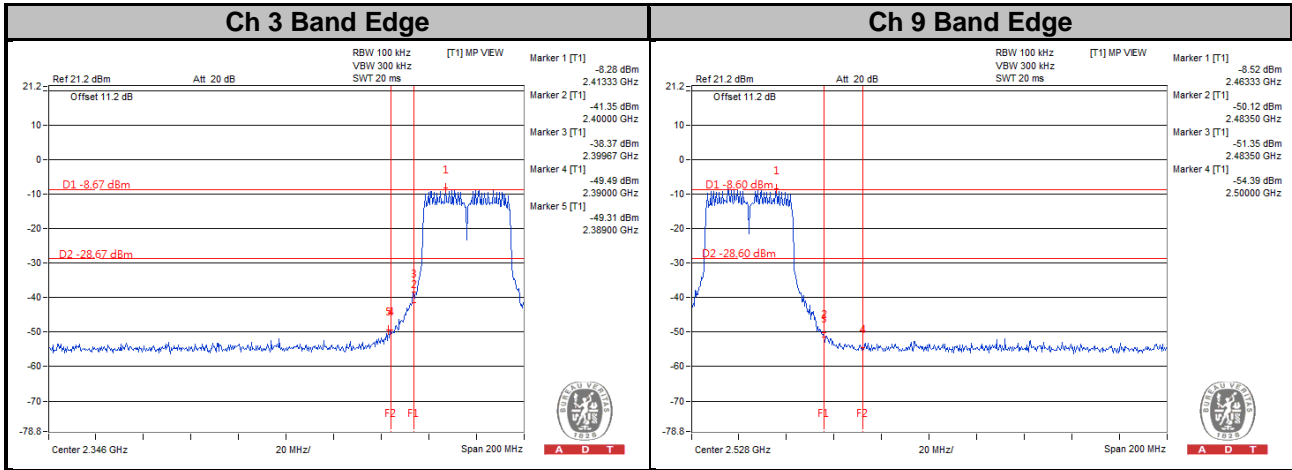

CHAIN 1

Ch 3

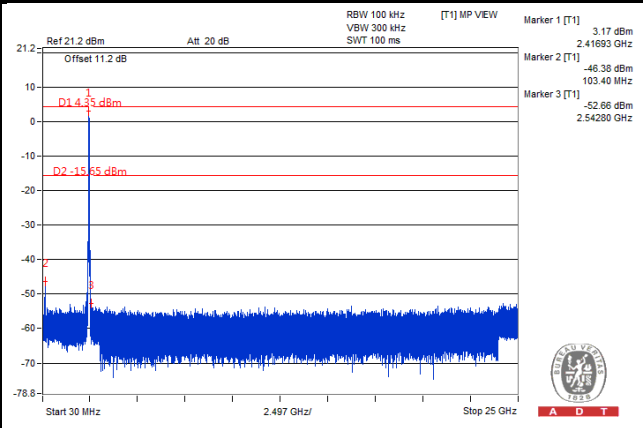
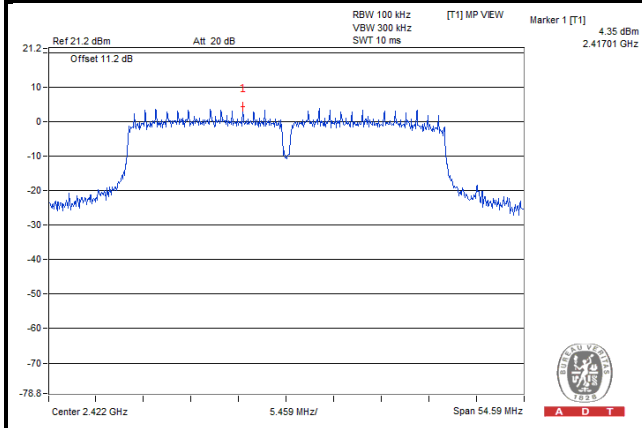

Ch 6

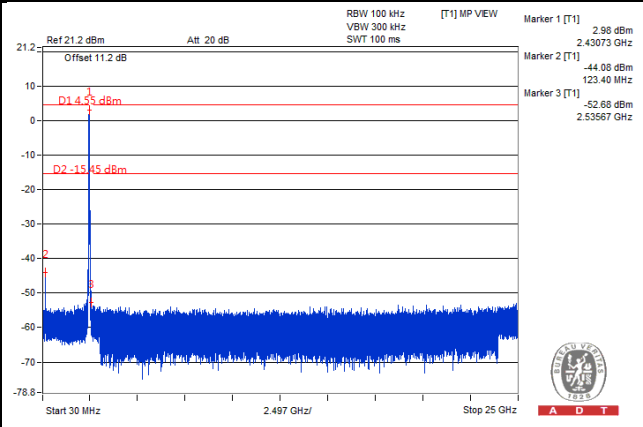
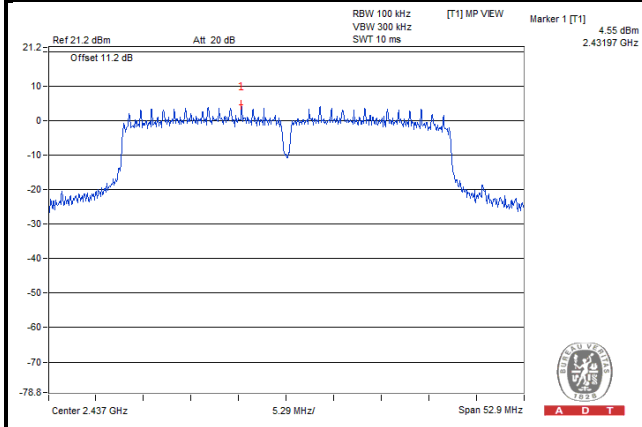

Ch 9

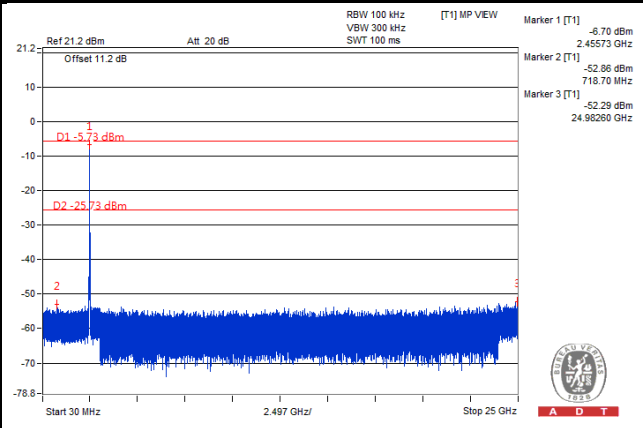
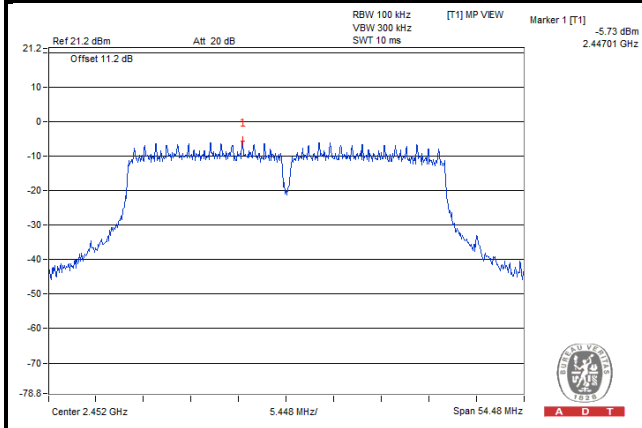

### Ch 3 Band Edge

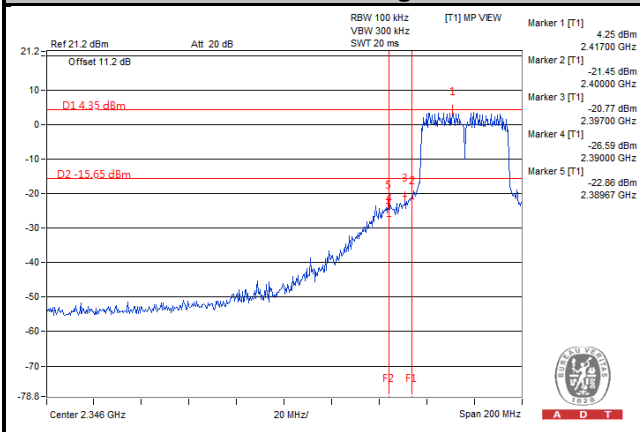

### Ch 9 Band Edge

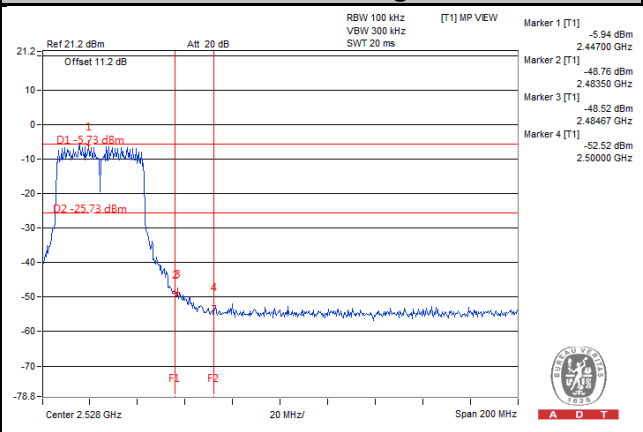

CHAIN 2

Ch 3

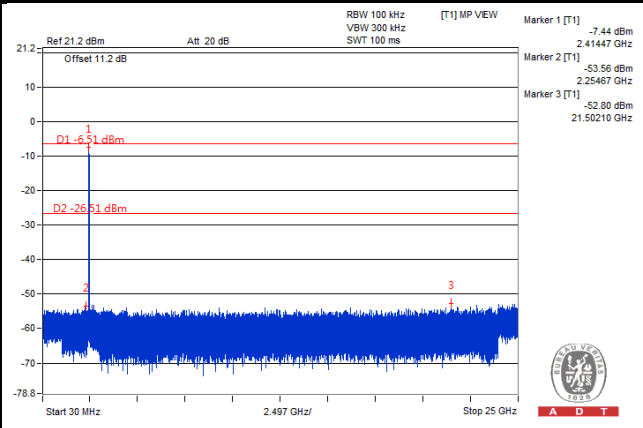
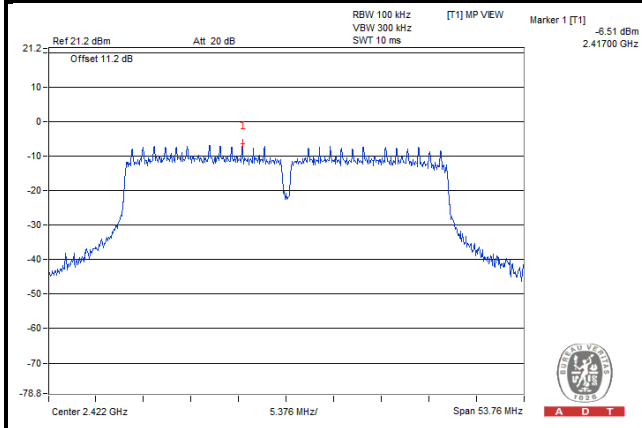

Ch 6

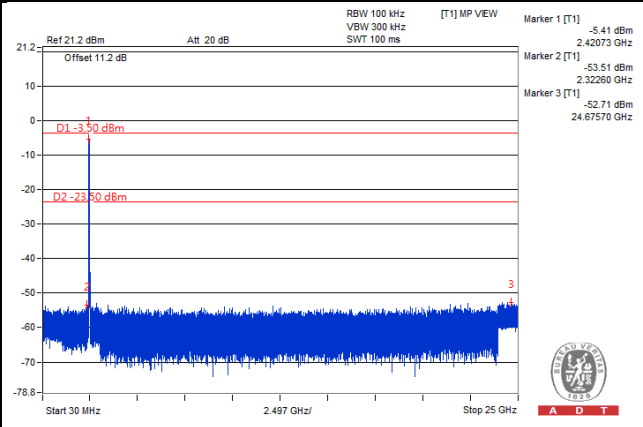
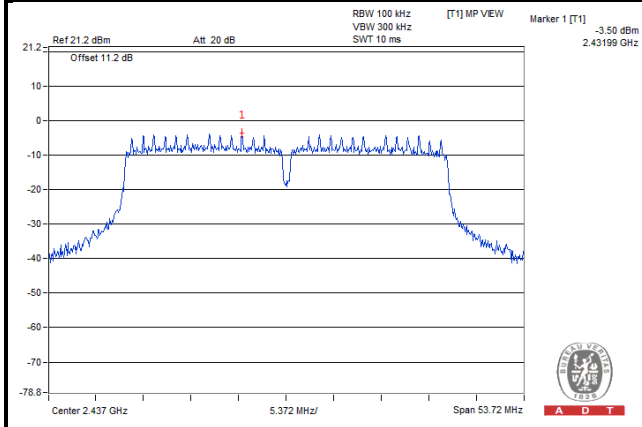

Ch 9

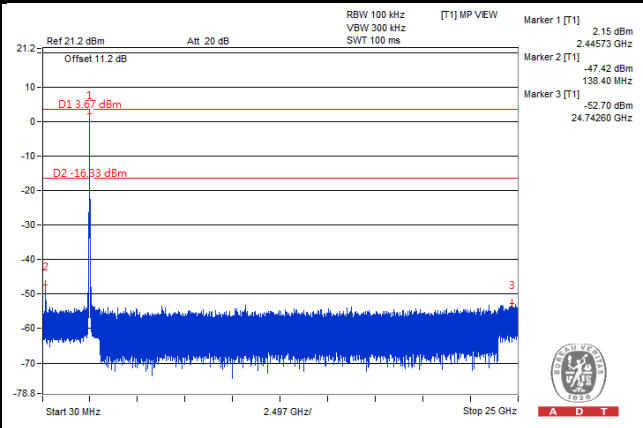
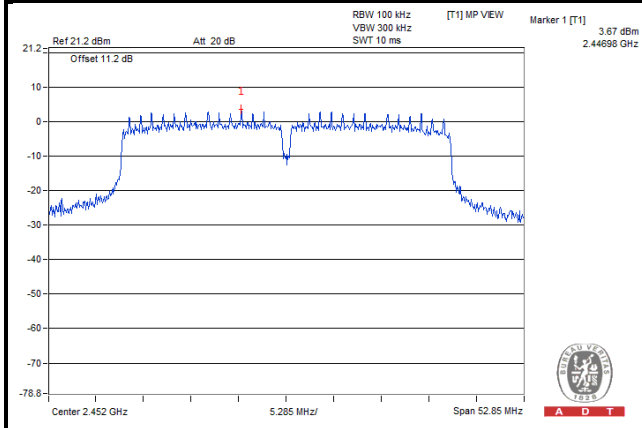



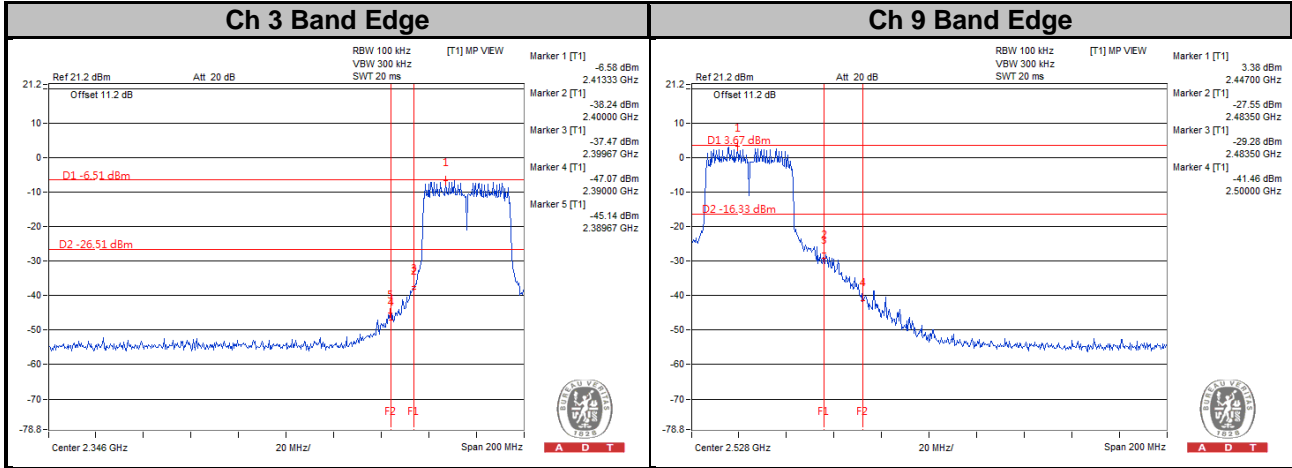



## 5 Pictures of Test Arrangements

Please refer to the attached file (Test Setup Photo).



A D T

## Appendix – Information on the Testing Laboratories

We, Bureau Veritas Consumer Products Services (H.K.) Ltd., Taoyuan Branch, were founded in 1988 to provide our best service in EMC, Radio, Telecom and Safety consultation. Our laboratories are accredited and approved according to ISO/IEC 17025.

If you have any comments, please feel free to contact us at the following:

### **Linko EMC/RF Lab**

Tel: 886-2-26052180

Fax: 886-2-26051924

### **Hsin Chu EMC/RF/Telecom Lab**

Tel: 886-3-6668565

Fax: 886-3-6668323

### **Hwa Ya EMC/RF/Safety Lab**

Tel: 886-3-3183232

Fax: 886-3-3270892

**Email:** [service.adt@tw.bureauveritas.com](mailto:service.adt@tw.bureauveritas.com)

**Web Site:** [www.bureauveritas-adt.com](http://www.bureauveritas-adt.com)

The address and road map of all our labs can be found in our web site also.

--- END ---