

FCC Test Report

Report No.: RF151102C18-1

FCC ID: YHI-NW121

Test Model: NW-121

Received Date: Nov. 02, 2015

Test Date: Nov. 21, 2015 ~ Dec. 16, 2015

Issued Date: Dec. 22, 2015

Applicant: NEXCOM International Co., Ltd.

Address: 9F, No. 920, Chung-Cheng Rd., Zhonghe Dist., New Taipei City 235, Taiwan

Issued By: Bureau Veritas Consumer Products Services (H.K.) Ltd., Taoyuan Branch

Lab Address: No. 47-2, 14th Ling, Chia Pau Vil., Lin Kou Dist., New Taipei City, Taiwan
(R.O.C)

Test Location : No.215, Sec. 3, Beixin Rd., Xindian Dist., New Taipei City 231, Taiwan,
R.O.C



This report is for your exclusive use. Any copying or replication of this report to or for any other person or entity, or use of our name or trademark, is permitted only with our prior written permission. This report sets forth our findings solely with respect to the test samples identified herein. The results set forth in this report are not indicative or representative of the quality or characteristics of the lot from which a test sample was taken or any similar or identical product unless specifically and expressly noted. Our report includes all of the tests requested by you and the results thereof based upon the information that you provided to us. You have 60 days from date of issuance of this report to notify us of any material error or omission caused by our negligence, provided, however, that such notice shall be in writing and shall specifically address the issue you wish to raise. A failure to raise such issue within the prescribed time shall constitute your unqualified acceptance of the completeness of this report, the tests conducted and the correctness of the report contents. Unless specific mention, the uncertainty of measurement has been explicitly taken into account to declare the compliance or non-compliance to the specification. The report must not be used by the client to claim product certification, approval, or endorsement by TAF or any government agencies.

Table of Contents

Release Control Record	4
1 Certificate of Conformity	5
2 Summary of Test Results.....	6
2.1 Measurement Uncertainty.....	6
2.2 Modification Record	6
3 General Information	7
3.1 General Description of EUT	7
3.2 Description of Test Modes.....	8
3.2.1 Test Mode Applicability and Tested Channel Detail.....	9
3.3 Duty Cycle of Test Signal	11
3.4 Description of Support Units	21
3.4.1 Configuration of System under Test	21
3.5 General Description of Applied Standards.....	21
4 Test Types and Results	22
4.1 Radiated Emission and Bandedge Measurement	22
4.1.1 Limits of Radiated Emission and Bandedge Measurement	22
4.1.2 Limits of Unwanted Emission Out of The Restricted Bands.....	22
4.1.3 Test Instruments	23
4.1.4 Test Procedures.....	24
4.1.5 Deviation from Test Standard	24
4.1.6 Test Set Up	25
4.1.7 EUT Operating Conditions.....	25
4.1.8 Test Results	26
4.2 Conducted Emission Measurement.....	66
4.2.1 Limits of Conducted Emission Measurement	66
4.2.2 Test Instruments	66
4.2.3 Test Procedures.....	67
4.2.4 Deviation from Test Standard	67
4.2.5 Test Setup.....	67
4.2.6 EUT Operating Conditions.....	67
4.2.7 Test Results	68
4.3 Transmit Power Measurement.....	72
4.3.1 Limits of Transmit Power Measurement	72
4.3.2 Test Setup.....	72
4.3.3 Test Instruments	73
4.3.4 Test Procedure	73
4.3.5 Deviation from Test Standard	73
4.3.6 EUT Operating Conditions.....	73
4.3.7 Test Result	74
4.4 Peak Power Spectral Density Measurement	80
4.4.1 Limits of Peak Power Spectral Density Measurement	80
4.4.2 Test Setup.....	80
4.4.3 Test Instruments	80
4.4.4 Test Procedures.....	80
4.4.5 Deviation from Test Standard	81
4.4.6 EUT Operating Conditions.....	81
4.4.7 Test Results	82
4.5 Frequency Stability	94
4.5.1 Limit of Frequency Stability Measurement	94
4.5.2 Test Setup.....	94
4.5.3 Test Instruments	94
4.5.4 Test Procedure	94
4.5.5 Deviation from Test Standard	94



4.5.6 EUT Operating Condition	94
4.5.7 Test Results	95
4.6 6dB Bandwidth Measurement.....	97
4.6.1 Limits of 6dB Bandwidth Measurement.....	97
4.6.2 Test Setup.....	97
4.6.3 Test Instruments	97
4.6.4 Test Procedure	97
4.6.5 Deviation from Test Standard	97
4.6.6 EUT Operating Condition	97
4.6.7 Test Results	98
5 Pictures of Test Arrangements.....	102
Appendix – Information on the Testing Laboratories	103



A D T

Release Control Record

Issue No.	Description	Date Issued
RF151102C18-1	Original Release	Dec. 22, 2015

1 Certificate of Conformity

Product: 3x3 11ac/n/g/b/a 2.4/5GHz WiFi Module

Brand: NEXCOM

Test Model: NW-121

Sample Status: Identical Prototype

Applicant: NEXCOM International Co., Ltd.

Test Date: Nov. 21, 2015 ~ Dec. 16, 2015

Standards: 47 CFR FCC Part 15, Subpart E (Section 15.407)
ANSI C63.10:2013

The above equipment has been tested by **Bureau Veritas Consumer Products Services (H.K.) Ltd., Taoyuan Branch**, and found compliance with the requirement of the above standards. The test record, data evaluation & Equipment Under Test (EUT) configurations represented herein are true and accurate accounts of the measurements of the sample's EMC characteristics under the conditions specified in this report.

Prepared by : Rona Chen , **Date:** Dec. 22, 2015
Rona Chen / Specialist

Approved by : Stanley Wu , **Date:** Dec. 22, 2015
Stanley Wu / Assistant Manager

2 Summary of Test Results

47 CFR FCC Part 15, Subpart E (Section 15.407)			
FCC Clause	Test Item	Result	Remarks
15.407(b)(6)	AC Power Conducted Emissions	Pass	Meet the requirement of limit. Minimum passing margin is -10.11 dB at 0.19692 MHz.
15.407(b)(1/2/3/4/6)	Radiated Emissions & Band Edge Measurement	Pass	Meet the requirement of limit. Minimum passing margin is -1.00 dB at 5148 MHz.
15.407(a)(1/2/3)	Max Average Transmit Power	Pass	Meet the requirement of limit.
15.407(a)(1/2/3)	Peak Power Spectral Density	Pass	Meet the requirement of limit.
15.407(e)	6 dB Bandwidth	Pass	Meet the requirement of limit. (U-NII-3 Band only)
15.407(g)	Frequency Stability	Pass	Meet the requirement of limit.
15.203	Antenna Requirement	Pass	No antenna connector is used.

2.1 Measurement Uncertainty

Where relevant, the following measurement uncertainty levels have been estimated for tests performed on the EUT as specified in CISPR 16-4-2:

Measurement	Frequency	Expanded Uncertainty (k=2) (±)
Conducted Emissions at mains ports	150 kHz ~ 30 MHz	2.44 dB
Radiated Emissions up to 1 GHz	30 MHz ~ 200 MHz	2.0153 dB
	200 MHz ~ 1000 MHz	2.0224 dB
Radiated Emissions above 1 GHz	1 GHz ~ 18 GHz	1.0121 dB
	18 GHz ~ 40 GHz	1.1508 dB

2.2 Modification Record

There were no modifications required for compliance.

3 General Information

3.1 General Description of EUT

Product	3x3 11ac/n/g/b/a 2.4/5GHz WiFi Module
Brand	NEXCOM
Test Model	NW-121
Status of EUT	Identical Prototype
Power Supply Rating	3.3 Vdc (Host equipment)
Modulation Type	256QAM, 64QAM, 16QAM, QPSK, BPSK
Modulation Technology	OFDM
Transfer Rate	802.11a: 54.0/ 48.0/ 36.0/ 24.0/ 18.0/ 12.0/ 9.0/ 6.0 Mbps 802.11n: up to MCS23 802.11ac: up to V29
Operating Frequency	5180 ~ 5240 MHz, 5745 ~ 5805 MHz
Number of Channel	5180 ~ 5240 MHz: 4 for 802.11a, 802.11n (HT20) 2 for 802.11n (HT40) 1 for 802.11ac (VHT80) 5745 ~ 5805 MHz: 4 for 802.11a, 802.11n (HT20) 2 for 802.11n (HT40) 1 for 802.11ac (VHT80)
Output Power	65.63 mW for 5180 ~ 5240 MHz 66.867 mW for 5745 ~ 5805 MHz
Antenna Type	PIFA antenna with 4.70 dBi gain (5180 ~ 5240 MHz) PIFA antenna with 5.24 dBi gain (5745 ~ 5805 MHz) Dipole antenna with 1.95 dBi gain (5180 ~ 5240 MHz) Dipole antenna with 1.94 dBi gain (5745 ~ 5805 MHz)
Antenna Connector	N/A
Accessory Device	Refer to Note as below
Data Cable Supplied	N/A

Note:

- The EUT incorporates a MIMO function. Physically, the EUT provides 3 completed transmitters and 3 receivers.

Modulation Mode	Tx Function
802.11a	3TX
802.11n (HT20)	3TX
802.11n (HT40)	3TX
802.11ac (VHT80)	3TX

* The modulation and bandwidth are similar for 802.11n mode for HT20 / HT40 and 802.11ac mode for HT20 / HT40, therefore investigated worst case to representative mode in test report. (Final test mode refer section 3.2.1)

- The EUT contains following accessory devices.

Product	Brand	Model	Description
Antenna 1	ARISTOTLE	RFA-25-AP250-70-50	PIFA
Antenna 2	WIESON	GY121L049S-XXX	Dipole

- The above EUT information is declared by manufacturer and for more detailed features description, please refer to the manufacturer's specifications or user's manual.

3.2 Description of Test Modes

FOR 5180 ~ 5240 MHz

4 channels are provided for 802.11a, 802.11n (HT20):

Channel	Frequency (MHz)	Channel	Frequency (MHz)
36	5180	44	5220
40	5200	48	5240

2 channels are provided for 802.11n (HT40):

Channel	Frequency (MHz)	Channel	Frequency (MHz)
38	5190	46	5230

1 channel is provided for 802.11ac (VHT80):

Channel	Frequency (MHz)
42	5210

FOR 5745 ~ 5805 MHz:

4 channels are provided for 802.11a, 802.11n (HT20):

Channel	Frequency (MHz)	Channel	Frequency (MHz)
149	5745	157	5785
153	5765	161	5805

2 channels are provided for 802.11n (HT40):

Channel	Frequency (MHz)	Channel	Frequency (MHz)
151	5755	159	5795

1 channel is provided for 802.11ac (VHT80):

Channel	Frequency (MHz)
155	5775

3.2.1 Test Mode Applicability and Tested Channel Detail

EUT Configure Mode	Applicable To				Description
	RE \geq 1G	RE $<$ 1G	PLC	APCM	
A	√	√	√	√	EUT with PIFA Antenna
B	√	√	√	√	EUT with Dipole Antenna

Where **RE \geq 1G**: Radiated Emission above 1 GHz **RE $<$ 1G**: Radiated Emission below 1 GHz
PLC: Power Line Conducted Emission **APCM**: Antenna Port Conducted Measurement

Radiated Emission Test (Above 1 GHz):

- Pre-Scan has been conducted to determine the worst-case mode from all possible combinations between available modulations, data rates and antenna ports (if EUT with antenna diversity architecture).
- Following channel(s) was (were) selected for the final test as listed below.

EUT Configure Mode	Mode	Frequency Band (MHz)	Available Channel	Tested Channel	Modulation Technology	Modulation Type	Data Rate (Mbps)
A, B	802.11a	5180-5240	36 to 48	36, 40, 48	OFDM	BPSK	6.0
	802.11n (HT20)		36 to 48	36, 40, 48	OFDM	BPSK	MCS0
	802.11n (HT40)		38 to 46	38, 46	OFDM	BPSK	MCS0
	802.11ac (VHT80)		42	42	OFDM	BPSK	V0
	802.11a	5745-5805	149 to 161	149, 157, 161	OFDM	BPSK	6.0
	802.11n (HT20)		149 to 161	149, 157, 161	OFDM	BPSK	MCS0
	802.11n (HT40)		151 to 159	151, 159	OFDM	BPSK	MCS0
	802.11ac (VHT80)		155	155	OFDM	BPSK	V0

Radiated Emission Test (Below 1 GHz):

- Pre-Scan has been conducted to determine the worst-case mode from all possible combinations between available modulations, data rates and antenna ports (if EUT with antenna diversity architecture).
- Following channel(s) was (were) selected for the final test as listed below.

EUT Configure Mode	Mode	Frequency Band (MHz)	Available Channel	Tested Channel	Modulation Technology	Modulation Type	Data Rate (Mbps)
A	802.11ac (VHT80)	5180-5240	42	42	OFDM	BPSK	V0
	802.11ac (VHT80)	5745-5805	155	155	OFDM	BPSK	V0
B	802.11n (HT40)	5180-5240	38 to 46	38	OFDM	BPSK	MCS0
	802.11ac (VHT80)	5745-5805	155	155	OFDM	BPSK	V0

Power Line Conducted Emission Test:

- Pre-Scan has been conducted to determine the worst-case mode from all possible combinations between available modulations, data rates and antenna ports (if EUT with antenna diversity architecture).
- Following channel(s) was (were) selected for the final test as listed below.

EUT Configure Mode	Mode	Frequency Band (MHz)	Available Channel	Tested Channel	Modulation Technology	Modulation Type	Data Rate (Mbps)
A	802.11ac (VHT80)	5180-5240	42	42	OFDM	BPSK	V0
B	802.11ac (VHT80)	5745-5805	155	155	OFDM	BPSK	V0

Antenna Port Conducted Measurement:

- This item includes all test value of each mode, but only includes spectrum plot of worst value of each mode.
- Pre-Scan has been conducted to determine the worst-case mode from all possible combinations between available modulations, data rates and antenna ports (if EUT with antenna diversity architecture).
- Following channel(s) was (were) selected for the final test as listed below.

EUT Configure Mode	Mode	Frequency Band (MHz)	Available Channel	Tested Channel	Modulation Technology	Modulation Type	Data Rate (Mbps)
A, B	802.11a	5180-5240	36 to 48	36, 40, 48	OFDM	BPSK	6.0
	802.11n (HT20)		36 to 48	36, 40, 48	OFDM	BPSK	MCS0
	802.11n (HT40)		38 to 46	38, 46	OFDM	BPSK	MCS0
	802.11ac (VHT80)		42	42	OFDM	BPSK	V0
	802.11a	5745-5805	149 to 161	149, 157, 161	OFDM	BPSK	6.0
	802.11n (HT20)		149 to 161	149, 157, 161	OFDM	BPSK	MCS0
	802.11n (HT40)		151 to 159	151, 159	OFDM	BPSK	MCS0
	802.11ac (VHT80)		155	155	OFDM	BPSK	V0

Test Condition:

Applicable To	Environmental Conditions	Input Power	Tested by
RE≥1G	25 deg. C, 65 % RH	120 Vac, 60 Hz	Karl Lee
RE<1G	25 deg. C, 65 % RH	120 Vac, 60 Hz	Karl Lee
PLC	25 deg. C, 65 % RH	120 Vac, 60 Hz	Toby Tian
APCM	25 deg. C, 65 % RH	3.3 Vdc	Taylor Liu

3.3 Duty Cycle of Test Signal

Mode A

5180 ~ 5240 MHz

MODULATION TYPE: BPSK

802.11a: Duty cycle = $2.019/2.107 = 0.958$, Duty factor = $10 * \log(1/0.958) = 0.19$

802.11n (HT20): Duty cycle = $0.649/0.729 = 0.890$, Duty factor = $10 * \log(1/0.890) = 0.51$

802.11n (HT40): Duty cycle = $0.313/0.425 = 0.736$, Duty factor = $10 * \log(1/0.736) = 1.33$

802.11ac (VHT80): Duty cycle = $0.157/0.263 = 0.598$, Duty factor = $10 * \log(1/0.598) = 2.24$

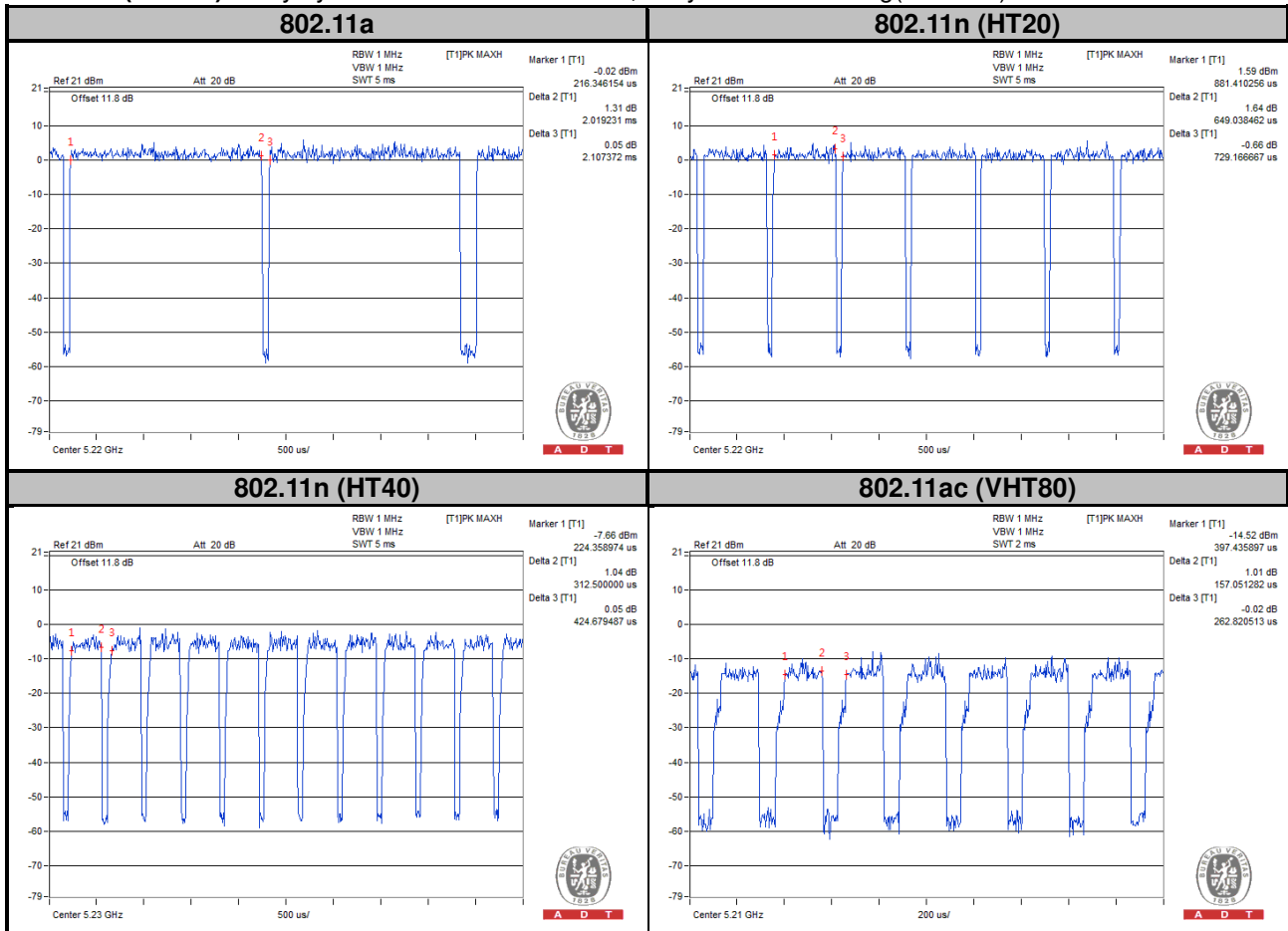

MODULATION TYPE: QPSK

802.11a: Duty cycle = $1.010/1.098 = 0.920$, Duty factor = $10 * \log(1/0.920) = 0.36$

802.11n (HT20): Duty cycle = $0.353/0.425 = 0.830$, Duty factor = $10 * \log(1/0.830) = 0.81$

802.11n (HT40): Duty cycle = $0.168/0.266 = 0.633$, Duty factor = $10 * \log(1/0.633) = 1.99$

802.11ac (VHT80): Duty cycle = $0.090/0.192 = 0.467$, Duty factor = $10 * \log(1/0.467) = 3.31$

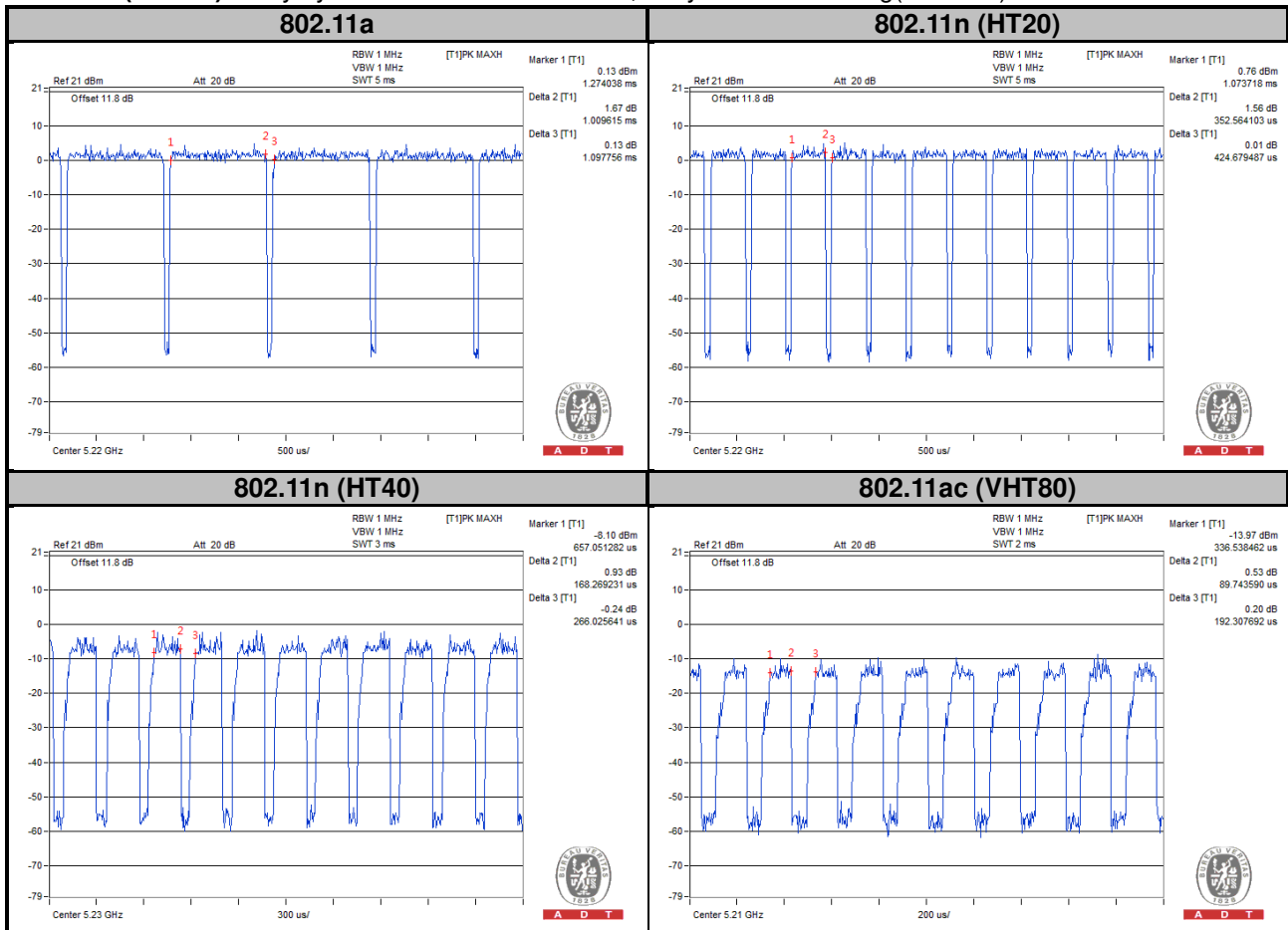

MODULATION TYPE: 16QAM

802.11a: Duty cycle = $0.521/0.593 = 0.878$, Duty factor = $10 * \log(1/0.878) = 0.56$

802.11n (HT20): Duty cycle = $0.186/0.277 = 0.671$, Duty factor = $10 * \log(1/0.671) = 1.74$

802.11n (HT40): Duty cycle = $0.091/0.196 = 0.467$, Duty factor = $10 * \log(1/0.467) = 3.30$

802.11ac (VHT80): Duty cycle = $0.051/0.157 = 0.327$, Duty factor = $10 * \log(1/0.327) = 4.86$



MODULATION TYPE: 64QAM

802.11a: Duty cycle = $0.264/0.337 = 0.786$, Duty factor = $10 * \log(1/0.786) = 1.05$

802.11n (HT20): Duty cycle = $0.119/0.194 = 0.612$, Duty factor = $10 * \log(1/0.612) = 2.14$

802.11n (HT40): Duty cycle = $0.056/0.154 = 0.365$, Duty factor = $10 * \log(1/0.365) = 4.38$

802.11ac (VHT80): Duty cycle = $0.038/0.141 = 0.273$, Duty factor = $10 * \log(1/0.273) = 5.64$

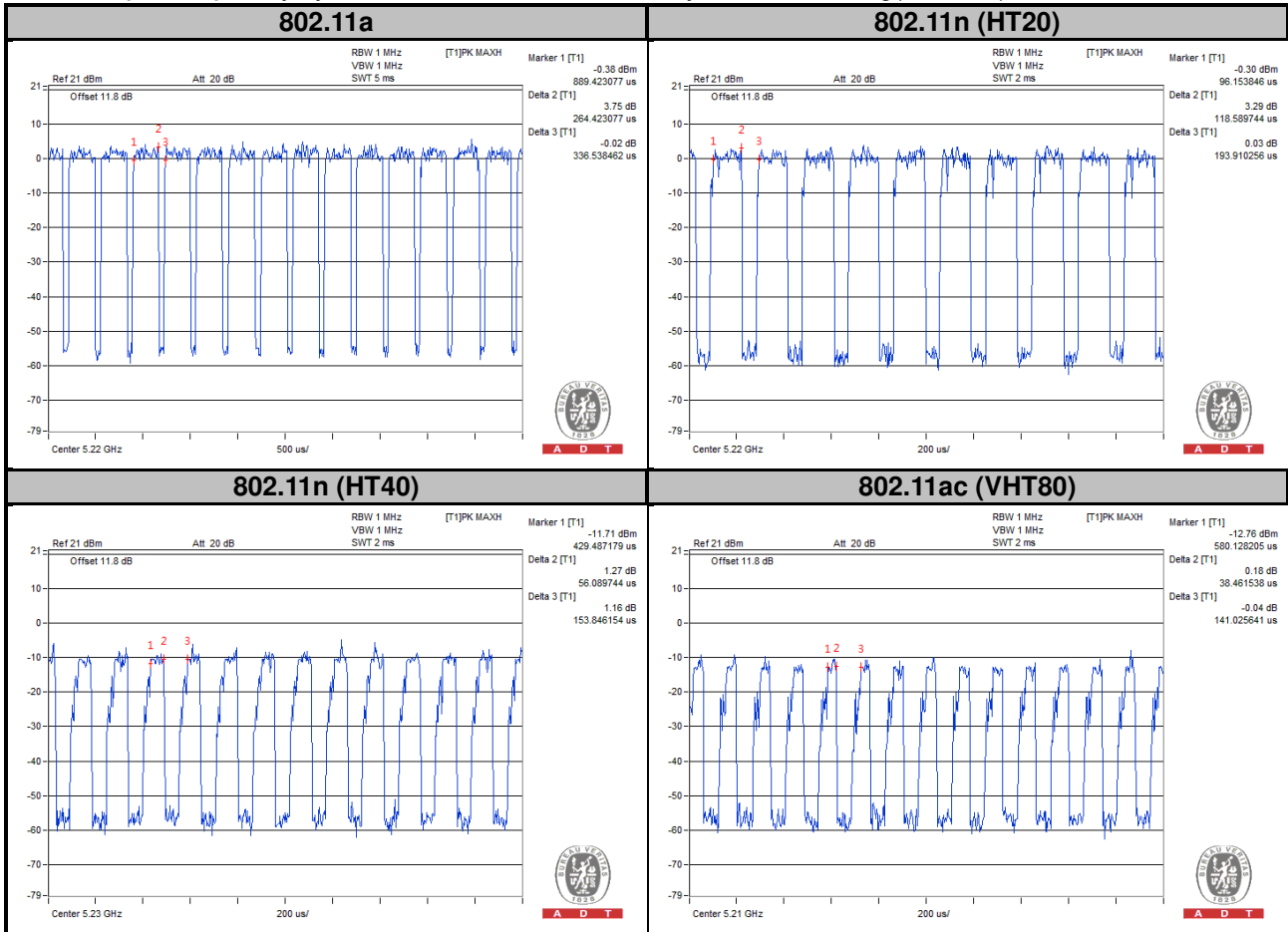
MODULATION TYPE: 256QAM

802.11ac (VHT80): Duty cycle = $0.029/0.135 = 0.214$, Duty factor = $10 * \log(1/0.214) = 6.69$

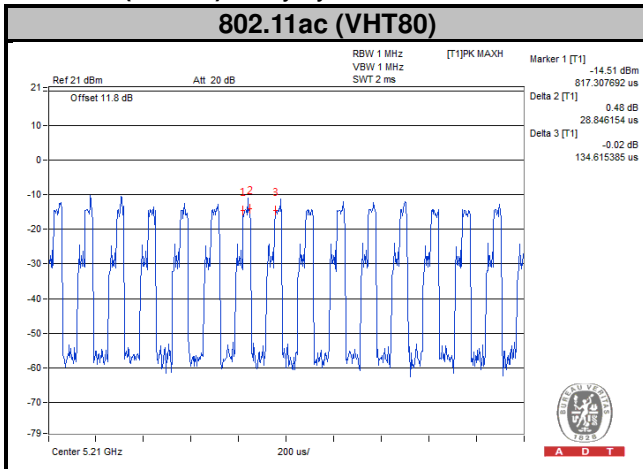

5745 ~ 5805 MHz

802.11a: Duty cycle = 2.019/2.107 = 0.958, Duty factor = $10 \cdot \log(1/0.958) = 0.19$

802.11n (HT20): Duty cycle = 0.649/0.729 = 0.890, Duty factor = $10 \cdot \log(1/0.890) = 0.51$

802.11n (HT40): Duty cycle = 0.313/0.425 = 0.736, Duty factor = $10 \cdot \log(1/0.736) = 1.33$

802.11ac (VHT80): Duty cycle = 0.157/0.263 = 0.598, Duty factor = $10 \cdot \log(1/0.598) = 2.24$

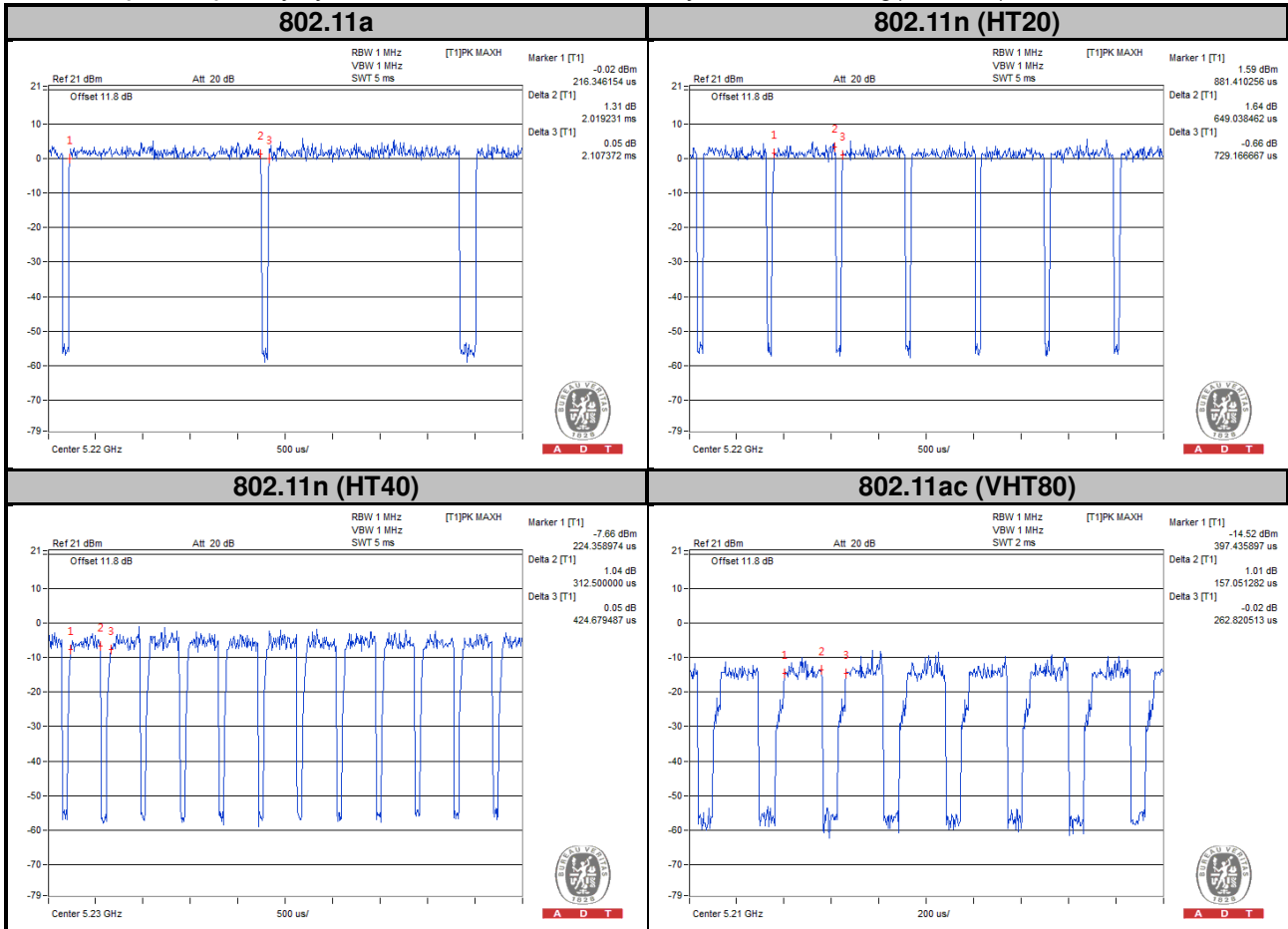

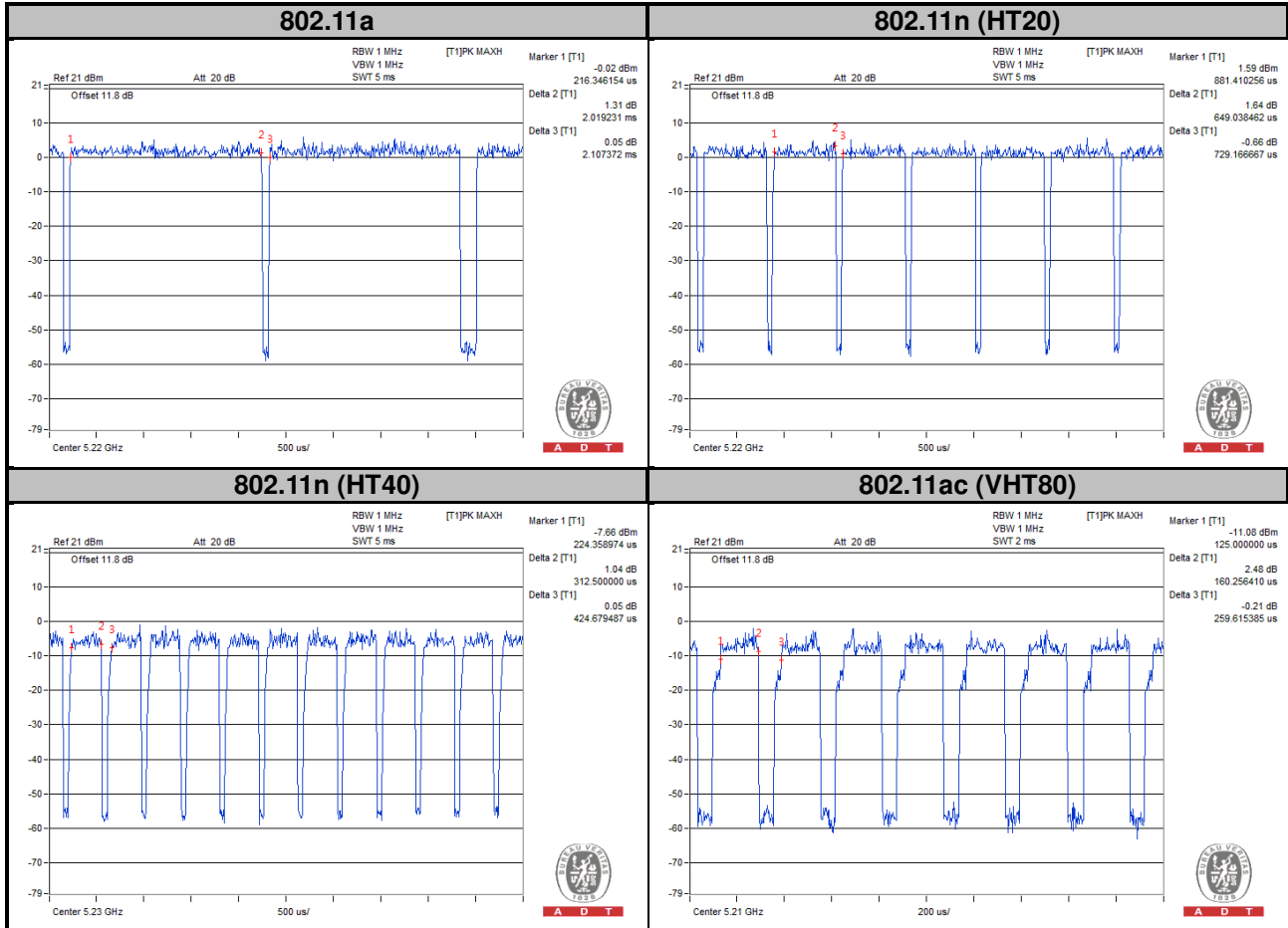
Mode B
5180 ~ 5240 MHz
MODULATION TYPE: BPSK
802.11a: Duty cycle = $2.019/2.107 = 0.958$, Duty factor = $10 * \log(1/0.958) = 0.19$
802.11n (HT20): Duty cycle = $0.649/0.729 = 0.890$, Duty factor = $10 * \log(1/0.890) = 0.51$
802.11n (HT40): Duty cycle = $0.313/0.425 = 0.736$, Duty factor = $10 * \log(1/0.736) = 1.33$
802.11ac (VHT80): Duty cycle = $0.160/0.260 = 0.617$, Duty factor = $10 * \log(1/0.617) = 2.10$

MODULATION TYPE: QPSK

802.11a: Duty cycle = $1.010/1.098 = 0.920$, Duty factor = $10 * \log(1/0.920) = 0.36$

802.11n (HT20): Duty cycle = $0.353/0.425 = 0.830$, Duty factor = $10 * \log(1/0.830) = 0.81$

802.11n (HT40): Duty cycle = $0.168/0.266 = 0.633$, Duty factor = $10 * \log(1/0.633) = 1.99$

802.11ac (VHT80): Duty cycle = $0.090/0.192 = 0.467$, Duty factor = $10 * \log(1/0.467) = 3.31$

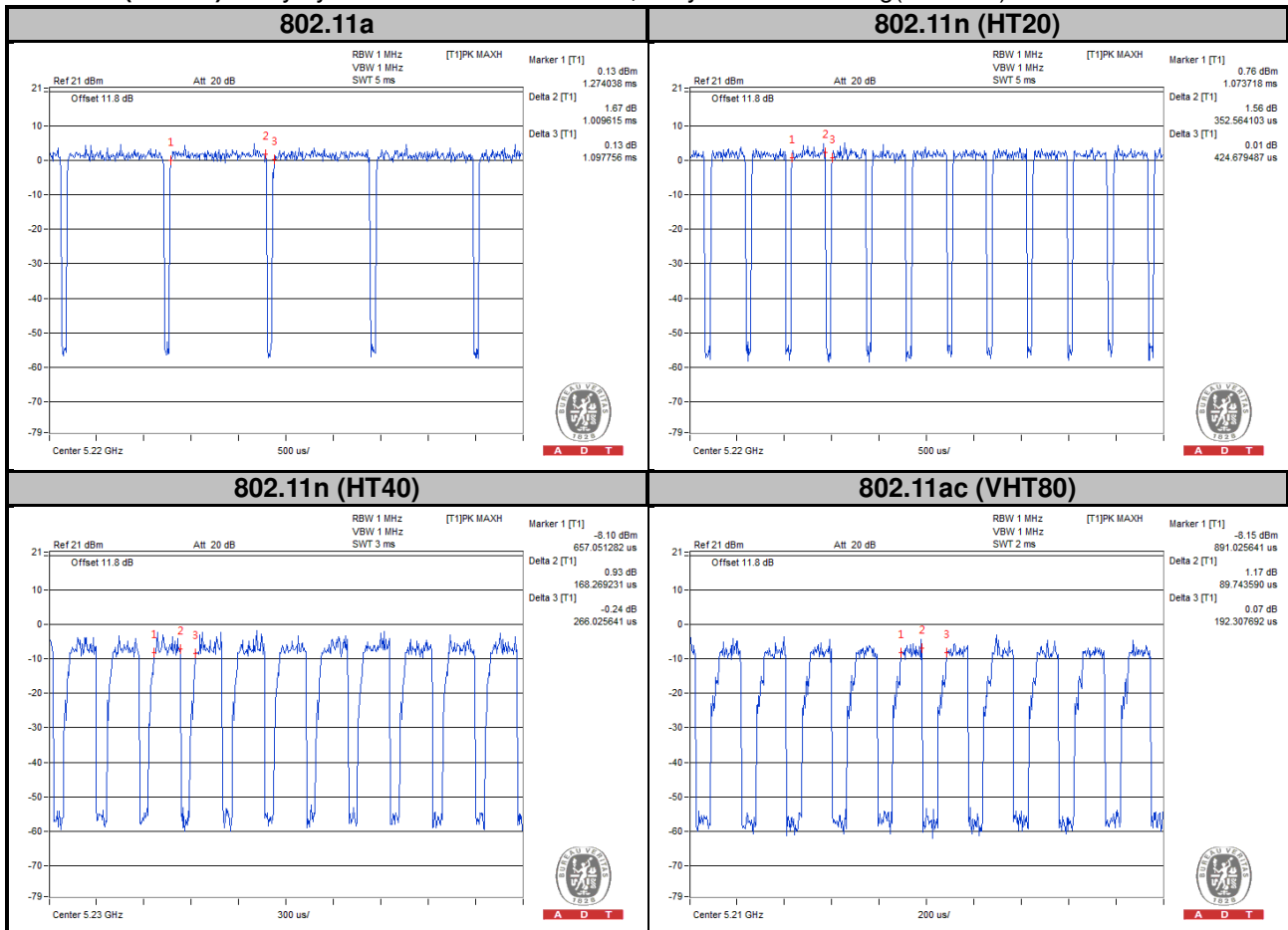

MODULATION TYPE: 16QAM

802.11a: Duty cycle = $0.521/0.593 = 0.878$, Duty factor = $10 * \log(1/0.878) = 0.56$

802.11n (HT20): Duty cycle = $0.186/0.277 = 0.671$, Duty factor = $10 * \log(1/0.671) = 1.74$

802.11n (HT40): Duty cycle = $0.091/0.196 = 0.467$, Duty factor = $10 * \log(1/0.467) = 3.30$

802.11ac (VHT80): Duty cycle = $0.058/0.157 = 0.367$, Duty factor = $10 * \log(1/0.367) = 4.35$

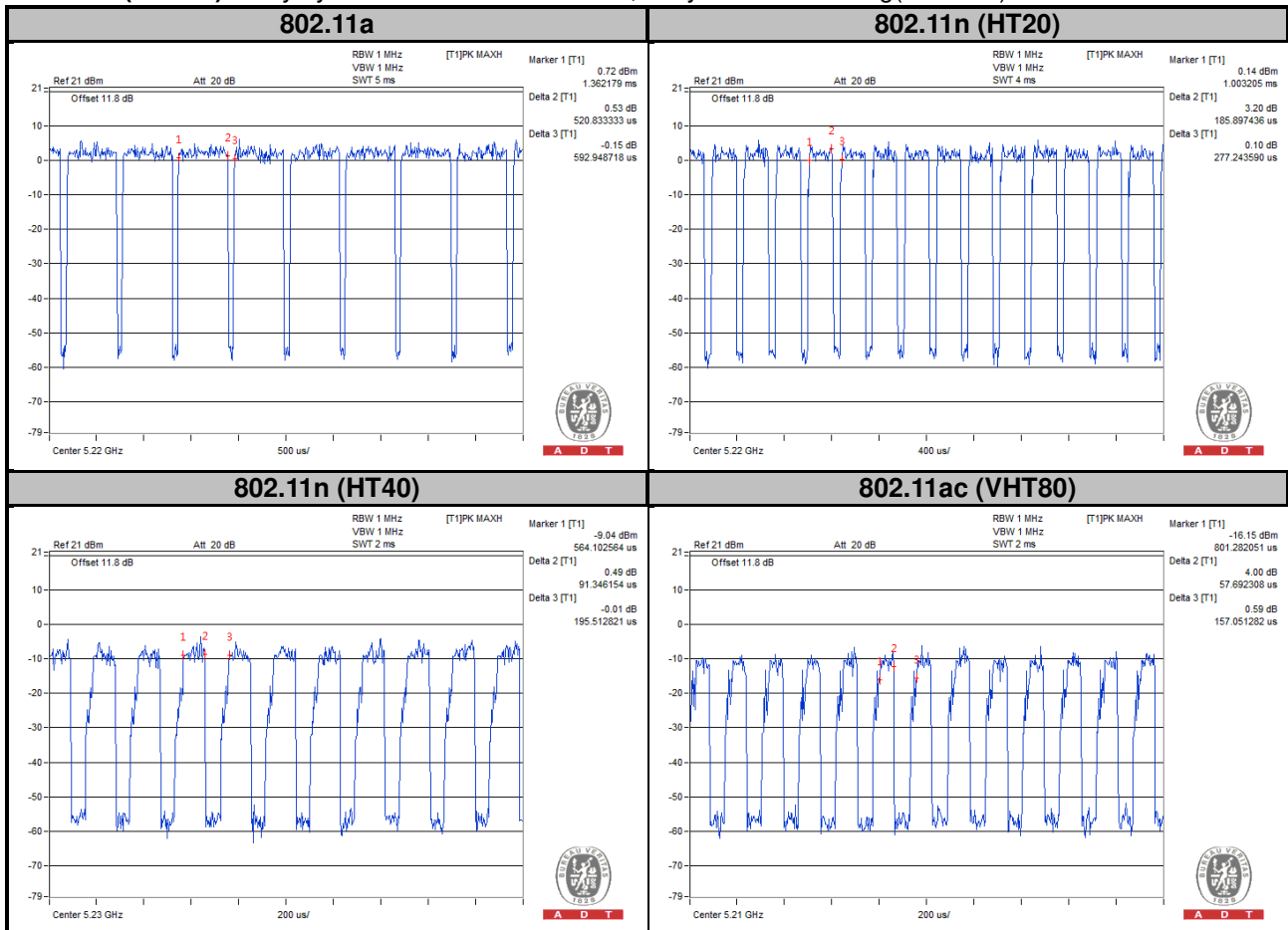

MODULATION TYPE: 64QAM

802.11a: Duty cycle = $0.264/0.337 = 0.786$, Duty factor = $10 * \log(1/0.786) = 1.05$

802.11n (HT20): Duty cycle = $0.119/0.194 = 0.612$, Duty factor = $10 * \log(1/0.612) = 2.14$

802.11n (HT40): Duty cycle = $0.056/0.154 = 0.365$, Duty factor = $10 * \log(1/0.365) = 4.38$

802.11ac (VHT80): Duty cycle = $0.042/0.141 = 0.295$, Duty factor = $10 * \log(1/0.295) = 5.30$

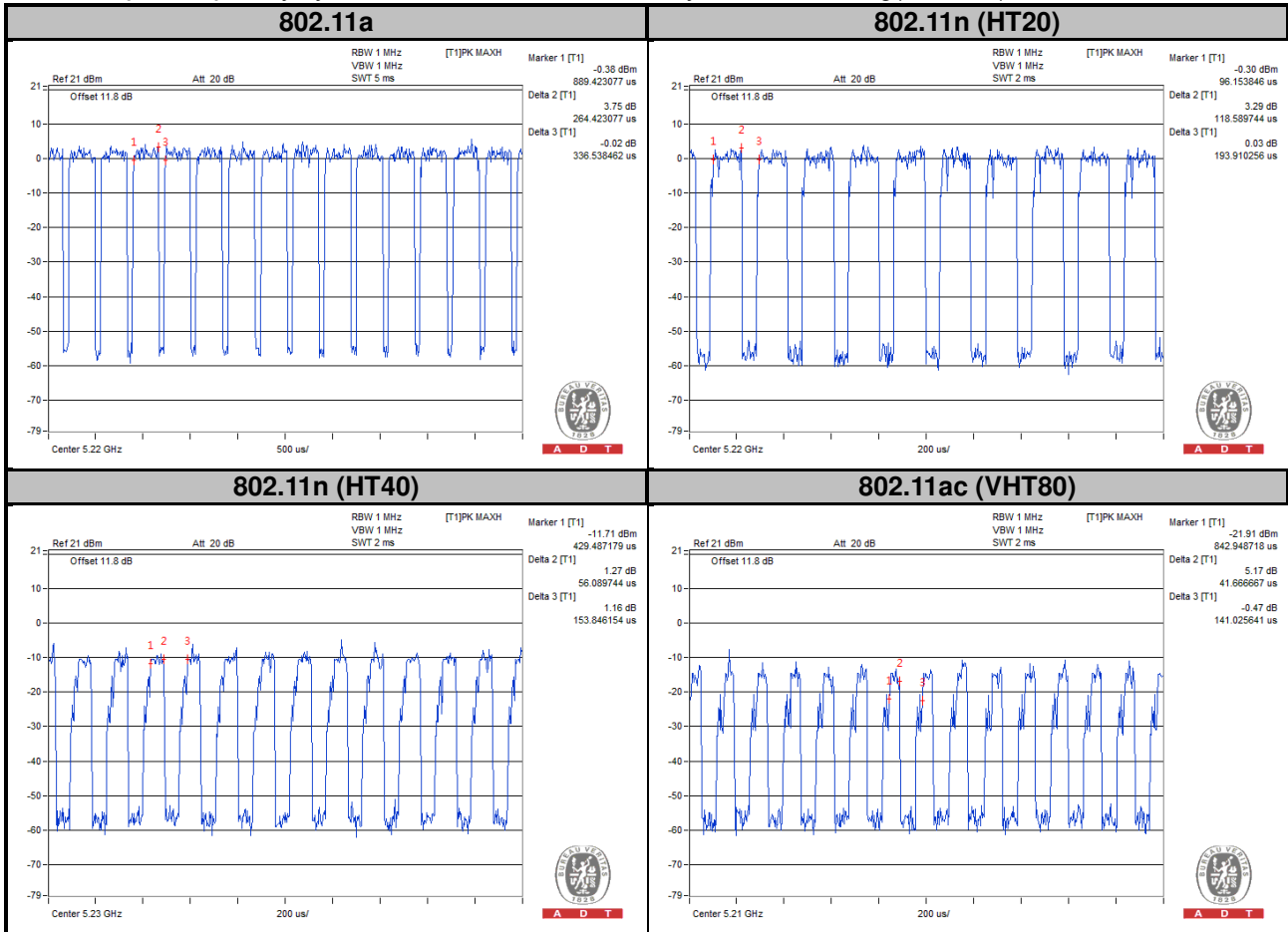

MODULATION TYPE: 256QAM

802.11ac (VHT80): Duty cycle = $0.029/0.131 = 0.220$, Duty factor = $10 * \log(1/0.220) = 6.59$

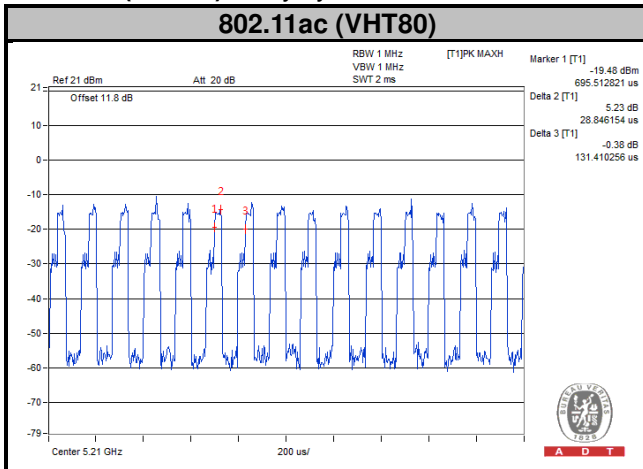

5745 ~ 5805 MHz

802.11a: Duty cycle = $2.019/2.107 = 0.958$, Duty factor = $10 * \log(1/0.958) = 0.19$

802.11n (HT20): Duty cycle = $0.649/0.729 = 0.890$, Duty factor = $10 * \log(1/0.890) = 0.51$

802.11n (HT40): Duty cycle = $313/0.425 = 0.736$, Duty factor = $10 * \log(1/0.736) = 1.33$

802.11ac (VHT80): Duty cycle = $0.160/0.260 = 0.617$, Duty factor = $10 * \log(1/0.617) = 2.10$

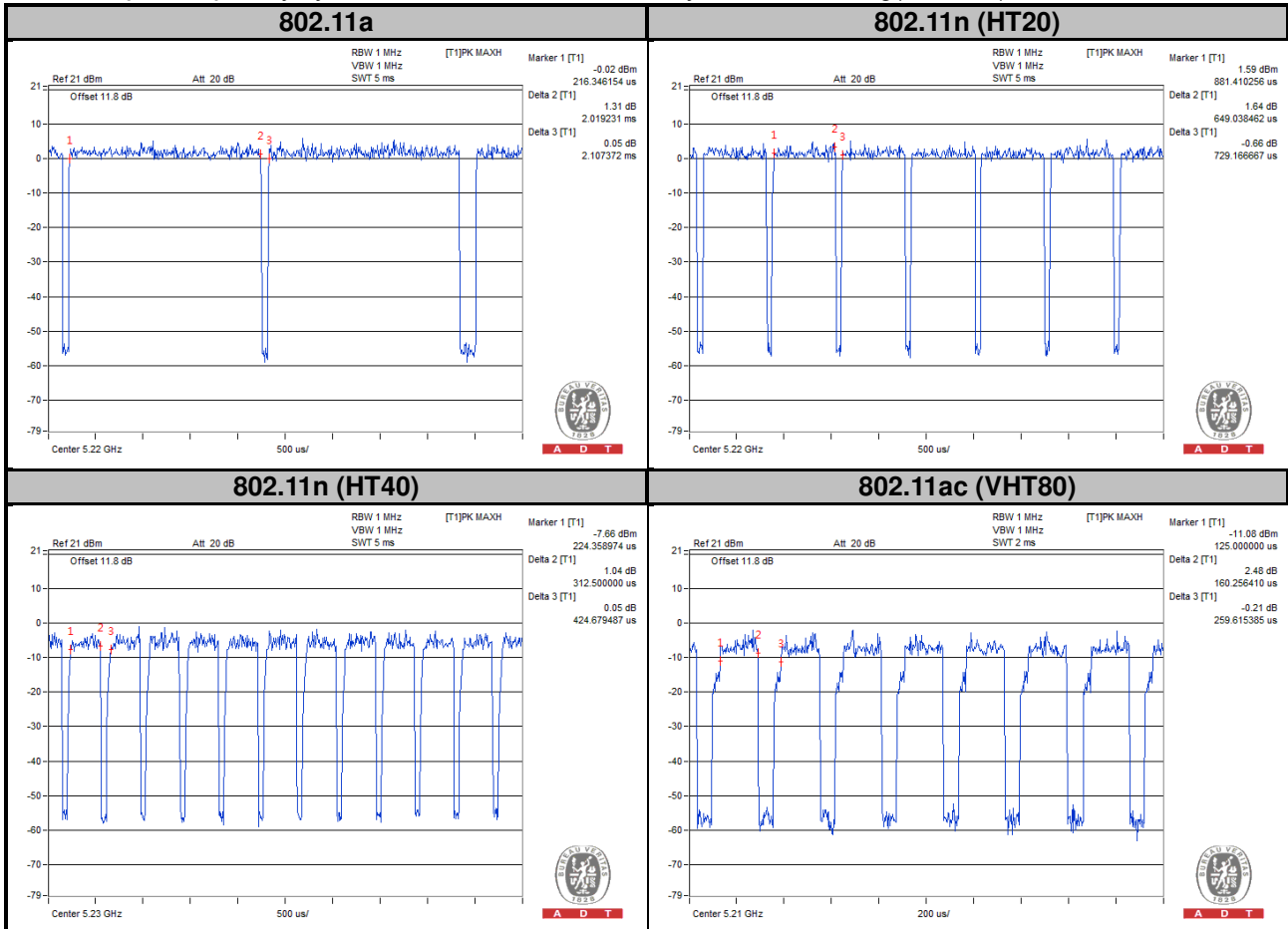

3.4 Description of Support Units

The EUT has been tested as an independent unit together with other necessary accessories or support units. The following support units or accessories were used to form a representative test configuration during the tests.

No.	Product	Brand	Model No.	Serial No.	FCC ID
1.	Notebook	DELL	E6420	D3T96R1	N/A

Note:

1. All power cords of the above support units are non-shielded (1.8m).

3.4.1 Configuration of System under Test

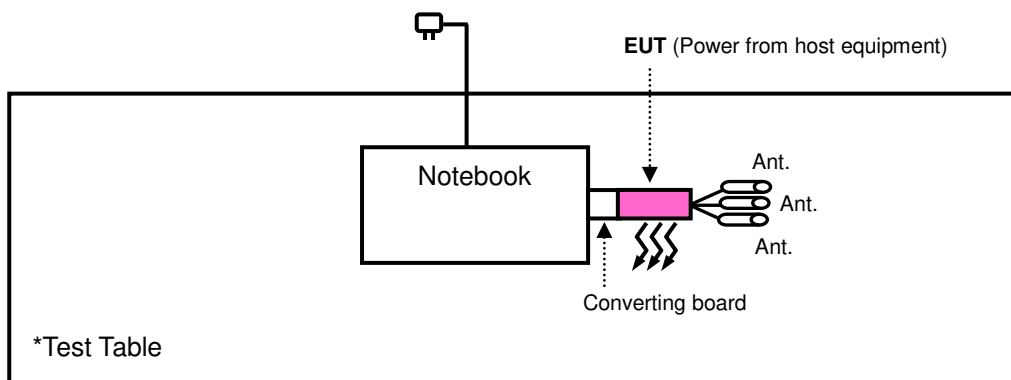

3.5 General Description of Applied Standards

The EUT is a RF Product. According to the specifications of the manufacturer, it must comply with the requirements of the following standards:

FCC Part 15, Subpart E (15.407)

789033 D02 General UNII Test Procedures New Rules v01

644545 D01 Guidance for IEEE 802 11ac v01r02

662911 D01 Multiple Transmitter Output v02r01

ANSI C63.10-2013

All test items have been performed and recorded as per the above standards.

NOTE: The EUT has been verified to comply with the requirements of FCC Part 15, Subpart B, Class B (DoC). The test report has been issued separately.

4 Test Types and Results

4.1 Radiated Emission and Bandedge Measurement

4.1.1 Limits of Radiated Emission and Bandedge Measurement

Radiated emissions which fall in the restricted bands must comply with the radiated emission limits specified as below table. Other emissions shall be at least 20 dB below the highest level of the desired power:

Frequencies (MHz)	Field Strength (microvolts/meter)	Measurement Distance (meters)
0.009 ~ 0.490	2400/F (kHz)	300
0.490 ~ 1.705	24000/F (kHz)	30
1.705 ~ 30.0	30	30
30 ~ 88	100	3
88 ~ 216	150	3
216 ~ 960	200	3
Above 960	500	3

NOTE:

1. The lower limit shall apply at the transition frequencies.
2. Emission level (dBuV/m) = 20 log Emission level (uV/m).
3. For frequencies above 1000 MHz, the field strength limits are based on average detector, however, the peak field strength of any emission shall not exceed the maximum permitted average limits, specified above by more than 20 dB under any condition of modulation.

4.1.2 Limits of Unwanted Emission Out of the Restricted Bands

Applicable To	Limit	
789033 D02 General UNII Test Procedures New Rules v01	Field Strength at 3 m	
	PK: 74 (dBμV/m)	AV: 54 (dBμV/m)
Applicable To	EIRP Limit	Equivalent Field Strength at 3 m
15.407(b)(1)	PK: -27 (dBm/MHz)	PK: 68.2 (dBμV/m)
15.407(b)(2)		
15.407(b)(3)		
15.407(b)(4)	PK: -27 (dBm/MHz) ^{*1} PK: -17 (dBm/MHz) ^{*2}	PK: 68.2 (dBμV/m) ^{*1} PK: 78.2 (dBμV/m) ^{*2}

NOTE: ^{*1} beyond 10 MHz of the band edge ^{*2} within 10 MHz of band edge

The following formula is used to convert the equipment isotropic radiated power (eirp) to field strength:

$$E = \frac{1000000\sqrt{30P}}{3} \mu\text{V/m, where } P \text{ is the eirp (Watts).}$$

4.1.3 Test Instruments

Description & Manufacturer	Model No.	Serial No.	Date of Calibration	Due Date of Calibration
Test Receiver Agilent Technologies	N9038A	MY52260177	May 19, 2015	May 18, 2016
Spectrum Analyzer Agilent	N9010A	MY52220207	Sep. 11, 2015	Sep. 10, 2016
BILOG Antenna SCHWARZBECK	VULB9168	9168-472	Feb. 04, 2015	Feb. 04, 2016
HORN Antenna SCHWARZBECK	BBHA 9170	9170-480	Feb. 04, 2015	Feb. 04, 2016
HORN Antenna ETS-Lindgren	3117	00143293	Jan. 05, 2015	Jan. 04, 2016
Bluetooth Tester	CBT	100980	Apr. 27, 2015	Apr. 26, 2017
Loop Antenna	EM-6879	269	Jul. 31, 2015	Jul. 30, 2016
Agilent Communications Tester-Wireless	8960 Series 10	MY53201073	Jul. 03, 2015	Jul. 02, 2017
Preamplifier Agilent	310N	187226	Jun. 29, 2015	Jun. 28, 2016
Preamplifier Agilent	83017A	MY39501357	Jun. 29, 2015	Jun. 28, 2016
Power Meter Anritsu	ML2495A	1232002	Sep. 21, 2015	Sep. 20, 2016
Power Sensor Anritsu	MA2411B	1207325	Sep. 21, 2015	Sep. 20, 2016
RF signal cable ETS-LINDGREN	5D-FB	Cable-CH1-01(R FC-SMS-100-SM S-120+RFC-SMS -100-SMS-400)	Jun. 27, 2015	Jun. 26, 2016
RF signal cable ETS-LINDGREN	8D-FB	Cable-CH1-02(R FC-SMS-100-SM S-24)	Jun. 27, 2015	Jun. 26, 2016
Software BV ADT	E3 8.130425b	NA	NA	NA
Antenna Tower MF	NA	NA	NA	NA
Turn Table MF	NA	NA	NA	NA
Antenna Tower & Turn Table Controller MF	MF-7802	NA	NA	NA

- Note: 1. The calibration interval of the above test instruments is 12 months and the calibrations are traceable to NML/ROC and NIST/USA.
2. The test was performed in HsinTien Chamber 1.
3. The horn antenna and preamplifier (model: 83017A) are used only for the measurement of emission frequency above 1 GHz if tested.
4. The FCC Site Registration No. is 149147.
5. The IC Site Registration No. is IC7450I-1.

4.1.4 Test Procedures

- a. The EUT was placed on the top of a rotating table 0.8 meters (for below 1 GHz) / 1.5 meters (for above 1 GHz) above the ground at 3 meter chamber room for test. The table was rotated 360 degrees to determine the position of the highest radiation.
- b. The EUT was set 3 meters away from the interference-receiving antenna, which was mounted on the top of a variable-height antenna tower.
- c. The height of antenna is varied from one meter to four meters above the ground to determine the maximum value of the field strength. Both horizontal and vertical polarizations of the antenna are set to make the measurement.
- d. For each suspected emission, the EUT was arranged to its worst case and then the antenna was tuned to heights from 1 meter to 4 meters and the rotatable table was turned from 0 degrees to 360 degrees to find the maximum reading.
- e. The test-receiver system was set to quasi-peak detect function and specified bandwidth with maximum hold mode when the test frequency is below 1 GHz.
- f. The test-receiver system was set to peak and average detected function and specified bandwidth with maximum hold mode when the test frequency is above 1 GHz. If the peak reading value also meets average limit, measurement with the average detector is unnecessary.

Note:

1. The resolution bandwidth and video bandwidth of test receiver/spectrum analyzer is 120 kHz for Quasi-peak detection (QP) at frequency below 1 GHz.
2. The resolution bandwidth of test receiver/spectrum analyzer is 1 MHz and the video bandwidth is 3 MHz for Peak detection (PK) at frequency above 1 GHz.
3. The resolution bandwidth of test receiver/spectrum analyzer is 1 MHz and the video bandwidth is 3 MHz for RMS Average (Duty cycle < 98 %) for Average detection (AV) at frequency above 1 GHz, then the measurement results was added to a correction factor ($10 \log(1/\text{duty cycle})$).
4. The resolution bandwidth of test receiver/spectrum analyzer is 1 MHz and the video bandwidth is 10 Hz (Duty cycle \geq 98 %) for Average detection (AV) at frequency above 1 GHz.
5. All modes of operation were investigated and the worst-case emissions are reported.

4.1.5 Deviation from Test Standard

No deviation.

4.1.6 Test Set Up

<Frequency Range below 1 GHz>

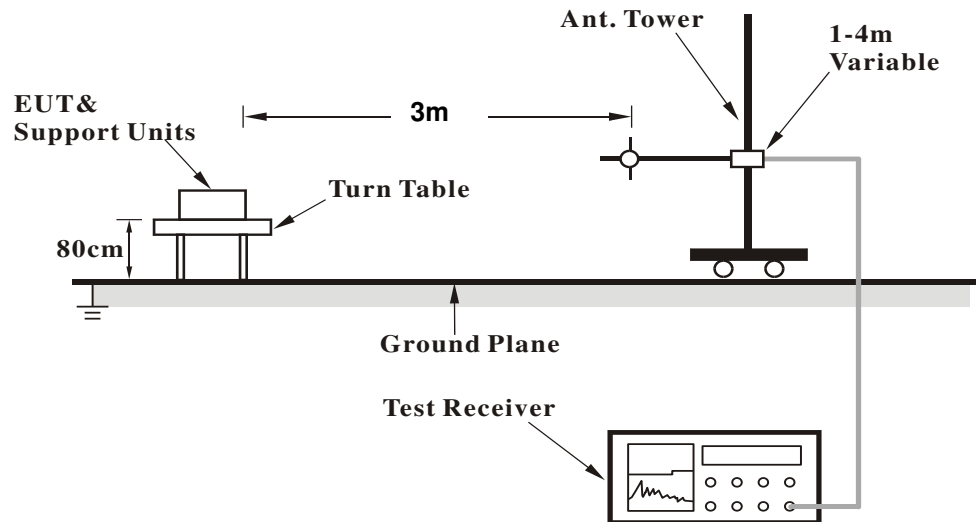

<Frequency Range above 1 GHz>

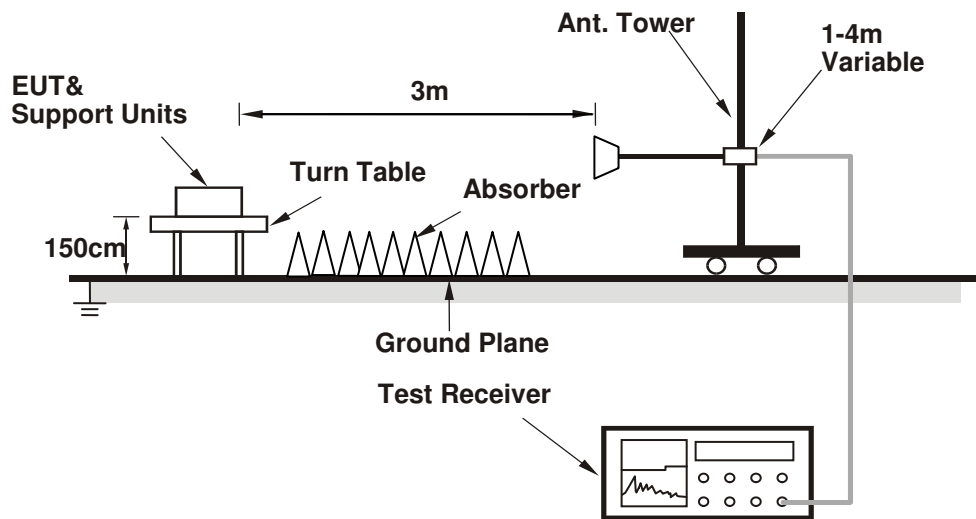

For the actual test configuration, please refer to the attached file (Test Setup Photo).

4.1.7 EUT Operating Conditions

- a. Placed the EUT on a testing table.
- b. Use the software to control the EUT under transmission condition continuously at specific channel frequency.

4.1.8 Test Results
ABOVE 1 GHz DATA :
Mode A
802.11a

EUT TEST CONDITION		MEASUREMENT DETAIL	
CHANNEL	Channel 36	FREQUENCY RANGE	1 GHz ~ 40 GHz
INPUT POWER	120 Vac, 60 Hz	DETECTOR FUNCTION	Peak (PK) Average (AV)
ENVIRONMENTAL CONDITIONS	25 deg. C, 65 % RH	TESTED BY	Karl Lee

ANTENNA POLARITY & TEST DISTANCE: HORIZONTAL AT 3 M										
FREQ. (MHz)	EMISSION LEVEL (dBuV/m)	READ LEVEL (dBuV)	LIMIT (dBuV/m)	MARGIN (dB)	ANTENNA FACTOR (dB/m)	CABLE LOSS (dB)	PREAMP FACTOR (dB)	ANTENNA HEIGHT (cm)	TABLE ANGLE (Degree)	REMARK
5072	45.7	37.58	54	-8.3	34.07	8.03	33.98	122	258	Average
5072	59.19	51.07	74	-14.81	34.07	8.03	33.98	122	258	Peak
5180	102.11	93.8			34.15	8.16	34	122	258	Average
5180	109.07	100.76			34.15	8.16	34	122	258	Peak
5426	45.31	36.54	54	-8.69	34.33	8.48	34.04	122	258	Average
5426	60.83	52.06	74	-13.17	34.33	8.48	34.04	122	258	Peak
ANTENNA POLARITY & TEST DISTANCE: VERTICAL AT 3 M										
FREQ. (MHz)	EMISSION LEVEL (dBuV/m)	READ LEVEL (dBuV)	LIMIT (dBuV/m)	MARGIN (dB)	ANTENNA FACTOR (dB/m)	CABLE LOSS (dB)	PREAMP FACTOR (dB)	ANTENNA HEIGHT (cm)	TABLE ANGLE (Degree)	REMARK
5150	52.15	43.9	54	-1.85	34.12	8.13	34	205	180	Average
5150	62.82	54.57	74	-11.18	34.12	8.13	34	205	180	Peak
5180	105.41	97.1			34.15	8.16	34	184	180	Average
5180	112.4	104.09			34.15	8.16	34	184	180	Peak
5422	51.26	42.49	54	-2.74	34.33	8.48	34.04	202	180	Average
5422	61.84	53.07	74	-12.16	34.33	8.48	34.04	202	180	Peak

REMARKS:

- Emission Level = Read Level + Antenna Factor + Cable Loss - Preamp Factor
Margin value = Emission level – Limit value
- 5180 MHz: Fundamental frequency.



A D T

EUT TEST CONDITION		MEASUREMENT DETAIL	
CHANNEL	Channel 44	FREQUENCY RANGE	1 GHz ~ 40 GHz
INPUT POWER	120 Vac, 60 Hz	DETECTOR FUNCTION	Peak (PK) Average (AV)
ENVIRONMENTAL CONDITIONS	25 deg. C, 65 % RH	TESTED BY	Karl Lee

ANTENNA POLARITY & TEST DISTANCE: HORIZONTAL AT 3 M										
FREQ. (MHz)	EMISSION LEVEL (dBuV/m)	READ LEVEL (dBuV)	LIMIT (dBuV/m)	MARGIN (dB)	ANTENNA FACTOR (dB/m)	CABLE LOSS (dB)	PREAMP FACTOR (dB)	ANTENNA HEIGHT (cm)	TABLE ANGLE (Degree)	REMARK
5150	44.35	36.1	54	-9.65	34.12	8.13	34	101	258	Average
5150	59.28	51.03	74	-14.72	34.12	8.13	34	101	258	Peak
5220	101.1	92.71			34.17	8.22	34	101	258	Average
5220	108.66	100.27			34.17	8.22	34	101	258	Peak
5356	44.76	36.13	54	-9.24	34.28	8.38	34.03	101	258	Average
5356	59.81	51.18	74	-14.19	34.28	8.38	34.03	101	258	Peak
ANTENNA POLARITY & TEST DISTANCE: VERTICAL AT 3 M										
FREQ. (MHz)	EMISSION LEVEL (dBuV/m)	READ LEVEL (dBuV)	LIMIT (dBuV/m)	MARGIN (dB)	ANTENNA FACTOR (dB/m)	CABLE LOSS (dB)	PREAMP FACTOR (dB)	ANTENNA HEIGHT (cm)	TABLE ANGLE (Degree)	REMARK
5108	48.75	40.55	54	-5.25	34.09	8.1	33.99	205	180	Average
5108	59.2	51	74	-14.8	34.09	8.1	33.99	205	180	Peak
5220	104	95.61			34.17	8.22	34	184	180	Average
5220	111.73	103.34			34.17	8.22	34	184	180	Peak
5450	51.22	42.4	54	-2.78	34.36	8.51	34.05	203	180	Average
5450	61.64	52.82	74	-12.36	34.36	8.51	34.05	203	180	Peak

REMARKS:

- Emission Level = Read Level + Antenna Factor + Cable Loss - Preamp Factor
Margin value = Emission level – Limit value
- 5220 MHz: Fundamental frequency.



A D T

EUT TEST CONDITION		MEASUREMENT DETAIL	
CHANNEL	Channel 48	FREQUENCY RANGE	1 GHz ~ 40 GHz
INPUT POWER	120 Vac, 60 Hz	DETECTOR FUNCTION	Peak (PK) Average (AV)
ENVIRONMENTAL CONDITIONS	25 deg. C, 65 % RH	TESTED BY	Karl Lee

ANTENNA POLARITY & TEST DISTANCE: HORIZONTAL AT 3 M

FREQ. (MHz)	EMISSION LEVEL (dBuV/m)	READ LEVEL (dBuV)	LIMIT (dBuV/m)	MARGIN (dB)	ANTENNA FACTOR (dB/m)	CABLE LOSS (dB)	PREAMP FACTOR (dB)	ANTENNA HEIGHT (cm)	TABLE ANGLE (Degree)	REMARK
5082	43.13	34.97	54	-10.87	34.07	8.07	33.98	120	258	Average
5082	59.45	51.29	74	-14.55	34.07	8.07	33.98	120	258	Peak
5240	101.54	93.1			34.19	8.26	34.01	120	258	Average
5240	108.31	99.87			34.19	8.26	34.01	120	258	Peak
5392	44.02	35.34	54	-9.98	34.31	8.41	34.04	120	258	Average
5392	59.27	50.59	74	-14.73	34.31	8.41	34.04	120	258	Peak

ANTENNA POLARITY & TEST DISTANCE: VERTICAL AT 3 M

FREQ. (MHz)	EMISSION LEVEL (dBuV/m)	READ LEVEL (dBuV)	LIMIT (dBuV/m)	MARGIN (dB)	ANTENNA FACTOR (dB/m)	CABLE LOSS (dB)	PREAMP FACTOR (dB)	ANTENNA HEIGHT (cm)	TABLE ANGLE (Degree)	REMARK
5140	48.95	40.69	54	-5.05	34.12	8.13	33.99	197	180	Average
5140	58.91	50.65	74	-15.09	34.12	8.13	33.99	197	180	Peak
5240	104.24	95.8			34.19	8.26	34.01	209	180	Average
5240	111.69	103.25			34.19	8.26	34.01	209	180	Peak
5392	51.21	42.53	54	-2.79	34.31	8.41	34.04	203	180	Average
5392	61.74	53.06	74	-12.26	34.31	8.41	34.04	203	180	Peak

REMARKS:

- Emission Level = Read Level + Antenna Factor + Cable Loss - Preamp Factor
Margin value = Emission level – Limit value
- 5240 MHz: Fundamental frequency.



A D T

EUT TEST CONDITION		MEASUREMENT DETAIL	
CHANNEL	Channel 149	FREQUENCY RANGE	1 GHz ~ 40 GHz
INPUT POWER	120 Vac, 60 Hz	DETECTOR FUNCTION	Peak (PK) Average (AV)
ENVIRONMENTAL CONDITIONS	25 deg. C, 65 % RH	TESTED BY	Karl Lee

ANTENNA POLARITY & TEST DISTANCE: HORIZONTAL AT 3 M										
FREQ. (MHz)	EMISSION LEVEL (dBuV/m)	READ LEVEL (dBuV)	LIMIT (dBuV/m)	MARGIN (dB)	ANTENNA FACTOR (dB/m)	CABLE LOSS (dB)	PREAMP FACTOR (dB)	ANTENNA HEIGHT (cm)	TABLE ANGLE (Degree)	REMARK
*5714	58	48.85	68.2	-10.2	34.61	8.65	34.11	113	86	Peak
*5724	71.02	61.86	78.2	-7.18	34.62	8.65	34.11	113	86	Peak
5745	99.14	89.95			34.64	8.66	34.11	113	86	Average
5745	107.22	98.03			34.64	8.66	34.11	113	86	Peak
*5854	57.31	47.99	78.2	-20.89	34.76	8.7	34.14	113	86	Peak
*5864	56.9	47.57	68.2	-11.3	34.76	8.71	34.14	113	86	Peak
11490	48.57	33.45	54	-5.43	37.89	12.62	35.39	109	218	Average
11490	58.28	43.16	74	-15.72	37.89	12.62	35.39	109	218	Peak

ANTENNA POLARITY & TEST DISTANCE: VERTICAL AT 3 M										
FREQ. (MHz)	EMISSION LEVEL (dBuV/m)	READ LEVEL (dBuV)	LIMIT (dBuV/m)	MARGIN (dB)	ANTENNA FACTOR (dB/m)	CABLE LOSS (dB)	PREAMP FACTOR (dB)	ANTENNA HEIGHT (cm)	TABLE ANGLE (Degree)	REMARK
*5710	60.51	51.36	68.2	-7.69	34.61	8.65	34.11	203	176	Peak
*5722	75.9	66.74	78.2	-2.3	34.62	8.65	34.11	109	158	Peak
5745	103.07	93.88			34.64	8.66	34.11	203	176	Average
5745	111.19	102			34.64	8.66	34.11	203	176	Peak
*5852	58.14	48.84	78.2	-20.06	34.74	8.7	34.14	203	176	Peak
*5868	58.57	49.24	68.2	-9.63	34.76	8.71	34.14	203	176	Peak
11490	50.92	35.8	54	-3.08	37.89	12.62	35.39	100	212	Average
11490	61.6	46.48	74	-12.4	37.89	12.62	35.39	100	212	Peak

REMARKS:

- Emission Level = Read Level + Antenna Factor + Cable Loss - Preamp Factor
Margin value = Emission level – Limit value
- 5745 MHz: Fundamental frequency.
- *: Out of restricted band



EUT TEST CONDITION		MEASUREMENT DETAIL	
CHANNEL	Channel 157	FREQUENCY RANGE	1 GHz ~ 40 GHz
INPUT POWER	120 Vac, 60 Hz	DETECTOR FUNCTION	Peak (PK) Average (AV)
ENVIRONMENTAL CONDITIONS	25 deg. C, 65 % RH	TESTED BY	Karl Lee

ANTENNA POLARITY & TEST DISTANCE: HORIZONTAL AT 3 M										
FREQ. (MHz)	EMISSION LEVEL (dBuV/m)	READ LEVEL (dBuV)	LIMIT (dBuV/m)	MARGIN (dB)	ANTENNA FACTOR (dB/m)	CABLE LOSS (dB)	PREAMP FACTOR (dB)	ANTENNA HEIGHT (cm)	TABLE ANGLE (Degree)	REMARK
*5714	57.75	48.6	68.2	-10.45	34.61	8.65	34.11	181	86	Peak
*5724	58.17	49.01	78.2	-20.03	34.62	8.65	34.11	181	86	Peak
5785	99.67	90.44			34.68	8.68	34.13	181	86	Average
5785	107.7	98.47			34.68	8.68	34.13	181	86	Peak
*5852	58	48.7	78.2	-20.2	34.74	8.7	34.14	181	86	Peak
*5864	58.02	48.69	68.2	-10.18	34.76	8.71	34.14	181	86	Peak
11570	48.02	32.71	54	-5.98	38	12.68	35.37	100	263	Average
11570	57.74	42.43	74	-16.26	38	12.68	35.37	100	263	Peak

ANTENNA POLARITY & TEST DISTANCE: VERTICAL AT 3 M										
FREQ. (MHz)	EMISSION LEVEL (dBuV/m)	READ LEVEL (dBuV)	LIMIT (dBuV/m)	MARGIN (dB)	ANTENNA FACTOR (dB/m)	CABLE LOSS (dB)	PREAMP FACTOR (dB)	ANTENNA HEIGHT (cm)	TABLE ANGLE (Degree)	REMARK
*5710	58.67	49.52	68.2	-9.53	34.61	8.65	34.11	122	0	Peak
*5716	60.4	51.25	78.2	-17.8	34.61	8.65	34.11	122	0	Peak
5785	103.72	94.49			34.68	8.68	34.13	122	0	Average
5785	110.43	101.2			34.68	8.68	34.13	122	0	Peak
*5852	58.03	48.73	78.2	-20.17	34.74	8.7	34.14	122	0	Peak
*5870	58.27	48.94	68.2	-9.93	34.76	8.71	34.14	122	0	Peak
11570	51.74	36.43	54	-2.26	38	12.68	35.37	192	174	Average
11570	61.41	46.1	74	-12.59	38	12.68	35.37	192	174	Peak

REMARKS:

- Emission Level = Read Level + Antenna Factor + Cable Loss - Preamp Factor
Margin value = Emission level – Limit value
- 5785 MHz: Fundamental frequency.
- *: Out of restricted band



A D T

EUT TEST CONDITION		MEASUREMENT DETAIL	
CHANNEL	Channel 161	FREQUENCY RANGE	1 GHz ~ 40 GHz
INPUT POWER	120 Vac, 60 Hz	DETECTOR FUNCTION	Peak (PK) Average (AV)
ENVIRONMENTAL CONDITIONS	25 deg. C, 65 % RH	TESTED BY	Karl Lee

ANTENNA POLARITY & TEST DISTANCE: HORIZONTAL AT 3 M										
FREQ. (MHz)	EMISSION LEVEL (dBuV/m)	READ LEVEL (dBuV)	LIMIT (dBuV/m)	MARGIN (dB)	ANTENNA FACTOR (dB/m)	CABLE LOSS (dB)	PREAMP FACTOR (dB)	ANTENNA HEIGHT (cm)	TABLE ANGLE (Degree)	REMARK
*5714	58.73	49.58	68.2	-9.47	34.61	8.65	34.11	215	84	Peak
*5718	57.87	48.71	78.2	-20.33	34.62	8.65	34.11	215	84	Peak
5805	99.49	90.23			34.71	8.68	34.13	215	84	Average
5805	106.93	97.67			34.71	8.68	34.13	215	84	Peak
*5854	58.82	49.5	78.2	-19.38	34.76	8.7	34.14	215	84	Peak
*5862	57.97	48.64	68.2	-10.23	34.76	8.71	34.14	215	84	Peak
11610	48.17	32.74	54	-5.83	38.04	12.76	35.37	100	170	Average
11610	58.57	43.14	74	-15.43	38.04	12.76	35.37	100	170	Peak

ANTENNA POLARITY & TEST DISTANCE: VERTICAL AT 3 M										
FREQ. (MHz)	EMISSION LEVEL (dBuV/m)	READ LEVEL (dBuV)	LIMIT (dBuV/m)	MARGIN (dB)	ANTENNA FACTOR (dB/m)	CABLE LOSS (dB)	PREAMP FACTOR (dB)	ANTENNA HEIGHT (cm)	TABLE ANGLE (Degree)	REMARK
*5712	58.34	49.19	68.2	-9.86	34.61	8.65	34.11	122	0	Peak
*5724	57.98	48.82	78.2	-20.22	34.62	8.65	34.11	122	0	Peak
5805	103.89	94.63			34.71	8.68	34.13	122	0	Average
5805	110.77	101.51			34.71	8.68	34.13	122	0	Peak
*5858	57.9	48.58	78.2	-20.3	34.76	8.7	34.14	122	0	Peak
*5862	56.6	47.27	68.2	-11.6	34.76	8.71	34.14	122	0	Peak
11610	50.28	34.85	54	-3.72	38.04	12.76	35.37	100	244	Average
11610	60.11	44.68	74	-13.89	38.04	12.76	35.37	100	244	Peak

REMARKS:

- Emission Level = Read Level + Antenna Factor + Cable Loss - Preamp Factor
Margin value = Emission level – Limit value
- 5805 MHz: Fundamental frequency.
- *: Out of restricted band

802.11n (HT20)

EUT TEST CONDITION		MEASUREMENT DETAIL	
CHANNEL	Channel 36	FREQUENCY RANGE	1 GHz ~ 40 GHz
INPUT POWER	120 Vac, 60 Hz	DETECTOR FUNCTION	Peak (PK) Average (AV)
ENVIRONMENTAL CONDITIONS	25 deg. C, 65 % RH	TESTED BY	Karl Lee

ANTENNA POLARITY & TEST DISTANCE: HORIZONTAL AT 3 M

FREQ. (MHz)	EMISSION LEVEL (dBuV/m)	READ LEVEL (dBuV)	LIMIT (dBuV/m)	MARGIN (dB)	ANTENNA FACTOR (dB/m)	CABLE LOSS (dB)	PREAMP FACTOR (dB)	ANTENNA HEIGHT (cm)	TABLE ANGLE (Degree)	REMARK
5074	45	36.88	54	-9	34.07	8.03	33.98	122	258	Average
5074	59.38	51.26	74	-14.62	34.07	8.03	33.98	122	258	Peak
5180	99.51	91.2			34.15	8.16	34	122	258	Average
5180	106.97	98.66			34.15	8.16	34	122	258	Peak
5376	44.71	36.05	54	-9.29	34.29	8.41	34.04	122	258	Average
5376	60.09	51.43	74	-13.91	34.29	8.41	34.04	122	258	Peak

ANTENNA POLARITY & TEST DISTANCE: VERTICAL AT 3 M

FREQ. (MHz)	EMISSION LEVEL (dBuV/m)	READ LEVEL (dBuV)	LIMIT (dBuV/m)	MARGIN (dB)	ANTENNA FACTOR (dB/m)	CABLE LOSS (dB)	PREAMP FACTOR (dB)	ANTENNA HEIGHT (cm)	TABLE ANGLE (Degree)	REMARK
5140	50.4	42.14	54	-3.6	34.12	8.13	33.99	206	180	Average
5140	60.11	51.85	74	-13.89	34.12	8.13	33.99	206	180	Peak
5180	103.31	95			34.15	8.16	34	184	180	Average
5180	110.43	102.12			34.15	8.16	34	184	180	Peak
5432	51.17	42.38	54	-2.83	34.35	8.48	34.04	203	180	Average
5432	62.06	53.27	74	-11.94	34.35	8.48	34.04	203	180	Peak

REMARKS:

- Emission Level = Read Level + Antenna Factor + Cable Loss - Preamp Factor
Margin value = Emission level – Limit value
- 5180 MHz: Fundamental frequency.

EUT TEST CONDITION		MEASUREMENT DETAIL	
CHANNEL	Channel 44	FREQUENCY RANGE	1 GHz ~ 40 GHz
INPUT POWER	120 Vac, 60 Hz	DETECTOR FUNCTION	Peak (PK) Average (AV)
ENVIRONMENTAL CONDITIONS	25 deg. C, 65 % RH	TESTED BY	Karl Lee

ANTENNA POLARITY & TEST DISTANCE: HORIZONTAL AT 3 M										
FREQ. (MHz)	EMISSION LEVEL (dBuV/m)	READ LEVEL (dBuV)	LIMIT (dBuV/m)	MARGIN (dB)	ANTENNA FACTOR (dB/m)	CABLE LOSS (dB)	PREAMP FACTOR (dB)	ANTENNA HEIGHT (cm)	TABLE ANGLE (Degree)	REMARK
5040	43.64	35.57	54	-10.36	34.04	8	33.97	101	258	Average
5040	58.85	50.78	74	-15.15	34.04	8	33.97	101	258	Peak
5220	101	92.61			34.17	8.22	34	101	258	Average
5220	108.03	99.64			34.17	8.22	34	101	258	Peak
5420	44.41	35.64	54	-9.59	34.33	8.48	34.04	101	258	Average
5420	59.65	50.88	74	-14.35	34.33	8.48	34.04	101	258	Peak
ANTENNA POLARITY & TEST DISTANCE: VERTICAL AT 3 M										
FREQ. (MHz)	EMISSION LEVEL (dBuV/m)	READ LEVEL (dBuV)	LIMIT (dBuV/m)	MARGIN (dB)	ANTENNA FACTOR (dB/m)	CABLE LOSS (dB)	PREAMP FACTOR (dB)	ANTENNA HEIGHT (cm)	TABLE ANGLE (Degree)	REMARK
5138	49.14	40.89	54	-4.86	34.11	8.13	33.99	197	180	Average
5138	59.28	51.03	74	-14.72	34.11	8.13	33.99	197	180	Peak
5220	105.5	97.11			34.17	8.22	34	184	180	Average
5220	112	103.61			34.17	8.22	34	184	180	Peak
5450	51.57	42.75	54	-2.43	34.36	8.51	34.05	203	180	Average
5450	61.84	53.02	74	-12.16	34.36	8.51	34.05	203	180	Peak

REMARKS:

- Emission Level = Read Level + Antenna Factor + Cable Loss - Preamp Factor
Margin value = Emission level – Limit value
- 5220 MHz: Fundamental frequency.



A D T

EUT TEST CONDITION		MEASUREMENT DETAIL	
CHANNEL	Channel 48	FREQUENCY RANGE	1 GHz ~ 40 GHz
INPUT POWER	120 Vac, 60 Hz	DETECTOR FUNCTION	Peak (PK) Average (AV)
ENVIRONMENTAL CONDITIONS	25 deg. C, 65 % RH	TESTED BY	Karl Lee

ANTENNA POLARITY & TEST DISTANCE: HORIZONTAL AT 3 M										
FREQ. (MHz)	EMISSION LEVEL (dBuV/m)	READ LEVEL (dBuV)	LIMIT (dBuV/m)	MARGIN (dB)	ANTENNA FACTOR (dB/m)	CABLE LOSS (dB)	PREAMP FACTOR (dB)	ANTENNA HEIGHT (cm)	TABLE ANGLE (Degree)	REMARK
5120	43.39	35.19	54	-10.61	34.09	8.1	33.99	120	258	Average
5120	59.5	51.3	74	-14.5	34.09	8.1	33.99	120	258	Peak
5240	100.19	91.75			34.19	8.26	34.01	120	258	Average
5240	108.17	99.73			34.19	8.26	34.01	120	258	Peak
5424	45.41	36.64	54	-8.59	34.33	8.48	34.04	120	258	Average
5424	59.9	51.13	74	-14.1	34.33	8.48	34.04	120	258	Peak

ANTENNA POLARITY & TEST DISTANCE: VERTICAL AT 3 M										
FREQ. (MHz)	EMISSION LEVEL (dBuV/m)	READ LEVEL (dBuV)	LIMIT (dBuV/m)	MARGIN (dB)	ANTENNA FACTOR (dB/m)	CABLE LOSS (dB)	PREAMP FACTOR (dB)	ANTENNA HEIGHT (cm)	TABLE ANGLE (Degree)	REMARK
5102	48.54	40.38	54	-5.46	34.08	8.07	33.99	205	180	Average
5102	58.79	50.63	74	-15.21	34.08	8.07	33.99	205	180	Peak
5240	104.44	96			34.19	8.26	34.01	209	180	Average
5240	111.83	103.39			34.19	8.26	34.01	209	180	Peak
5456	51.26	42.44	54	-2.74	34.36	8.51	34.05	202	180	Average
5456	61.91	53.09	74	-12.09	34.36	8.51	34.05	202	180	Peak

REMARKS:

- Emission Level = Read Level + Antenna Factor + Cable Loss - Preamp Factor
Margin value = Emission level – Limit value
- 5240 MHz: Fundamental frequency.

EUT TEST CONDITION		MEASUREMENT DETAIL	
CHANNEL	Channel 149	FREQUENCY RANGE	1 GHz ~ 40 GHz
INPUT POWER	120 Vac, 60 Hz	DETECTOR FUNCTION	Peak (PK) Average (AV)
ENVIRONMENTAL CONDITIONS	25 deg. C, 65 % RH	TESTED BY	Karl Lee

ANTENNA POLARITY & TEST DISTANCE: HORIZONTAL AT 3 M										
FREQ. (MHz)	EMISSION LEVEL (dBuV/m)	READ LEVEL (dBuV)	LIMIT (dBuV/m)	MARGIN (dB)	ANTENNA FACTOR (dB/m)	CABLE LOSS (dB)	PREAMP FACTOR (dB)	ANTENNA HEIGHT (cm)	TABLE ANGLE (Degree)	REMARK
5712	57.62	48.47	68.2	-10.58	34.61	8.65	34.11	112	86	Peak
5724	67.61	58.45	78.2	-10.59	34.62	8.65	34.11	112	86	Peak
5745	96.23	87.04			34.64	8.66	34.11	112	86	Average
5745	104.09	94.9			34.64	8.66	34.11	112	86	Peak
5858	57.16	47.84	78.2	-21.04	34.76	8.7	34.14	112	86	Peak
5868	57.05	47.72	68.2	-11.15	34.76	8.71	34.14	112	86	Peak
ANTENNA POLARITY & TEST DISTANCE: VERTICAL AT 3 M										
FREQ. (MHz)	EMISSION LEVEL (dBuV/m)	READ LEVEL (dBuV)	LIMIT (dBuV/m)	MARGIN (dB)	ANTENNA FACTOR (dB/m)	CABLE LOSS (dB)	PREAMP FACTOR (dB)	ANTENNA HEIGHT (cm)	TABLE ANGLE (Degree)	REMARK
5712	59.42	50.27	68.2	-8.78	34.61	8.65	34.11	197	345	Peak
5724	74.71	65.55	78.2	-3.49	34.62	8.65	34.11	197	345	Peak
5745	101.87	92.68			34.64	8.66	34.11	197	345	Average
5745	108.75	99.56			34.64	8.66	34.11	197	345	Peak
5860	58.9	49.58	78.2	-19.3	34.76	8.7	34.14	197	345	Peak
5870	58.5	49.17	68.2	-9.7	34.76	8.71	34.14	197	345	Peak

REMARKS:

- Emission Level = Read Level + Antenna Factor + Cable Loss - Preamp Factor
Margin value = Emission level – Limit value
- 5745 MHz: Fundamental frequency.
- *: Out of restricted band



A D T

EUT TEST CONDITION		MEASUREMENT DETAIL	
CHANNEL	Channel 157	FREQUENCY RANGE	1 GHz ~ 40 GHz
INPUT POWER	120 Vac, 60 Hz	DETECTOR FUNCTION	Peak (PK) Average (AV)
ENVIRONMENTAL CONDITIONS	25 deg. C, 65 % RH	TESTED BY	Karl Lee

ANTENNA POLARITY & TEST DISTANCE: HORIZONTAL AT 3 M

FREQ. (MHz)	EMISSION LEVEL (dBuV/m)	READ LEVEL (dBuV)	LIMIT (dBuV/m)	MARGIN (dB)	ANTENNA FACTOR (dB/m)	CABLE LOSS (dB)	PREAMP FACTOR (dB)	ANTENNA HEIGHT (cm)	TABLE ANGLE (Degree)	REMARK
*5712	57.79	48.64	68.2	-10.41	34.61	8.65	34.11	181	86	Peak
*5718	58.33	49.17	78.2	-19.87	34.62	8.65	34.11	181	86	Peak
5785	99.13	89.9			34.68	8.68	34.13	181	86	Average
5785	106.77	97.54			34.68	8.68	34.13	181	86	Peak
*5858	57.85	48.53	78.2	-20.35	34.76	8.7	34.14	181	86	Peak
*5866	58.16	48.83	68.2	-10.04	34.76	8.71	34.14	181	86	Peak
11570	47.6	32.29	54	-6.4	38	12.68	35.37	100	263	Average
11570	57.84	42.53	74	-16.16	38	12.68	35.37	100	263	Peak

ANTENNA POLARITY & TEST DISTANCE: VERTICAL AT 3 M

FREQ. (MHz)	EMISSION LEVEL (dBuV/m)	READ LEVEL (dBuV)	LIMIT (dBuV/m)	MARGIN (dB)	ANTENNA FACTOR (dB/m)	CABLE LOSS (dB)	PREAMP FACTOR (dB)	ANTENNA HEIGHT (cm)	TABLE ANGLE (Degree)	REMARK
*5714	58.67	49.52	68.2	-9.53	34.61	8.65	34.11	122	0	Peak
*5724	59.47	50.31	78.2	-18.73	34.62	8.65	34.11	122	0	Peak
5785	103.9	94.67			34.68	8.68	34.13	122	0	Average
5785	110.22	100.99			34.68	8.68	34.13	122	0	Peak
*5854	58.57	49.25	78.2	-19.63	34.76	8.7	34.14	122	0	Peak
*5862	57.52	48.19	68.2	-10.68	34.76	8.71	34.14	122	0	Peak
11570	50.7	35.39	54	-3.3	38	12.68	35.37	192	174	Average
11570	60.19	44.88	74	-13.81	38	12.68	35.37	192	174	Peak

REMARKS:

- Emission Level = Read Level + Antenna Factor + Cable Loss - Preamp Factor
Margin value = Emission level – Limit value
- 5785 MHz: Fundamental frequency.
- *: Out of restricted band



A D T

EUT TEST CONDITION		MEASUREMENT DETAIL	
CHANNEL	Channel 161	FREQUENCY RANGE	1 GHz ~ 40 GHz
INPUT POWER	120 Vac, 60 Hz	DETECTOR FUNCTION	Peak (PK) Average (AV)
ENVIRONMENTAL CONDITIONS	25 deg. C, 65 % RH	TESTED BY	Karl Lee

ANTENNA POLARITY & TEST DISTANCE: HORIZONTAL AT 3 M

FREQ. (MHz)	EMISSION LEVEL (dBuV/m)	READ LEVEL (dBuV)	LIMIT (dBuV/m)	MARGIN (dB)	ANTENNA FACTOR (dB/m)	CABLE LOSS (dB)	PREAMP FACTOR (dB)	ANTENNA HEIGHT (cm)	TABLE ANGLE (Degree)	REMARK
*5708	58.76	49.61	68.2	-9.44	34.61	8.65	34.11	215	84	Peak
*5720	59.06	49.9	78.2	-19.14	34.62	8.65	34.11	215	84	Peak
5805	98.79	89.53			34.71	8.68	34.13	215	84	Average
5805	105.68	96.42			34.71	8.68	34.13	215	84	Peak
*5860	59.3	49.98	78.2	-18.9	34.76	8.7	34.14	215	84	Peak
*5870	59.69	50.36	68.2	-8.51	34.76	8.71	34.14	215	84	Peak
11610	48.44	33.01	54	-5.56	38.04	12.76	35.37	100	170	Average
11610	58.34	42.91	74	-15.66	38.04	12.76	35.37	100	170	Peak

ANTENNA POLARITY & TEST DISTANCE: VERTICAL AT 3 M

FREQ. (MHz)	EMISSION LEVEL (dBuV/m)	READ LEVEL (dBuV)	LIMIT (dBuV/m)	MARGIN (dB)	ANTENNA FACTOR (dB/m)	CABLE LOSS (dB)	PREAMP FACTOR (dB)	ANTENNA HEIGHT (cm)	TABLE ANGLE (Degree)	REMARK
*5712	58.96	49.81	68.2	-9.24	34.61	8.65	34.11	115	0	Peak
*5722	59.85	50.69	78.2	-18.35	34.62	8.65	34.11	115	0	Peak
5805	102.83	93.57			34.71	8.68	34.13	115	0	Average
5805	109.62	100.36			34.71	8.68	34.13	115	0	Peak
*5852	59.66	50.36	78.2	-18.54	34.74	8.7	34.14	115	0	Peak
*5866	59.39	50.06	68.2	-8.81	34.76	8.71	34.14	115	0	Peak
11610	49.98	34.55	54	-4.02	38.04	12.76	35.37	204	161	Average
11610	59.69	44.26	74	-14.31	38.04	12.76	35.37	204	161	Peak

REMARKS:

- Emission Level = Read Level + Antenna Factor + Cable Loss - Preamp Factor
Margin value = Emission level – Limit value
- 5805 MHz: Fundamental frequency.
- *: Out of restricted band

802.11n (HT40)

EUT TEST CONDITION		MEASUREMENT DETAIL	
CHANNEL	Channel 38	FREQUENCY RANGE	1 GHz ~ 40 GHz
INPUT POWER	120 Vac, 60 Hz	DETECTOR FUNCTION	Peak (PK) Average (AV)
ENVIRONMENTAL CONDITIONS	25 deg. C, 65 % RH	TESTED BY	Karl Lee

ANTENNA POLARITY & TEST DISTANCE: HORIZONTAL AT 3 M

FREQ. (MHz)	EMISSION LEVEL (dBuV/m)	READ LEVEL (dBuV)	LIMIT (dBuV/m)	MARGIN (dB)	ANTENNA FACTOR (dB/m)	CABLE LOSS (dB)	PREAMP FACTOR (dB)	ANTENNA HEIGHT (cm)	TABLE ANGLE (Degree)	REMARK
5150	47.31	39.06	54	-6.69	34.12	8.13	34	102	90	Average
5150	58.13	49.88	74	-15.87	34.12	8.13	34	102	90	Peak
5190	92.37	84.03			34.15	8.19	34	102	90	Average
5190	99.39	91.05			34.15	8.19	34	102	90	Peak
5448	43.57	34.74	54	-10.43	34.36	8.51	34.04	102	90	Average
5448	58.34	49.51	74	-15.66	34.36	8.51	34.04	102	90	Peak

ANTENNA POLARITY & TEST DISTANCE: VERTICAL AT 3 M

FREQ. (MHz)	EMISSION LEVEL (dBuV/m)	READ LEVEL (dBuV)	LIMIT (dBuV/m)	MARGIN (dB)	ANTENNA FACTOR (dB/m)	CABLE LOSS (dB)	PREAMP FACTOR (dB)	ANTENNA HEIGHT (cm)	TABLE ANGLE (Degree)	REMARK
5150	52.41	44.16	54	-1.59	34.12	8.13	34	182	54	Average
5150	63.83	55.58	74	-10.17	34.12	8.13	34	182	54	Peak
5190	95.98	87.64			34.15	8.19	34	182	54	Average
5190	103.76	95.42			34.15	8.19	34	182	54	Peak
5428	44.57	35.8	54	-9.43	34.33	8.48	34.04	182	54	Average
5428	58.25	49.48	74	-15.75	34.33	8.48	34.04	182	54	Peak

REMARKS:

- Emission Level = Read Level + Antenna Factor + Cable Loss - Preamp Factor
Margin value = Emission level – Limit value
- 5190 MHz: Fundamental frequency.



A D T

EUT TEST CONDITION		MEASUREMENT DETAIL	
CHANNEL	Channel 46	FREQUENCY RANGE	1 GHz ~ 40 GHz
INPUT POWER	120 Vac, 60 Hz	DETECTOR FUNCTION	Peak (PK) Average (AV)
ENVIRONMENTAL CONDITIONS	25 deg. C, 65 % RH	TESTED BY	Karl Lee

ANTENNA POLARITY & TEST DISTANCE: HORIZONTAL AT 3 M

FREQ. (MHz)	EMISSION LEVEL (dBuV/m)	READ LEVEL (dBuV)	LIMIT (dBuV/m)	MARGIN (dB)	ANTENNA FACTOR (dB/m)	CABLE LOSS (dB)	PREAMP FACTOR (dB)	ANTENNA HEIGHT (cm)	TABLE ANGLE (Degree)	REMARK
5122	43.31	35.11	54	-10.69	34.09	8.1	33.99	106	90	Average
5122	58.34	50.14	74	-15.66	34.09	8.1	33.99	106	90	Peak
5230	96.11	87.71			34.19	8.22	34.01	106	90	Average
5230	104.65	96.25			34.19	8.22	34.01	106	90	Peak
5432	44.24	35.45	54	-9.76	34.35	8.48	34.04	106	90	Average
5432	57.17	48.38	74	-16.83	34.35	8.48	34.04	106	90	Peak

ANTENNA POLARITY & TEST DISTANCE: VERTICAL AT 3 M

FREQ. (MHz)	EMISSION LEVEL (dBuV/m)	READ LEVEL (dBuV)	LIMIT (dBuV/m)	MARGIN (dB)	ANTENNA FACTOR (dB/m)	CABLE LOSS (dB)	PREAMP FACTOR (dB)	ANTENNA HEIGHT (cm)	TABLE ANGLE (Degree)	REMARK
5146	46.23	37.98	54	-7.77	34.12	8.13	34	203	360	Average
5146	58.25	50	74	-15.75	34.12	8.13	34	203	360	Peak
5230	101.62	93.22			34.19	8.22	34.01	203	360	Average
5230	108.38	99.98			34.19	8.22	34.01	203	360	Peak
5422	48.74	39.97	54	-5.26	34.33	8.48	34.04	203	246	Average
5422	61.17	52.4	74	-12.83	34.33	8.48	34.04	203	246	Peak

REMARKS:

- Emission Level = Read Level + Antenna Factor + Cable Loss - Preamp Factor
Margin value = Emission level – Limit value
- 5230 MHz: Fundamental frequency.

EUT TEST CONDITION		MEASUREMENT DETAIL	
CHANNEL	Channel 151	FREQUENCY RANGE	1 GHz ~ 40 GHz
INPUT POWER	120 Vac, 60 Hz	DETECTOR FUNCTION	Peak (PK) Average (AV)
ENVIRONMENTAL CONDITIONS	25 deg. C, 65 % RH	TESTED BY	Karl Lee

ANTENNA POLARITY & TEST DISTANCE: HORIZONTAL AT 3 M										
FREQ. (MHz)	EMISSION LEVEL (dBuV/m)	READ LEVEL (dBuV)	LIMIT (dBuV/m)	MARGIN (dB)	ANTENNA FACTOR (dB/m)	CABLE LOSS (dB)	PREAMP FACTOR (dB)	ANTENNA HEIGHT (cm)	TABLE ANGLE (Degree)	REMARK
*5714	57.18	48.03	68.2	-11.02	34.61	8.65	34.11	211	83	Peak
*5722	64.62	55.46	78.2	-13.58	34.62	8.65	34.11	211	83	Peak
5755	94.39	85.18			34.66	8.66	34.11	211	83	Average
5755	101.09	91.88			34.66	8.66	34.11	211	83	Peak
*5858	55.79	46.47	78.2	-22.41	34.76	8.7	34.14	211	83	Peak
*5862	56.92	47.59	68.2	-11.28	34.76	8.71	34.14	211	83	Peak
ANTENNA POLARITY & TEST DISTANCE: VERTICAL AT 3 M										
FREQ. (MHz)	EMISSION LEVEL (dBuV/m)	READ LEVEL (dBuV)	LIMIT (dBuV/m)	MARGIN (dB)	ANTENNA FACTOR (dB/m)	CABLE LOSS (dB)	PREAMP FACTOR (dB)	ANTENNA HEIGHT (cm)	TABLE ANGLE (Degree)	REMARK
*5714	66.39	57.24	68.2	-1.81	34.61	8.65	34.11	196	360	Peak
*5724	69.79	60.63	78.2	-8.41	34.62	8.65	34.11	196	360	Peak
5755	98.42	89.21			34.66	8.66	34.11	196	360	Average
5755	105.82	96.61			34.66	8.66	34.11	196	360	Peak
*5854	56.77	47.45	78.2	-21.43	34.76	8.7	34.14	196	360	Peak
*5868	57.79	48.46	68.2	-10.41	34.76	8.71	34.14	196	360	Peak

REMARKS:

- Emission Level = Read Level + Antenna Factor + Cable Loss - Preamp Factor
Margin value = Emission level – Limit value
- 5755 MHz: Fundamental frequency.
- *: Out of restricted band



EUT TEST CONDITION		MEASUREMENT DETAIL	
CHANNEL	Channel 159	FREQUENCY RANGE	1 GHz ~ 40 GHz
INPUT POWER	120 Vac, 60 Hz	DETECTOR FUNCTION	Peak (PK) Average (AV)
ENVIRONMENTAL CONDITIONS	25 deg. C, 65 % RH	TESTED BY	Karl Lee

ANTENNA POLARITY & TEST DISTANCE: HORIZONTAL AT 3 M

FREQ. (MHz)	EMISSION LEVEL (dBuV/m)	READ LEVEL (dBuV)	LIMIT (dBuV/m)	MARGIN (dB)	ANTENNA FACTOR (dB/m)	CABLE LOSS (dB)	PREAMP FACTOR (dB)	ANTENNA HEIGHT (cm)	TABLE ANGLE (Degree)	REMARK
*5710	59.11	49.96	68.2	-9.09	34.61	8.65	34.11	214	84	Peak
*5722	59.29	50.13	78.2	-18.91	34.62	8.65	34.11	214	84	Peak
5795	97.47	88.23			34.69	8.68	34.13	214	84	Average
5795	104.34	95.1			34.69	8.68	34.13	214	84	Peak
*5852	59.17	49.87	78.2	-19.03	34.74	8.7	34.14	214	84	Peak
*5868	60.48	51.15	68.2	-7.72	34.76	8.71	34.14	214	84	Peak

ANTENNA POLARITY & TEST DISTANCE: VERTICAL AT 3 M

FREQ. (MHz)	EMISSION LEVEL (dBuV/m)	READ LEVEL (dBuV)	LIMIT (dBuV/m)	MARGIN (dB)	ANTENNA FACTOR (dB/m)	CABLE LOSS (dB)	PREAMP FACTOR (dB)	ANTENNA HEIGHT (cm)	TABLE ANGLE (Degree)	REMARK
*5708	61.43	52.28	68.2	-6.77	34.61	8.65	34.11	212	100	Peak
*5724	59.86	50.7	78.2	-18.34	34.62	8.65	34.11	212	100	Peak
5795	101.17	91.93			34.69	8.68	34.13	212	100	Average
5795	108.16	98.92			34.69	8.68	34.13	212	100	Peak
*5856	60.43	51.11	78.2	-17.77	34.76	8.7	34.14	212	100	Peak
*5866	60.07	50.74	68.2	-8.13	34.76	8.71	34.14	212	100	Peak

REMARKS:

- Emission Level = Read Level + Antenna Factor + Cable Loss - Preamp Factor
Margin value = Emission level – Limit value
- 5795 MHz: Fundamental frequency.
- *: Out of restricted band

802.11ac (VHT80)

EUT TEST CONDITION		MEASUREMENT DETAIL	
CHANNEL	Channel 42	FREQUENCY RANGE	1 GHz ~ 40 GHz
INPUT POWER	120 Vac, 60 Hz	DETECTOR FUNCTION	Peak (PK) Average (AV)
ENVIRONMENTAL CONDITIONS	25 deg. C, 65 % RH	TESTED BY	Karl Lee

ANTENNA POLARITY & TEST DISTANCE: HORIZONTAL AT 3 M

FREQ. (MHz)	EMISSION LEVEL (dBuV/m)	READ LEVEL (dBuV)	LIMIT (dBuV/m)	MARGIN (dB)	ANTENNA FACTOR (dB/m)	CABLE LOSS (dB)	PREAMP FACTOR (dB)	ANTENNA HEIGHT (cm)	TABLE ANGLE (Degree)	REMARK
5144	45.92	37.67	54	-8.08	34.12	8.13	34	109	92	Average
5144	59.75	51.5	74	-14.25	34.12	8.13	34	109	92	Peak
5210	87.53	79.17			34.17	8.19	34	109	92	Average
5210	95.18	86.82			34.17	8.19	34	109	92	Peak
5442	43.61	34.82	54	-10.39	34.35	8.48	34.04	109	92	Average
5442	59.49	50.7	74	-14.51	34.35	8.48	34.04	109	92	Peak

ANTENNA POLARITY & TEST DISTANCE: VERTICAL AT 3 M

FREQ. (MHz)	EMISSION LEVEL (dBuV/m)	READ LEVEL (dBuV)	LIMIT (dBuV/m)	MARGIN (dB)	ANTENNA FACTOR (dB/m)	CABLE LOSS (dB)	PREAMP FACTOR (dB)	ANTENNA HEIGHT (cm)	TABLE ANGLE (Degree)	REMARK
5150	52.94	44.69	54	-1.06	34.12	8.13	34	214	189	Average
5150	66.02	57.77	74	-7.98	34.12	8.13	34	214	189	Peak
5210	90.02	81.66			34.17	8.19	34	214	189	Average
5210	98.77	90.41			34.17	8.19	34	214	189	Peak
5364	44.51	35.87	54	-9.49	34.29	8.38	34.03	214	189	Average
5364	57.66	49.02	74	-16.34	34.29	8.38	34.03	214	189	Peak

REMARKS:

- Emission Level = Read Level + Antenna Factor + Cable Loss - Preamp Factor
Margin value = Emission level – Limit value
- 5210 MHz: Fundamental frequency.



A D T

EUT TEST CONDITION		MEASUREMENT DETAIL	
CHANNEL	Channel 155	FREQUENCY RANGE	1 GHz ~ 40 GHz
INPUT POWER	120 Vac, 60 Hz	DETECTOR FUNCTION	Peak (PK) Average (AV)
ENVIRONMENTAL CONDITIONS	25 deg. C, 65 % RH	TESTED BY	Karl Lee

ANTENNA POLARITY & TEST DISTANCE: HORIZONTAL AT 3 M

FREQ. (MHz)	EMISSION LEVEL (dBuV/m)	READ LEVEL (dBuV)	LIMIT (dBuV/m)	MARGIN (dB)	ANTENNA FACTOR (dB/m)	CABLE LOSS (dB)	PREAMP FACTOR (dB)	ANTENNA HEIGHT (cm)	TABLE ANGLE (Degree)	REMARK
*5710	60.85	51.7	68.2	-7.35	34.61	8.65	34.11	113	86	Peak
*5724	67.26	58.1	78.2	-10.94	34.62	8.65	34.11	113	86	Peak
5775	89.46	80.23			34.68	8.67	34.12	113	86	Average
5775	97.15	87.92			34.68	8.67	34.12	113	86	Peak
*5856	57.55	48.23	78.2	-20.65	34.76	8.7	34.14	113	86	Peak
*5870	57.26	47.93	68.2	-10.94	34.76	8.71	34.14	113	86	Peak

ANTENNA POLARITY & TEST DISTANCE: VERTICAL AT 3 M

FREQ. (MHz)	EMISSION LEVEL (dBuV/m)	READ LEVEL (dBuV)	LIMIT (dBuV/m)	MARGIN (dB)	ANTENNA FACTOR (dB/m)	CABLE LOSS (dB)	PREAMP FACTOR (dB)	ANTENNA HEIGHT (cm)	TABLE ANGLE (Degree)	REMARK
*5710	66.45	57.3	68.2	-1.75	34.61	8.65	34.11	109	184	Peak
*5722	71.99	62.83	78.2	-6.21	34.62	8.65	34.11	109	184	Peak
5775	93.99	84.76			34.68	8.67	34.12	109	184	Average
5775	101.63	92.4			34.68	8.67	34.12	109	184	Peak
*5852	58.23	48.93	78.2	-19.97	34.74	8.7	34.14	109	184	Peak
*5868	57.8	48.47	68.2	-10.4	34.76	8.71	34.14	109	184	Peak

REMARKS:

- Emission Level = Read Level + Antenna Factor + Cable Loss - Preamp Factor
Margin value = Emission level – Limit value
- 5775 MHz: Fundamental frequency.
- *: Out of restricted band

Mode B
802.11a

EUT TEST CONDITION		MEASUREMENT DETAIL	
CHANNEL	Channel 36	FREQUENCY RANGE	1 GHz ~ 40 GHz
INPUT POWER	120 Vac, 60 Hz	DETECTOR FUNCTION	Peak (PK) Average (AV)
ENVIRONMENTAL CONDITIONS	25 deg. C, 65 % RH	TESTED BY	Karl Lee

ANTENNA POLARITY & TEST DISTANCE: HORIZONTAL AT 3 M										
FREQ. (MHz)	EMISSION LEVEL (dBuV/m)	READ LEVEL (dBuV)	LIMIT (dBuV/m)	MARGIN (dB)	ANTENNA FACTOR (dB/m)	CABLE LOSS (dB)	PREAMP FACTOR (dB)	ANTENNA HEIGHT (cm)	TABLE ANGLE (Degree)	REMARK
5150	52.9	44.65	54	-1.1	34.12	8.13	34	100	142	Average
5150	65.95	57.7	74	-8.05	34.12	8.13	34	100	142	Peak
5180	106.51	98.2			34.15	8.16	34	107	136	Average
5180	113.34	105.03			34.15	8.16	34	107	136	Peak
5446	51.64	42.81	54	-2.36	34.36	8.51	34.04	103	108	Average
5446	61.77	52.94	74	-12.23	34.36	8.51	34.04	103	108	Peak

ANTENNA POLARITY & TEST DISTANCE: VERTICAL AT 3 M										
FREQ. (MHz)	EMISSION LEVEL (dBuV/m)	READ LEVEL (dBuV)	LIMIT (dBuV/m)	MARGIN (dB)	ANTENNA FACTOR (dB/m)	CABLE LOSS (dB)	PREAMP FACTOR (dB)	ANTENNA HEIGHT (cm)	TABLE ANGLE (Degree)	REMARK
5142	45.25	36.99	54	-8.75	34.12	8.13	33.99	202	0	Average
5142	59.8	51.54	74	-14.2	34.12	8.13	33.99	202	0	Peak
5180	101.31	93			34.15	8.16	34	202	0	Average
5180	108.07	99.76			34.15	8.16	34	202	0	Peak
5442	46.12	37.33	54	-7.88	34.35	8.48	34.04	202	0	Average
5442	60.32	51.53	74	-13.68	34.35	8.48	34.04	202	0	Peak

REMARKS:

- Emission Level = Read Level + Antenna Factor + Cable Loss - Preamp Factor
Margin value = Emission level – Limit value
- 5180 MHz: Fundamental frequency.



A D T

EUT TEST CONDITION		MEASUREMENT DETAIL	
CHANNEL	Channel 44	FREQUENCY RANGE	1 GHz ~ 40 GHz
INPUT POWER	120 Vac, 60 Hz	DETECTOR FUNCTION	Peak (PK) Average (AV)
ENVIRONMENTAL CONDITIONS	25 deg. C, 65 % RH	TESTED BY	Karl Lee

ANTENNA POLARITY & TEST DISTANCE: HORIZONTAL AT 3 M

FREQ. (MHz)	EMISSION LEVEL (dBuV/m)	READ LEVEL (dBuV)	LIMIT (dBuV/m)	MARGIN (dB)	ANTENNA FACTOR (dB/m)	CABLE LOSS (dB)	PREAMP FACTOR (dB)	ANTENNA HEIGHT (cm)	TABLE ANGLE (Degree)	REMARK
5142	50.35	42.09	54	-3.65	34.12	8.13	33.99	107	122	Average
5142	60.32	52.06	74	-13.68	34.12	8.13	33.99	107	122	Peak
5220	106.1	97.71			34.17	8.22	34	107	136	Average
5220	113.81	105.42			34.17	8.22	34	107	136	Peak
5460	51.41	42.59	54	-2.59	34.36	8.51	34.05	101	129	Average
5460	61.94	53.12	74	-12.06	34.36	8.51	34.05	101	129	Peak

ANTENNA POLARITY & TEST DISTANCE: VERTICAL AT 3 M

FREQ. (MHz)	EMISSION LEVEL (dBuV/m)	READ LEVEL (dBuV)	LIMIT (dBuV/m)	MARGIN (dB)	ANTENNA FACTOR (dB/m)	CABLE LOSS (dB)	PREAMP FACTOR (dB)	ANTENNA HEIGHT (cm)	TABLE ANGLE (Degree)	REMARK
5142	44.65	36.39	54	-9.35	34.12	8.13	33.99	113	360	Average
5142	59.19	50.93	74	-14.81	34.12	8.13	33.99	113	360	Peak
5220	100.4	92.01			34.17	8.22	34	113	360	Average
5220	108.28	99.89			34.17	8.22	34	113	360	Peak
5438	46.12	37.33	54	-7.88	34.35	8.48	34.04	113	360	Average
5438	60.83	52.04	74	-13.17	34.35	8.48	34.04	113	360	Peak

REMARKS:

- Emission Level = Read Level + Antenna Factor + Cable Loss - Preamp Factor
Margin value = Emission level – Limit value
- 5220 MHz: Fundamental frequency.



EUT TEST CONDITION		MEASUREMENT DETAIL	
CHANNEL	Channel 48	FREQUENCY RANGE	1 GHz ~ 40 GHz
INPUT POWER	120 Vac, 60 Hz	DETECTOR FUNCTION	Peak (PK) Average (AV)
ENVIRONMENTAL CONDITIONS	25 deg. C, 65 % RH	TESTED BY	Karl Lee

ANTENNA POLARITY & TEST DISTANCE: HORIZONTAL AT 3 M										
FREQ. (MHz)	EMISSION LEVEL (dBuV/m)	READ LEVEL (dBuV)	LIMIT (dBuV/m)	MARGIN (dB)	ANTENNA FACTOR (dB/m)	CABLE LOSS (dB)	PREAMP FACTOR (dB)	ANTENNA HEIGHT (cm)	TABLE ANGLE (Degree)	REMARK
5146	50.4	42.15	54	-3.6	34.12	8.13	34	100	120	Average
5146	60.69	52.44	74	-13.31	34.12	8.13	34	100	120	Peak
5240	105.24	96.8			34.19	8.26	34.01	107	136	Average
5240	113.41	104.97			34.19	8.26	34.01	107	136	Peak
5450	51.41	42.59	54	-2.59	34.36	8.51	34.05	102	107	Average
5450	62.13	53.31	74	-11.87	34.36	8.51	34.05	102	107	Peak

ANTENNA POLARITY & TEST DISTANCE: VERTICAL AT 3 M										
FREQ. (MHz)	EMISSION LEVEL (dBuV/m)	READ LEVEL (dBuV)	LIMIT (dBuV/m)	MARGIN (dB)	ANTENNA FACTOR (dB/m)	CABLE LOSS (dB)	PREAMP FACTOR (dB)	ANTENNA HEIGHT (cm)	TABLE ANGLE (Degree)	REMARK
5046	44.44	36.38	54	-9.56	34.04	8	33.98	105	360	Average
5046	59.44	51.38	74	-14.56	34.04	8	33.98	105	360	Peak
5240	100.54	92.1			34.19	8.26	34.01	105	360	Average
5240	108.46	100.02			34.19	8.26	34.01	105	360	Peak
5440	45.22	36.43	54	-8.78	34.35	8.48	34.04	105	360	Average
5440	59.73	50.94	74	-14.27	34.35	8.48	34.04	105	360	Peak

REMARKS:

- Emission Level = Read Level + Antenna Factor + Cable Loss - Preamp Factor
Margin value = Emission level – Limit value
- 5240 MHz: Fundamental frequency.



EUT TEST CONDITION		MEASUREMENT DETAIL	
CHANNEL	Channel 149	FREQUENCY RANGE	1 GHz ~ 40 GHz
INPUT POWER	120 Vac, 60 Hz	DETECTOR FUNCTION	Peak (PK) Average (AV)
ENVIRONMENTAL CONDITIONS	25 deg. C, 65 % RH	TESTED BY	Karl Lee

ANTENNA POLARITY & TEST DISTANCE: HORIZONTAL AT 3 M										
FREQ. (MHz)	EMISSION LEVEL (dBuV/m)	READ LEVEL (dBuV)	LIMIT (dBuV/m)	MARGIN (dB)	ANTENNA FACTOR (dB/m)	CABLE LOSS (dB)	PREAMP FACTOR (dB)	ANTENNA HEIGHT (cm)	TABLE ANGLE (Degree)	REMARK
*5706	63.13	53.98	68.2	-5.07	34.61	8.65	34.11	106	289	Peak
*5724	77.13	67.97	78.2	-1.07	34.62	8.65	34.11	218	322	Peak
5745	105.06	95.87			34.64	8.66	34.11	218	322	Average
5745	112.44	103.25			34.64	8.66	34.11	218	322	Peak
*5852	59.47	50.17	78.2	-18.73	34.74	8.7	34.14	218	322	Peak
*5868	59.73	50.4	68.2	-8.47	34.76	8.71	34.14	218	322	Peak
11490	51.82	36.7	54	-2.18	37.89	12.62	35.39	100	352	Average
11490	61.75	46.63	74	-12.25	37.89	12.62	35.39	100	352	Peak

ANTENNA POLARITY & TEST DISTANCE: VERTICAL AT 3 M										
FREQ. (MHz)	EMISSION LEVEL (dBuV/m)	READ LEVEL (dBuV)	LIMIT (dBuV/m)	MARGIN (dB)	ANTENNA FACTOR (dB/m)	CABLE LOSS (dB)	PREAMP FACTOR (dB)	ANTENNA HEIGHT (cm)	TABLE ANGLE (Degree)	REMARK
*5712	59.42	50.27	68.2	-8.78	34.61	8.65	34.11	238	0	Peak
*5724	66.31	57.15	78.2	-11.89	34.62	8.65	34.11	238	0	Peak
5745	102.71	93.52			34.64	8.66	34.11	238	0	Average
5745	109.95	100.76			34.64	8.66	34.11	238	0	Peak
*5856	57.18	47.86	78.2	-21.02	34.76	8.7	34.14	238	0	Peak
*5864	57.49	48.16	68.2	-10.71	34.76	8.71	34.14	238	0	Peak
11490	51.56	36.44	54	-2.44	37.89	12.62	35.39	111	53	Average
11490	60.95	45.83	74	-13.05	37.89	12.62	35.39	111	53	Peak

REMARKS:

- Emission Level = Read Level + Antenna Factor + Cable Loss - Preamp Factor
Margin value = Emission level – Limit value
- 5745 MHz: Fundamental frequency.
- *: Out of restricted band



A D T

EUT TEST CONDITION		MEASUREMENT DETAIL	
CHANNEL	Channel 157	FREQUENCY RANGE	1 GHz ~ 40 GHz
INPUT POWER	120 Vac, 60 Hz	DETECTOR FUNCTION	Peak (PK) Average (AV)
ENVIRONMENTAL CONDITIONS	25 deg. C, 65 % RH	TESTED BY	Karl Lee

ANTENNA POLARITY & TEST DISTANCE: HORIZONTAL AT 3 M

FREQ. (MHz)	EMISSION LEVEL (dBuV/m)	READ LEVEL (dBuV)	LIMIT (dBuV/m)	MARGIN (dB)	ANTENNA FACTOR (dB/m)	CABLE LOSS (dB)	PREAMP FACTOR (dB)	ANTENNA HEIGHT (cm)	TABLE ANGLE (Degree)	REMARK
*5708	59.2	50.05	68.2	-9	34.61	8.65	34.11	109	271	Peak
*5724	58.58	49.42	78.2	-19.62	34.62	8.65	34.11	109	271	Peak
5785	105.38	96.15			34.68	8.68	34.13	109	271	Average
5785	112.13	102.9			34.68	8.68	34.13	109	271	Peak
*5856	59.05	49.73	78.2	-19.15	34.76	8.7	34.14	109	271	Peak
*5862	58.67	49.34	68.2	-9.53	34.76	8.71	34.14	109	271	Peak
11570	51.8	36.49	54	-2.2	38	12.68	35.37	100	352	Average
11570	61.58	46.27	74	-12.42	38	12.68	35.37	100	352	Peak

ANTENNA POLARITY & TEST DISTANCE: VERTICAL AT 3 M

FREQ. (MHz)	EMISSION LEVEL (dBuV/m)	READ LEVEL (dBuV)	LIMIT (dBuV/m)	MARGIN (dB)	ANTENNA FACTOR (dB/m)	CABLE LOSS (dB)	PREAMP FACTOR (dB)	ANTENNA HEIGHT (cm)	TABLE ANGLE (Degree)	REMARK
*5710	57.4	48.25	68.2	-10.8	34.61	8.65	34.11	246	360	Peak
*5720	57.84	48.68	78.2	-20.36	34.62	8.65	34.11	246	360	Peak
5785	102.25	93.02			34.68	8.68	34.13	246	360	Average
5785	109.89	100.66			34.68	8.68	34.13	246	360	Peak
*5852	57.86	48.56	78.2	-20.34	34.74	8.7	34.14	246	360	Peak
*5864	57.7	48.37	68.2	-10.5	34.76	8.71	34.14	246	360	Peak
11570	51.3	35.99	54	-2.7	38	12.68	35.37	104	29	Average
11570	60.76	45.45	74	-13.24	38	12.68	35.37	104	29	Peak

REMARKS:

- Emission Level = Read Level + Antenna Factor + Cable Loss - Preamp Factor
Margin value = Emission level – Limit value
- 5785 MHz: Fundamental frequency.
- *: Out of restricted band



EUT TEST CONDITION		MEASUREMENT DETAIL	
CHANNEL	Channel 161	FREQUENCY RANGE	1 GHz ~ 40 GHz
INPUT POWER	120 Vac, 60 Hz	DETECTOR FUNCTION	Peak (PK) Average (AV)
ENVIRONMENTAL CONDITIONS	25 deg. C, 65 % RH	TESTED BY	Karl Lee

ANTENNA POLARITY & TEST DISTANCE: HORIZONTAL AT 3 M										
FREQ. (MHz)	EMISSION LEVEL (dBuV/m)	READ LEVEL (dBuV)	LIMIT (dBuV/m)	MARGIN (dB)	ANTENNA FACTOR (dB/m)	CABLE LOSS (dB)	PREAMP FACTOR (dB)	ANTENNA HEIGHT (cm)	TABLE ANGLE (Degree)	REMARK
*5714	60.06	50.91	68.2	-8.14	34.61	8.65	34.11	109	271	Peak
*5720	59.09	49.93	78.2	-19.11	34.62	8.65	34.11	109	271	Peak
5805	104.97	95.71			34.71	8.68	34.13	109	271	Average
5805	111.63	102.37			34.71	8.68	34.13	109	271	Peak
*5854	59.15	49.83	78.2	-19.05	34.76	8.7	34.14	109	271	Peak
*5861	58.44	49.11	68.2	-9.76	34.76	8.71	34.14	109	271	Peak
11610	51.34	35.91	54	-2.66	38.04	12.76	35.37	100	350	Average
11610	60.82	45.39	74	-13.18	38.04	12.76	35.37	100	350	Peak

ANTENNA POLARITY & TEST DISTANCE: VERTICAL AT 3 M										
FREQ. (MHz)	EMISSION LEVEL (dBuV/m)	READ LEVEL (dBuV)	LIMIT (dBuV/m)	MARGIN (dB)	ANTENNA FACTOR (dB/m)	CABLE LOSS (dB)	PREAMP FACTOR (dB)	ANTENNA HEIGHT (cm)	TABLE ANGLE (Degree)	REMARK
*5708	58.51	49.36	68.2	-9.69	34.61	8.65	34.11	246	360	Peak
*5716	57.64	48.49	78.2	-20.56	34.61	8.65	34.11	246	360	Peak
5805	101.58	92.32			34.71	8.68	34.13	246	360	Average
5805	108.06	98.8			34.71	8.68	34.13	246	360	Peak
*5858	58.58	49.26	78.2	-19.62	34.76	8.7	34.14	246	360	Peak
*5862	57.96	48.63	68.2	-10.24	34.76	8.71	34.14	246	360	Peak
11610	50.69	35.26	54	-3.31	38.04	12.76	35.37	101	312	Average
11610	60.25	44.82	74	-13.75	38.04	12.76	35.37	101	312	Peak

REMARKS:

- Emission Level = Read Level + Antenna Factor + Cable Loss - Preamp Factor
Margin value = Emission level – Limit value
- 5805 MHz: Fundamental frequency.
- *: Out of restricted band

802.11n (HT20)

EUT TEST CONDITION		MEASUREMENT DETAIL	
CHANNEL	Channel 36	FREQUENCY RANGE	1 GHz ~ 40 GHz
INPUT POWER	120 Vac, 60 Hz	DETECTOR FUNCTION	Peak (PK) Average (AV)
ENVIRONMENTAL CONDITIONS	25 deg. C, 65 % RH	TESTED BY	Karl Lee

ANTENNA POLARITY & TEST DISTANCE: HORIZONTAL AT 3 M

FREQ. (MHz)	EMISSION LEVEL (dBuV/m)	READ LEVEL (dBuV)	LIMIT (dBuV/m)	MARGIN (dB)	ANTENNA FACTOR (dB/m)	CABLE LOSS (dB)	PREAMP FACTOR (dB)	ANTENNA HEIGHT (cm)	TABLE ANGLE (Degree)	REMARK
5146	51.75	43.5	54	-2.25	34.12	8.13	34	100	120	Average
5146	62.23	53.98	74	-11.77	34.12	8.13	34	100	120	Peak
5180	105.01	96.7			34.15	8.16	34	107	136	Average
5180	111.23	102.92			34.15	8.16	34	107	136	Peak
5448	50.61	41.78	54	-3.39	34.36	8.51	34.04	102	113	Average
5448	62.02	53.19	74	-11.98	34.36	8.51	34.04	102	113	Peak

ANTENNA POLARITY & TEST DISTANCE: VERTICAL AT 3 M

FREQ. (MHz)	EMISSION LEVEL (dBuV/m)	READ LEVEL (dBuV)	LIMIT (dBuV/m)	MARGIN (dB)	ANTENNA FACTOR (dB/m)	CABLE LOSS (dB)	PREAMP FACTOR (dB)	ANTENNA HEIGHT (cm)	TABLE ANGLE (Degree)	REMARK
5126	45.6	37.38	54	-8.4	34.11	8.1	33.99	202	0	Average
5126	59.48	51.26	74	-14.52	34.11	8.1	33.99	202	0	Peak
5180	100.31	92			34.15	8.16	34	202	0	Average
5180	106.97	98.66			34.15	8.16	34	202	0	Peak
5388	45.72	37.04	54	-8.28	34.31	8.41	34.04	202	0	Average
5388	60.36	51.68	74	-13.64	34.31	8.41	34.04	202	0	Peak

REMARKS:

- Emission Level = Read Level + Antenna Factor + Cable Loss - Preamp Factor
Margin value = Emission level – Limit value
- 5180 MHz: Fundamental frequency.



EUT TEST CONDITION		MEASUREMENT DETAIL	
CHANNEL	Channel 44	FREQUENCY RANGE	1 GHz ~ 40 GHz
INPUT POWER	120 Vac, 60 Hz	DETECTOR FUNCTION	Peak (PK) Average (AV)
ENVIRONMENTAL CONDITIONS	25 deg. C, 65 % RH	TESTED BY	Karl Lee

ANTENNA POLARITY & TEST DISTANCE: HORIZONTAL AT 3 M										
FREQ. (MHz)	EMISSION LEVEL (dBuV/m)	READ LEVEL (dBuV)	LIMIT (dBuV/m)	MARGIN (dB)	ANTENNA FACTOR (dB/m)	CABLE LOSS (dB)	PREAMP FACTOR (dB)	ANTENNA HEIGHT (cm)	TABLE ANGLE (Degree)	REMARK
5140	50.8	42.54	54	-3.2	34.12	8.13	33.99	108	146	Average
5140	60.65	52.39	74	-13.35	34.12	8.13	33.99	108	146	Peak
5220	105.85	97.46			34.17	8.22	34	107	136	Average
5220	111.86	103.47			34.17	8.22	34	107	136	Peak
5444	50.96	42.17	54	-3.04	34.35	8.48	34.04	100	103	Average
5444	61.92	53.13	74	-12.08	34.35	8.48	34.04	100	103	Peak
ANTENNA POLARITY & TEST DISTANCE: VERTICAL AT 3 M										
FREQ. (MHz)	EMISSION LEVEL (dBuV/m)	READ LEVEL (dBuV)	LIMIT (dBuV/m)	MARGIN (dB)	ANTENNA FACTOR (dB/m)	CABLE LOSS (dB)	PREAMP FACTOR (dB)	ANTENNA HEIGHT (cm)	TABLE ANGLE (Degree)	REMARK
5130	44.7	36.48	54	-9.3	34.11	8.1	33.99	113	0	Average
5130	59.98	51.76	74	-14.02	34.11	8.1	33.99	113	0	Peak
5220	100.7	92.31			34.17	8.22	34	113	0	Average
5220	107.33	98.94			34.17	8.22	34	113	0	Peak
5432	45.59	36.8	54	-8.41	34.35	8.48	34.04	113	0	Average
5432	60.64	51.85	74	-13.36	34.35	8.48	34.04	113	0	Peak

REMARKS:

- Emission Level = Read Level + Antenna Factor + Cable Loss - Preamp Factor
Margin value = Emission level – Limit value
- 5220 MHz: Fundamental frequency.



A D T

EUT TEST CONDITION		MEASUREMENT DETAIL	
CHANNEL	Channel 48	FREQUENCY RANGE	1 GHz ~ 40 GHz
INPUT POWER	120 Vac, 60 Hz	DETECTOR FUNCTION	Peak (PK) Average (AV)
ENVIRONMENTAL CONDITIONS	25 deg. C, 65 % RH	TESTED BY	Karl Lee

ANTENNA POLARITY & TEST DISTANCE: HORIZONTAL AT 3 M										
FREQ. (MHz)	EMISSION LEVEL (dBuV/m)	READ LEVEL (dBuV)	LIMIT (dBuV/m)	MARGIN (dB)	ANTENNA FACTOR (dB/m)	CABLE LOSS (dB)	PREAMP FACTOR (dB)	ANTENNA HEIGHT (cm)	TABLE ANGLE (Degree)	REMARK
5140	50.3	42.04	54	-3.7	34.12	8.13	33.99	100	117	Average
5140	60.18	51.92	74	-13.82	34.12	8.13	33.99	100	117	Peak
5240	104.84	96.4			34.19	8.26	34.01	107	136	Average
5240	111.12	102.68			34.19	8.26	34.01	107	136	Peak
5424	51.19	42.42	54	-2.81	34.33	8.48	34.04	117	133	Average
5424	62.26	53.49	74	-11.74	34.33	8.48	34.04	117	133	Peak
ANTENNA POLARITY & TEST DISTANCE: VERTICAL AT 3 M										
FREQ. (MHz)	EMISSION LEVEL (dBuV/m)	READ LEVEL (dBuV)	LIMIT (dBuV/m)	MARGIN (dB)	ANTENNA FACTOR (dB/m)	CABLE LOSS (dB)	PREAMP FACTOR (dB)	ANTENNA HEIGHT (cm)	TABLE ANGLE (Degree)	REMARK
5088	44.73	36.57	54	-9.27	34.07	8.07	33.98	105	0	Average
5088	59.44	51.28	74	-14.56	34.07	8.07	33.98	105	0	Peak
5240	99.84	91.4			34.19	8.26	34.01	105	0	Average
5240	106.86	98.42			34.19	8.26	34.01	105	0	Peak
5442	45.62	36.83	54	-8.38	34.35	8.48	34.04	105	0	Average
5442	59.7	50.91	74	-14.3	34.35	8.48	34.04	105	0	Peak

REMARKS:

- Emission Level = Read Level + Antenna Factor + Cable Loss - Preamp Factor
Margin value = Emission level – Limit value
- 5240 MHz: Fundamental frequency.



A D T

EUT TEST CONDITION		MEASUREMENT DETAIL	
CHANNEL	Channel 149	FREQUENCY RANGE	1 GHz ~ 40 GHz
INPUT POWER	120 Vac, 60 Hz	DETECTOR FUNCTION	Peak (PK) Average (AV)
ENVIRONMENTAL CONDITIONS	25 deg. C, 65 % RH	TESTED BY	Karl Lee

ANTENNA POLARITY & TEST DISTANCE: HORIZONTAL AT 3 M										
FREQ. (MHz)	EMISSION LEVEL (dBuV/m)	READ LEVEL (dBuV)	LIMIT (dBuV/m)	MARGIN (dB)	ANTENNA FACTOR (dB/m)	CABLE LOSS (dB)	PREAMP FACTOR (dB)	ANTENNA HEIGHT (cm)	TABLE ANGLE (Degree)	REMARK
*5714	61.34	52.19	68.2	-6.86	34.61	8.65	34.11	234	323	Peak
*5724	75.08	65.92	78.2	-3.12	34.62	8.65	34.11	234	323	Peak
5745	102.69	93.5			34.64	8.66	34.11	234	323	Average
5745	109.67	100.48			34.64	8.66	34.11	234	323	Peak
*5858	59.25	49.93	78.2	-18.95	34.76	8.7	34.14	234	323	Peak
*5868	58.86	49.53	68.2	-9.34	34.76	8.71	34.14	234	323	Peak
11490	51.92	36.8	54	-2.08	37.89	12.62	35.39	100	352	Average
11490	61.51	46.39	74	-12.49	37.89	12.62	35.39	100	352	Peak

ANTENNA POLARITY & TEST DISTANCE: VERTICAL AT 3 M										
FREQ. (MHz)	EMISSION LEVEL (dBuV/m)	READ LEVEL (dBuV)	LIMIT (dBuV/m)	MARGIN (dB)	ANTENNA FACTOR (dB/m)	CABLE LOSS (dB)	PREAMP FACTOR (dB)	ANTENNA HEIGHT (cm)	TABLE ANGLE (Degree)	REMARK
*5714	58.6	49.45	68.2	-9.6	34.61	8.65	34.11	259	360	Peak
*5724	71.81	62.65	78.2	-6.39	34.62	8.65	34.11	259	360	Peak
5745	99.37	90.18			34.64	8.66	34.11	259	360	Average
5745	106.82	97.63			34.64	8.66	34.11	259	360	Peak
*5852	58.01	48.71	78.2	-20.19	34.74	8.7	34.14	259	360	Peak
*5866	57.81	48.48	68.2	-10.39	34.76	8.71	34.14	259	360	Peak
11490	51.64	36.52	54	-2.36	37.89	12.62	35.39	111	53	Average
11490	60.81	45.69	74	-13.19	37.89	12.62	35.39	111	53	Peak

REMARKS:

- Emission Level = Read Level + Antenna Factor + Cable Loss - Preamp Factor
Margin value = Emission level – Limit value
- 5745 MHz: Fundamental frequency.
- *: Out of restricted band



EUT TEST CONDITION		MEASUREMENT DETAIL	
CHANNEL	Channel 157	FREQUENCY RANGE	1 GHz ~ 40 GHz
INPUT POWER	120 Vac, 60 Hz	DETECTOR FUNCTION	Peak (PK) Average (AV)
ENVIRONMENTAL CONDITIONS	25 deg. C, 65 % RH	TESTED BY	Karl Lee

ANTENNA POLARITY & TEST DISTANCE: HORIZONTAL AT 3 M										
FREQ. (MHz)	EMISSION LEVEL (dBuV/m)	READ LEVEL (dBuV)	LIMIT (dBuV/m)	MARGIN (dB)	ANTENNA FACTOR (dB/m)	CABLE LOSS (dB)	PREAMP FACTOR (dB)	ANTENNA HEIGHT (cm)	TABLE ANGLE (Degree)	REMARK
*5708	59.83	50.68	68.2	-8.37	34.61	8.65	34.11	109	271	Peak
*5718	59.25	50.09	78.2	-18.95	34.62	8.65	34.11	109	271	Peak
5785	104.06	94.83			34.68	8.68	34.13	109	271	Average
5785	111.51	102.28			34.68	8.68	34.13	109	271	Peak
*5856	59.23	49.91	78.2	-18.97	34.76	8.7	34.14	109	271	Peak
*5870	59.61	50.28	68.2	-8.59	34.76	8.71	34.14	109	271	Peak
11570	52.3	36.99	54	-1.7	38	12.68	35.37	100	352	Average
11570	62.83	47.52	74	-11.17	38	12.68	35.37	100	352	Peak

ANTENNA POLARITY & TEST DISTANCE: VERTICAL AT 3 M										
FREQ. (MHz)	EMISSION LEVEL (dBuV/m)	READ LEVEL (dBuV)	LIMIT (dBuV/m)	MARGIN (dB)	ANTENNA FACTOR (dB/m)	CABLE LOSS (dB)	PREAMP FACTOR (dB)	ANTENNA HEIGHT (cm)	TABLE ANGLE (Degree)	REMARK
*5710	57.8	48.65	68.2	-10.4	34.61	8.65	34.11	246	360	Peak
*5718	56.96	47.8	78.2	-21.24	34.62	8.65	34.11	246	360	Peak
5785	100.61	91.38			34.68	8.68	34.13	246	360	Average
5785	108.75	99.52			34.68	8.68	34.13	246	360	Peak
*5860	56.89	47.57	78.2	-21.31	34.76	8.7	34.14	246	360	Peak
*5870	56.91	47.58	68.2	-11.29	34.76	8.71	34.14	246	360	Peak
11570	51.44	36.13	54	-2.56	38	12.68	35.37	104	36	Average
11570	60.49	45.18	74	-13.51	38	12.68	35.37	104	36	Peak

REMARKS:

- Emission Level = Read Level + Antenna Factor + Cable Loss - Preamp Factor
Margin value = Emission level – Limit value
- 5785 MHz: Fundamental frequency.
- *: Out of restricted band



EUT TEST CONDITION		MEASUREMENT DETAIL	
CHANNEL	Channel 161	FREQUENCY RANGE	1 GHz ~ 40 GHz
INPUT POWER	120 Vac, 60 Hz	DETECTOR FUNCTION	Peak (PK) Average (AV)
ENVIRONMENTAL CONDITIONS	25 deg. C, 65 % RH	TESTED BY	Karl Lee

ANTENNA POLARITY & TEST DISTANCE: HORIZONTAL AT 3 M										
FREQ. (MHz)	EMISSION LEVEL (dBuV/m)	READ LEVEL (dBuV)	LIMIT (dBuV/m)	MARGIN (dB)	ANTENNA FACTOR (dB/m)	CABLE LOSS (dB)	PREAMP FACTOR (dB)	ANTENNA HEIGHT (cm)	TABLE ANGLE (Degree)	REMARK
*5708	58.98	49.83	68.2	-9.22	34.61	8.65	34.11	110	271	Peak
*5716	59.88	50.73	78.2	-18.32	34.61	8.65	34.11	110	271	Peak
5805	104	94.74			34.71	8.68	34.13	110	271	Average
5805	111.7	102.44			34.71	8.68	34.13	110	271	Peak
*5852	58.72	49.42	78.2	-19.48	34.74	8.7	34.14	110	271	Peak
*5862	58.94	49.61	68.2	-9.26	34.76	8.71	34.14	110	271	Peak
11610	50.27	34.84	54	-3.73	38.04	12.76	35.37	100	350	Average
11610	59.61	44.18	74	-14.39	38.04	12.76	35.37	100	350	Peak

ANTENNA POLARITY & TEST DISTANCE: VERTICAL AT 3 M										
FREQ. (MHz)	EMISSION LEVEL (dBuV/m)	READ LEVEL (dBuV)	LIMIT (dBuV/m)	MARGIN (dB)	ANTENNA FACTOR (dB/m)	CABLE LOSS (dB)	PREAMP FACTOR (dB)	ANTENNA HEIGHT (cm)	TABLE ANGLE (Degree)	REMARK
*5710	57.83	48.68	68.2	-10.37	34.61	8.65	34.11	246	360	Peak
*5718	57.49	48.33	78.2	-20.71	34.62	8.65	34.11	246	360	Peak
5805	101.05	91.79			34.71	8.68	34.13	246	360	Average
5805	108.95	99.69			34.71	8.68	34.13	246	360	Peak
*5860	57.64	48.32	78.2	-20.56	34.76	8.7	34.14	246	360	Peak
*5866	58.61	49.28	68.2	-9.59	34.76	8.71	34.14	246	360	Peak
11610	49.94	34.51	54	-4.06	38.04	12.76	35.37	100	312	Average
11610	59.23	43.8	74	-14.77	38.04	12.76	35.37	100	312	Peak

REMARKS:

- Emission Level = Read Level + Antenna Factor + Cable Loss - Preamp Factor
Margin value = Emission level – Limit value
- 5805 MHz: Fundamental frequency.
- *: Out of restricted band

802.11n (HT40)

EUT TEST CONDITION		MEASUREMENT DETAIL	
CHANNEL	Channel 38	FREQUENCY RANGE	1 GHz ~ 40 GHz
INPUT POWER	120 Vac, 60 Hz	DETECTOR FUNCTION	Peak (PK) Average (AV)
ENVIRONMENTAL CONDITIONS	25 deg. C, 65 % RH	TESTED BY	Karl Lee

ANTENNA POLARITY & TEST DISTANCE: HORIZONTAL AT 3 M

FREQ. (MHz)	EMISSION LEVEL (dBuV/m)	READ LEVEL (dBuV)	LIMIT (dBuV/m)	MARGIN (dB)	ANTENNA FACTOR (dB/m)	CABLE LOSS (dB)	PREAMP FACTOR (dB)	ANTENNA HEIGHT (cm)	TABLE ANGLE (Degree)	REMARK
5148	53	44.75	54	-1	34.12	8.13	34	106	114	Average
5148	63.45	55.2	74	-10.55	34.12	8.13	34	106	114	Peak
5190	98.16	89.82			34.15	8.19	34	107	136	Average
5190	105.46	97.12			34.15	8.19	34	107	136	Peak
5394	45.95	37.24	54	-8.05	34.31	8.44	34.04	107	136	Average
5394	58.89	50.18	74	-15.11	34.31	8.44	34.04	107	136	Peak

ANTENNA POLARITY & TEST DISTANCE: VERTICAL AT 3 M

FREQ. (MHz)	EMISSION LEVEL (dBuV/m)	READ LEVEL (dBuV)	LIMIT (dBuV/m)	MARGIN (dB)	ANTENNA FACTOR (dB/m)	CABLE LOSS (dB)	PREAMP FACTOR (dB)	ANTENNA HEIGHT (cm)	TABLE ANGLE (Degree)	REMARK
5138	44.04	35.79	54	-9.96	34.11	8.13	33.99	113	0	Average
5138	58.44	50.19	74	-15.56	34.11	8.13	33.99	113	0	Peak
5190	93.34	85			34.15	8.19	34	113	0	Average
5190	100.74	92.4			34.15	8.19	34	113	0	Peak
5370	44.71	36.04	54	-9.29	34.29	8.41	34.03	113	0	Average
5370	58.7	50.03	74	-15.3	34.29	8.41	34.03	113	0	Peak

REMARKS:

- Emission Level = Read Level + Antenna Factor + Cable Loss - Preamp Factor
Margin value = Emission level – Limit value
- 5190 MHz: Fundamental frequency.



EUT TEST CONDITION		MEASUREMENT DETAIL	
CHANNEL	Channel 46	FREQUENCY RANGE	1 GHz ~ 40 GHz
INPUT POWER	120 Vac, 60 Hz	DETECTOR FUNCTION	Peak (PK) Average (AV)
ENVIRONMENTAL CONDITIONS	25 deg. C, 65 % RH	TESTED BY	Karl Lee

ANTENNA POLARITY & TEST DISTANCE: HORIZONTAL AT 3 M										
FREQ. (MHz)	EMISSION LEVEL (dBuV/m)	READ LEVEL (dBuV)	LIMIT (dBuV/m)	MARGIN (dB)	ANTENNA FACTOR (dB/m)	CABLE LOSS (dB)	PREAMP FACTOR (dB)	ANTENNA HEIGHT (cm)	TABLE ANGLE (Degree)	REMARK
5130	47.85	39.63	54	-6.15	34.11	8.1	33.99	114	118	Average
5130	57.98	49.76	74	-16.02	34.11	8.1	33.99	114	118	Peak
5230	101.81	93.41			34.19	8.22	34.01	107	118	Average
5230	108.98	100.58			34.19	8.22	34.01	107	118	Peak
5390	48.81	40.13	54	-5.19	34.31	8.41	34.04	104	116	Average
5390	58.94	50.26	74	-15.06	34.31	8.41	34.04	104	116	Peak
ANTENNA POLARITY & TEST DISTANCE: VERTICAL AT 3 M										
FREQ. (MHz)	EMISSION LEVEL (dBuV/m)	READ LEVEL (dBuV)	LIMIT (dBuV/m)	MARGIN (dB)	ANTENNA FACTOR (dB/m)	CABLE LOSS (dB)	PREAMP FACTOR (dB)	ANTENNA HEIGHT (cm)	TABLE ANGLE (Degree)	REMARK
5126	44.2	35.98	54	-9.8	34.11	8.1	33.99	113	0	Average
5126	59.75	51.53	74	-14.25	34.11	8.1	33.99	113	0	Peak
5230	96.21	87.81			34.19	8.22	34.01	113	0	Average
5230	103.9	95.5			34.19	8.22	34.01	113	0	Peak
5428	45.01	36.24	54	-8.99	34.33	8.48	34.04	113	0	Average
5428	60.09	51.32	74	-13.91	34.33	8.48	34.04	113	0	Peak

REMARKS:

- Emission Level = Read Level + Antenna Factor + Cable Loss - Preamp Factor
Margin value = Emission level – Limit value
- 5230 MHz: Fundamental frequency.

EUT TEST CONDITION		MEASUREMENT DETAIL	
CHANNEL	Channel 151	FREQUENCY RANGE	1 GHz ~ 40 GHz
INPUT POWER	120 Vac, 60 Hz	DETECTOR FUNCTION	Peak (PK) Average (AV)
ENVIRONMENTAL CONDITIONS	25 deg. C, 65 % RH	TESTED BY	Karl Lee

ANTENNA POLARITY & TEST DISTANCE: HORIZONTAL AT 3 M										
FREQ. (MHz)	EMISSION LEVEL (dBuV/m)	READ LEVEL (dBuV)	LIMIT (dBuV/m)	MARGIN (dB)	ANTENNA FACTOR (dB/m)	CABLE LOSS (dB)	PREAMP FACTOR (dB)	ANTENNA HEIGHT (cm)	TABLE ANGLE (Degree)	REMARK
*5714	67.11	57.96	68.2	-1.09	34.61	8.65	34.11	107	318	Peak
*5724	70.85	61.69	78.2	-7.35	34.62	8.65	34.11	107	318	Peak
5755	100.16	90.95			34.66	8.66	34.11	107	318	Average
5755	108.14	98.93			34.66	8.66	34.11	107	318	Peak
*5860	57.41	48.09	78.2	-20.79	34.76	8.7	34.14	107	318	Peak
*5864	56.86	47.53	68.2	-11.34	34.76	8.71	34.14	107	318	Peak
ANTENNA POLARITY & TEST DISTANCE: VERTICAL AT 3 M										
FREQ. (MHz)	EMISSION LEVEL (dBuV/m)	READ LEVEL (dBuV)	LIMIT (dBuV/m)	MARGIN (dB)	ANTENNA FACTOR (dB/m)	CABLE LOSS (dB)	PREAMP FACTOR (dB)	ANTENNA HEIGHT (cm)	TABLE ANGLE (Degree)	REMARK
*5714	61.78	52.63	68.2	-6.42	34.61	8.65	34.11	238	0	Peak
*5720	66.66	57.5	78.2	-11.54	34.62	8.65	34.11	238	0	Peak
5755	97.89	88.68			34.66	8.66	34.11	238	0	Average
5755	105.36	96.15			34.66	8.66	34.11	238	0	Peak
*5854	58.74	49.42	78.2	-19.46	34.76	8.7	34.14	238	0	Peak
*5862	56.62	47.29	68.2	-11.58	34.76	8.71	34.14	238	0	Peak

REMARKS:

- Emission Level = Read Level + Antenna Factor + Cable Loss - Preamp Factor
Margin value = Emission level – Limit value
- 5755 MHz: Fundamental frequency.
- *: Out of restricted band

EUT TEST CONDITION		MEASUREMENT DETAIL	
CHANNEL	Channel 159	FREQUENCY RANGE	1 GHz ~ 40 GHz
INPUT POWER	120 Vac, 60 Hz	DETECTOR FUNCTION	Peak (PK) Average (AV)
ENVIRONMENTAL CONDITIONS	25 deg. C, 65 % RH	TESTED BY	Karl Lee

ANTENNA POLARITY & TEST DISTANCE: HORIZONTAL AT 3 M										
FREQ. (MHz)	EMISSION LEVEL (dBuV/m)	READ LEVEL (dBuV)	LIMIT (dBuV/m)	MARGIN (dB)	ANTENNA FACTOR (dB/m)	CABLE LOSS (dB)	PREAMP FACTOR (dB)	ANTENNA HEIGHT (cm)	TABLE ANGLE (Degree)	REMARK
*5714	57.73	48.58	68.2	-10.47	34.61	8.65	34.11	110	271	Peak
*5716	57.24	48.09	78.2	-20.96	34.61	8.65	34.11	110	271	Peak
5795	101.19	91.95			34.69	8.68	34.13	110	271	Average
5795	108.9	99.66			34.69	8.68	34.13	110	271	Peak
*5854	59.1	49.78	78.2	-19.1	34.76	8.7	34.14	110	271	Peak
*5868	57.88	48.55	68.2	-10.32	34.76	8.71	34.14	110	271	Peak
ANTENNA POLARITY & TEST DISTANCE: VERTICAL AT 3 M										
FREQ. (MHz)	EMISSION LEVEL (dBuV/m)	READ LEVEL (dBuV)	LIMIT (dBuV/m)	MARGIN (dB)	ANTENNA FACTOR (dB/m)	CABLE LOSS (dB)	PREAMP FACTOR (dB)	ANTENNA HEIGHT (cm)	TABLE ANGLE (Degree)	REMARK
*5714	57.31	48.16	68.2	-10.89	34.61	8.65	34.11	246	360	Peak
*5724	57.57	48.41	78.2	-20.63	34.62	8.65	34.11	246	360	Peak
5795	98.66	89.42			34.69	8.68	34.13	246	360	Average
5795	105.69	96.45			34.69	8.68	34.13	246	360	Peak
*5854	58.67	49.35	78.2	-19.53	34.76	8.7	34.14	246	360	Peak
*5868	57.71	48.38	68.2	-10.49	34.76	8.71	34.14	246	360	Peak

REMARKS:

- Emission Level = Read Level + Antenna Factor + Cable Loss - Preamp Factor
Margin value = Emission level – Limit value
- 5795 MHz: Fundamental frequency.
- *: Out of restricted band

802.11ac (VHT80)

EUT TEST CONDITION		MEASUREMENT DETAIL	
CHANNEL	Channel 42	FREQUENCY RANGE	1 GHz ~ 40 GHz
INPUT POWER	120 Vac, 60 Hz	DETECTOR FUNCTION	Peak (PK) Average (AV)
ENVIRONMENTAL CONDITIONS	25 deg. C, 65 % RH	TESTED BY	Karl Lee

ANTENNA POLARITY & TEST DISTANCE: HORIZONTAL AT 3 M

FREQ. (MHz)	EMISSION LEVEL (dBuV/m)	READ LEVEL (dBuV)	LIMIT (dBuV/m)	MARGIN (dB)	ANTENNA FACTOR (dB/m)	CABLE LOSS (dB)	PREAMP FACTOR (dB)	ANTENNA HEIGHT (cm)	TABLE ANGLE (Degree)	REMARK
5140	52.95	44.69	54	-1.05	34.12	8.13	33.99	107	116	Average
5140	64.91	56.65	74	-9.09	34.12	8.13	33.99	107	116	Peak
5210	92.47	84.11			34.17	8.19	34	107	147	Average
5210	100.43	92.07			34.17	8.19	34	107	147	Peak
5438	44.32	35.53	54	-9.68	34.35	8.48	34.04	107	147	Average
5438	59.25	50.46	74	-14.75	34.35	8.48	34.04	107	147	Peak

ANTENNA POLARITY & TEST DISTANCE: VERTICAL AT 3 M

FREQ. (MHz)	EMISSION LEVEL (dBuV/m)	READ LEVEL (dBuV)	LIMIT (dBuV/m)	MARGIN (dB)	ANTENNA FACTOR (dB/m)	CABLE LOSS (dB)	PREAMP FACTOR (dB)	ANTENNA HEIGHT (cm)	TABLE ANGLE (Degree)	REMARK
5150	46.45	38.2	54	-7.55	34.12	8.13	34	202	0	Average
5150	59.3	51.05	74	-14.7	34.12	8.13	34	202	0	Peak
5210	88.47	80.11			34.17	8.19	34	202	0	Average
5210	95.1	86.74			34.17	8.19	34	202	0	Peak
5360	44.56	35.93	54	-9.44	34.28	8.38	34.03	202	0	Average
5360	59.71	51.08	74	-14.29	34.28	8.38	34.03	202	0	Peak

REMARKS:

- Emission Level = Read Level + Antenna Factor + Cable Loss - Preamp Factor
Margin value = Emission level – Limit value
- 5210 MHz: Fundamental frequency.



EUT TEST CONDITION		MEASUREMENT DETAIL	
CHANNEL	Channel 155	FREQUENCY RANGE	1 GHz ~ 40 GHz
INPUT POWER	120 Vac, 60 Hz	DETECTOR FUNCTION	Peak (PK) Average (AV)
ENVIRONMENTAL CONDITIONS	25 deg. C, 65 % RH	TESTED BY	Karl Lee

ANTENNA POLARITY & TEST DISTANCE: HORIZONTAL AT 3 M										
FREQ. (MHz)	EMISSION LEVEL (dBuV/m)	READ LEVEL (dBuV)	LIMIT (dBuV/m)	MARGIN (dB)	ANTENNA FACTOR (dB/m)	CABLE LOSS (dB)	PREAMP FACTOR (dB)	ANTENNA HEIGHT (cm)	TABLE ANGLE (Degree)	REMARK
*5714	67.19	58.04	68.2	-1.01	34.61	8.65	34.11	106	320	Peak
*5724	72.07	62.91	78.2	-6.13	34.62	8.65	34.11	106	320	Peak
5775	94.35	85.12			34.68	8.67	34.12	106	320	Average
5775	102.51	93.28			34.68	8.67	34.12	106	320	Peak
*5858	58.36	49.04	78.2	-19.84	34.76	8.7	34.14	106	320	Peak
*5864	58.74	49.41	68.2	-9.46	34.76	8.71	34.14	106	320	Peak
ANTENNA POLARITY & TEST DISTANCE: VERTICAL AT 3 M										
FREQ. (MHz)	EMISSION LEVEL (dBuV/m)	READ LEVEL (dBuV)	LIMIT (dBuV/m)	MARGIN (dB)	ANTENNA FACTOR (dB/m)	CABLE LOSS (dB)	PREAMP FACTOR (dB)	ANTENNA HEIGHT (cm)	TABLE ANGLE (Degree)	REMARK
*5714	60.66	51.51	68.2	-7.54	34.61	8.65	34.11	238	0	Peak
*5724	64.63	55.47	78.2	-13.57	34.62	8.65	34.11	238	0	Peak
5775	91.06	81.83			34.68	8.67	34.12	238	0	Average
5775	99.58	90.35			34.68	8.67	34.12	238	0	Peak
*5856	57.66	48.34	78.2	-20.54	34.76	8.7	34.14	238	0	Peak
*5862	56.53	47.2	68.2	-11.67	34.76	8.71	34.14	238	0	Peak

REMARKS:

- Emission Level = Read Level + Antenna Factor + Cable Loss - Preamp Factor
Margin value = Emission level – Limit value
- 5775 MHz: Fundamental frequency.
- *: Out of restricted band

9 kHz ~ 30 MHz DATA:

The amplitude of spurious emissions attenuated more than 20 dB below the permissible value is not required to be report.

30 MHz ~ 1 GHz WORST-CASE DATA:
Mode A
802.11ac (VHT80)

EUT TEST CONDITION		MEASUREMENT DETAIL	
CHANNEL	Channel 42	FREQUENCY RANGE	30 MHz ~ 1 GHz
INPUT POWER	120 Vac, 60 Hz	DETECTOR FUNCTION	Peak (PK)
ENVIRONMENTAL CONDITIONS	25 deg. C, 65 % RH	TESTED BY	Karl Lee

ANTENNA POLARITY & TEST DISTANCE: HORIZONTAL AT 3 M

FREQ. (MHz)	EMISSION LEVEL (dBuV/m)	READ LEVEL (dBuV)	LIMIT (dBuV/m)	MARGIN (dB)	ANTENNA FACTOR (dB/m)	CABLE LOSS (dB)	PREAMP FACTOR (dB)	ANTENNA HEIGHT (cm)	TABLE ANGLE (Degree)	REMARK
99.66	42	60.7	43.5	-1.5	12.28	1.28	32.26	105	127	Peak
199.56	42.67	62.24	43.5	-0.83	11.08	1.65	32.3	164	212	Peak
300	43.14	60.19	46	-2.86	13.06	2.03	32.14	145	128	Peak
622	39.19	50.28	46	-6.81	18.15	2.93	32.17	176	208	Peak
750.1	43.95	53.07	46	-2.05	19.81	3.22	32.15	164	212	Peak
874.7	43.83	50.69	46	-2.17	21.29	3.49	31.64	194	120	Peak

ANTENNA POLARITY & TEST DISTANCE: VERTICAL AT 3 M

FREQ. (MHz)	EMISSION LEVEL (dBuV/m)	READ LEVEL (dBuV)	LIMIT (dBuV/m)	MARGIN (dB)	ANTENNA FACTOR (dB/m)	CABLE LOSS (dB)	PREAMP FACTOR (dB)	ANTENNA HEIGHT (cm)	TABLE ANGLE (Degree)	REMARK
99.93	33.53	52.23	43.5	-9.97	12.28	1.28	32.26	132	146	Peak
199.29	32.21	51.78	43.5	-11.29	11.08	1.65	32.3	197	121	Peak
298.92	35.53	52.6	46	-10.47	13.04	2.03	32.14	136	320	Peak
499.5	31.16	44.28	46	-14.84	16.35	2.63	32.1	165	145	Peak
750.1	39.18	48.3	46	-6.82	19.81	3.22	32.15	132	214	Peak
871.2	37.9	44.87	46	-8.1	21.25	3.44	31.66	167	136	Peak

REMARKS: Emission Level = Read Level + Antenna Factor + Cable Loss - Preamp Factor

Margin value = Emission level – Limit value

802.11ac (VHT80)

EUT TEST CONDITION		MEASUREMENT DETAIL	
CHANNEL	Channel 155	FREQUENCY RANGE	30 MHz ~ 1 GHz
INPUT POWER	120 Vac, 60 Hz	DETECTOR FUNCTION	Peak (PK)
ENVIRONMENTAL CONDITIONS	25 deg. C, 65 % RH	TESTED BY	Karl Lee

ANTENNA POLARITY & TEST DISTANCE: HORIZONTAL AT 3 M

FREQ. (MHz)	EMISSION LEVEL (dBuV/m)	READ LEVEL (dBuV)	LIMIT (dBuV/m)	MARGIN (dB)	ANTENNA FACTOR (dB/m)	CABLE LOSS (dB)	PREAMP FACTOR (dB)	ANTENNA HEIGHT (cm)	TABLE ANGLE (Degree)	REMARK
99.93	39.34	58.04	43.5	-4.16	12.28	1.28	32.26	164	128	Peak
200.1	41.36	60.93	43.5	-2.14	11.08	1.65	32.3	164	230	Peak
300	44.26	61.31	46	-1.74	13.06	2.03	32.14	144	178	Peak
374.9	30.47	45.83	46	-15.53	14.53	2.26	32.15	168	312	Peak
624.8	39.31	50.38	46	-6.69	18.17	2.93	32.17	162	120	Peak
747.3	43.81	52.95	46	-2.19	19.78	3.22	32.14	174	166	Peak

ANTENNA POLARITY & TEST DISTANCE: VERTICAL AT 3 M

FREQ. (MHz)	EMISSION LEVEL (dBuV/m)	READ LEVEL (dBuV)	LIMIT (dBuV/m)	MARGIN (dB)	ANTENNA FACTOR (dB/m)	CABLE LOSS (dB)	PREAMP FACTOR (dB)	ANTENNA HEIGHT (cm)	TABLE ANGLE (Degree)	REMARK
99.93	33.4	52.1	43.5	-10.1	12.28	1.28	32.26	185	120	Peak
200.1	32.33	51.9	43.5	-11.17	11.08	1.65	32.3	197	212	Peak
289.74	26	43.24	46	-20	12.86	2.03	32.13	133	241	Peak
499.5	31.07	44.19	46	-14.93	16.35	2.63	32.1	146	284	Peak
750.1	38.98	48.1	46	-7.02	19.81	3.22	32.15	166	128	Peak
874.7	37.71	44.57	46	-8.29	21.29	3.49	31.64	169	111	Peak

REMARKS: Emission Level = Read Level + Antenna Factor + Cable Loss - Preamp Factor

Margin value = Emission level – Limit value

Mode B
802.11n (HT40)

EUT TEST CONDITION		MEASUREMENT DETAIL	
CHANNEL	Channel 38	FREQUENCY RANGE	30 MHz ~ 1 GHz
INPUT POWER	120 Vac, 60 Hz	DETECTOR FUNCTION	Peak (PK) Quasi-peak (QP)
ENVIRONMENTAL CONDITIONS	25 deg. C, 65 % RH	TESTED BY	Karl Lee

ANTENNA POLARITY & TEST DISTANCE: HORIZONTAL AT 3 M										
FREQ. (MHz)	EMISSION LEVEL (dBuV/m)	READ LEVEL (dBuV)	LIMIT (dBuV/m)	MARGIN (dB)	ANTENNA FACTOR (dB/m)	CABLE LOSS (dB)	PREAMP FACTOR (dB)	ANTENNA HEIGHT (cm)	TABLE ANGLE (Degree)	REMARK
99.66	32.49	51.19	43.5	-11.01	12.28	1.28	32.26	169	142	Peak
200.1	41.9	61.47	43.5	-1.6	11.08	1.65	32.3	166	135	Peak
298.92	44.4	61.47	46	-1.6	13.04	2.03	32.14	165	215	QP
497.4	39.74	52.89	46	-6.26	16.32	2.63	32.1	198	125	Peak
700.4	34.62	44.36	46	-11.38	19.24	3.11	32.09	163	175	Peak
896.4	32.76	39.34	46	-13.24	21.44	3.49	31.51	101	215	Peak
ANTENNA POLARITY & TEST DISTANCE: VERTICAL AT 3 M										
FREQ. (MHz)	EMISSION LEVEL (dBuV/m)	READ LEVEL (dBuV)	LIMIT (dBuV/m)	MARGIN (dB)	ANTENNA FACTOR (dB/m)	CABLE LOSS (dB)	PREAMP FACTOR (dB)	ANTENNA HEIGHT (cm)	TABLE ANGLE (Degree)	REMARK
99.66	22.75	41.45	43.5	-20.75	12.28	1.28	32.26	198	172	Peak
200.1	32.09	51.66	43.5	-11.41	11.08	1.65	32.3	114	175	Peak
298.92	44.91	61.98	46	-1.09	13.04	2.03	32.14	136	185	Peak
499.5	30.94	44.06	46	-15.06	16.35	2.63	32.1	158	175	Peak
700.4	32.52	42.26	46	-13.48	19.24	3.11	32.09	122	185	Peak
916.7	30.54	36.83	46	-15.46	21.54	3.53	31.36	169	223	Peak

REMARKS: Emission Level = Read Level + Antenna Factor + Cable Loss - Preamp Factor
Margin value = Emission level – Limit value



802.11ac (VHT80)

EUT TEST CONDITION		MEASUREMENT DETAIL	
CHANNEL	Channel 155	FREQUENCY RANGE	30 MHz ~ 1 GHz
INPUT POWER	120 Vac, 60 Hz	DETECTOR FUNCTION	Peak (PK)
ENVIRONMENTAL CONDITIONS	25 deg. C, 65 % RH	TESTED BY	Karl Lee

ANTENNA POLARITY & TEST DISTANCE: HORIZONTAL AT 3 M

FREQ. (MHz)	EMISSION LEVEL (dBuV/m)	READ LEVEL (dBuV)	LIMIT (dBuV/m)	MARGIN (dB)	ANTENNA FACTOR (dB/m)	CABLE LOSS (dB)	PREAMP FACTOR (dB)	ANTENNA HEIGHT (cm)	TABLE ANGLE (Degree)	REMARK
99.93	34.21	52.91	43.5	-9.29	12.28	1.28	32.26	169	175	Peak
200.1	42.23	61.8	43.5	-1.27	11.08	1.65	32.3	135	167	Peak
298.92	44.79	61.86	46	-1.21	13.04	2.03	32.14	155	178	Peak
497.4	37.71	50.86	46	-8.29	16.32	2.63	32.1	176	218	Peak
697.6	31.03	40.81	46	-14.97	19.2	3.11	32.09	155	186	Peak
817.3	31.97	40	46	-14.03	20.61	3.32	31.96	167	183	Peak

ANTENNA POLARITY & TEST DISTANCE: VERTICAL AT 3 M

FREQ. (MHz)	EMISSION LEVEL (dBuV/m)	READ LEVEL (dBuV)	LIMIT (dBuV/m)	MARGIN (dB)	ANTENNA FACTOR (dB/m)	CABLE LOSS (dB)	PREAMP FACTOR (dB)	ANTENNA HEIGHT (cm)	TABLE ANGLE (Degree)	REMARK
99.93	23.59	42.29	43.5	-19.91	12.28	1.28	32.26	136	142	Peak
200.1	31.38	50.95	43.5	-12.12	11.08	1.65	32.3	175	146	Peak
300	43.15	60.2	46	-2.85	13.06	2.03	32.14	142	186	Peak
497.4	29.37	42.52	46	-16.63	16.32	2.63	32.1	152	172	Peak
697.6	28.78	38.56	46	-17.22	19.2	3.11	32.09	125	168	Peak
978.3	28.49	33.42	54	-25.51	21.98	3.72	30.63	144	185	Peak

REMARKS: Emission Level = Read Level + Antenna Factor + Cable Loss - Preamp Factor
Margin value = Emission level – Limit value

4.2 Conducted Emission Measurement

4.2.1 Limits of Conducted Emission Measurement

Frequency (MHz)	Conducted Limit (dBuV)	
	Quasi-peak	Average
0.15 - 0.5	66 - 56	56 - 46
0.50 - 5.0	56	46
5.0 - 30.0	60	50

Note: 1. The lower limit shall apply at the transition frequencies.

2. The limit decreases in line with the logarithm of the frequency in the range of 0.15 to 0.50 MHz.

4.2.2 Test Instruments

Description & Manufacturer	Model No.	Serial No.	Date Of Calibration	Due Date Of Calibration
Test Receiver ROHDE & SCHWARZ	ESCI	100613	Nov. 16, 2015	Nov. 15, 2016
RF signal cable Woken	5D-FB	Cable-cond1-01	Dec. 26, 2014	Dec. 25, 2015
LISN ROHDE & SCHWARZ (EUT)	ESH3-Z5	835239/001	Feb. 26, 2015	Feb. 25, 2016
LISN ROHDE & SCHWARZ (Peripheral)	ESH3-Z5	100311	Jul. 24, 2015	Jul. 23, 2016
Software ADT	BV ADT_Cond_ V7.3.7.3	NA	NA	NA

- Note:**
1. The calibration interval of the above test instruments is 12 months and the calibrations are traceable to NML/ROC and NIST/USA.
 2. The test was performed in HwaYa Shielded Room 1.
 3. The VCCI Site Registration No. is C-2040.

4.2.3 Test Procedures

- a. The EUT was placed 0.4 meters from the conducting wall of the shielded room with EUT being connected to the power mains through a line impedance stabilization network (LISN). Other support units were connected to the power mains through another LISN. The two LISNs provide 50 ohm/ 50uH of coupling impedance for the measuring instrument.
- b. Both lines of the power mains connected to the EUT were checked for maximum conducted interference.
- c. The frequency range from 150 kHz to 30 MHz was searched. Emission levels under (Limit -20 dB) was not recorded.

NOTE: All modes of operation were investigated and the worst-case emissions are reported.

4.2.4 Deviation from Test Standard

No deviation.

4.2.5 Test Setup

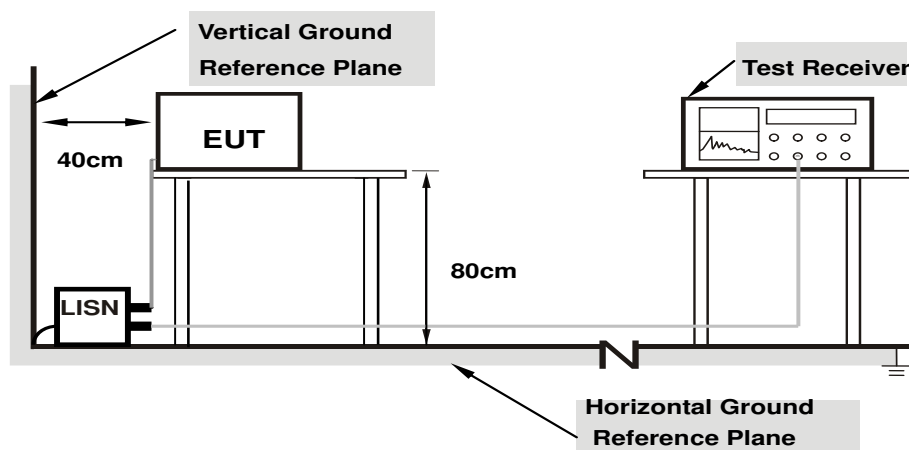

- Note: 1.Support units were connected to second LISN.**
2.Both of LISNs (AMN) are 80 cm from EUT and at least 80 from other units and other metal planes

For the actual test configuration, please refer to the attached file (Test Setup Photo).

4.2.6 EUT Operating Conditions

- a. Placed the EUT on a testing table.
- b. Use the software to control the EUT under transmission condition continuously at specific channel frequency.

4.2.7 Test Results

Mode A

Frequency Range	150kHz ~ 30MHz	Detector Function & Resolution Bandwidth	Quasi-Peak (QP) / Average (AV), 9kHz
Input Power	120Vac, 60Hz	Environmental Conditions	25°C, 65%RH
Tested by	Toby Tian	Test Date	2015/12/16

Phase Of Power : Line (L)										
No	Frequency (MHz)	Correction Factor (dB)	Reading Value (dBuV)		Emission Level (dBuV)		Limit (dBuV)		Margin (dB)	
			Q.P.	AV.	Q.P.	AV.	Q.P.	AV.	Q.P.	AV.
1	0.17744	9.83	43.44	25.92	53.27	35.75	64.60	54.60	-11.33	-18.85
2	0.19692	9.84	43.79	26.20	53.63	36.04	63.74	53.74	-10.11	-17.70
3	0.23993	9.85	37.21	21.32	47.06	31.17	62.10	52.10	-15.04	-20.93
4	0.32204	9.86	27.23	9.79	37.09	19.65	59.65	49.65	-22.56	-30.00
5	0.37678	9.88	27.44	13.64	37.32	23.52	58.35	48.35	-21.03	-24.83
6	1.93687	10.00	21.55	11.81	31.55	21.81	56.00	46.00	-24.45	-24.19

Remarks:

1. Q.P. and AV. are abbreviations of quasi-peak and average individually.
2. The emission levels of other frequencies were very low against the limit.
3. Margin value = Emission level – Limit value
4. Correction factor = Insertion loss + Cable loss
5. Emission Level = Correction Factor + Reading Value

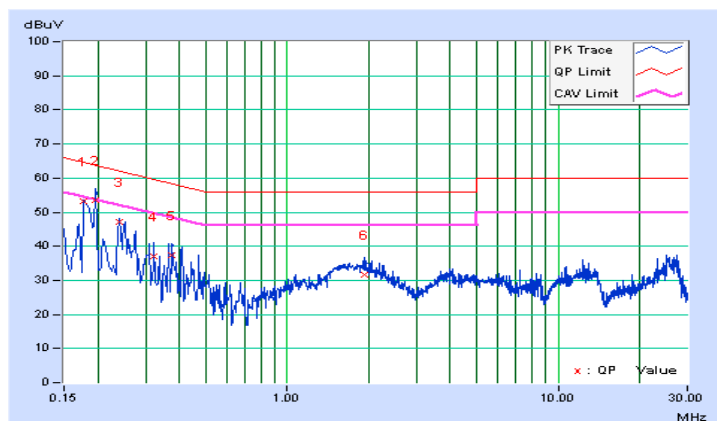

Frequency Range	150kHz ~ 30MHz	Detector Function & Resolution Bandwidth	Quasi-Peak (QP) / Average (AV), 9kHz
Input Power	120Vac, 60Hz	Environmental Conditions	25°C, 65%RH
Tested by	Toby Tian	Test Date	2015/12/16

Phase Of Power : Neutral (N)										
No	Frequency (MHz)	Correction Factor (dB)	Reading Value (dBuV)		Emission Level (dBuV)		Limit (dBuV)		Margin (dB)	
			Q.P.	AV.	Q.P.	AV.	Q.P.	AV.	Q.P.	AV.
1	0.16569	9.82	44.85	20.72	54.67	30.54	65.17	55.17	-10.50	-24.63
2	0.18953	9.83	44.06	26.29	53.89	36.12	64.06	54.06	-10.17	-17.94
3	0.24731	9.84	36.87	23.30	46.71	33.14	61.85	51.85	-15.14	-18.71
4	0.32204	9.86	24.66	7.63	34.52	17.49	59.65	49.65	-25.13	-32.16
5	0.34550	9.87	23.14	6.60	33.01	16.47	59.07	49.07	-26.06	-32.60
6	1.85867	9.98	19.88	11.29	29.86	21.27	56.00	46.00	-26.14	-24.73

Remarks:

1. Q.P. and AV. are abbreviations of quasi-peak and average individually.
2. The emission levels of other frequencies were very low against the limit.
3. Margin value = Emission level – Limit value
4. Correction factor = Insertion loss + Cable loss
5. Emission Level = Correction Factor + Reading Value

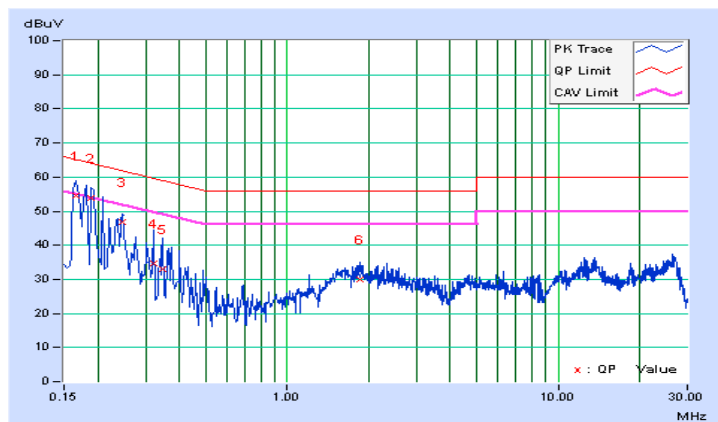

Mode B

Frequency Range	150kHz ~ 30MHz	Detector Function & Resolution Bandwidth	Quasi-Peak (QP) / Average (AV), 9kHz
Input Power	120Vac, 60Hz	Environmental Conditions	25°C, 65%RH
Tested by	Toby Tian	Test Date	2015/12/16

Phase Of Power : Line (L)										
No	Frequency (MHz)	Correction Factor (dB)	Reading Value (dBuV)		Emission Level (dBuV)		Limit (dBuV)		Margin (dB)	
			Q.P.	AV.	Q.P.	AV.	Q.P.	AV.	Q.P.	AV.
1	0.17737	9.83	43.85	28.84	53.68	38.67	64.61	54.61	-10.93	-15.94
2	0.18519	9.83	43.60	27.38	53.43	37.21	64.25	54.25	-10.82	-17.04
3	0.23216	9.85	36.72	20.39	46.57	30.24	62.37	52.37	-15.81	-22.14
4	0.30249	9.86	28.24	14.87	38.10	24.73	60.17	50.17	-22.07	-25.44
5	0.41588	9.88	25.25	12.13	35.13	22.01	57.53	47.53	-22.40	-25.52
6	2.02289	10.00	20.09	11.06	30.09	21.06	56.00	46.00	-25.91	-24.94

Remarks:

1. Q.P. and AV. are abbreviations of quasi-peak and average individually.
2. The emission levels of other frequencies were very low against the limit.
3. Margin value = Emission level – Limit value
4. Correction factor = Insertion loss + Cable loss
5. Emission Level = Correction Factor + Reading Value

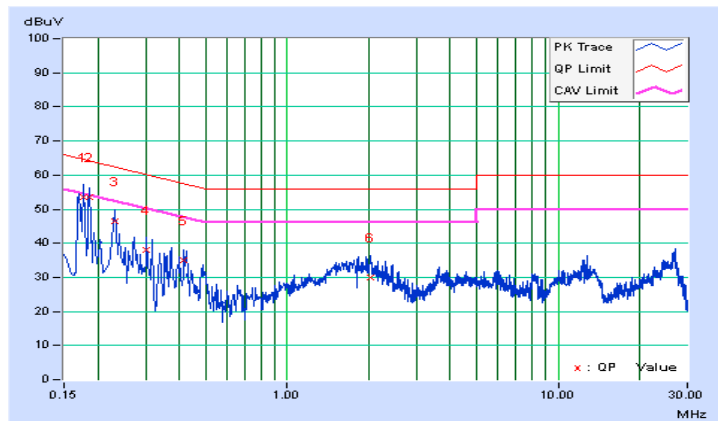

Frequency Range	150kHz ~ 30MHz	Detector Function & Resolution Bandwidth	Quasi-Peak (QP) / Average (AV), 9kHz
Input Power	120Vac, 60Hz	Environmental Conditions	25°C, 65%RH
Tested by	Toby Tian	Test Date	2015/12/16

Phase Of Power : Neutral (N)										
No	Frequency (MHz)	Correction Factor (dB)	Reading Value (dBuV)		Emission Level (dBuV)		Limit (dBuV)		Margin (dB)	
			Q.P.	AV.	Q.P.	AV.	Q.P.	AV.	Q.P.	AV.
1	0.18122	9.83	44.16	31.66	53.99	41.49	64.43	54.43	-10.44	-12.94
2	0.22038	9.84	38.29	18.28	48.13	28.12	62.80	52.80	-14.68	-24.69
3	0.24796	9.84	36.00	21.02	45.84	30.86	61.83	51.83	-15.98	-20.96
4	0.27918	9.85	30.01	14.07	39.86	23.92	60.84	50.84	-20.98	-26.92
5	0.36505	9.87	24.83	9.85	34.70	19.72	58.61	48.61	-23.91	-28.89
6	2.32787	10.01	18.18	9.57	28.19	19.58	56.00	46.00	-27.81	-26.42

Remarks:

1. Q.P. and AV. are abbreviations of quasi-peak and average individually.
2. The emission levels of other frequencies were very low against the limit.
3. Margin value = Emission level – Limit value
4. Correction factor = Insertion loss + Cable loss
5. Emission Level = Correction Factor + Reading Value

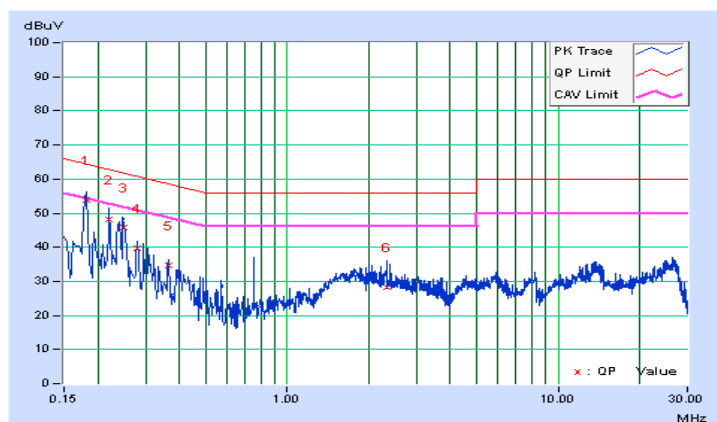

4.3 Transmit Power Measurement

4.3.1 Limits of Transmit Power Measurement

Operation Band	EUT Category	Limit
U-NII-1	Outdoor Access Point	1 Watt (30 dBm) (Max. e.i.r.p \leq 125 mW (21 dBm) at any elevation angle above 30 degrees as measured from the horizon)
	Fixed point-to-point Access Point	1 Watt (30 dBm)
	Indoor Access Point	1 Watt (30 dBm)
	√ Mobile and Portable client device	250 mW (24 dBm)
U-NII-2A		250 mW (24 dBm) or 11 dBm+10 log B*
U-NII-2C		250 mW (24 dBm) or 11 dBm+10 log B*
U-NII-3	√	1 Watt (30 dBm)

*B is the 26 dB emission bandwidth in megahertz

Per KDB 662911 Method of conducted output power measurement on IEEE 802.11 devices,

Array Gain = 0 dB (i.e., no array gain) for $N_{ANT} \leq 4$;

Array Gain = 0 dB (i.e., no array gain) for channel widths ≥ 40 MHz for any N_{ANT} ;

Array Gain = $5 \log(N_{ANT}/N_{SS})$ dB or 3 dB, whichever is less for 20 MHz channel widths with $N_{ANT} \geq 5$.

For power measurements on all other devices: Array Gain = $10 \log(N_{ANT}/N_{SS})$ dB.

4.3.2 Test Setup

<Power Output Measurement>

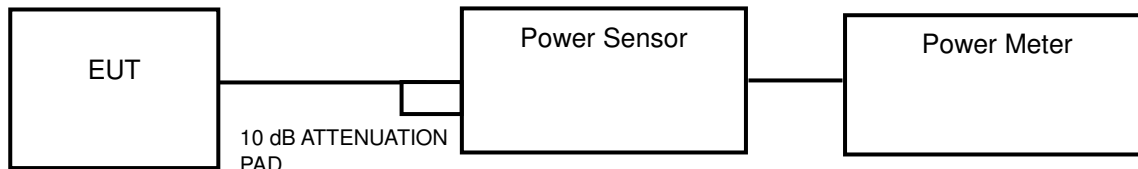

or

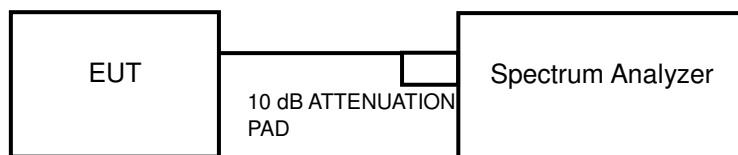

<26 dB Bandwidth>

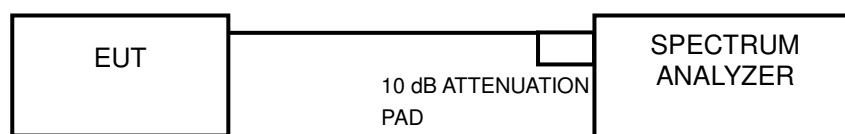

4.3.3 Test Instruments

Refer to section 4.1.2 to get information of above instrument.

4.3.4 Test Procedure

Average Power Measurement

<802.11a, 802.11n (HT20), 802.11n (HT40)>

Method PM is used to perform output power measurement, trigger and gating function of wide band power meter is enabled to measure max output power of TX on burst. Duty factor is not added to measured value.

<802.11ac (VHT80)>

Method SA-1 is used to perform output power measurement, trigger and gating function of spectrum analyzer is enabled to measure max output power of TX on burst. Duty factor is not added to measured value.

26 dB Bandwidth

- 1) Set RBW = approximately 1 % of the emission bandwidth.
- 2) Set the VBW > RBW.
- 3) Detector = Peak.
- 4) Trace mode = max hold.
- 5) Measure the maximum width of the emission that is 26 dB down from the peak of the emission. Compare this with the RBW setting of the analyzer. Readjust RBW and repeat measurement as needed until the RBW/EBW ratio is approximately 1 %.

4.3.5 Deviation from Test Standard

No deviation.

4.3.6 EUT Operating Conditions

The software provided by client to enable the EUT under transmission condition continuously at lowest, middle and highest channel frequencies individually.

4.3.7 Test Result

Mode A

Power Output:

802.11a

Channel	Frequency (MHz)	Maximum Conducted Power (dBm)			Total Power (mW)	Total Power (dBm)	Power Limit (dBm)	Pass / Fail
		Chain 0	Chain 1	Chain 2				
36	5180	12.52	13.55	12.04	56.51	17.52	24	Pass
44	5220	13.53	14.08	12.43	65.63	18.17	24	Pass
48	5240	13.48	13.67	12.40	62.94	17.99	24	Pass
149	5745	13.93	13.24	11.75	60.766	17.84	30	Pass
157	5785	14.20	13.49	12.18	65.158	18.14	30	Pass
161	5805	13.84	13.66	11.48	61.498	17.89	30	Pass

802.11n (HT20)

Channel	Frequency (MHz)	Maximum Conducted Power (dBm)			Total Power (mW)	Total Power (dBm)	Power Limit (dBm)	Pass / Fail
		Chain 0	Chain 1	Chain 2				
36	5180	12.79	13.79	12.07	59.05	17.71	24	Pass
44	5220	13.54	13.83	12.45	64.33	18.08	24	Pass
48	5240	13.43	13.61	12.38	62.29	17.94	24	Pass
149	5745	11.94	12.59	10.50	45.007	16.53	30	Pass
157	5785	14.34	13.68	12.14	66.867	18.25	30	Pass
161	5805	14.08	13.22	11.77	61.607	14.08	30	Pass

802.11n (HT40)

Channel	Frequency (MHz)	Maximum Conducted Power (dBm)			Total Power (mW)	Total Power (dBm)	Power Limit (dBm)	Pass / Fail
		Chain 0	Chain 1	Chain 2				
38	5190	9.86	10.55	9.31	29.56	14.71	24	Pass
46	5230	13.33	13.38	11.88	58.72	17.69	24	Pass
151	5755	11.48	12.45	9.11	39.787	16.00	30	Pass
159	5795	13.39	14.44	11.47	63.653	18.04	30	Pass

802.11ac (VHT80)

Channel	Frequency (MHz)	Maximum Conducted Power (dBm)			Total Power (mW)	Total Power (dBm)	Power Limit (dBm)	Pass / Fail
		Chain 0	Chain 1	Chain 2				
42	5210	7.28	7.02	6.03	14.39	11.58	24	Pass
155	5775	5.94	6.70	4.59	11.481	10.60	30	Pass

26 dB Bandwidth:
802.11a

Channel	Frequency (MHz)	26 dBc Bandwidth (MHz)			Pass / Fail
		Chain 0	Chain 1	Chain 2	
36	5180	23.26	25.33	23.86	Pass
44	5220	23.94	24.90	23.30	Pass
48	5240	23.92	24.66	23.61	Pass

802.11n (HT20)

Channel	Frequency (MHz)	26 dBc Bandwidth (MHz)			Pass / Fail
		Chain 0	Chain 1	Chain 2	
36	5180	24.65	24.33	23.88	Pass
44	5220	24.30	25.18	24.30	Pass
48	5240	24.51	24.35	24.40	Pass

802.11n (HT40)

Channel	Frequency (MHz)	26 dBc Bandwidth (MHz)			Pass / Fail
		Chain 0	Chain 1	Chain 2	
38	5190	46.27	46.72	47.37	Pass
46	5230	48.44	47.35	48.70	Pass

802.11ac (VHT80)

Channel	Frequency (MHz)	26 dBc Bandwidth (MHz)			Pass / Fail
		Chain 0	Chain 1	Chain 2	
42	5210	94.64	91.50	88.93	Pass

Spectrum Plot of Worst Value

802.11a

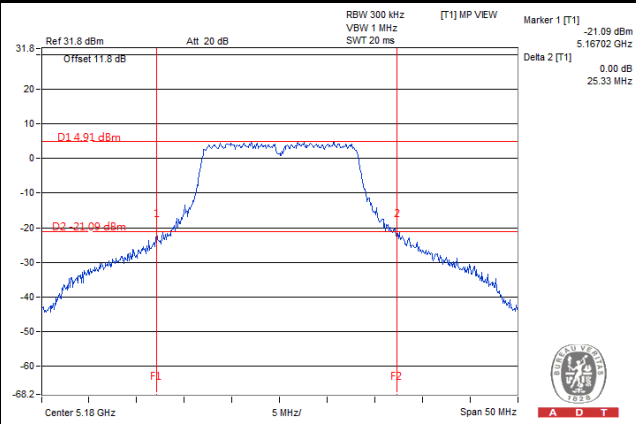

802.11n (HT20)

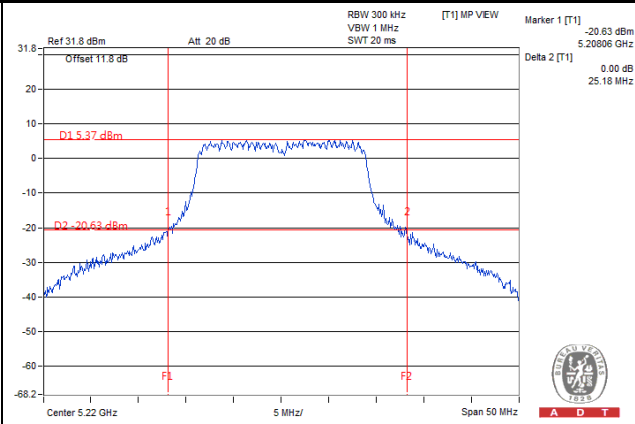

802.11n (HT40)

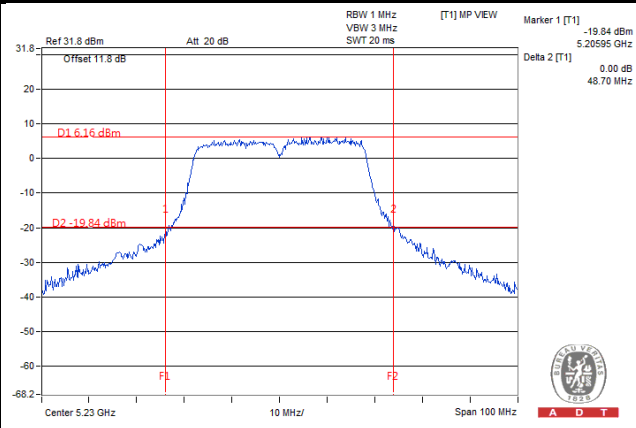

802.11ac (VHT80)

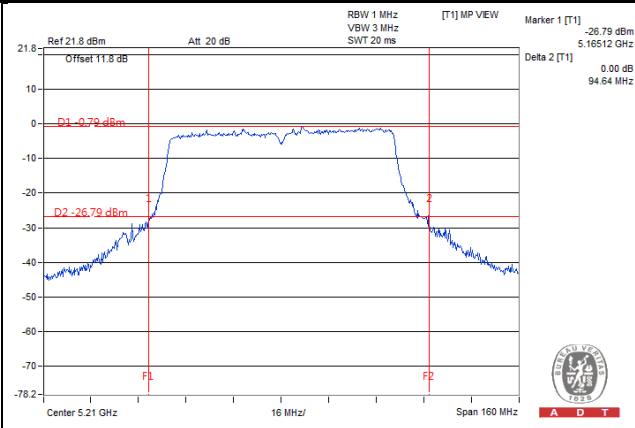

Mode B
Power Output:
802.11a

Channel	Frequency (MHz)	Maximum Conducted Power (dBm)			Total Power (mW)	Total Power (dBm)	Power Limit (dBm)	Pass / Fail
		Chain 0	Chain 1	Chain 2				
36	5180	12.92	13.80	12.04	59.57	17.75	24	Pass
44	5220	13.53	14.08	12.43	65.63	18.17	24	Pass
48	5240	13.48	13.67	12.40	62.94	17.99	24	Pass
149	5745	13.93	13.24	11.75	60.766	17.84	30	Pass
157	5785	14.20	13.49	12.18	65.158	18.14	30	Pass
161	5805	13.23	13.56	11.86	59.083	17.71	30	Pass

802.11n (HT20)

Channel	Frequency (MHz)	Maximum Conducted Power (dBm)			Total Power (mW)	Total Power (dBm)	Power Limit (dBm)	Pass / Fail
		Chain 0	Chain 1	Chain 2				
36	5180	12.67	13.31	11.95	55.59	17.45	24	Pass
44	5220	13.54	13.83	12.45	64.33	18.08	24	Pass
48	5240	13.43	13.61	12.38	62.29	17.94	24	Pass
149	5745	13.85	13.65	11.21	60.653	17.83	30	Pass
157	5785	14.34	13.68	12.14	66.867	18.25	30	Pass
161	5805	13.79	12.99	11.55	58.129	17.64	30	Pass

802.11n (HT40)

Channel	Frequency (MHz)	Maximum Conducted Power (dBm)			Total Power (mW)	Total Power (dBm)	Power Limit (dBm)	Pass / Fail
		Chain 0	Chain 1	Chain 2				
38	5190	9.87	9.77	8.89	26.93	14.30	24	Pass
46	5230	13.33	13.38	11.88	58.72	17.69	24	Pass
151	5755	12.53	13.11	10.11	48.627	16.87	30	Pass
159	5795	13.39	14.44	11.47	63.653	18.04	30	Pass

802.11ac (VHT80)

Channel	Frequency (MHz)	Maximum Conducted Power (dBm)			Total Power (mW)	Total Power (dBm)	Power Limit (dBm)	Pass / Fail
		Chain 0	Chain 1	Chain 2				
42	5210	6.45	5.77	4.83	11.23	10.50	24	Pass
155	5775	5.94	6.70	4.59	11.481	10.60	30	Pass

26 dB Bandwidth:
802.11a

Channel	Frequency (MHz)	26 dBc Bandwidth (MHz)			Pass / Fail
		Chain 0	Chain 1	Chain 2	
36	5180	23.26	25.33	23.86	Pass
44	5220	23.94	24.90	23.30	Pass
48	5240	23.92	24.66	23.61	Pass

802.11n (HT20)

Channel	Frequency (MHz)	26 dBc Bandwidth (MHz)			Pass / Fail
		Chain 0	Chain 1	Chain 2	
36	5180	23.99	24.39	24.99	Pass
44	5220	24.30	25.18	24.30	Pass
48	5240	24.51	24.35	24.40	Pass

802.11n (HT40)

Channel	Frequency (MHz)	26 dBc Bandwidth (MHz)			Pass / Fail
		Chain 0	Chain 1	Chain 2	
38	5190	46.65	46.68	46.39	Pass
46	5230	48.44	47.35	48.70	Pass

802.11ac (VHT80)

Channel	Frequency (MHz)	26 dBc Bandwidth (MHz)			Pass / Fail
		Chain 0	Chain 1	Chain 2	
42	5210	90.08	94.31	87.87	Pass

Spectrum Plot of Worst Value

802.11a

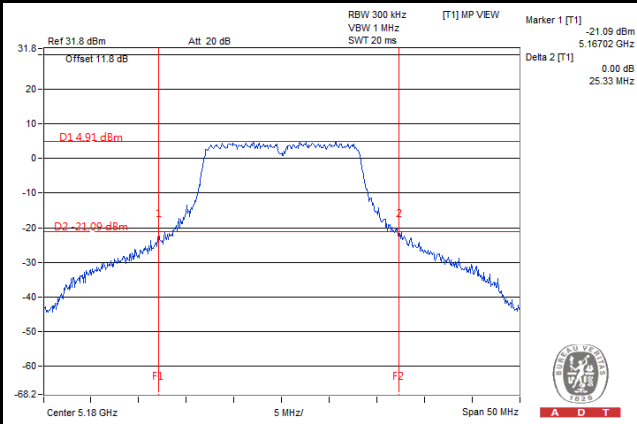

802.11n (HT20)

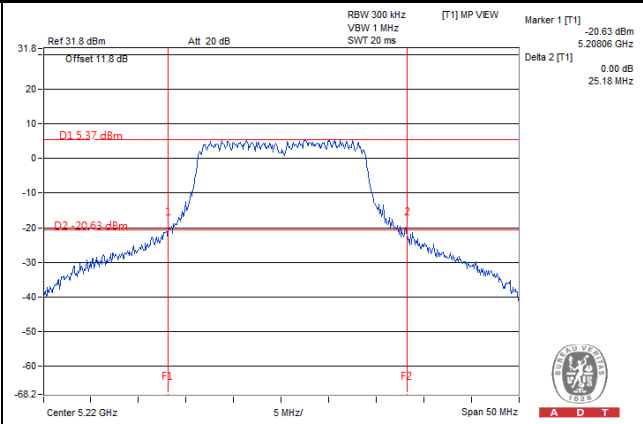

802.11n (HT40)

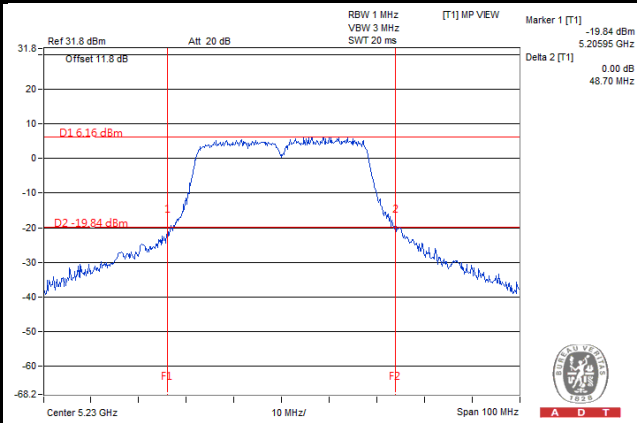

802.11ac (VHT80)

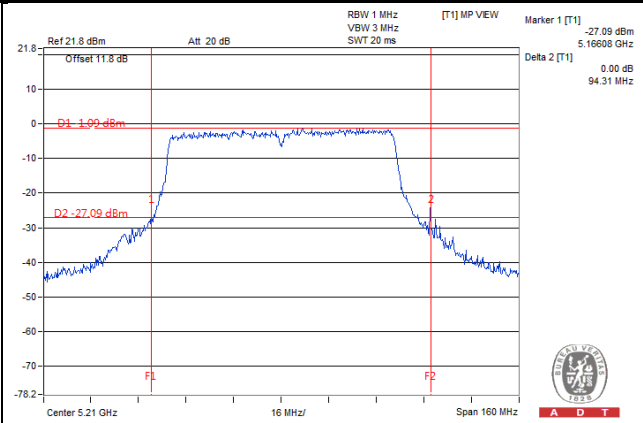

4.4 Peak Power Spectral Density Measurement

4.4.1 Limits of Peak Power Spectral Density Measurement

Operation Band	EUT Category		Limit
U-NII-1		Outdoor Access Point	17 dBm/MHz
		Fixed point-to-point Access Point	
		Indoor Access Point	
	√	Mobile and Portable client device	11 dBm/MHz
U-NII-2A			11 dBm/MHz
U-NII-2C			11 dBm/MHz
U-NII-3		√	30 dBm/500 kHz

4.4.2 Test Setup

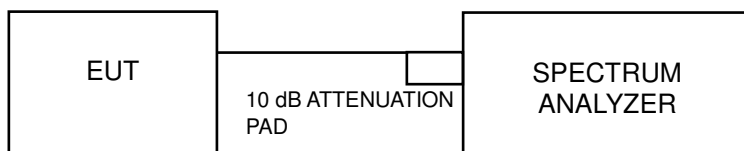

4.4.3 Test Instruments

Refer to section 4.1.3 to get information of above instrument.

4.4.4 Test Procedures

For U-NII-1 band:

Using method SA-2

1. Set span to encompass the entire emission bandwidth (EBW) of the signal.
2. Set RBW = 1 MHz, Set VBW ≥ 3 MHz, Detector = RMS
3. Sweep time = auto, trigger set to “free run”.
4. Trace average at least 100 traces in power averaging mode.
5. Record the max value and add 10 log (1/duty cycle)

For U-NII-3:

1. Set span to encompass the entire emission bandwidth (EBW) of the signal.
2. Set RBW = 300 kHz, Set VBW ≥ 1 MHz, Detector = RMS
3. Use the peak marker function to determine the maximum power level in any 300 kHz band segment within the fundamental EBW.
4. Scale the observed power level to an equivalent value in 500 kHz by adjusting (reducing) the measured power by a bandwidth correction factor (BWCF) where $BWCF = 10\log(500\text{ kHz}/300\text{ kHz})$
5. Sweep time = auto, trigger set to “free run”.
6. Trace average at least 100 traces in power averaging mode.
7. Record the max value and add 10 log (1/duty cycle)

4.4.5 Deviation from Test Standard

No deviation.

4.4.6 EUT Operating Conditions

The software provided by client to enable the EUT under transmission condition continuously at lowest, middle and highest channel frequencies individually.

4.4.7 Test Results

Mode A

U-NII-1 Band

802.11a

Channel	Frequency (MHz)	PSD (dBm)			Total PSD w/o Duty Factor (dBm)	Duty Factor	Total PSD with Duty Factor (dBm)	Maximum Limit (dBm)	Pass / Fail
		Chain 0	Chain 1	Chain 2					
36	5180	0.27	1.34	-1.28	5.01	0.19	5.20	7.53	Pass
44	5220	1.01	1.73	-0.24	5.68	0.19	5.86	7.53	Pass
48	5240	1.07	1.78	-0.09	5.76	0.19	5.94	7.53	Pass

NOTE:

- Method 1 of power density measurement of KDB 662911 is using for calculating total power density. Total power density is summing entire spectra across corresponding frequency bins on the various outputs by computer.
- Directional gain = $4.70 \text{ dBi} + 10\log(3) = 9.47 \text{ dBi} > 6 \text{ dBi}$, so the power density limit shall be reduced to $11-(9.47-6) = 7.53 \text{ dBm}$.
- Refer to section 3.3 for duty cycle spectrum plot.

802.11n (HT20)

Channel	Frequency (MHz)	PSD (dBm)			Total PSD w/o Duty Factor (dBm)	Duty Factor	Total PSD with Duty Factor (dBm)	Maximum Limit (dBm)	Pass / Fail
		Chain 0	Chain 1	Chain 2					
36	5180	-0.28	0.94	-0.10	4.99	0.51	5.50	7.53	Pass
44	5220	0.41	1.20	-1.45	4.96	0.51	5.47	7.53	Pass
48	5240	0.33	1.15	-1.17	4.98	0.51	5.48	7.53	Pass

NOTE:

- Method 1 of power density measurement of KDB 662911 is using for calculating total power density. Total power density is summing entire spectra across corresponding frequency bins on the various outputs by computer.
- Directional gain = $4.70 \text{ dBi} + 10\log(3) = 9.47 \text{ dBi} > 6 \text{ dBi}$, so the power density limit shall be reduced to $11-(9.47-6) = 7.53 \text{ dBm}$.
- Refer to section 3.3 for duty cycle spectrum plot.

802.11n (HT40)

Channel	Frequency (MHz)	PSD (dBm)			Total PSD w/o Duty Factor (dBm)	Duty Factor	Total PSD with Duty Factor (dBm)	Maximum Limit (dBm)	Pass / Fail
		Chain 0	Chain 1	Chain 2					
38	5190	-6.22	-5.37	-7.30	-1.45	1.33	-0.12	7.53	Pass
46	5230	-2.78	-2.41	-4.59	1.61	1.33	2.94	7.53	Pass

NOTE:

- Method 1 of power density measurement of KDB 662911 is using for calculating total power density. Total power density is summing entire spectra across corresponding frequency bins on the various outputs by computer.
- Directional gain = $4.70 \text{ dBi} + 10\log(3) = 9.47 \text{ dBi} > 6 \text{ dBi}$, so the power density limit shall be reduced to $11-(9.47-6) = 7.53 \text{ dBm}$.
- Refer to section 3.3 for duty cycle spectrum plot.

802.11ac (VHT80)

Channel	Frequency (MHz)	PSD (dBm)			Total PSD w/o Duty Factor (dBm)	Duty Factor	Total PSD with Duty Factor (dBm)	Maximum Limit (dBm)	Pass / Fail
		Chain 0	Chain 1	Chain 2					
42	5210	-11.90	-11.10	-13.40	-7.26	2.24	-5.02	7.53	Pass

NOTE:

- Method 1 of power density measurement of KDB 662911 is using for calculating total power density. Total power density is summing entire spectra across corresponding frequency bins on the various outputs by computer.
- Directional gain = $4.70 \text{ dBi} + 10\log(3) = 9.47 \text{ dBi} > 6 \text{ dBi}$, so the power density limit shall be reduced to $11-(9.47-6) = 7.53 \text{ dBm}$.
- Refer to section 3.3 for duty cycle spectrum plot.

Spectrum Plot of Worst Value

802.11a

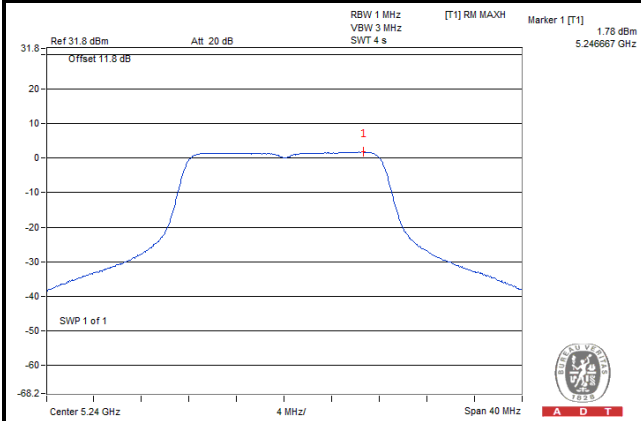

802.11n (HT20)

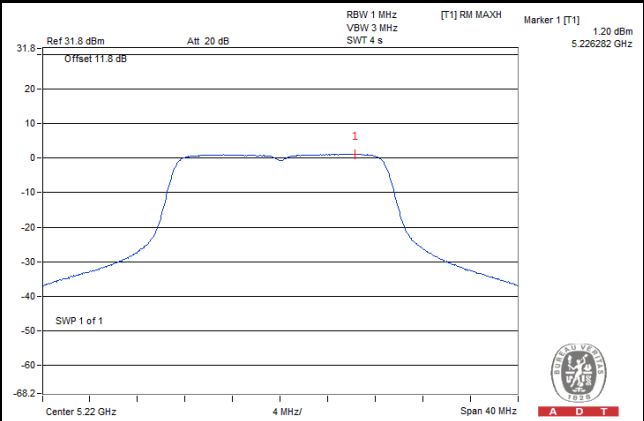

802.11n (HT40)

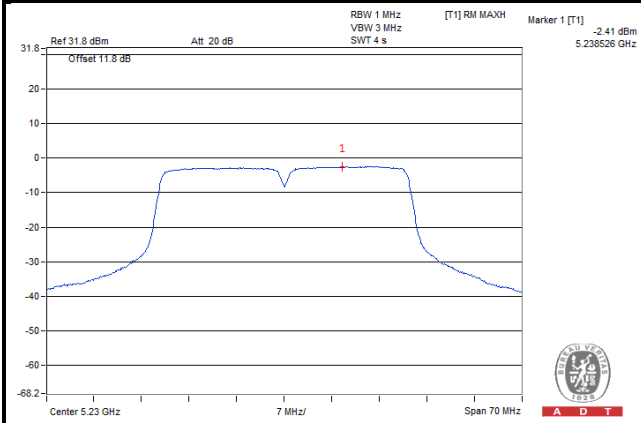

802.11ac (VHT80)

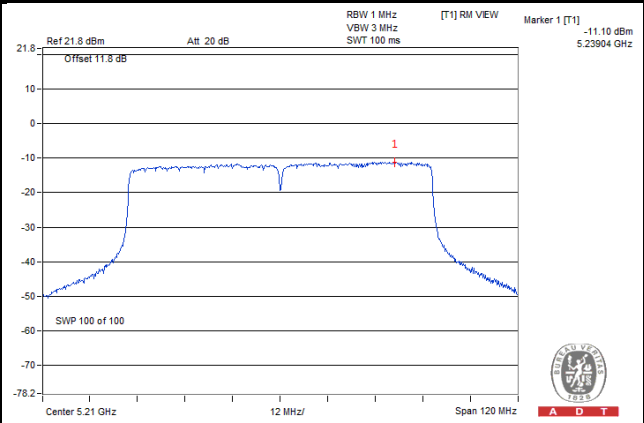

U-NII-3 Band
802.11a

TX Chain	Channel	Frequency (MHz)	PSD (dBm/500 kHz)	10 log (N=3) dB	Total PSD without Duty Factor (dBm/500 kHz)	Duty Factor	Total PSD with Duty Factor (dBm/500 kHz)	Limit (dBm/500 kHz)	Pass / Fail
0	149	5745	-1.55	4.77	3.22	0.19	3.41	25.99	Pass
	157	5785	-1.50	4.77	3.27	0.19	3.46	25.99	Pass
	161	5805	-1.28	4.77	3.49	0.19	3.68	25.99	Pass
1	149	5745	-2.48	4.77	2.29	0.19	2.48	25.99	Pass
	157	5785	-2.40	4.77	2.37	0.19	2.56	25.99	Pass
	161	5805	-1.74	4.77	3.03	0.19	3.22	25.99	Pass
2	149	5745	-4.18	4.77	0.59	0.19	0.78	25.99	Pass
	157	5785	-3.76	4.77	1.01	0.19	1.20	25.99	Pass
	161	5805	-3.32	4.77	1.45	0.19	1.64	25.99	Pass

NOTE:

- Method 1 of power density measurement of KDB 662911 is using for calculating total power density. Total power density is summing entire spectra across corresponding frequency bins on the various outputs by computer.
- Directional gain = 5.24 dBi + 10log(3) = 10.01 dBi > 6 dBi , so the power density limit shall be reduced to 30-(10.01-6) = 25.99 dBm.
- Refer to section 3.3 for duty cycle spectrum plot.

802.11n (HT20)

TX Chain	Channel	Frequency (MHz)	PSD (dBm/500 kHz)	10 log (N=3) dB	Total PSD without Duty Factor (dBm/500 kHz)	Duty Factor	Total PSD with Duty Factor (dBm/500 kHz)	Limit (dBm/500 kHz)	Pass / Fail
0	149	5745	-3.08	4.77	1.69	0.51	2.20	25.99	Pass
	157	5785	-1.42	4.77	3.35	0.51	3.86	25.99	Pass
	161	5805	-2.32	4.77	2.45	0.51	2.96	25.99	Pass
1	149	5745	-3.39	4.77	1.38	0.51	1.89	25.99	Pass
	157	5785	-2.62	4.77	2.15	0.51	2.66	25.99	Pass
	161	5805	-1.94	4.77	2.83	0.51	3.34	25.99	Pass
2	149	5745	-6.04	4.77	-1.27	0.51	-0.76	25.99	Pass
	157	5785	-4.10	4.77	0.67	0.51	1.18	25.99	Pass
	161	5805	-3.63	4.77	1.14	0.51	1.65	25.99	Pass

NOTE:

- Method 1 of power density measurement of KDB 662911 is using for calculating total power density. Total power density is summing entire spectra across corresponding frequency bins on the various outputs by computer.
- Directional gain = 5.24 dBi + 10log(3) = 10.01 dBi > 6 dBi , so the power density limit shall be reduced to 30-(10.01-6) = 25.99 dBm.
- Refer to section 3.3 for duty cycle spectrum plot.

802.11n (HT40)

TX Chain	Channel	Frequency (MHz)	PSD (dBm/500 kHz)	10 log (N=3) dB	Total PSD without Duty Factor (dBm/500 kHz)	Duty Factor	Total PSD with Duty Factor (dBm/500 kHz)	Limit (dBm/500 kHz)	Pass / Fail
0	151	5755	-7.64	4.77	-2.87	1.33	-1.54	25.99	Pass
	159	5795	-5.28	4.77	-0.51	1.33	0.82	25.99	Pass
1	151	5755	-6.75	4.77	-1.98	1.33	-0.65	25.99	Pass
	159	5795	-4.52	4.77	0.25	1.33	1.58	25.99	Pass
2	151	5755	-10.57	4.77	-5.80	1.33	-4.47	25.99	Pass
	159	5795	-7.55	4.77	-2.78	1.33	-1.45	25.99	Pass

NOTE:

- Method 1 of power density measurement of KDB 662911 is using for calculating total power density. Total power density is summing entire spectra across corresponding frequency bins on the various outputs by computer.
- Directional gain = 5.24 dBi + 10log(3) = 10.01 dBi > 6 dBi , so the power density limit shall be reduced to 30-(10.01-6) = 25.99 dBm.
- Refer to section 3.3 for duty cycle spectrum plot.

802.11ac (VHT80)

TX Chain	Channel	Frequency (MHz)	PSD (dBm/500 kHz)	10 log (N=3) dB	Total PSD without Duty Factor (dBm/500 kHz)	Duty Factor	Total PSD with Duty Factor (dBm/500 kHz)	Limit (dBm/500 kHz)	Pass / Fail
0	155	5775	-15.80	4.77	-11.03	2.24	-8.79	25.99	Pass
1	155	5775	-14.18	4.77	-9.41	2.24	-7.17	25.99	Pass
2	155	5775	-17.32	4.77	-12.55	2.24	-10.31	25.99	Pass

NOTE:

- Method 1 of power density measurement of KDB 662911 is using for calculating total power density. Total power density is summing entire spectra across corresponding frequency bins on the various outputs by computer.
- Directional gain = 5.24 dBi + 10log(3) = 10.01 dBi > 6 dBi , so the power density limit shall be reduced to 30-(10.01-6) = 25.99 dBm.
- Refer to section 3.3 for duty cycle spectrum plot.

Spectrum Plot of Worst Value

802.11a

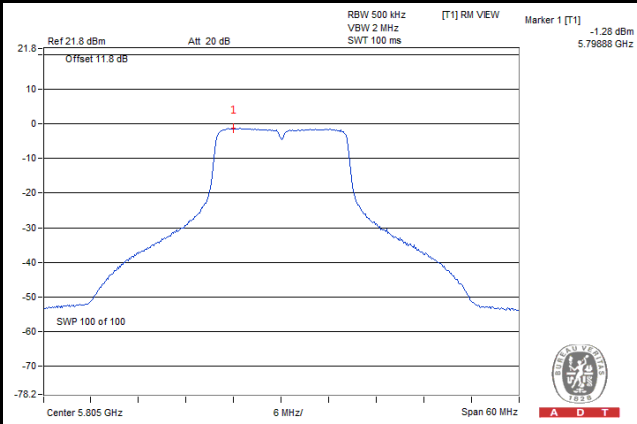

802.11n (HT20)

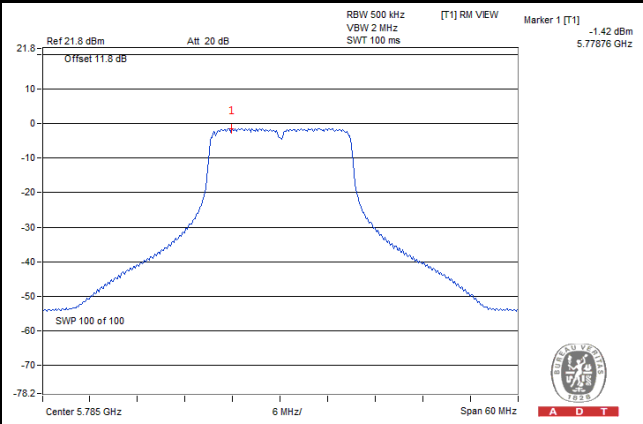

802.11n (HT40)

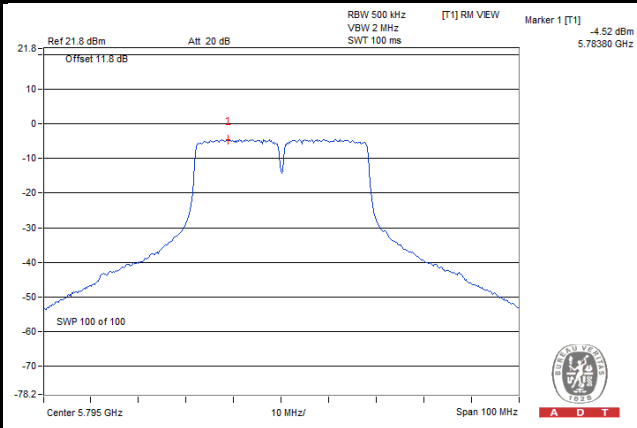

802.11ac (VHT80)

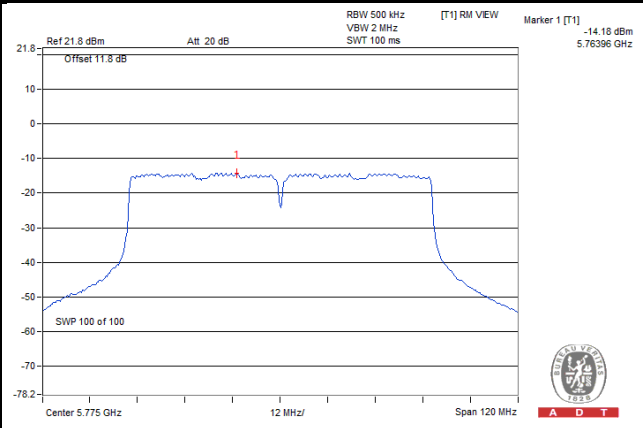

Mode B

U-NII-1 Band

802.11a

Channel	Frequency (MHz)	PSD (dBm)			Total PSD w/o Duty Factor (dBm)	Duty Factor	Total PSD with Duty Factor (dBm)	Maximum Limit (dBm)	Pass / Fail
		Chain 0	Chain 1	Chain 2					
36	5180	0.27	1.34	-1.28	5.01	5.20	0.19	10.28	Pass
44	5220	1.01	1.73	-0.24	5.68	5.86	0.19	10.28	Pass
48	5240	1.07	1.78	-0.09	5.76	5.94	0.19	10.28	Pass

NOTE:

1. Method 1 of power density measurement of KDB 662911 is using for calculating total power density. Total power density is summing entire spectra across corresponding frequency bins on the various outputs by computer.
2. Directional gain = $1.95 \text{ dBi} + 10\log(3) = 6.72 \text{ dBi} > 6 \text{ dBi}$, so the power density limit shall be reduced to $11-(6.72-6) = 10.28 \text{ dBm}$.
3. Refer to section 3.3 for duty cycle spectrum plot.

802.11n (HT20)

Channel	Frequency (MHz)	PSD (dBm)			Total PSD w/o Duty Factor (dBm)	Duty Factor	Total PSD with Duty Factor (dBm)	Maximum Limit (dBm)	Pass / Fail
		Chain 0	Chain 1	Chain 2					
36	5180	-1.19	0.31	-2.66	3.76	0.51	4.26	10.28	Pass
44	5220	0.41	1.20	-1.45	4.96	0.51	5.47	10.28	Pass
48	5240	0.33	1.15	-1.17	4.98	0.51	5.48	10.28	Pass

NOTE:

1. Method 1 of power density measurement of KDB 662911 is using for calculating total power density. Total power density is summing entire spectra across corresponding frequency bins on the various outputs by computer.
2. Directional gain = $1.95 \text{ dBi} + 10\log(3) = 6.72 \text{ dBi} > 6 \text{ dBi}$, so the power density limit shall be reduced to $11-(6.72-6) = 10.28 \text{ dBm}$.
3. Refer to section 3.3 for duty cycle spectrum plot.

802.11n (HT40)

Channel	Frequency (MHz)	PSD (dBm)			Total PSD w/o Duty Factor (dBm)	Duty Factor	Total PSD with Duty Factor (dBm)	Maximum Limit (dBm)	Pass / Fail
		Chain 0	Chain 1	Chain 2					
38	5190	-6.66	-5.85	-8.52	-2.10	1.33	-0.77	10.28	Pass
46	5230	-2.78	-2.41	-4.59	1.61	1.33	2.94	10.28	Pass

NOTE:

- Method 1 of power density measurement of KDB 662911 is using for calculating total power density. Total power density is summing entire spectra across corresponding frequency bins on the various outputs by computer.
- Directional gain = $1.95 \text{ dBi} + 10\log(3) = 6.72 \text{ dBi} > 6 \text{ dBi}$, so the power density limit shall be reduced to $11-(6.72-6) = 10.28 \text{ dBm}$.
- Refer to section 3.3 for duty cycle spectrum plot.

802.11ac (VHT80)

Channel	Frequency (MHz)	PSD (dBm)			Total PSD w/o Duty Factor (dBm)	Duty Factor	Total PSD with Duty Factor (dBm)	Maximum Limit (dBm)	Pass / Fail
		Chain 0	Chain 1	Chain 2					
42	5210	-12.22	-12.10	-13.77	-7.86	2.10	-5.77	10.28	Pass

NOTE:

- Method 1 of power density measurement of KDB 662911 is using for calculating total power density. Total power density is summing entire spectra across corresponding frequency bins on the various outputs by computer.
- Directional gain = $1.95 \text{ dBi} + 10\log(3) = 6.72 \text{ dBi} > 6 \text{ dBi}$, so the power density limit shall be reduced to $11-(6.72-6) = 10.28 \text{ dBm}$.
- Refer to section 3.3 for duty cycle spectrum plot.

Spectrum Plot of Worst Value

802.11a

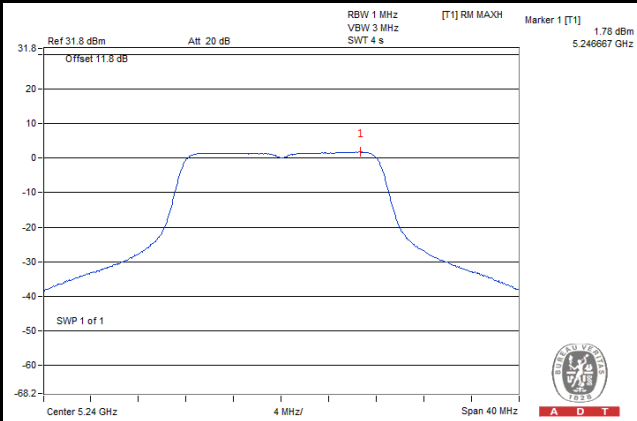

802.11n (HT20)

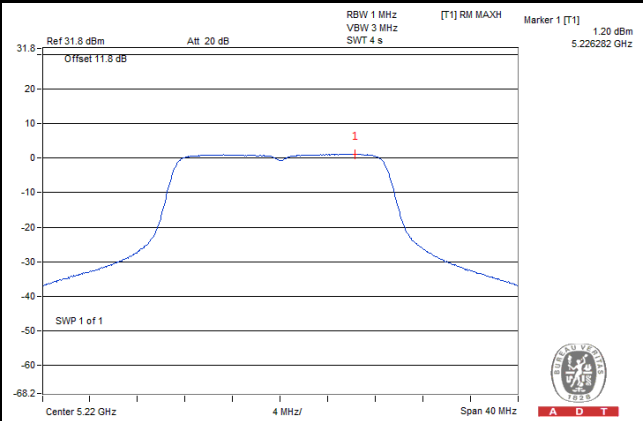

802.11n (HT40)

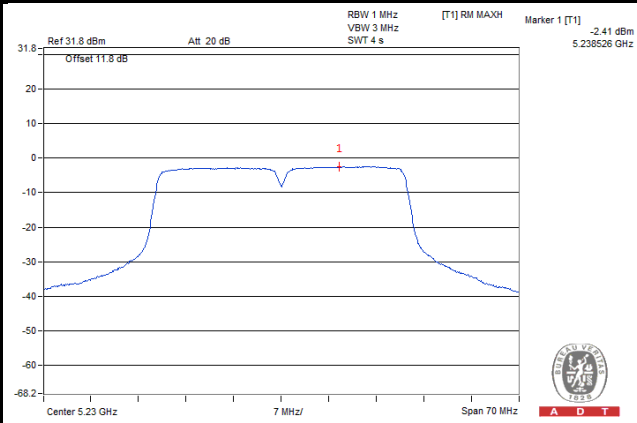

802.11ac (VHT80)

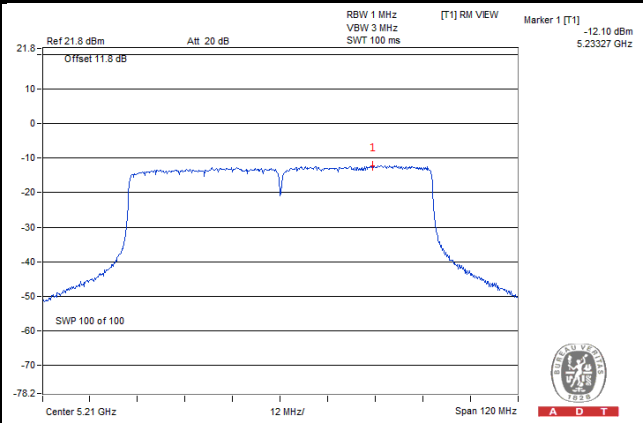

U-NII-3 Band
802.11a

TX Chain	Channel	Frequency (MHz)	PSD (dBm/500 kHz)	10 log (N=3) dB	Total PSD without Duty Factor (dBm/500 kHz)	Duty Factor	Total PSD with Duty Factor (dBm/500 kHz)	Limit (dBm/500 kHz)	Pass / Fail
0	149	5745	-1.55	4.77	3.22	0.19	3.41	29.29	Pass
	157	5785	-1.50	4.77	3.27	0.19	3.46	29.29	Pass
	161	5805	-1.28	4.77	3.49	0.19	3.68	29.29	Pass
1	149	5745	-2.48	4.77	2.29	0.19	2.48	29.29	Pass
	157	5785	-2.40	4.77	2.37	0.19	2.56	29.29	Pass
	161	5805	-1.74	4.77	3.03	0.19	3.22	29.29	Pass
2	149	5745	-4.18	4.77	0.59	0.19	0.78	29.29	Pass
	157	5785	-3.76	4.77	1.01	0.19	1.20	29.29	Pass
	161	5805	-3.32	4.77	1.45	0.19	1.64	29.29	Pass

NOTE:

- Method 1 of power density measurement of KDB 662911 is using for calculating total power density. Total power density is summing entire spectra across corresponding frequency bins on the various outputs by computer.
- Directional gain = 1.94 dBi + 10log(3) = 6.71 dBi > 6 dBi , so the power density limit shall be reduced to 30-(6.71-6) = 29.29 dBm.
- Refer to section 3.3 for duty cycle spectrum plot.

802.11n (HT20)

TX Chain	Channel	Frequency (MHz)	PSD (dBm/500 kHz)	10 log (N=3) dB	Total PSD without Duty Factor (dBm/500 kHz)	Duty Factor	Total PSD with Duty Factor (dBm/500 kHz)	Limit (dBm/500 kHz)	Pass / Fail
0	149	5745	-1.83	4.77	2.94	0.51	3.45	29.29	Pass
	157	5785	-1.42	4.77	3.35	0.51	3.86	29.29	Pass
	161	5805	-2.32	4.77	2.45	0.51	2.96	29.29	Pass
1	149	5745	-2.88	4.77	1.89	0.51	2.40	29.29	Pass
	157	5785	-2.62	4.77	2.15	0.51	2.66	29.29	Pass
	161	5805	-1.94	4.77	2.83	0.51	3.34	29.29	Pass
2	149	5745	-4.74	4.77	0.03	0.51	0.54	29.29	Pass
	157	5785	-4.10	4.77	0.67	0.51	1.18	29.29	Pass
	161	5805	-3.63	4.77	1.14	0.51	1.65	29.29	Pass

NOTE:

- Method 1 of power density measurement of KDB 662911 is using for calculating total power density. Total power density is summing entire spectra across corresponding frequency bins on the various outputs by computer.
- Directional gain = 1.94 dBi + 10log(3) = 6.71 dBi > 6 dBi , so the power density limit shall be reduced to 30-(6.71-6) = 29.29 dBm.
- Refer to section 3.3 for duty cycle spectrum plot.

802.11n (HT40)

TX Chain	Channel	Frequency (MHz)	PSD (dBm/500 kHz)	10 log (N=3) dB	Total PSD without Duty Factor (dBm/500 kHz)	Duty Factor	Total PSD with Duty Factor (dBm/500 kHz)	Limit (dBm/500 kHz)	Pass / Fail
0	151	5755	-6.60	4.77	-1.83	1.33	-0.50	29.29	Pass
	159	5795	-5.28	4.77	-0.51	1.33	0.82	29.29	Pass
1	151	5755	-5.81	4.77	-1.04	1.33	0.29	29.29	Pass
	159	5795	-4.52	4.77	0.25	1.33	1.58	29.29	Pass
2	151	5755	-10.13	4.77	-5.36	1.33	-4.03	29.29	Pass
	159	5795	-7.55	4.77	-2.78	1.33	-1.45	29.29	Pass

NOTE:

- Method 1 of power density measurement of KDB 662911 is using for calculating total power density. Total power density is summing entire spectra across corresponding frequency bins on the various outputs by computer.
- Directional gain = 1.94 dBi + 10log(3) = 6.71 dBi > 6 dBi , so the power density limit shall be reduced to 30-(6.71-6) = 29.29 dBm.
- Refer to section 3.3 for duty cycle spectrum plot.

802.11ac (VHT80)

TX Chain	Channel	Frequency (MHz)	PSD (dBm/500 kHz)	10 log (N=3) dB	Total PSD without Duty Factor (dBm/500 kHz)	Duty Factor	Total PSD with Duty Factor (dBm/500 kHz)	Limit (dBm/500 kHz)	Pass / Fail
0	155	5775	-15.80	4.77	-11.03	2.10	-8.93	29.29	Pass
1	155	5775	-14.18	4.77	-9.41	2.10	-7.31	29.29	Pass
2	155	5775	-17.32	4.77	-12.55	2.10	-10.45	29.29	Pass

NOTE:

- Method 1 of power density measurement of KDB 662911 is using for calculating total power density. Total power density is summing entire spectra across corresponding frequency bins on the various outputs by computer.
- Directional gain = 1.94 dBi + 10log(3) = 6.71 dBi > 6 dBi , so the power density limit shall be reduced to 30-(6.71-6) = 29.29 dBm.
- Refer to section 3.3 for duty cycle spectrum plot.

Spectrum Plot of Worst Value

802.11a

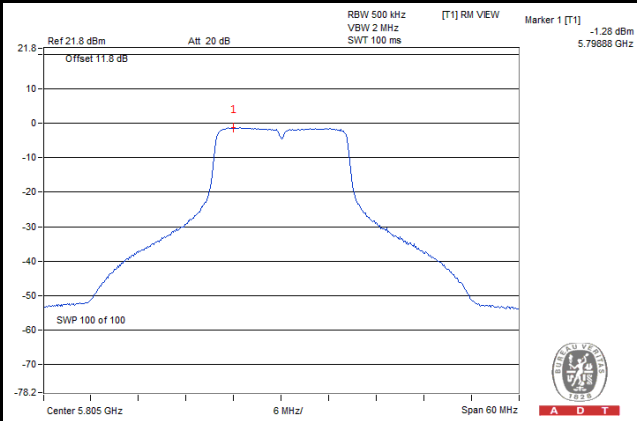

802.11n (HT20)

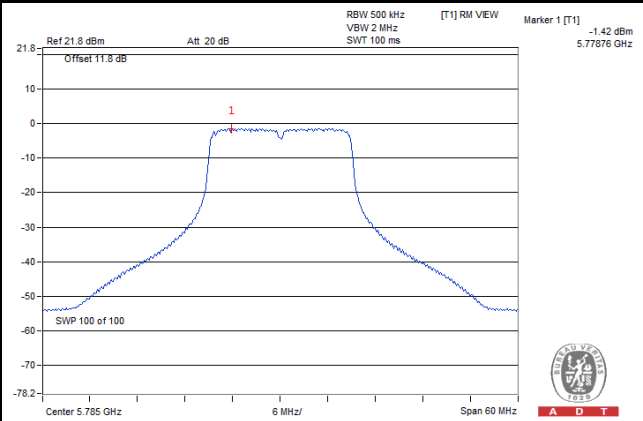

802.11n (HT40)

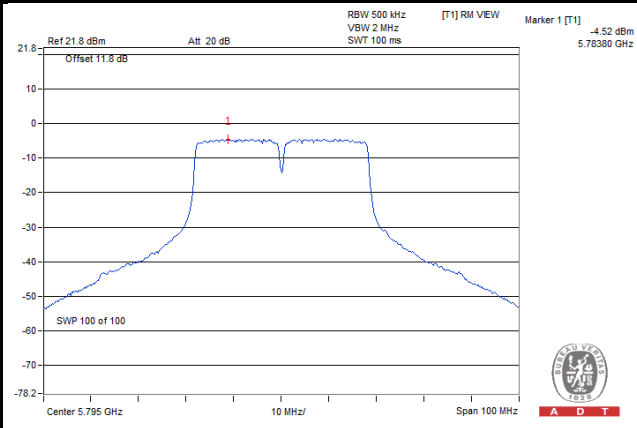

802.11ac (VHT80)

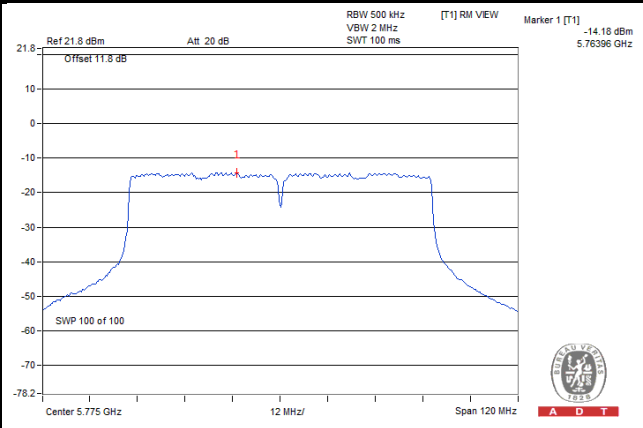

4.5 Frequency Stability

4.5.1 Limit of Frequency Stability Measurement

The frequency of the carrier signal shall be maintained within band of operation

4.5.2 Test Setup

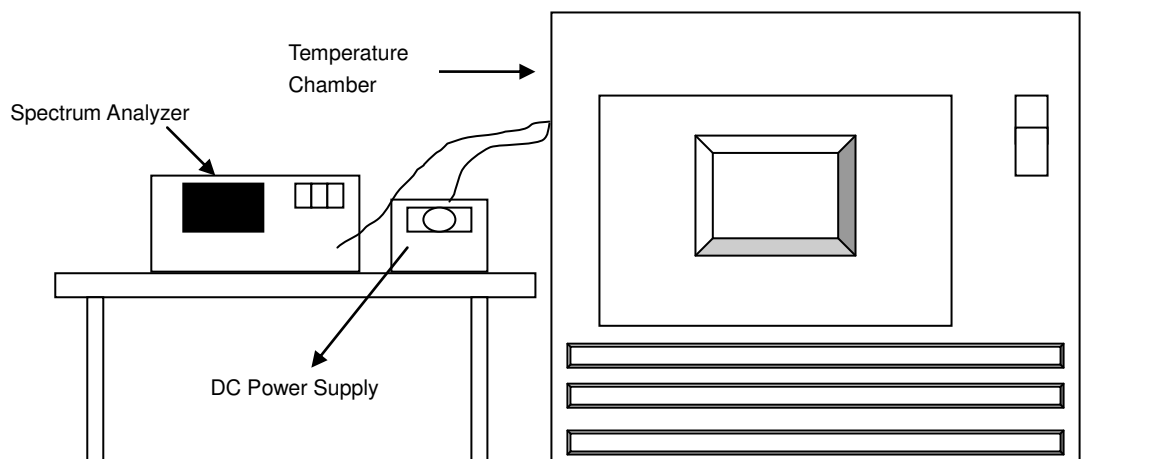

4.5.3 Test Instruments

Refer to section 4.1.3 to get information of above instrument.

4.5.4 Test Procedure

- To ensure emission at the band edge is maintained within the authorized band, those values shall be measured by radiation emissions at upper and lower frequency points, and finally compensated by frequency deviation as procedures below.
- The EUT was operated at the maximum output power, and connected to the spectrum analyzer, which is set to maximum hold function and peak detector. The peak value of the power envelope was measured and noted. The upper and lower frequency points were respectively measured relatively 10 dB lower than the measured peak value.
- The frequency deviation was calculated by adding the upper frequency point and the lower frequency point divided by two. Those detailed values of frequency deviation are provided in table below.

4.5.5 Deviation from Test Standard

No deviation.

4.5.6 EUT Operating Condition

Set the EUT transmit at un-modulation mode to test frequency stability.

4.5.7 Test Results

Mode A

Frequency Stability Versus Temp.									
Operating Frequency: 5180 MHz									
Temp. (°C)	Power Supply (Vdc)	0 Minute		2 Minute		5 Minute		10 Minute	
		Measured Frequency (MHz)	Frequency Drift (ppm)	Measured Frequency (MHz)	Frequency Drift (ppm)	Measured Frequency (MHz)	Frequency Drift (ppm)	Measured Frequency (MHz)	Frequency Drift (ppm)
50	3.3	5180.032620	6.297	5180.033323	6.433	5180.033208	6.411	5180.032586	6.291
40	3.3	5180.032839	6.340	5180.032781	6.328	5180.032913	6.354	5180.032953	6.362
30	3.3	5180.034400	6.641	5180.033848	6.534	5180.034167	6.596	5180.034509	6.662
20	3.3	5180.034806	6.719	5180.034773	6.713	5180.035475	6.848	5180.035043	6.765
10	3.3	5180.036504	7.047	5180.036734	7.092	5180.036523	7.051	5180.036980	7.139
0	3.3	5180.035012	6.759	5180.035165	6.789	5180.035412	6.836	5180.034870	6.732
-10	3.3	5180.033514	6.470	5180.033302	6.429	5180.033726	6.511	5180.033767	6.519
-20	3.3	5180.033257	6.420	5180.033130	6.396	5180.033031	6.377	5180.033190	6.407
-30	3.3	5180.032357	6.247	5180.032354	6.246	5180.031722	6.124	5180.032023	6.182

Frequency Stability Versus Temp.									
Operating Frequency: 5180 MHz									
Temp. (°C)	Power Supply (Vdc)	0 Minute		2 Minute		5 Minute		10 Minute	
		Measured Frequency (MHz)	Frequency Drift (ppm)	Measured Frequency (MHz)	Frequency Drift (ppm)	Measured Frequency (MHz)	Frequency Drift (ppm)	Measured Frequency (MHz)	Frequency Drift (ppm)
20	2.8	5180.044947	8.677	5180.044567	8.604	5180.044424	8.576	5180.044850	8.658
	3.3	5180.034806	6.719	5180.034773	6.713	5180.035475	6.848	5180.035043	6.765
	3.8	5180.046255	8.930	5180.046300	8.938	5180.046374	8.953	5180.046734	9.022



Mode B

Frequency Stability Versus Temp.									
Operating Frequency: 5180 MHz									
Temp. (°C)	Power Supply (Vdc)	0 Minute		2 Minute		5 Minute		10 Minute	
		Measured Frequency (MHz)	Frequency Drift (ppm)	Measured Frequency (MHz)	Frequency Drift (ppm)	Measured Frequency (MHz)	Frequency Drift (ppm)	Measured Frequency (MHz)	Frequency Drift (ppm)
50	3.3	5180.032620	6.297	5180.033323	6.433	5180.033208	6.411	5180.032586	6.291
40	3.3	5180.032839	6.340	5180.032781	6.328	5180.032913	6.354	5180.032953	6.362
30	3.3	5180.034400	6.641	5180.033848	6.534	5180.034167	6.596	5180.034509	6.662
20	3.3	5180.034806	6.719	5180.034773	6.713	5180.035475	6.848	5180.035043	6.765
10	3.3	5180.036504	7.047	5180.036734	7.092	5180.036523	7.051	5180.036980	7.139
0	3.3	5180.035012	6.759	5180.035165	6.789	5180.035412	6.836	5180.034870	6.732
-10	3.3	5180.033514	6.470	5180.033302	6.429	5180.033726	6.511	5180.033767	6.519
-20	3.3	5180.033257	6.420	5180.033130	6.396	5180.033031	6.377	5180.033190	6.407
-30	3.3	5180.032357	6.247	5180.032354	6.246	5180.031722	6.124	5180.032023	6.182

Frequency Stability Versus Temp.									
Operating Frequency: 5180 MHz									
Temp. (°C)	Power Supply (Vdc)	0 Minute		2 Minute		5 Minute		10 Minute	
		Measured Frequency (MHz)	Frequency Drift (ppm)	Measured Frequency (MHz)	Frequency Drift (ppm)	Measured Frequency (MHz)	Frequency Drift (ppm)	Measured Frequency (MHz)	Frequency Drift (ppm)
20	2.8	5180.044947	8.677	5180.044567	8.604	5180.044424	8.576	5180.044850	8.658
	3.3	5180.034806	6.719	5180.034773	6.713	5180.035475	6.848	5180.035043	6.765
	3.8	5180.046255	8.930	5180.046300	8.938	5180.046374	8.953	5180.046734	9.022

4.6 6 dB Bandwidth Measurement

4.6.1 Limits of 6 dB Bandwidth Measurement

The minimum of 6 dB Bandwidth Measurement is 0.5 MHz.

4.6.2 Test Setup

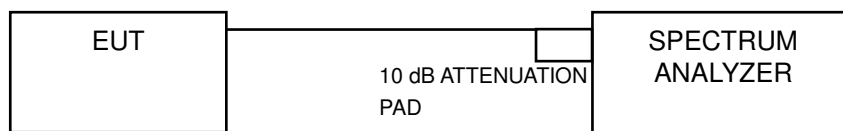

4.6.3 Test Instruments

Refer to section 4.1.3 to get information of above instrument.

4.6.4 Test Procedure

MEASUREMENT PROCEDURE REF

- Set resolution bandwidth (RBW) = 100 kHz
- Set the video bandwidth (VBW) $\geq 3 \times$ RBW, Detector = Peak.
- Trace mode = max hold.
- Sweep = auto couple.
- Measure the maximum width of the emission that is constrained by the frequencies associated with the two amplitude points (upper and lower) that are attenuated by 6 dB relative to the maximum level measured in the fundamental emission

4.6.5 Deviation from Test Standard

No deviation.

4.6.6 EUT Operating Condition

The software provided by client to enable the EUT under transmission condition continuously at lowest, middle and highest channel frequencies individually.

4.6.7 Test Results

Mode A

802.11a

Channel	Frequency (MHz)	6 dB Bandwidth (MHz)			Minimum Limit (MHz)	Pass / Fail
		Chain 0	Chain 1	Chain 2		
149	5745	16.37	16.38	16.41	0.5	Pass
157	5785	16.37	16.38	16.38	0.5	Pass
161	5805	16.37	16.38	16.38	0.5	Pass

802.11n (HT20)

Channel	Frequency (MHz)	6 dB Bandwidth (MHz)			Minimum Limit (MHz)	Pass / Fail
		Chain 0	Chain 1	Chain 2		
149	5745	17.57	17.63	17.60	0.5	Pass
157	5785	17.57	17.19	17.60	0.5	Pass
161	5805	17.56	17.59	17.61	0.5	Pass

802.11n (HT40)

Channel	Frequency (MHz)	6 dB Bandwidth (MHz)			Minimum Limit (MHz)	Pass / Fail
		Chain 0	Chain 1	Chain 2		
151	5755	36.06	36.43	36.38	0.5	Pass
159	5795	36.09	36.40	36.38	0.5	Pass

802.11ac (VHT80)

Channel	Frequency (MHz)	6 dB Bandwidth (MHz)			Minimum Limit (MHz)	Pass / Fail
		Chain 0	Chain 1	Chain 2		
155	5775	76.10	76.55	76.54	0.5	Pass

Spectrum Plot of Worst Value

802.11a

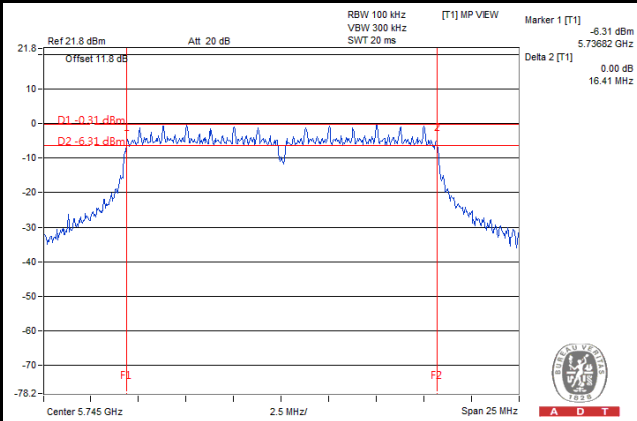

802.11n (HT20)

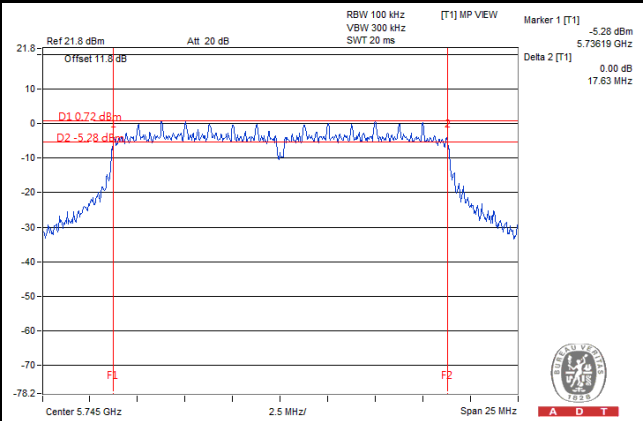

802.11n (HT40)

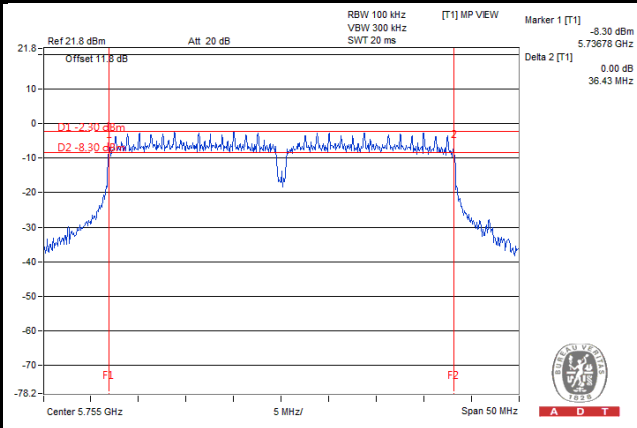

802.11ac (VHT80)

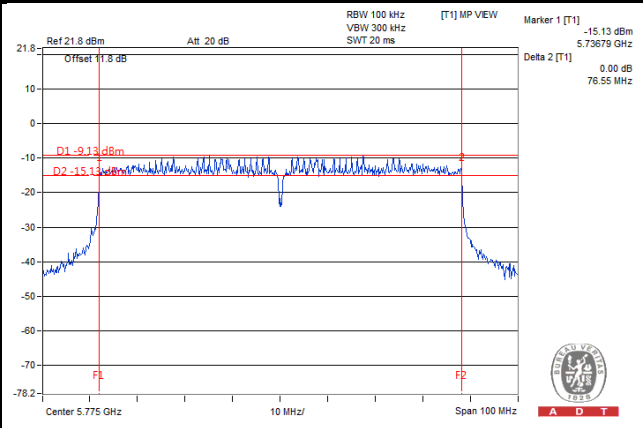

Mode B
802.11a

Channel	Frequency (MHz)	6 dB Bandwidth (MHz)			Minimum Limit (MHz)	Pass / Fail
		Chain 0	Chain 1	Chain 2		
149	5745	16.37	16.38	16.41	0.5	Pass
157	5785	16.37	16.38	16.38	0.5	Pass
161	5805	16.37	16.38	16.38	0.5	Pass

802.11n (HT20)

Channel	Frequency (MHz)	6 dB Bandwidth (MHz)			Minimum Limit (MHz)	Pass / Fail
		Chain 0	Chain 1	Chain 2		
149	5745	17.59	17.63	17.60	0.5	Pass
157	5785	17.57	17.19	17.60	0.5	Pass
161	5805	17.56	17.59	17.61	0.5	Pass

802.11n (HT40)

Channel	Frequency (MHz)	6 dB Bandwidth (MHz)			Minimum Limit (MHz)	Pass / Fail
		Chain 0	Chain 1	Chain 2		
151	5755	36.39	36.43	36.01	0.5	Pass
159	5795	36.09	36.40	36.38	0.5	Pass

802.11ac (VHT80)

Channel	Frequency (MHz)	6 dB Bandwidth (MHz)			Minimum Limit (MHz)	Pass / Fail
		Chain 0	Chain 1	Chain 2		
155	5775	76.10	76.55	76.54	0.5	Pass

Spectrum Plot of Worst Value

802.11a

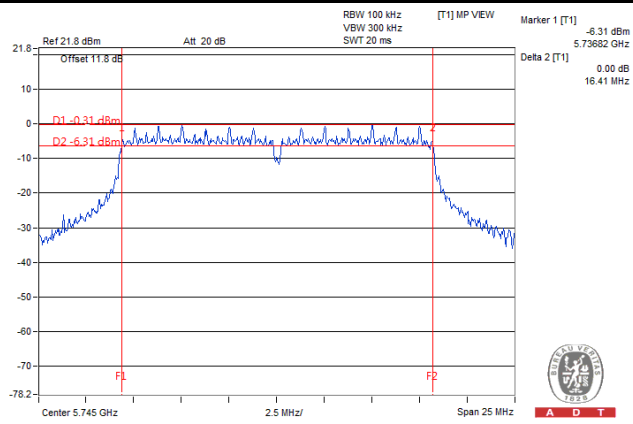

802.11n (HT20)

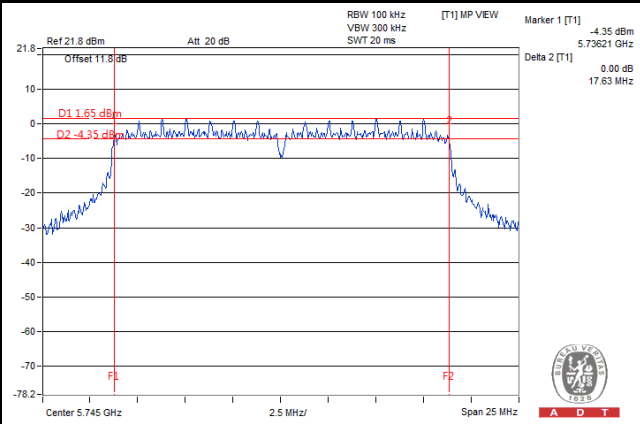

802.11n (HT40)

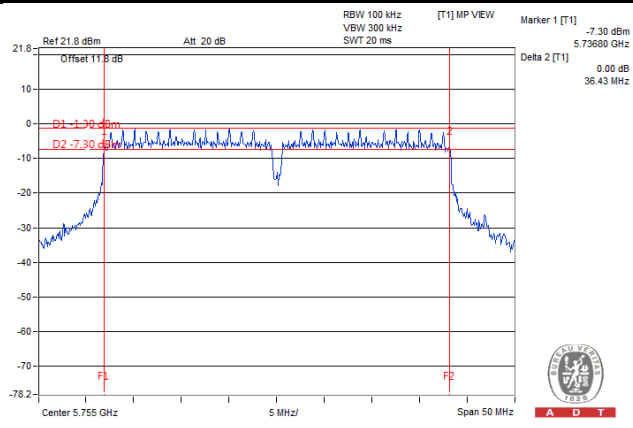

802.11ac (VHT80)

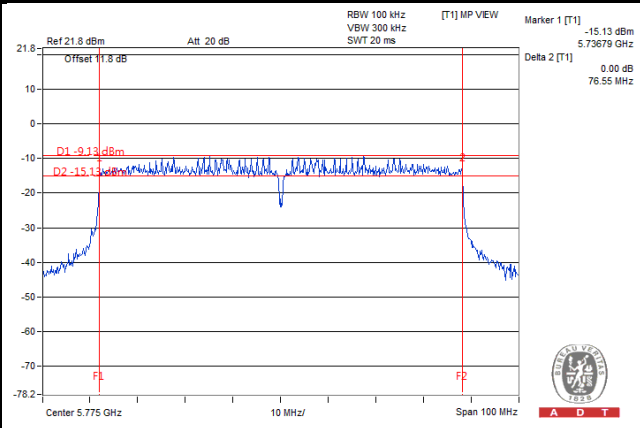



5 Pictures of Test Arrangements

Please refer to the attached file (Test Setup Photo).



A D T

Appendix – Information on the Testing Laboratories

We, Bureau Veritas Consumer Products Services (H.K.) Ltd., Taoyuan Branch, were founded in 1988 to provide our best service in EMC, Radio, Telecom and Safety consultation. Our laboratories are accredited and approved according to ISO/IEC 17025.

If you have any comments, please feel free to contact us at the following:

Linko EMC/RF Lab

Tel: 886-2-26052180

Fax: 886-2-26051924

Hsin Chu EMC/RF/Telecom Lab

Tel: 886-3-6668565

Fax: 886-3-6668323

Hwa Ya EMC/RF/Safety

Tel: 886-3-3183232

Fax: 886-3-3270892

Email: service.adt@tw.bureauveritas.com

Web Site: www.bureauveritas-adt.com

The address and road map of all our labs can be found in our web site also.

--- END ---