



FCC TEST REPORT

**Test report
On Behalf of
LITTLE WING TECHNOLOGIES CORP.
For
Wireless keyboard
Model No.: JW9851, JW9851+YES,
W9851, K9851, W9891, JW9891
FCC ID: YHA-JW9851**

Prepared for : LITTLE WING TECHNOLOGIES CORP.
3F-1, No. 36, Lane 118, Yi-An Road, 235 Zhonghe District, New Taipei City,
Taiwan, R.O.C.

Prepared By : Shenzhen HUAKE Testing Technology Co., Ltd.
F1-008, Tai Yi Building, No.1, Haicheng West Road, Xixiang Street, Bao'an
District, Shenzhen City, China

Date of Test: Jun. 27, 2017 ~ Jul. 04, 2017

Date of Report: Jul. 04, 2017

Report Number: HUAKE170627274-E



TEST RESULT CERTIFICATION

Applicant's name : LITTLE WING TECHNOLOGIES CORP.
Address : 3F-1, No. 36, Lane 118, Yi-An Road, 235 Zhonghe District, New Taipei City, Taiwan, R.O.C.
Manufacture's Name : GUANGZHOU JINGSHENG TECHNOLOGY DEVELOPMENT CO., LTD.
Address : Suite 102, 64 Tianhe Road East, Guangzhou 510630, P.R.China

Product description

Trade Mark: N/A
Product name : Wireless keyboard
Model and/or type reference : JW9851, JW9851+YES, W9851, K9851, W9891, JW9891
Standards : FCC Rules and Regulations Part 15 Subpart C Section 15.249
 ANSI C63.10: 2013

This device described above has been tested by HUAKE, and the test results show that the equipment under test (EUT) is in compliance with Part 15 of FCC Rules. And it is applicable only to the tested sample identified in the report.

This report shall not be reproduced except in full, without the written approval of HUAKE, this document may be altered or revised by HUAKE, personal only, and shall be noted in the revision of the document.

Date of Test..... :
Date (s) of performance of tests..... : Jun. 27, 2017 ~ Jul. 04, 2017
Date of Issue : Jul. 04, 2017
Test Result : **Pass**

Testing Engineer : Eric Xie
 (Eric Xie)

Technical Manager : Dora Qin
 (Dora Qin)

Authorized Signatory : Kait Chen
 (Kait Chen)



Table of Contents	Page
1 . TEST SUMMARY	4
2 . GENERAL INFORMATION	5
2.1 GENERAL DESCRIPTION OF EUT	5
2.2 Operation of EUT during testing	6
2.3 DESCRIPTION OF TEST SETUP	6
2.4 MEASUREMENT INSTRUMENTS LIST	7
3 . CONDUCTED EMISSIONS TEST	8
3.1 Conducted Power Line Emission Limit	8
3.2 Test Setup	8
3.3 Test Procedure	8
3.4 Test Result	8
4 RADIATED EMISSION TEST	9
4.1 Radiation Limit	9
4.2 Test Setup	9
4.3 Test Procedure	10
4.4 Test Result	10
5 BAND EDGE	16
5.1 Limits	16
5.2 Test Procedure	16
5.3 Test Result	16
6 OCCUPIED BANDWIDTH MEASUREMENT	18
6.1 Test Setup	18
6.2 Test Procedure	18
6.3 Measurement Equipment Used	18
6.4 Test Result	18
7 ANTENNA REQUIREMENT	20
8 PHOTOGRAPH OF TEST	21
8.1 Radiated Emission	21



1. TEST SUMMARY

1.1 TEST PROCEDURES AND RESULTS

DESCRIPTION OF TEST	RESULT
CONDUCTED EMISSIONS TEST	N/A
RADIATED EMISSION TEST	COMPLIANT
BAND EDGE	COMPLIANT
OCCUPIED BANDWIDTH MEASUREMENT	COMPLIANT
ANTENNA REQUIREMENT	COMPLIANT

1.2 TEST FACILITY

Test Firm : QTC Certification & Testing Co., Ltd.
Certificated by FCC, Registration No.: 588523
Address 2nd Floor,B1 Building,Fengyeyuan Industrial Plant, Liuxian 2st. Road,
Xin'an Street, Bao'an District, Shenzhen, China

1.3 MEASUREMENT UNCERTAINTY

Measurement Uncertainty	
Conducted Emission Expanded Uncertainty	= 2.23dB, k=2
Radiated emission expanded uncertainty(9kHz-30MHz)	= 3.08dB, k=2
Radiated emission expanded uncertainty(30MHz-1000MHz)	= 4.42dB, k=2
Radiated emission expanded uncertainty(Above 1GHz)	= 4.06dB, k=2



2. GENERAL INFORMATION

2.1 GENERAL DESCRIPTION OF EUT

Equipment	Wireless keyboard
Model Name	JW9851
Serial Model	JW9851+YES, W9851, K9851, W9891, JW9891
Model Difference	All model's the function, software and electric circuit are the same, only with a product appearance and model named different. Test sample model: JW9851.
FCC ID	YHA-JW9851
Antenna Type	PCB Antenna
Antenna Gain	0 dBi
BT Operation frequency	2405-2472MHz
Number of Channels	68CH
Modulation Type	GFSK
Power Source	DC1.5V from battery
Power Rating	DC1.5V from battery



2.1.1 Carrier Frequency of Channels

Channel List					
Channel	Frequency (MHz)	Channel	Frequency (MHz)	Channel	Frequency (MHz)
01	2405	25	2429	49	2453
02	2406	26	2430	50	2454
03	2407	27	2431	51	2455
04	2408	28	2432	52	2456
05	2409	29	2433	53	2457
06	2410	30	2434	54	2458
07	2411	31	2435	55	2459
08	2412	32	2436	56	2460
09	2413	33	2437	57	2461
10	2414	34	2438	58	2462
11	2415	35	2439	59	2463
12	2416	36	2440	60	2464
13	2417	37	2441	61	2465
14	2418	38	2442	62	2466
15	2419	39	2443	63	2467
16	2420	40	2444	64	2468
17	2421	41	2445	65	2469
18	2422	42	2446	66	2470
19	2423	43	2447	67	2471
20	2424	44	2448	68	2472
21	2425	45	2449		
22	2426	46	2450		
23	2427	47	2451		
24	2428	48	2452		

2.2 Operation of EUT during testing

Operating Mode

The mode is used: **Transmitting mode**

Low Channel: 2405MHz

Middle Channel: 2448MHz

High Channel: 2472MHz

2.3 DESCRIPTION OF TEST SETUP

Operation of EUT during Radiation testing:





2.4 MEASUREMENT INSTRUMENTS LIST

Item	Equipment	Manufacturer	Model No.	Serial No.	Cal Date	Due Date
1.	EMI Receiver	Rohde & Schwarz	ESCI	100627	Feb. 18, 2017	Feb. 17, 2018
2.	LISN	SchwarzBeck	NSLK 8126	8126377	Feb. 18, 2017	Feb. 17, 2018
3.	RF Switching Unit	Compliance Direction	RSU-M2	38303	Feb. 18, 2017	Feb. 17, 2018
4.	EMI Test Software ES-K1	Rohde & Schwarz	N/A	N/A	N/A	N/A
5.	EMI Test Receiver	Rohde & Schwarz	ESCI	100627	Feb. 18, 2017	Feb. 17, 2018
6.	Trilog Broadband Antenna	Schwarzbeck	VULB9163	VULB 9163-289	Feb. 18, 2017	Feb. 17, 2018
7.	Pre-amplifier	Compliance Direction	PAP-0203	22008	Feb. 18, 2017	Feb. 17, 2018
8.	EMI Test Software EZ-EMC	SHURPLE	N/A	N/A	N/A	N/A
9.	EMI Receiver	Rohde & Schwarz	ESCI	100627	Feb. 18, 2017	Feb. 17, 2018
10.	LISN	SchwarzBeck	NSLK 8126	8126377	Feb. 18, 2017	Feb. 17, 2018
11.	RF Switching Unit	Compliance Direction	RSU-M2	38303	Feb. 18, 2017	Feb. 17, 2018
12.	EMI Test Software ES-K1	Rohde & Schwarz	N/A	N/A	N/A	N/A
13.	EMI Receiver	Rohde & Schwarz	ESCI	100627	Feb. 18, 2017	Feb. 17, 2018
14.	EMI Receiver	Rohde & Schwarz	ESCI	100627	Feb. 18, 2017	Feb. 17, 2018
15.	LISN	SchwarzBeck	NSLK 8126	8126377	Feb. 18, 2017	Feb. 17, 2018
16.	RF Switching Unit	Compliance Direction	RSU-M2	38303	Feb. 18, 2017	Feb. 17, 2018
17.	EMI Test Software ES-K1	Rohde & Schwarz	N/A	N/A	N/A	N/A
18.	Power Meter	R&S	NRVD	SEL0069	Feb. 18, 2017	Feb. 17, 2018
19.	Power Sensor	R&S	URV5-Z2	SEL0071	Feb. 18, 2017	Feb. 17, 2018
20.	Power Sensor	R&S	URV5-Z2	SEL0072	Feb. 18, 2017	Feb. 17, 2018
21.	Software EMC32	R&S	EMC32-S	SEL0082	N/A	N/A
22.	Log-periodic Antenna	Amplifier Reasearch	APT1.580	SEL0073	Feb. 18, 2017	Feb. 17, 2018
23.	Loop Antenna	Schwarz beck	FMZB 1516	9773	Feb. 18, 2017	Feb. 17, 2018
24.	Broadband Antenna	Schwarz beck	VULB9163	9163-333	Feb. 18, 2017	Feb. 17, 2018
25.	Horn Antenna	ETS	3117	00086197	Feb. 18, 2017	Feb. 17, 2018
26.	Horn Antenna	Schwarzbeck	BBHA9170	BBHA91705 82	Feb. 18, 2017	Feb. 17, 2018
27.	Antenna Tripod	Amplifier Reasearch	TP1000A	SEL0074	Feb. 18, 2017	Feb. 17, 2018
28.	High Gain Horn Antenna	Amplifier Reasearch	AT4002A	SEL0075	Feb. 18, 2017	Feb. 17, 2018
29.	Spectrum analyzer	Agilent	N9020A	MY49911004 8	Feb. 18, 2017	Feb. 17, 2018
30.	Spectrum analyzer	Agilent	E4407B	MY46184326	Feb. 18, 2017	Feb. 17, 2018
31.	Spectrum analyzer	R&S	FSP30	836079/035	Feb. 18, 2017	Feb. 17, 2018



3. CONDUCTED EMISSIONS TEST

3.1 Conducted Power Line Emission Limit

For unintentional device, according to § 15.107(a) Line Conducted Emission Limits is as following

Frequency (MHz)	Maximum RF Line Voltage (dB μ V)			
	CLASS A		CLASS B	
	Q.P.	Ave.	Q.P.	Ave.
0.15 - 0.50	79	66	66-56*	56-46*
0.50 - 5.00	73	60	56	46
5.00 - 30.0	73	60	60	50

* Decreasing linearly with the logarithm of the frequency

For intentional device, according to §15.207(a) Line Conducted Emission Limit is same as above table.

3.2 Test Setup

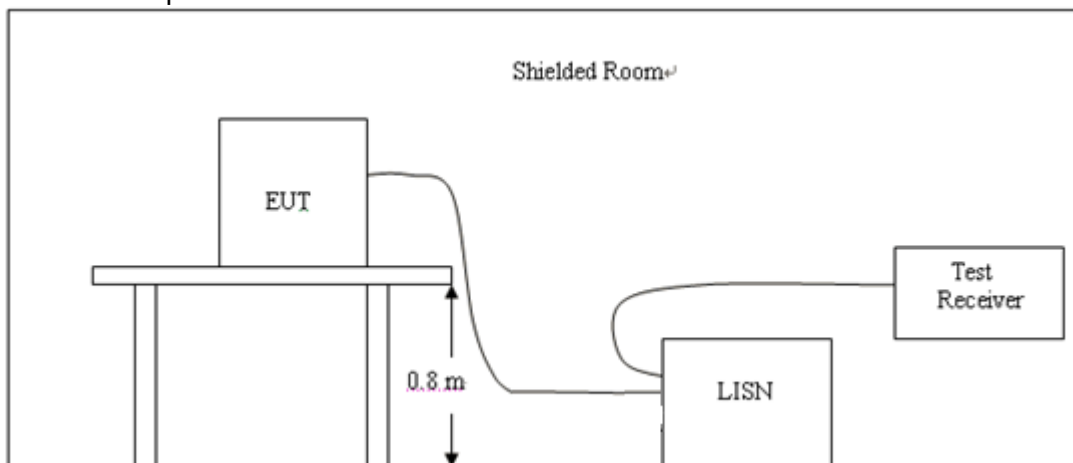

3.3 Test Procedure

- 1, The equipment was set up as per the test configuration to simulate typical actual usage per the user's manual. The EUT is a tabletop system, a wooden table with a height of 0.1 meters is used and is placed on the ground plane as per ANSI C63.10.
- 2, Support equipment, if needed, was placed as per ANSI C63.10.
- 3, All I/O cables were positioned to simulate typical actual usage as per ANSI C63.10.
- 4, If a EUT received DC power from the USB Port of Notebook PC, the PC's adapter received AC120V/60Hz power through a Line Impedance Stabilization Network (LISN) which supplied power source and was grounded to the ground plane.
- 5, All support equipments received AC power from a second LISN, if any.
- 6, The EUT test program was started. Emissions were measured on each current carrying line of the EUT using a spectrum Analyzer / Receiver connected to the LISN powering the EUT. The LISN has two monitoring points: Line 1 (Hot Side) and Line 2 (Neutral Side). Two scans were taken: one with Line 1 connected to Analyzer / Receiver and Line 2 connected to a 50 ohm load; the second scan had Line 1 connected to a 50 ohm load and Line 2 connected to the Analyzer / Receiver.
- 7, Analyzer / Receiver scanned from 150 KHz to 30MHz for emissions in each of the test modes.

3.4 Test Result

N/A

EUT power supply by battery, so this test item not applicable.

4 RADIATED EMISSION TEST

4.1 Radiation Limit

For unintentional device, according to § 15.109(a), except for Class A digital devices, the field strength of radiated emissions from unintentional radiators at a distance of 3 meters shall not exceed the following values:

Frequency (MHz)	Distance (Meters)	Radiated (dB μ V/m)	Radiated (μ V/m)
30-88	3	40	100
88-216	3	43.5	150
216-960	3	46	200
Above 960	3	54	500

For intentional device, according to § 15.209(a), the general requirement of field strength of radiated emissions from intentional radiators at a distance of 3 meters shall not exceed the above table.

4.2 Test Setup

(1) Radiated Emission Test-Up Frequency Below 30MHz

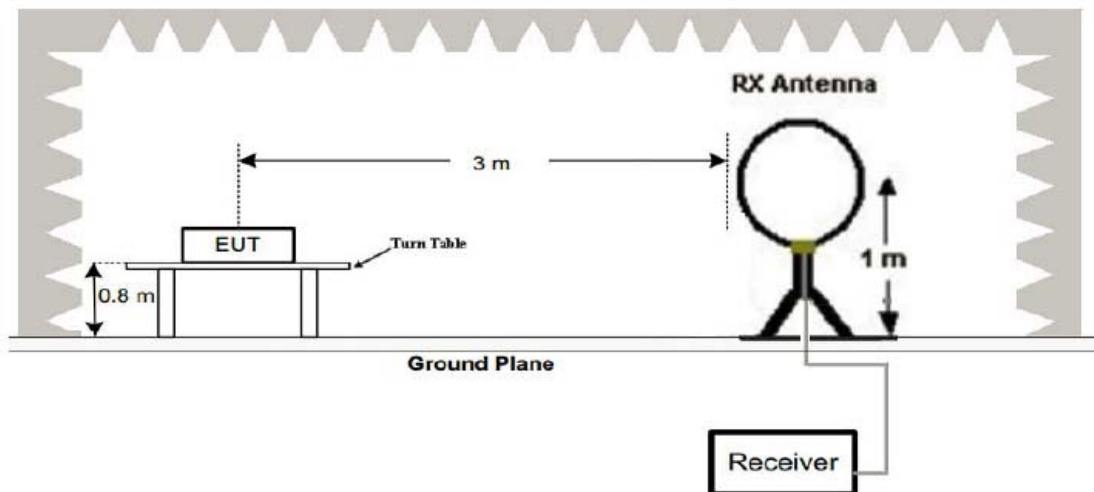

(2) Radiated Emission Test-Up Frequency 30MHz~1GHz

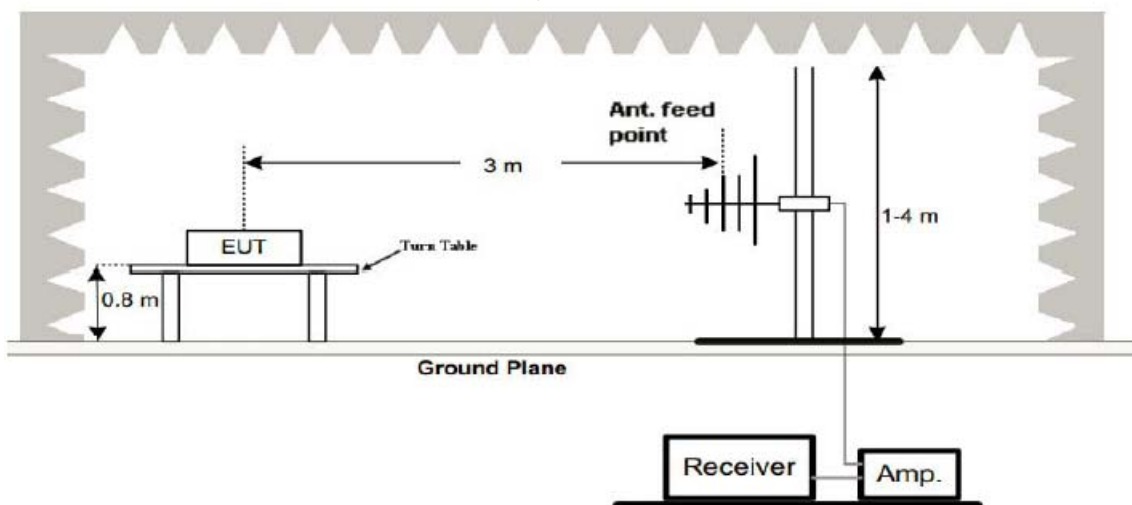

(3) Radiated Emission Test-Up Frequency Above 1GHz

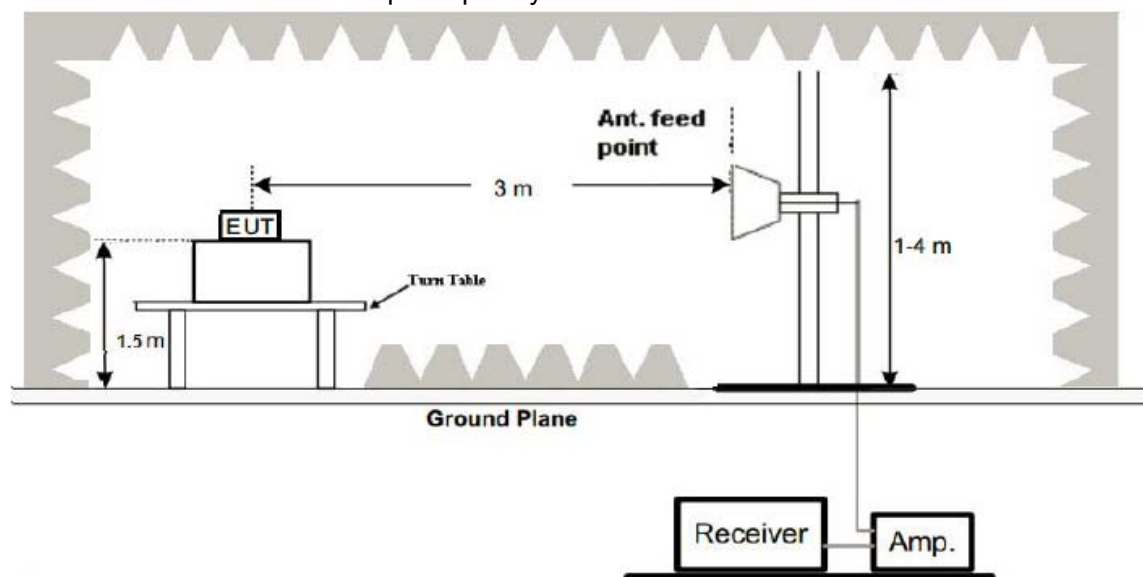

4.3 Test Procedure

1. Below 1GHz measurement the EUT is placed on turntable which is 0.1m above ground plane. And above 1GHz measurement EUT was placed on low permittivity and low tangent turn table which is 1.5m above ground plane.
2. The turntable shall be rotated for 360 degrees to determine the position of maximum emission level.
3. EUT is set 3m away from the receiving antenna, which is varied from 1m to 4m to find out the highest emissions.
4. Maximum procedure was performed on the six highest emissions to ensure EUT compliance.
5. And also, each emission was to be maximized by changing the polarization of receiving antenna both horizontal and vertical.
6. Repeat above procedures until the measurements for all frequencies are complete.
7. The test frequency range from 9KHz to 25GHz per FCC PART 15.33(a).

Note:

For battery operated equipment, the equipment tests shall be performed using a new battery.

4.4 Test Result

PASS

All the test modes completed for test. The worst case of Radiated Emission is CH 2405; the test data of this mode was reported.



Below 1GHz Test Results:
Antenna polarity: H

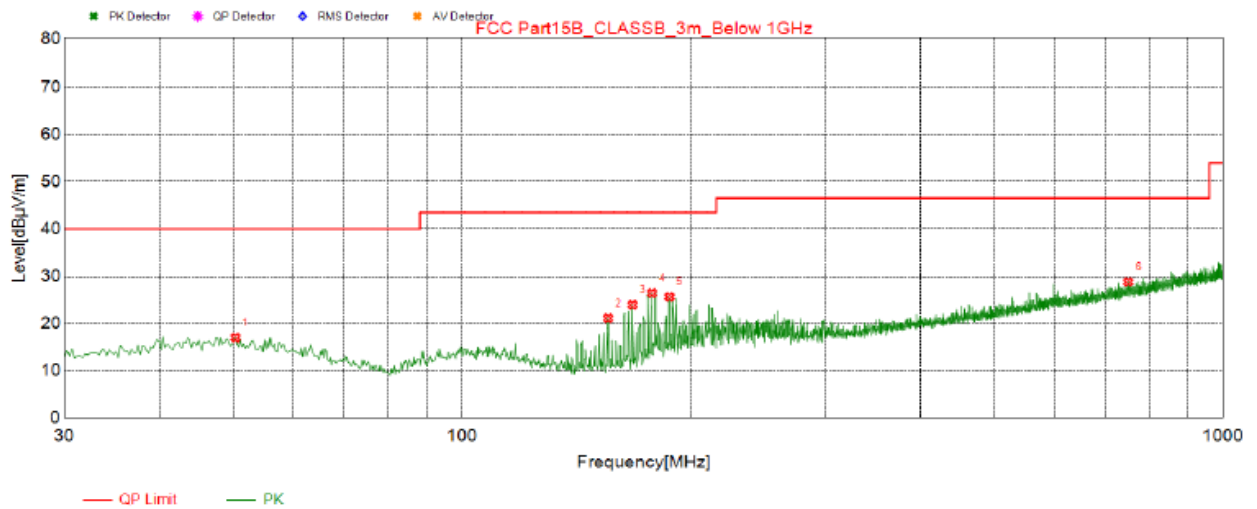

Suspected List								
NO.	Freq. [MHz]	Result Level [dBµV]	Factor [dB]	Limit [dBµV/m]	Margin [dB]	Height [cm]	Angle [°]	Polarity
1	50.370	16.99	-14.24	40.00	23.01	100	0	Horizontal
2	155.61	21.11	-18.86	43.50	22.39	100	199	Horizontal
3	167.49	23.95	-18.23	43.50	19.55	100	222	Horizontal
4	177.68	26.43	-17.60	43.50	17.07	100	214	Horizontal
5	187.38	25.63	-16.72	43.50	17.87	100	203	Horizontal
6	750.71	28.8	-3.61	46.50	17.70	100	245	Horizontal



Antenna polarity: V

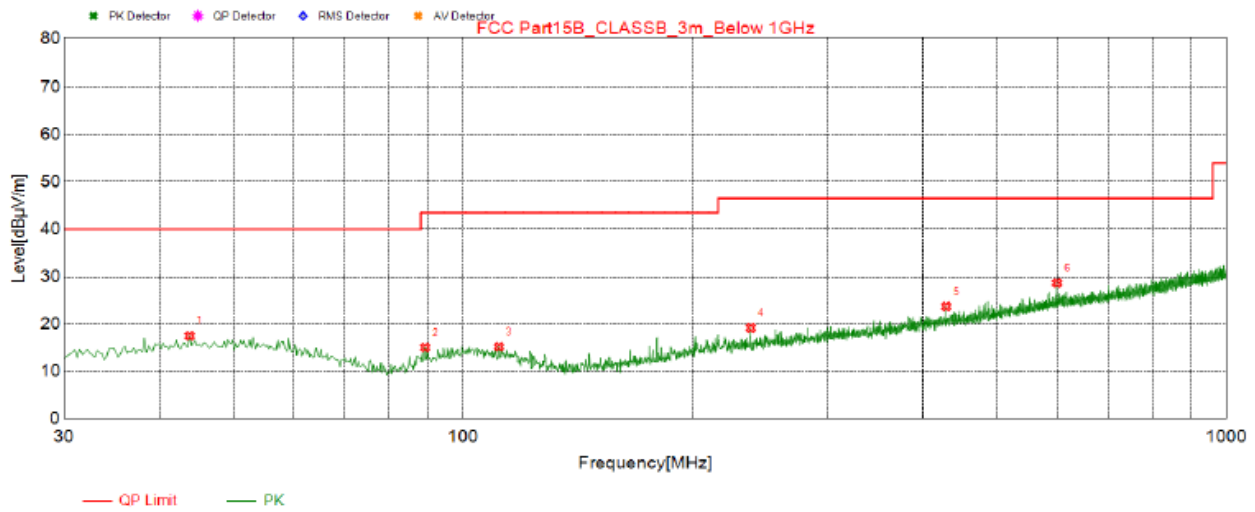

Suspected List								
NO.	Freq. [MHz]	Result Level [dBµV]	Factor [dB]	Limit [dBµV/m]	Margin [dB]	Height [cm]	Angle[°]	Polarity
1	43.823	17.48	-14.09	40.00	22.52	100	183	Vertical
2	89.170	15.05	-17.88	43.50	28.45	100	116	Vertical
3	111.48	15.19	-16.25	43.50	28.31	100	149	Vertical
4	238.06	19.17	-14.24	46.50	27.33	100	134	Vertical
5	429.39	23.69	-9.45	46.50	22.81	100	45	Vertical
6	600.11	28.65	-5.59	46.50	17.85	100	186	Vertical

Remark:

- (1) Measuring frequencies from 9 KHz to the 1 GHz, Radiated emission test from 9KHz to 30MHz was verified, and no any emission was found except system noise floor.
- (2) * denotes emission frequency which appearing within the Restricted Bands specified in provision of 15.205, then the general radiated emission limits in 15.209 apply.
- (3) The IF bandwidth of EMI Test Receiver between 30MHz to 1GHz was 120KHz, 1 MHz for measuring above 1 GHz, below 30MHz was 10KHz.



Above 1 GHz Test Results:

CH Low (2405MHz)
Horizontal:

Frequency	Meter Reading	Factor	Emission Level	Limits	Margin	Detector Type
(MHz)	(dBμV)	(dB)	(dBμV/m)	(dBμV/m)	(dB)	
2405	112.43	-5.84	106.59	114	-7.41	peak
2405	83.69	-5.84	77.85	94	-16.15	AVG
4810	55.24	-3.64	51.6	74	-22.4	peak
4810	45.76	-3.64	42.12	54	-11.88	AVG
7215	52.18	-0.95	51.23	74	-22.77	peak
7215	40.52	-0.95	39.57	54	-14.43	AVG
---	---	---	---	---	---	---
---	---	---	---	---	---	---

Remark: Factor = Antenna Factor + Cable Loss – Pre-amplifier.

Vertical:

Frequency	Meter Reading	Factor	Emission Level	Limits	Margin	Detector Type
(MHz)	(dBμV)	(dB)	(dBμV/m)	(dBμV/m)	(dB)	
2405	111.34	-5.84	105.5	114	-8.5	peak
2405	83.27	-5.84	77.43	94	-16.57	AVG
4810	55.02	-3.64	51.38	74	-22.62	peak
4810	41.46	-3.64	37.82	54	-16.18	AVG
7215	53.85	-0.95	52.9	74	-21.1	peak
7215	40.31	-0.95	39.36	54	-14.64	AVG
---	---	---	---	---	---	---
---	---	---	---	---	---	---

Remark: Factor = Antenna Factor + Cable Loss – Pre-amplifier.



CH Middle (2448MHz)

Horizontal:

Frequency (MHz)	Meter Reading (dB μ V)	Factor (dB)	Emission Level (dB μ V/m)	Limits (dB μ V/m)	Margin (dB)	Detector Type
2448	110.18	-5.71	104.47	114	-9.53	peak
2448	83.54	-5.71	77.83	94	-16.17	AVG
4896	55.35	-3.51	51.84	74	-22.16	peak
4896	42.61	-3.51	39.1	54	-14.9	AVG
7344	52.74	-0.82	51.92	74	-22.08	peak
7344	39.06	-0.82	38.24	54	-15.76	AVG
---	---	---	---	---	---	---
---	---	---	---	---	---	---

Remark: Factor = Antenna Factor + Cable Loss – Pre-amplifier.

Vertical:

Frequency (MHz)	Meter Reading (dB μ V)	Factor (dB)	Emission Level (dB μ V/m)	Limits (dB μ V/m)	Margin (dB)	Detector Type
2448	109.21	-5.71	103.5	114	-10.5	peak
2448	83.54	-5.71	77.83	94	-16.17	AVG
4896	54.67	-3.51	51.16	74	-22.84	peak
4896	42.73	-3.51	39.22	54	-14.78	AVG
7344	51.08	-0.82	50.26	74	-23.74	peak
7344	37.55	-0.82	36.73	54	-17.27	AVG
---	---	---	---	---	---	---
---	---	---	---	---	---	---

Remark: Factor = Antenna Factor + Cable Loss – Pre-amplifier.



CH High (2472MHz)

Horizontal:

Frequency	Meter Reading	Factor	Emission Level	Limits	Margin	Detector Type
(MHz)	(dBμV)	(dB)	(dBμV/m)	(dBμV/m)	(dB)	
2472	108.41	-5.65	102.76	114	-11.24	peak
2472	83.25	-5.65	77.6	94	-16.4	AVG
4944	53.78	-3.43	50.35	74	-23.65	peak
4944	41.53	-3.43	38.1	54	-15.9	AVG
7416	52.66	-0.75	51.91	74	-22.09	peak
7416	37.04	-0.75	36.29	54	-17.71	AVG
---	---	---	---	---	---	---
---	---	---	---	---	---	---

Remark: Factor = Antenna Factor + Cable Loss – Pre-amplifier.

Vertical:

Frequency	Meter Reading	Factor	Emission Level	Limits	Margin	Detector Type
(MHz)	(dBμV)	(dB)	(dBμV/m)	(dBμV/m)	(dB)	
2472	106.92	-5.65	101.27	114	-12.73	peak
2472	82.56	-5.65	76.91	94	-17.09	AVG
4944	52.43	-3.43	49	74	-25	peak
4944	41.27	-3.43	37.84	54	-16.16	AVG
7416	52.64	-0.75	51.89	74	-22.11	peak
7416	37.83	-0.75	37.08	54	-16.92	AVG
---	---	---	---	---	---	---
---	---	---	---	---	---	---

Remark: Factor = Antenna Factor + Cable Loss – Pre-amplifier.

Remark:

- (1) Measuring frequencies from 1 GHz to the 25 GHz.
- (2) "F" denotes fundamental frequency; "H" denotes spurious frequency. "E" denotes band edge frequency.
- (3) * denotes emission frequency which appearing within the Restricted Bands specified in provision of 15.205, then the general radiated emission limits in 15.209 apply.
- (4) Data of measurement within this frequency range shown "---" in the table above means the reading of emissions are attenuated more than 20dB below the permissible limits or the field strength is too small to be measured.
- (5) The IF bandwidth of EMI Test Receiver between 30MHz to 1GHz was 120KHz, 1 MHz for measuring above 1 GHz, below 30MHz was 10KHz.
- (6) When the test results of Peak Detected below the limits of Average Detected, the Average Detected is not need completed. For example: Top Channel at Fundamental 73.16dBuV/m(PK Value) <93.98(AV Limit), at harmonic 53.20 dBuV/m(PK Value) <54 dBuV/m(AV Limit), the Average Detected not need to completed.



5 BAND EDGE

5.1 Limits

FCC PART 15.249(d) Emissions radiated outside of the specified frequency bands, except for harmonics, shall be attenuated by at least 50 dB below the level of the fundamental or to the general radiated emission limits in §15.209, whichever is the lesser attenuation.

5.2 Test Procedure

The band edge compliance of RF radiated emission should be measured by following the guidance in ANSI C63.10 with respect to maximizing the emission by rotating the EUT, measuring the emission while the EUT is situated in three orthogonal planes (if appropriate), adjusting the measurement antenna height and polarization etc. Set RBW to 100KHz and VBM to 300KHz to measure the peak field strength and set RBW to 1MHz and VBW to 10Hz to measure the average radiated field strength. The conducted RF band edge was measured by using a spectrum analyzer. Set span wide enough to capture the highest in-band emission and the emission at the band edge. Set RBW to 100 KHz and VBW to 300 KHz, to measure the conducted peak band edge.

5.3 Test Result

PASS

Radiated Band Edge Test:
 Operation Mode: TX CH Low (2405MHz)
 Horizontal (Worst case)

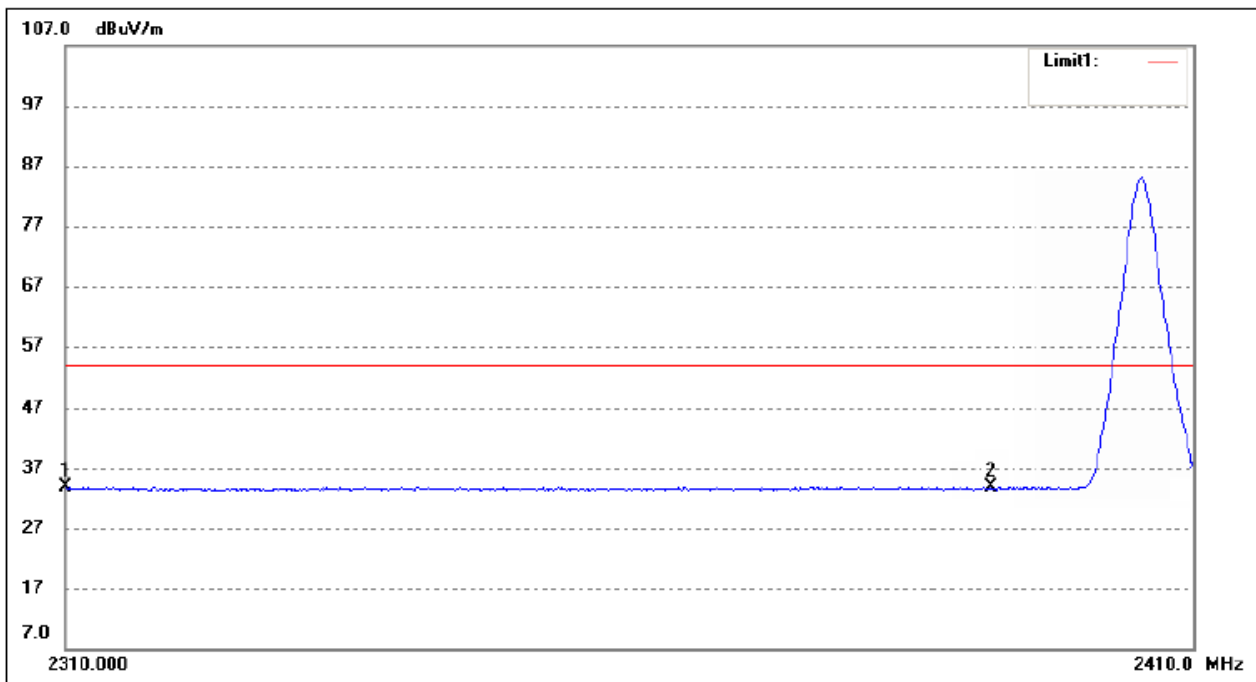

No.	Frequency (MHz)	Reading (dBuV/m)	Correct Factor(dB)	Result (dBuV/m)	Limit (dBuV/m)	Margin (dB)	Remark
1	2310.00	35.43	-2.01	33.33	54.00	-20.67	Average Detector
	2310.00	47.25	-2.01	45.24	74.00	-28.76	Peak Detector
2	2390.00	35.68	-1.75	33.93	54.00	-20.07	Average Detector
	2390.00	46.23	-1.75	44.48	74.00	-29.52	Peak Detector



Operation Mode: TX CH High (2472MHz)

Horizontal (Worst case)

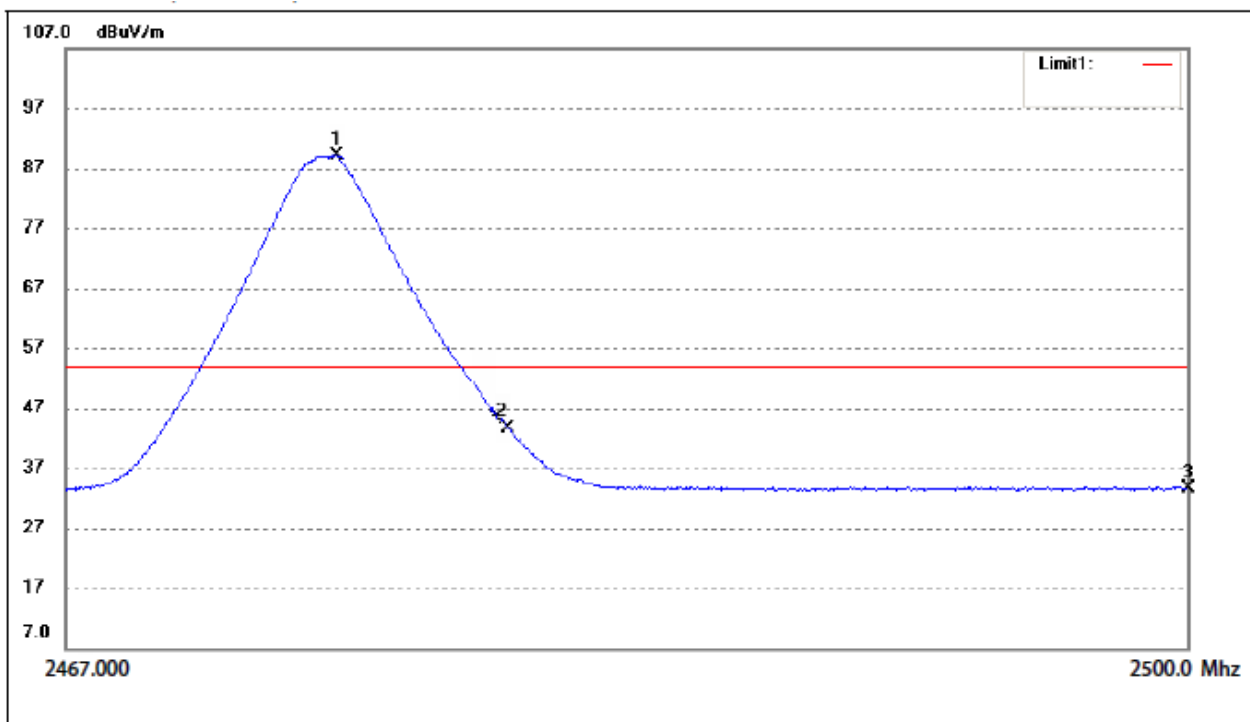

No.	Frequency (MHz)	Reading (dBuV/m)	Correct (dB/m)	Result (dBuV/m)	Limit (dBuV/m)	Margin (dB)	Remark
1	2472.15	90.68	-1.06	89.62	/	/	Average Detector
	2471.94	94.42	-1.06	93.36	/	/	Peak Detector
2	2483.50	46.53	-1.21	45.32	54.00	-8.68	Average Detector
	2483.50	52.27	-1.21	51.06	74.00	-22.94	Peak Detector
3	2500.00	34.11	-0.88	33.23	54.00	-20.77	Average Detector
	2500.00	46.64	-0.88	45.76	74.00	-28.24	Peak Detector



6 OCCUPIED BANDWIDTH MEASUREMENT

6.1 Test Setup

Same as Radiated Emission Measurement

6.2 Test Procedure

1. The EUT was placed on a turn table which is 0.8m above ground plane.
2. Set EUT as normal operation.
3. Based on FCC Part15 C Section 15.249(a): RBW= 50KHz. VBW= 200 KHz, Span=3MHz.
4. The useful radiated emission from the EUT was detected by the spectrum analyser with peak detector.

6.3 Measurement Equipment Used

Same as Radiated Emission Measurement

6.4 Test Result

PASS

Frequency	20dB Bandwidth (KHz)	Result
2405 MHz	1450	PASS
2448 MHz	2194	PASS
2472 MHz	2236	PASS

CH: 2405MHz





CH: 2448MHz



CH: 2472MHz





7 ANTENNA REQUIREMENT

Standard Applicable

For intentional device, according to FCC 47 CFR Section 15.203, an intentional radiator shall be designed to ensure that no antenna other than that furnished by the responsible party shall be used with the device. And according to FCC 47 CFR Section 15.249, if transmitting antennas of directional gain greater than 6dBi are used, the power shall be reduced by the amount in dB that the directional gain of the antenna exceeds 6dBi.

Refer to statement below for compliance.

The manufacturer may design the unit so that the user can replace a broken antenna, but the use of a standard antenna jack or electrical connector is prohibited. Further, this requirement does not apply to intentional radiators that must be professionally installed.

Antenna Connected Construction

The antenna used in this product is a PCB Antenna, The directional gains of antenna used for transmitting is 0dBi.

ANTENNA

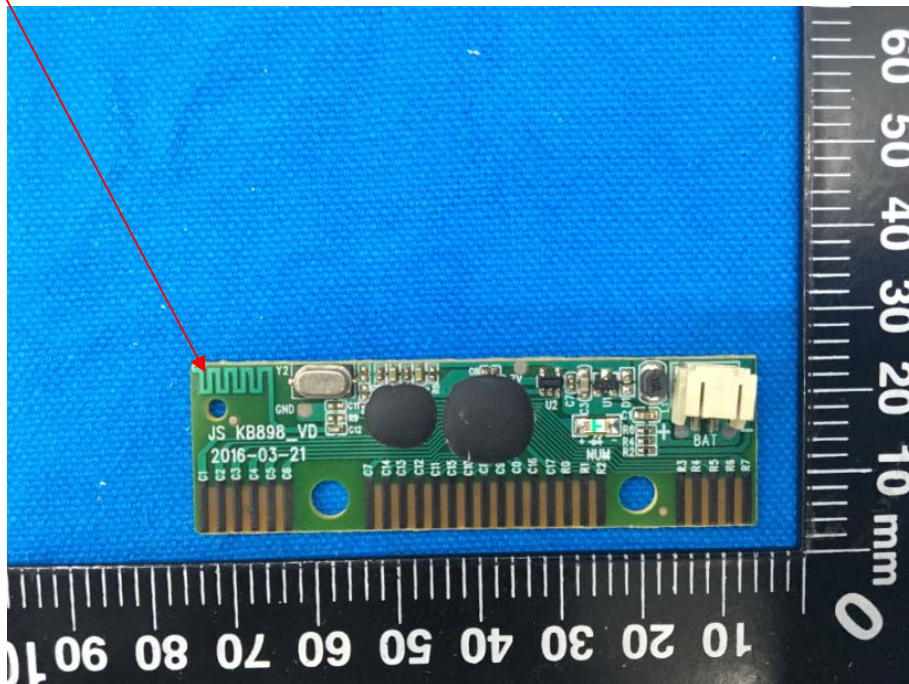

8 PHOTOGRAPH OF TEST

8.1 Radiated Emission

