



TEST REPORT

FCC Part 15.247

Report Reference No.....: CTL1401100056-WF

Compiled by

(position+printed name+signature) .: File administrators Jacky Chen

Name of the organization performing the tests

Test Engineer Tracy Qi

(position+printed name+signature) .:

Approved by

(position+printed name+signature) .: Manager Tracy Qi

Date of issue.....: Jan. 22, 2014

Test Firm.....: Shenzhen CTL Testing Technology Co., Ltd.

Address: Floor 1-A, Baisha Technology Park, No.3011, Shahehexi Road, Nanshan District, Shenzhen, China 518055

Applicant's name.....: Kobian Canada Inc

Address: 560 Denison Street, Unit #5, Markham, Ontario, L3R 2M8, Canada

Test specification:

Standard: FCC Part 15.247: Operation within the bands 902–928 MHz, 2400–2483.5 MHz, and 5725–5850 MHz.

TRF Originator.....: Shenzhen CTL Testing Technology Co., Ltd.

Master TRF.....: Dated 2014-01

Shenzhen CTL Testing Technology Co., Ltd. All rights reserved.

This publication may be reproduced in whole or in part for non-commercial purposes as long as the Shenzhen CTL Testing Technology Co., Ltd.. is acknowledged as copyright owner and source of the material. Shenzhen CTL Testing Technology Co., Ltd. takes no responsibility for and will not assume liability for damages resulting from the reader's interpretation of the reproduced material due to its placement and context.

Test item description: HS-9DTB13-8GB

FCC ID.....: YH5-9DTB13

Trade Mark: Hipstreet

Model/Type reference: HS-9DTB13-8GB

Work frequency: 802.11b/g/n: 2412~2462MHz, 802.11n(40MHz): 2422~2452

Type of modulation.....: 802.11b DSSS, 802.11g/n: OFDM

Data Rate: 802.11b: 1/2/5.5/11 Mbps, 802.11g: 6/9/12/18/24/36/48/54 Mbps
802.11n: up to 150 Mbps

Antenna Gain: -0.5 dBi

Antenna type: Internal

Result: Positive

TEST REPORT

Test Report No. :	CTL1401100056-WF	Jan. 22, 2014
		Date of issue

Equipment under Test : **HS-9DTB13-8GB**

Model /Type : HS-9DTB13-8GB

Applicant : **Kobian Canada Inc**

Address : 560 Denison Street, Unit #5, Markham, Ontario, L3R 2M8, Canada

Manufacturer : **Wing Ming Electronics Limited**

Address : Suite 1306, A Block, Tianan Building, Renmin South Road, Luohu, Shenzhen, China

Test Result according to the standards on page 4:	Positive
--	-----------------

The test report merely corresponds to the test sample.
It is not permitted to copy extracts of these test result without the written permission of the test laboratory.

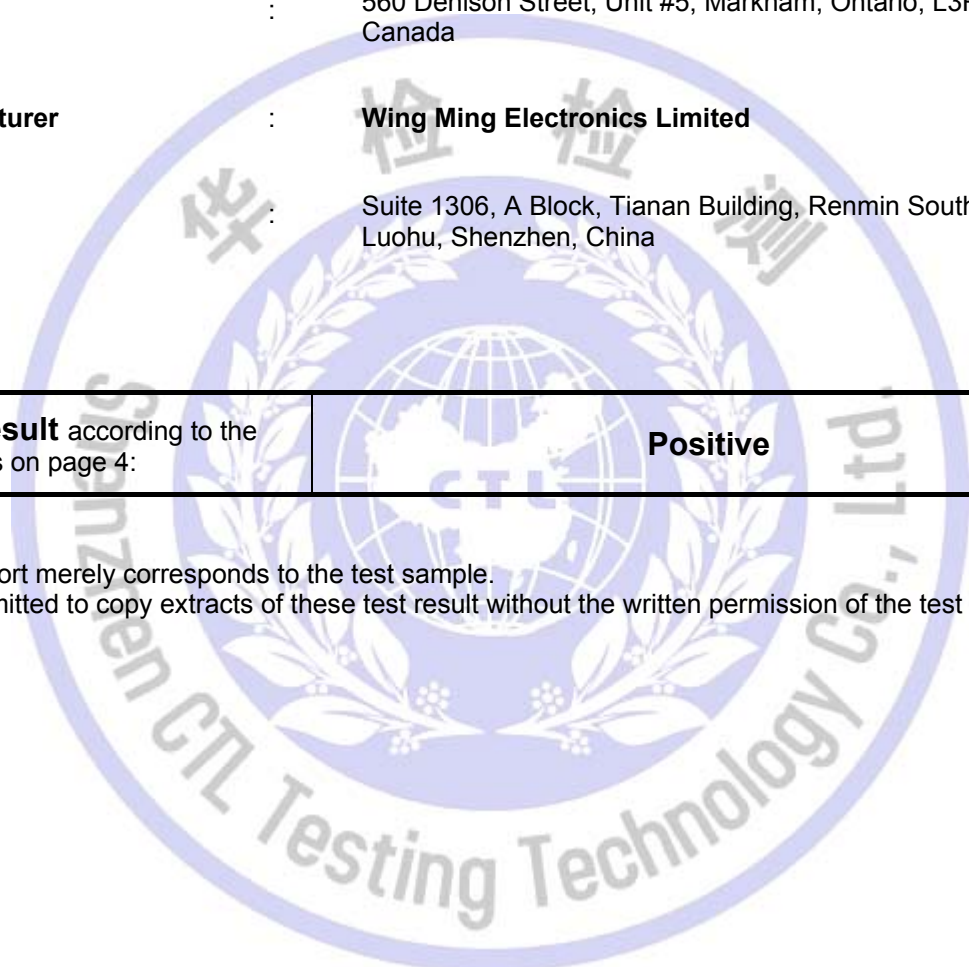

Contents

1.	<u>TEST STANDARDS</u>	4
2.	<u>SUMMARY</u>	5
2.1.	General Remarks	5
2.2.	Equipment Under Test	5
2.3.	Short description of the Equipment under Test (EUT)	5
2.4.	EUT operation mode	5
2.5.	EUT configuration	6
2.6.	NOTE	6
2.7.	Related Submittal(s) / Grant (s)	6
2.8.	Modifications	6
3.	<u>TEST ENVIRONMENT</u>	7
3.1.	Address of the test laboratory	7
3.2.	Test Facility	7
3.3.	Environmental conditions	7
3.4.	Configuration of Tested System	7
3.5.	Statement of the measurement uncertainty	8
3.6.	Equipments Used during the Test	8
3.7.	Summary of Test Result	9
4.	<u>TEST CONDITIONS AND RESULTS</u>	10
4.1.	Conducted Emissions Test	10
4.2.	Radiated Emission Test	13
4.3.	6dB Bandwidth Measurement	21
4.4.	Maximum Peak Output Power	30
4.5.	Band Edge Measurement	31
4.6.	Power Spectral Density Measurement	48
4.7.	Spurious RF Conducted Emission	57
4.8.	Operation Frequency Range of 20dB Bandwidth	65
4.9.	Antenna Requirement	70
4.10.	RF Exposure	71
5.	<u>TEST SETUP PHOTOS OF THE EUT</u>	72
6.	<u>EXTERNAL AND INTERNAL PHOTOS OF THE EUT</u>	74

1. TEST STANDARDS

The tests were performed according to following standards:

[FCC Part 15.247](#): Frequency Hopping, Direct Spread Spectrum and Hybrid Systems that are in operation within the bands of 902-928 MHz, 2400-2483.5 MHz, and 5725-5850 MHz.

[ANSI C63.10-2009](#): American National Standard for Testing Unlicensed Wireless Devices.

[ANSI C63.4-2009](#)

[KDB Publication No. 558074 D01 v03r01 Guidance on Measurements for Digital Transmission Systems](#)



2. SUMMARY

2.1. General Remarks

Date of receipt of test sample	:	Jan. 16, 2014
Testing commenced on	:	Jan. 17, 2014
Testing concluded on	:	Jan. 21, 2014

2.2. Equipment Under Test

Power supply system utilised

Power supply voltage	:	<input checked="" type="radio"/> 120V / 60 Hz	<input type="radio"/> 115V / 60Hz
		<input type="radio"/> 12 V DC	<input type="radio"/> 24 V DC
		<input checked="" type="radio"/> Other (specified in blank below)	

DC 3.7V from battery

Description of the test mode

IEEE 802.11b/g/n: Thirteen channels are provided to the EUT, but only eleventh channels used for USA.

Channel	Frequency(MHz)	Channel	Frequency(MHz)
1	2412	8	2447
2	2417	9	2452
3	2422	10	2457
4	2427	11	2462
5	2432		
6	2437		
7	2442		

2.3. Short description of the Equipment under Test (EUT)

The HS-9DTB13-8GB is a Tablet PC support wifi function.

For more details, refer to the user's manual of the EUT.

Serial number: Prototype

2.4. EUT operation mode

Test Mode:

- The EUT has been tested under normal operating condition.
- Test program used to control the EUT for staying in continuous transmitting and receiving mode is programmed. Channel low (2412MHz), mid (2442MHz) and high (2462MHz) with highest data rate are chosen for full testing.
- Test Mode:

Test Mode(TM)	Description	Remark
1	Transmitting	802.11 b
2	Transmitting	802.11 g
3	Transmitting	802.11 n HT20
4	Transmitting	802.11 n HT40

2.5. EUT configuration

The following peripheral devices and interface cables were connected during the measurement:

○ - supplied by the manufacturer

● - supplied by the lab

● Notebook PC

Manufacturer : DELL

Model No. : PP18L

2.6. NOTE

1. The EUT is an 802.11b/g/n Tablet PC, The functions of the EUT listed as below:

	Test Standards	Reference Report
WLAN 802.11b/g, 802.11n	FCC Part 15 Subpart C (Section15.247)	CTL1401100056-WF

2. The frequency bands used in this EUT are listed as follows:

Frequency Band(MHz)	2400-2483.5	5150-5350	5470-5725	5725-5850
802.11b	√	—	—	—
802.11g	√	—	—	—
802.11n(20MHz)	√	—	—	—
802.11n(40MHz)	√	—	—	—

3. The EUT incorporates a SISO function, Physically, the EUT provides two completed transmitter and two completed receivers.

Modulation Mode	TX Function
802.11b	1TX
802.11g	1TX
802.11n (20MHz)	1TX
802.11n (40MHz)	1TX

2.7. Related Submittal(s) / Grant (s)

This submittal(s) (test report) is intended for FCC ID: YH5-9DTB13 filing to comply with of the FCC Part 15.247 Rules.

2.8. Modifications

No modifications were implemented to meet testing criteria.

3. TEST ENVIRONMENT

3.1. Address of the test laboratory

Shenzhen CTL Testing Technology Co., Ltd.
 Floor 1-A, Baisha Technology Park, No. 3011, Shahehexi Road, Nanshan, Shenzhen 518055 China.

The sites are constructed in conformance with the requirements of ANSI C63.7, ANSI C63.4 (2009) and CISPR Publication 22.

3.2. Test Facility

The test facility is recognized, certified, or accredited by the following organizations:

IC Registration No.: 9618B

The 3m alternate test site of Shenzhen CTL Testing Technology Co., Ltd. EMC Laboratory has been registered by Certification and Engineer Bureau of Industry Canada for the performance of with Registration No.: 9618B on November 13, 2013.

FCC-Registration No.: 970318

Shenzhen CTL Testing Technology Co., Ltd. EMC Laboratory has been registered and fully described in a report filed with the (FCC) Federal Communications Commission. The acceptance letter from the FCC is maintained in our files. Registration 970318, December 19, 2013.

3.3. Environmental conditions

During the measurement the environmental conditions were within the listed ranges:

Temperature:	<u>15-35 ° C</u>
Humidity:	<u>30-60 %</u>
Atmospheric pressure:	<u>950-1050mbar</u>

3.4. Configuration of Tested System

Fig. 2-1 Configuration of Tested System

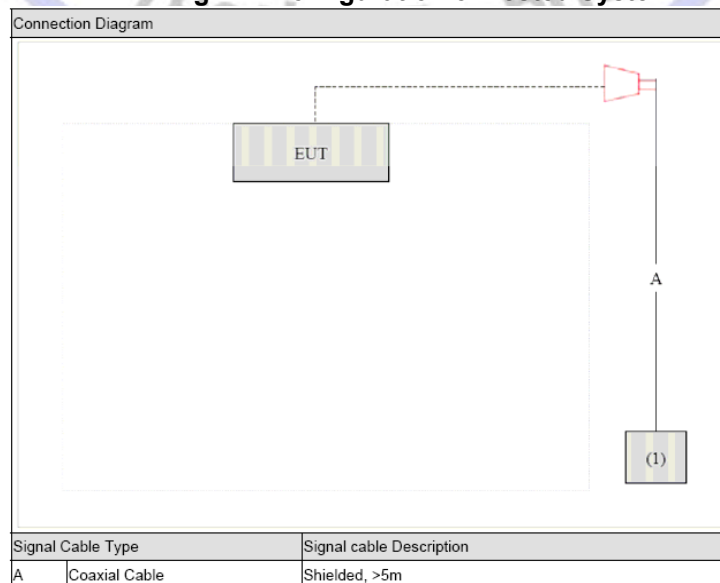

3.5. Statement of the measurement uncertainty

The data and results referenced in this document are true and accurate. The reader is cautioned that there may be errors within the calibration limits of the equipment and facilities. The measurement uncertainty was calculated for all measurements listed in this test report acc. to CISPR 16 - 4 „Specification for radio disturbance and immunity measuring apparatus and methods – Part 4: Uncertainty in EMC Measurements“ and is documented in the Shenzhen CTL Testing Technology Co., Ltd. quality system acc. to DIN EN ISO/IEC 17025. Furthermore, component and process variability of devices similar to that tested may result in additional deviation. The manufacturer has the sole responsibility of continued compliance of the device.

Hereafter the best measurement capability for CTL laboratory is reported:

Test	Range	Measurement Uncertainty	Notes
Radiated Emission	30~1000MHz	4.10dB	(1)
Radiated Emission	1~26.5GHz	4.32dB	(1)
Conducted Disturbance	0.15~30MHz	3.20dB	(1)

This uncertainty represents an expanded uncertainty expressed at approximately the 95% confidence level using a coverage factor of k=2.

3.6. Equipments Used during the Test

Test Equipment	Manufacturer	Model No.	Serial No.	Calibration Date	Calibration Due Date
Bilog Antenna	Sunol Sciences Corp.	JB1	A061713	2013/07/12	2014/07/11
EMI Test Receiver	R&S	ESCI	103710	2013/07/10	2014/07/09
Spectrum Analyzer	Agilent	E4407B	MY45108355	2013/07/06	2014/07/05
Controller	EM Electronics	Controller EM 1000	N/A	2013/07/06	2014/07/05
Horn Antenna	Sunol Sciences Corp.	DRH-118	A062013	2013/07/12	2014/07/11
Horn Antenna	SCHWARZBECK	BBHA9170	1562	2013/07/12	2014/07/11
Active Loop Antenna	SCHWARZBECK	FMZB1519	1519-037	2013/07/12	2014/07/11
LISN	R&S	ENV216	101316	2013/07/10	2014/07/09
LISN	SCHWARZBECK	NSLK8127	8127687	2013/07/10	2014/07/09
Microwave Preamplifier	HP	8349B	3155A00882	2013/07/10	2014/07/09
Amplifier	HP	8447D	3113A07663	2013/07/10	2014/07/09
Transient Limiter	Com-Power	LIT-153	532226	2013/07/10	2014/07/09
Radio Communication Tester	R&S	CMU200	3655A03522	2013/07/06	2014/07/05
Temperature/Humidity Meter	zhicheng	ZC1-2	22522	2013/07/10	2014/07/09
SIGNAL GENERATOR	HP	8647A	3200A00852	2013/07/10	2014/07/09
Wideband Peak Power Meter	Anritsu	ML2495A	220.23.35	2013/07/06	2014/07/05
Climate Chamber	ESPEC	EL-10KA	A20120523	2013/07/06	2014/07/05
High-Pass Filter	K&L	9SH10-2700/X12750-O/O	/	2013/07/06	2014/07/05
High-Pass Filter	K&L	41H10-1375/U12750-O/O	/	2013/07/06	2014/07/05

3.7. Summary of Test Result

FCC PART 15		
FCC Part 15.207	AC Power Conducted Emission	PASS
FCC Part 15.247(a)(2)	6dB Bandwidth	PASS
FCC Part 15.247(d)	Spurious RF Conducted Emission	PASS
FCC Part 15.247(b)	Maximum Peak Output Power	PASS
FCC Part 15.247(e)	Power Spectral Density	PASS
FCC Part 15.109/ 15.205/ 15.209	Radiated Emissions	PASS
FCC Part 15.247(d)	Band Edge Compliance of RF Emission	PASS
FCC Part 15.203/15.247 (b)	Antenna Requirement	PASS

Remark: The measurement uncertainty is not included in the test result.

Preliminary tests were performed in different data rate to find the worst radiated emission. The data rate shown in the table below is the worst-case rate with respect to the specific test item. Investigation has been done on all the possible configurations for searching the worst cases. The following table is a list of the test modes shown in this test report.

Test Items	Mode	Data Rate	Channel
AC Power Conducted Emission	Normal Link	11 Mbps	1
Maximum Peak Conducted Output Power Power Spectral Density 6dB Bandwidth Spurious RF conducted emission	11b/DSSS	11 Mbps	1/6/11
	11g/OFDM	54 Mbps	1/6/11
	11n(20MHz)/OFDM	65Mbps	1/6/11
	11n(40MHz)/OFDM	150Mbps	3/6/9
Radiated Emission 30MHz~1GHz	11b/DSSS	11 Mbps	1/6/11
	11g/OFDM	54 Mbps	1/6/11
	11n(20MHz)/OFDM	65Mbps	1/6/11
	11n(40MHz)/OFDM	150Mbps	3/6/9
Radiated Emission 1GHz~10th Harmonic	11b/DSSS	11 Mbps	1/6/11
	11g/OFDM	54 Mbps	1/6/11
	11n(20MHz)/OFDM	65Mbps	1/6/11
	11n(40MHz)/OFDM	150Mbps	3/6/9
Band Edge Compliance of RF Emission	11b/DSSS	11 Mbps	1/11
	11g/OFDM	54 Mbps	1/11
	11n(20MHz)/OFDM	65Mbps	1/11
	11n(40MHz)/OFDM	150Mbps	3/9

Note1: According exploratory test, EUT will have maximum output power in those data rate, so those data rate were used for all test.

4. TEST CONDITIONS AND RESULTS

4.1. Conducted Emissions Test

TEST CONFIGURATION

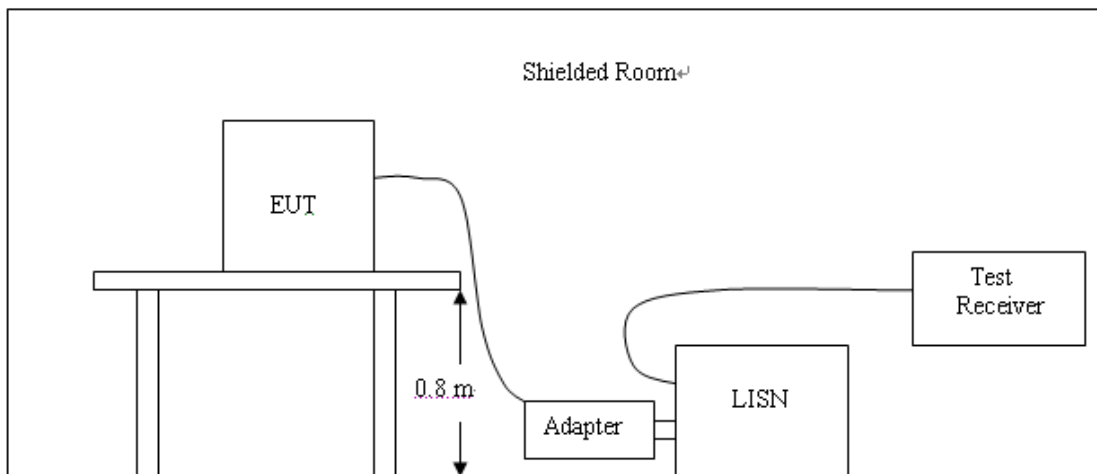

TEST PROCEDURE

For unintentional device, according to § 15.107(a) Line Conducted Emission Limits is as following:

Frequency (MHz)	Maximum RF Line Voltage (dB μ v)			
	CLASS A		CLASS B	
	Q.P.	Ave.	Q.P.	Ave.
0.15 - 0.50	79	66	66-56*	56-46*
0.50 - 5.00	73	60	56	46
5.00 - 30.0	73	60	60	50

* Decreasing linearly with the logarithm of the frequency

For intentional device, according to §15.207(a) Line Conducted Emission Limit is same as above table.

1. Please follow the guidelines in ANSI C63.4-2009.
2. The EUT was placed 0.4 meter from the conducting wall of the shielding room was kept at least 80 centimeters from any other grounded conducting surface.
3. Connect EUT to the power mains through a line impedance stabilization network (LISN).
4. All the support units are connecting to the other LISN.
5. The LISN provides 50 ohm coupling impedance for the measuring instrument.
6. The FCC states that a 50 ohm, 50 microhenry LISN should be used.
7. Both sides of AC line were checked for maximum conducted interference.
8. The frequency range from 150 kHz to 30 MHz was searched.
9. Set the test-receiver system to Peak Detect Function and specified bandwidth with Maximum Hold Mode.

The RBW/VBW for 150KHz to 30MHz: 9KHz

TEST RESULTS

SCAN TABLE: "Voltage (9K-30M) FIN"

Short Description: 150K-30M Voltage

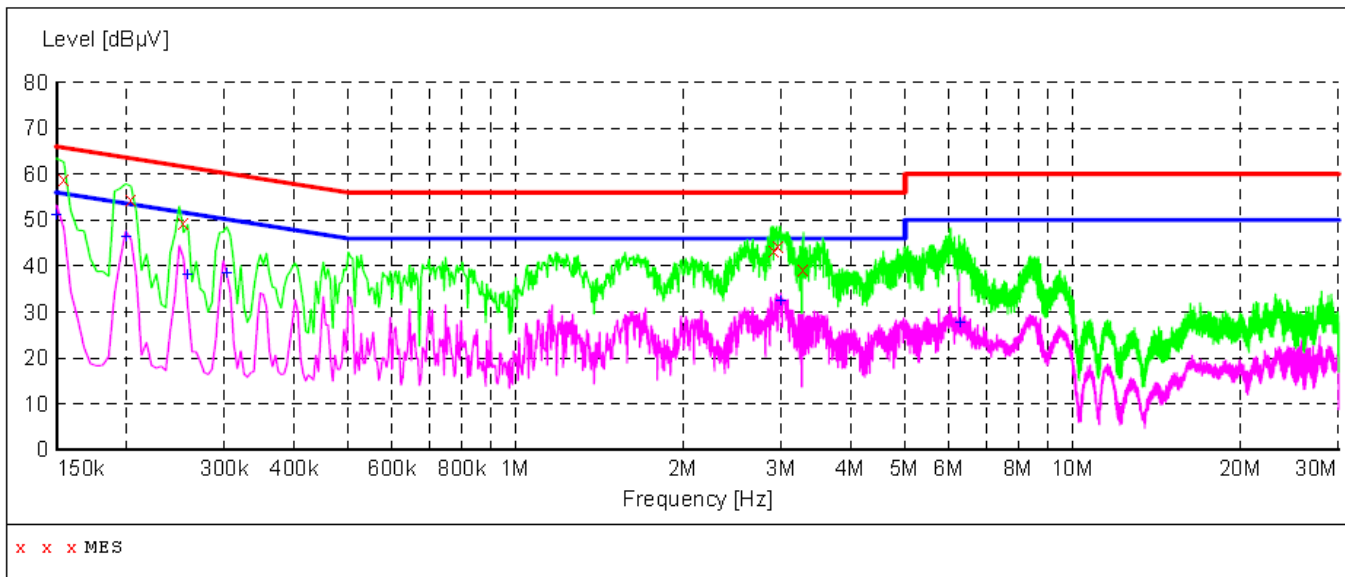

MEASUREMENT RESULT:

Frequency MHz	Level dBµV	Transd dB	Limit dBµV	Margin dB	Detector	Line	PE
0.154500	59.00	9.8	66	6.8	QP	L1	GND
0.204000	54.50	9.8	63	8.9	QP	L1	GND
0.253500	49.50	9.8	62	12.1	QP	L1	GND
2.904000	43.50	9.9	56	12.5	QP	L1	GND
2.962500	44.60	9.9	56	11.4	QP	L1	GND
3.286500	39.40	9.9	56	16.6	QP	L1	GND

MEASUREMENT RESULT:

Frequency MHz	Level dBµV	Transd dB	Limit dBµV	Margin dB	Detector	Line	PE
0.150000	51.20	9.8	56	4.8	AV	L1	GND
0.199500	46.30	9.8	54	7.3	AV	L1	GND
0.258000	38.10	9.8	52	13.4	AV	L1	GND
0.303000	38.40	9.8	50	11.8	AV	L1	GND
2.994000	32.30	9.9	46	13.7	AV	L1	GND
6.274500	27.50	10.0	50	22.5	AV	L1	GND

SCAN TABLE: "Voltage (9K-30M) FIN"

Short Description: 150K-30M Voltage

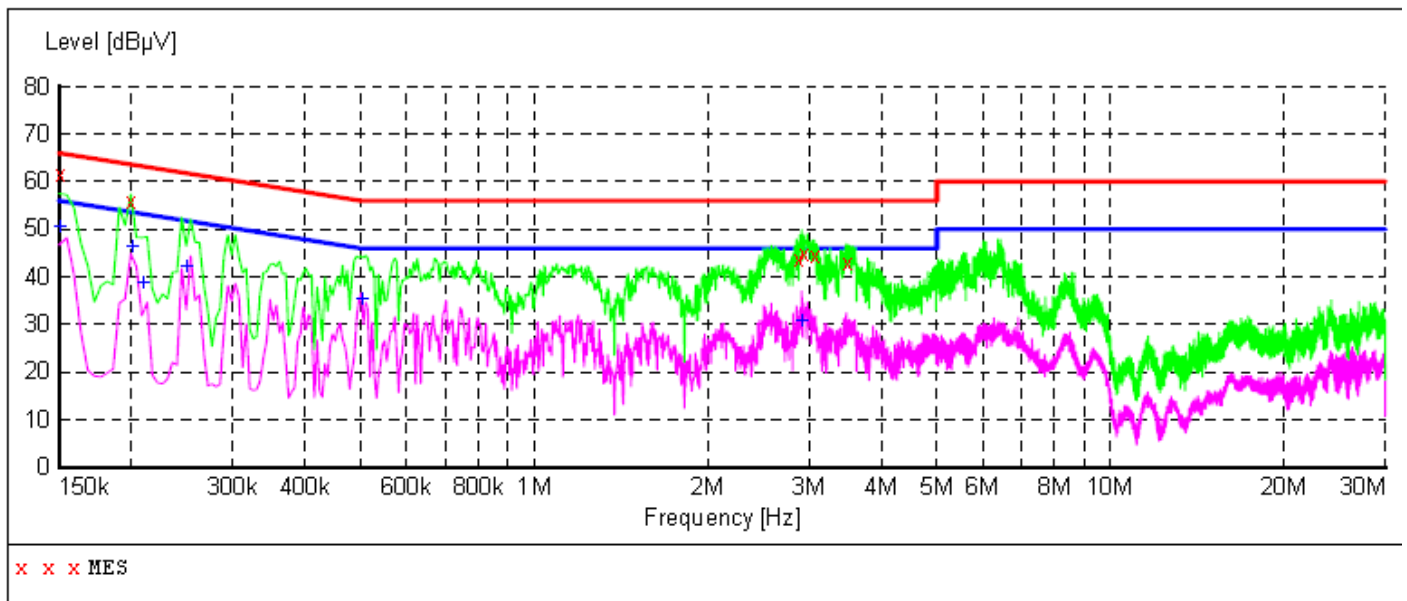

MEASUREMENT RESULT:

Frequency MHz	Level dBµV	Transd dB	Limit dBµV	Margin dB	Detector	Line	PE
0.150000	61.40	9.8	66	4.6	QP	N	GND
0.199500	55.90	9.8	64	7.7	QP	N	GND
2.868000	43.60	9.9	56	12.4	QP	N	GND
2.931000	44.70	9.9	56	11.3	QP	N	GND
3.061500	44.60	9.9	56	11.4	QP	N	GND
3.475500	42.80	9.9	56	13.2	QP	N	GND

MEASUREMENT RESULT:

Frequency MHz	Level dBµV	Transd dB	Limit dBµV	Margin dB	Detector	Line	PE
0.150000	50.70	9.8	56	5.3	AV	N	GND
0.199500	46.50	9.8	54	7.1	AV	N	GND
0.208500	38.80	9.8	53	14.5	AV	N	GND
0.249000	42.10	9.8	52	9.7	AV	N	GND
0.501000	35.50	9.8	46	10.5	AV	N	GND
2.899500	30.80	9.9	46	15.2	AV	N	GND

4.2. Radiated Emission Test

TEST CONFIGURATION

(A) Radiated Emission Test Set-Up, Frequency Below 30MHz

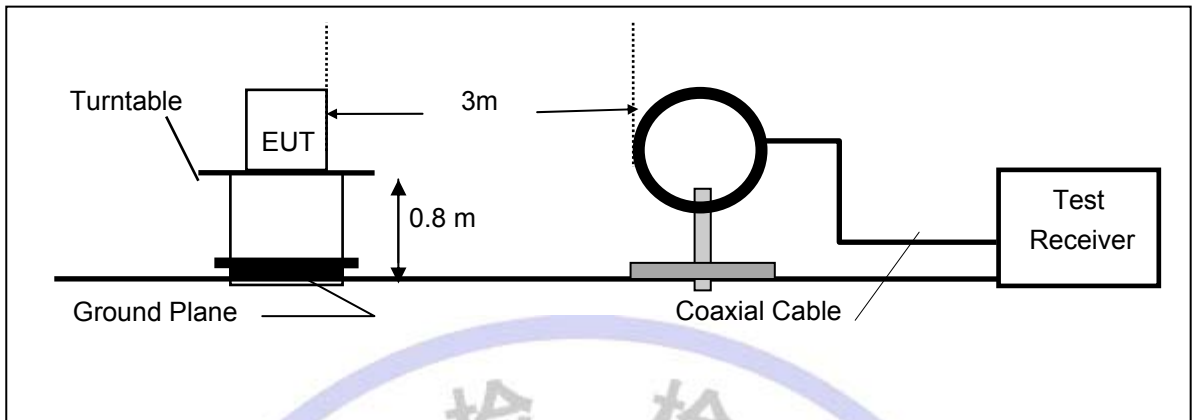

(B) Radiated Emission Test Set-Up, Frequency Below 1000MHz

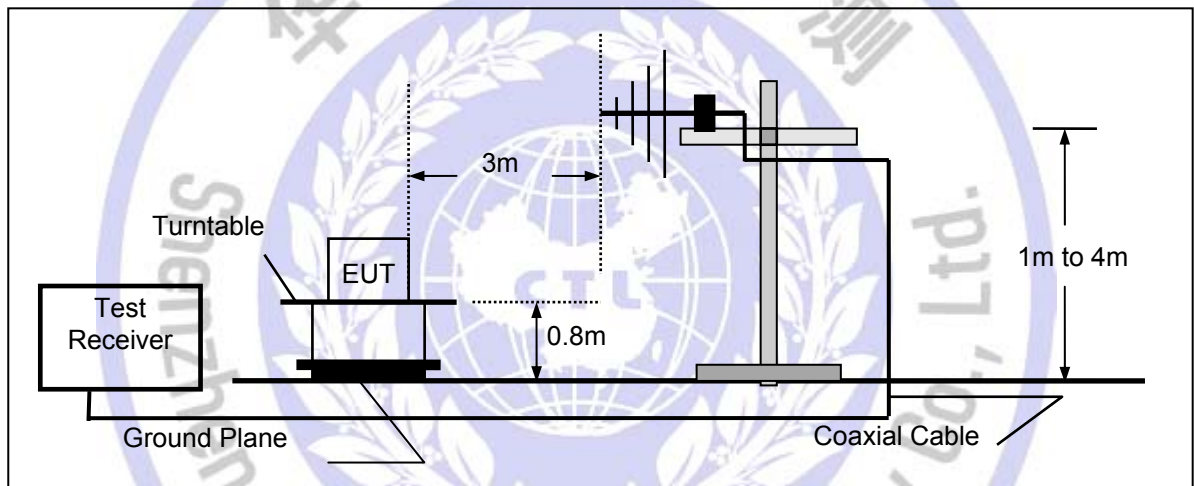

(C) Radiated Emission Test Set-Up, Frequency above 1000MHz

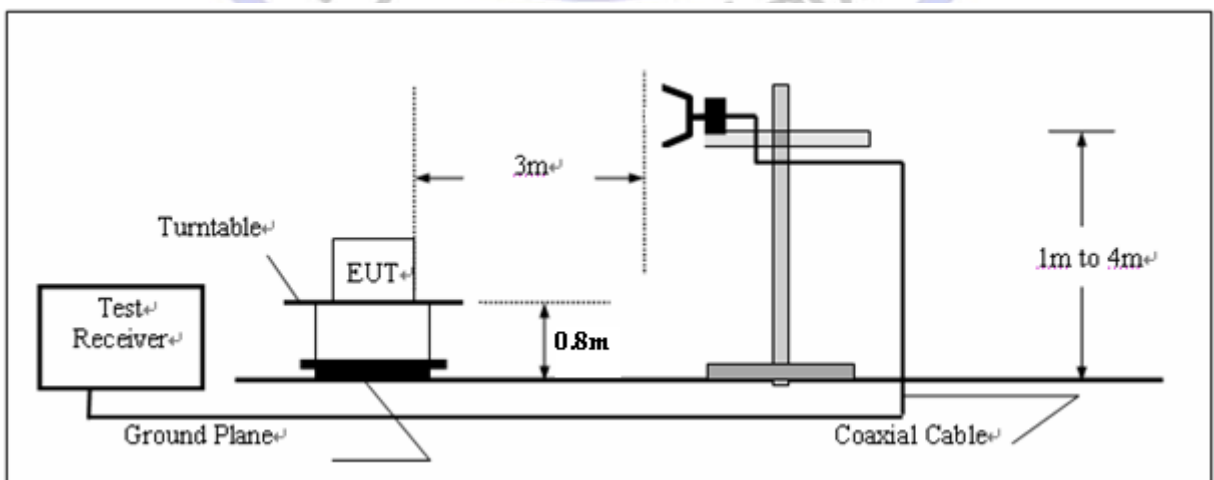

FIELD STRENGTH CALCULATION

The field strength is calculated by adding the Antenna Factor and Cable Factor and subtracting the Amplifier Gain and Duty Cycle Correction Factor(if any) from the measured reading. The basic equation with a sample calculation is as follows:

$$FS = RA + AF + CL - AG$$

Where FS = Field Strength	CL = Cable Attenuation Factor (Cable Loss)
RA = Reading Amplitude	AG = Amplifier Gain
AF = Antenna Factor	

TEST PROCEDURE

1. The testing follows FCC KDB Publication No. 558074 (Measurement Guidelines of DTS), the EUT was setup according to ANSI C63.4: and tested according to ANSI C63.10 for compliance to FCC 47CFR 15.247 requirements.
2. The EUT was placed on a turn table which is 0.8m above ground plane.
3. Maximum procedure was performed by raising the receiving antenna from 1m to 4m and rotating the turn table from 0° to 360° to acquire the highest emissions from EUT
4. And also, each emission was to be maximized by changing the polarization of receiving antenna both horizontal and vertical.
5. Span = wide enough to fully capture the emission being measured; RBW = 1 MHz for f > 1 GHz, 120 kHz for f < 1 GHz; VBW ≥ RBW; Sweep = auto; Detector function = peak; Trace = max hold.
6. Repeat above procedures until all frequency measurements have been completed.

Note:

When doing emission measurement above 1GHz, the horn antenna will be bended down a little (as horn antenna has the narrow beamwidth) in order to keeping the antenna in the “cone of radiation” of EUT. The 3dB beamwidth is 60 degrees for H-plane and 90 degrees for E-plane.

LIMIT

For unintentional device, according to § 15.109(a), except for Class A digital devices, the field strength of radiated emissions from unintentional radiators at a distance of 3 meters shall not exceed the following values:

Frequency (MHz)	Distance (Meters)	Radiated (dBμV/m)	Radiated (μV/m)
30-88	3	40.0	100
88-216	3	43.5	150
216-960	3	46.0	200
Above 960	3	54.0	500

For intentional device, according to § 15.209(a), the general requirement of field strength of radiated emissions from intentional radiators at a distance of 3 meters shall not exceed the above table. According to § 15.247(d), in any 100kHz bandwidth outside the frequency band in which the EUT is operating, the radio frequency power that is produced by the intentional radiator shall be at least 20dB below that in the 100kHz bandwidth within the band that contains the highest level of desired power.

TEST RESULTS

802.11b

CH	Antenna	Frequency (MHz)	Reading Level (dBuV/m)	Factor (dB)	Measure Level (dBuV/m)	Limit (dBuV/m)	Margin (dB)	Detector
1	V	2412.0	75.0	30.8	105.8	Fundamental	/	PK
	V	320.1	15.4	14.8	30.2	46	-15.8	QP
	V	515.0	15.2	19.7	34.9	46	-11.1	QP
	V	3200.0	43.3	-0.6	42.7	54(note3)	-11.3	PK
	V	4825.0	47.5	2.6	50.1	54(note3)	-3.9	PK
	V	7239.0	51.3	8.1	59.4	74	-13.8	PK
	V	7236.0	44.5	8.5	53.0	54	-1.0	AV
	H	24000.0	59.2	-8.9	50.3	54(note3)	-3.7	PK
6	V	2437.0	72.2	31.2	103.4	Fundamental	/	PK
	V	326.7	13.6	15.2	28.8	46	-17.2	QP
	V	571.2	13.5	21.2	34.7	46	-11.3	QP
	V	3200.0	43.4	-0.6	42.8	54(note3)	-11.2	PK
	V	4876.0	49.4	2.8	52.2	54(note3)	-1.8	PK
	V	7315.5	53.5	8.8	62.3	74	-11.7	PK
	V	7311.0	43.6	8.8	52.4	54	-1.6	AV
	H	24000.0	59.1	-8.9	50.2	54(note3)	-3.8	PK
11	V	2462.0	70.7	30.9	101.6	Fundamental	/	PK
	V	325.7	12.3	14.9	27.2	46	-18.8	QP
	H	585.2	12.5	21.2	33.7	46	-12.3	QP
	V	3200.0	44.5	-0.6	43.9	54(note3)	-10.9	PK
	V	4927.0	45.1	3.0	48.1	54(note3)	-5.9	PK
	V	7383.5	50.2	8.9	59.1	74	-14.9	PK
	V	7386.0	43.5	8.9	52.4	54	-1.6	AV
	H	24000.0	59.1	-8.9	50.2	54(note3)	-3.8	PK

Note: 1. Measure Level = Reading Level + Factor.

2. The test trace is same as the ambient noise and the test results which are attenuated more than 20 dB below the permissible value limit (the test frequency range: 9kHz~30MHz, 18GHz~25GHz), therefore no data appear in the report.

3. This limit applies for using average detector, if the test result on peak is lower than average limit, then average measurement needn't be performed.

802.11g

CH	Antenna	Frequency (MHz)	Reading Level (dBuV/m)	Factor (dB)	Measure Level (dBuV/m)	Limit (dBuV/m)	Margin (dB)	Detector
1	V	2411.9	67.3	31.9	99.2	Fundamental	/	PK
	H	256.3	13.5	15.7	29.2	46	-16.8	QP
	H	525.2	13.5	21.3	35.6	46	-10.4	QP
	V	3200	50.3	-13.4	36.9	54(note3)	-17.1	PK
	V	4824.0	43.1	2.6	45.7	54(note3)	-8.3	PK
	V	7236.0	36.7	8.9	45.6	54	-8.4	AV
	V	7239.0	50.2	8.9	59.1	74	-14.9	PK
	H	24000.0	59.5	-8.9	50.6	54(note3)	-3.4	PK
6	V	2437.0	72.1	31.2	103.3	Fundamental	/	PK
	V	333.2	12.5	14.8	27.3	46	-18.7	QP
	V	594.1	13.4	21.2	34.6	46	-11.4	QP
	V	3200.0	42.5	-0.6	41.9	54(note3)	-12.1	PK
	V	4876.0	45.6	2.8	48.4	54(note3)	-5.6	PK
	V	7298.5	44.2	8.8	53.0	54(note3)	-1.0	PK
	H	24000.0	59.3	-8.9	50.4	54(note3)	-3.6	PK
11	V	2462.3	70.5	30.9	101.4	Fundamental	/	PK
	H	582.2	13.5	21.2	34.7	46	-11.3	QP
	V	283.1	12.3	14.7	27.0	46	-19.0	QP
	V	3200.0	42.5	-0.6	41.9	54(note3)	-12.1	PK
	V	4927.0	45.5	3.0	48.5	54(note3)	-5.5	PK
	V	7386.0	37.4	8.9	46.3	54	-7.7	AV
	V	7392.0	51.8	8.9	60.7	74	-13.3	PK
	H	24000.0	59.3	-8.9	50.4	54(note3)	-3.6	PK

Note: 1. Measure Level = Reading Level + Factor.

2. The test trace is same as the ambient noise and the test results which are attenuated more than 20 dB below the permissible value limit (the test frequency range: 9kHz~30MHz, 18GHz~25GHz), therefore no data appear in the report.

3. This limit applies for using average detector, if the test result on peak is lower than average limit, then average measurement needn't be performed.

802.11n(20MHz)

CH	Antenna	Frequency (MHz)	Reading Level (dBuV/m)	Factor (dB)	Measure Level (dBuV/m)	Limit (dBuV/m)	Margin (dB)	Detector
1	V	2412.1	69.7	30.7	100.7	Fundamental	/	PK
	H	591.1	14.3	21.2	35.5	46	-10.5	QP
	H	312.7	12.3	15.1	27.4	46	-18.6	QP
	V	3200.0	42.1	-0.6	41.5	54(note3)	-12.5	PK
	V	4824.0	42.5	2.6	45.1	54(note3)	-8.9	PK
	V	7236.0	33.3	8.9	42.2	54	-11.8	AV
	V	7239.0	46.2	8.9	55.1	74	-18.9	PK
	H	24000.0	59.1	-8.9	50.2	54(note3)	-3.8	PK
6	V	2437.0	69.8	31.2	101.0	Fundamental	/	PK
	H	565.5	13.2	21.2	34.4	46	-11.6	QP
	H	341.1	13.5	16.0	29.5	46	-16.5	QP
	V	3200.0	42.5	-0.6	41.9	54(note3)	-12.1	PK
	V	4876.0	45.5	2.8	48.3	54(note3)	-5.7	PK
	V	7307.0	54.6	8.8	63.4	74	-10.6	PK
	V	7310.6	41.0	8.8	49.8	54	-4.2	AV
	H	24000.0	59.1	-8.9	50.2	54(note3)	-3.8	PK
11	V	2462.0	72.5	30.9	102.4	Fundamental	/	PK
	H	311.2	13.5	14.7	28.2	46	-17.8	QP
	H	555.1	13.1	21.2	34.3	46	-11.7	QP
	V	3200.0	43.2	-0.6	42.6	54(note3)	-11.4	PK
	V	4924.0	42.3	3.0	45.3	54(note3)	-8.7	PK
	V	7375.0	50.1	9.0	59.0	74	-15.0	PK
	V	7378.3	34.0	9.0	42.9	54	-11.1	AV
	H	24000.0	59.3	-8.9	50.5	54(note3)	-3.5	PK

Note: 1. Measure Level = Reading Level + Factor.

2. The test trace is same as the ambient noise and the test results which are attenuated more than 20 dB below the permissible value limit (the test frequency range: 9kHz~30MHz, 18GHz~25GHz), therefore no data appear in the report.

3. This limit applies for using average detector, if the test result on peak is lower than average limit, then average measurement needn't be performed.

802.11n(40MHz)

CH	Antenna	Frequency (MHz)	Reading Level (dBuV/m)	Factor (dB)	Measure Level (dBuV/m)	Limit (dBuV/m)	Margin (dB)	Detector
3	V	2423.6	65.7	31.8	97.5	Fundamental	/	PK
	H	344.5	14.6	16.0	30.6	46	-15.4	QP
	H	562.2	14.5	21.2	35.7	46	-10.3	QP
	V	3200.0	42.2	-0.6	41.6	54(note3)	-12.4	PK
	V	4844.0	41.1	2.6	43.8	54(note3)	-10.2	PK
	V	7290.0	44.3	8.8	53.1	54(note3)	-0.9	PK
	H	24000.0	59.4	-8.9	50.5	54(note3)	-3.5	PK
6	V	2437.0	64.5	31.2	95.7	Fundamental	/	PK
	H	291.6	12.5	14.8	27.3	46	-18.7	QP
	H	553.5	13.5	21.2	34.7	46	-11.3	QP
	V	3200.0	42.3	-0.6	41.7	54(note3)	-12.3	PK
	V	4874.0	41.5	2.8	44.3	54(note3)	-9.7	PK
	V	7349.2	32.0	9.0	40.9	54	-13.1	AV
	V	7358.0	46.6	9.0	55.6	74	-18.4	PK
H	24000.0	59.1	-8.9	50.2	54(note3)	-3.8	PK	
9	V	2453.6	65.7	30.9	96.6	Fundamental	/	PK
	H	582.2	14.4	21.2	35.6	46	-10.4	QP
	H	296.5	13.5	14.8	28.3	46	-17.7	QP
	V	3200.0	42.2	-0.6	41.6	54(note3)	-12.4	PK
	V	4904.0	41.9	2.9	44.8	54(note3)	-9.2	PK
	V	7349.4	32.2	9.0	41.2	54	-12.8	AV
	V	7349.5	45.3	9.0	54.2	74	-19.8	PK
H	24000.0	59.4	-8.9	50.5	54(note3)	-3.5	PK	

Note: 1. Measure Level = Reading Level + Factor.

2. The test trace is same as the ambient noise and the test results which are attenuated more than 20 dB below the permissible value limit (the test frequency range: 9kHz~30MHz, 18GHz~25GHz), therefore no data appear in the report.

3. This limit applies for using average detector, if the test result on peak is lower than average limit, then average measurement needn't be performed.

The worst case of Radiated Emission below 1GHz:

SWEEP TABLE: "test (30M-1G)"

Short Description:		Field Strength			
Start	Stop	Detector	Meas. Time	IF Bandw.	Transducer
Frequency	Frequency				
30.0 MHz	1.0 GHz	MaxPeak	300.0 ms	120 kHz	JB1

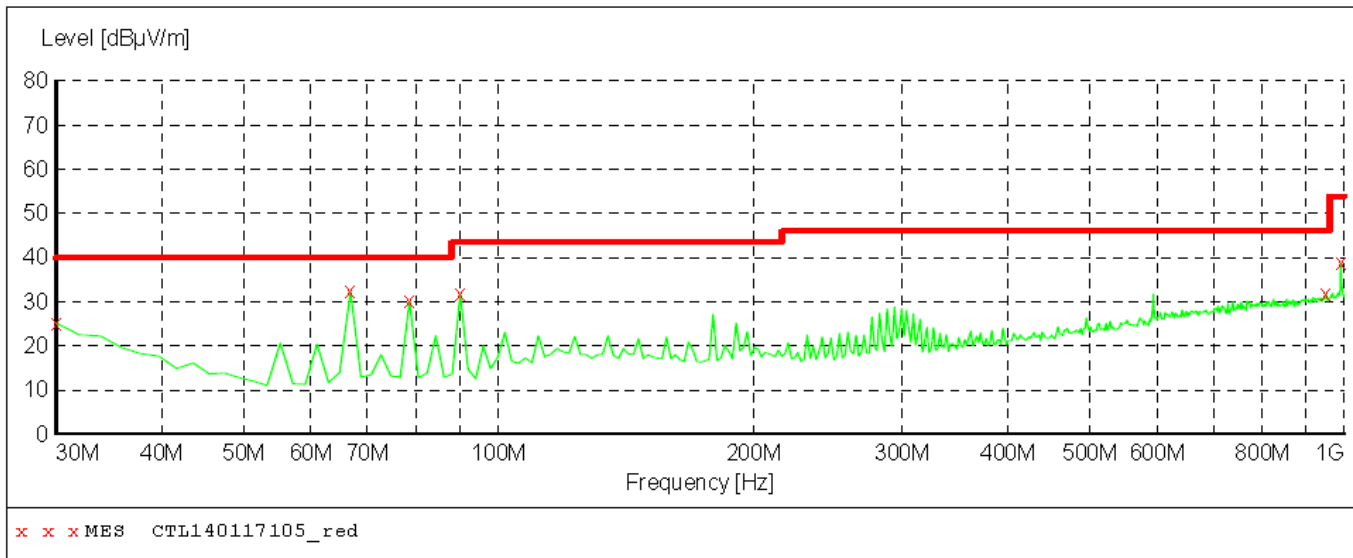

MEASUREMENT RESULT: "CTL140117105_red"

1/17/2014 8:59AM

Frequency MHz	Level dBµV/m	Transd dB	Limit dBµV/m	Margin dB	Det.	Height cm	Azimuth deg	Polarization
30.000000	25.20	21.1	40.0	14.8	---	0.0	0.00	VERTICAL
66.860000	32.40	8.4	40.0	7.6	---	0.0	0.00	VERTICAL
78.500000	30.10	8.6	40.0	9.9	---	0.0	0.00	VERTICAL
90.140000	31.80	9.7	43.5	11.7	---	0.0	0.00	VERTICAL
951.500000	31.90	26.7	46.0	14.1	---	0.0	0.00	VERTICAL
990.300000	38.80	27.2	53.9	15.1	---	0.0	0.00	VERTICAL



SWEEP TABLE: "test (30M-1G)"

Short Description:		Field Strength			
Start	Stop	Detector	Meas. Time	IF Bandw.	Transducer
30.0 MHz	1.0 GHz	MaxPeak	300.0 ms	120 kHz	JB1

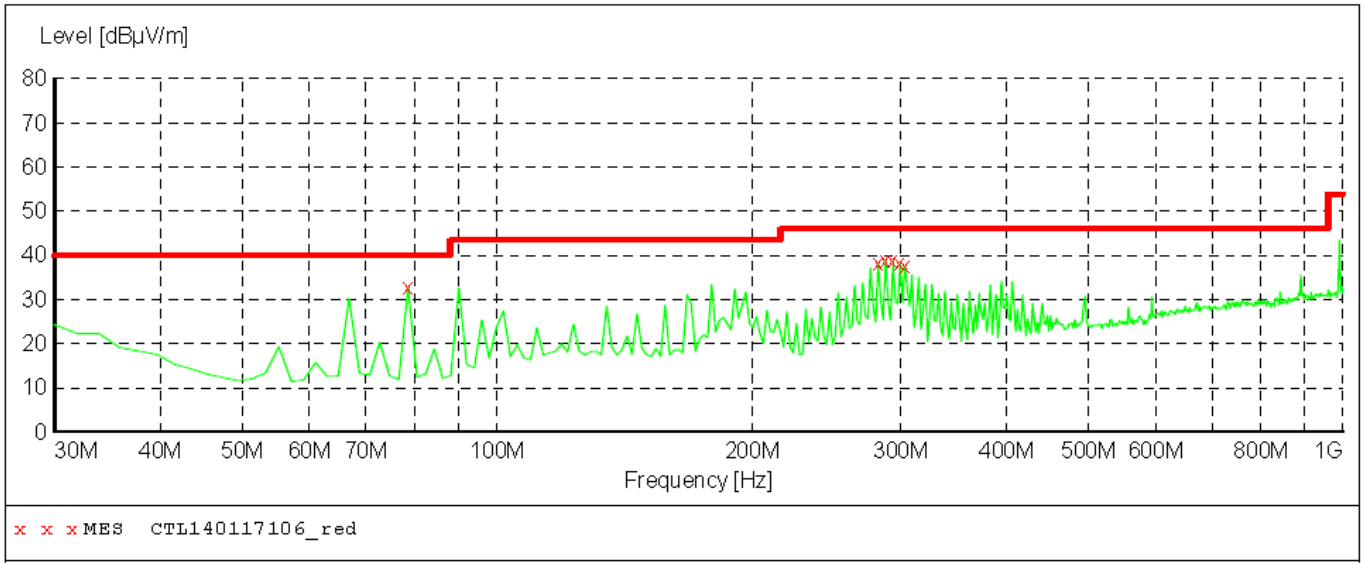

MEASUREMENT RESULT: "CTL140117106_red"

1/17/2014 9:01AM

Frequency MHz	Level dBµV/m	Transd dB	Limit dBµV/m	Margin dB	Det.	Height cm	Azimuth deg	Polarization
78.500000	32.80	8.6	40.0	7.2	---	0.0	0.00	HORIZONTAL
282.200000	38.30	15.4	46.0	7.7	---	0.0	0.00	HORIZONTAL
288.020000	39.00	15.4	46.0	7.0	---	0.0	0.00	HORIZONTAL
293.840000	38.70	15.4	46.0	7.3	---	0.0	0.00	HORIZONTAL
299.660000	38.30	15.4	46.0	7.7	---	0.0	0.00	HORIZONTAL
303.540000	37.60	15.5	46.0	8.4	---	0.0	0.00	HORIZONTAL



4.3. 6dB Bandwidth Measurement

TEST CONFIGURATION

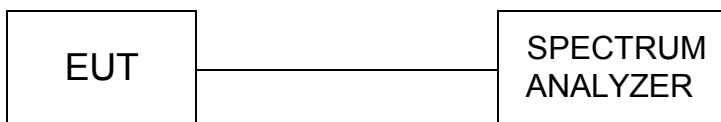

TEST PROCEDURE

1. The testing follows FCC KDB Publication No. 558074 (Measurement Guidelines of DTS).
2. The RF output of EUT was connected to the spectrum analyzer by a low loss cable.
3. Make the measurement with the spectrum analyzer's resolution bandwidth (RBW) = 100 kHz. In order to make an accurate measurement, set the span greater than RBW. The 6 dB bandwidth must be greater than 500 kHz.
4. The marker-delta reading at this point is the 6 dB bandwidth of the emission.

LIMIT

For digital modulation systems, the minimum 6 dB bandwidth shall be at least 500 kHz.

TEST RESULTS

Product	:	HS-9DTB13-8GB
Test Item	:	6dB Occupied Bandwidth
Test Mode	:	Mode 1: Transmit by 802.11b

Channel No.	Frequency (MHz)	Occupied Bandwidth (kHz)	Limit (kHz)	Result
01	2412	9400	500	Pass
06	2437	9200	500	Pass
11	2462	9100	500	Pass

Channel 11 (2462MHz)



*RBW 100 kHz Delta 3 [T1]
VBW 300 kHz -6.32 dB
SWT 5 ms 5.200000000 MHz

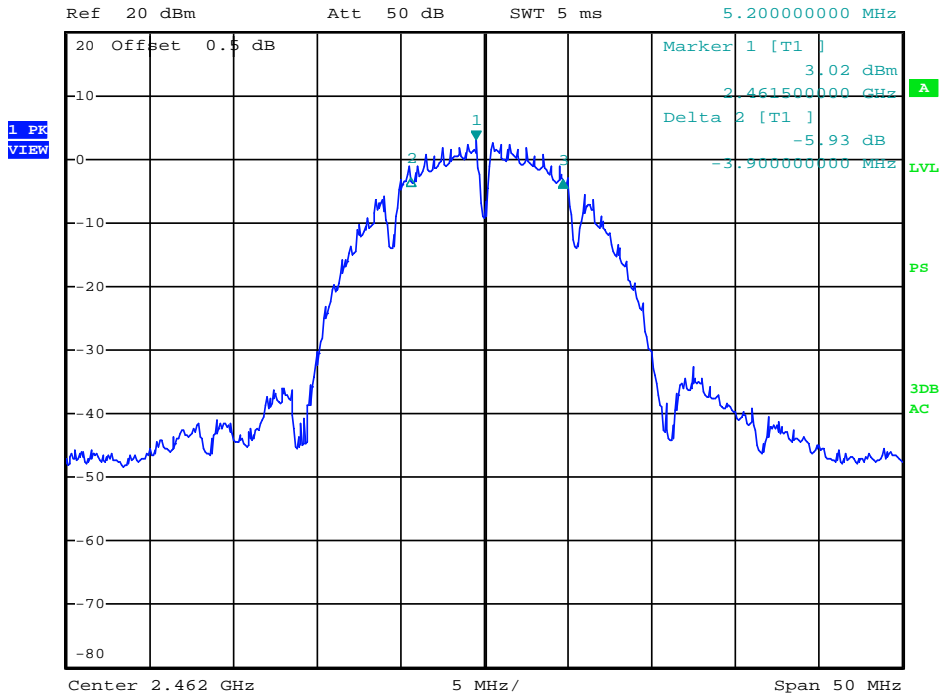

Date: 17.JAN.2014 14:17:08



Product	:	HS-9DTB13-8GB
Test Item	:	6dB Occupied Bandwidth
Test Mode	:	Mode 2: Transmit by 802.11g

Channel No.	Frequency (MHz)	Occupied Bandwidth (kHz)	Limit (kHz)	Result
01	2412	16500	500	Pass
06	2437	16600	500	Pass
11	2462	16600	500	Pass

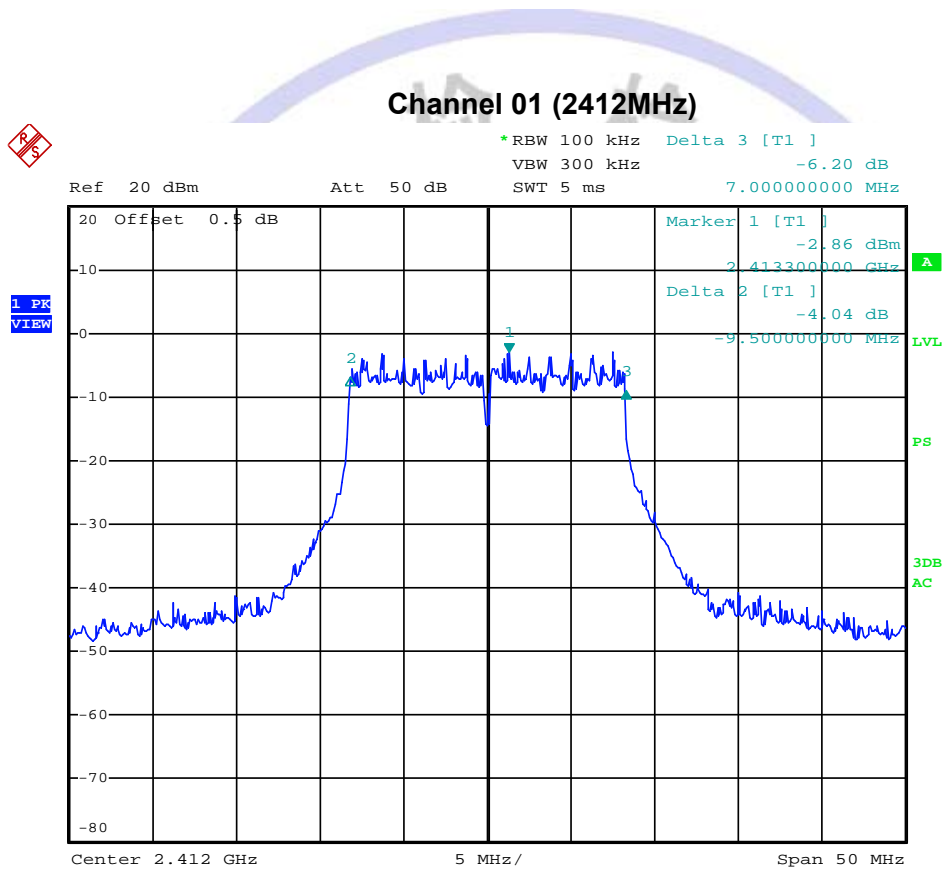

Date: 17.JAN.2014 14:19:56

Channel 06 (2437MHz)

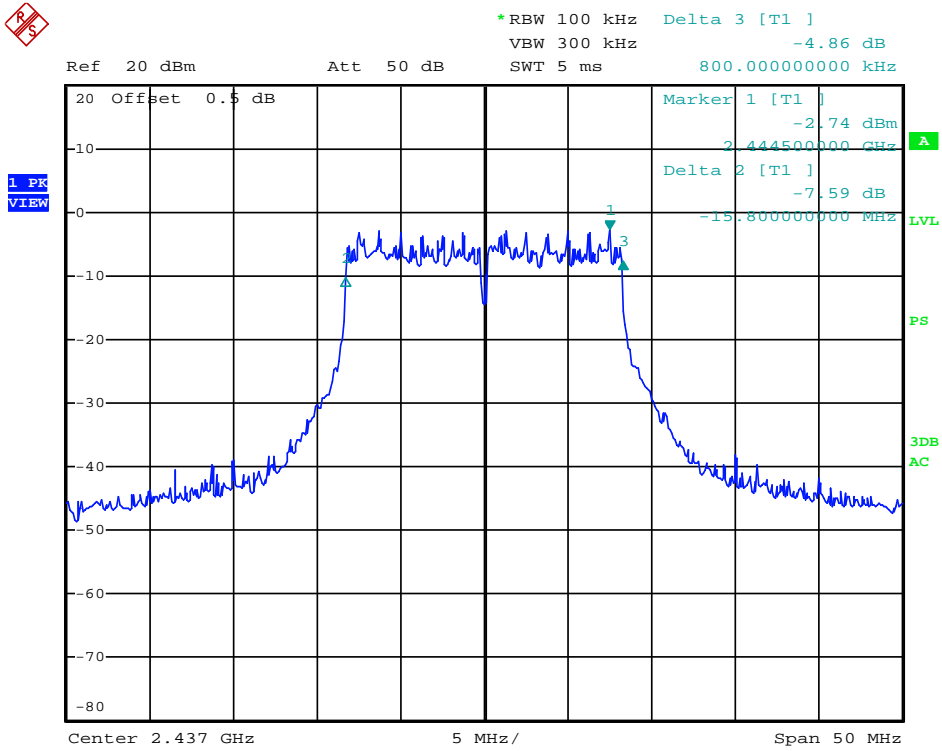

Date: 17.JAN.2014 14:19:07

Channel 11 (2462MHz)

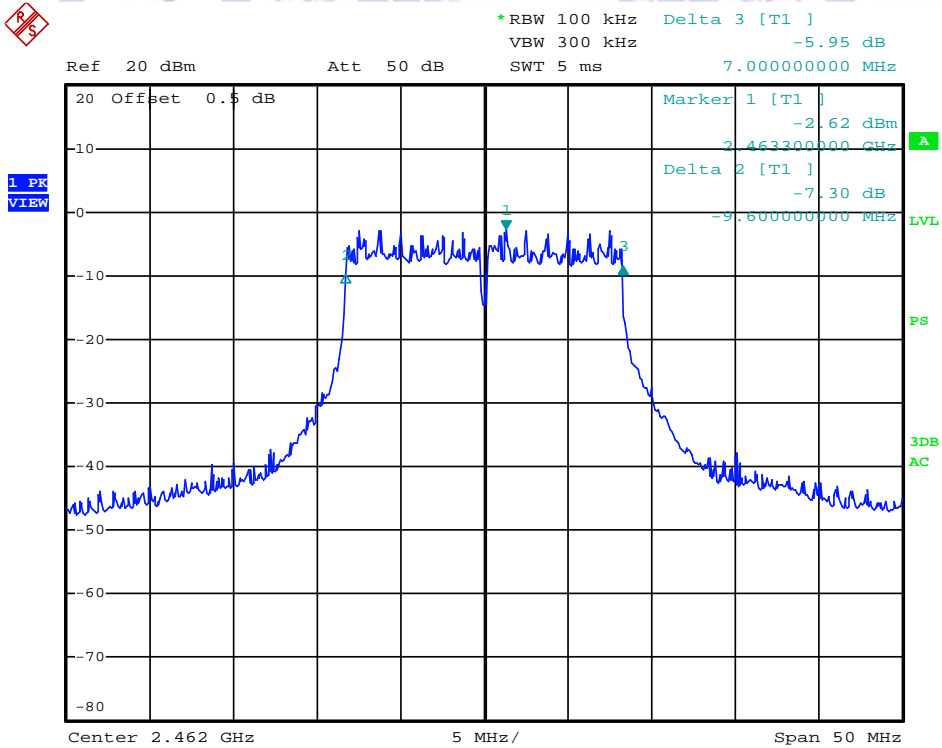

Date: 17.JAN.2014 14:18:13

Product	:	HS-9DTB13-8GB
Test Item	:	6dB Occupied Bandwidth
Test Mode	:	Mode 3: Transmit by 802.11n (20MHz)

Channel No.	Frequency (MHz)	Occupied Bandwidth (kHz)	Limit (kHz)	Result
01	2412	17800	500	Pass
06	2437	17800	500	Pass
11	2462	17800	500	Pass

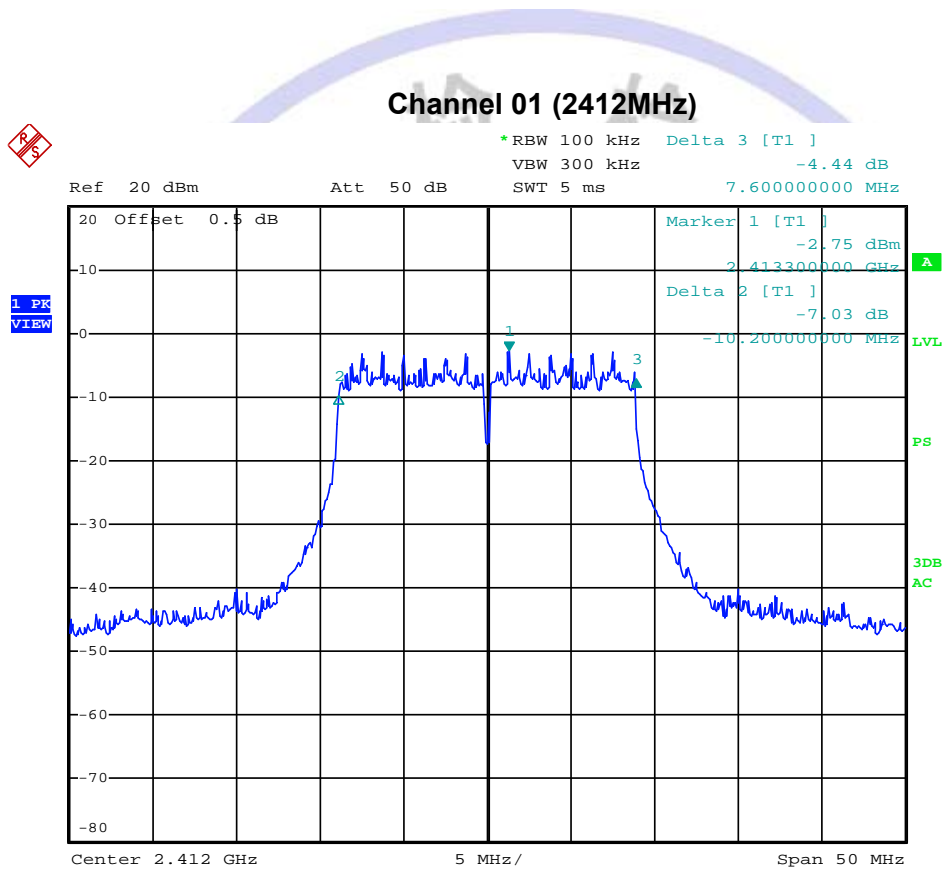

Date: 17.JAN.2014 14:21:19

Channel 06 (2437MHz)

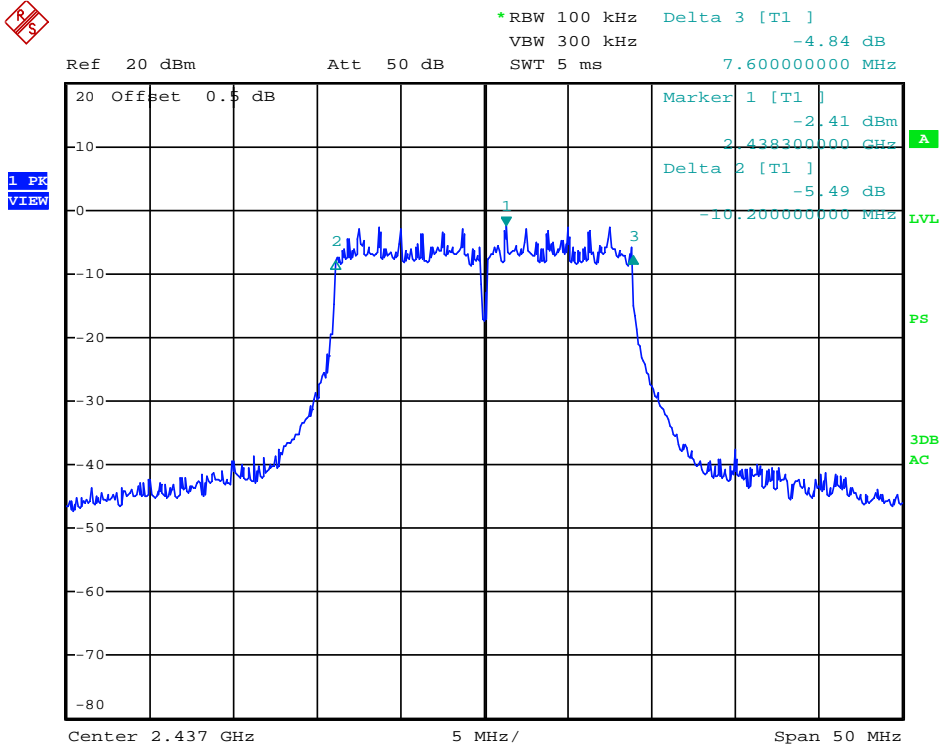

Date: 17.JAN.2014 14:22:11

Channel 11 (2462MHz)

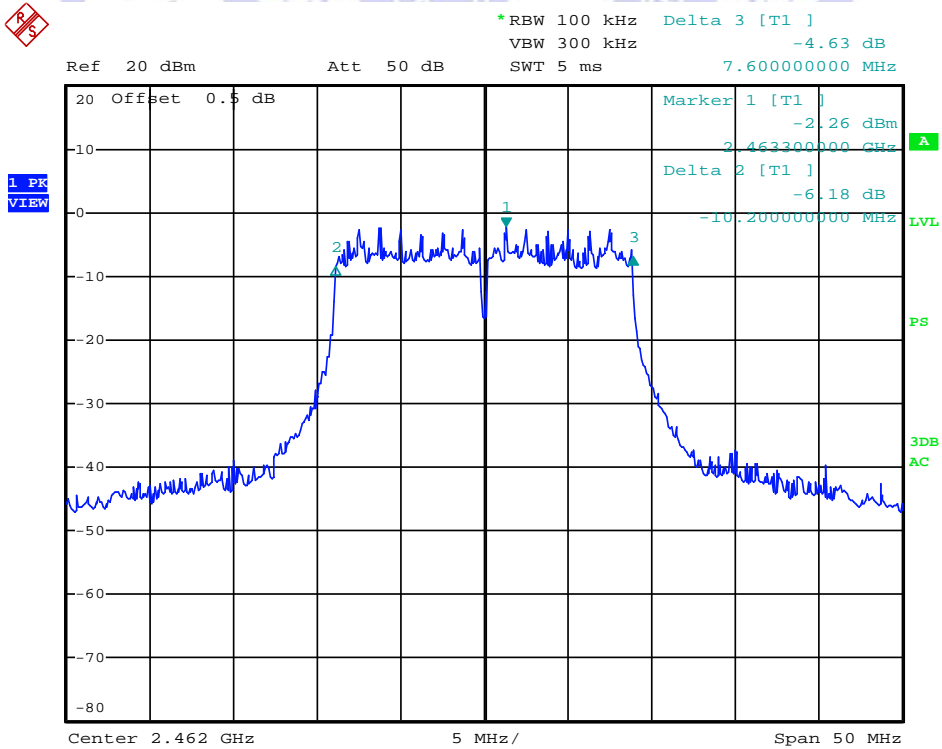

Date: 17.JAN.2014 14:22:58

Product	:	HS-9DTB13-8GB
Test Item	:	6dB Occupied Bandwidth
Test Mode	:	Mode 4: Transmit by 802.11n (40MHz)

Channel No.	Frequency (MHz)	Occupied Bandwidth (kHz)	Limit (kHz)	Result
03	2422	35800	500	Pass
06	2437	35800	500	Pass
09	2452	35800	500	Pass

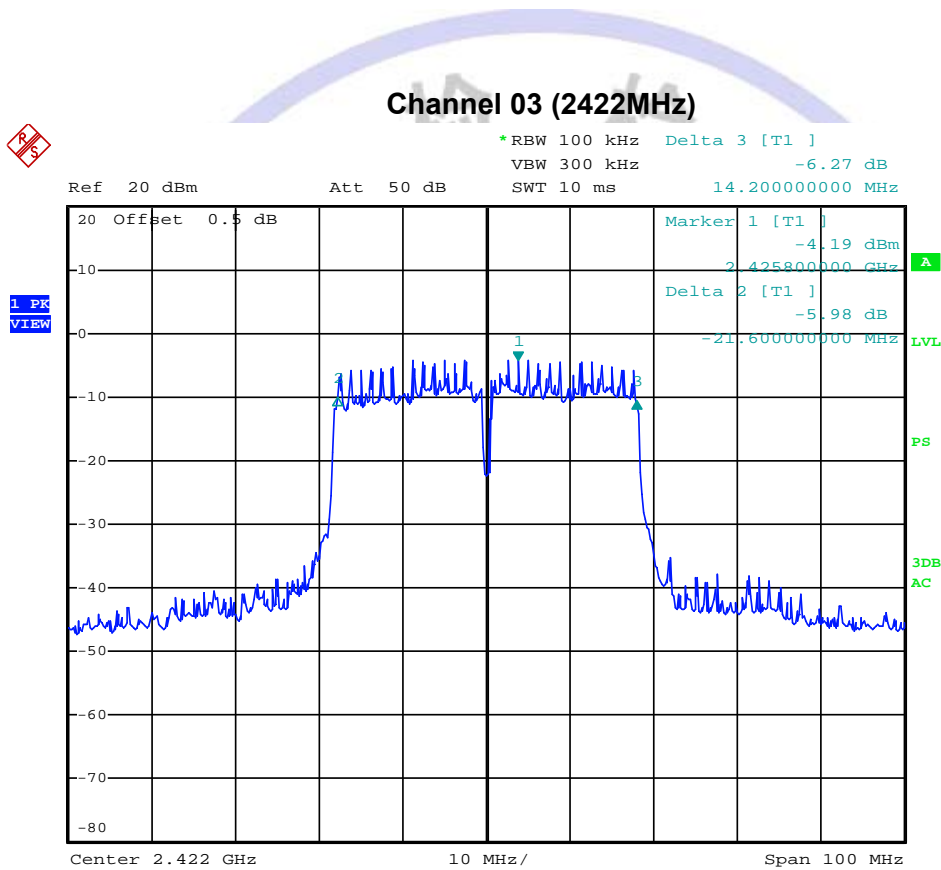

Date: 17.JAN.2014 14:25:57

Channel 06 (2437MHz)

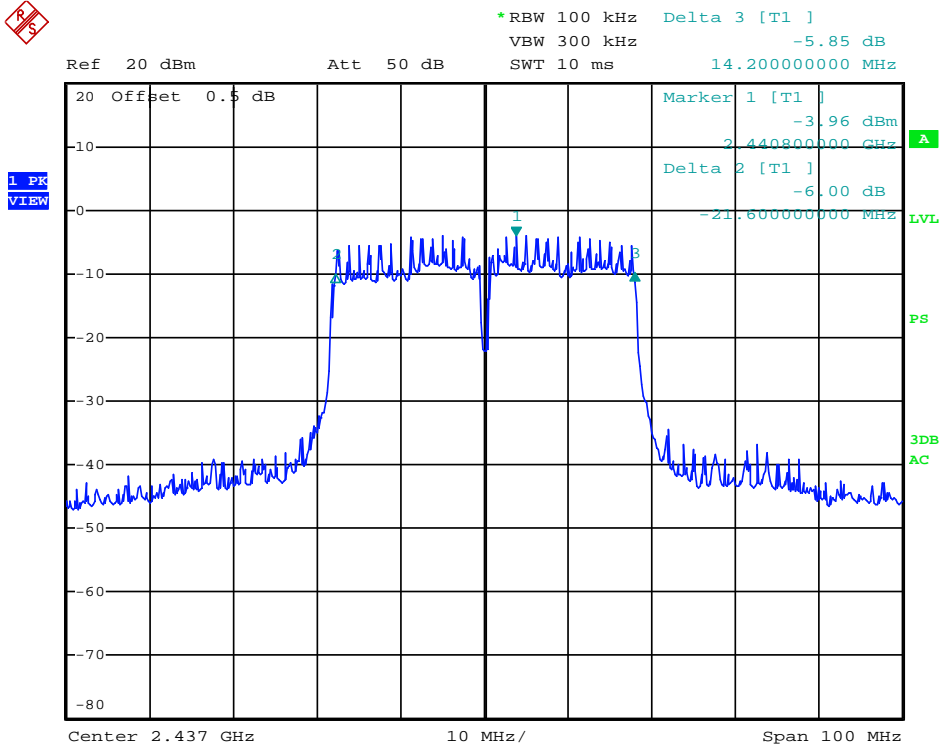

Date: 17.JAN.2014 14:26:45

Channel 09 (2452MHz)

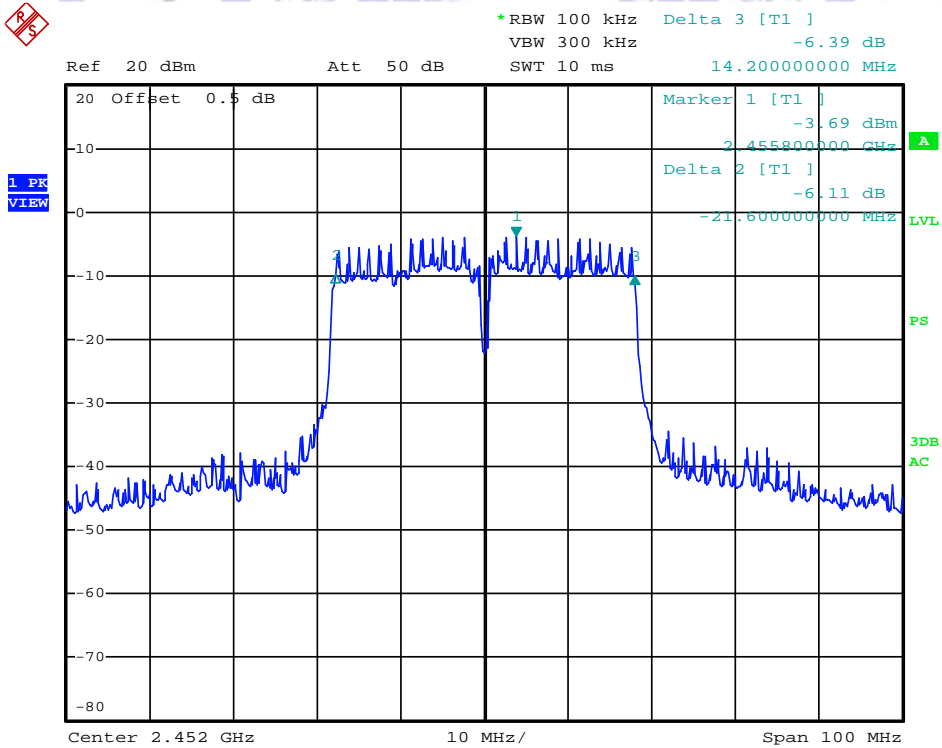

Date: 17.JAN.2014 14:27:35

4.4. Maximum Peak Output Power

TEST CONFIGURATION

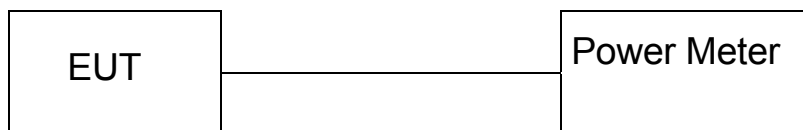

TEST PROCEDURE

According to C63.10 -2009 and KDB558074, The EUT was directly connected to the power meter / spectrum analyzer and antenna output port as show in the block diagram as TEST CONFIGURATION shows.

Use the wideband power meter to test peak power and record the result.

LIMIT

The Peak Output Power Measurement limits are 30dBm.

TEST RESULTS

Mode	Channel	Peak Power Output (dBm)	Peak Power Limit (dBm)	PASS / FAIL
802.11b	1	9.65	30	PASS
	6	9.48	30	PASS
	11	9.36	30	PASS
802.11g	1	9.44	30	PASS
	6	9.28	30	PASS
	11	9.31	30	PASS
802.11n HT20	1	9.27	30	PASS
	6	9.15	30	PASS
	11	9.02	30	PASS
802.11n HT40	3	8.87	30	PASS
	6	8.66	30	PASS
	9	8.69	30	PASS

Note: The test results including the cable lose.

4.5. Band Edge Measurement

TEST CONFIGURATION

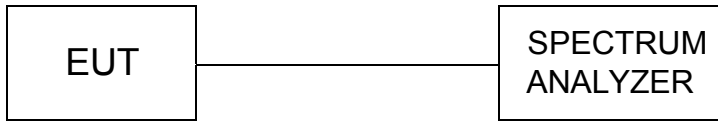

TEST PROCEDURE

The band edge compliance of RF radiated emission should be measured by following the guidance in ANSI C63.10 and FCC KDB Publication No. 558074 (Measurement Guidelines of DTS) with respect to maximizing the emission by rotating the EUT, measuring the emission while the EUT is situated in three orthogonal planes (if appropriate), adjusting the measurement antenna height and polarization etc. Set RBW=100kHz and VBM= 300KHz to measure the peak field strength and set RBW to 1MHz and VBW to 10Hz to measure the average radiated field strength.

The conducted RF band edge was measured by using a spectrum analyzer. Set span wide enough to capture the highest in-band emission and the emission at the band edge. Set RBW and VBW to 100 kHz, to measure the conducted peak band edge.

Connect the spectrum analyzer to the EUT using an appropriate RF cable connected to the EUT output. Configure the spectrum analyzer settings as described below (be sure to enter all losses between the unlicensed wireless device output and the spectrum analyzer).

- Span: Set Span for minimum 50 MHz - Reference Level: 110 dB μ V (corrected for gains and losses of test antenna factor, preamp gain and cable loss) - Attenuation: 10 dB

- Sweep Time: Coupled - Resolution Bandwidth: Up to and including 1 GHz = \geq 100 kHz

- Resolution Bandwidth: Above 1 GHz = 1 MHz - Video Bandwidth: Below 1 GHz = 300 kHz

- Video Bandwidth: Up to and including 1 GHz = \geq 3 MHz for peak and 10 Hz for average

- Detector: Peak

Place a marker at the end of the restricted band closest to the transmit frequency to show compliance. Also measure any emissions in the restricted bands. Save the spectrum analyzer plot. Repeat for each power and modulation for lowest and highest channel.

LIMIT

1. Below -20dB of the highest emission level in operating band.

2. Fall in the restricted bands listed in section 15.205. The maximum permitted average field strength is listed in section 15.209(see Section 15.205(c)).

Frequency (MHz)	Limit Average (dBuV/m)	Limit Peak (dBuV/m)
Below 2390 or Above 2483.5	54	74

TEST RESULTS

Engineer: Sunny	
Site: AC5	Time: 2014/01/20 - 19:17
Limit: FCC Part15.209 RE(3m)	Margin: 0
Probe: BBHA 9120D_499(1-18GHz)	Polarity: Horizontal
EUT: Tablet PC	Power:By Battery
Note: Mode1: Transmit at channel 2412 by 802.11b	

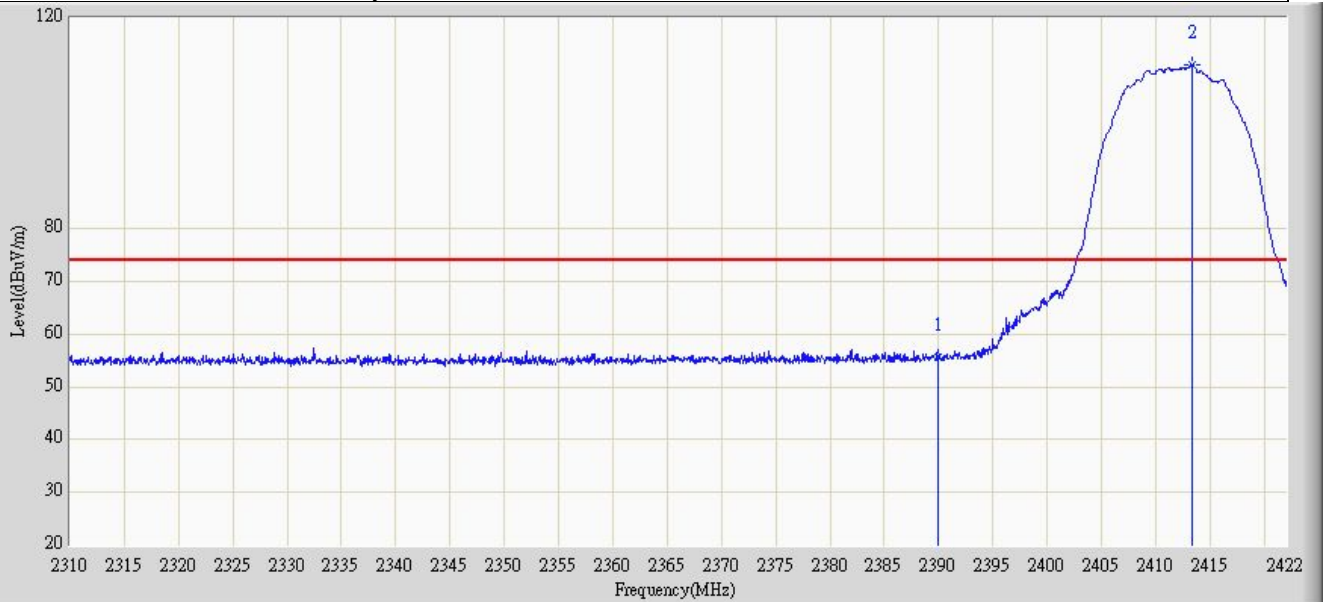

No	Mark	Frequency (MHz)	Measure Level (dBuV/m)	Reading Level (dBuV)	Over Limit (dB)	Limit (dBuV/m)	Factor (dB)	Type
1		2390.000	55.715	24.627	-18.285	74.000	31.088	PK
2	*	2413.376	111.224	79.981	N/A	N/A	31.243	PK

Engineer: Sunny	
Site: AC5	Time: 2014/01/20 - 19:24
Limit: FCC Part15.209 RE(3m)	Margin: 0
Probe: BBHA 9120D_499(1-18GHz)	Polarity: Horizontal
EUT: Tablet PC	Power:By Battery
Note: Mode1: Transmit at channel 2412 by 802.11b	

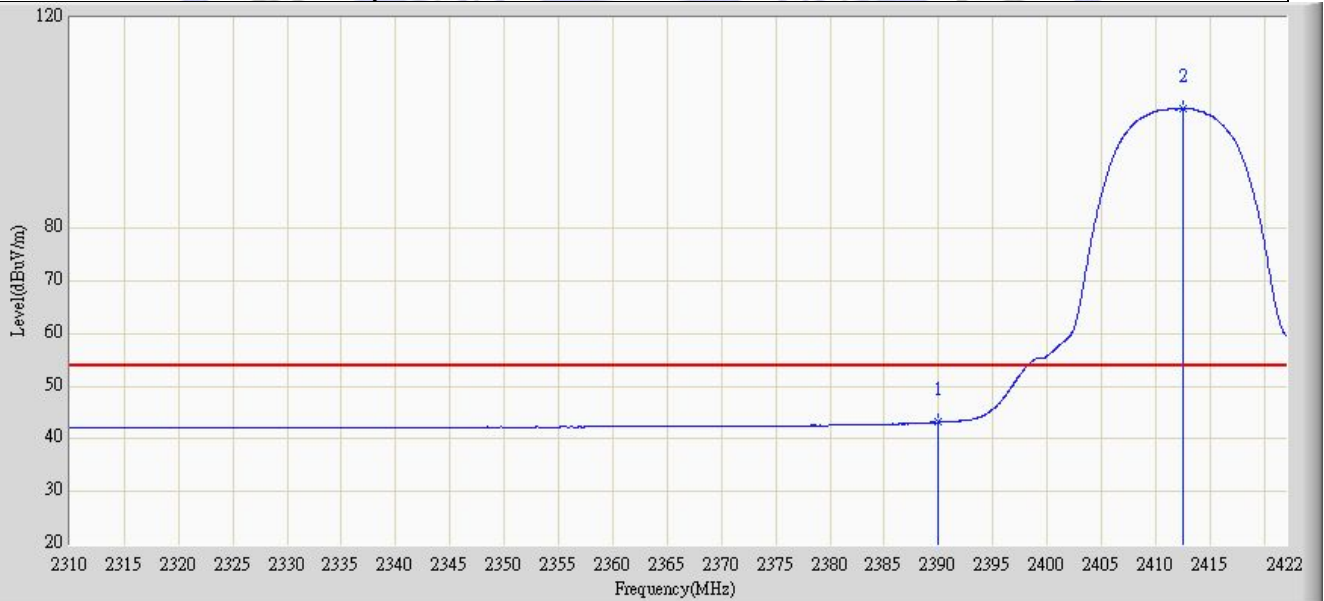

No	Mark	Frequency (MHz)	Measure Level (dBuV/m)	Reading Level (dBuV)	Over Limit (dB)	Limit (dBuV/m)	Factor (dB)	Type
1		2390.000	43.155	12.067	-10.845	54.000	31.088	AV
2	*	2412.480	102.771	71.536	N/A	N/A	31.235	AV

Engineer: Sunny	
Site: AC5	Time: 2014/01/20 - 19:32
Limit: FCC Part15.209 RE(3m)	Margin: 0
Probe: BBHA 9120D_499(1-18GHz)	Polarity: Vertical
EUT: Tablet PC	Power:By Battery
Note: Mode1: Transmit at channel 2412 by 802.11b	

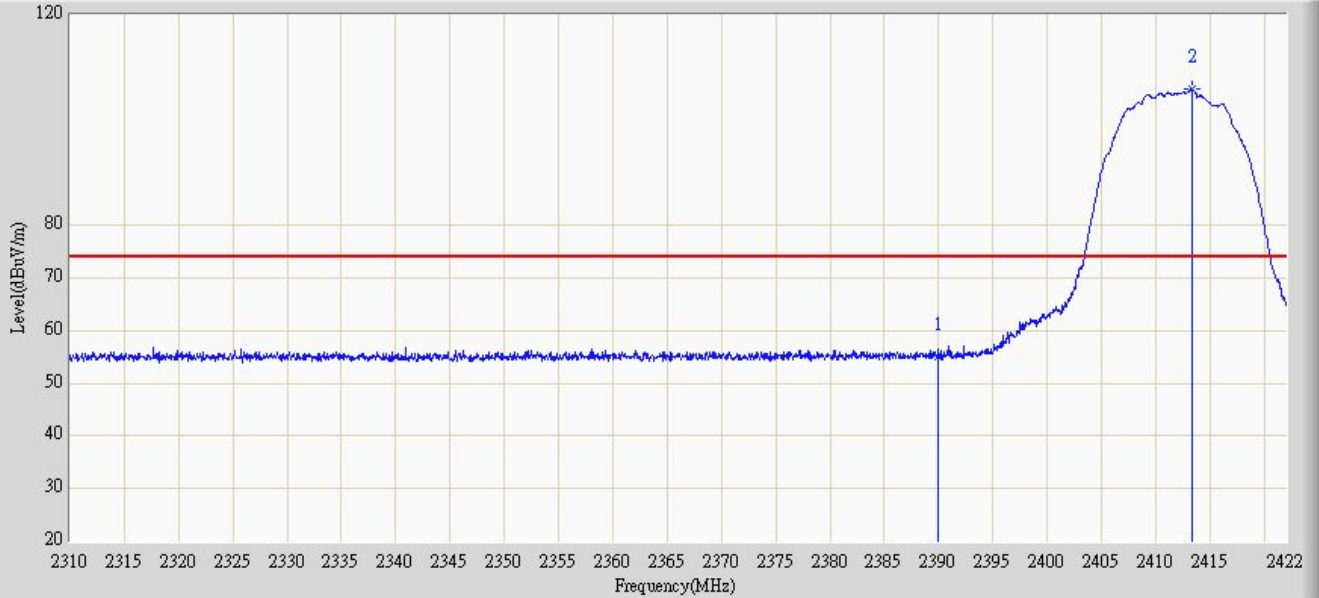

No	Mark	Frequency (MHz)	Measure Level (dBuV/m)	Reading Level (dBuV)	Over Limit (dB)	Limit (dBuV/m)	Factor (dB)	Type
1		2390.000	54.965	23.877	-19.035	74.000	31.088	PK
2	*	2413.376	105.927	74.684	N/A	N/A	31.243	PK

Engineer: Sunny	
Site: AC5	Time: 2014/01/20 - 19:35
Limit: FCC Part15.209 RE(3m)	Margin: 0
Probe: BBHA 9120D_499(1-18GHz)	Polarity: Vertical
EUT: Tablet PC	Power:By Battery
Note: Mode1: Transmit at channel 2412 by 802.11b	

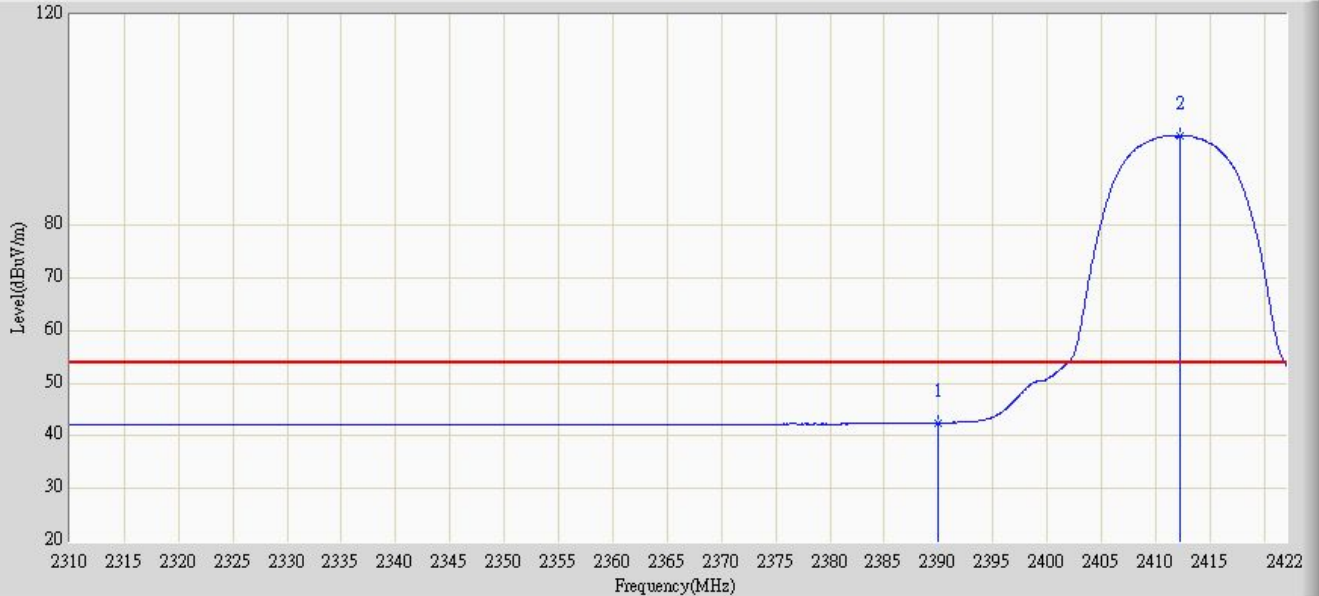

No	Mark	Frequency (MHz)	Measure Level (dBuV/m)	Reading Level (dBuV)	Over Limit (dB)	Limit (dBuV/m)	Factor (dB)	Type
1		2390.000	42.481	11.393	-11.519	54.000	31.088	AV
2	*	2412.312	96.974	65.741	N/A	N/A	31.233	AV

Engineer: Sunny	
Site: AC5	Time: 2014/01/20 - 19:41
Limit: FCC Part15.209 RE(3m)	Margin: 0
Probe: BBHA 9120D_499(1-18GHz)	Polarity: Horizontal
EUT: Tablet PC	Power:By Battery
Note: Mode1: Transmit at channel 2462 by 802.11b	

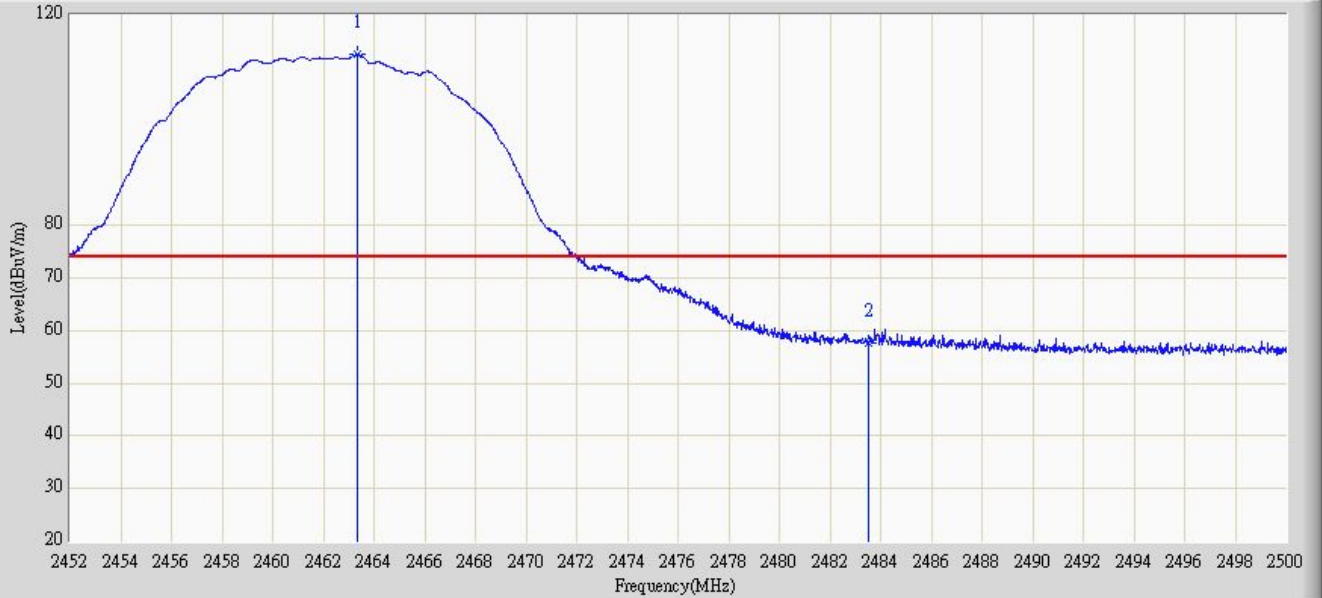

No	Mark	Frequency (MHz)	Measure Level (dBuV/m)	Reading Level (dBuV)	Over Limit (dB)	Limit (dBuV/m)	Factor (dB)	Type
1	*	2463.328	112.452	80.859	N/A	N/A	31.593	PK
2		2483.500	57.616	26.003	-16.384	74.000	31.613	PK

Engineer: Sunny	
Site: AC5	Time: 2014/01/20 - 19:49
Limit: FCC Part15.209 RE(3m)	Margin: 0
Probe: BBHA 9120D_499(1-18GHz)	Polarity: Horizontal
EUT: Tablet PC	Power:By Battery
Note: Mode1: Transmit at channel 2462 by 802.11b	

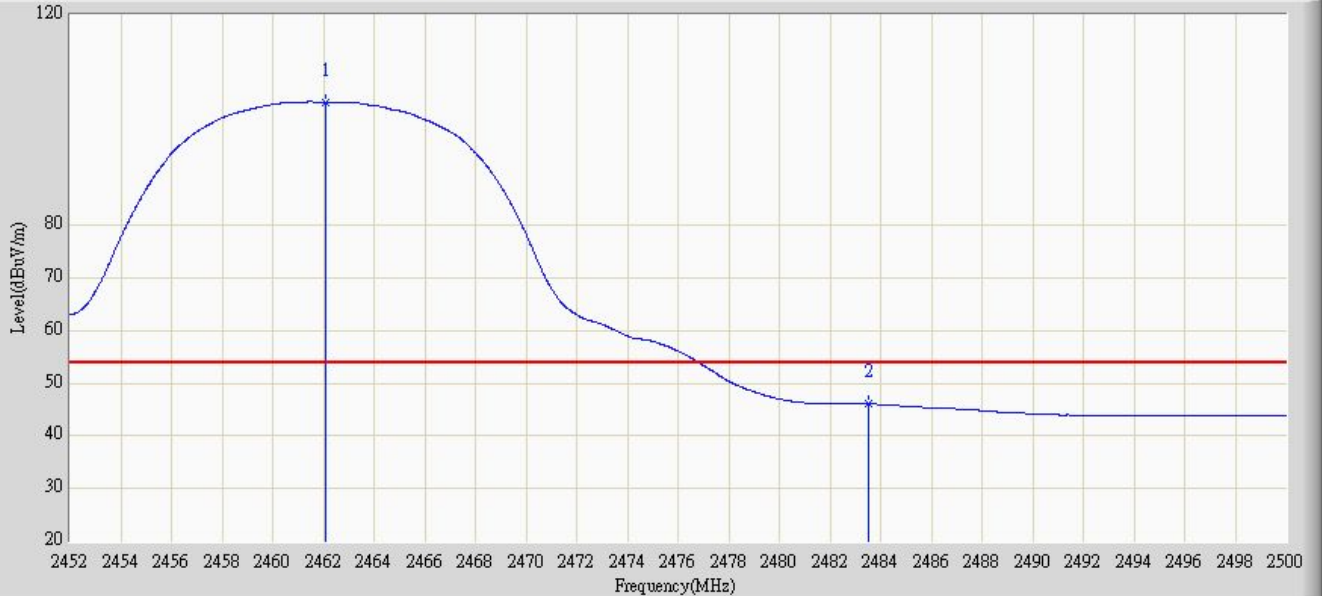

No	Mark	Frequency (MHz)	Measure Level (dBuV/m)	Reading Level (dBuV)	Over Limit (dB)	Limit (dBuV/m)	Factor (dB)	Type
1	*	2462.104	103.389	71.797	N/A	N/A	31.592	AV
2		2483.500	46.117	14.504	-7.883	54.000	31.613	AV

Engineer: Sunny	
Site: AC5	Time: 2014/01/20 - 20:03
Limit: FCC Part15.209 RE(3m)	Margin: 0
Probe: BBHA 9120D_499(1-18GHz)	Polarity: Vertical
EUT: Tablet PC	Power:By Battery
Note: Mode1: Transmit at channel 2462 by 802.11b	



No	Mark	Frequency (MHz)	Measure Level (dBuV/m)	Reading Level (dBuV)	Over Limit (dB)	Limit (dBuV/m)	Factor (dB)	Type
1	*	2463.400	107.253	75.660	N/A	N/A	31.593	PK
2		2483.500	57.348	25.734	-16.652	74.000	31.613	PK

Engineer: Sunny	
Site: AC5	Time: 2014/01/20 - 20:05
Limit: FCC Part15.209 RE(3m)	Margin: 0
Probe: BBHA 9120D_499(1-18GHz)	Polarity: Vertical
EUT: Tablet PC	Power:By Battery
Note: Mode1: Transmit at channel 2462 by 802.11b	

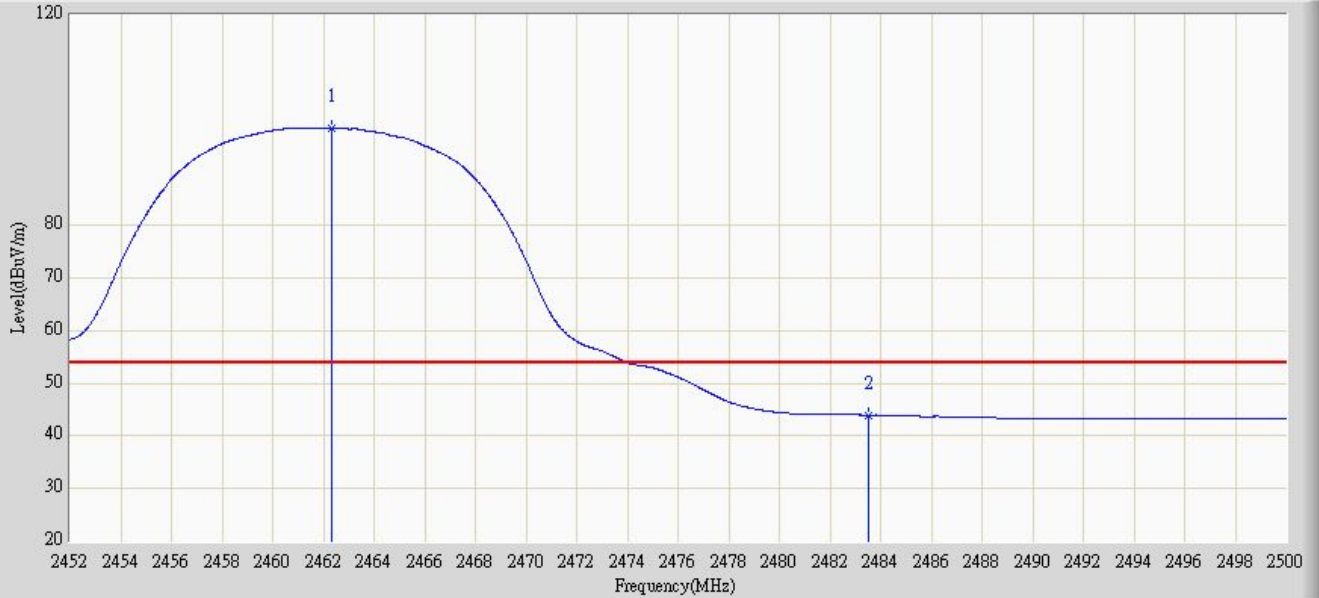

No	Mark	Frequency (MHz)	Measure Level (dBuV/m)	Reading Level (dBuV)	Over Limit (dB)	Limit (dBuV/m)	Factor (dB)	Type
1	*	2462.344	98.479	66.887	N/A	N/A	31.592	AV
2		2483.500	43.931	12.318	-10.069	54.000	31.613	AV

Engineer: Sunny	
Site: AC5	Time: 2014/01/20 - 20:09
Limit: FCC Part15.209 RE(3m)	Margin: 0
Probe: BBHA 9120D_499(1-18GHz)	Polarity: Horizontal
EUT: Tablet PC	Power:By Battery
Note: Mode2: Transmit at channel 2412 by 802.11g	

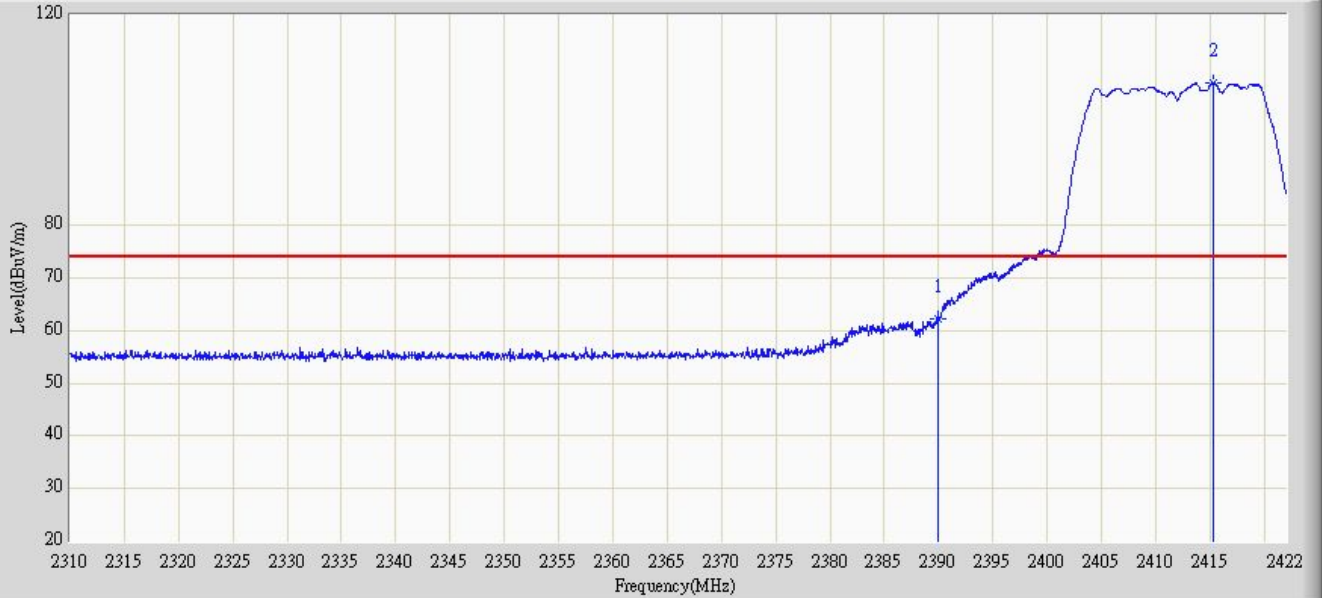

No	Mark	Frequency (MHz)	Measure Level (dBuV/m)	Reading Level (dBuV)	Over Limit (dB)	Limit (dBuV/m)	Factor (dB)	Type
1		2390.000	62.162	31.074	-11.838	74.000	31.088	PK
2	*	2415.280	107.157	75.897	N/A	N/A	31.260	PK

Engineer: Sunny	
Site: AC5	Time: 2014/01/20 - 20:14
Limit: FCC Part15.209 RE(3m)	Margin: 0
Probe: BBHA 9120D_499(1-18GHz)	Polarity: Horizontal
EUT: Tablet PC	Power:By Battery
Note: Mode2: Transmit at channel 2412 by 802.11g	

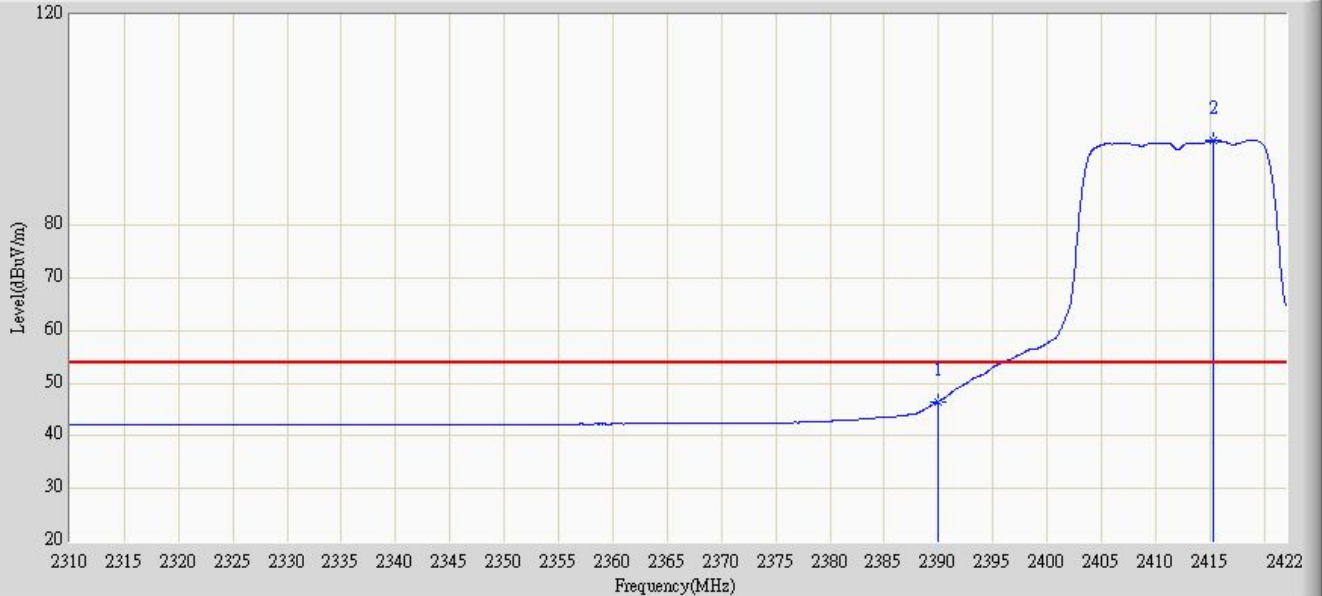

No	Mark	Frequency (MHz)	Measure Level (dBuV/m)	Reading Level (dBuV)	Over Limit (dB)	Limit (dBuV/m)	Factor (dB)	Type
1		2390.000	46.546	15.458	-7.454	54.000	31.088	AV
2	*	2415.280	96.112	64.852	N/A	N/A	31.260	AV

Engineer: Sunny	
Site: AC5	Time: 2014/01/20 - 20:21
Limit: FCC Part15.209 RE(3m)	Margin: 0
Probe: BBHA 9120D_499(1-18GHz)	Polarity: Vertical
EUT: Tablet PC	Power:By Battery
Note: Mode2: Transmit at channel 2412 by 802.11g	

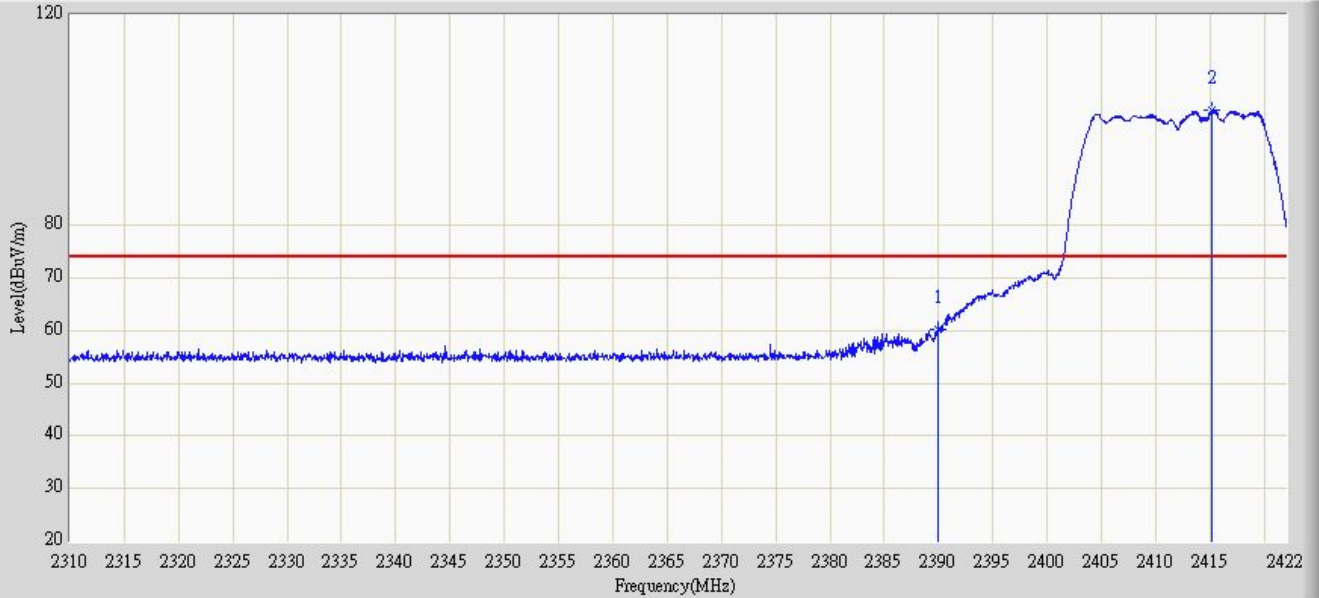

No	Mark	Frequency (MHz)	Measure Level (dBuV/m)	Reading Level (dBuV)	Over Limit (dB)	Limit (dBuV/m)	Factor (dB)	Type
1		2390.000	60.170	29.082	-13.830	74.000	31.088	PK
2	*	2415.224	101.841	70.581	N/A	N/A	31.260	PK

Engineer: Sunny	
Site: AC5	Time: 2014/01/20 - 20:23
Limit: FCC Part15.209 RE(3m)	Margin: 0
Probe: BBHA 9120D_499(1-18GHz)	Polarity: Vertical
EUT: Tablet PC	Power:By Battery
Note: Mode2: Transmit at channel 2412 by 802.11g	

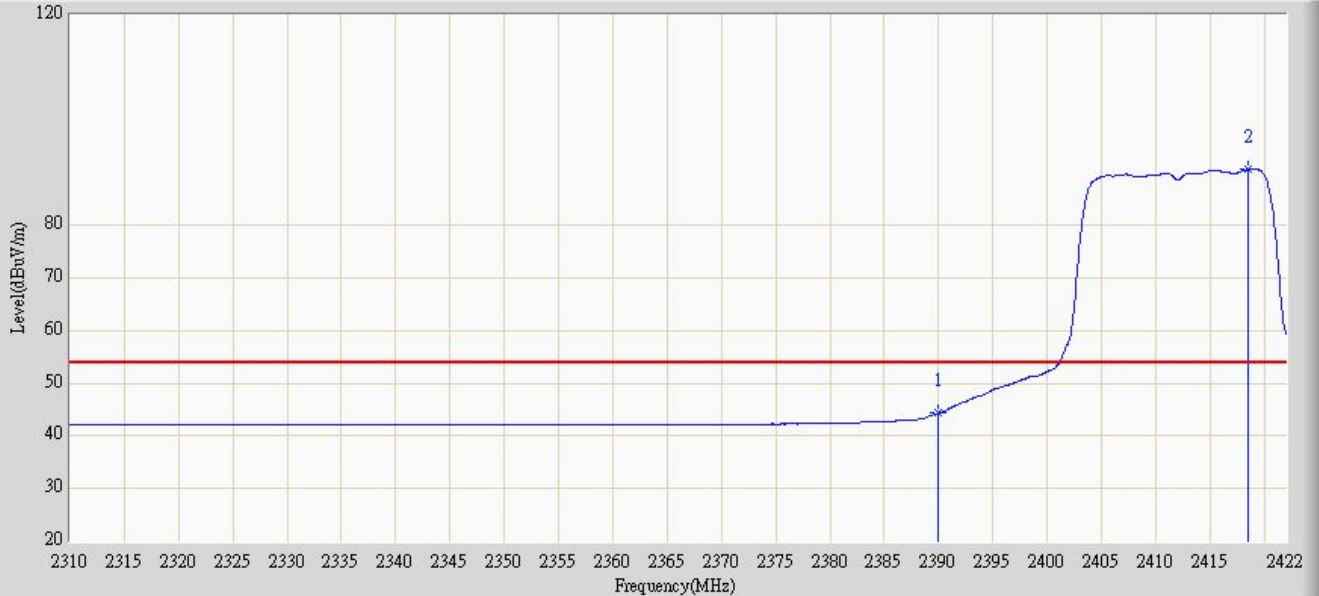

No	Mark	Frequency (MHz)	Measure Level (dBuV/m)	Reading Level (dBuV)	Over Limit (dB)	Limit (dBuV/m)	Factor (dB)	Type
1		2390.000	44.357	13.269	-9.643	54.000	31.088	AV
2	*	2418.584	90.671	59.380	N/A	N/A	31.291	AV

Engineer: Sunny	
Site: AC5	Time: 2014/01/20 - 20:25
Limit: FCC Part15.209 RE(3m)	Margin: 0
Probe: BBHA 9120D_499(1-18GHz)	Polarity: Horizontal
EUT: Tablet PC	Power:By Battery
Note: Mode2: Transmit at channel 2462 by 802.11g	



No	Mark	Frequency (MHz)	Measure Level (dBuV/m)	Reading Level (dBuV)	Over Limit (dB)	Limit (dBuV/m)	Factor (dB)	Type
1	*	2463.544	108.093	76.499	N/A	N/A	31.594	PK
2		2483.500	72.019	40.405	-1.981	74.000	31.613	PK

Engineer: Sunny	
Site: AC5	Time: 2014/01/20 - 20:30
Limit: FCC Part15.209 RE(3m)	Margin: 0
Probe: BBHA 9120D_499(1-18GHz)	Polarity: Horizontal
EUT: Tablet PC	Power:By Battery
Note: Mode2: Transmit at channel 2462 by 802.11g	

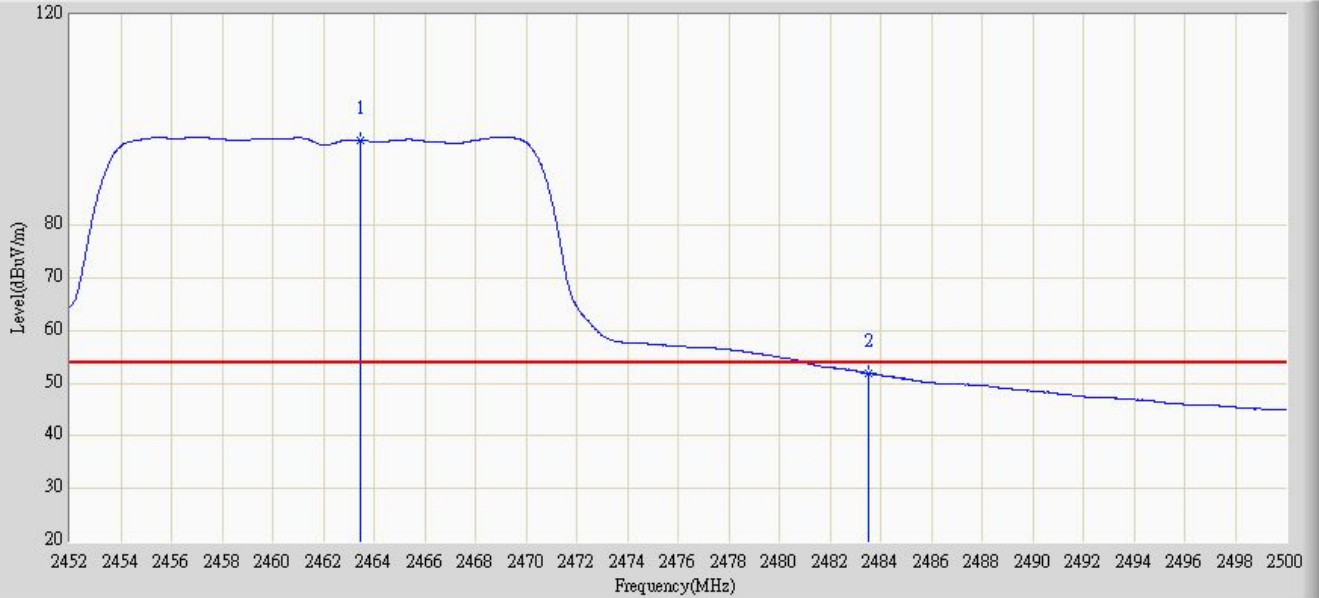

No	Mark	Frequency (MHz)	Measure Level (dBuV/m)	Reading Level (dBuV)	Over Limit (dB)	Limit (dBuV/m)	Factor (dB)	Type
1	*	2463.472	96.153	64.560	N/A	N/A	31.594	AV
2		2483.500	51.905	20.292	-2.095	54.000	31.613	AV

Engineer: Sunny	
Site: AC5	Time: 2014/01/20 - 20:35
Limit: FCC Part15.209 RE(3m)	Margin: 0
Probe: BBHA 9120D_499(1-18GHz)	Polarity: Horizontal
EUT: Tablet PC	Power:By Battery
Note: Mode2: Transmit at channel 2462 by 802.11g	



No	Mark	Frequency (MHz)	Measure Level (dBuV/m)	Reading Level (dBuV)	Over Limit (dB)	Limit (dBuV/m)	Factor (dB)	Type
1	*	2463.472	105.908	74.315	N/A	N/A	31.594	PK
2		2483.500	70.881	39.267	-3.119	74.000	31.613	PK

Engineer: Sunny	
Site: AC5	Time: 2014/01/20 - 20:39
Limit: FCC Part15.209 RE(3m)	Margin: 0
Probe: BBHA 9120D_499(1-18GHz)	Polarity: Horizontal
EUT: Tablet PC	Power:By Battery
Note: Mode2: Transmit at channel 2462 by 802.11g	

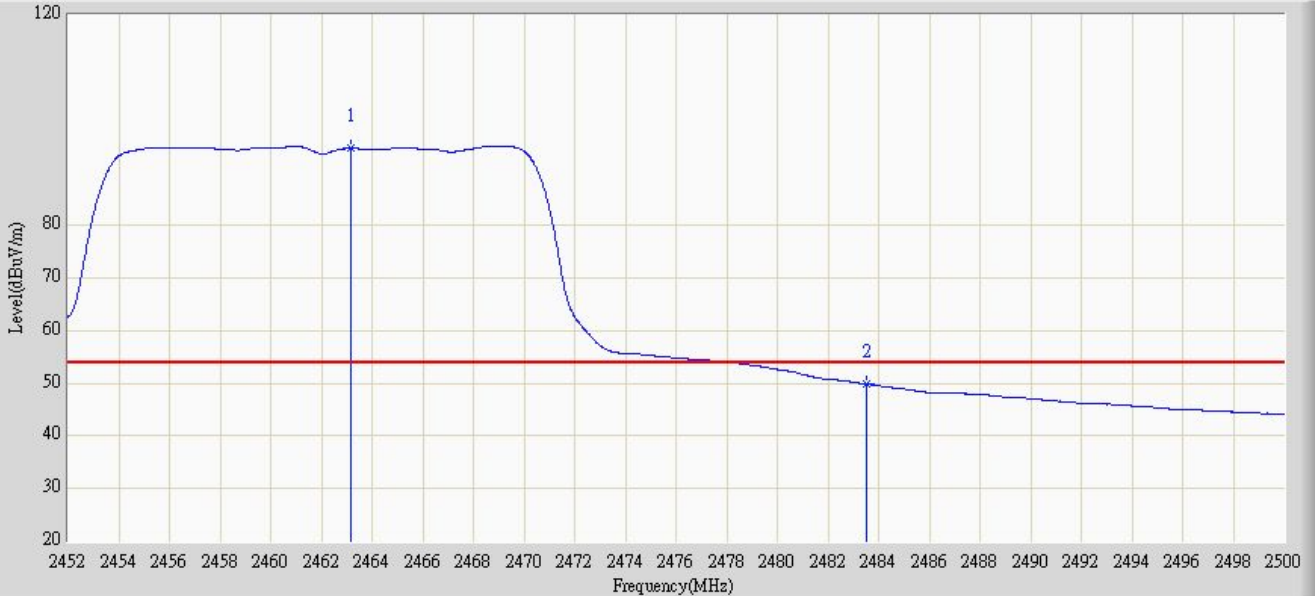

No	Mark	Frequency (MHz)	Measure Level (dBuV/m)	Reading Level (dBuV)	Over Limit (dB)	Limit (dBuV/m)	Factor (dB)	Type
1	*	2463.160	94.574	62.981	N/A	N/A	31.593	AV
2		2483.500	49.892	18.279	-4.108	54.000	31.613	AV

Engineer: Sunny	
Site: AC5	Time: 2014/01/20 - 20:41
Limit: FCC Part15.209 RE(3m)	Margin: 0
Probe: BBHA 9120D_499(1-18GHz)	Polarity: Horizontal
EUT: Tablet PC	Power:By Battery
Note: Mode3: Transmit at channel 2412 by 802.11n20	

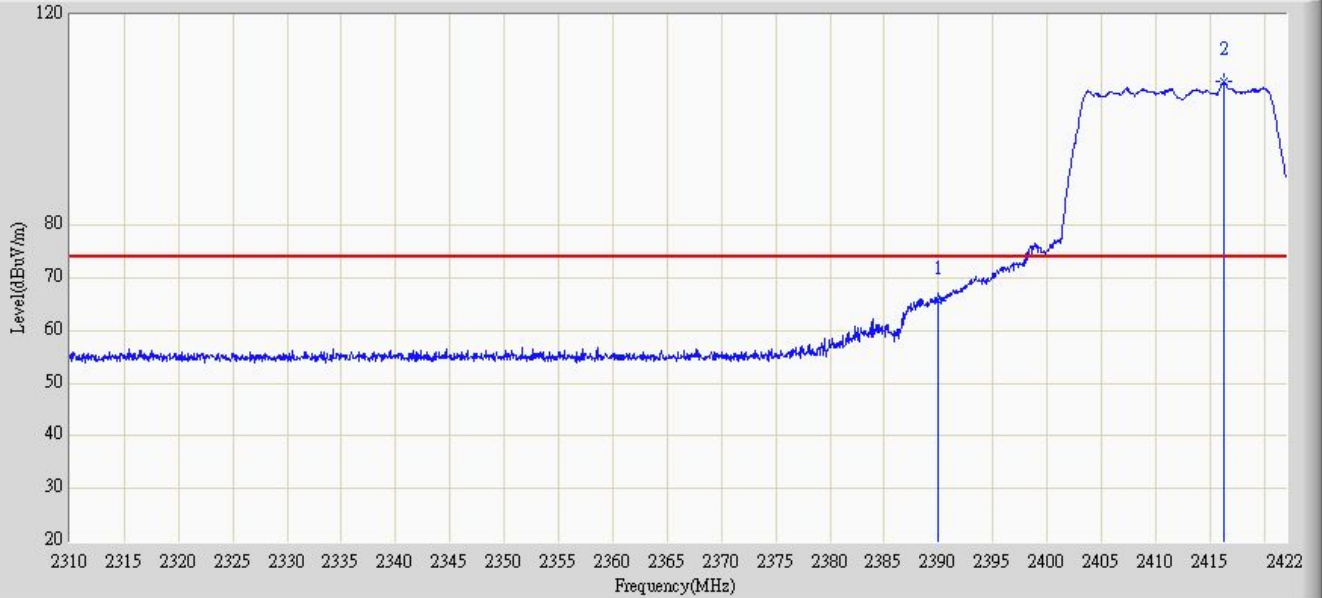

No	Mark	Frequency (MHz)	Measure Level (dBuV/m)	Reading Level (dBuV)	Over Limit (dB)	Limit (dBuV/m)	Factor (dB)	Type
1		2390.000	65.819	34.731	-8.181	74.000	31.088	PK
2	*	2416.344	107.247	75.977	N/A	N/A	31.270	PK

Engineer: Sunny	
Site: AC5	Time: 2014/01/20 - 20:47
Limit: FCC Part15.209 RE(3m)	Margin: 0
Probe: BBHA 9120D_499(1-18GHz)	Polarity: Horizontal
EUT: Tablet PC	Power:By Battery
Note: Mode3: Transmit at channel 2412 by 802.11n20	

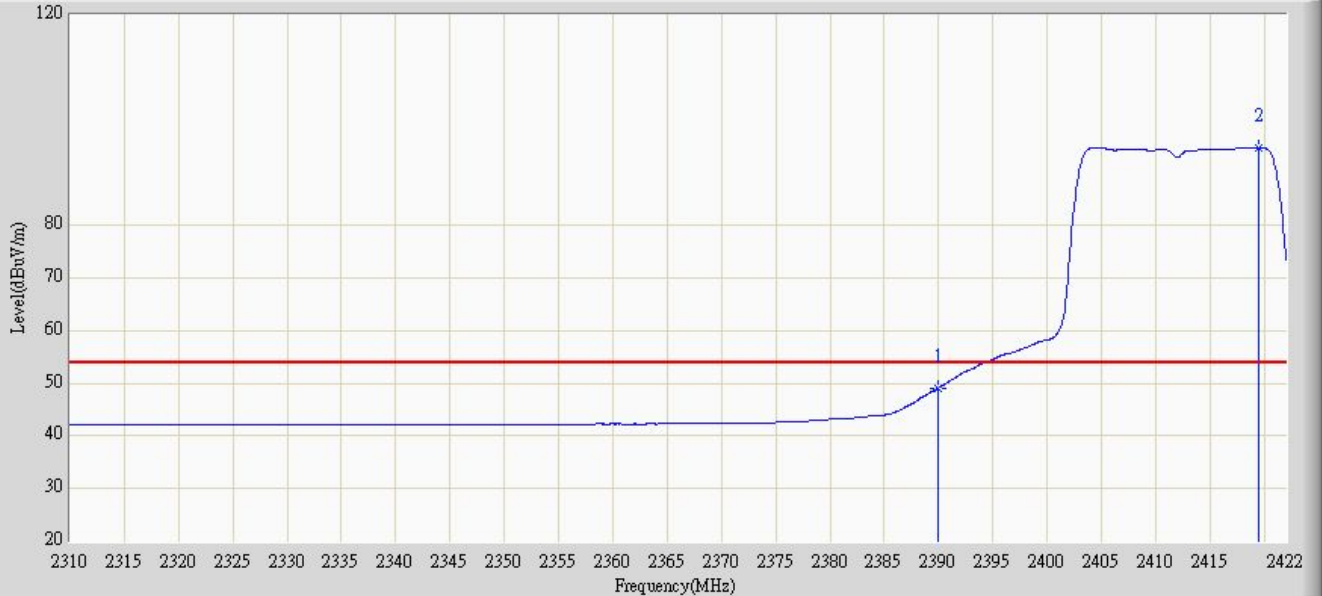

No	Mark	Frequency (MHz)	Measure Level (dBuV/m)	Reading Level (dBuV)	Over Limit (dB)	Limit (dBuV/m)	Factor (dB)	Type
1		2390.000	49.126	18.038	-4.874	54.000	31.088	AV
2	*	2419.480	94.714	63.415	N/A	N/A	31.299	AV

Engineer: Sunny	
Site: AC5	Time: 2014/01/20 - 20:49
Limit: FCC Part15.209 RE(3m)	Margin: 0
Probe: BBHA 9120D_499(1-18GHz)	Polarity: Vertical
EUT: Tablet PC	Power:By Battery
Note: Mode3: Transmit at channel 2412 by 802.11n20	

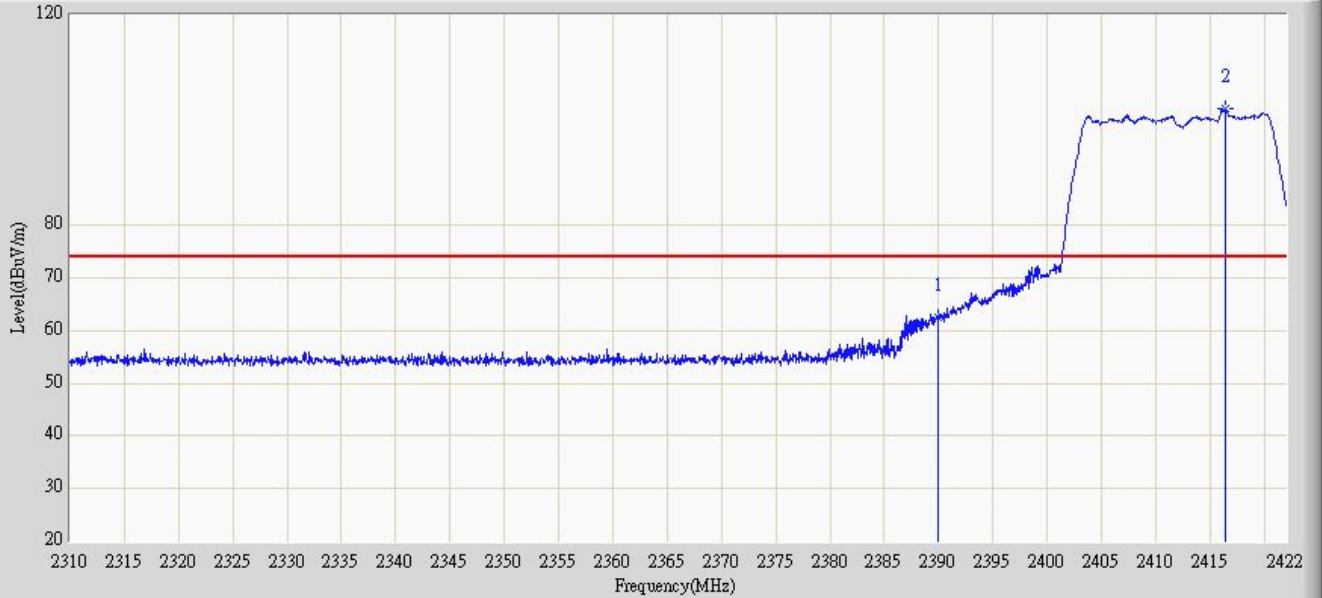

No	Mark	Frequency (MHz)	Measure Level (dBuV/m)	Reading Level (dBuV)	Over Limit (dB)	Limit (dBuV/m)	Factor (dB)	Type
1		2390.000	62.406	31.318	-11.594	74.000	31.088	PK
2	*	2416.400	102.170	70.899	N/A	N/A	31.270	PK

Engineer: Sunny	
Site: AC5	Time: 2014/01/20 - 20:51
Limit: FCC Part15.209 RE(3m)	Margin: 0
Probe: BBHA 9120D_499(1-18GHz)	Polarity: Vertical
EUT: Tablet PC	Power:By Battery
Note: Mode3: Transmit at channel 2412 by 802.11n20	

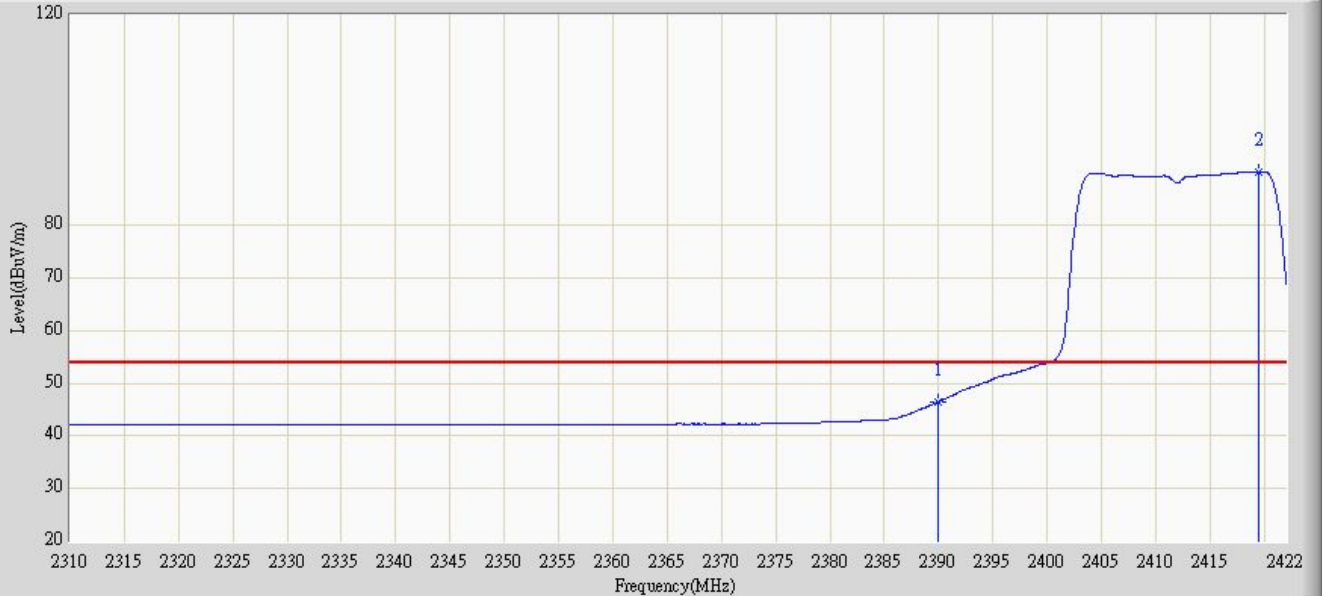

No	Mark	Frequency (MHz)	Measure Level (dBuV/m)	Reading Level (dBuV)	Over Limit (dB)	Limit (dBuV/m)	Factor (dB)	Type
1		2390.000	46.428	15.340	-7.572	54.000	31.088	AV
2	*	2419.480	90.181	58.882	N/A	N/A	31.299	AV

Engineer: Sunny	
Site: AC5	Time: 2014/01/20 - 21:00
Limit: FCC Part15.209 RE(3m)	Margin: 0
Probe: BBHA 9120D_499(1-18GHz)	Polarity: Horizontal
EUT: Tablet PC	Power:By Battery
Note: Mode3: Transmit at channel 2462 by 802.11n20	

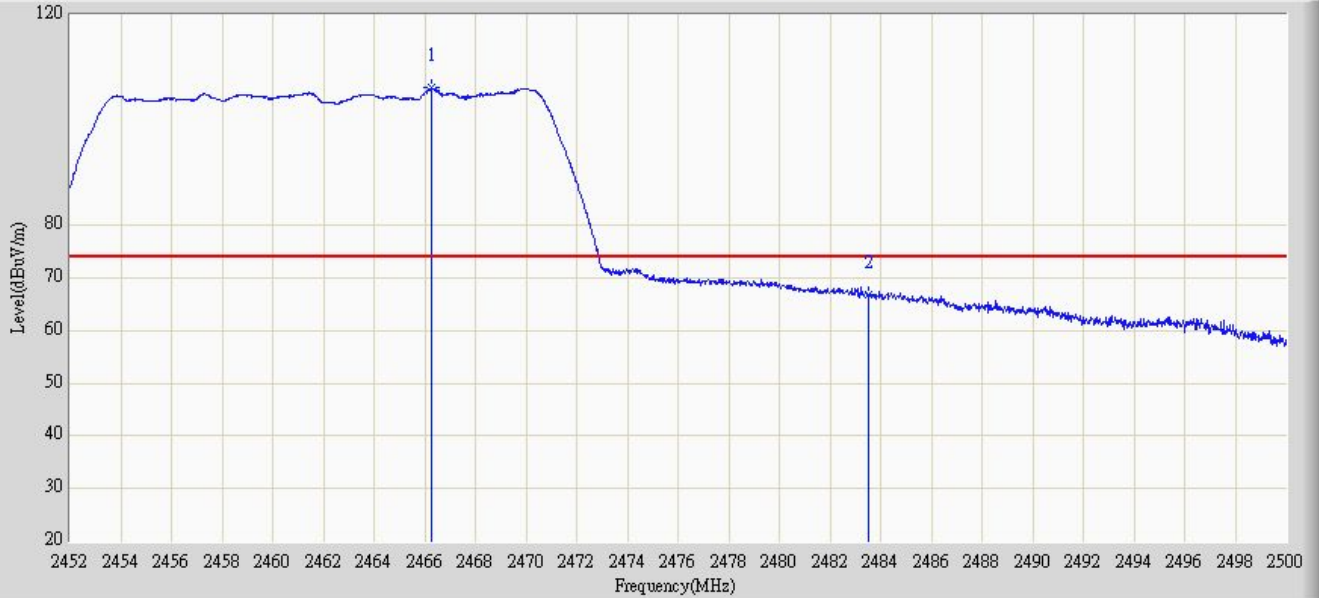

No	Mark	Frequency (MHz)	Measure Level (dBuV/m)	Reading Level (dBuV)	Over Limit (dB)	Limit (dBuV/m)	Factor (dB)	Type
1	*	2466.280	106.112	74.516	N/A	N/A	31.596	PK
2		2483.500	66.955	35.341	-7.045	74.000	31.613	PK

Engineer: Sunny	
Site: AC5	Time: 2014/01/20 - 21:09
Limit: FCC Part15.209 RE(3m)	Margin: 0
Probe: BBHA 9120D_499(1-18GHz)	Polarity: Horizontal
EUT: Tablet PC	Power:By Battery
Note: Mode3: Transmit at channel 2462 by 802.11n20	

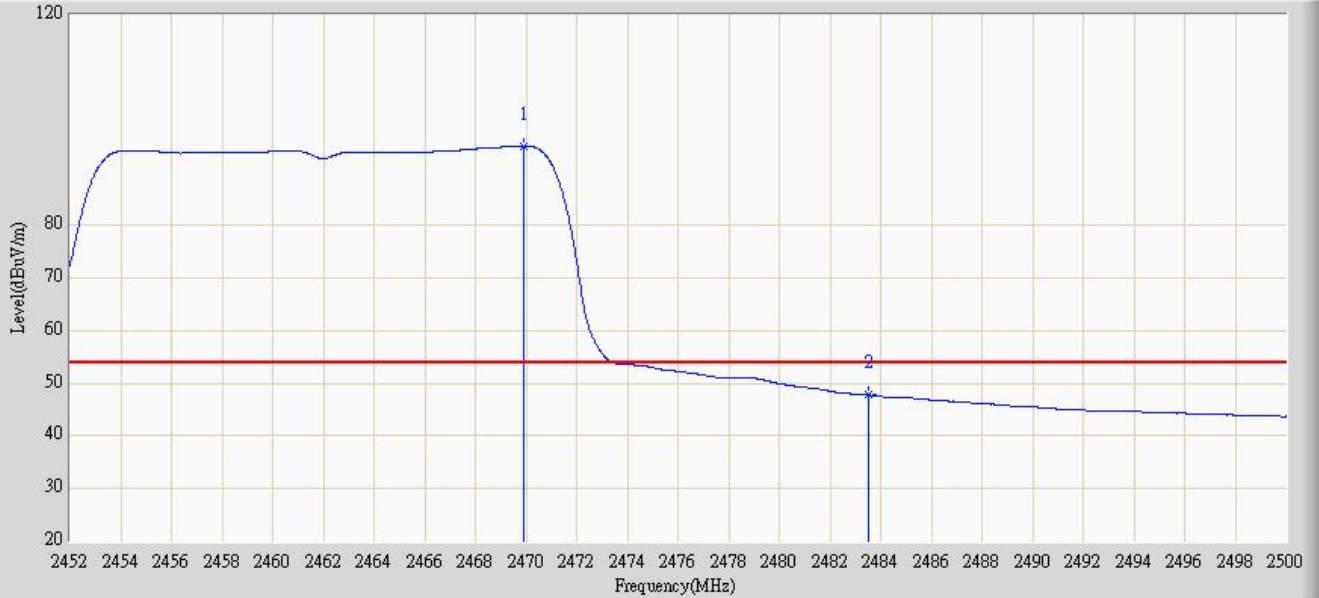

No	Mark	Frequency (MHz)	Measure Level (dBuV/m)	Reading Level (dBuV)	Over Limit (dB)	Limit (dBuV/m)	Factor (dB)	Type
1	*	2469.928	95.025	63.425	N/A	N/A	31.600	AV
2		2483.500	47.794	16.180	-6.206	54.000	31.613	AV

Engineer: Sunny	
Site: AC5	Time: 2014/01/20 - 21:11
Limit: FCC Part15.209 RE(3m)	Margin: 0
Probe: BBHA 9120D_499(1-18GHz)	Polarity: Vertical
EUT: Tablet PC	Power:By Battery
Note: Mode3: Transmit at channel 2462 by 802.11n20	

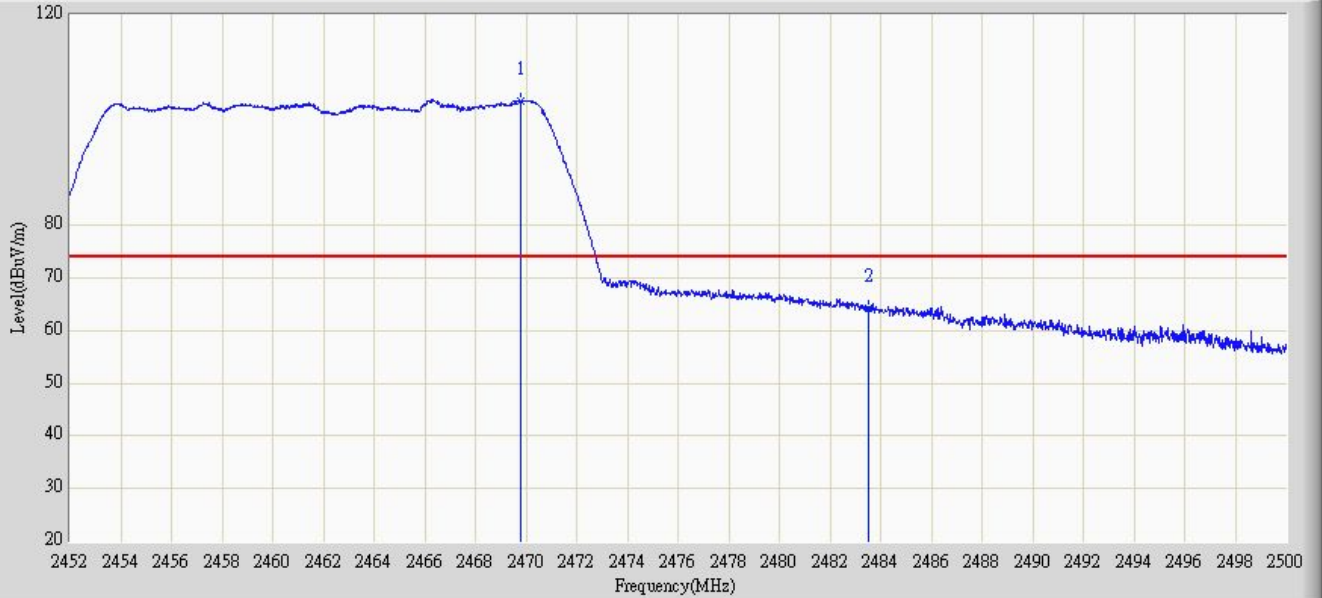

No	Mark	Frequency (MHz)	Measure Level (dBuV/m)	Reading Level (dBuV)	Over Limit (dB)	Limit (dBuV/m)	Factor (dB)	Type
1	*	2469.784	103.755	72.155	N/A	N/A	31.599	PK
2		2483.500	64.184	32.570	-9.816	74.000	31.613	PK

Engineer: Sunny	
Site: AC5	Time: 2014/01/20 - 21:13
Limit: FCC Part15.209 RE(3m)	Margin: 0
Probe: BBHA 9120D_499(1-18GHz)	Polarity: Vertical
EUT: Tablet PC	Power:By Battery
Note: Mode3: Transmit at channel 2462 by 802.11n20	

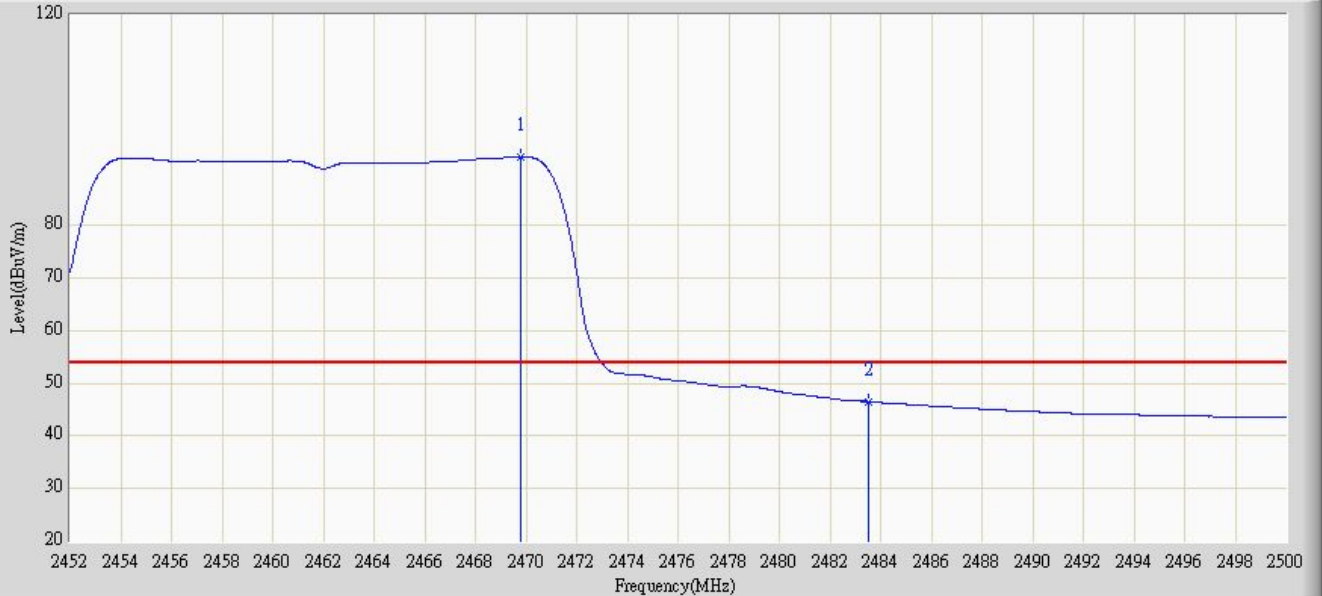

No	Mark	Frequency (MHz)	Measure Level (dBuV/m)	Reading Level (dBuV)	Over Limit (dB)	Limit (dBuV/m)	Factor (dB)	Type
1	*	2469.784	92.938	61.338	N/A	N/A	31.599	AV
2		2483.500	46.544	14.931	-7.456	54.000	31.613	AV

Engineer: Sunny	
Site: AC5	Time: 2014/01/20 - 21:15
Limit: FCC Part15.209 RE(3m)	Margin: 0
Probe: BBHA 9120D_499(1-18GHz)	Polarity: Horizontal
EUT: Tablet PC	Power:By Battery
Note: Mode4: Transmit at channel 2422 by 802.11n40	

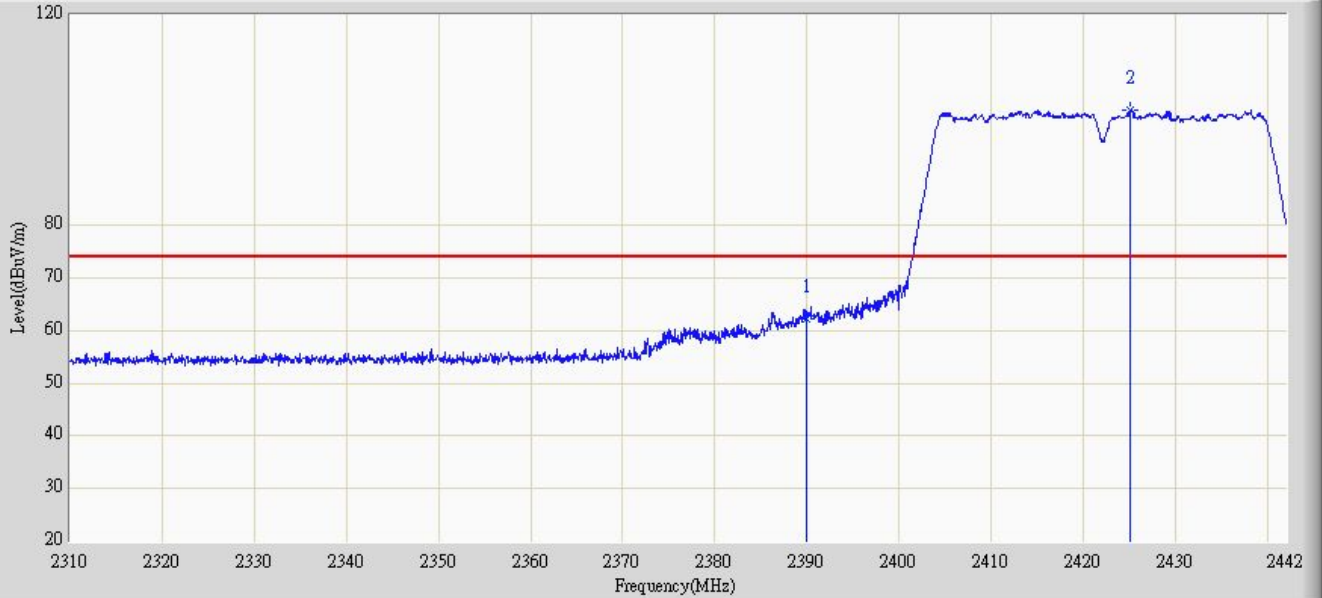

No	Mark	Frequency (MHz)	Measure Level (dBuV/m)	Reading Level (dBuV)	Over Limit (dB)	Limit (dBuV/m)	Factor (dB)	Type
1		2390.000	62.336	31.248	-11.664	74.000	31.088	PK
2	*	2425.170	101.977	70.626	N/A	N/A	31.351	PK

Engineer: Sunny	
Site: AC5	Time: 2014/01/20 - 21:18
Limit: FCC Part15.209 RE(3m)	Margin: 0
Probe: BBHA 9120D_499(1-18GHz)	Polarity: Horizontal
EUT: Tablet PC	Power:By Battery
Note: Mode4: Transmit at channel 2422 by 802.11n40	

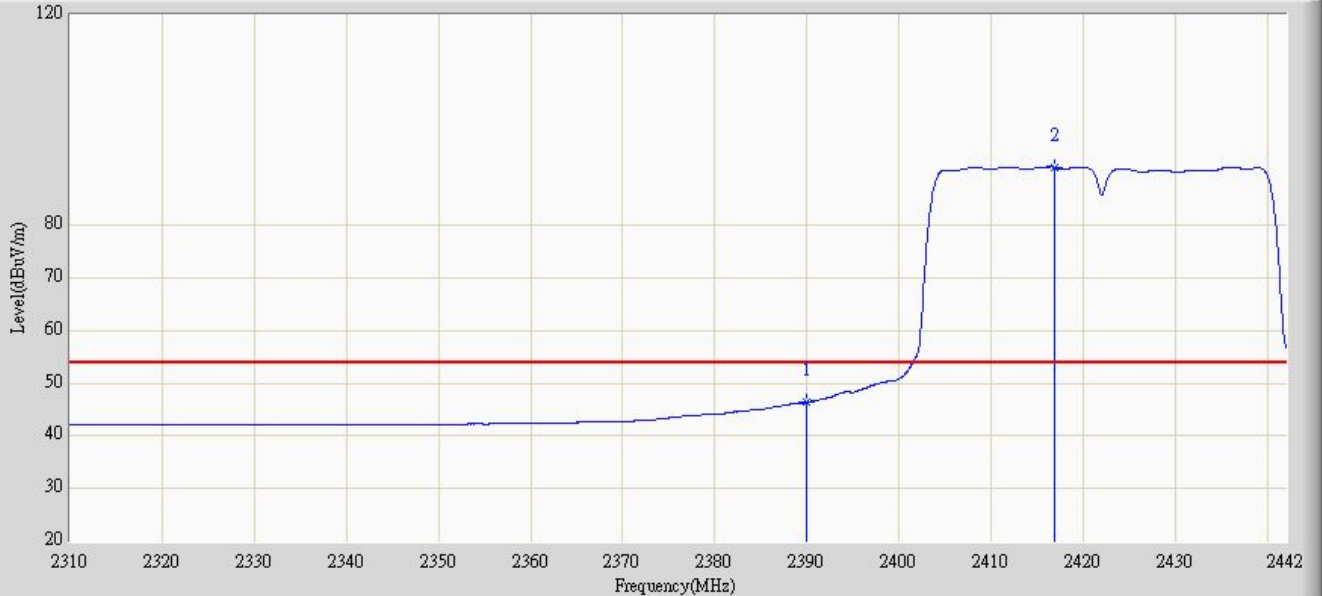

No	Mark	Frequency (MHz)	Measure Level (dBuV/m)	Reading Level (dBuV)	Over Limit (dB)	Limit (dBuV/m)	Factor (dB)	Type
1		2390.000	46.439	15.351	-7.561	54.000	31.088	AV
2	*	2416.920	91.019	59.744	N/A	N/A	31.275	AV

Engineer: Sunny	
Site: AC5	Time: 2014/01/20 - 21:20
Limit: FCC Part15.209 RE(3m)	Margin: 0
Probe: BBHA 9120D_499(1-18GHz)	Polarity: Vertical
EUT: Tablet PC	Power:By Battery
Note: Mode4: Transmit at channel 2422 by 802.11n40	

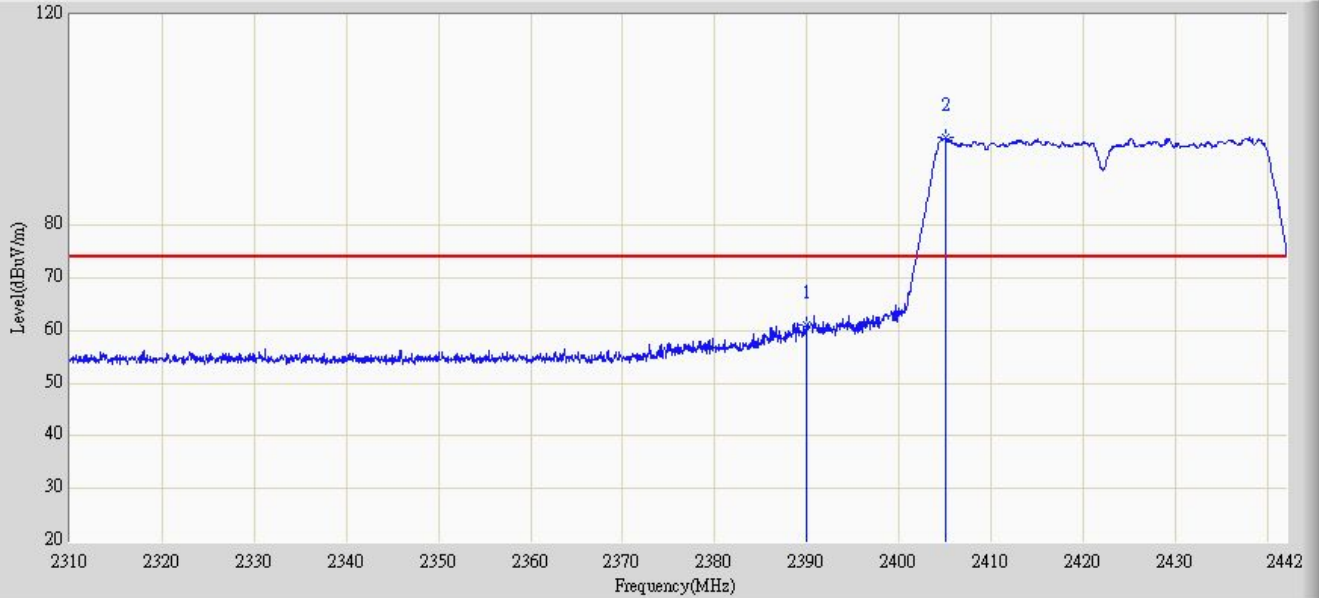

No	Mark	Frequency (MHz)	Measure Level (dBuV/m)	Reading Level (dBuV)	Over Limit (dB)	Limit (dBuV/m)	Factor (dB)	Type
1		2390.000	61.093	30.005	-12.907	74.000	31.088	PK
2	*	2405.040	96.637	65.458	N/A	N/A	31.179	PK

Engineer: Sunny	
Site: AC5	Time: 2014/01/20 - 21:23
Limit: FCC Part15.209 RE(3m)	Margin: 0
Probe: BBHA 9120D_499(1-18GHz)	Polarity: Vertical
EUT: Tablet PC	Power:By Battery
Note: Mode4: Transmit at channel 2422 by 802.11n40	

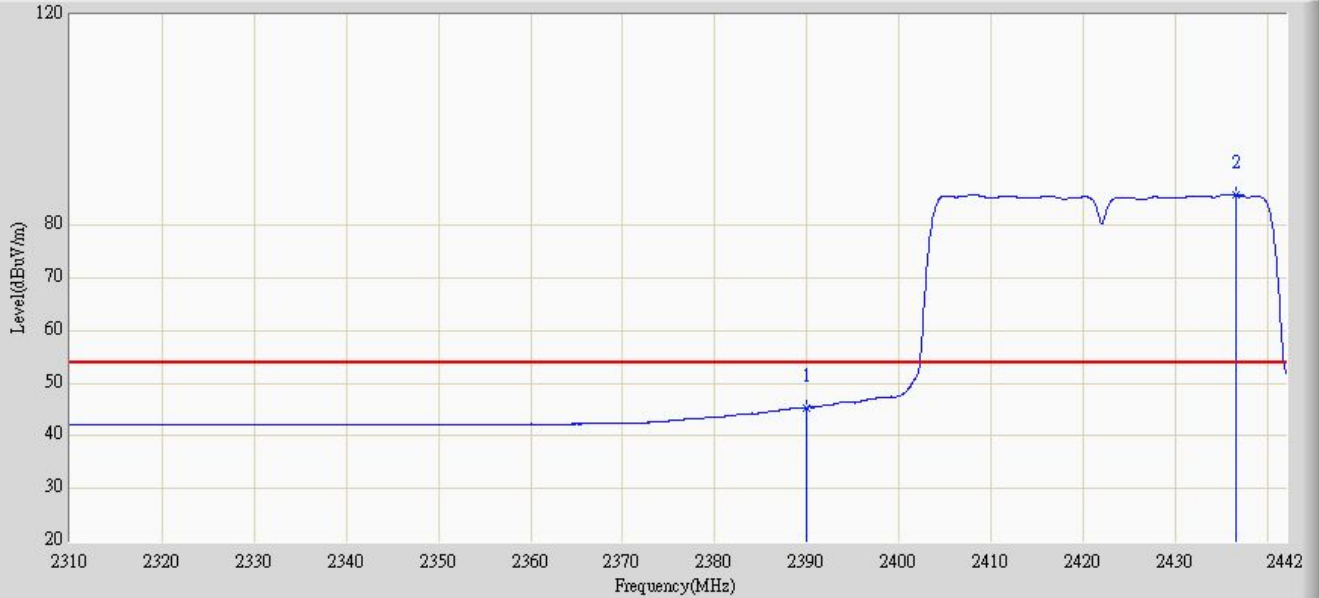

No	Mark	Frequency (MHz)	Measure Level (dBuV/m)	Reading Level (dBuV)	Over Limit (dB)	Limit (dBuV/m)	Factor (dB)	Type
1		2390.000	45.353	14.265	-8.647	54.000	31.088	AV
2	*	2436.588	85.772	54.316	N/A	N/A	31.456	AV

Engineer: Sunny	
Site: AC5	Time: 2014/01/20 - 21:27
Limit: FCC Part15.209 RE(3m)	Margin: 0
Probe: BBHA 9120D_499(1-18GHz)	Polarity: Horizontal
EUT: Tablet PC	Power:By Battery
Note: Mode4: Transmit at channel 2452 by 802.11n40	

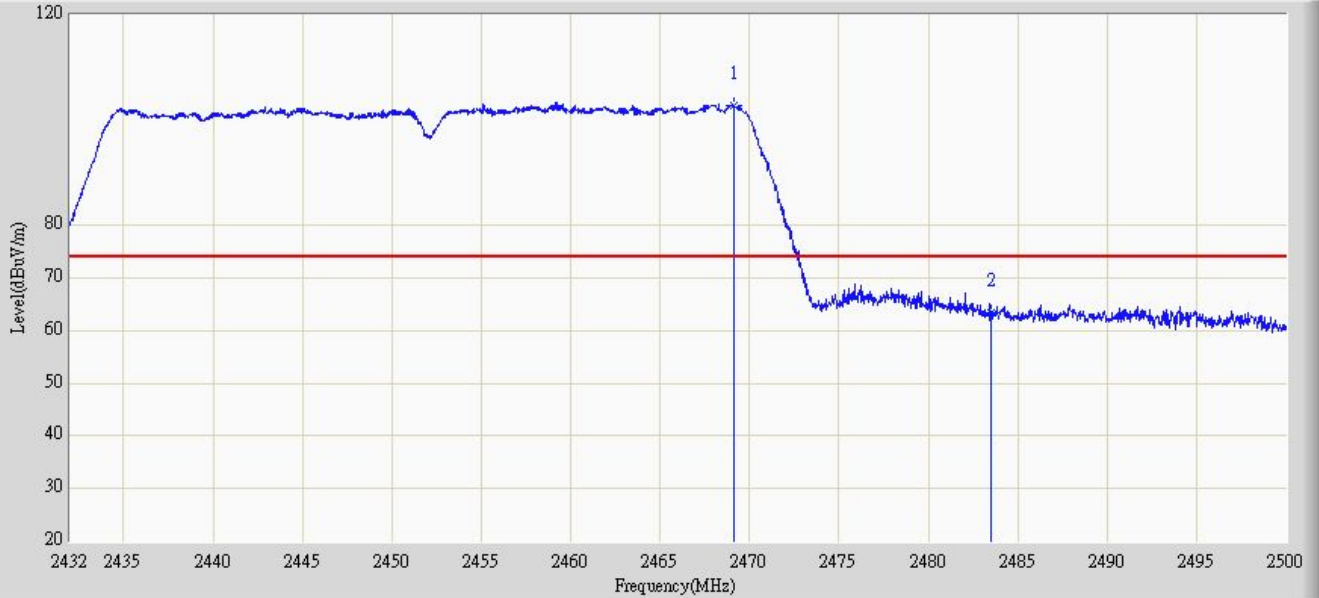

No	Mark	Frequency (MHz)	Measure Level (dBuV/m)	Reading Level (dBuV)	Over Limit (dB)	Limit (dBuV/m)	Factor (dB)	Type
1	*	2469.094	102.793	71.194	N/A	N/A	31.599	PK
2		2483.500	63.449	31.835	-10.551	74.000	31.613	PK

Engineer: Sunny	
Site: AC5	Time: 2014/01/20 - 21:30
Limit: FCC Part15.209 RE(3m)	Margin: 0
Probe: BBHA 9120D_499(1-18GHz)	Polarity: Horizontal
EUT: Tablet PC	Power:By Battery
Note: Mode4: Transmit at channel 2452 by 802.11n40	

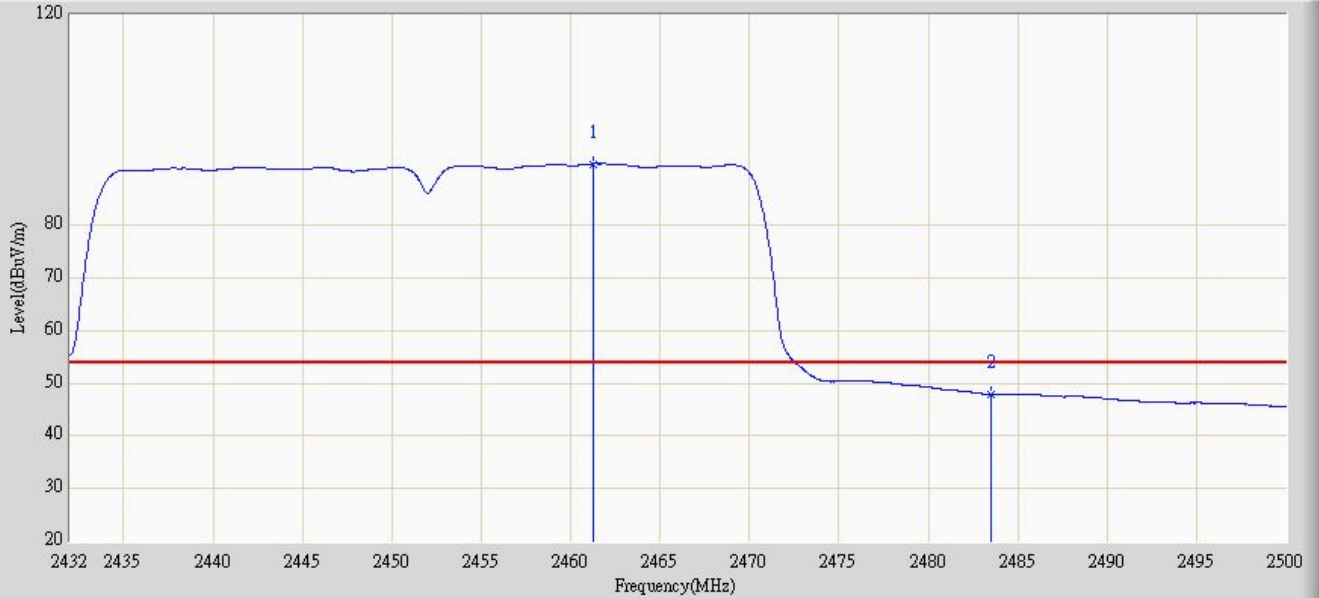

No	Mark	Frequency (MHz)	Measure Level (dBuV/m)	Reading Level (dBuV)	Over Limit (dB)	Limit (dBuV/m)	Factor (dB)	Type
1	*	2461.240	91.688	60.099	N/A	N/A	31.589	AV
2		2483.500	47.901	16.287	-6.099	54.000	31.613	AV

Engineer: Sunny	
Site: AC5	Time: 2014/01/20 - 21:33
Limit: FCC Part15.209 RE(3m)	Margin: 0
Probe: BBHA 9120D_499(1-18GHz)	Polarity: Vertical
EUT: Tablet PC	Power:By Battery
Note: Mode4: Transmit at channel 2452 by 802.11n40	

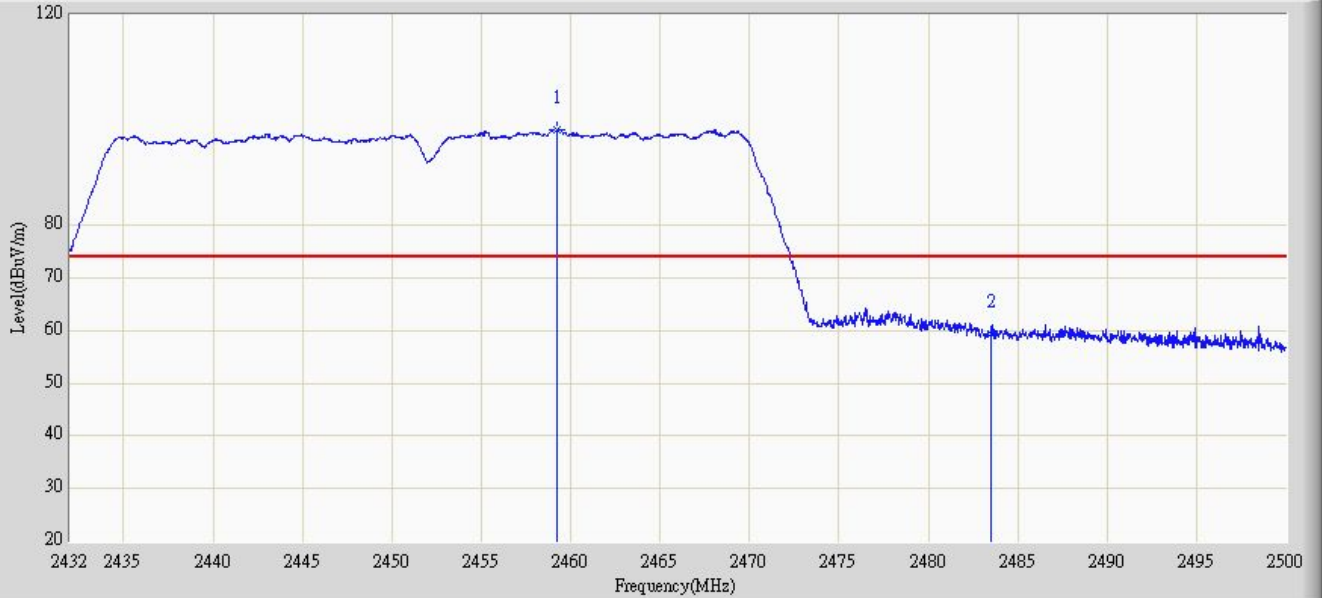

No	Mark	Frequency (MHz)	Measure Level (dBuV/m)	Reading Level (dBuV)	Over Limit (dB)	Limit (dBuV/m)	Factor (dB)	Type
1	*	2459.234	98.272	66.689	N/A	N/A	31.582	PK
2		2483.500	59.431	27.817	-14.569	74.000	31.613	PK

Engineer: Sunny	
Site: AC5	Time: 2014/01/20 - 21:35
Limit: FCC Part15.209 RE(3m)	Margin: 0
Probe: BBHA 9120D_499(1-18GHz)	Polarity: Vertical
EUT: Tablet PC	Power:By Battery
Note: Mode4: Transmit at channel 2452 by 802.11n40	

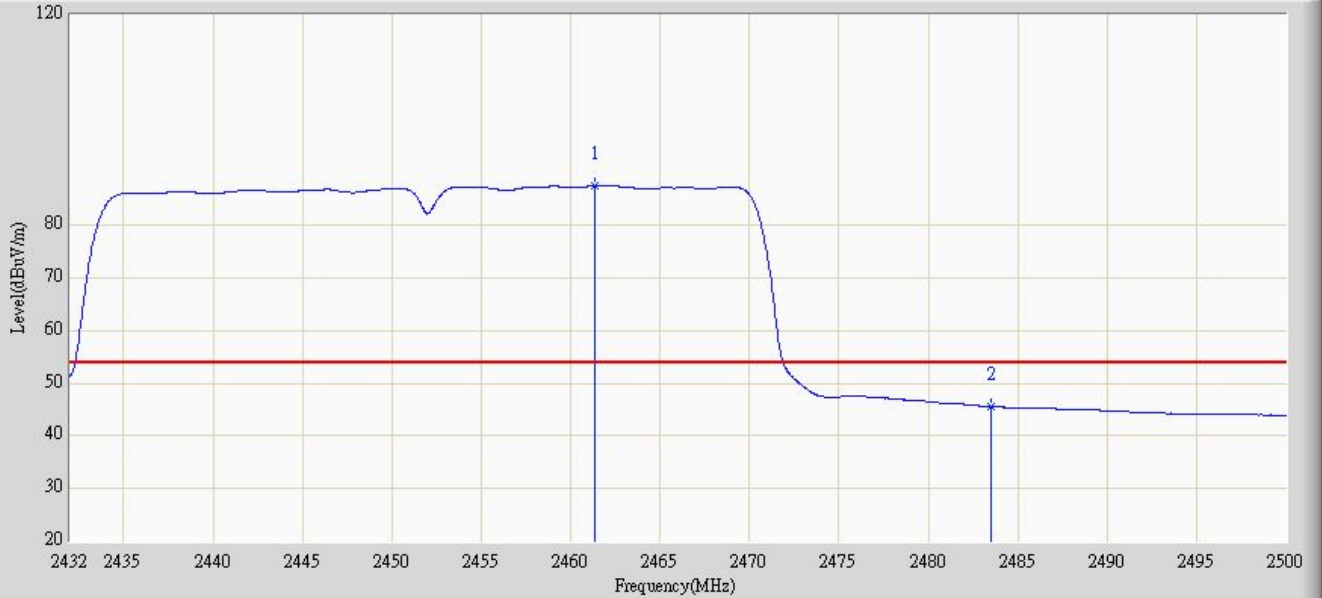

No	Mark	Frequency (MHz)	Measure Level (dBuV/m)	Reading Level (dBuV)	Over Limit (dB)	Limit (dBuV/m)	Factor (dB)	Type
1	*	2461.342	87.578	55.988	N/A	N/A	31.589	AV
2		2483.500	45.511	13.897	-8.489	54.000	31.613	AV

4.6. Power Spectral Density Measurement

TEST CONFIGURATION

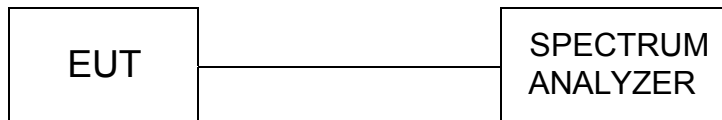

TEST PROCEDURE

The EUT was tested according to KDB558074 D01 v03r01 for compliance to FCC 47CFR 15.247 requirements.

Set RBW= 3 kHz, VBW \geq 10KHz, SPAN to 1.5 times greater than the EBW,.

LIMIT

For digitally modulated systems, the power spectral density conducted from the intentional radiator to the antenna shall not be greater than 8 dBm in any 3 kHz band during any time interval of continuous transmission.

TEST RESULTS

Product	:	HS-9DTB13-8GB
Test Item	:	Power Spectral Density
Test Mode	:	Mode 1: Transmit by 802.11b

Channel No.	Frequency (MHz)	Measurement PSD (dBm/3KHz)	Limit (dBm/3KHz)	Result
01	2412	-8.53	8	Pass
06	2437	-8.55	8	Pass
11	2462	-8.94	8	Pass

Channel 01 (2412MHz)

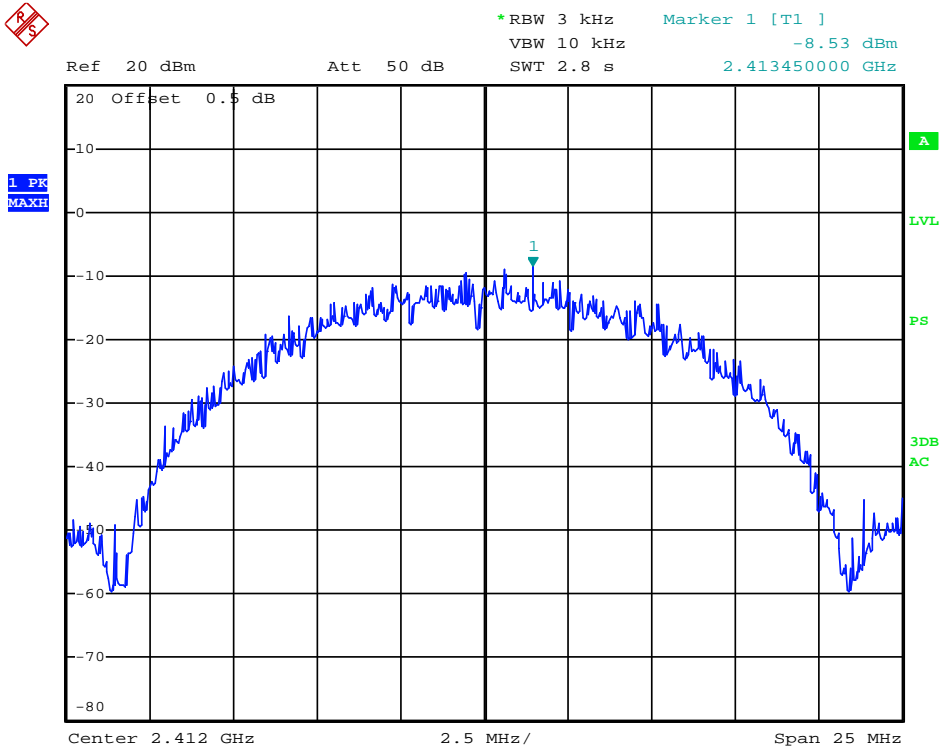

Date: 17.JAN.2014 14:34:06

Channel 06 (2437MHz)

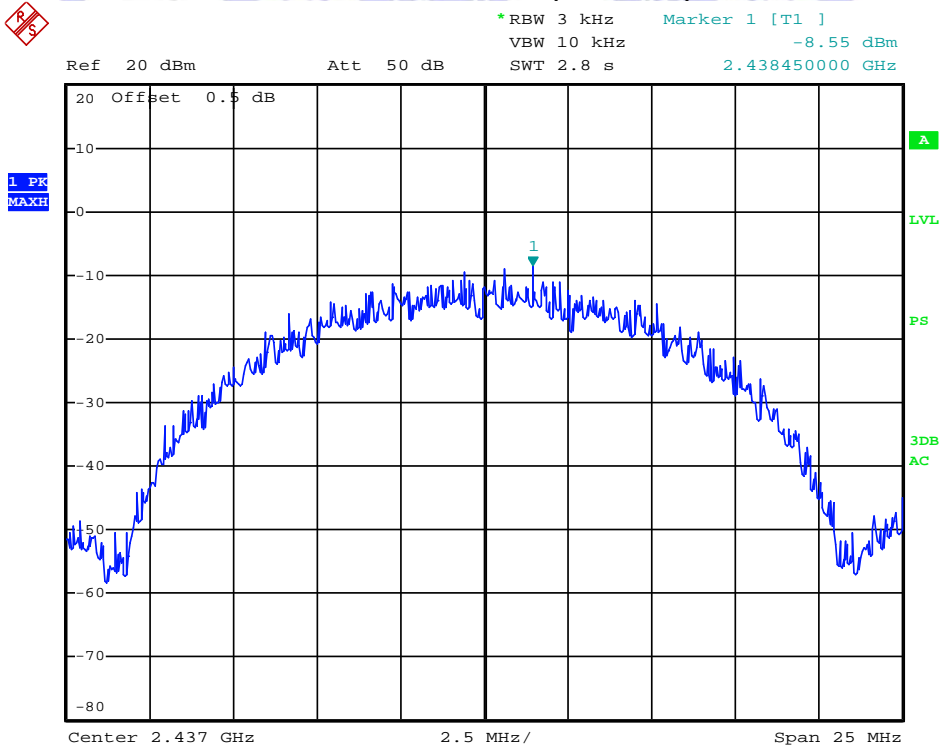

Date: 17.JAN.2014 14:34:31

Channel 11 (2462MHz)

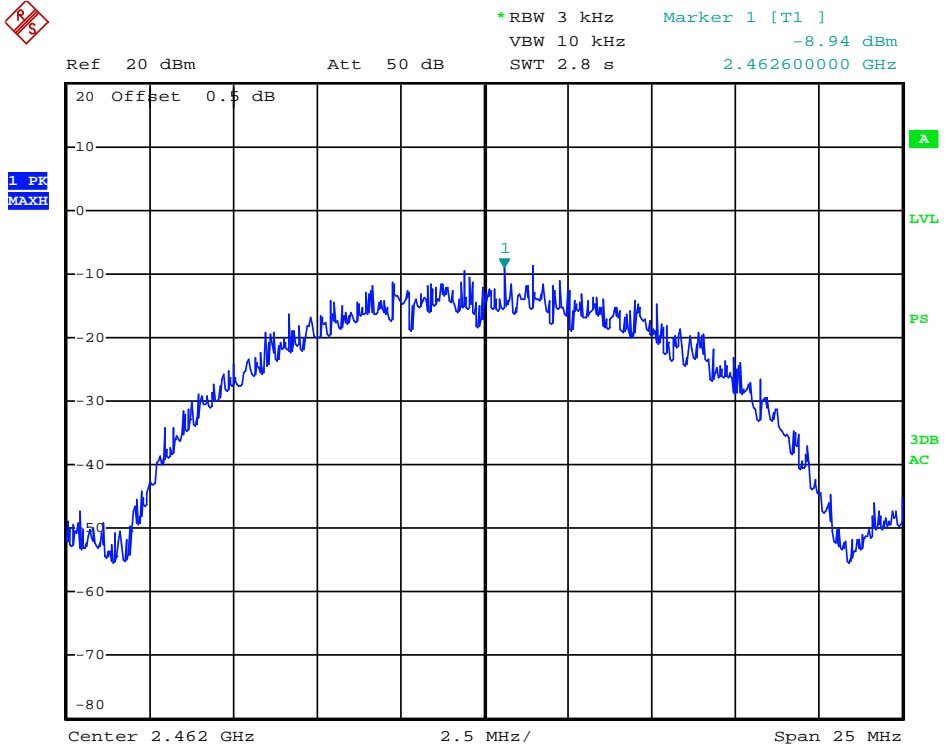

Date: 17.JAN.2014 14:35:02



Product	:	HS-9DTB13-8GB
Test Item	:	Power Spectral Density
Test Mode	:	Mode 2: Transmit by 802.11g

Channel No.	Frequency (MHz)	Measurement PSD (dBm/3KHz)	Limit (dBm/3KHz)	Result
01	2412	-16.63	8	Pass
06	2437	-16.69	8	Pass
11	2462	-16.64	8	Pass

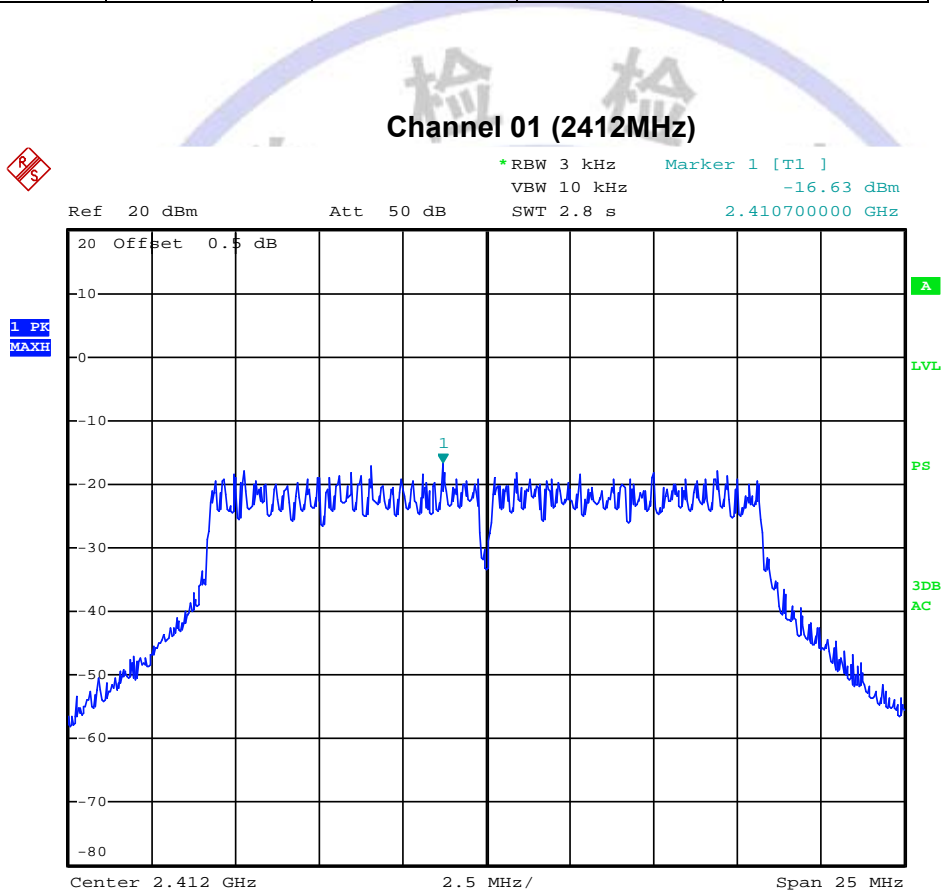

Date: 17.JAN.2014 14:33:29

Product	:	HS-9DTB13-8GB
Test Item	:	Power Spectral Density
Test Mode	:	Mode 3: Transmit by 802.11n (20MHz)

Channel No.	Frequency (MHz)	Measurement PSD (dBm/3KHz)	Limit (dBm/3KHz)	Result
01	2412	-16.32	8	Pass
06	2437	-16.70	8	Pass
11	2462	-16.29	8	Pass

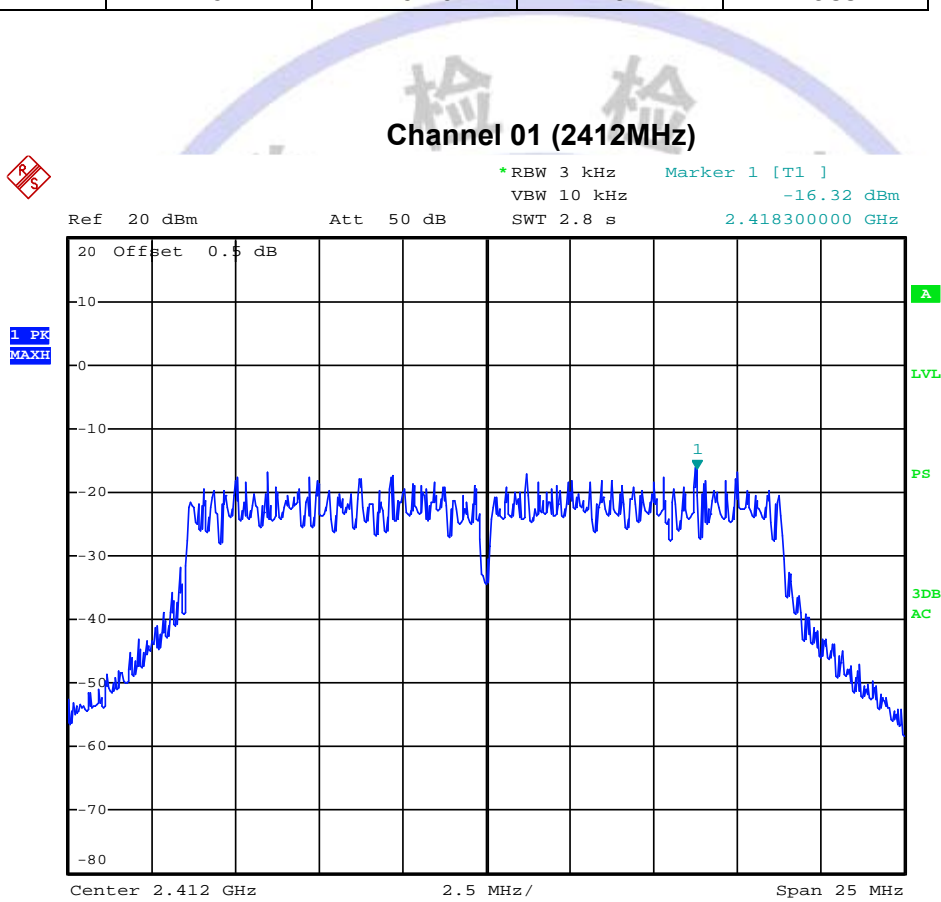

Date: 17.JAN.2014 14:31:03

Channel 06 (2437MHz)

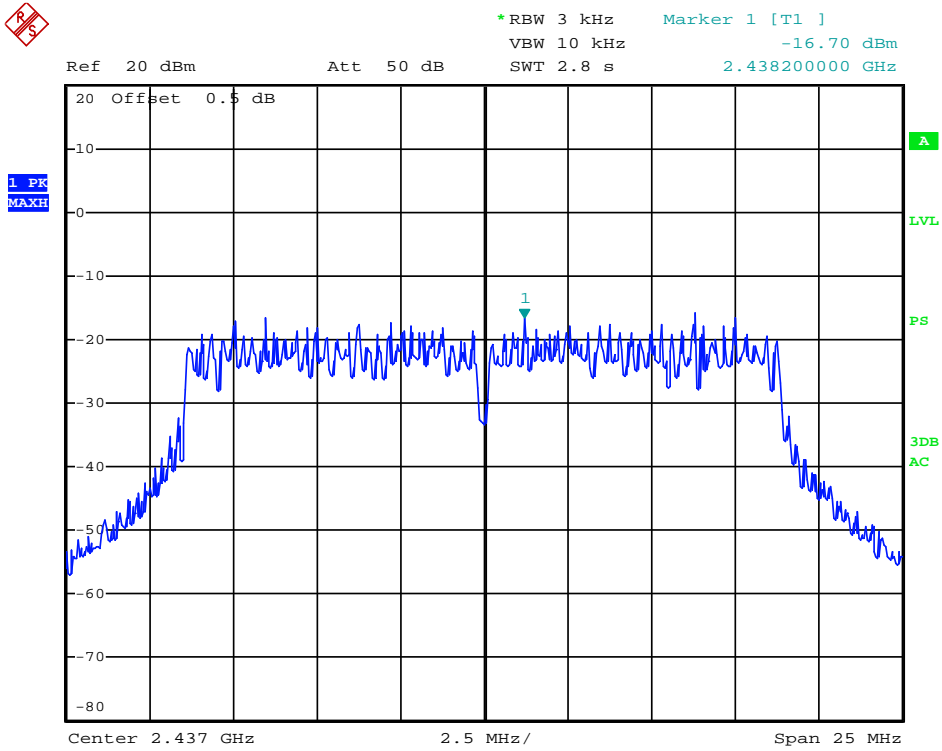

Date: 17.JAN.2014 14:31:29



Channel 11 (2462MHz)

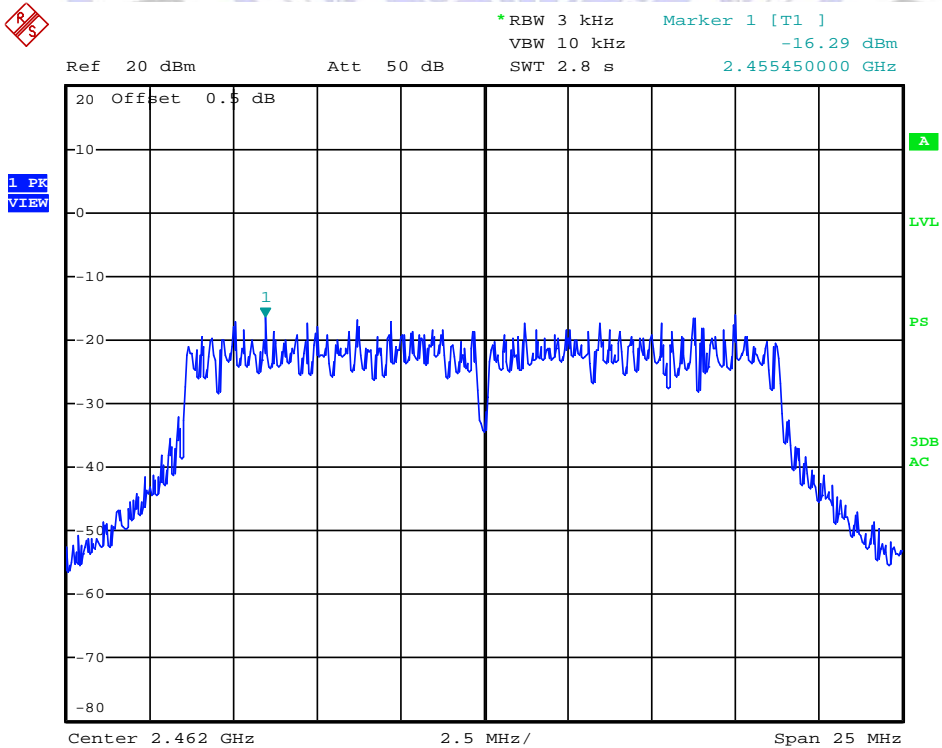

Date: 17.JAN.2014 14:32:08

Product	:	HS-9DTB13-8GB
Test Item	:	Power Spectral Density
Test Mode	:	Mode 4: Transmit by 802.11n (40MHz)

Channel No.	Frequency (MHz)	Measurement PSD (dBm/3KHz)	Limit (dBm/3KHz)	Result
03	2422	-18.23	8	Pass
06	2437	-20.22	8	Pass
09	2452	-19.92	8	Pass

Channel 03 (2422MHz)

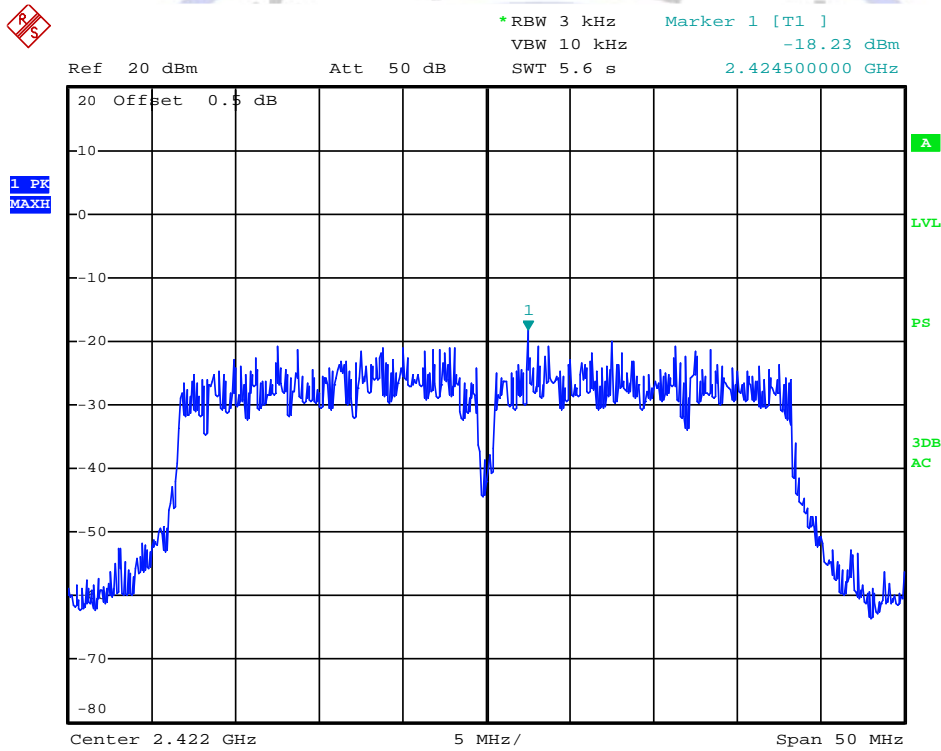

Date: 17.JAN.2014 14:30:18

4.7. Spurious RF Conducted Emission

TEST CONFIGURATION

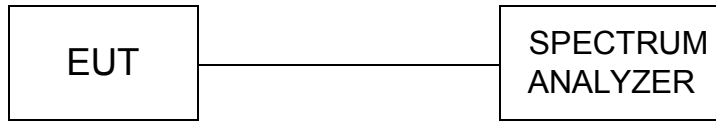

TEST PROCEDURE

The EUT was tested according to KDB558074 D01 v03r01 for compliance to FCC 47CFR 15.247 requirements.

The Spurious RF conducted emissions compliance of RF radiated emission should be measured by following the guidance in ANSI C63.10-2009 with respect to maximizing the emission by rotating the EUT, measuring the emission while the EUT is situated in three orthogonal planes (if appropriate), adjusting the measurement antenna height and polarization etc. Set RBW=100kHz and VBM= 300kHz to measure the peak field strength , and measure frequency range from 30MHz to 26.5GHz.

LIMIT

In any 100 kHz bandwidth outside the frequency band in which the spread spectrum or digitally modulated intentional radiator is operating, the radio frequency power that is produced by the intentional radiator shall be at least 20 dB below that in the 100 kHz bandwidth within the band that contains the highest level of the desired power, based on either an RF conducted or a radiated measurement, provided the transmitter demonstrates compliance with the peak conducted power limits.

TEST RESULTS

Product	:	HS-9DTB13-8GB
Test Item	:	RF Antenna Conducted Spurious
Test Mode	:	Mode 1: Transmit by 802.11b

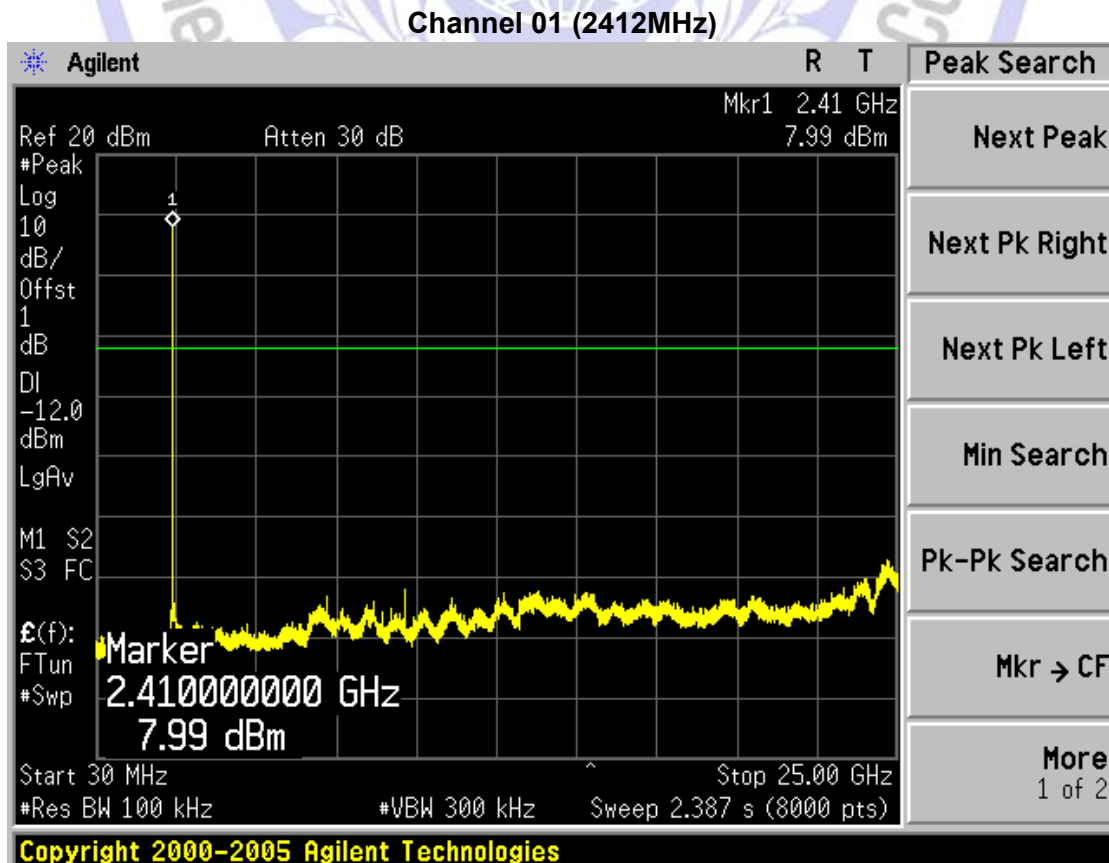

Channel 06 (2437MHz)

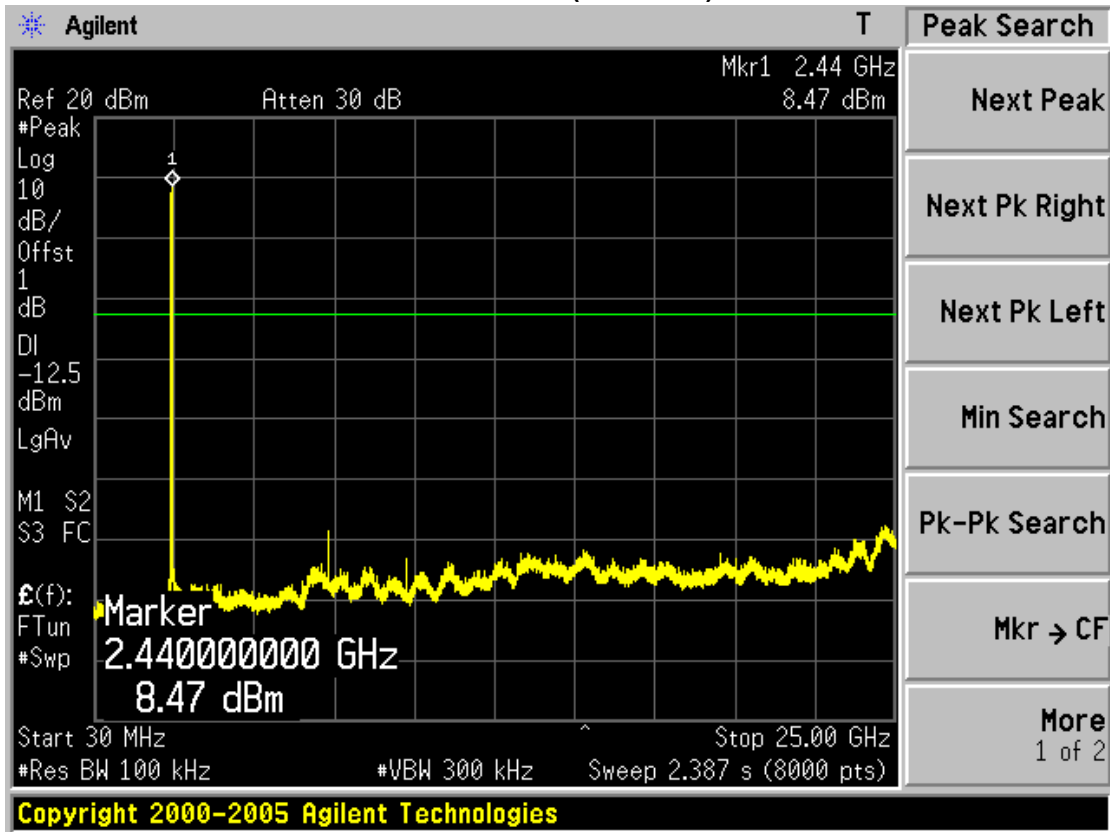

Channel 11 (2462MHz)

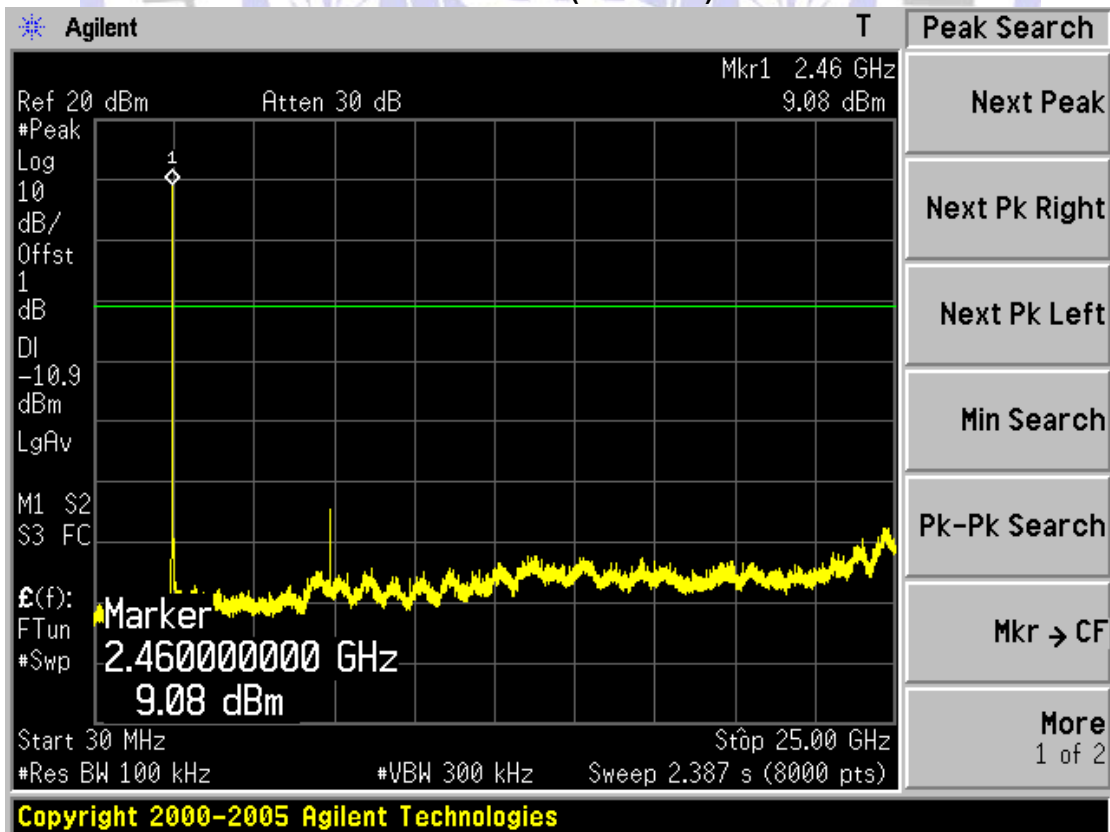

Product	:	HS-9DTB13-8GB
Test Item	:	RF Antenna Conducted Spurious
Test Mode	:	Mode 2: Transmit by 802.11g

Channel 01 (2412MHz)

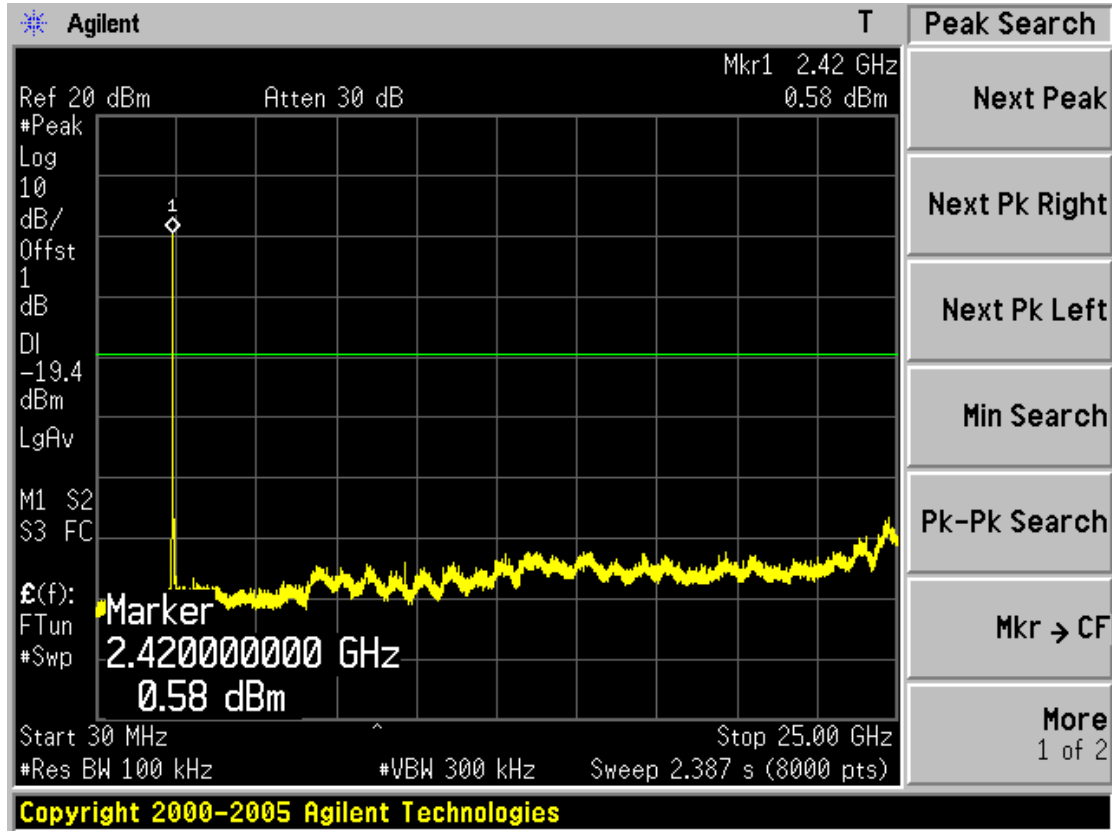

Channel 06 (2437MHz)

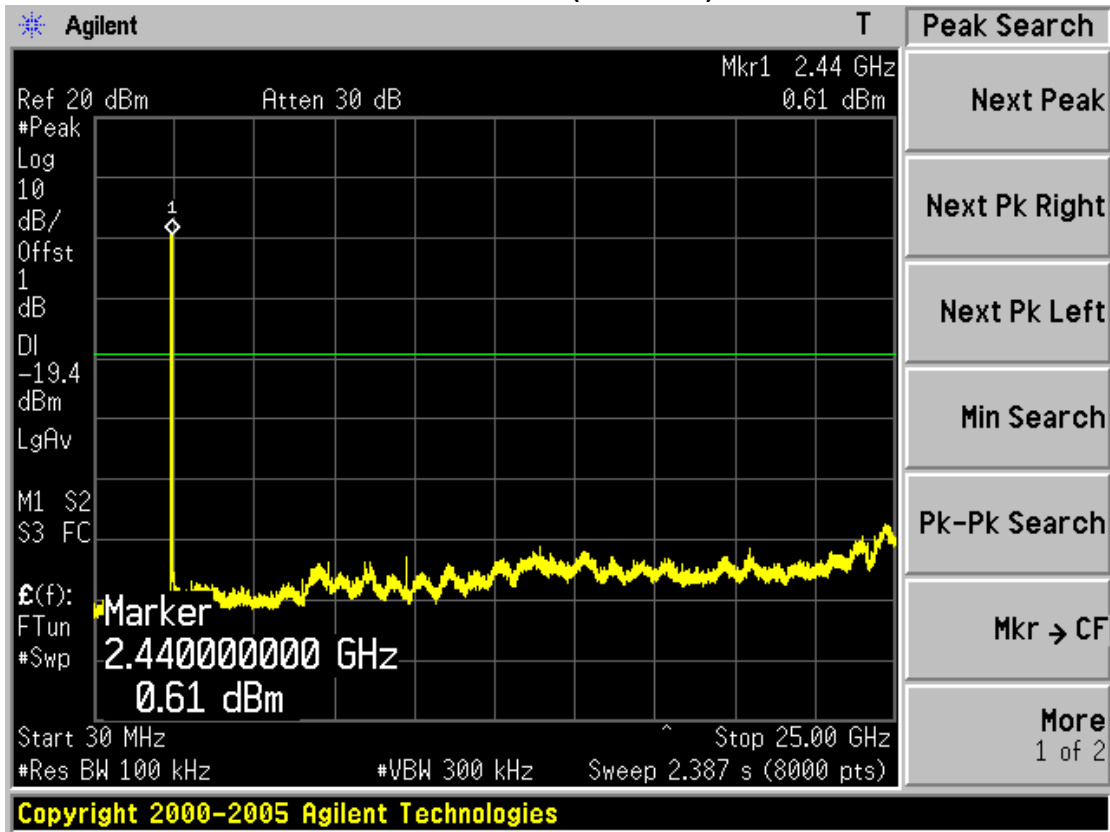

Channel 11 (2462MHz)

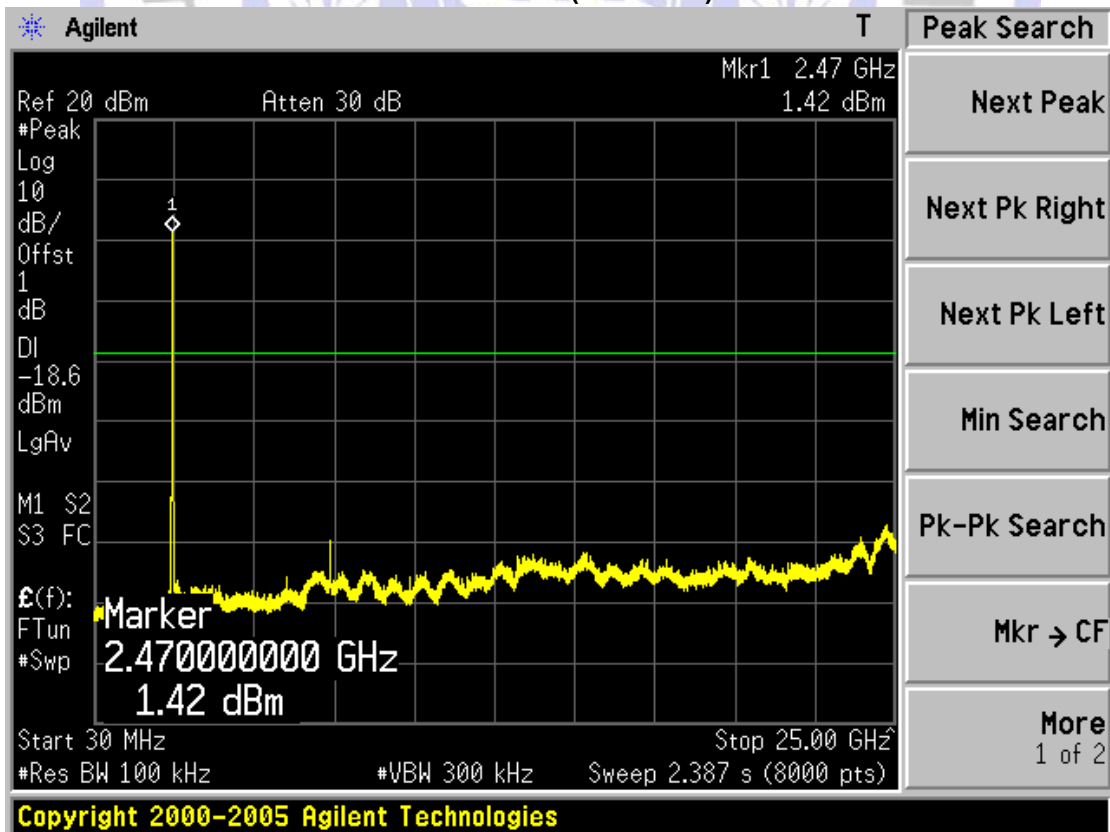

Product	:	HS-9DTB13-8GB
Test Item	:	RF Antenna Conducted Spurious
Test Mode	:	Mode 3: Transmit by 802.11n (20MHz)

Channel 01 (2412MHz)

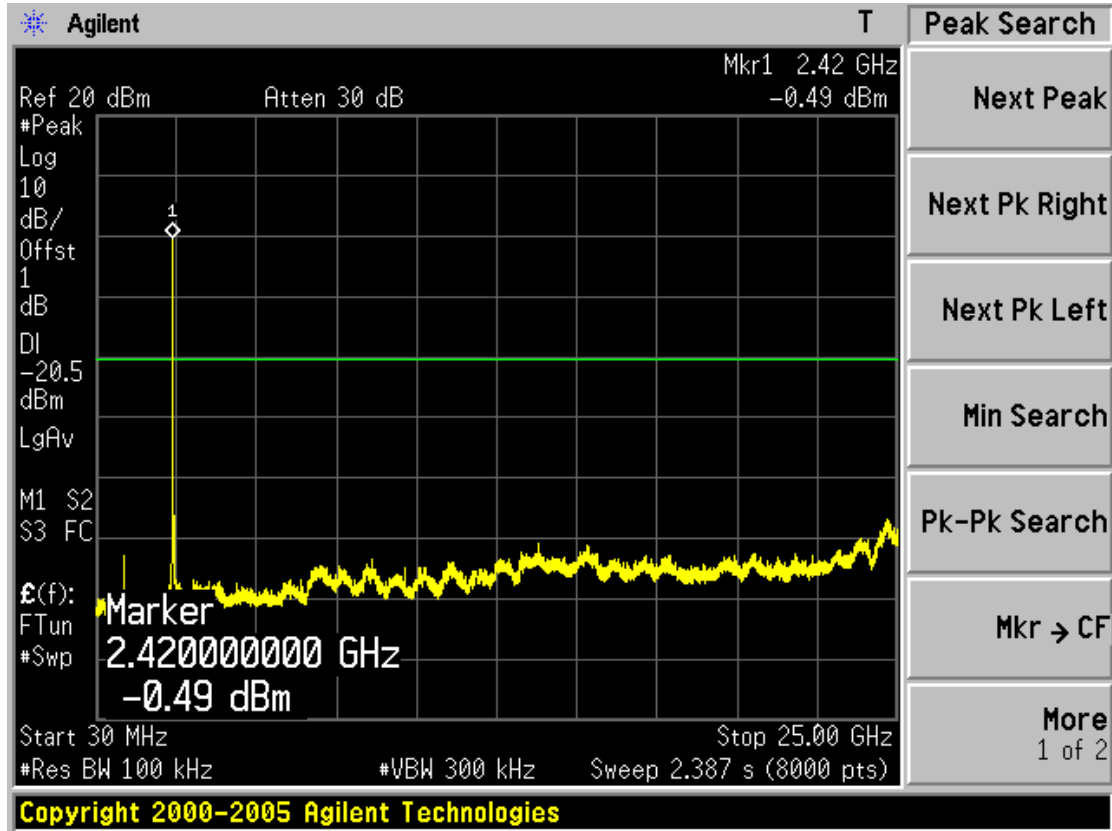

Channel 06 (2437MHz)

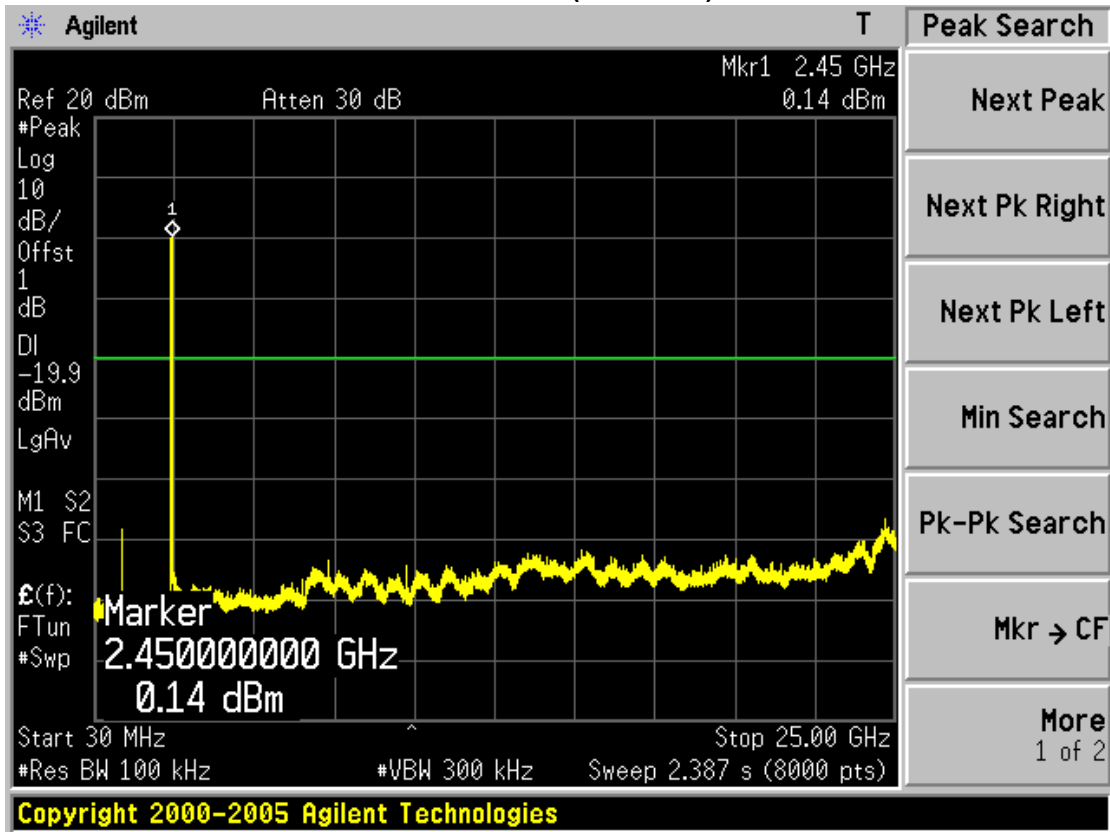

Channel 11 (2462MHz)

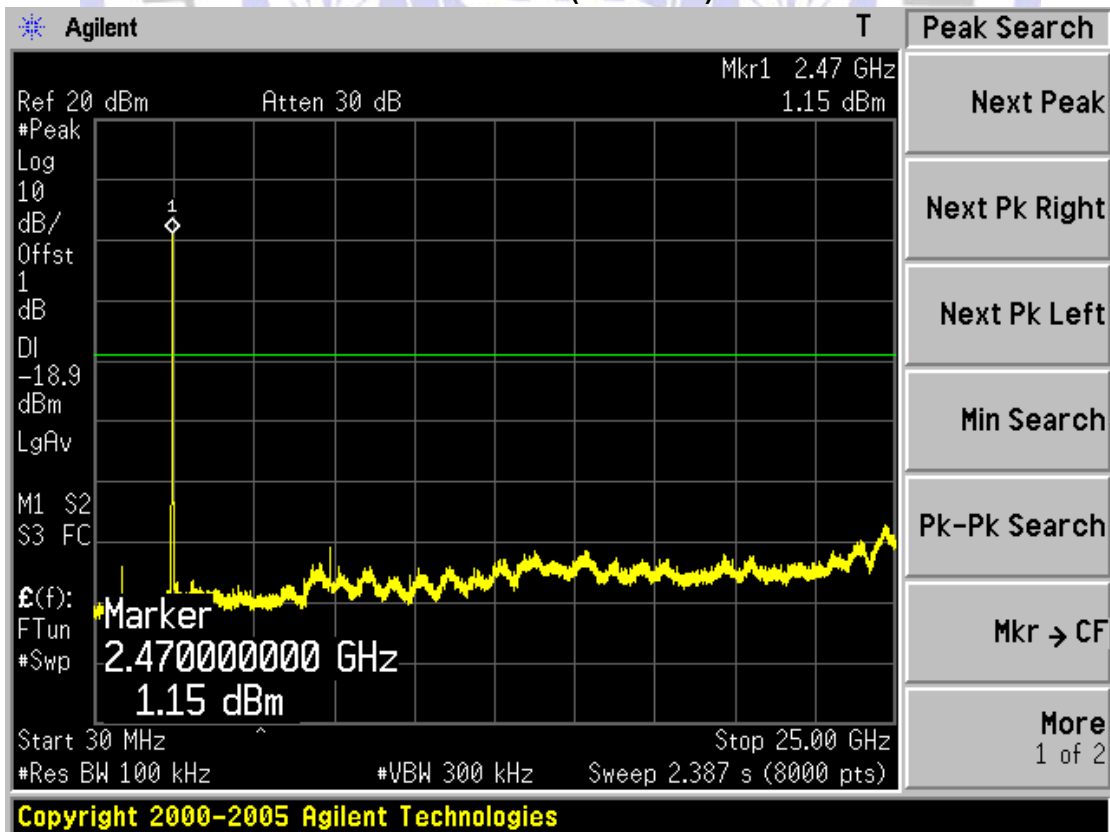

Product	:	HS-9DTB13-8GB
Test Item	:	RF Antenna Conducted Spurious
Test Mode	:	Mode 4: Transmit by 802.11n (40MHz)

Channel 03 (2422MHz)

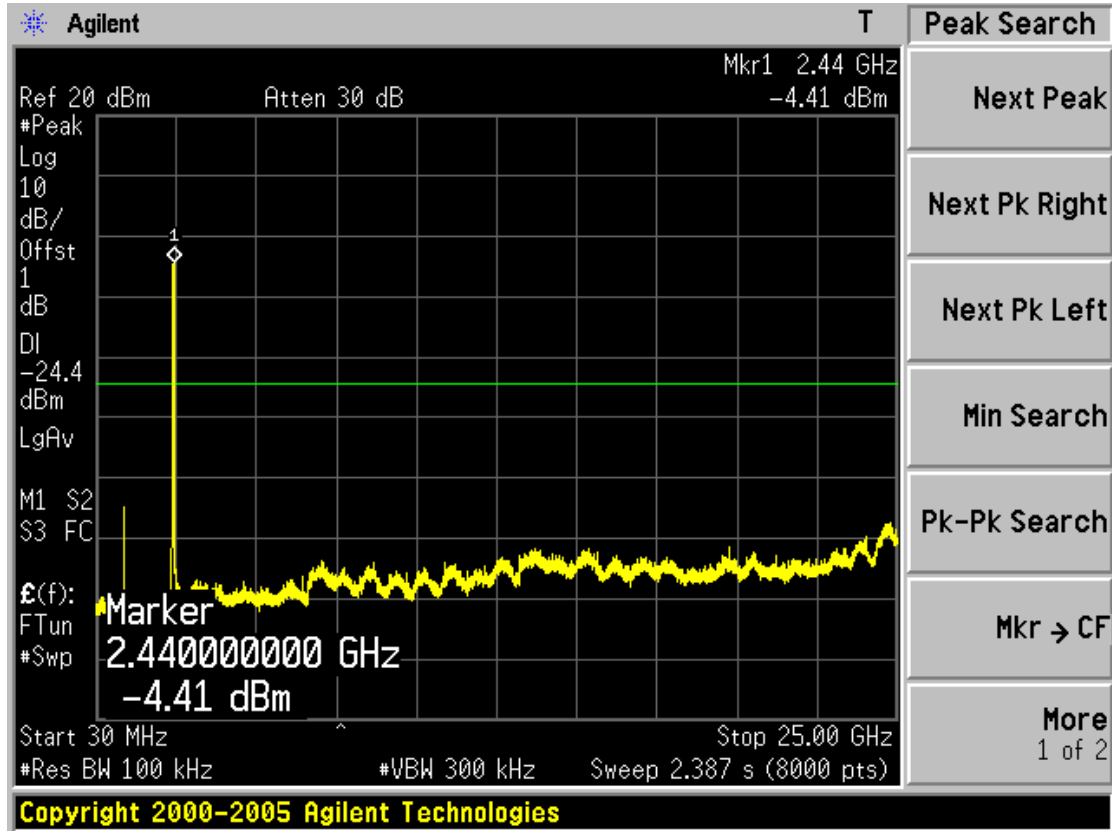

Channel 06 (2437MHz)

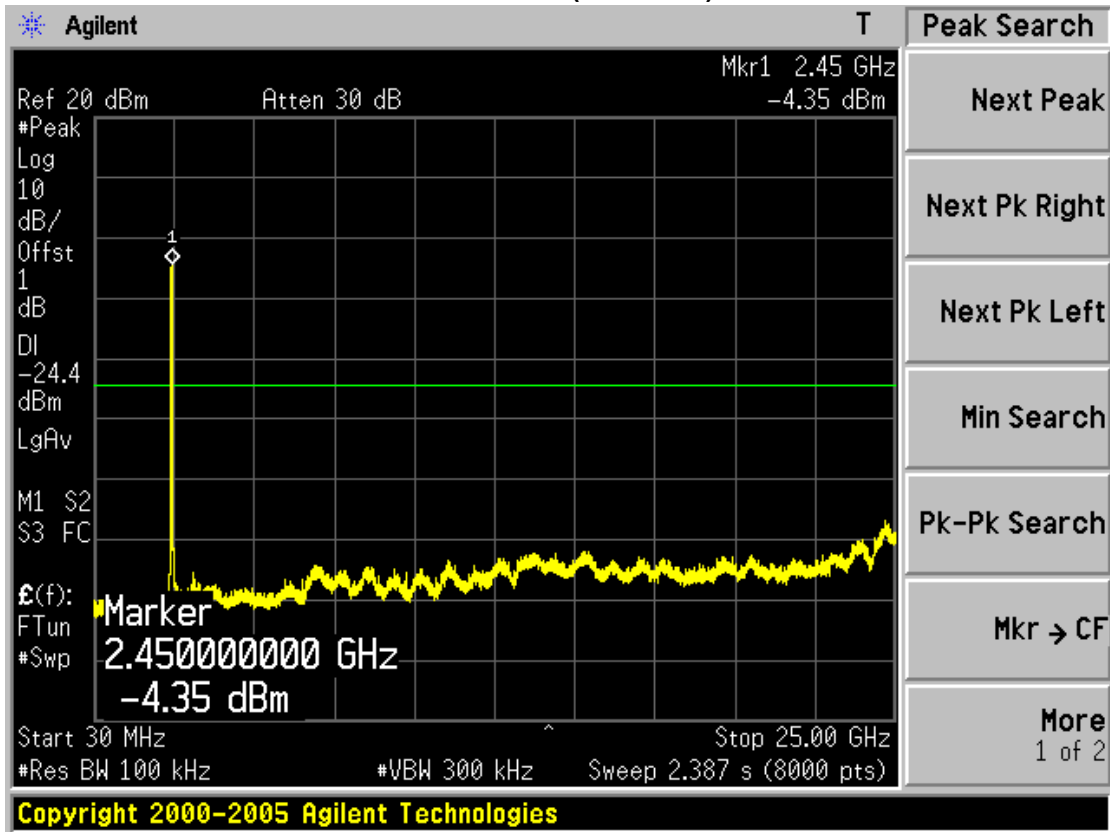

Channel 09 (2452MHz)

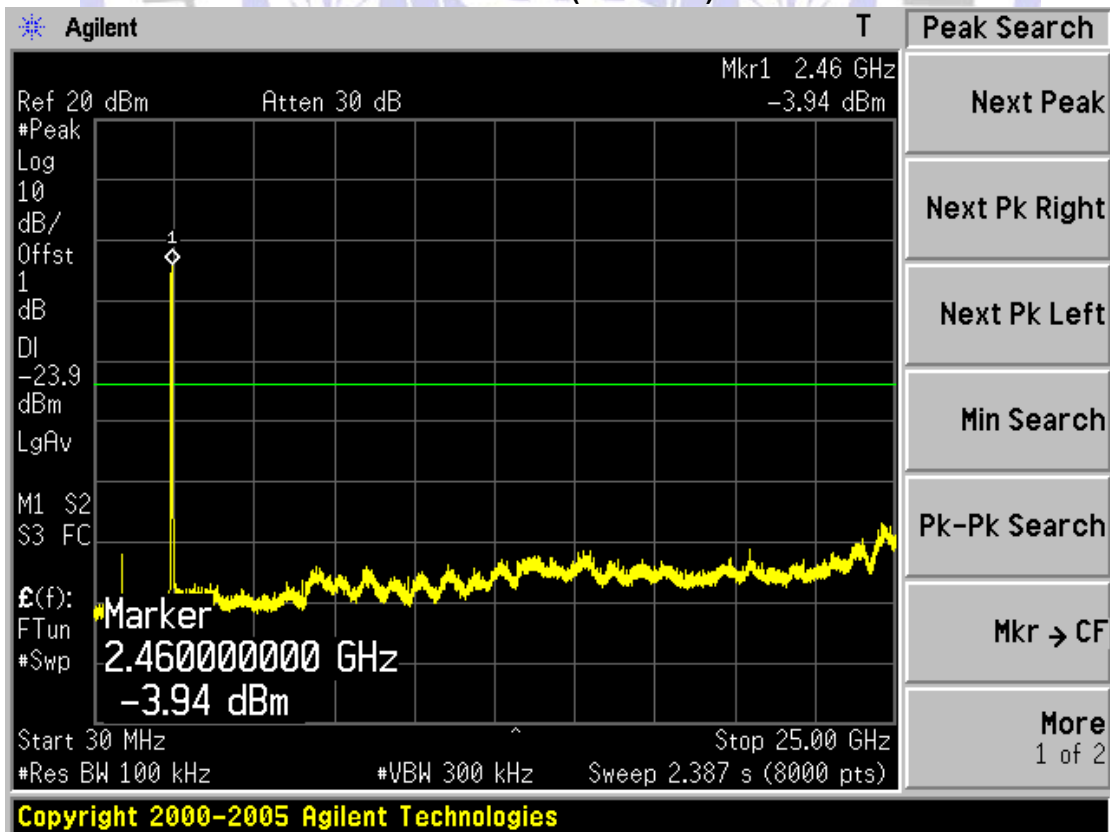

4.8. Operation Frequency Range of 20dB Bandwidth

TEST CONFIGURATION

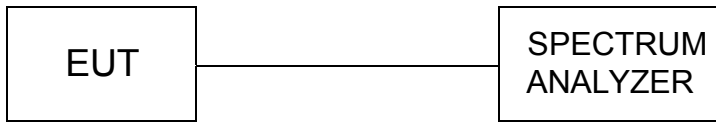

TEST PROCEDURE

The EUT was tested according to KDB558074 D01 v03r01 for compliance to FCC 47CFR 15.247 requirements. Set RBW = 100 kHz, Span greater than RBW.

LIMIT

20 dB bandwidth of the emission is contained within the operation frequency band.

TEST RESULT

Product	:	HS-9DTB13-8GB
Test Item	:	Operation Frequency Range of 20dB Bandwidth
Test Mode	:	Mode 1: Transmit by 802.11b

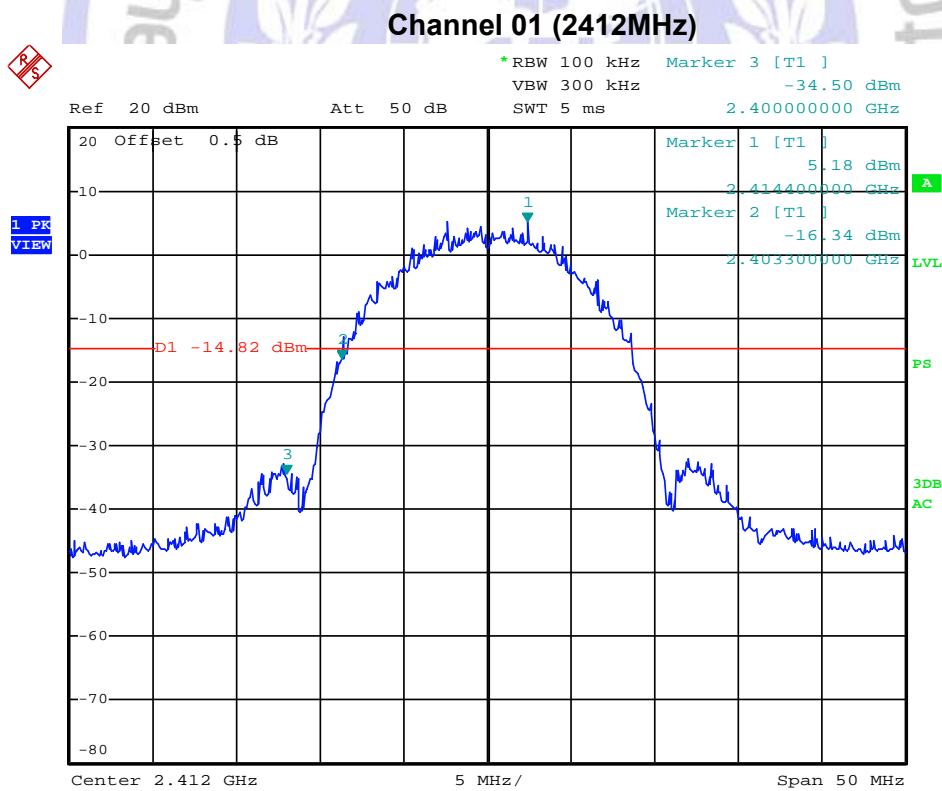

Channel 11 (2462MHz)

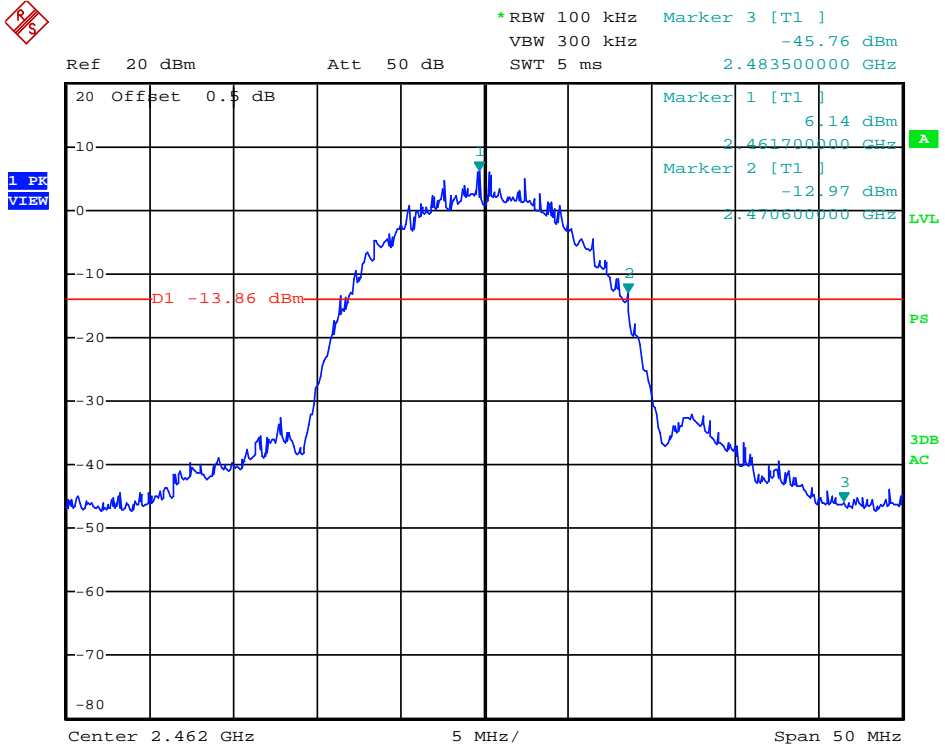

Date: 17.JAN.2014 14:38:41



Product	: HS-9DTB13-8GB
Test Item	: Operation Frequency Range of 20dB Bandwidth
Test Mode	: Mode 2: Transmit by 802.11g

Channel 01 (2412MHz)

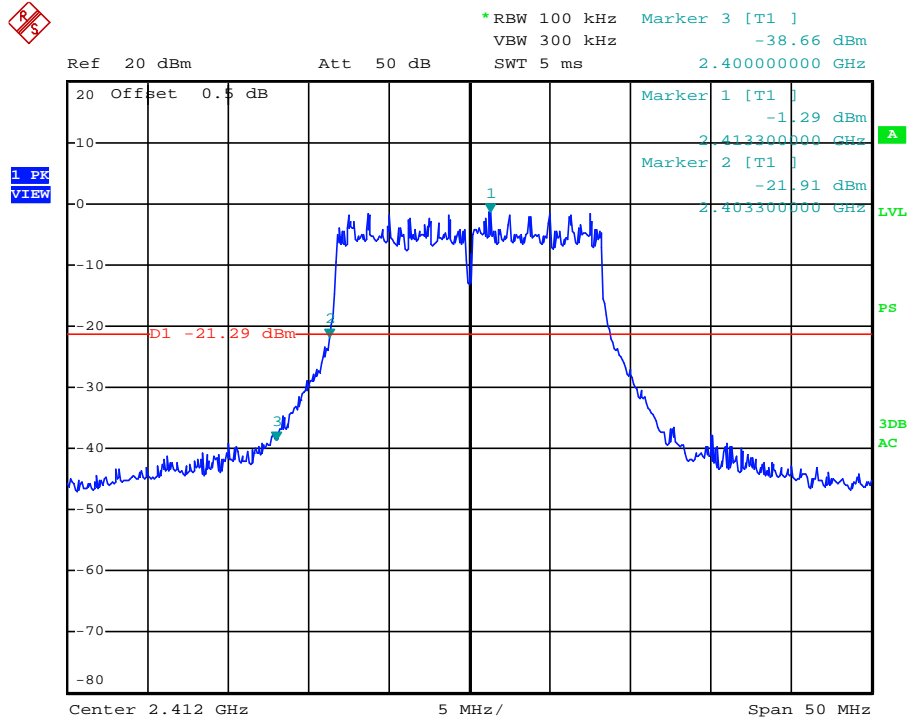

Date: 17.JAN.2014 14:41:44

Channel 11 (2462MHz)

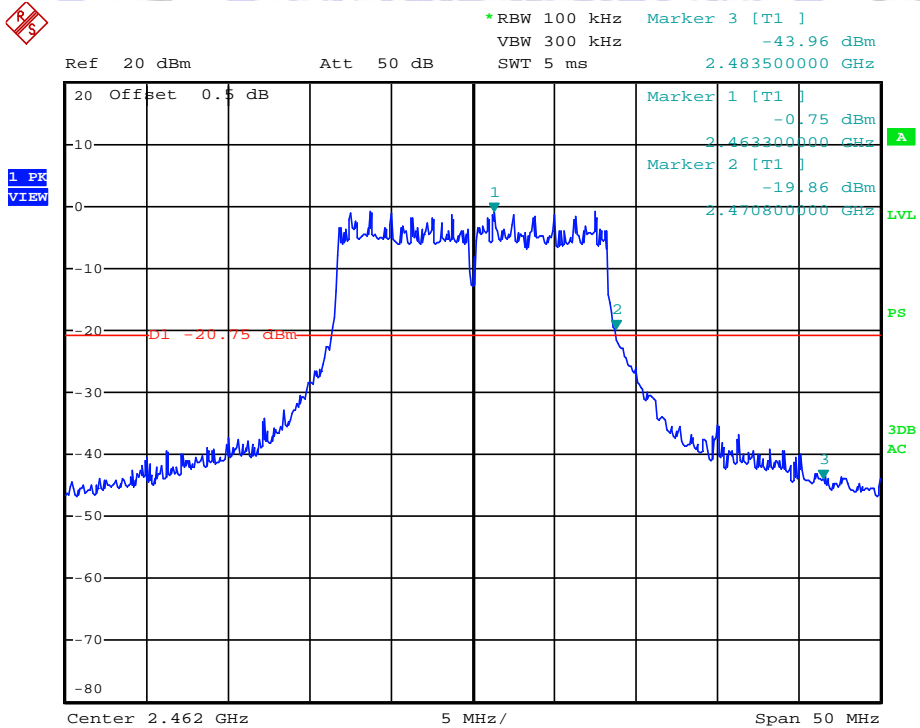

Date: 17.JAN.2014 14:43:30

Product	:	HS-9DTB13-8GB
Test Item	:	Operation Frequency Range of 20dB Bandwidth
Test Mode	:	Mode 3: Transmit by 802.11n (20MHz)

Channel 01 (2412MHz)

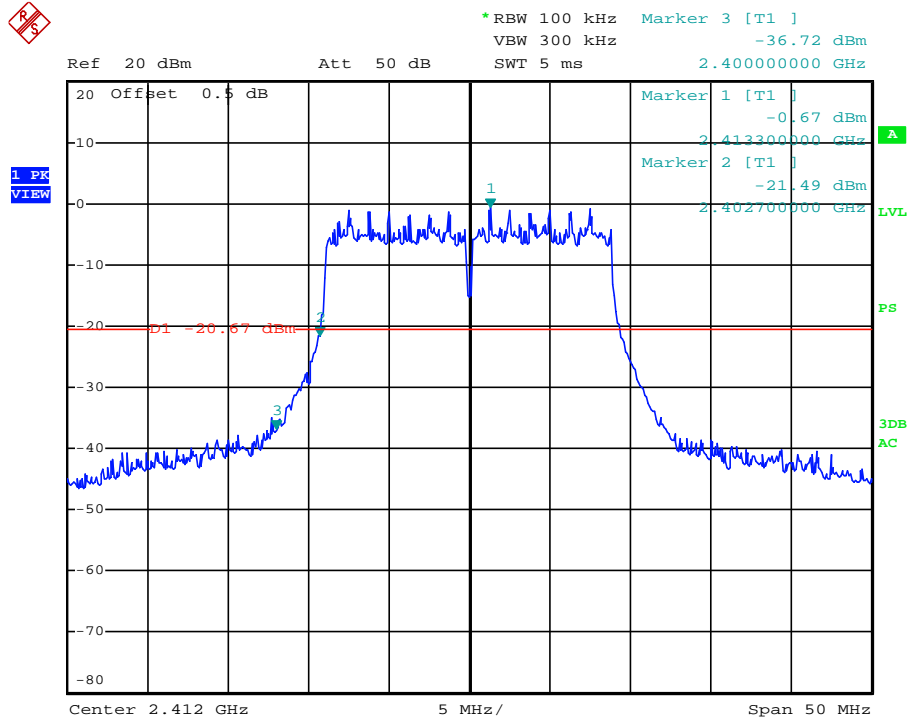

Date: 17.JAN.2014 14:56:10

Channel 11 (2462MHz)

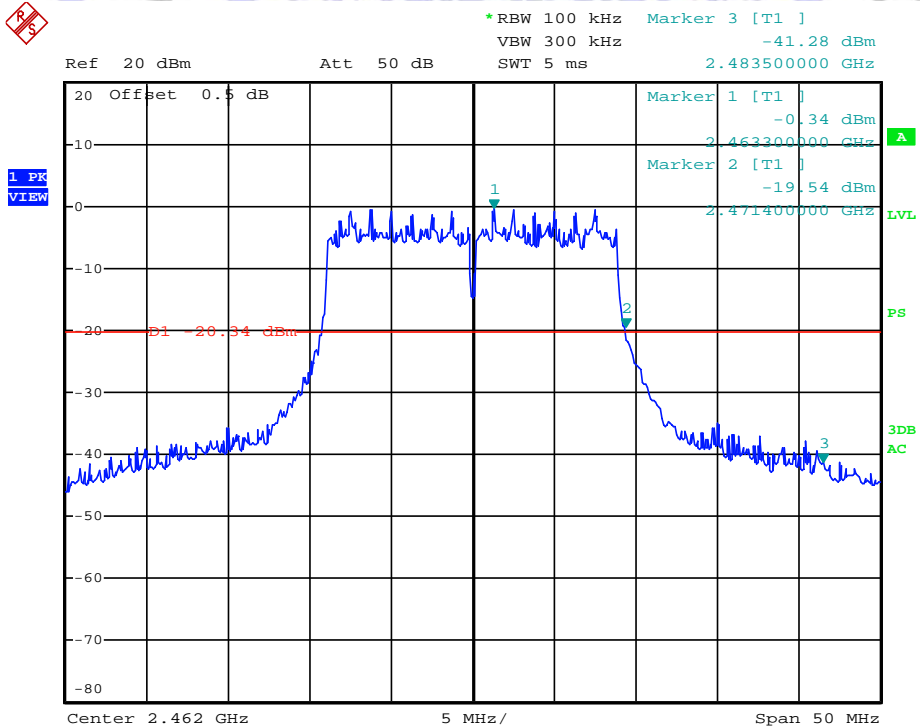

Date: 17.JAN.2014 14:54:49

4.9. Antenna Requirement

STANDARD APPLICABLE

For intentional device, according to FCC 47 CFR Section 15.203, an intentional radiator shall be designed to ensure that no antenna other than that furnished by the responsible party shall be used with the device.

And according to FCC 47 CFR Section 15.247 (c), if transmitting antennas of directional gain greater than 6dBi are used, the power shall be reduced by the amount in dB that the directional gain of the antenna exceeds 6dBi.

Refer to statement below for compliance.

The manufacturer may design the unit so that the user can replace a broken antenna, but the use of a standard antenna jack or electrical connector is prohibited. Further, this requirement does not apply to intentional radiators that must be professionally installed.

ANTENNA CONNECTED CONSTRUCTION

The directional gains of antenna used for transmitting is -0.5 dBi, and the antenna connector is designed with permanent attachment and no consideration of replacement. Please see EUT photo for details.



4.10. RF Exposure

STANDARD APPLICABLE

According to § 1.1307 (b)(1), system operating under the provisions of this section shall be operated in a manner that ensure that the public is not exposed to radio frequency energy level in excess of the Commission' s guideline.

This is a portable device. Per KDB 447498 D01 v05, the device used distance is 5mm from body.

LIMIT

LIMITS FOR MAXIMUM PERMISSIBLE EXPOSURE (MPE)

Frequency Range (MHz)	Electric Field Strength (V/m)	Magnetic Field Strength (A/m)	Power Density (mW/cm ²)	Average Time (Minutes)
(A) Limits for Occupational/ Control Exposures				
300-1500	--	--	F/300	6
1500-100,000	--	--	5	6
(B) Limits for General Population/ Uncontrolled Exposures				
300-1500	--	--	F/1500	6
1500-100,000	--	--	1	30

F= Frequency in MHz

MEASUREMENT RESULTS

Per KDB 447498 D01 V05

This is a bluetooth function and the Max peak output power is 9.65 dBm (9.23 mW) lower than low threshold 10 mW in general population category.

The SAR measurement is not necessary.

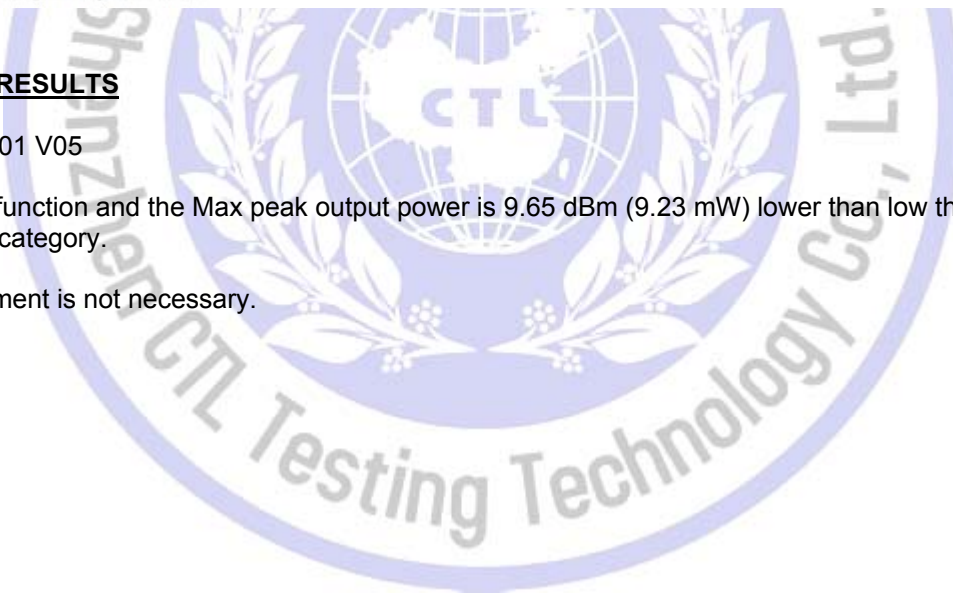

5. Test Setup Photos of the EUT

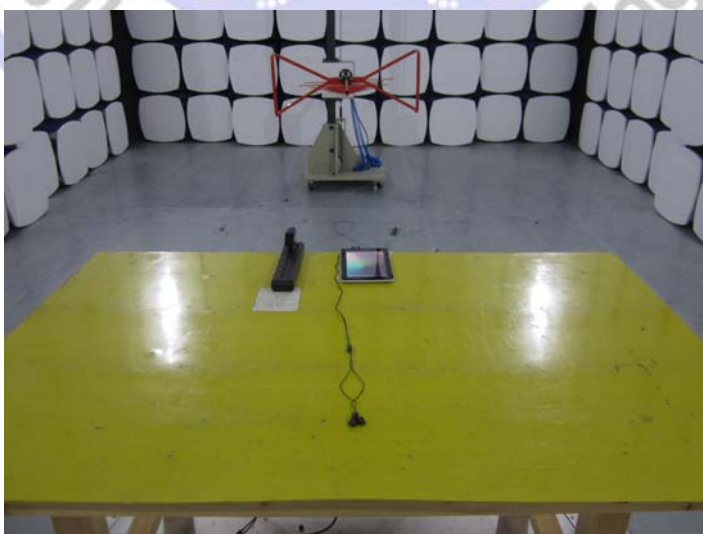
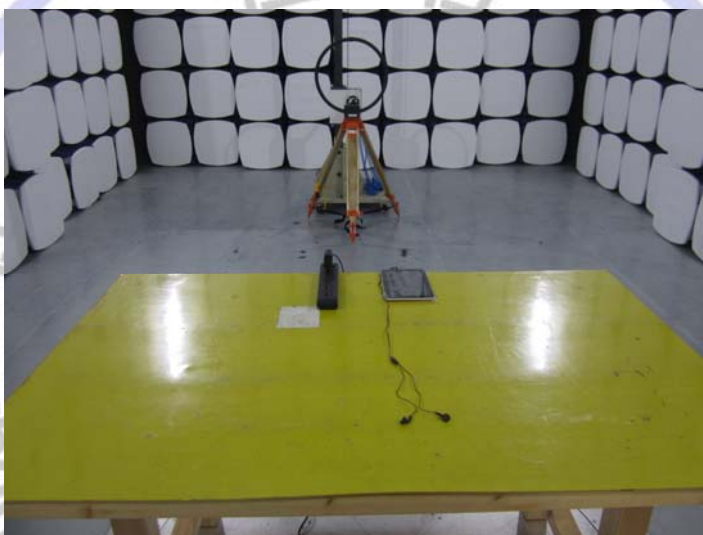

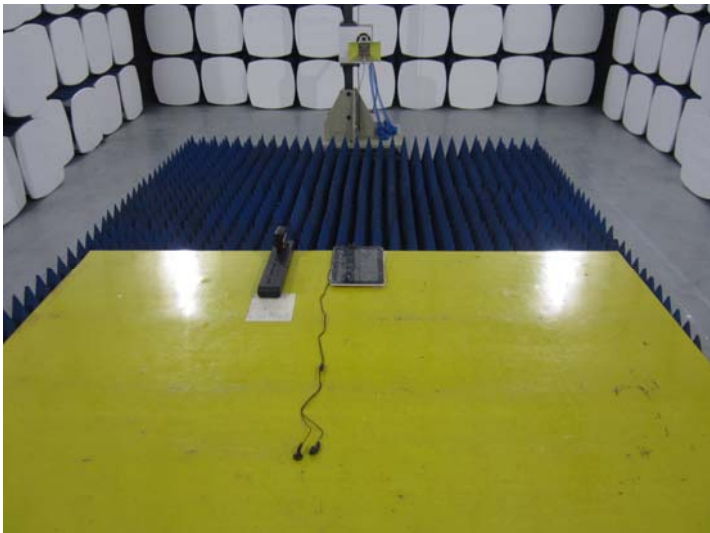

6. External and Internal Photos of the EUT

External Photos of EUT

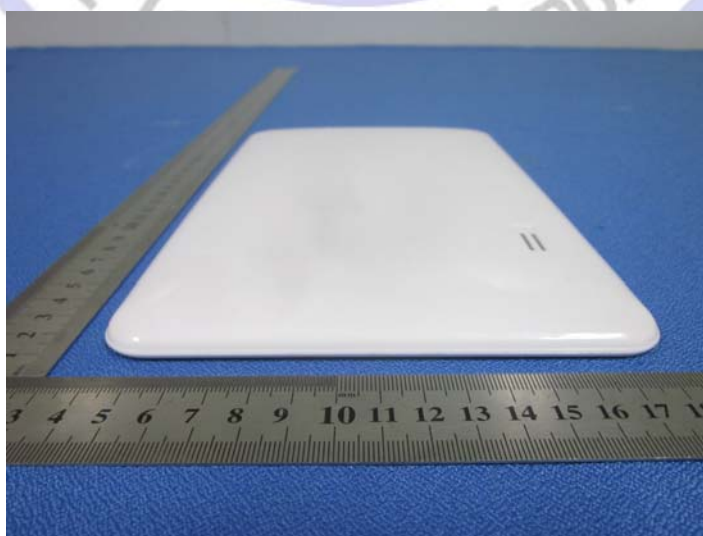



Internal Photos of EUT

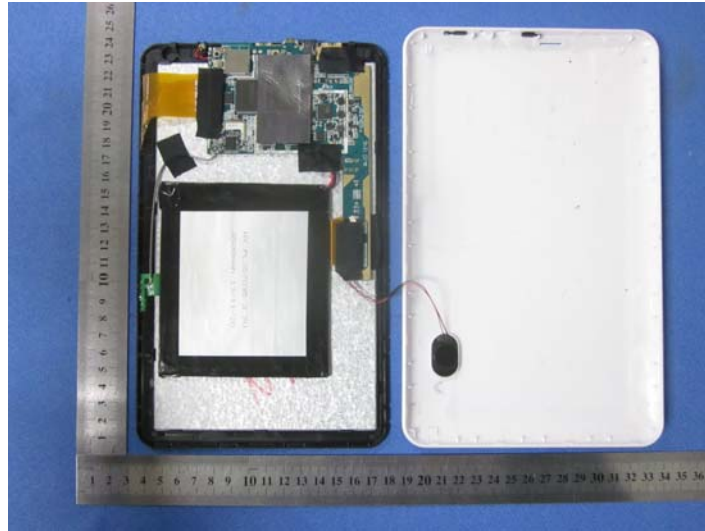

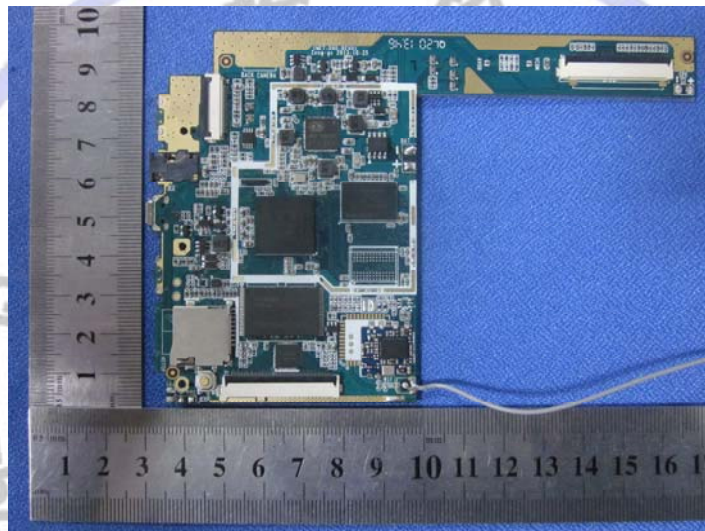

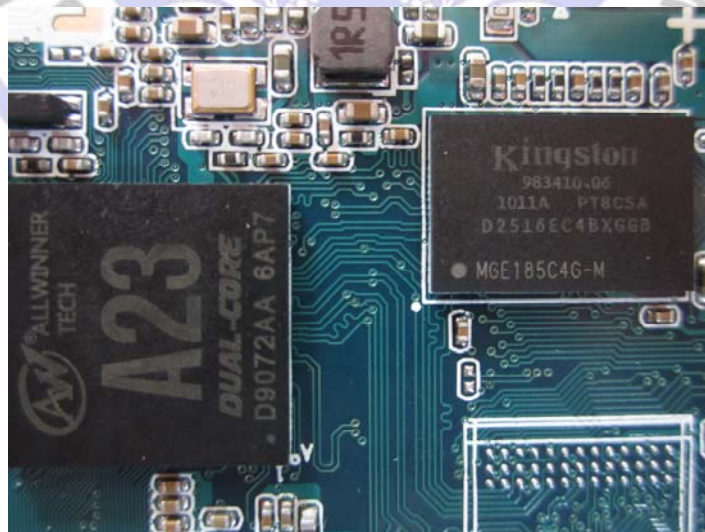

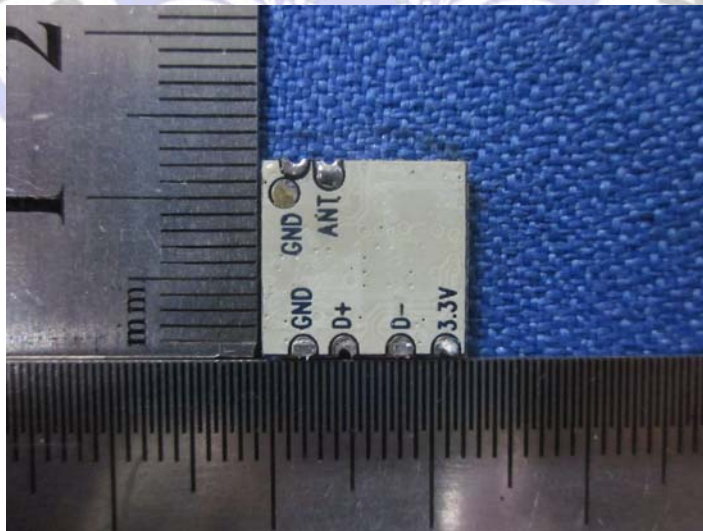
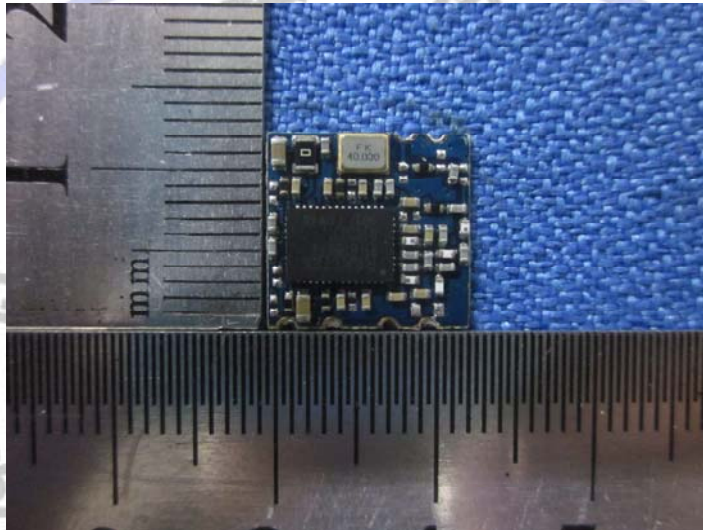
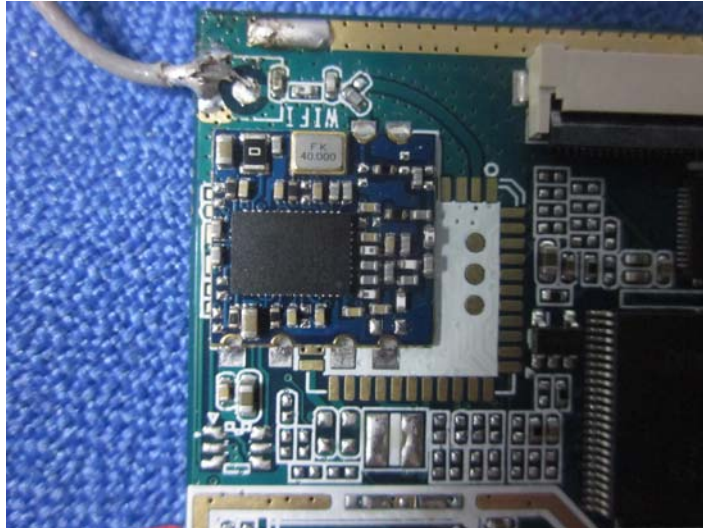

.....End of Report.....