



BNetzA-CAB-21/21-21

# Test Report

Test report no.: 22097767-29122-0

Date of issue: 2023-01-12

**Test result:** The test item - **passed** - and complies with below listed standards.

## Applicant

Huf Hülsbeck & Fürst GmbH & Co. KG

## Manufacturer

Huf Hülsbeck & Fürst GmbH & Co. KG

## Test Item

NFCETAB1

## RF-Spectrum Testing according to:

### FCC 47 CFR Part 15

Radio Frequency Devices (Subpart C)

### RSS-210, Issue 10 (2019-12)

Licence-Exempt Radio Apparatus: Category I Equipment

### RSS-Gen, Issue 5 (2018-04)

General Requirements for Compliance of Radio Apparatus

Tested by  
(name, function, signature)

*Karsten Gerdly*  
Lab Manager RF

  
signature

Approved by  
(name, function, signature)

*Andreas Bender*  
Deputy Managing Director

  
signature

<b>Applicant and Test item details</b>	
<b>Applicant</b>	Huf Hülsbeck & Fürst GmbH & Co. KG Huf Group Headquarters/ Werk Velbert Steeger Straße 17 42551, Velbert, Germany Phone: +49 2051 272-0 Fax: +49 2051 272-207
<b>Manufacturer</b>	Huf Hülsbeck & Fürst GmbH & Co. KG Huf Group Headquarters/ Werk Velbert Steeger Straße 17 42551, Velbert, Germany
<b>Test item description</b>	Audi-eTAB_V5_NFC
<b>Model/Type reference</b>	NFCETAB1
<b>FCC ID</b>	YGONFCETAB1
<b>IC</b>	4008C-NFCETAB1
<b>HMN</b>	N/A
<b>PMN</b>	HUF NFCETAB1
<b>HVIN</b>	NFCETAB1
<b>FVIN</b>	NFC_V5.24
<b>Frequency</b>	13.56 MHz
<b>Antenna</b>	Magnetic loop antenna
<b>Power supply</b>	9.0 V to 16.0 V DC
<b>Temperature range</b>	-40 °C to +80 °C

### Disclaimer and Notes

The content of this test report relates to the mentioned test sample(s) only.  
Without a written permit of IBL-Lab GmbH, this test report shall not be reproduced, except in full.

The last valid version is available at TAMSys®.

Copyright ©: All rights reserved by IBL-Lab GmbH

Within this test report, a  point /  comma is used as a decimal separator.  
If otherwise, a detailed note is added adjoined to its use.

IBL-Lab GmbH does not take test samples. The samples used for testing are provided by the applicant.

Decision rule:

Decision rule based on simple acceptance without guard bands, binary statement, based on mutually agreed uncertainty tolerances with expansion factor k=2 according to ILAC-G8:09/2019

# 1 TABLE OF CONTENTS

1	TABLE OF CONTENTS .....	3
2	GENERAL INFORMATION .....	4
2.1	Administrative details .....	4
2.2	Possible test case verdicts .....	4
2.3	Observations .....	5
2.4	Opinions and interpretations .....	5
2.5	Revision history .....	5
2.6	Further documents .....	5
3	ENVIRONMENTAL & TEST CONDITIONS .....	6
3.1	Environmental conditions .....	6
3.2	Normal and extreme test conditions .....	6
4	TEST STANDARDS AND REFERENCES .....	6
5	EQUIPMENT UNDER TEST (EUT) .....	7
5.1	Product description .....	7
5.2	Description of test item .....	7
5.3	Technical data of test item .....	7
5.4	Additional information .....	7
6	SUMMARY OF TEST RESULTS .....	8
7	TEST RESULTS .....	9
7.1	Field strength of emissions (transmitter spectrum mask) .....	9
7.2	Field strength of emissions (spurious and harmonics) .....	11
7.3	Frequency tolerance .....	16
7.4	20 dB bandwidth / occupied bandwidth .....	19
8	Test Setup Description .....	22
8.1	Semi Anechoic Chamber with Ground Plane .....	23
8.2	Measurements under normal and extreme climatic conditions .....	25
9	MEASUREMENT PROCEDURES .....	26
9.1	Radiated spurious emissions from 9 kHz to 30 MHz .....	26
9.2	Radiated spurious emissions from 30 MHz to 1 GHz .....	27
9.3	Radiated spurious emissions from 1 GHz to 18 GHz .....	28
10	MEASUREMENT UNCERTAINTIES .....	29
Annex 1	EUT Photographs, external .....	30
Annex 2	EUT Photographs, internal .....	34
Annex 3	Test Setup Photographs .....	36

## 2 GENERAL INFORMATION

### 2.1 Administrative details

Testing laboratory	<b>IBL-Lab GmbH</b> Heinrich-Hertz-Allee 7 66386 St. Ingbert / Germany Fon: +49 6894 38938-0 Fax: +49 6894 38938-99 URL: <a href="http://www.ib-lenhardt.de">www.ib-lenhardt.de</a> E-Mail: <a href="mailto:info@ib-lenhardt.de">info@ib-lenhardt.de</a>
Accreditation	<p>The testing laboratory is accredited by Deutsche Akkreditierungsstelle GmbH (DAkks) in compliance with DIN EN ISO/IEC 17025:2018.</p> <p>Scope of testing and registration number:</p> <ul style="list-style-type: none"> <li>• Electronics, EMC, Radio <a href="#">D-PL-21375-01-01</a></li> <li>• Electromagnetic Compatibility and Telecommunication (FCC requirements) Testing Laboratory Designation Number <a href="#">D-PL-21375-01-02</a> DE0024</li> <li>• Telecommunication (TC) and Electromagnetic Compatibility (EMC) for Canadian Standards <a href="#">D-PL-21375-01-03</a> ISED Company Number 27156 Testing Laboratory CAB Identifier DE0020</li> </ul> <p>Website DAkks: <a href="https://www.dakks.de/">https://www.dakks.de/</a></p> <p>The Deutsche Akkreditierungsstelle GmbH (DAkks) is also a signatory to the <a href="#">ILAC Mutual Recognition Arrangement</a></p>
Testing location	<b>IBL-Lab GmbH</b> Heinrich-Hertz-Allee 7 66386 St. Ingbert / Germany
Date of receipt of test samples	2022-12-12
Start – End of tests	2022-12-12 – 2023-01-05

### 2.2 Possible test case verdicts

Test sample meets the requirements	P (PASS)
Test sample does not meet the requirements	F (FAIL)
Test case does not apply to the test sample	N/A (Not applicable)
Test case not performed	N/P (Not performed)

### 2.3 Observations

No additional observations other than the reported observations within this test report have been made.

### 2.4 Opinions and interpretations

No appropriate opinions or interpretations according ISO/IEC 17025:2017 clause 7.8.7 are within this test report.

### 2.5 Revision history

**-0 Initial Version**

**Utilisation, publication and control of previous report editions is under responsibility of the applicant.**

### 2.6 Further documents

List of further applicable documents belonging to the present test report:

– no additional documents –

### 3 ENVIRONMENTAL & TEST CONDITIONS

#### 3.1 Environmental conditions

Temperature	20°C ± 5°C
Relative humidity	25-75 % r.H.
Barometric Pressure	860-1060 mbar
Power supply	230 V / 50 Hz

#### 3.2 Normal and extreme test conditions

	minimum	normal	maximum
Temperature	-40 °C	20 °C	+80 °C
Relative humidity	-/-	45 % r.h.	-/-
Power supply	9.0 V DC	13.5 V DC	16.0 V DC

### 4 TEST STANDARDS AND REFERENCES

Test standard (accredited)	Description
<b>FCC 47 CFR Part 15</b>	Radio Frequency Devices (Subpart C)
<b>RSS-210, Issue 10 (2019-12)</b>	Licence-Exempt Radio Apparatus: Category I Equipment
<b>RSS-Gen, Issue 5 (2018-04)</b>	General Requirements for Compliance of Radio Apparatus

Reference	Description
<b>ANSI C63.4-2014</b>	American National Standard for Methods of Measurement of Radio-Noise Emissions from Low-Voltage Electrical and Electronic Equipment in the Range of 9 kHz to 40 GHz
<b>ANSI C63.10-2013</b>	American National Standard of Procedures for Compliance Testing of Unlicensed Wireless Devices

## 5 EQUIPMENT UNDER TEST (EUT)

### 5.1 Product description

Audi-eTAB\_V5\_NFC

The EUT is a door handle for passenger cars including locking/unlocking function of the vehicle.

### 5.2 Description of test item

<b>Model name*</b>	NFCETAB1
<b>Serial number*</b>	left door handle, max. equipped: 85F 837 811 left door handle, min. equipped: 8B1 837 811
<b>PCB identifier*</b>	left door handle: 13.907.261
<b>Hardware status*</b>	H05
<b>Software status*</b>	X541

\*: as declared by applicant

### 5.3 Technical data of test item

<b>Operational frequency*</b>	13.56 MHz
<b>Operational frequency band*</b>	11.81 MHz – 15.31 MHz
<b>Type of radio transmission*</b>	CW carrier & modulated carrier
<b>Modulation type*</b>	OOK (NFC-A Frames according to ISO 14443-A)
<b>Number of channels*</b>	1
<b>Channel bandwidth*</b>	-/-
<b>Channel spacing*</b>	-/-
<b>Antenna*</b>	Magnetic loop antenna
<b>Power supply*</b>	9.0 V to 16.0 V DC
<b>Temperature range*</b>	-40 °C to +80 °C

\*: as declared by applicant

### 5.4 Additional information

<b>Model differences</b>	There are two different variations of EUT available: - left door handle: fully equipped, partly equipped Maximum equipped door handle is fully tested. Minimum equipped door handle is only partial tested (spuri).
<b>Ancillaries tested with</b>	none
<b>Additional equipment used for testing</b>	none

Equipment Under Test (EUT) is prepared by the applicant with special test software to produce a continuously operating carrier. EUT is transmitting alternating CW and NFC-Type A modulation.

According to the applicant this test mode represents the worst case (max. Tx power, max. duty cycle).

## 6 SUMMARY OF TEST RESULTS

### Test specification

FCC 47 CFR Part 15  
 RSS-210, Issue 10 (2019-12) / RSS-Gen, Issue 5 (2018-04)

Clause	Requirement / Test case	Test Conditions	Result / Remark	Verdict
§15.225 (a) – (c) RSS-210, B.6 a	Field strength of emissions (transmitter spectrum mask)	Normal	63.6 dBµV/m @3m	P
§15.225(d) / §15.209(a) // RSS-210, B.6 a RSS-Gen	Field strength of emissions (spurious & harmonics)	Normal	< limit	P
§15.225(e) RSS-210, B.6 b	Frequency tolerance	Extreme	< 0.002 % < 20 ppm	P
§15.207 RSS-Gen, 8.8	Conducted limits	Normal	< limit	P
§15.215(c) RSS-Gen, 6.7	20 dB bandwidth Occupied bandwidth	Normal	53.9 kHz 916.565 kHz	P

### Notes

– none –

### Comments and observations

– none –



## 7 TEST RESULTS

### 7.1 Field strength of emissions (transmitter spectrum mask)

#### Description / Limits

§15.225

(a) The field strength of any emissions within the band 13.553-13.567 MHz shall not exceed 15848 microvolts/meter at 30 meters (84 dB $\mu$ V/m).

(b) Within the bands 13.410-13.553 MHz and 13.567-13.710 MHz, the field strength of any emissions shall not exceed 334 microvolts/meter at 30 meters (50.5 dB $\mu$ V/m).

(c) Within the bands 13.110-13.410 MHz and 13.710-14.010 MHz the field strength of any emissions shall not exceed 106 microvolts/meter at 30 meters (40.5 dBV/m).

#### Test procedure

§15.31 (m) Measurements on intentional radiators or receivers, other than TV broadcast receivers, shall be performed and, if required, reported for each band in which the device can be operated with the device operating at the number of frequencies in each band specified in the following table:

Frequency range	Number of frequencies	Location
< 1MHz bandwidth	1	middle
1 – 10 MHz bandwidth	2	1 near bottom and 1 near top
> 10 MHz bandwidth	3	1 near bottom / middle / top

§15.35 (a) On any frequency or frequencies below or equal to 1000 MHz, the limits shown are based on measuring equipment employing a CISPR quasi-peak detector function and related measurement bandwidths, unless otherwise specified. The specifications for the measuring instrumentation using the CISPR quasi-peak detector can be found in ANSI C63.4-2014, clause 4 (incorporated by reference, see §15.38). As an alternative to CISPR quasi-peak measurements, the responsible party, at its option, may demonstrate compliance with the emission limits using measuring equipment employing a peak detector function as long at the same bandwidth as indicated for CISPR quasi-peak measurements are employed.

**Test setup:** see 8.1

#### Test results

EUT	Frequency [MHz]	Detector	Test distance [m]	Level [dB $\mu$ V/m]	Limit [dB $\mu$ V/m]	Margin [dB]
Left Maximum	13.56	QP	3	63.6	105.4	41.8

#### Note:

Testing was performed with high duty cycle for testing purpose.

Plot no. 1: Transmitter Spectrum Mask (TSM), loop antenna

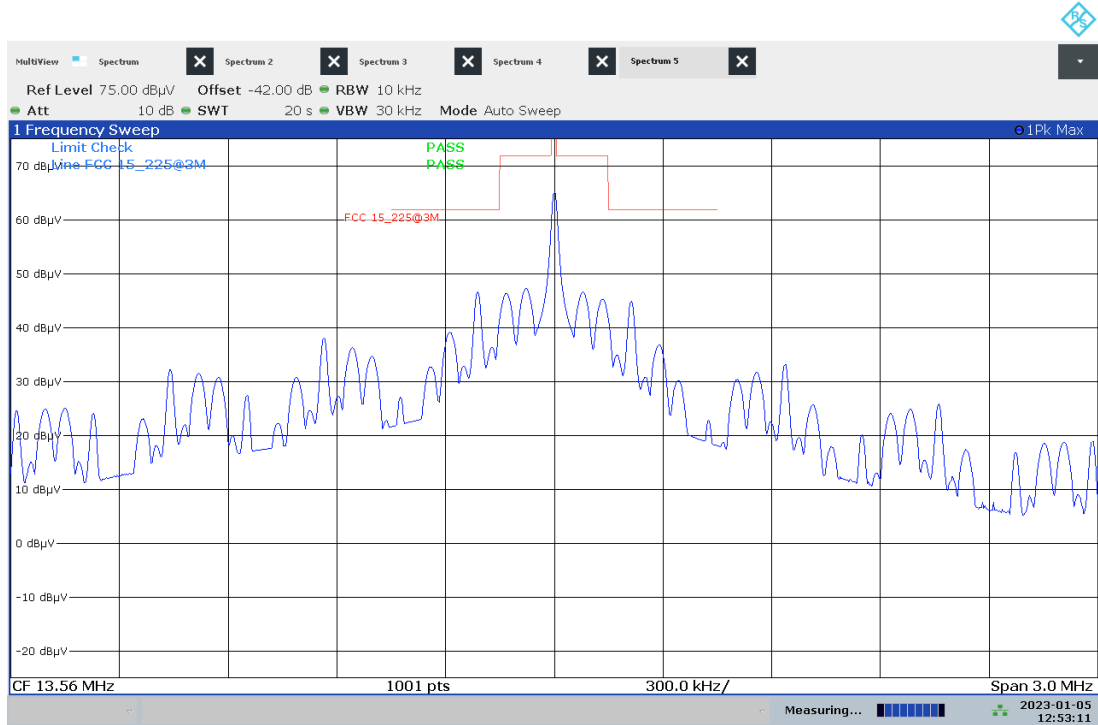

12:53:11 01/05/2023

## 7.2 Field strength of emissions (spurious and harmonics)

### Description / Limits

§15.225 (d) The field strength of any emissions appearing outside of the 13.110-14.010 MHz band shall not exceed the general radiated emission limits in §15.209:

Frequency	Field Strength	Measurement distance
0.009 – 0.490 MHz	2400/F[kHz] $\mu\text{V}/\text{m}$	300 m
0.490 – 1.705 MHz	24000/F[kHz] $\mu\text{V}/\text{m}$	30 m
1.705 – 30.0 MHz	30.0 $\mu\text{V}/\text{m}$ / 29.5 dB $\mu\text{V}/\text{m}$	30 m
30 – 88 MHz	100 $\mu\text{V}/\text{m}$ / 40.0 dB $\mu\text{V}/\text{m}$	3 m
88 – 216 MHz	150 $\mu\text{V}/\text{m}$ / 43.5 dB $\mu\text{V}/\text{m}$	3 m
216 – 960 MHz	200 $\mu\text{V}/\text{m}$ / 46.0 dB $\mu\text{V}/\text{m}$	3 m
960 – 100 000 MHz	500 $\mu\text{V}/\text{m}$ / 54.0 dB $\mu\text{V}/\text{m}$	3 m

### Test procedure

§15.31 (m) Measurements on intentional radiators or receivers, other than TV broadcast receivers, shall be performed and, if required, reported for each band in which the device can be operated with the device operating at the number of frequencies in each band specified in the following table:

Frequency range	Number of frequencies	Location
< 1MHz bandwidth	1	middle
1 – 10 MHz bandwidth	2	1 near bottom and 1 near top
> 10 MHz bandwidth	3	1 near bottom / middle / top

§15.35 (a) On any frequency or frequencies below or equal to 1000 MHz, the limits shown are based on measuring equipment employing a CISPR quasi-peak detector function and related measurement bandwidths, unless otherwise specified. The specifications for the measuring instrumentation using the CISPR quasi-peak detector can be found in ANSI C63.4-2014, clause 4 (incorporated by reference, see §15.38). As an alternative to CISPR quasi-peak measurements, the responsible party, at its option, may demonstrate compliance with the emission limits using measuring equipment employing a peak detector function as long as the same bandwidth as indicated for CISPR quasi-peak measurements are employed.

**Test setup:** see 8.1

### Test results

EUT	Frequency [MHz]	Detector	Test distance [m]	Level [dB $\mu\text{V}/\text{m}$ ]	Limit [dB $\mu\text{V}/\text{m}$ ]	Margin [dB]
Right maximum	see plots	see plots	see plots	see plots	see plots	see plots
Left Maximum	see plots	see plots	see plots	see plots	see plots	see plots
Right Minimum	see plots	see plots	see plots	see plots	see plots	see plots
Left Minimum	see plots	see plots	see plots	see plots	see plots	see plots

**Note:** -

Plot no. 2: Radiated Emissions 9 kHz – 30 MHz, loop antenna, Left maximum

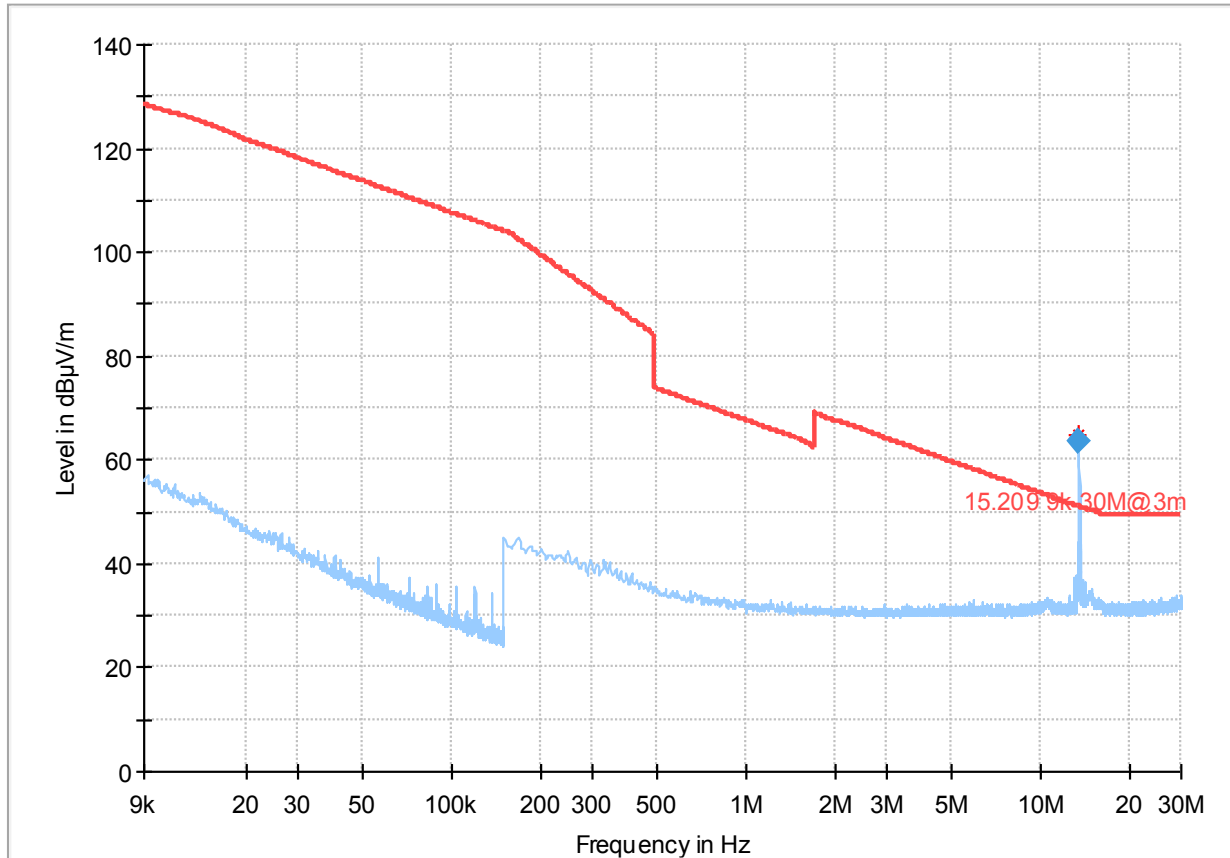

— Preview Result 1-PK+  
— 15.209 9k-30M@3m

\* Critical\_Freqs PK+  
◆ Final\_Result QPK

### Final Result

Frequency (MHz)	QuasiPeak (dBµV/m)	Limit (dBµV/m)	Margin (dB)	Meas. Time (ms)	Bandwidth (kHz)	Pol	Azimuth (deg)	Corr. (dB/m)
13.560000	63.62	50.94	-12.68	100.0	9.000	H	-24.0	20.5

**Note:**

Please see previous plot for transmitter spectrum mask (TSM)!

The limits in CFR 47, Part 15, Subpart C, paragraph 15.209(a), are identical to those in RSS-GEN Section 8.9, Table 6, since the measurements are performed in terms of magnetic field strength and converted to electric field strength levels (as reported in the table) using the free space impedance of 377Ω. For example, the measurement frequency X kHz resulted in a level of Y dBµV/m, which is equivalent to Y - 51.5 = Z dBµA/m, which has the same margin, W dB, to the corresponding RSS-GEN Table 6 limit as it has to the 15.209(a) limit.

Plot no. 3: Radiated Emissions 9 kHz – 30 MHz, loop antenna, Left minimum

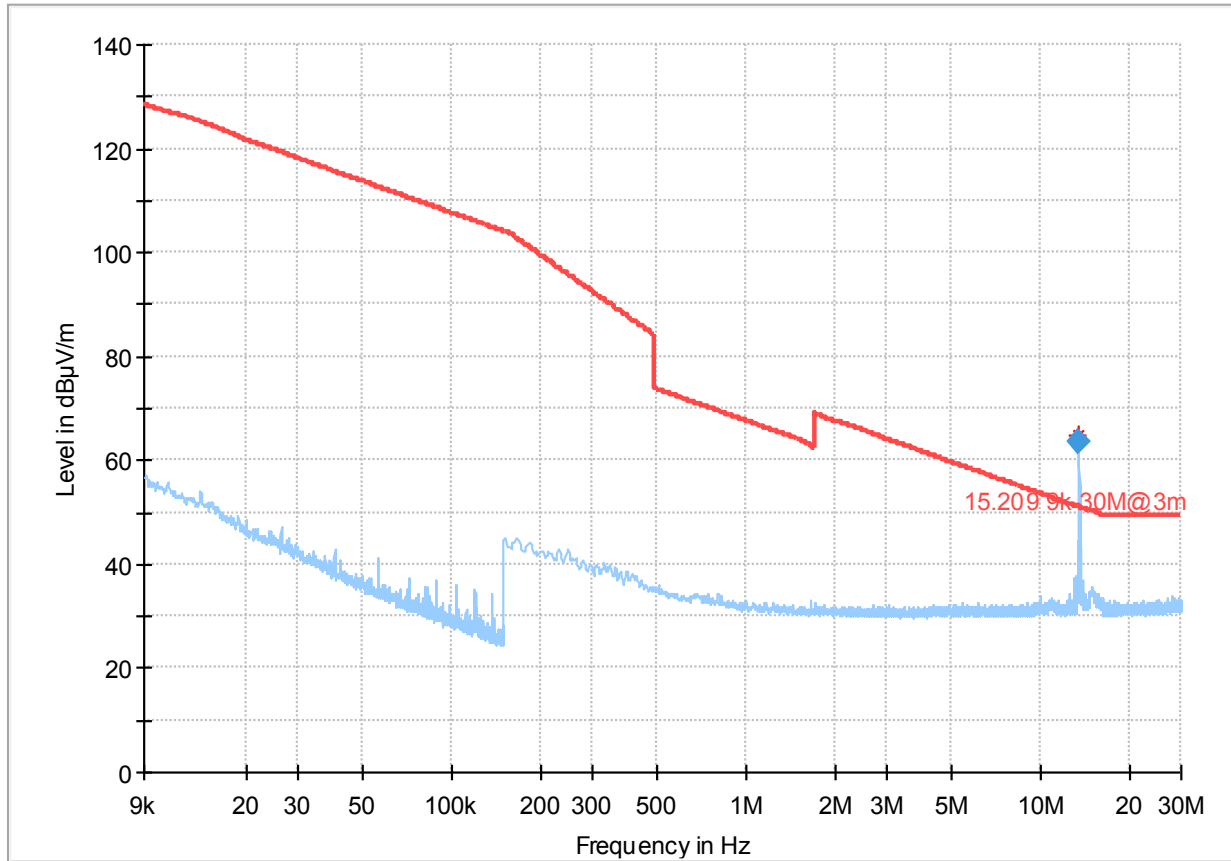

— Preview Result 1-PK+  
— 15.209 9k-30M@3m
 \* Critical\_Freqs PK+  
◆ Final\_Result QPK

### Final Result

Frequency (MHz)	QuasiPeak (dBµV/m)	Limit (dBµV/m)	Margin (dB)	Meas. Time (ms)	Bandwidth (kHz)	Pol	Azimuth (deg)	Corr. (dB/m)
13.560000	63.63	50.94	-12.69	100.0	9.000	H	171.0	20.5

(continuation of the "Final\_Result" table from column 15 ...)

Frequency (MHz)	Comment
13.560000	18:13:37 - 12.12.2022

Note:  
Please see previous plot for transmitter spectrum mask (TSM)!

Plot no. 4: Radiated Emissions 30 MHz – 1 GHz, hor./vert. polarization, Left maximum

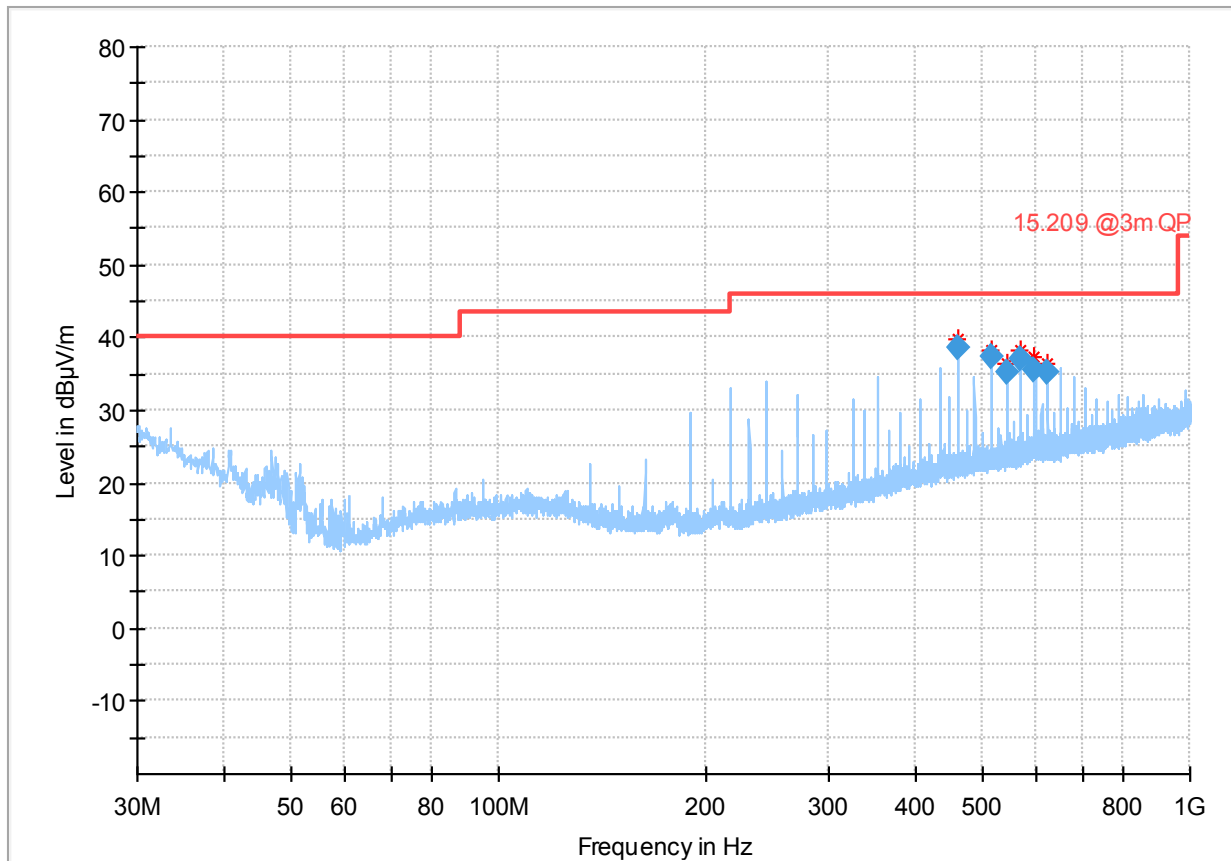

— Preview Result 1-PK+      \* Critical\_Freqs PK+  
— 15.209 @3m QP            ◆ Final\_Result QPK

### Final\_Result

Frequency (MHz)	QuasiPeak (dBµV/m)	Limit (dBµV/m)	Margin (dB)	Meas. Time (ms)	Bandwidth (kHz)	Height (cm)	Pol	Azimuth (deg)
461.043000	38.50	46.00	7.50	100.0	120.000	184.0	H	301.0
515.291000	37.38	46.00	8.62	100.0	120.000	100.0	V	89.0
542.402500	35.30	46.00	10.70	100.0	120.000	103.0	V	225.0
569.537500	37.19	46.00	8.81	100.0	120.000	103.0	V	296.0
596.649000	35.47	46.00	10.53	100.0	120.000	104.0	V	305.0
623.760500	35.25	46.00	10.75	100.0	120.000	100.0	V	209.0

(continuation of the "Final\_Result" table from column 15 ...)

Frequency (MHz)	Corr. (dB/m)	Comment
461.043000	17.3	17:14:58 - 12.12.2022
515.291000	18.2	17:17:24 - 12.12.2022
542.402500	18.5	17:21:12 - 12.12.2022
569.537500	19.0	17:23:13 - 12.12.2022
596.649000	19.5	17:25:05 - 12.12.2022
623.760500	19.8	17:19:22 - 12.12.2022

Plot no. 5: Radiated Emissions 30 MHz – 1 GHz, hor./vert. polarization, Left minimum

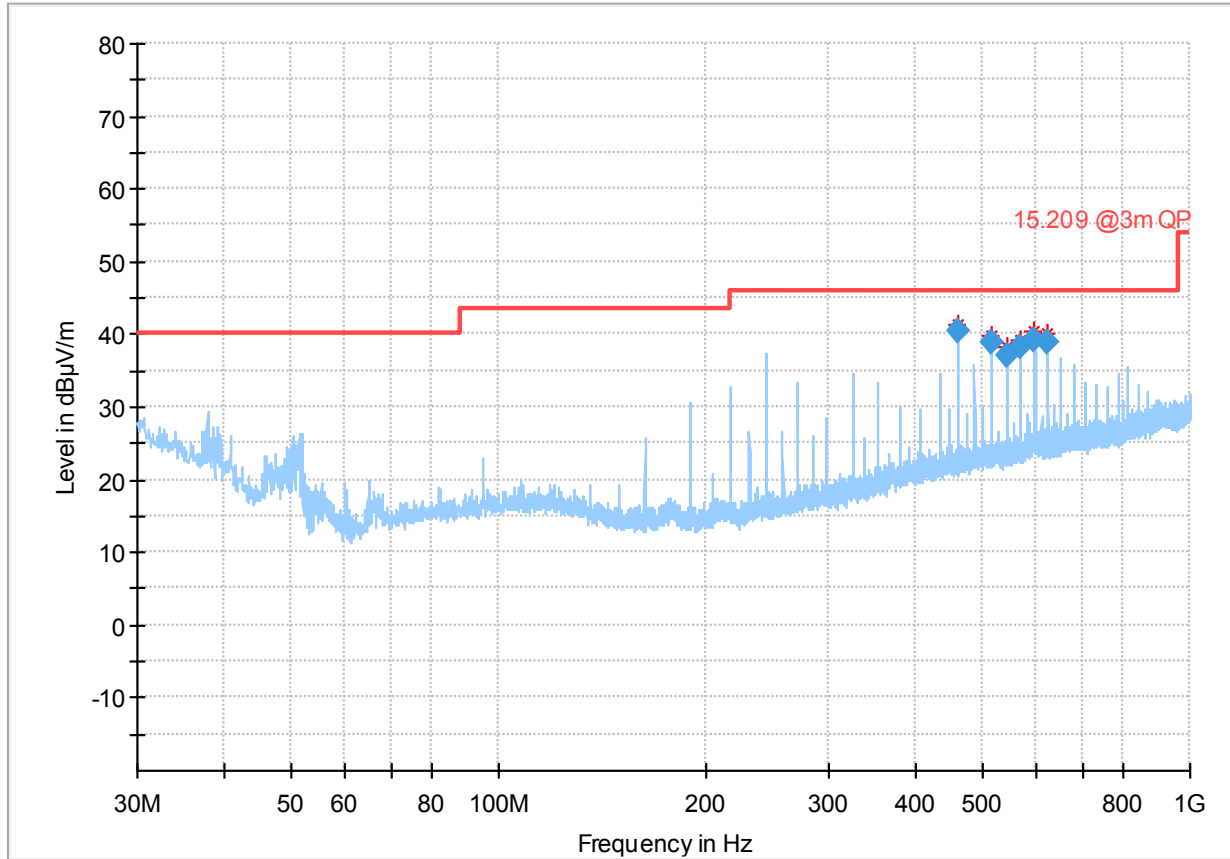

— Preview Result 1-PK+      \* Critical\_Freqs PK+  
— 15.209 @3m QP      ◆ Final\_Result QPK

### Final\_Result

Frequency (MHz)	QuasiPeak (dBµV/m)	Limit (dBµV/m)	Margin (dB)	Meas. Time (ms)	Bandwidth (kHz)	Height (cm)	Pol	Azimuth (deg)
461.043000	40.56	46.00	5.44	100.0	120.000	100.0	V	54.0
515.291000	38.84	46.00	7.16	100.0	120.000	103.0	V	52.0
542.402500	37.15	46.00	8.85	100.0	120.000	100.0	V	296.0
569.537500	38.42	46.00	7.58	100.0	120.000	100.0	V	285.0
596.649000	39.32	46.00	6.68	100.0	120.000	100.0	V	311.0
623.760500	39.00	46.00	7.00	100.0	120.000	131.0	H	330.0

(continuation of the "Final\_Result" table from column 15 ...)

Frequency (MHz)	Corr. (dB/m)	Comment
461.043000	17.3	17:54:53 - 12.12.2022
515.291000	18.2	17:56:39 - 12.12.2022
542.402500	18.5	17:58:48 - 12.12.2022
569.537500	19.0	18:00:39 - 12.12.2022
596.649000	19.5	18:02:29 - 12.12.2022
623.760500	19.8	17:52:25 - 12.12.2022

### 7.3 Frequency tolerance

**Description / Limits**

§15.225 (e) The frequency tolerance of the carrier signal shall be maintained within  $\pm 0.01\%$  of the operating frequency over a temperature variation of  $-20$  degrees to  $+ 50$  degrees C at normal supply voltage, and for a variation in the primary supply voltage from 85% to 115% of the rated supply voltage at a temperature of 20 degrees C. For battery operated equipment, the equipment tests shall be performed using a new battery.

**Test setup:** see 8.3

**Test results**

EUT mode	Test conditions	Declared frequency [MHz]	Measured frequency [MHz]	Deviation [%]	Deviation [ppm]
Tx	-20 °C	13.56	13.56000	0	0
Tx	+20 °C	13.56	13.56000	0	0
Tx	+50 °C	13.56	13.56000	0	0

With voltage variation:

Input voltage variation 9 V to 16 V DC does not affect the transmitted signal.

**Note:**

Testing was performed with high duty cycle for testing purpose.



TR no.: 22097767-29122-0

2023-01-12

Plot no. 6: frequency tolerance @ -40 °C

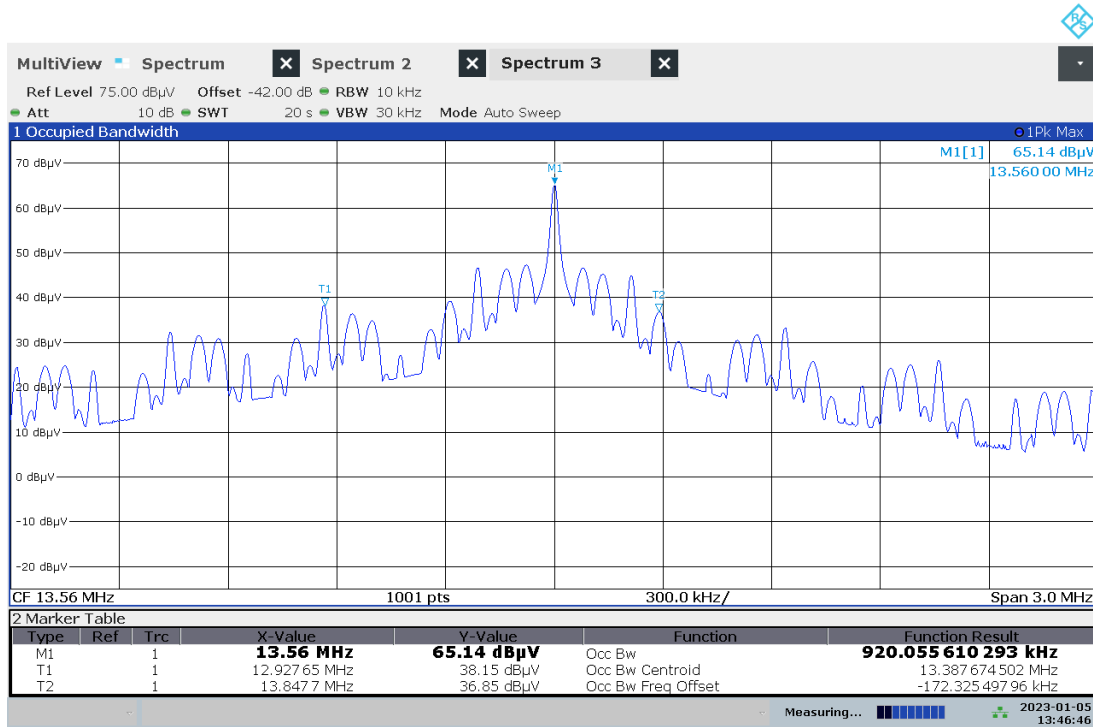

01:46:47 01/05/2023

Plot no. 7: frequency tolerance @ +20 °C

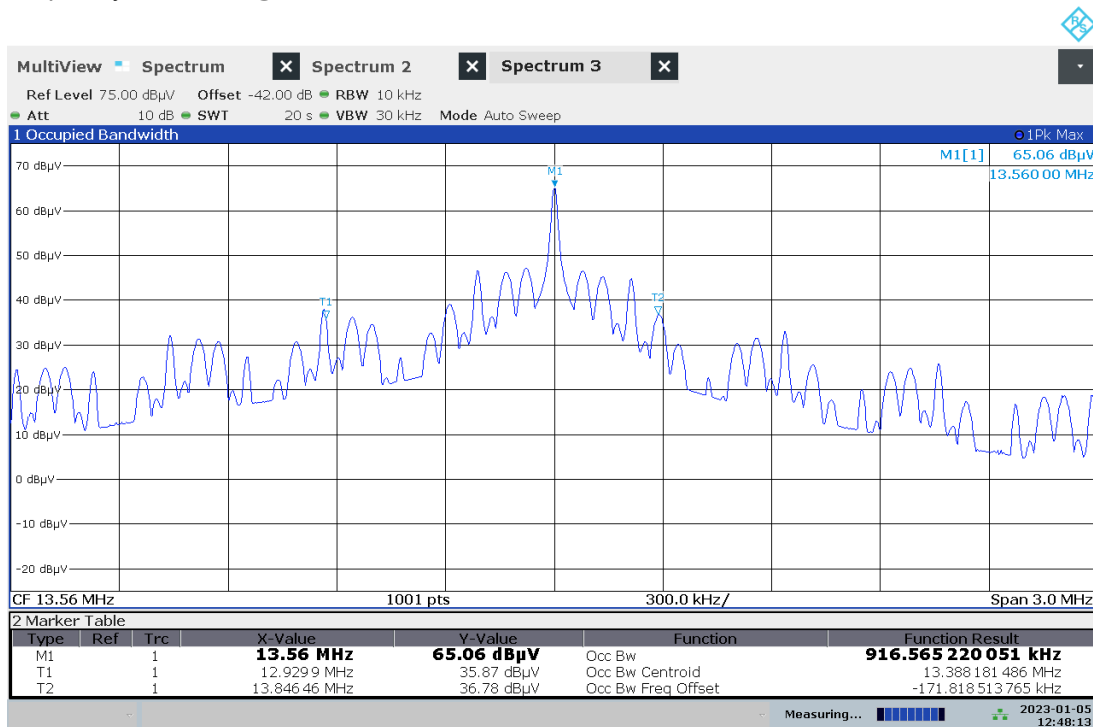

12:48:14 01/05/2023

TR no.: 22097767-29122-0

2023-01-12

Plot no. 8: frequency tolerance @ +80 °C

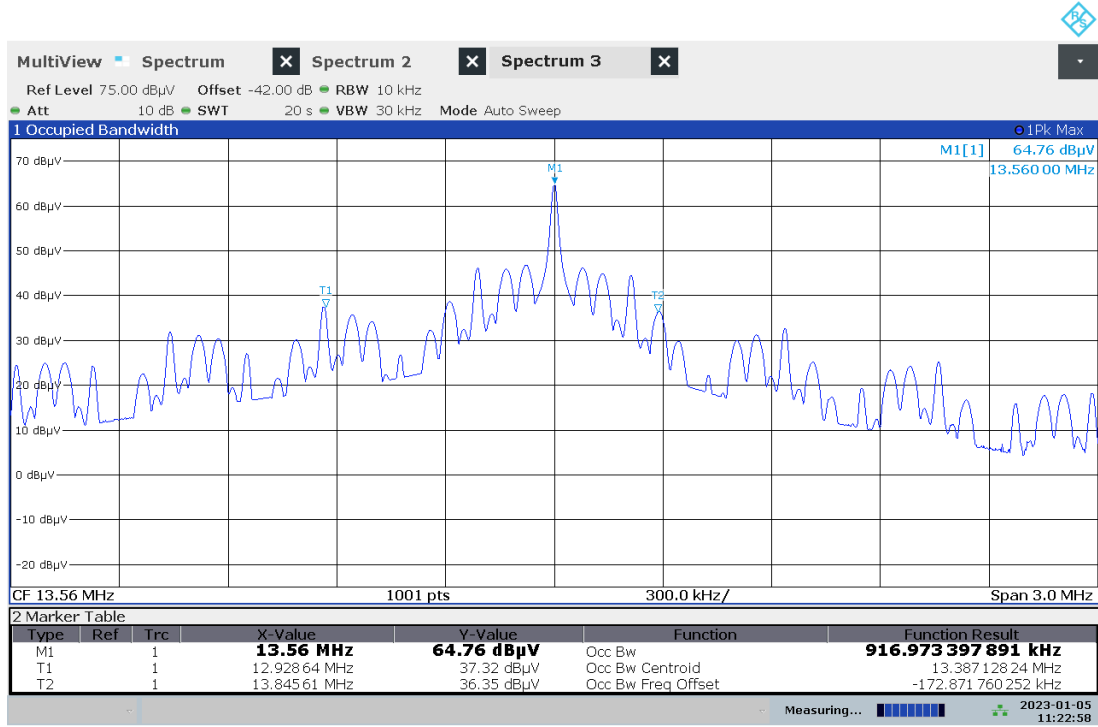

11:22:58 01/05/2023

## 7.4 20 dB bandwidth / occupied bandwidth

### Description

The occupied bandwidth or the “99% emission bandwidth” is defined as the frequency range between two points, one above and the other below the carrier frequency, within which 99% of the total transmitted power of the fundamental transmitted emission is contained. The occupied bandwidth shall be reported for all equipment in addition to the specified bandwidth required in the applicable RSSs.

In some cases, the “x dB bandwidth” is required, which is defined as the frequency range between two points, one at the lowest frequency below and one at the highest frequency above the carrier frequency, at which the maximum power level of the transmitted emission is attenuated x dB below the maximum in-band power level of the modulated signal, where the two points are on the outskirts of the in-band emission.

The following conditions shall be observed for measuring the occupied bandwidth and x dB bandwidth:

- The transmitter shall be operated at its maximum carrier power measured under normal test conditions.
- The span of the spectrum analyzer shall be set large enough to capture all products of the modulation process, including the emission skirts, around the carrier frequency, but small enough to avoid having other emissions (e.g. on adjacent channels) within the span.
- The detector of the spectrum analyzer shall be set to “Sample”. However, a peak, or peak hold, may be used in place of the sampling detector since this usually produces a wider bandwidth than the actual bandwidth (worst-case measurement). Use of a peak hold (or “Max Hold”) may be necessary to determine the occupied / x dB bandwidth if the device is not transmitting continuously.
- The resolution bandwidth (RBW) shall be in the range of 1% to 5% of the actual occupied / x dB bandwidth and the video bandwidth (VBW) shall not be smaller than three times the RBW value. Video averaging is not permitted.

**Note:** It may be necessary to repeat the measurement a few times until the RBW and VBW are in compliance with the above requirement.

For the 99% emission bandwidth, the trace data points are recovered and directly summed in linear power level terms. The recovered amplitude data points, beginning at the lowest frequency, are placed in a running sum until 0.5% of the total is reached, and that frequency recorded. The process is repeated for the highest frequency data points (starting at the highest frequency, at the right side of the span, and going down in frequency). This frequency is then recorded. The difference between the two recorded frequencies is the occupied bandwidth (or the 99% emission bandwidth).

### Test procedure

ANSI C63.10, 6.9.3

The occupied bandwidth is the frequency bandwidth such that, below its lower and above its upper frequency limits, the mean powers are each equal to 0.5% of the total mean power of the given emission.

The following procedure shall be used for measuring 99% power bandwidth:

- a) The instrument center frequency is set to the nominal EUT channel center frequency. The frequency span for the spectrum analyzer shall be between 1.5 times and 5.0 times the OBW.
- b) The nominal IF filter bandwidth (3 dB RBW) shall be in the range of 1% to 5% of the OBW, and VBW shall be approximately three times the RBW, unless otherwise specified by the applicable requirement.
- c) Set the reference level of the instrument as required, keeping the signal from exceeding the maximum input mixer level for linear operation. In general, the peak of the spectral envelope shall be more than  $[10 \log(\text{OBW/RBW})]$  below the reference level. Specific guidance is given in 4.1.5.2.
- d) Step a) through step c) might require iteration to adjust within the specified range.
- e) Video averaging is not permitted. Where practical, a sample detection and single sweep mode shall be used. Otherwise, peak detection and max hold mode (until the trace stabilizes) shall be used.
- f) Use the 99% power bandwidth function of the instrument (if available) and report the measured bandwidth.
- g) If the instrument does not have a 99% power bandwidth function, then the trace data points are recovered and directly summed in linear power terms. The recovered amplitude data points, beginning at the lowest frequency, are placed in a running sum until 0.5% of the total is reached; that frequency is recorded as the lower frequency. The process is repeated until 99.5% of the total is reached; that frequency is recorded as the upper frequency. The 99% power bandwidth is the difference between these two frequencies.
- h) The occupied bandwidth shall be reported by providing plot(s) of the measuring instrument display; the plot axes and the scale units per division shall be clearly labeled. Tabular data may be reported in addition to the plot(s).

**Note**  
 Measurements with the peak detector are also suitable to demonstrate compliance of an EUT, as long as the required resolution bandwidth is used, because peak detection will yield amplitudes equal to or greater than amplitudes measured with RMS detector. The measurement data from a spectrum analyser peak detector will represent the worst-case results (see ANSI C63.10).

**Test Parameters:**

Detector	Pos-Peak (worst-case)		
Trace-mode	Max Hold		
Resolution bandwidth RBW	10 kHz		
Video bandwidth	≥ RBW		
Span	see plots		
Sweep time	see plots		
Measurement uncertainty	±1 x 10 <sup>-7</sup>		
Test environment	Normal and extreme		
Test set-up	<input type="checkbox"/> Conducted	<input type="checkbox"/> Radiated	<input checked="" type="checkbox"/> Test Fixture

**Test Results:**

Channel	Min. Frequency F <sub>L</sub> [MHz]	Max. frequency F <sub>H</sub> [MHz]	20 dB bandwidth [kHz]
1	13.533	13.587	53.9

Channel	Min. Frequency F <sub>L</sub> [MHz]	Max. frequency F <sub>H</sub> [MHz]	Occupied bandwidth (99%) [kHz]
1	12.930	13.846	916.565

Where: F<sub>L</sub> = is the lower edge of the OBW  
 F<sub>H</sub> = is the upper edge of the OBW

<b>Verdict</b>	<b>- PASS -</b>	<i>Measurement plot(s) see next page(s).</i>
----------------	-----------------	--

<b>Comment</b>	
----------------	--

Plot No. 9: 20 dB Bandwidth

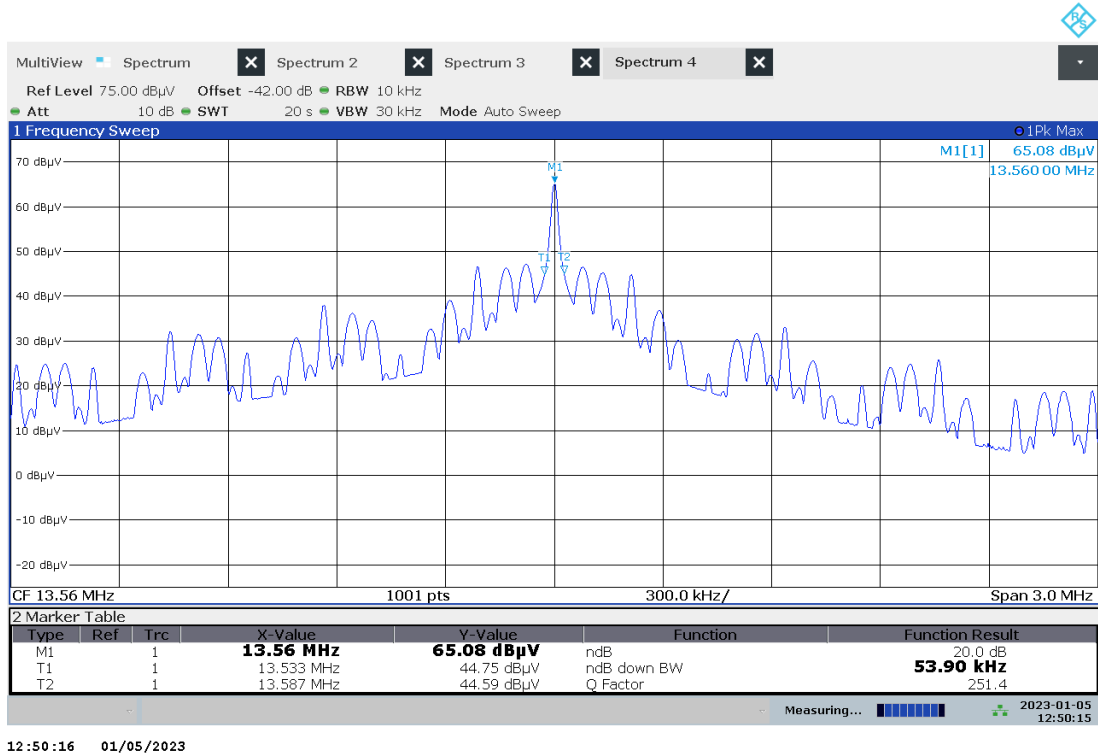

Plot No. 10: 99% Occupied Bandwidth

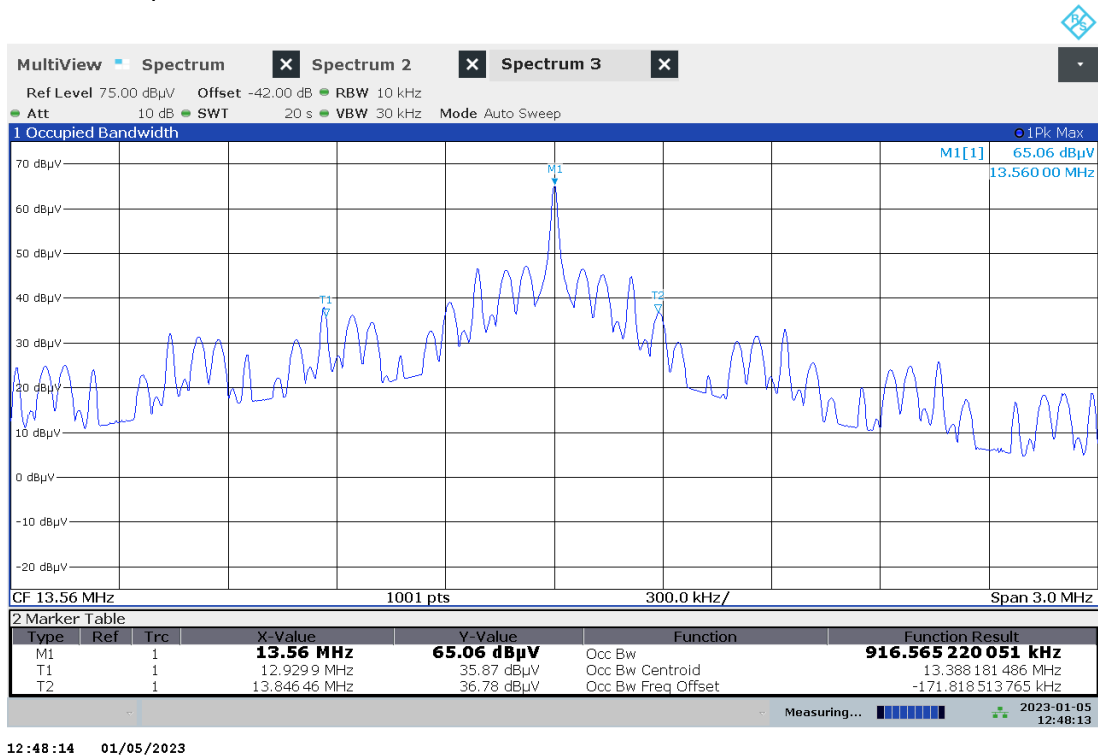

## 8 Test Setup Description

Typically, the calibrations of the test apparatus are commissioned to and performed by an accredited calibration laboratory. The calibration intervals are determined in accordance with the DIN EN ISO/IEC 17025. In addition to the external calibrations, the laboratory executes comparison measurements with other calibrated test systems or effective verifications. Cyclic chamber inspections and range calibrations are performed. Where possible, RF generating and signalling equipment as well as measuring receivers and analysers are connected to an external high-precision 10 MHz reference (GPS-based or rubidium frequency standard).

In order to simplify the identification of the equipment used at some special tests, some items of test equipment and ancillaries can be provided with an identifier or number in the equipment list below (Lab/Item).

### Kind of calibration (abbreviations):

- C = calibrated
- CM = cyclic maintenance
- NR = not required
- L = locked

## 8.1 Semi Anechoic Chamber with Ground Plane

Radiated measurements are performed in vertical and horizontal plane in the frequency range 30 MHz to 1 GHz in a Semi Anechoic Chamber with a metallic ground plane. The EUT is positioned on a non-conductive test table with a height of 0.80 m above the metallic ground plane that covers the whole chamber. The receiving antennas conform to specification ANSI C63.10-2013, American National Standard for Testing Unlicensed Wireless Devices. These antennas can be moved over the height range between 1.0 m and 4.5 m in order to search for maximum field strength emitted from the EUT. The measurement distances between EUT and receiving antennas are indicated in the test setups for the various frequency ranges. For each measurement, the EUT is rotated in all three axes until the maximum field strength is received. The wanted and unwanted emissions are received by a spectrum analyzer where the detector modes and resolution bandwidths over various frequency ranges are set according to requirement ANSI C63.

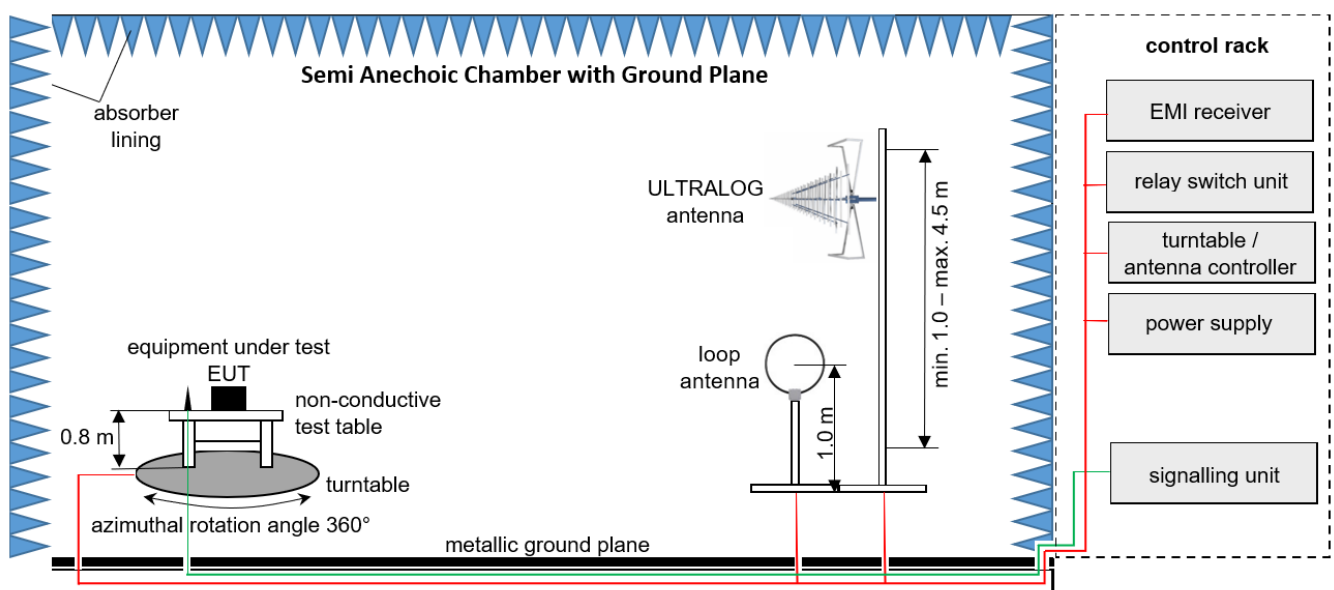

Measurement distance: ULTRALOG antenna at 3 m; loop antenna at 3 m

EMC32 software version: 11.20.00

$$FS = UR + CL + AF$$

(FS-field strength; UR-voltage at the receiver; CL-loss of the cable; AF-antenna factor)

Example calculation:

$$FS [dB\mu V/m] = 12.35 [dB\mu V/m] + 1.90 [dB] + 16.80 [dB/m] = 31.05 [dB\mu V/m] (35.69 \mu V/m)$$

**List of test equipment used:**

No.	Equipment	Manufacturer	Type	Serial No.	IBL No.	Kind of Calibration	Last / Next Calibration
1	Power Supply	Elektro-Automatik GmbH & Co. KG	EA-PSI 9080-40 T	2000230001	LAB000313	NR	–
2	Test table	innco systems GmbH	PT1208-080-RH	-	LAB000306	NR	–
3	Power Supply	Chroma	61604	616040005416	LAB000285	NR	–
4	Positioner	matur GmbH	TD 1.5-10KG		LAB000258	NR	–
5	Compressed Air	Implotex	1-850-30	-	LAB000256	NR	–
6	EMI Test Receiver	Rohde & Schwarz	ESW26	101481	LAB000236	C	2022-07-07 → 12M → 2023-07-07
7	Semi/Fully Anechoic Chamber (SFAC)	Albatross Projects GmbH	Babylon 5 (SAC 5)	20168.PRB	LAB000235	NR	–
8	Measurement Software	Rohde & Schwarz	EMC32 V11.20		LAB000226	NR	–
9	Turntable	matur GmbH	TT2.0-2t	TT2.0-2t/921	LAB000225	NR	–
10	Antenna Mast	matur GmbH	CAM4.0-P	CAM4.0-P/316	LAB000224	NR	–
11	Antenna Mast	matur GmbH	BAM4.5-P	BAM4.5-P/272	LAB000223	NR	–
12	Controller	matur GmbH	FCU 3.0	10082	LAB000222	NR	–
13	Power Supply	Elektro-Automatik GmbH & Co. KG	EA-PS 2042-10 B	2878350292	LAB000191	NR	–
14	Pre-Amplifier	Schwarzbeck Mess-Elektronik OHG	BBV 9718 C	84	LAB000169	NR	–
15	Antenna	Rohde & Schwarz	HF907	102899	LAB000151	C	2020-04-23 → 36M → 2023-04-23
16	Antenna	Rohde & Schwarz	HL562E	102005	LAB000150	C	2020-07-05 → 36M → 2023-07-05
17	Open Switch and Control Platform	Rohde & Schwarz	OSP200 Base Unit 2HU	101748	LAB000149	NR	–
18	Antenna	Rohde & Schwarz	HF907	102898	LAB000124	C	2020-04-23 → 36M → 2023-04-23
19	Antenna	Rohde & Schwarz	HL562E	102001	LAB000123	C	2020-07-05 → 36M → 2023-07-05
20	Antenna	Rohde & Schwarz	HFH2-Z2E - Active Loop Antenna	100954	LAB000108	C	2020-03-25 → 36M → 2023-03-25



## 8.2 Measurements under normal and extreme climatic conditions

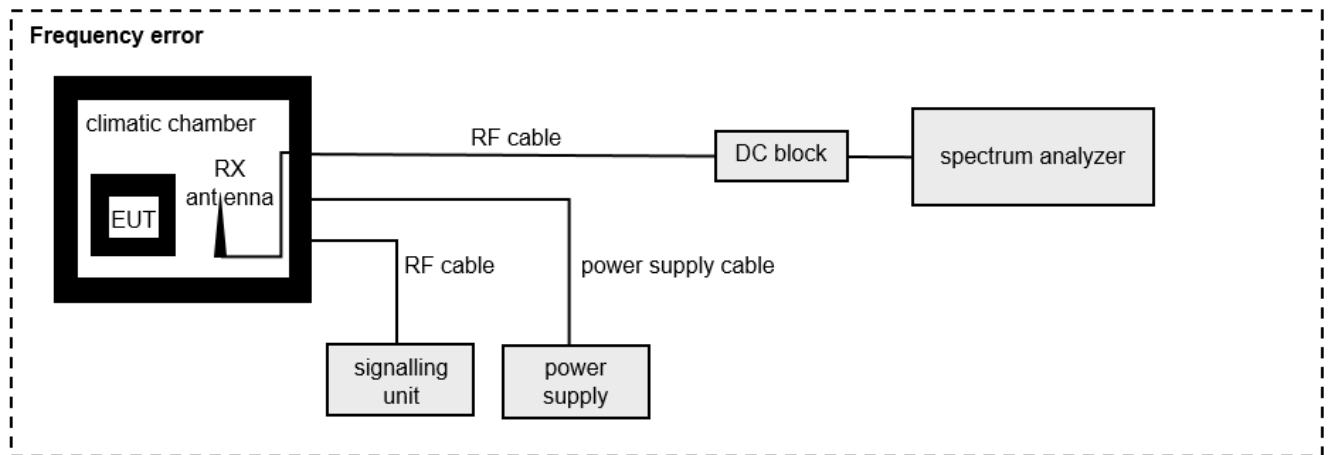

### List of test equipment used:

No.	Equipment	Manufacturer	Type	Serial No.	IBL No.	Kind of Calibration	Last / Next Calibration
1	Power Supply	PS 2042-10 B	Elektro-Automatic GmbH	2878350263	LAB000190	NR	–
2	Coaxial Cable	Huber & Suhner	ST18/72"	2575556	LAB000395	CM	2022-05-31 → 12M → 2023-05-31
3	Spectrum Analyser	Rohde & Schwarz	FSW50	101450	LAB000111	C	2022-07-28 → 12M → 2023-07-28
4	Climatic Chamber	T65/50	CTS GmbH	204002	LAB000110	CM	2022-05-11 → 12M → 2023-05-11
5	Loop antenna	IBL	–	–	–	NR	–

## 9 MEASUREMENT PROCEDURES

### 9.1 Radiated spurious emissions from 9 kHz to 30 MHz

#### Test setup

- The EUT is set up according to its intended use, as described in the user manual or as defined by the manufacturer.
- In case of floor standing equipment, it is placed in the middle of the turn table.  
In case of tabletop equipment it is placed on a non-conductive table with a height of 80 cm.
- Additional equipment, cables, ... necessary for testing, are positioned like under normal operation.
- Interface cables, e.g. power supply, network, ... are connected to the connection box in the turn table.
- EUT is powered on and set into operation.

#### Pre-scan

- Turntable performs an azimuthal rotation from 0° to 315° in 45° steps.
- For each turntable step the EMI-receiver/spectrum analyser performs a positive-peak/max-hold sweep (=worst-case). Data is transferred to EMI-software and recorded. EMI-software will show the maximum level of all single sweeps as the final result for the pre-scan.

#### Final measurement

- Significant emissions found during the pre-scan will be maximized by the EMI-software by rotating the turntable from 0° to 360°.
- Loop antenna is rotated with special 3D adapter set to find maximum level of emissions.
- Plot of the pre-scan with frequencies of identified emissions including levels, correction factors, turn table position and settings of measuring equipment is recorded.

#### Distance correction (extrapolation)

- When performing measurements on test distances other than defined in the rules, the results shall be extrapolated to the specified distance by conservatively presuming that the field strength decays at 40 dB/decade of distance in the region closer than  $\lambda$  in m divided by  $2\pi$  (i.e.,  $\lambda/2\pi$ ), and at 20 dB/decade of distance beyond that, using the measurement of a single point at the radial angle that produces the maximum emission.  
This correction is already included in the limit line of corresponding measurement plots.

Detailed requirements can be found in e.g. ANSI C63.4 / C63.10

## 9.2 Radiated spurious emissions from 30 MHz to 1 GHz

### Test setup

- The EUT is set up according to its intended use, as described in the user manual or as defined by the manufacturer.
- In case of floor standing equipment, it is placed in the middle of the turn table.  
In case of tabletop equipment it is placed on a non-conductive table with a height of 80 cm.
- Additional equipment, cables, ... necessary for testing, are positioned like under normal operation.
- Interface cables, e.g. power supply, network, ... are connected to the connection box in the turn table.
- EUT is powered on and set into operation.

### Pre-scan

- Turntable performs an azimuthal rotation from 0° to 315° in 45° steps.
- Antenna polarisation is changed (H-V / V-H) and antenna height is changed from 1 meter to 4 meters.
- For each turntable step / antenna polarisation / antenna height the EMI-receiver/spectrum analyser performs a positive-peak/max-hold sweep (=worst-case). Data is transferred to EMI-software and recorded. EMI-software will show the maximum level of all single sweeps as the final result for the pre-scan.

### Final measurement

- Significant emissions found during the pre-scan will be maximized by the EMI-software based on evaluated data during the pre-scan by rotating the turntable and changing antenna height and polarisation.
- Final measurement will be performed with measuring equipment settings as defined in the applicable test standards (e.g. ANSI C6.4).
- Plot of the pre-scan with frequencies of identified emissions including levels, correction factors, turn table position, antenna polarisation and settings of measuring equipment is recorded.

### Distance correction (extrapolation)

- When performing measurements on test distances other than defined in the rules, the results shall be extrapolated to the specified distance by conservatively presuming that the field strength decays at 20 dB/decade of distance beyond the region  $\lambda$  in m divided by  $2\pi$  (i.e.,  $\lambda/2\pi$ ), using the measurement of a single point at the radial angle that produces the maximum emission.  
This correction is already included in the corresponding measurement plots.

Detailed requirements can be found in e.g. ANSI C63.4 / C63.10

### 9.3 Radiated spurious emissions from 1 GHz to 18 GHz

#### Test setup

- The EUT is set up according to its intended use, as described in the user manual or as defined by the manufacturer.
- In case of floor standing equipment, it is placed in the middle of the turn table.  
In case of tabletop equipment it is placed on a non-conductive table with a height of 80 cm.
- Additional equipment, cables, ... necessary for testing, are positioned like under normal operation.
- Interface cables, e.g. power supply, network, ... are connected to the connection box in the turn table.
- EUT is powered on and set into operation.

#### Pre-scan

- Turntable performs an azimuthal rotation from 0° to 315° in 45° steps.
- Antenna polarisation is changed (H-V / V-H) and antenna height is changed from 1 meter to 4 meters.
- For each turntable step / antenna polarisation / antenna height the EMI-receiver/spectrum analyser performs a positive-peak/max-hold sweep (=worst-case). Data is transferred to EMI-software and recorded. EMI-software will show the maximum level of all single sweeps as the final result for the pre-scan.

#### Final measurement

- Significant emissions found during the pre-scan will be maximized by the EMI-software based on evaluated data during the pre-scan by rotating the turntable and changing antenna height and polarisation.
- Final measurement will be performed with measuring equipment settings as defined in the applicable test standards (e.g. ANSI C6.4).
- Plot of the pre-scan with frequencies of identified emissions including levels, correction factors, turn table position, antenna polarisation and settings of measuring equipment is recorded.

#### Distance correction (extrapolation)

- When performing measurements on test distances other than defined in the rules, the results shall be extrapolated to the specified distance by conservatively presuming that the field strength decays at 20 dB/decade of distance beyond the region  $\lambda$  in m divided by  $2\pi$  (i.e.,  $\lambda/2\pi$ ), using the measurement of a single point at the radial angle that produces the maximum emission.  
This correction is already included in the corresponding measurement plots.

Detailed requirements can be found in e.g. ANSI C63.4 / C63.10

## 10 MEASUREMENT UNCERTAINTIES

Radio frequency	$\leq \pm 10$ ppm
Radiated emission	$\leq \pm 6$ dB
Temperature	$\leq \pm 1$ °C
Humidity	$\leq \pm 5$ %
DC and low frequency voltages	$\leq \pm 3$ %

The indicated expanded measurement uncertainty corresponds to the standard measurement uncertainty for the measurement results multiplied by the coverage factor  $k = 2$ . It was determined in accordance with EA-4/01 m:2013. The true value is located in the corresponding interval with a probability of 95 %.

**Annex 1 EUT Photographs, external**

Photo No. 1: Left Maximum

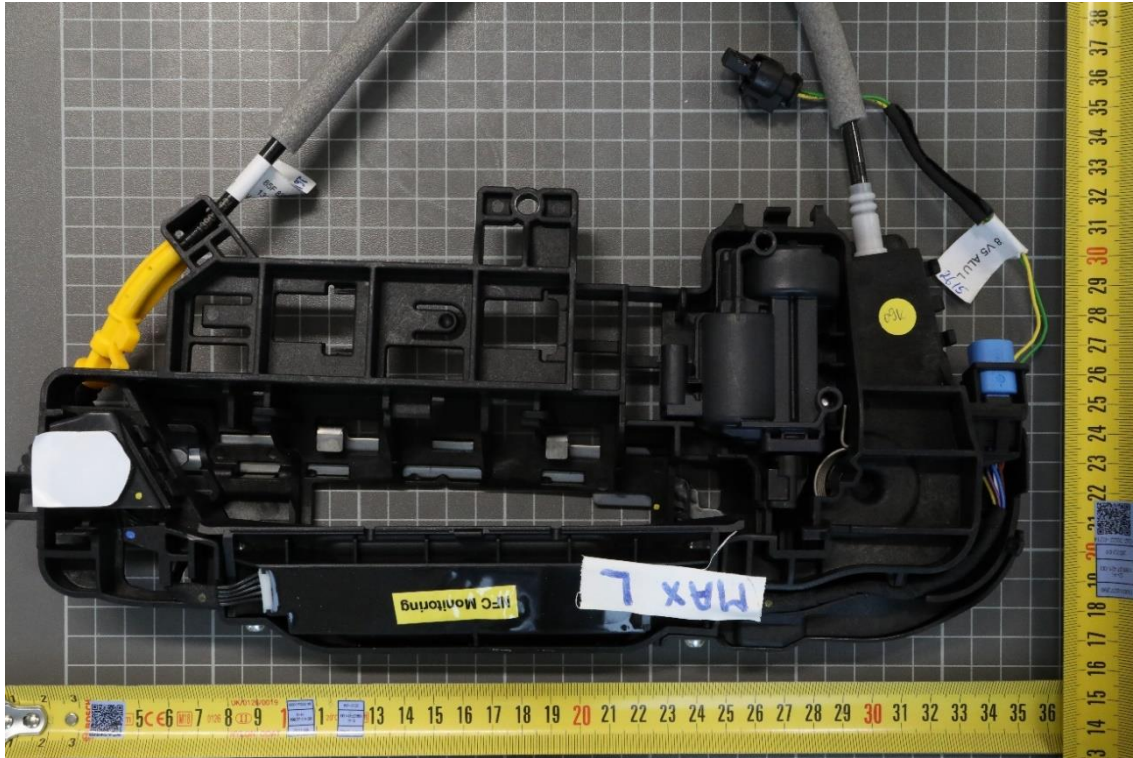

Photo No. 2:

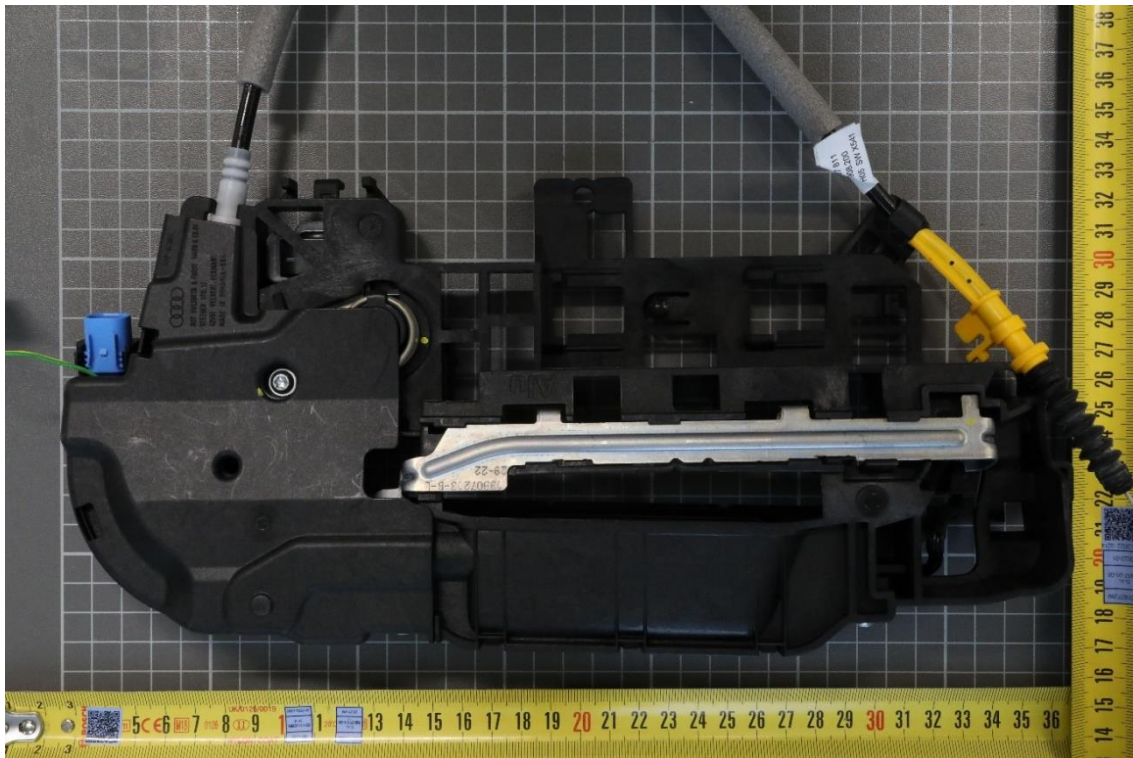

Photo No. 3: Left Minimum

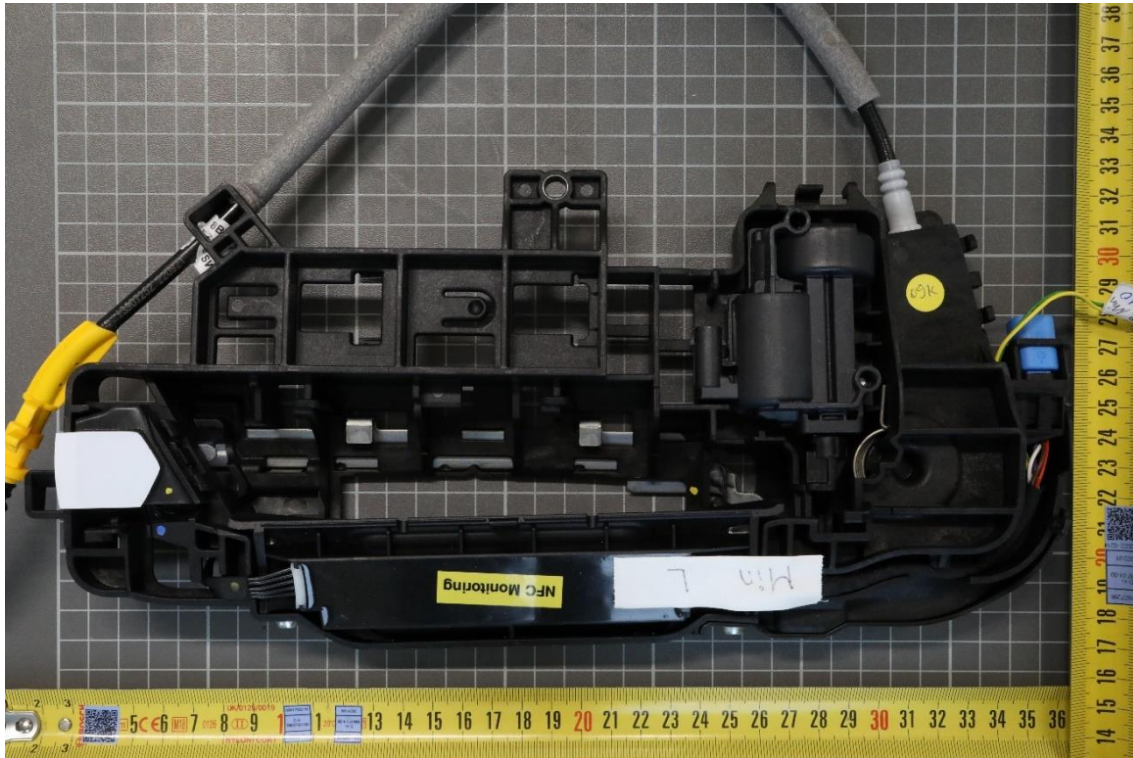
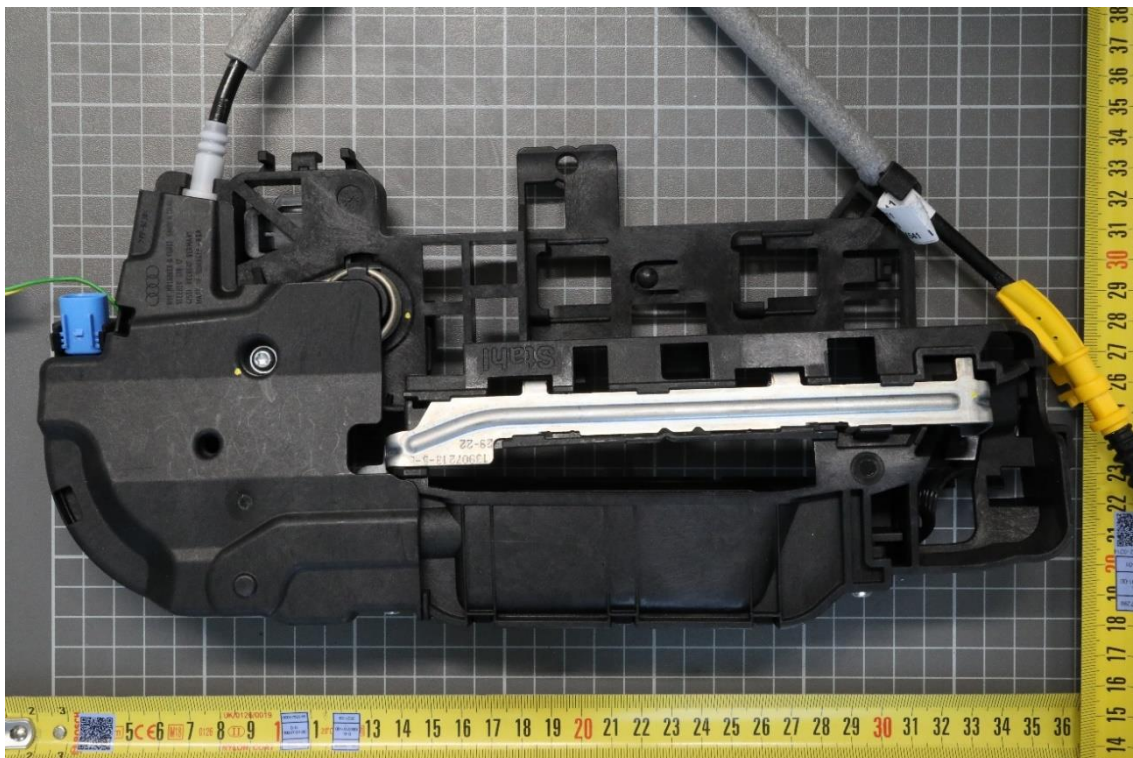

Photo No. 4:



TR no.: 22097767-29122-0

2023-01-12

Photo No. 5:



Photo No. 6:

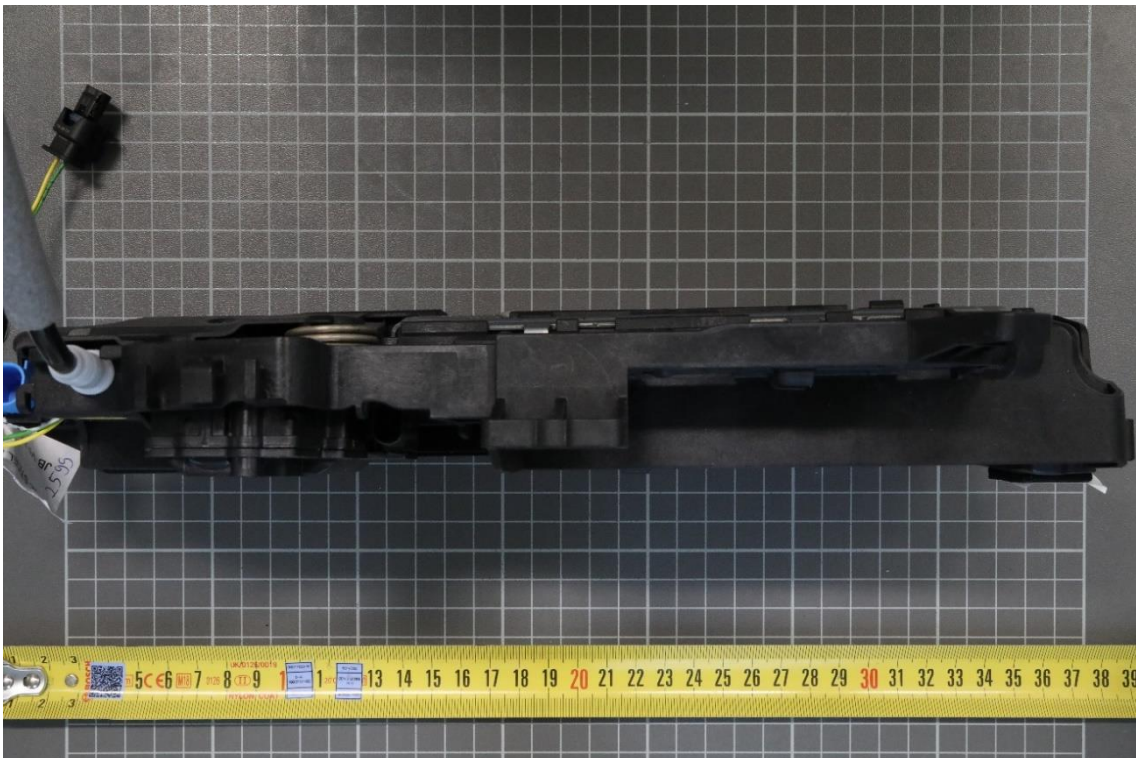



Photo No. 7:

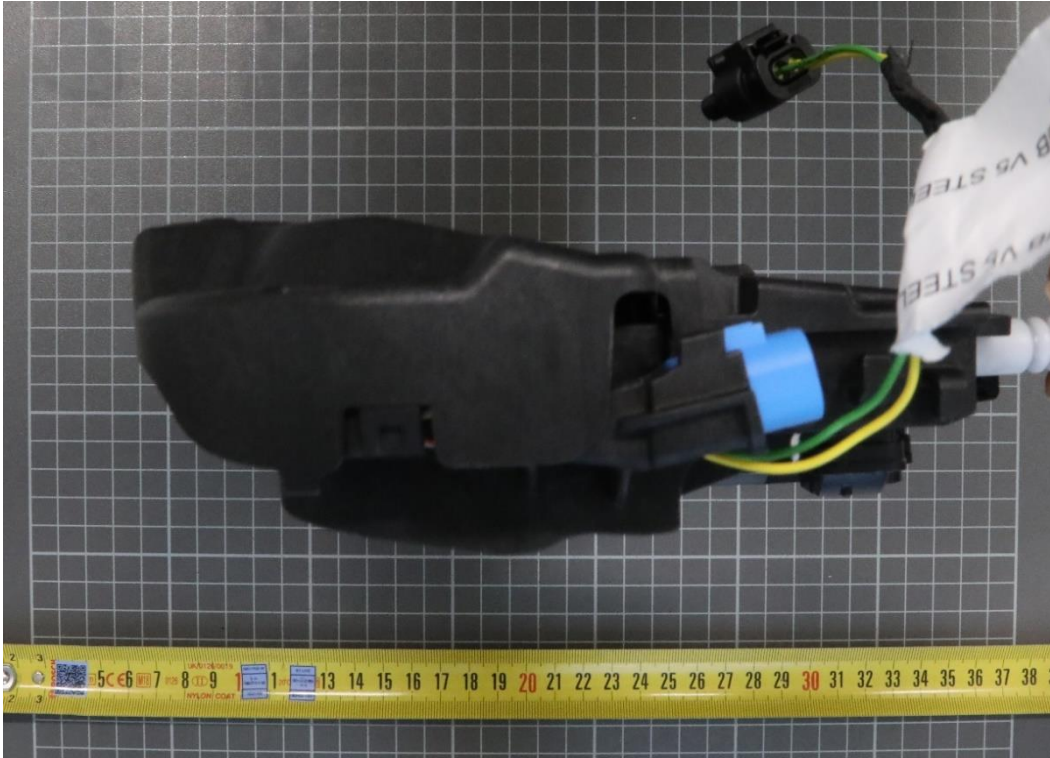

Photo No. 8:



**Annex 2 EUT Photographs, internal**

Photo No. 9:

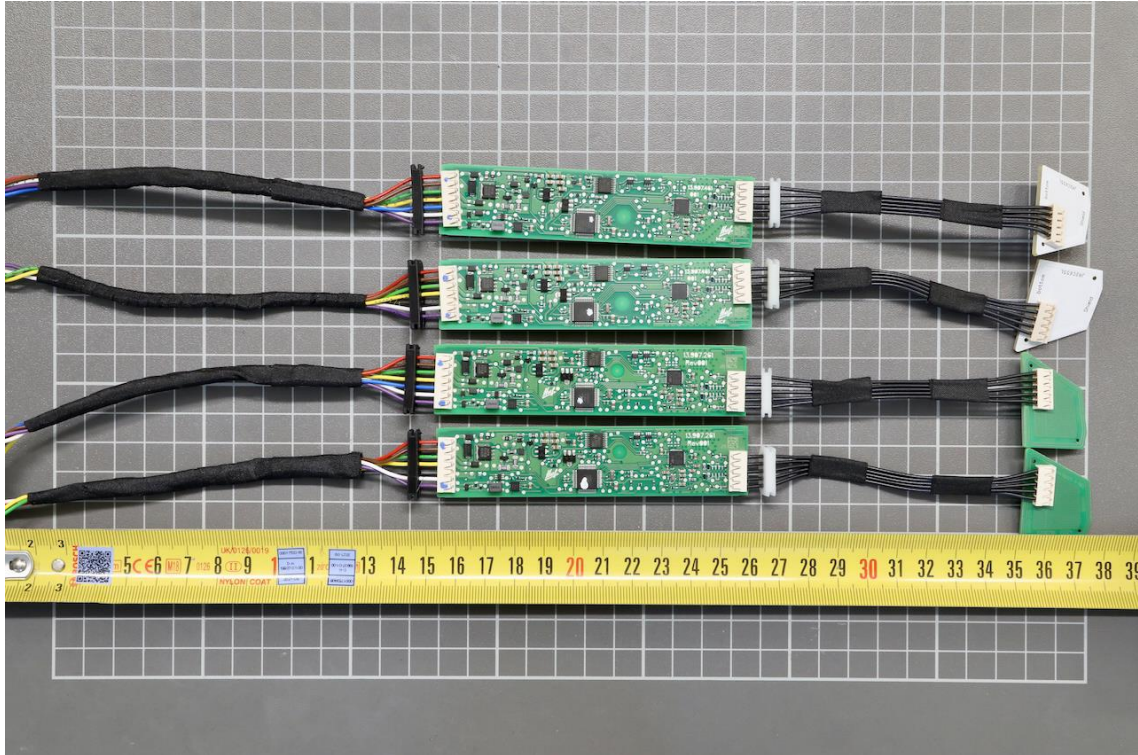

Photo No. 10:

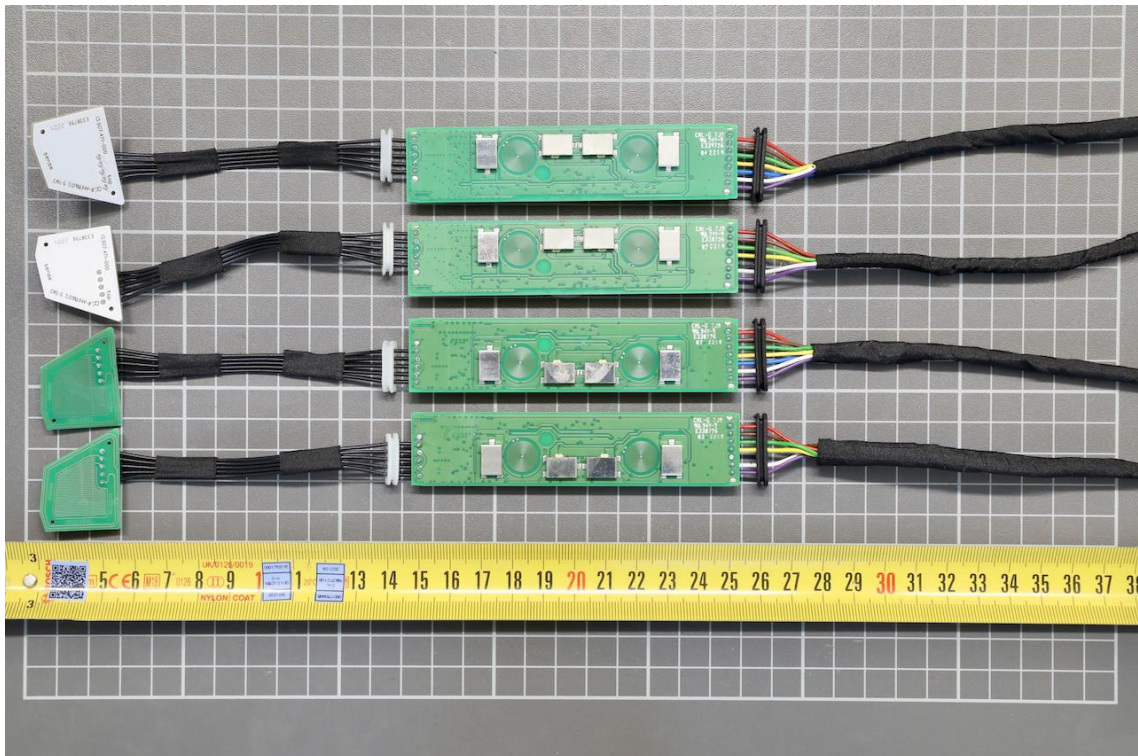

Photo No. 11

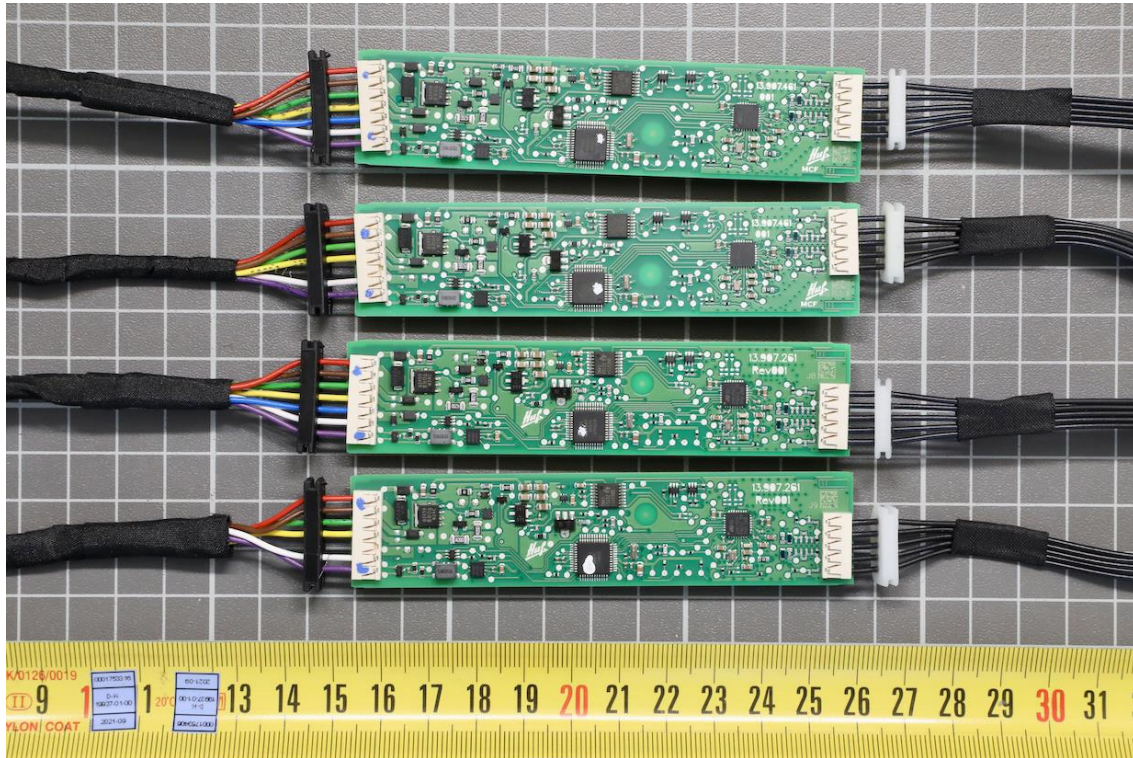
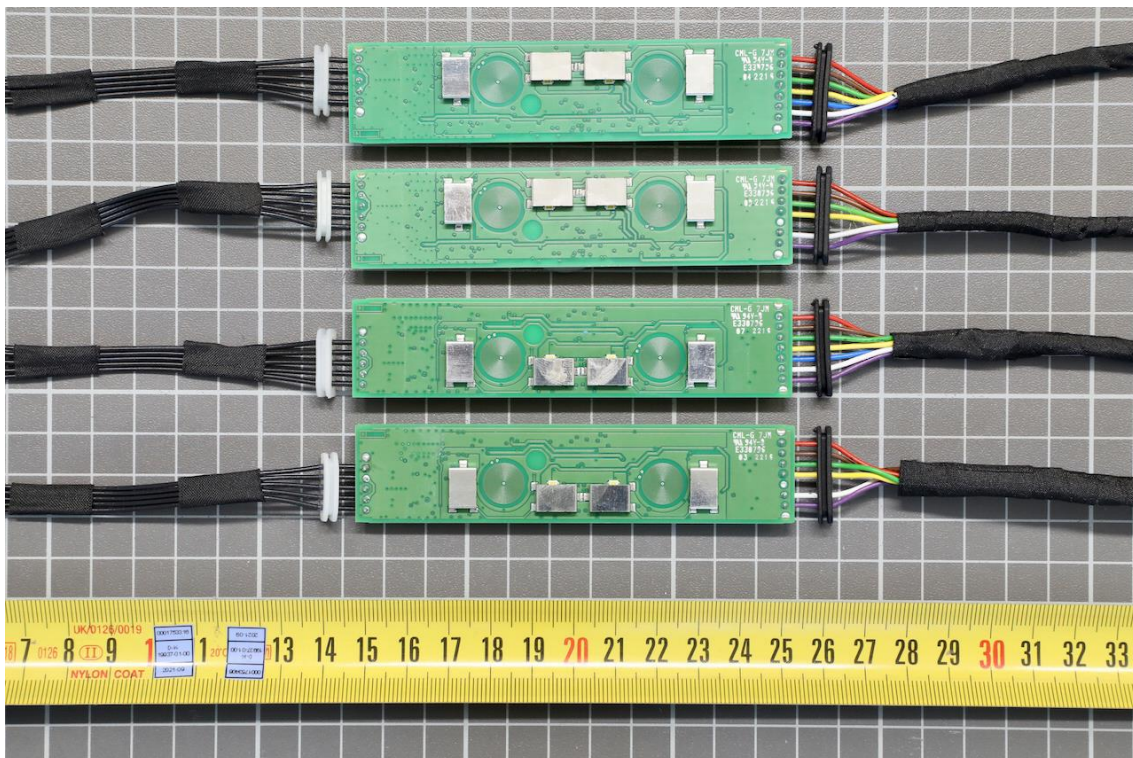

Photo No. 12:



**Annex 3 Test Setup Photographs**

Photo No. 13:

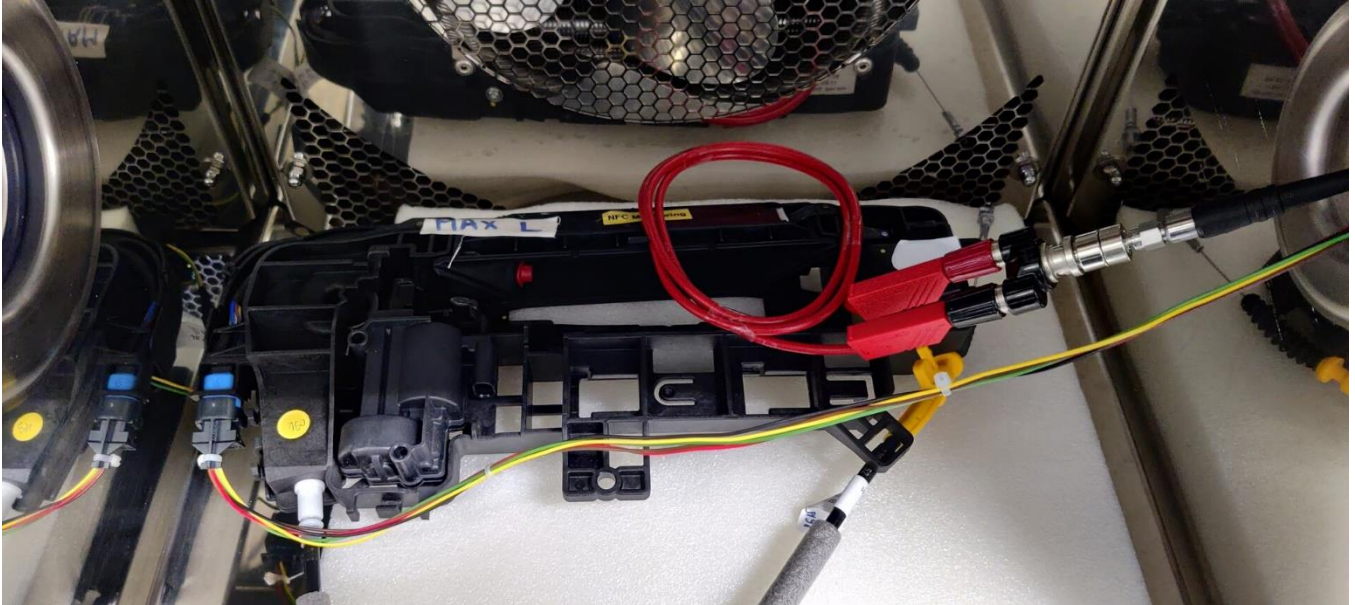

Photo No. 14:



Photo No. 15:



Photo No. 16:



Photo No. 17:



---

**End of Test Report**

---