



BNetzA-CAB-21/21-21

# Test Report

Test report no.: 21045477-21304-0

Date of issue: 2023-03-22

**Test result:** The test item - **passed** - and complies with below listed standards.

## Applicant

Huf Hülsbeck & Fürst GmbH & Co. KG

## Manufacturer

Huf Hülsbeck & Fürst GmbH & Co. KG

## Test Item

MINI\_TAGE

## RF-Spectrum Testing according to:

### FCC 47 CFR Part 15

Radio Frequency Devices (Subpart C)

### RSS-210, Issue 10 (2019-12)

Digital Transmission Systems (DTSs), Frequency Hopping Systems (FHSs) and Licence-Exempt Local Area Network (LE-LAN) Devices

### RSS-Gen, Issue 5 (2018-04)

General Requirements for Compliance of Radio Apparatus

Tested by  
(name, function, signature)

*Piotr Sardyko*  
Deputy Head of Laboratory RF

signature

Approved by  
(name, function, signature)

*Andreas Bender*  
Deputy Managing Director

signature

<b>Applicant and Test item details</b>	
<b>Applicant</b>	Huf Hülsbeck & Fürst GmbH & Co. KG Steeger Straße 17 42551, Velbert, Germany +49 (0)2051 272-0 +49 (0)2051 272-207
<b>Manufacturer</b>	same as applicant
<b>Test item description</b>	NFC door handle
<b>Model/Type reference</b>	MINI_TAGE
<b>FCC ID</b>	YGOMINITAGE
<b>IC</b>	4008C-MINITAGE
<b>HMN</b>	-/-
<b>PMN</b>	HUF MINI_TAGE
<b>HVIN</b>	MINI_TAGE
<b>FVIN</b>	-/-
<b>Frequency</b>	13.56 MHz
<b>Antenna</b>	Integrated PCB antenna
<b>Power supply (function)</b>	9 – 16 V DC
<b>Temperature range</b>	-40 °C – +85 °C

#### Disclaimer and Notes

The content of this test report relates to the mentioned test sample(s) only.  
Without a written permit of IBL-Lab GmbH, this test report shall not be reproduced, except in full.

Copyright ©: All rights reserved by IBL-Lab GmbH

Within this test report, a ☒ point / ☐ comma is used as a decimal separator.  
If otherwise, a detailed note is added adjoined to its use.

Decision rule: Binary Statement for Simple Acceptance Rule according ILAC-G8:09/2019

# 1 TABLE OF CONTENTS

1	TABLE OF CONTENTS .....	3
2	GENERAL INFORMATION .....	4
2.1	Administrative details .....	4
2.2	Possible test case verdicts .....	4
2.3	Observations .....	5
2.4	Opinions and interpretations .....	5
2.5	Revision history .....	5
2.6	Further documents .....	5
3	ENVIRONMENTAL & TEST CONDITIONS .....	6
3.1	Environmental conditions .....	6
3.2	Normal and extreme test conditions .....	6
4	TEST STANDARDS AND REFERENCES .....	6
5	EQUIPMENT UNDER TEST (EUT) .....	7
5.1	Product description .....	7
5.2	Description of test item .....	7
5.3	Technical data of test item .....	7
5.4	Additional information .....	7
6	SUMMARY OF TEST RESULTS .....	8
7	TEST RESULTS .....	9
7.1	Field strength of emissions (transmitter spectrum mask) .....	9
7.2	Field strength of emissions (spurious and harmonics) .....	12
7.3	Frequency tolerance .....	17
7.4	20 dB bandwidth / occupied bandwidth .....	23
8	Test Setup Description .....	26
8.1	Semi Anechoic Chamber with Ground Plane .....	27
8.2	Frequency error .....	29
9	Measurement procedures .....	30
9.1	Radiated spurious emissions from 9 kHz to 30 MHz .....	30
9.2	Radiated spurious emissions from 30 MHz to 1 GHz .....	31
10	MEASUREMENT UNCERTAINTIES .....	32
Annex 1	EUT Photographs, external .....	33
Annex 2	Test Setup Photographs .....	36

## 2 GENERAL INFORMATION

### 2.1 Administrative details

Testing laboratory	<b>IBL-Lab GmbH</b> Heinrich-Hertz-Allee 7 66386 Sankt Ingbert / Germany Fon: +49 6894 38938-0 Fax: +49 6894 38938-99 URL: <a href="http://www.ib-lenhardt.de">www.ib-lenhardt.de</a> E-Mail: <a href="mailto:info@ib-lenhardt.de">info@ib-lenhardt.de</a>
Accreditation	<p>The testing laboratory is accredited by Deutsche Akkreditierungsstelle GmbH (DAkKS) in compliance with DIN EN ISO/IEC 17025:2018.</p> <p>Scope of testing and registration number:</p> <ul style="list-style-type: none"> <li>• Attachment to the accreditation certificate <a href="#">D-PL-21375-01-00</a> <ul style="list-style-type: none"> <li>○ Electronics</li> <li>○ Electromagnetic Compatibility</li> <li>○ Radio</li> <li>○ Electromagnetic Compatibility and Telecommunication (FCC requirements)</li> <li>○ Telecommunication (TC) and Electromagnetic Compatibility (EMC) for Canadian Standards</li> <li>○ Automotive EMC</li> </ul> </li> </ul> <p>Website DAkKS: <a href="https://www.dakks.de/">https://www.dakks.de/</a>          The Deutsche Akkreditierungsstelle GmbH (DAkKS) is also a signatory to the <a href="#">ILAC Mutual Recognition Arrangement</a>.</p> <ul style="list-style-type: none"> <li>• Designations             <ul style="list-style-type: none"> <li>○ FCC Testing Laboratory Designation Number DE0024</li> <li>○ ISED ISED Company Number 27156 Testing Laboratory CAB Identifier DE0020</li> <li>○ Kraftfahrt-Bundesamt KBA-P 00120-23</li> </ul> </li> </ul>
Testing location	<b>IBL-Lab GmbH</b> Heinrich-Hertz-Allee 7 66386 St. Ingbert / Germany
Date of receipt of test samples	2023-03-15
Start – End of tests	2023-03-15 – 2023-03-22

### 2.2 Possible test case verdicts

Test sample meets the requirements	P (PASS)
Test sample does not meet the requirements	F (FAIL)
Test case does not apply to the test sample	N/A (Not applicable)
Test case not performed	N/P (Not performed)

### 2.3 Observations

No additional observations other than the reported observations within this test report have been made.

### 2.4 Opinions and interpretations

No appropriate opinions or interpretations according ISO/IEC 17025:2017 clause 7.8.7 are within this test report.

### 2.5 Revision history

-0 Initial Version

### 2.6 Further documents

List of further applicable documents belonging to the present test report:  
– no additional documents –

### 3 ENVIRONMENTAL & TEST CONDITIONS

#### 3.1 Environmental conditions

Temperature	20°C ± 5°C
Relative humidity	25-75 % r.H.
Barometric Pressure	860-1060 mbar
Power supply	230 V / 50 Hz

#### 3.2 Normal and extreme test conditions

	minimum	normal	maximum
Temperature	-40 °C	20 °C	+85 °C
Relative humidity	-/-	45 % r.h.	-/-
Power supply	9 V DC	12.0 V DC	16.0 V DC

### 4 TEST STANDARDS AND REFERENCES

Test standard (accredited)	Description
FCC 47 CFR Part 15	Radio Frequency Devices (Subpart C)
RSS-210, Issue 10 (2019-12)	Digital Transmission Systems (DTSs), Frequency Hopping Systems (FHSs) and Licence-Exempt Local Area Network (LE-LAN) Devices
RSS-Gen, Issue 5 (2018-04)	General Requirements for Compliance of Radio Apparatus

Reference	Description
ANSI C63.4-2014	American National Standard for Methods of Measurement of Radio-Noise Emissions from Low-Voltage Electrical and Electronic Equipment in the Range of 9 kHz to 40 GHz
ANSI C63.10-2013	American National Standard of Procedures for Compliance Testing of Unlicensed Wireless Devices

## 5 EQUIPMENT UNDER TEST (EUT)

### 5.1 Product description

Door handle with capacitive sensors for Lock and Unlock function and NFC interface.

\*: as declared by applicant

### 5.2 Description of test item

<b>Model name*</b>	MINI_TAGE
<b>Serial number*</b>	N/A
<b>Hardware status*</b>	Left handle: 04.00
<b>Software status*</b>	Left handle: NFC V03.00

\*: as declared by applicant

### 5.3 Technical data of test item

<b>Operational frequency*</b>	13.56 MHz
<b>Operational frequency band*</b>	11.81 MHz – 15.31 MHz
<b>Type of radio transmission*</b>	CW carrier & modulated carrier
<b>Modulation type*</b>	OOK (NFC-A Frames according to ISO 14443-A)
<b>Number of channels*</b>	1
<b>Channel bandwidth*</b>	-/-
<b>Channel spacing*</b>	-/-
<b>Antenna*</b>	Integrated PCB antenna
<b>Power supply*</b>	9 – 16 V DC
<b>Temperature range*</b>	-40 °C – +85 °C

\*: as declared by applicant

### 5.4 Additional information

<b>EUT Variations</b>	none
<b>Ancillaries tested with</b>	none
<b>Additional equipment used for testing</b>	none

## 6 SUMMARY OF TEST RESULTS

### Test specification

FCC 47 CFR Part 15 / RSS-210, Issue 10 (2019-12) / RSS-Gen, Issue 5 (2018-04)

Clause	Requirement / Test case	Test Conditions	Result / Remark	Verdict
§15.225 (a) – (c) RSS-210, B.6 a	Field strength of emissions (transmitter spectrum mask)	Normal	None	- PASS -
§15.225(d) / §15.209(a) // RSS-210, B.6 a RSS-Gen	Field strength of emissions (spurious & harmonics)	Normal	None	- PASS -
§15.225(e) RSS-210, B.6 b	Frequency tolerance	Extreme	None	- PASS -
§15.215(c)	20 dB bandwidth	Normal	None	- PASS -
RSS-Gen, 6.7	Occupied bandwidth	Normal	None	- PASS -

### Notes

– none –

### Comments and observations

– none –



## 7 TEST RESULTS

### 7.1 Field strength of emissions (transmitter spectrum mask)

#### Description / Limits

§15.225

(a) The field strength of any emissions within the band 13.553-13.567 MHz shall not exceed 15848 microvolts/meter at 30 meters (84 dB $\mu$ V/m).

(b) Within the bands 13.410-13.553 MHz and 13.567-13.710 MHz, the field strength of any emissions shall not exceed 334 microvolts/meter at 30 meters (50.5 dB $\mu$ V/m).

(c) Within the bands 13.110-13.410 MHz and 13.710-14.010 MHz the field strength of any emissions shall not exceed 106 microvolts/meter at 30 meters (40.5 dBV/m).

#### Test procedure

§15.31 (m) Measurements on intentional radiators or receivers, other than TV broadcast receivers, shall be performed and, if required, reported for each band in which the device can be operated with the device operating at the number of frequencies in each band specified in the following table:

Frequency range	Number of frequencies	Location
< 1MHz bandwidth	1	middle
1 – 10 MHz bandwidth	2	1 near bottom and 1 near top
> 10 MHz bandwidth	3	1 near bottom / middle / top

§15.35 (a) On any frequency or frequencies below or equal to 1000 MHz, the limits shown are based on measuring equipment employing a CISPR quasi-peak detector function and related measurement bandwidths, unless otherwise specified. The specifications for the measuring instrumentation using the CISPR quasi-peak detector can be found in ANSI C63.4-2014, clause 4 (incorporated by reference, see §15.38). As an alternative to CISPR quasi-peak measurements, the responsible party, at its option, may demonstrate compliance with the emission limits using measuring equipment employing a peak detector function as long as the same bandwidth as indicated for CISPR quasi-peak measurements are employed.

**Test setup:** see 8.1

#### Test results

EUT	Frequency [MHz]	Detector	Test distance [m]	Level [dB $\mu$ V/m]	Limit [dB $\mu$ V/m]	Margin [dB]
Left handle	13.56	QP	3	64.55	105.4	40.85

#### Note:

Testing was performed at a test distance of 3 m, limit is corrected for a test distance of 3 m according to ANSI C63.10, chapter 7.7.2.

Plot no. 1: Transmitter Spectrum Mask (TSM), Left handle, lying

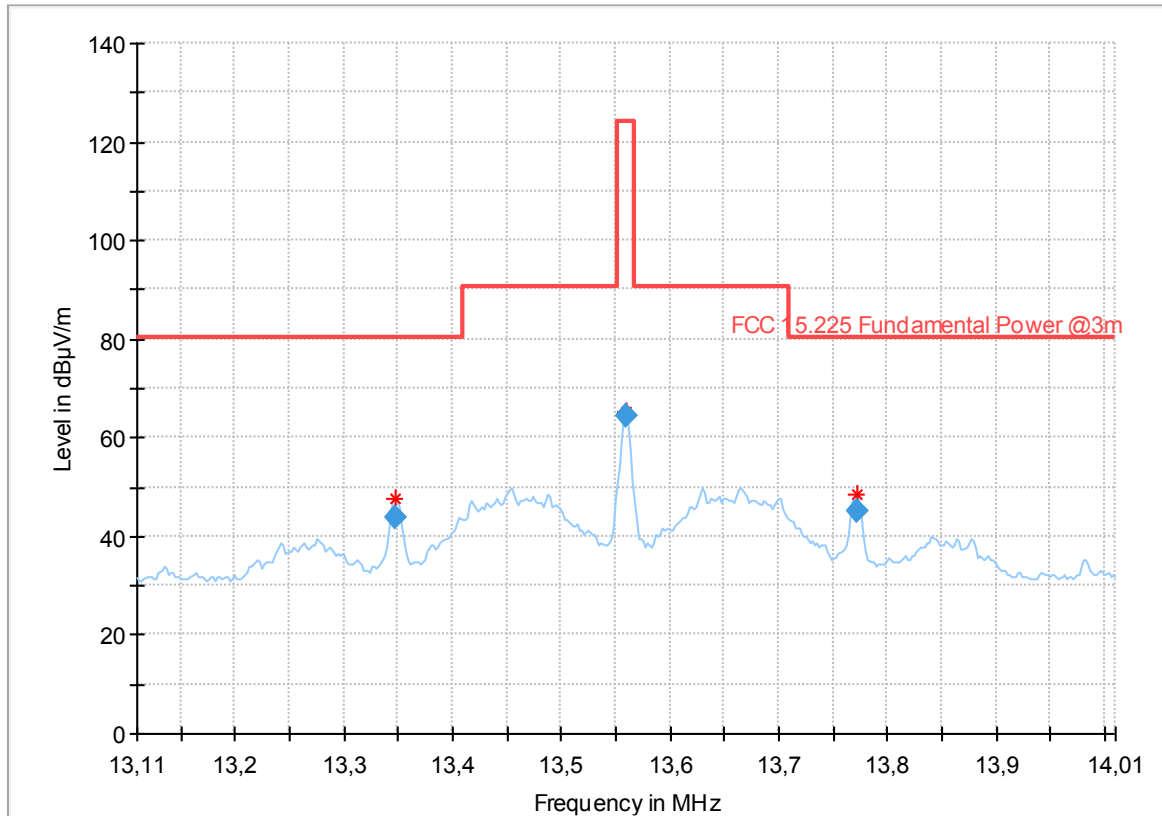

— Preview Result 1-PK+      \* Critical\_Freqs PK+  
— FCC 15.225 Fundamental Power @3m      ◆ Final\_Result QPK

### Final Result

Frequency (MHz)	QuasiPeak (dBµV/m)	Limit (dBµV/m)	Margin (dB)	Meas. Time (ms)	Bandwidth (kHz)	Pol	Azimuth (deg)	Corr. (dB/m)
13.348500	43.82	80.51	36.69	100.0	9.000	V	195.0	20.5
13.560000	64.55	124.00	59.45	100.0	9.000	V	172.0	20.5
13.771500	44.96	80.51	35.55	100.0	9.000	V	172.0	20.5

(continuation of the "Final\_Result" table from column 15 ...)

Frequency (MHz)	Comment
13.348500	11:53:02 - 16.03.2023
13.560000	11:54:55 - 16.03.2023
13.771500	11:56:47 - 16.03.2023

Plot no. 2: Transmitter Spectrum Mask (TSM), Left handle, staying

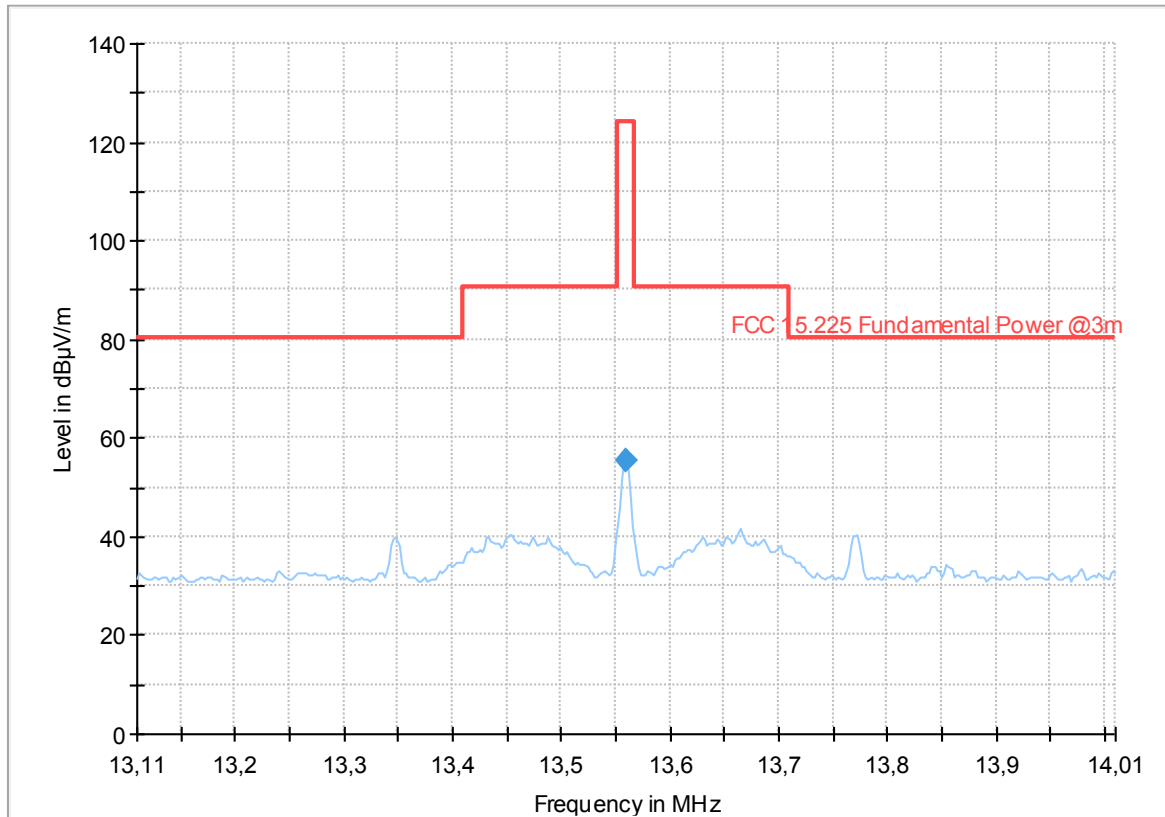

— Preview Result 1-PK+      \* Critical\_Freqs PK+  
— FCC 15.225 Fundamental Power @3m      ◆ Final\_Result QPK

## Final\_Result

Frequency (MHz)	QuasiPeak (dBµV/m)	Limit (dBµV/m)	Margin (dB)	Meas. Time (ms)	Bandwidth (kHz)	Pol	Azimuth (deg)	Corr. (dB/m)
13.560000	55.42	124.00	68.58	100.0	9.000	H	214.0	20.5

(continuation of the "Final\_Result" table from column 15 ...)

Frequency (MHz)	Comment
13.560000	12:11:37 - 16.03.2023

7.2 Field strength of emissions (spurious and harmonics)					
<b>Description / Limits</b>					
§15.225 (d) The field strength of any emissions appearing outside of the 13.110-14.010 MHz band shall not exceed the general radiated emission limits in §15.209:					
Frequency	Field Strength		Measurement distance		
0.009 – 0.490 MHz	2400/F[kHz] $\mu\text{V/m}$		300 m		
0.490 – 1.705 MHz	24000/F[kHz] $\mu\text{V/m}$		30 m		
1.705 – 30.0 MHz	30.0 $\mu\text{V/m}$ / 29.5 dB $\mu\text{V/m}$		30 m		
30 – 88 MHz	100 $\mu\text{V/m}$ / 40.0 dB $\mu\text{V/m}$		3 m		
88 – 216 MHz	150 $\mu\text{V/m}$ / 43.5 dB $\mu\text{V/m}$		3 m		
216 – 960 MHz	200 $\mu\text{V/m}$ / 46.0 dB $\mu\text{V/m}$		3 m		
960 – 100 000 MHz	500 $\mu\text{V/m}$ / 54.0 dB $\mu\text{V/m}$		3 m		
<b>Test procedure</b>					
§15.31 (m) Measurements on intentional radiators or receivers, other than TV broadcast receivers, shall be performed and, if required, reported for each band in which the device can be operated with the device operating at the number of frequencies in each band specified in the following table:					
Frequency range	Number of frequencies		Location		
< 1MHz bandwidth	1		middle		
1 – 10 MHz bandwidth	2		1 near bottom and 1 near top		
> 10 MHz bandwidth	3		1 near bottom / middle / top		
§15.35 (a) On any frequency or frequencies below or equal to 1000 MHz, the limits shown are based on measuring equipment employing a CISPR quasi-peak detector function and related measurement bandwidths, unless otherwise specified. The specifications for the measuring instrumentation using the CISPR quasi-peak detector can be found in ANSI C63.4-2014, clause 4 (incorporated by reference, see §15.38). As an alternative to CISPR quasi-peak measurements, the responsible party, at its option, may demonstrate compliance with the emission limits using measuring equipment employing a peak detector function as long at the same bandwidth as indicated for CISPR quasi-peak measurements are employed.					
<b>Test setup:</b> see 8.1					
<b>Test results</b>					
Channel frequency (MHz)	Frequency [MHz]	Detector	Level [dB $\mu\text{V/m}$ ]	Limit [dB $\mu\text{V/m}$ ]	Verdict
13.56	see next plots	QP	see next plots	see next plots	passed

Plot no. 3: Radiated emissions 9 kHz – 30 MHz, Left handle, lying

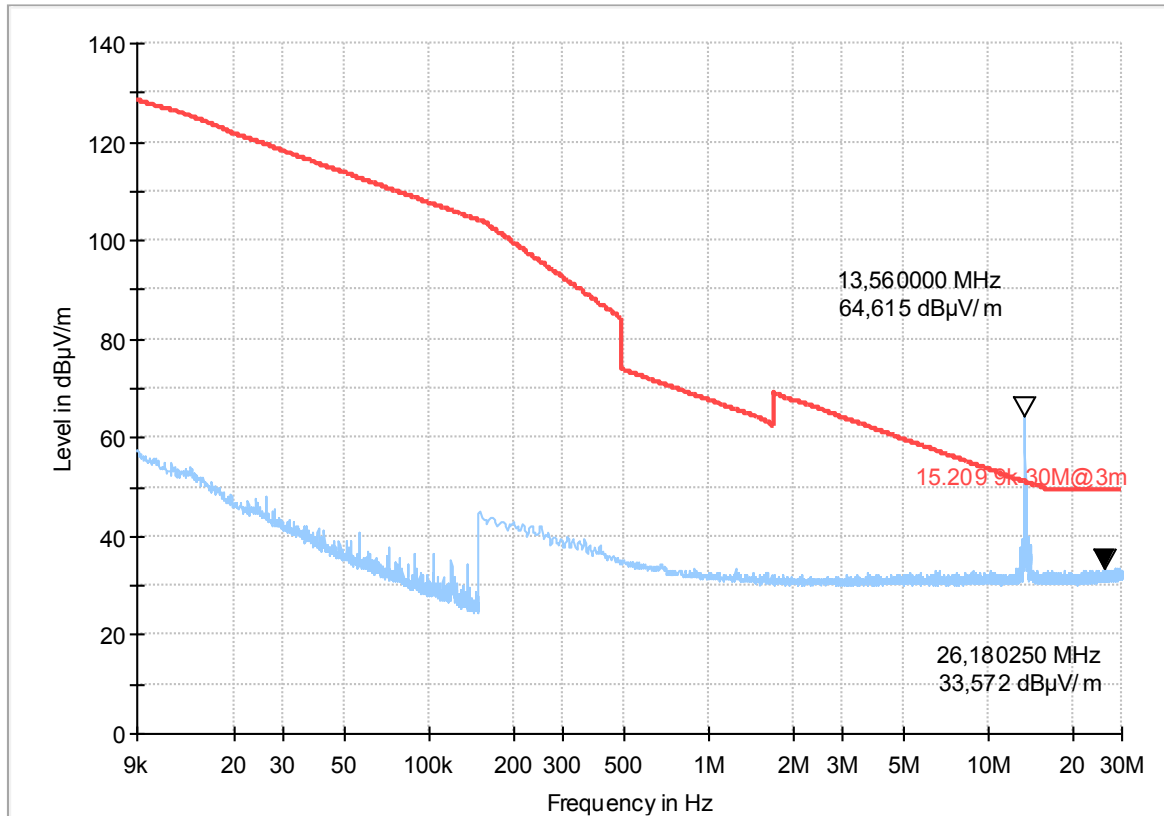

- Preview Result 1-PK+
- 15.209 9k-30M@3m
- \* Critical\_Freqs PK+
- ◆ Final\_Result QPK

**Note:**

Please see previous plot for transmitter spectrum mask (TSM)!

Plot no. 4: Radiated emissions 9 kHz – 30 MHz, Left handle, staying

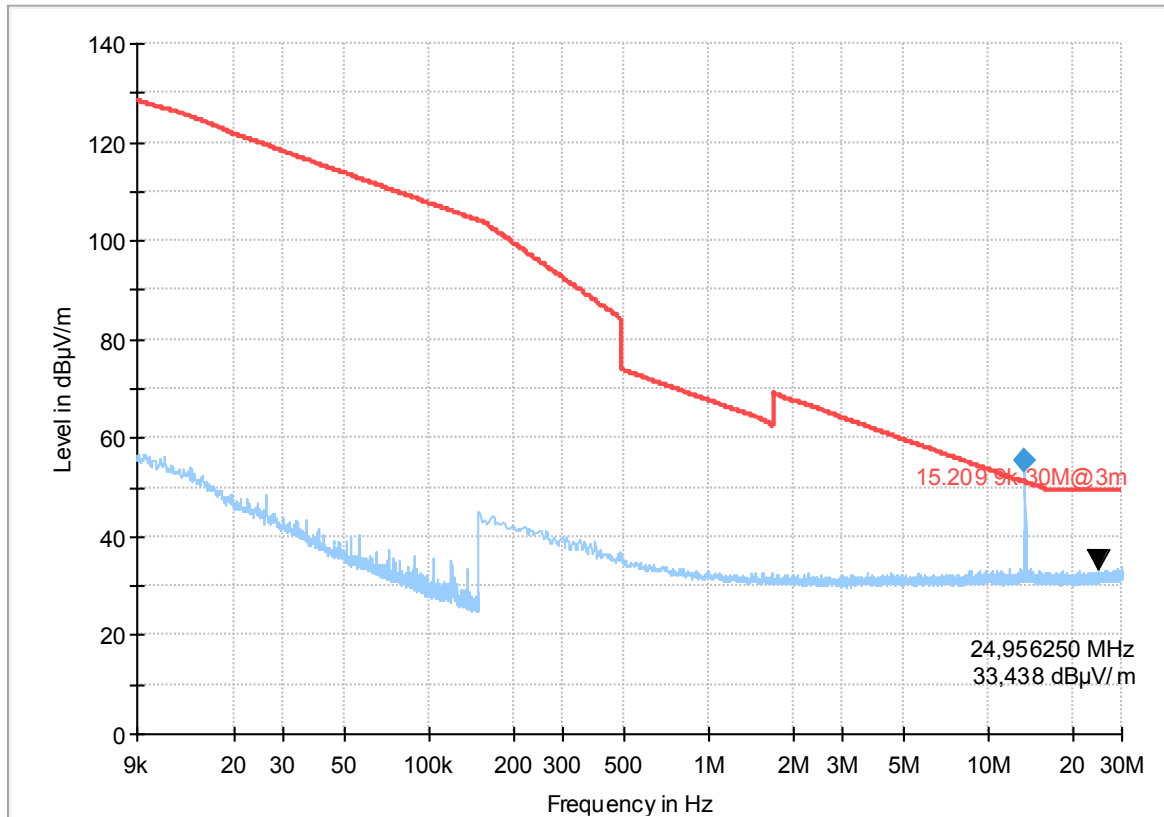

## Final Result

Frequency (MHz)	QuasiPeak (dBµV/m)	Limit (dBµV/m)	Margin (dB)	Meas. Time (ms)	Bandwidth (kHz)	Pol	Azimuth (deg)	Corr. (dB/m)
13.560000	55.35	50.94	-4.41	100.0	9.000	H	215.0	20.5

(continuation of the "Final\_Result" table from column 15 ...)

Frequency (MHz)	Comment
13.560000	12:25:08 - 16.03.2023

### Note:

Please see previous plot for transmitter spectrum mask (TSM)!

Plot no. 5: Radiated emissions 30 MHz – 1 GHz, hor./vert. polarization, Left handle, lying

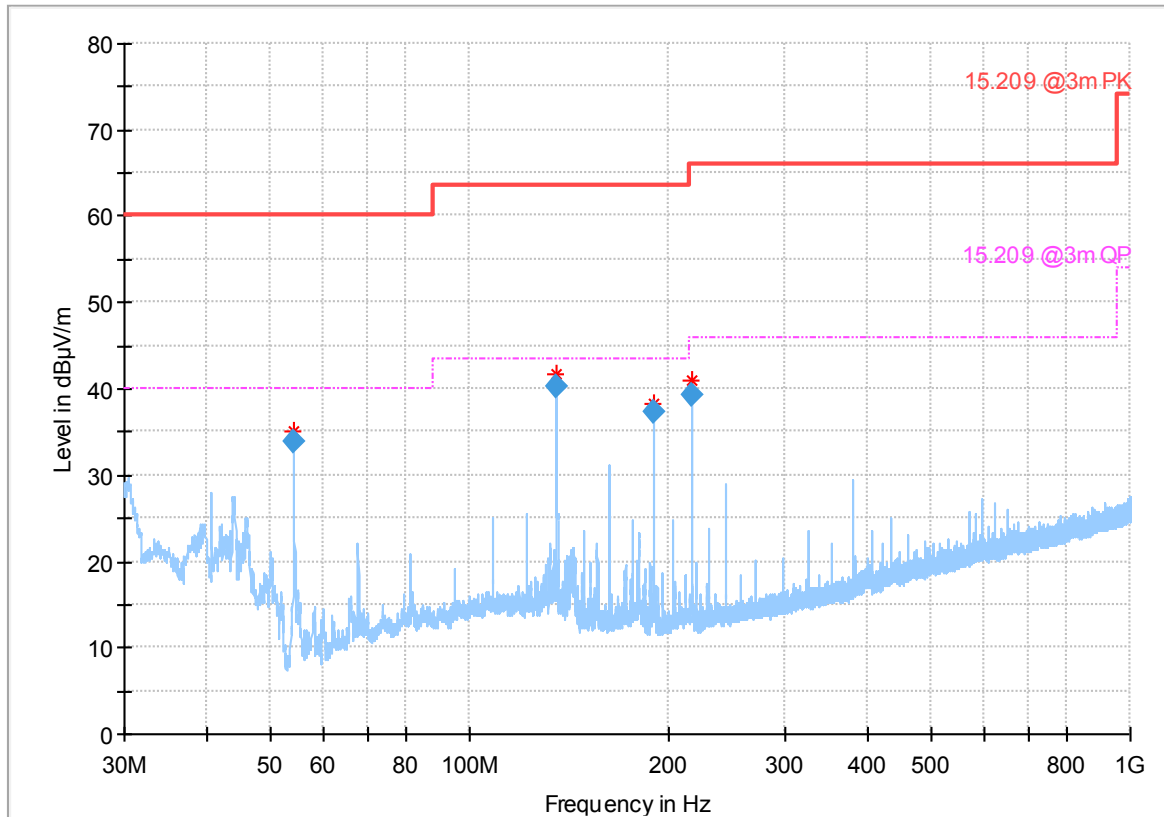

— Preview Result 1-PK+      \* Critical\_Freqs PK+      — 15.209 @3m PK  
- - - 15.209 @3m QP      ◆ Final\_Result QPK

### Final Result

Frequency (MHz)	QuasiPeak (dBµV/m)	Limit (dBµV/m)	Margin (dB)	Meas. Time (ms)	Bandwidth (kHz)	Height (cm)	Pol	Azimuth (deg)
54.225000	33.83	40	6.17	100.0	120.000	103.0	V	214.0
135.600000	40.30	43.5	3.2	100.0	120.000	170.0	H	151.0
189.825000	37.19	43.5	6.31	100.0	120.000	100.0	V	-6.0
216.950000	39.38	46	6.62	100.0	120.000	100.0	V	324.0

(continuation of the "Final\_Result" table from column 15 ...)

Frequency (MHz)	Corr. (dB/m)	Comment
54.225000	6.3	12:59:23 - 16.03.2023
135.600000	11.4	12:54:44 - 16.03.2023
189.825000	10.1	12:57:09 - 16.03.2023
216.950000	10.9	13:01:33 - 16.03.2023

Plot no. 6: Radiated emissions 30 MHz – 1 GHz, hor./vert. polarization, Left handle, staying

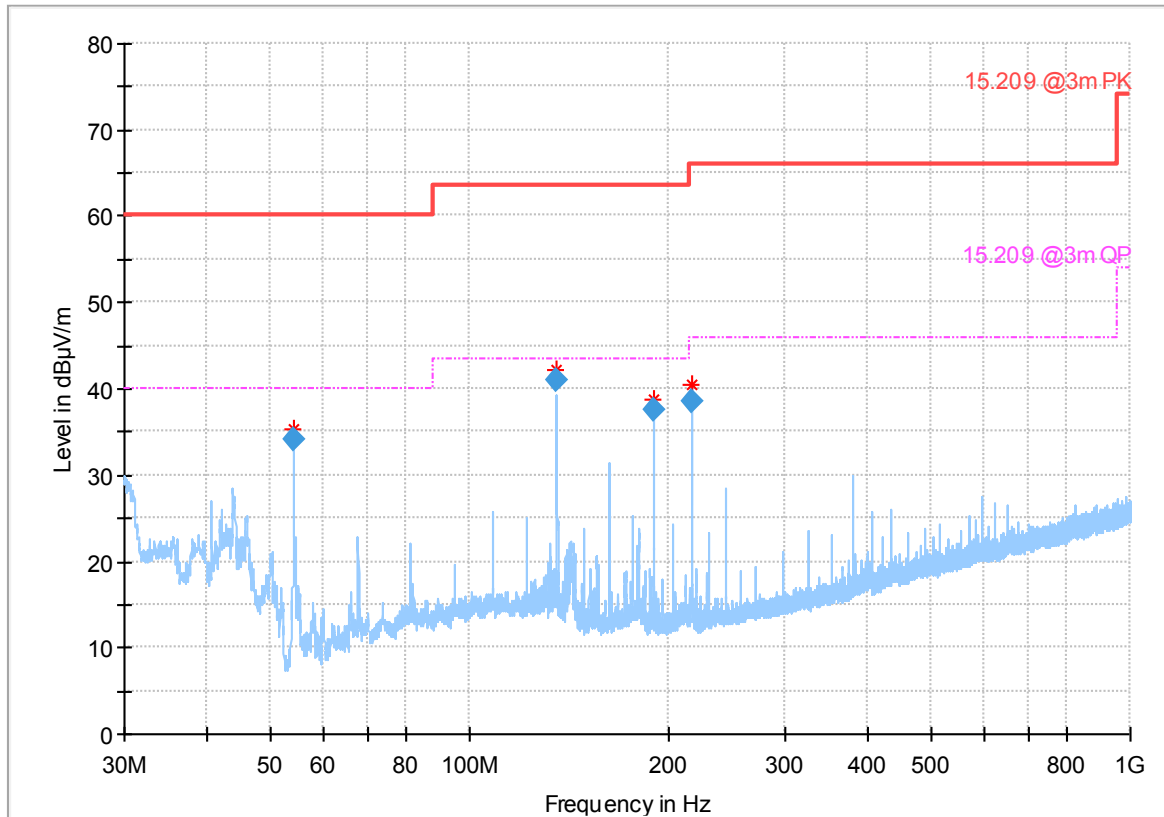

— Preview Result 1-PK+      \* Critical\_Freqs PK+      — 15.209 @3m PK  
- - - 15.209 @3m QP      ◆ Final\_Result QPK

### Final Result

Frequency (MHz)	QuasiPeak (dBµV/m)	Limit (dBµV/m)	Margin (dB)	Meas. Time (ms)	Bandwidth (kHz)	Height (cm)	Pol	Azimuth (deg)
54.225000	40	5.86	25.86	100.0	120.000	104.0	V	202.0
135.600000	43.5	2.62	22.62	100.0	120.000	170.0	H	147.0
189.825000	43.5	5.94	25.94	100.0	120.000	100.0	V	-10.0
216.950000	46	7.42	27.42	100.0	120.000	104.0	V	331.0

(continuation of the "Final\_Result" table from column 15 ...)

Frequency (MHz)	Corr. (dB/m)	Comment
54.225000	6.3	13:21:27 - 16.03.2023
135.600000	11.4	13:16:44 - 16.03.2023
189.825000	10.1	13:19:09 - 16.03.2023
216.950000	10.9	13:23:38 - 16.03.2023



### 7.3 Frequency tolerance

#### Description / Limits

§15.225 (e) The frequency tolerance of the carrier signal shall be maintained within  $\pm 0.01\%$  of the operating frequency over a temperature variation of  $-20$  degrees to  $+ 50$  degrees C at normal supply voltage, and for a variation in the primary supply voltage from 85% to 115% of the rated supply voltage at a temperature of 20 degrees C. For battery operated equipment, the equipment tests shall be performed using a new battery.

Test setup: see 8.2

#### Test results

EUT	Test conditions, [temperature]	Test conditions, [voltage]	Declared frequency [MHz]	Measured frequency [MHz]	Deviation [%]	Deviation [ppm]
Left handle	-40 °C	Vnom	13.56	13.56	0	0
	-40 °C	Vmin	13.56	13.56	0	0
	-40 °C	Vmax	13.56	13.56	0	0
	+20 °C	Vnom	13.559	13.559	0.007375	-73.75
	+20 °C	Vmin	13.559	13.559	0.007375	-73.75
	+20 °C	Vmax	13.559	13.559	0.007375	-73.75
	+85 °C	Vnom	13.559	13.559	0.007375	-73.75
	+85 °C	Vmin	13.559	13.559	0.007375	-73.75
	+85 °C	Vmax	13.559	13.559	0.007375	-73.75

Pass.

Plot no. 7: Frequency tolerance @ -40 °C, Left handle, Vnom

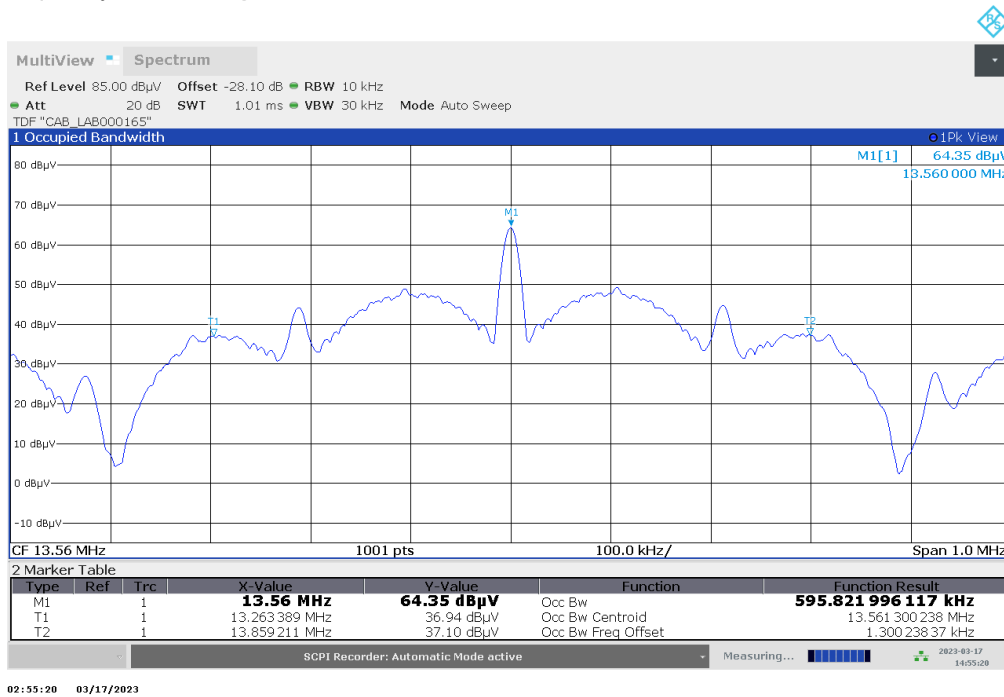

Plot no. 8: Frequency tolerance @ -40 °C, Left handle, Vmin

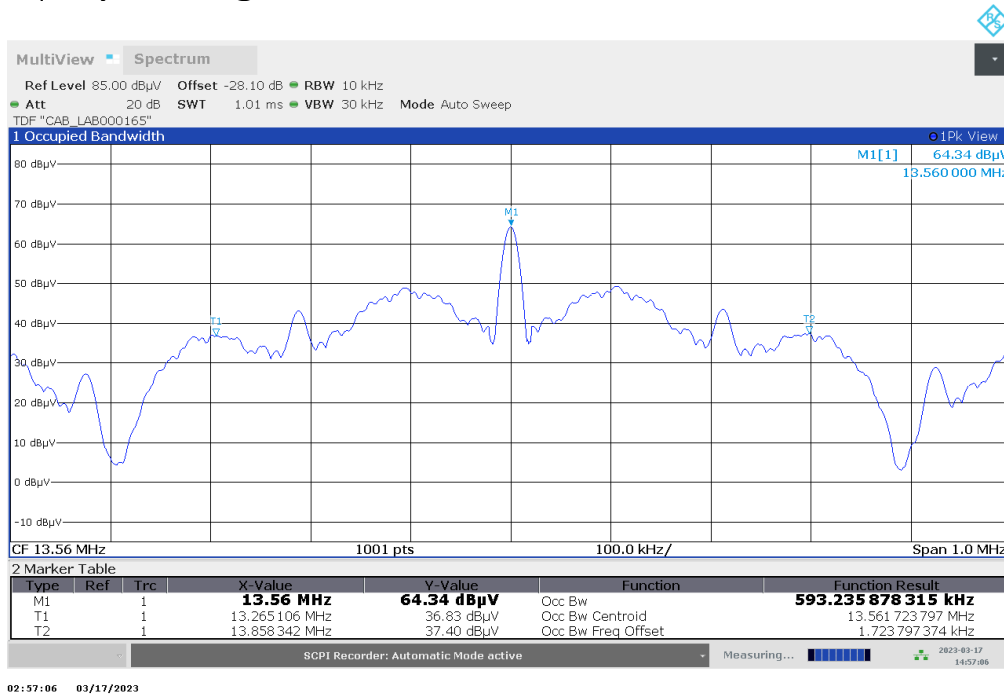

TR no.: 21045477-21304-0

2023-03-22

Plot no. 9: Frequency tolerance @ -40 °C, Left handle, Vmax

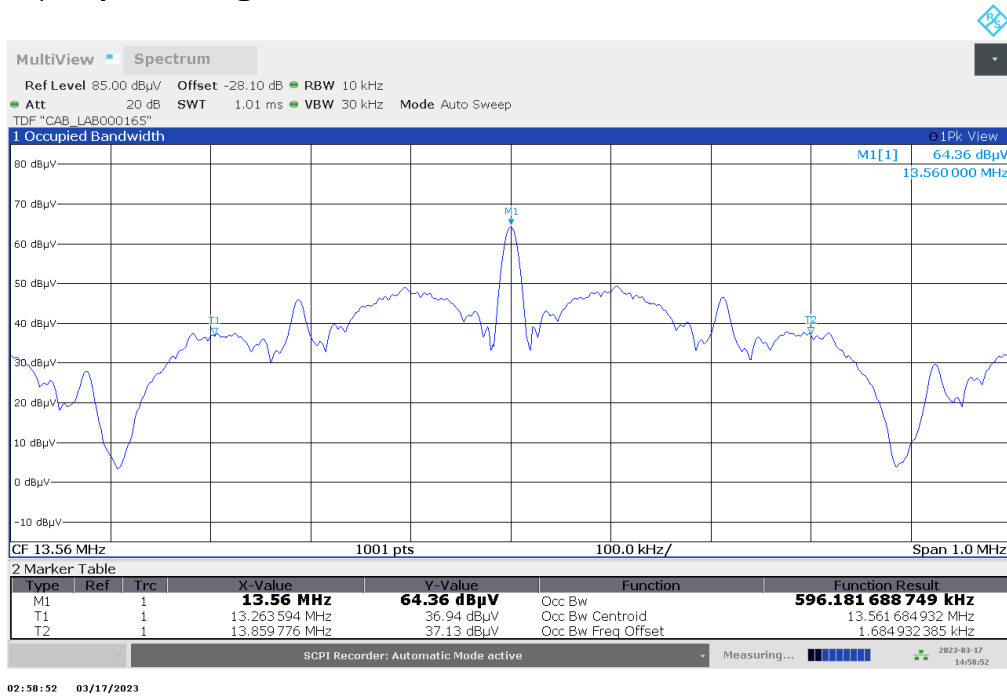

Plot no. 10: Frequency tolerance @ +20 °C, Left handle, Vnom

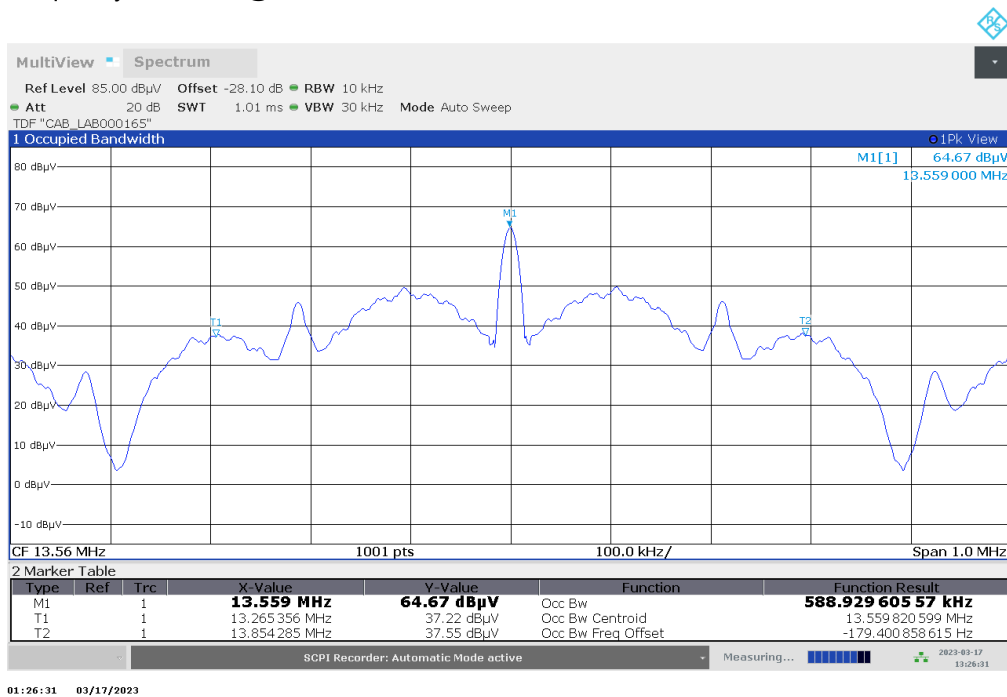

Plot no. 11: Frequency tolerance @ +20 °C, Left handle, Vmin

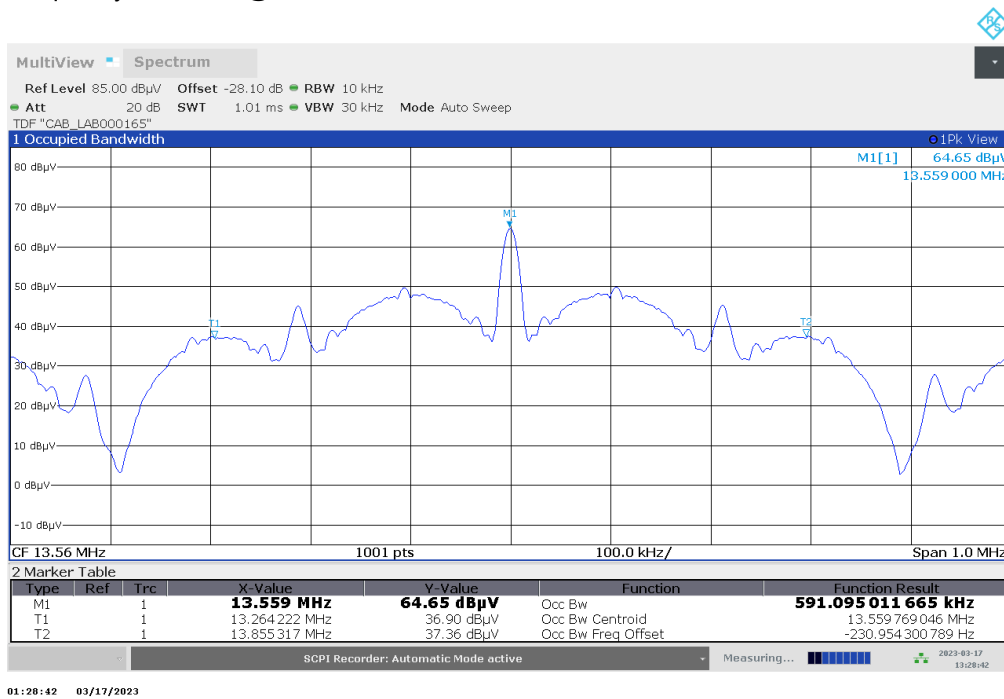

Plot no. 12: Frequency tolerance @ +20 °C, Left handle, Vmax

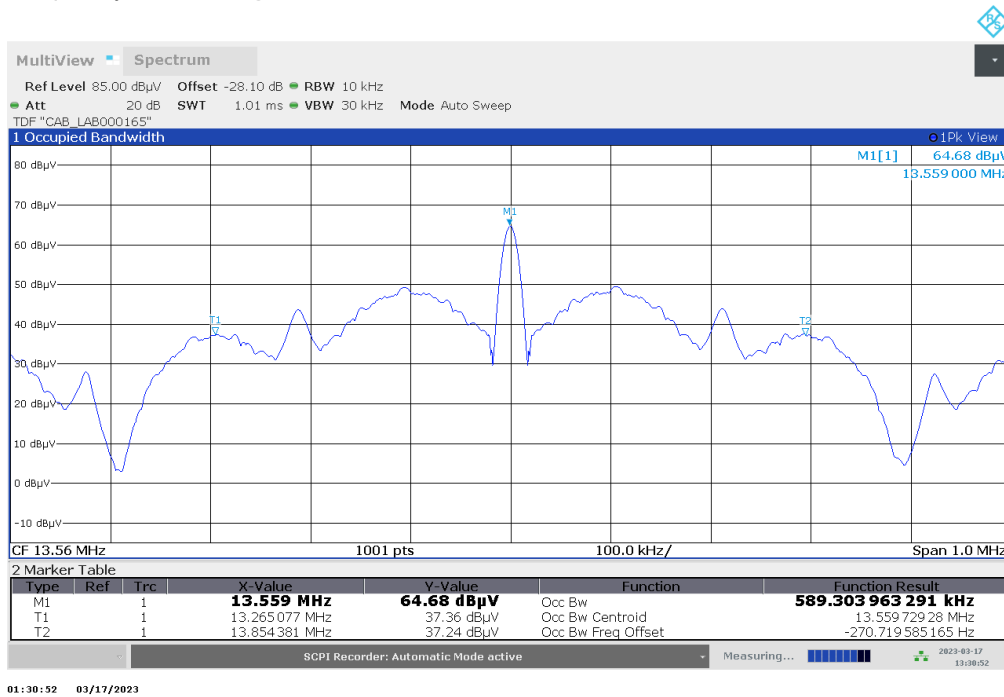

TR no.: 21045477-21304-0

2023-03-22

Plot no. 13: Frequency tolerance @ +85 °C, Left handle, Vnom

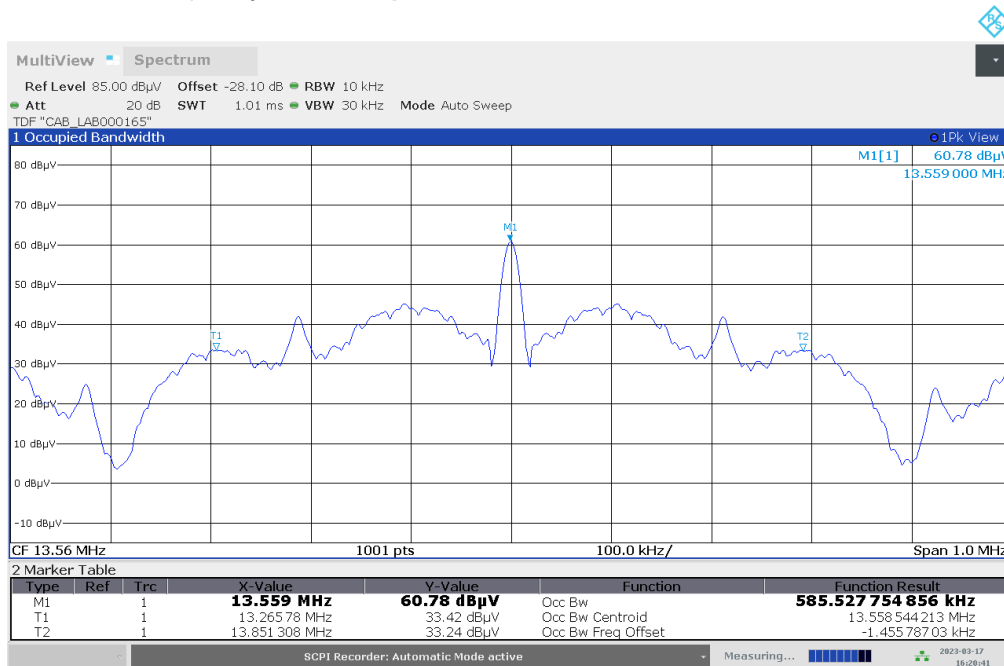

04:20:41 03/17/2023

Plot no. 14: Frequency tolerance @ +85 °C, Left handle, Vmin

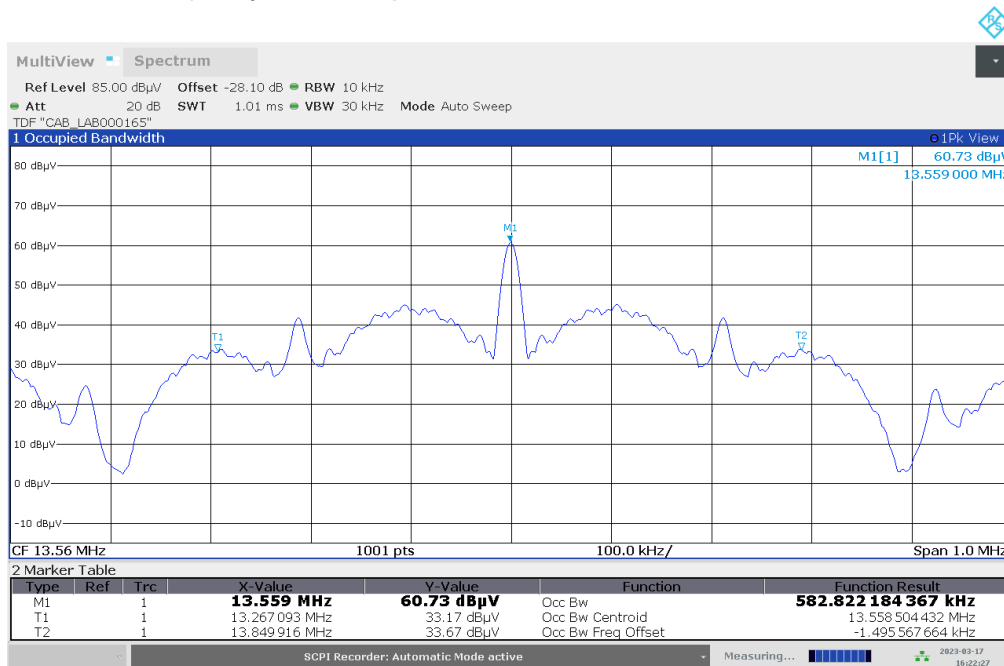

04:22:27 03/17/2023

Plot no. 15: Frequency tolerance @ +85 °C, Left handle, Vmax

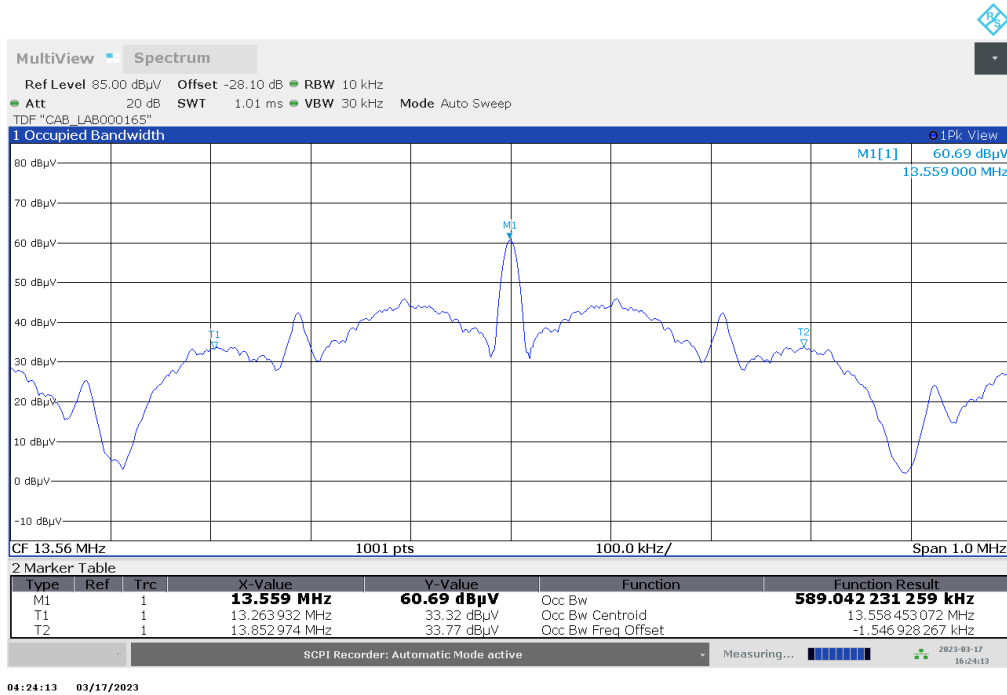

## 7.4 20 dB bandwidth / occupied bandwidth

### Description

The occupied bandwidth or the “99% emission bandwidth” is defined as the frequency range between two points, one above and the other below the carrier frequency, within which 99% of the total transmitted power of the fundamental transmitted emission is contained. The occupied bandwidth shall be reported for all equipment in addition to the specified bandwidth required in the applicable RSSs.

In some cases, the “x dB bandwidth” is required, which is defined as the frequency range between two points, one at the lowest frequency below and one at the highest frequency above the carrier frequency, at which the maximum power level of the transmitted emission is attenuated x dB below the maximum in-band power level of the modulated signal, where the two points are on the outskirts of the in-band emission.

The following conditions shall be observed for measuring the occupied bandwidth and x dB bandwidth:

- The transmitter shall be operated at its maximum carrier power measured under normal test conditions.
- The span of the spectrum analyzer shall be set large enough to capture all products of the modulation process, including the emission skirts, around the carrier frequency, but small enough to avoid having other emissions (e.g. on adjacent channels) within the span.
- The detector of the spectrum analyzer shall be set to “Sample”. However, a peak, or peak hold, may be used in place of the sampling detector since this usually produces a wider bandwidth than the actual bandwidth (worst-case measurement). Use of a peak hold (or “Max Hold”) may be necessary to determine the occupied / x dB bandwidth if the device is not transmitting continuously.
- The resolution bandwidth (RBW) shall be in the range of 1% to 5% of the actual occupied / x dB bandwidth and the video bandwidth (VBW) shall not be smaller than three times the RBW value. Video averaging is not permitted.

**Note:** It may be necessary to repeat the measurement a few times until the RBW and VBW are in compliance with the above requirement.

For the 99% emission bandwidth, the trace data points are recovered and directly summed in linear power level terms. The recovered amplitude data points, beginning at the lowest frequency, are placed in a running sum until 0.5% of the total is reached, and that frequency recorded. The process is repeated for the highest frequency data points (starting at the highest frequency, at the right side of the span, and going down in frequency). This frequency is then recorded. The difference between the two recorded frequencies is the occupied bandwidth (or the 99% emission bandwidth).

### Test procedure

ANSI C63.10, 6.9.3

The occupied bandwidth is the frequency bandwidth such that, below its lower and above its upper frequency limits, the mean powers are each equal to 0.5% of the total mean power of the given emission.

The following procedure shall be used for measuring 99% power bandwidth:

- a) The instrument center frequency is set to the nominal EUT channel center frequency. The frequency span for the spectrum analyzer shall be between 1.5 times and 5.0 times the OBW.
- b) The nominal IF filter bandwidth (3 dB RBW) shall be in the range of 1% to 5% of the OBW, and VBW shall be approximately three times the RBW, unless otherwise specified by the applicable requirement.
- c) Set the reference level of the instrument as required, keeping the signal from exceeding the maximum input mixer level for linear operation. In general, the peak of the spectral envelope shall be more than  $[10 \log(\text{OBW}/\text{RBW})]$  below the reference level. Specific guidance is given in 4.1.5.2.
- d) Step a) through step c) might require iteration to adjust within the specified range.
- e) Video averaging is not permitted. Where practical, a sample detection and single sweep mode shall be used. Otherwise, peak detection and max hold mode (until the trace stabilizes) shall be used.
- f) Use the 99% power bandwidth function of the instrument (if available) and report the measured bandwidth.
- g) If the instrument does not have a 99% power bandwidth function, then the trace data points are recovered and directly summed in linear power terms. The recovered amplitude data points, beginning at the lowest frequency, are placed in a running sum until 0.5% of the total is reached; that frequency is recorded as the lower frequency. The process is repeated until 99.5% of the total is reached; that frequency is recorded as the upper frequency. The 99% power bandwidth is the difference between these two frequencies.
- h) The occupied bandwidth shall be reported by providing plot(s) of the measuring instrument display; the plot axes and the scale units per division shall be clearly labeled. Tabular data may be reported in addition to the plot(s).

**Note**  
 Measurements with the peak detector are also suitable to demonstrate compliance of an EUT, as long as the required resolution bandwidth is used, because peak detection will yield amplitudes equal to or greater than amplitudes measured with RMS detector. The measurement data from a spectrum analyser peak detector will represent the worst-case results (see ANSI C63.10).

**Test Parameters:**

Detector	Pos-Peak (worst-case)		
Trace-mode	Max Hold		
Resolution bandwidth RBW	10 kHz		
Video bandwidth	≥ RBW		
Span	see plots		
Sweep time	see plots		
Measurement uncertainty	±1 x 10 <sup>-7</sup>		
Test environment	Normal		
Test set-up	<input type="checkbox"/> Conducted	<input type="checkbox"/> Radiated	<input checked="" type="checkbox"/> Test Fixture

**Test Results:**

EUT	Channel frequency (MHz)	Min. Frequency F <sub>L</sub> [MHz]	Max. frequency F <sub>H</sub> [MHz]	20 dB bandwidth [kHz]
Left handle	13.56	13.343	13.776	433

EUT	Channel frequency (MHz)	Min. Frequency F <sub>L</sub> [MHz]	Max. frequency F <sub>H</sub> [MHz]	Occupied bandwidth (99%) [kHz]
Left handle	13.56	13.2641064717	13.8554873285	591.381

Where: F<sub>L</sub> = is the lower edge of the OBW  
 F<sub>H</sub> = is the upper edge of the OBW

<b>Verdict</b>	<b>- PASS -</b>	<i>Measurement plot(s) see next page(s).</i>
----------------	-----------------	--

<b>Comment</b>	
----------------	--



Plot No. 16: 99% Occupied bandwidth, Left handle

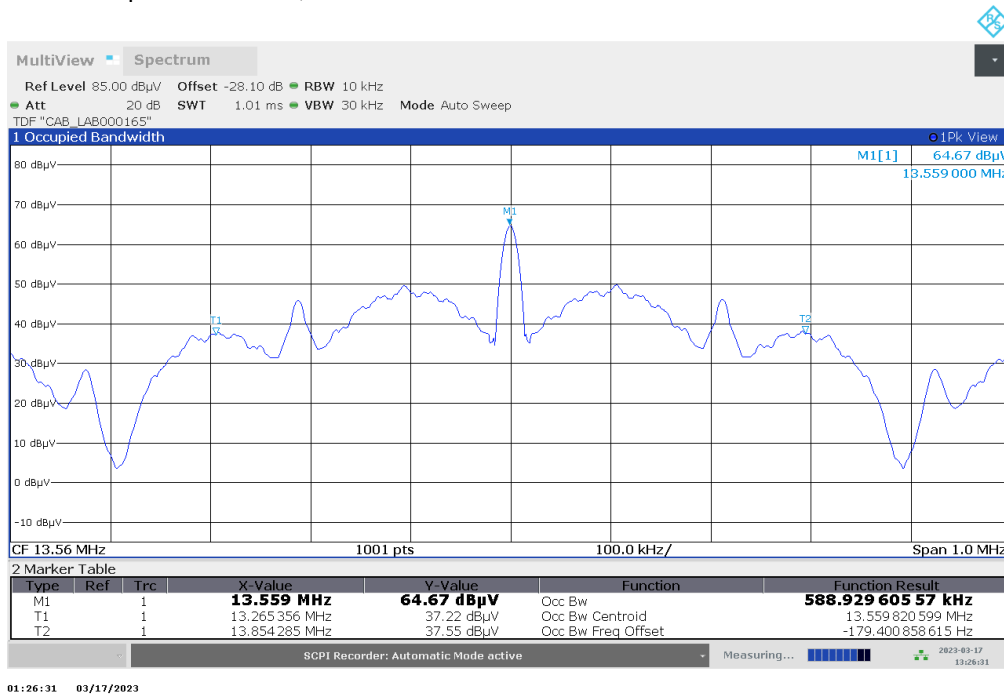

01:26:31 03/17/2023

Plot No. 17: 20 dB bandwidth, Left handle

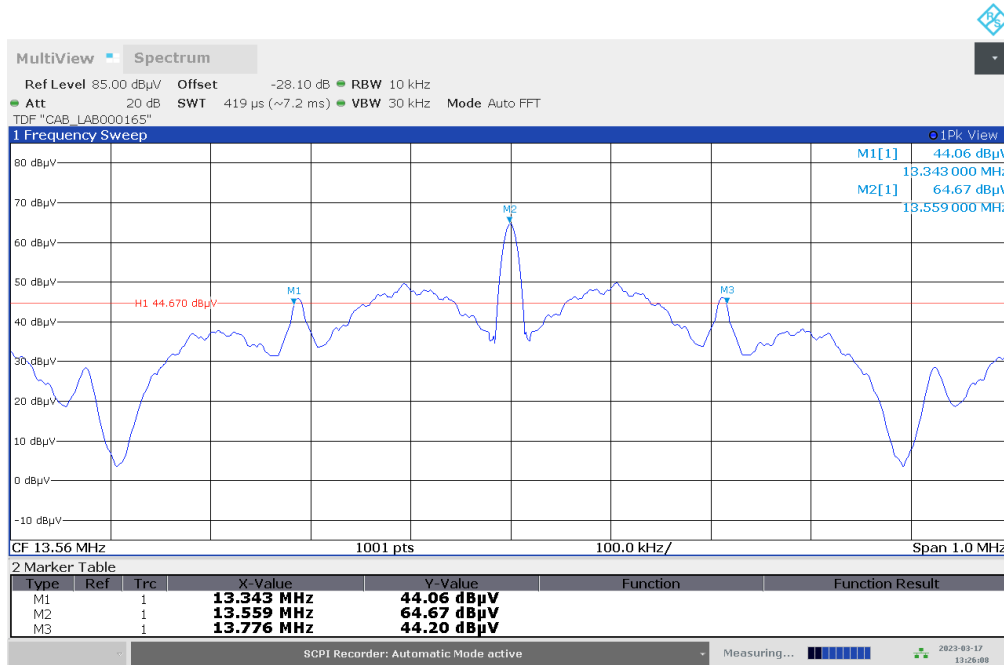

01:26:08 03/17/2023

## 8 Test Setup Description

Typically, the calibrations of the test apparatus are commissioned to and performed by an accredited calibration laboratory. The calibration intervals are determined in accordance with the DIN EN ISO/IEC 17025. In addition to the external calibrations, the laboratory executes comparison measurements with other calibrated test systems or effective verifications. Cyclically chamber inspections and range calibrations are performed. Where possible resp. necessary, RF generating and signalling equipment as well as measuring receivers and analysers are connected to an external high-precision 10 MHz reference (GPS-based frequency standard).

In order to simplify the identification of the equipment used at some special tests, some items of test equipment and ancillaries can be provided with an identifier or number in the equipment list below (Lab/Item).

## 8.1 Semi Anechoic Chamber with Ground Plane

Radiated measurements are performed in vertical and horizontal plane in the frequency range 30 MHz to 1 GHz in a Semi Anechoic Chamber with a metallic ground plane. The EUT is positioned on a non-conductive test table with a height of 0.80 m above the metallic ground plane that covers the whole chamber. The receiving antennas conform to specification ANSI C63.10-2013, American National Standard for Testing Unlicensed Wireless Devices. These antennas can be moved over the height range between 1.0 m and 4.5 m in order to search for maximum field strength emitted from the EUT. The measurement distances between EUT and receiving antennas are indicated in the test setups for the various frequency ranges. For each measurement, the EUT is rotated in all three axes until the maximum field strength is received. The wanted and unwanted emissions are received by a spectrum analyzer where the detector modes and resolution bandwidths over various frequency ranges are set according to requirement ANSI C63.

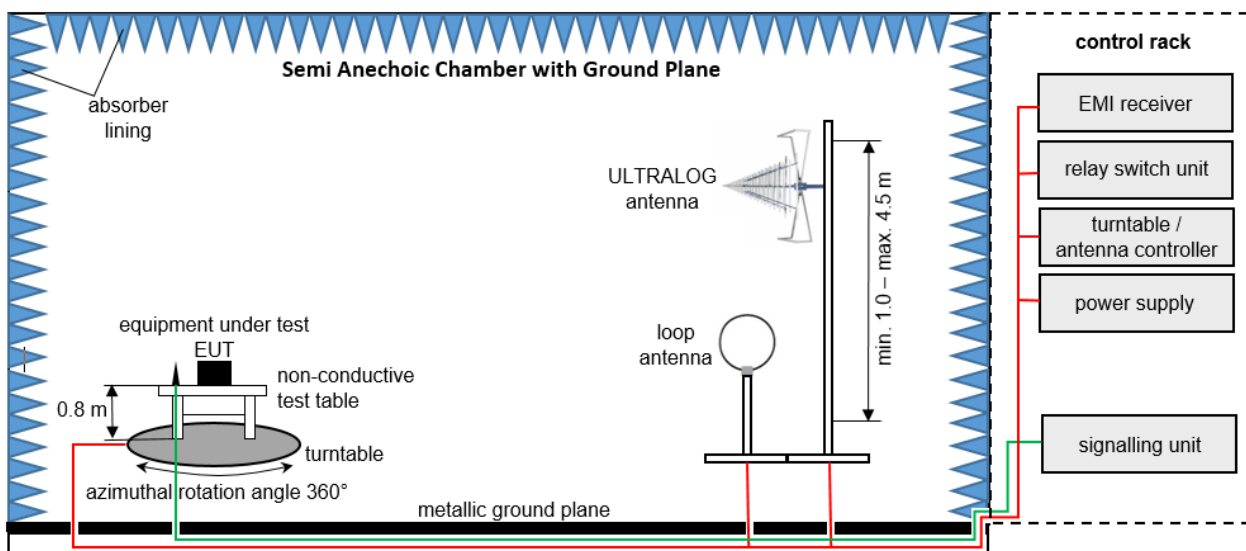

Measurement distance: ULTRALOG antenna 3 m; loop antenna 3 m  
 EMC32 software version: 11.10.00

$$FS = UR + CL + AF$$

(FS-field strength; UR-voltage at the receiver; CL-loss of the cable; AF-antenna factor)

Example calculation:

$$FS [dB\mu V/m] = 12.35 [dB\mu V/m] + 1.90 [dB] + 16.80 [dB/m] = 31.05 [dB\mu V/m] (35.69 \mu V/m)$$

**List of test equipment used:**

No.	Equipment	Manufacturer	Type	Serial No.	IBL No.	Kind of Calibration	Last / Next Calibration
1	Power Supply	Elektro-Automatik GmbH & Co. KG	EA-PSI 9080-40 T	2000230001	LAB000313	NE	–
2	Test table	innco systems GmbH	PT1208-080-RH	-	LAB000306	NE	–
3	Positioner	matur GmbH	TD 1.5-10KG		LAB000258	NE	–
4	Compressed Air	Implotex	1-850-30	-	LAB000256	NE	–
5	EMI Test Receiver	Rohde & Schwarz	ESW26	101481	LAB000236	K	2022-07-07 → 12M → 2023-07-07
6	Semi-Anechoic Chamber (SAC)	Albatross Projects GmbH	SAC 5 (Babylon 5)	20168.PR.B	LAB000235	ZW	2020-07-23 → 36M → 2023-07-23
7	Measurement Software	Rohde & Schwarz	EMC32 V11.00.10		LAB000226	NE	–
8	Turntable	matur GmbH	TT2.0-2t	TT2.0-2t/921	LAB000225	NE	–
9	Antenna Mast	matur GmbH	CAM4.0-P	CAM4.0-P/316	LAB000224	NE	–
10	Antenna Mast	matur GmbH	BAM4.5-P	BAM4.5-P/272	LAB000223	NE	–
11	Controller	matur GmbH	FCU 3.0	10082	LAB000222	NE	–
12	Power Supply	Elektro-Automatik GmbH & Co. KG	PS 2042-10 B	2878350292	LAB000191	NE	–
13	Open Switch and Control Platform	Rohde & Schwarz	OSP200 Base Unit 2HU	101748	LAB000149	ZW	–
14	Antenna	Rohde & Schwarz	HF907	102898	LAB000124	K	2020-04-23 → 36M → 2023-04-23
15	Antenna	Rohde & Schwarz	HL562E	102001	LAB000123	K	2020-07-05 → 36M → 2023-07-05
16	Antenna	Rohde & Schwarz	HFH2-Z2E - Active Loop Antenna	100954	LAB000108	K	2020-03-25 → 36M → 2023-03-25
17	Pre-Amplifier	Schwarzbeck Mess-Elektronik OHG	BBV 9718 C	84	LAB000169	NE	–

## 8.2 Frequency error

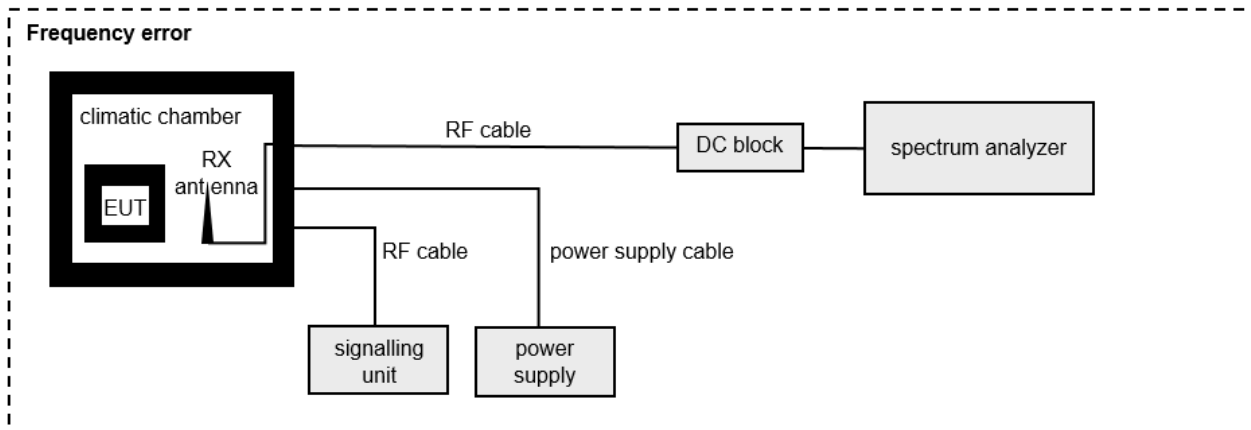

### List of test equipment used:

No.	Equipment	Type	Manufacturer	Serial No.	IBL No.	Kind of Calibration	Calibration
1	Power Supply	Elektro-Automatik GmbH & Co. KG	EA-PS 2042-10 B	2878350263	LAB000190	NE	-
3	Spectrum Analyser	Rohde & Schwarz	FSW50	101450	LAB000111	K	2022-07-28 → 12M → 2023-07-28
4	Climatic Chamber	CTS GmbH	T-65/50	204002	LAB000110	ZW	2022-05-11 → 12M → 2023-05-11
5	RF cable	ST18/72"	Huber & Suhner	2278434	LAB000160	-	-

## 9 Measurement procedures

### 9.1 Radiated spurious emissions from 9 kHz to 30 MHz

#### Test setup

- The EUT is set up according to its intended use, as described in the user manual or as defined by the manufacturer.
- In case of floor standing equipment, it is placed in the middle of the turn table.  
In case of tabletop equipment it is placed on a non-conductive table with a height of 80 cm.
- Additional equipment, cables, ... necessary for testing, are positioned like under normal operation.
- Interface cables, e.g. power supply, network, ... are connected to the connection box in the turn table.
- EUT is powered on and set into operation.

#### Pre-scan

- Turntable performs an azimuthal rotation from 0° to 315° in 45° steps.
- For each turntable step the EMI-receiver/spectrum analyser performs a positive-peak/max-hold sweep (=worst-case). Data is transferred to EMI-software and recorded. EMI-software will show the maximum level of all single sweeps as the final result for the pre-scan.

#### Final measurement

- Significant emissions found during the pre-scan will be maximized by the EMI-software by rotating the turntable from 0° to 360°.
- Loop antenna is rotated with special 3D adapter set to find maximum level of emissions.
- Plot of the pre-scan with frequencies of identified emissions including levels, correction factors, turn table position and settings of measuring equipment is recorded.

#### Distance correction (extrapolation)

- When performing measurements on test distances other than defined in the rules, the results shall be extrapolated to the specified distance by conservatively presuming that the field strength decays at 40 dB/decade of distance in the region closer than  $\lambda$  in m divided by  $2\pi$  (i.e.,  $\lambda/2\pi$ ), and at 20 dB/decade of distance beyond that, using the measurement of a single point at the radial angle that produces the maximum emission.  
This correction is already included in the limit line of corresponding measurement plots.

Detailed requirements can be found in e.g. ANSI C63.4 / C63.10

## 9.2 Radiated spurious emissions from 30 MHz to 1 GHz

### Test setup

- The EUT is set up according to its intended use, as described in the user manual or as defined by the manufacturer.
- In case of floor standing equipment, it is placed in the middle of the turn table.  
In case of tabletop equipment it is placed on a non-conductive table with a height of 80 cm.
- Additional equipment, cables, ... necessary for testing, are positioned like under normal operation.
- Interface cables, e.g. power supply, network, ... are connected to the connection box in the turn table.
- EUT is powered on and set into operation.

### Pre-scan

- Turntable performs an azimuthal rotation from 0° to 315° in 45° steps.
- Antenna polarisation is changed (H-V / V-H) and antenna height is changed from 1 meter to 4 meters.
- For each turntable step / antenna polarisation / antenna height the EMI-receiver/spectrum analyser performs a positive-peak/max-hold sweep (=worst-case). Data is transferred to EMI-software and recorded. EMI-software will show the maximum level of all single sweeps as the final result for the pre-scan.

### Final measurement

- Significant emissions found during the pre-scan will be maximized by the EMI-software based on evaluated data during the pre-scan by rotating the turntable and changing antenna height and polarisation.
- Final measurement will be performed with measuring equipment settings as defined in the applicable test standards (e.g. ANSI C6.4).
- Plot of the pre-scan with frequencies of identified emissions including levels, correction factors, turn table position, antenna polarisation and settings of measuring equipment is recorded.

### Distance correction (extrapolation)

- When performing measurements on test distances other than defined in the rules, the results shall be extrapolated to the specified distance by conservatively presuming that the field strength decays at 20 dB/decade of distance beyond the region  $\lambda$  in m divided by  $2\pi$  (i.e.,  $\lambda/2\pi$ ), using the measurement of a single point at the radial angle that produces the maximum emission.  
This correction is already included in the corresponding measurement plots.

Detailed requirements can be found in e.g. ANSI C63.4 / C63.10

## 10 MEASUREMENT UNCERTAINTIES

Radio frequency	$\leq \pm 10$ ppm
Radiated emission	$\leq \pm 6$ dB
Temperature	$\leq \pm 1$ °C
Humidity	$\leq \pm 5$ %
DC and low frequency voltages	$\leq \pm 3$ %

The indicated expanded measurement uncertainty corresponds to the standard measurement uncertainty for the measurement results multiplied by the coverage factor  $k = 2$ . It was determined in accordance with EA-4/01 m:2013. The true value is located in the corresponding interval with a probability of 95 %.