

**FCC PART 15 SUBPART C MEASUREMENT AND TEST REPORT**

**For**

**SHUOYING DIGITAL SCIENCE&TECHNOLOGY(CHINA)Co.,Ltd**

**No.187, 5th Binhai Road, Wenzhou, Zhejiang, China**

**E.U.T.: Wearable Camera**

**Model Name: DV036, DVR906HD**

**Brand Name: Vivitar**

**FCC ID: YGB-DV036**

**Report Number: NTC1604228F**

**Test Date(s): April 21, 2016 to May 05, 2016**

**Report Date(s): May 05, 2016**

**Prepared by**

**Dongguan Nore Testing Center Co., Ltd.**

**Building D, Gaosheng Science and Technology Park, Hongtu Road,  
Nancheng District, Dongguan City, Guangdong, China**

**Tel: +86-769-22022444**

**Fax: +86-769-22022799**

**Prepared By**

**Approved & Authorized Signer**

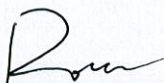
  
**Rose Hu / Engineer**

  
**Sunm Lv / Q.A. Director**

**Note: This test report is for the customer shown above and their specific product only. It may not be duplicated or used in part without prior written consent from Dongguan Nore Testing Center Co., Ltd. The test results referenced from this report are relevant only to the sample tested.**



## Table of Contents

<b>1. GENERAL INFORMATION .....</b>	<b>3</b>
1.1 PRODUCT DESCRIPTION FOR EQUIPMENT UNDER TEST .....	3
1.2 RELATED SUBMITTAL(S) / GRANT (S).....	4
1.3 TEST METHODOLOGY .....	4
1.4 EQUIPMENT MODIFICATIONS .....	4
1.5 SUPPORT DEVICE .....	5
1.6 TEST FACILITY AND LOCATION.....	5
1.7 SUMMARY OF TEST RESULTS.....	6
<b>2. SYSTEM TEST CONFIGURATION.....</b>	<b>7</b>
2.1 EUT CONFIGURATION.....	7
2.2 SPECIAL ACCESSORIES.....	7
2.3 DESCRIPTION OF TEST MODES .....	7
<b>3. CONDUCTED EMISSIONS TEST .....</b>	<b>8</b>
3.1 TEST SET-UP (BLOCK DIAGRAM OF CONFIGURATION).....	8
3.2 TEST CONDITION .....	8
3.3 MEASUREMENT RESULTS.....	8
<b>4. RADIATED EMISSION TEST .....</b>	<b>11</b>
4.1 TEST SET-UP (BLOCK DIAGRAM OF CONFIGURATION).....	11
4.2 MEASUREMENT PROCEDURE .....	11
4.3 LIMIT.....	12
4.4 MEASUREMENT RESULTS .....	12
<b>5. TEST EQUIPMENT LIST.....</b>	<b>15</b>

## 1. GENERAL INFORMATION

### 1.1 Product Description for Equipment under Test

Manufacturer/ Factory	: Shuoying Digital Science & Technology (China) Co., Ltd.
Address	: No.187, 5th Binhai Road, Binhai Industrial Park, Economic and Technological Development Zone, Wenzhou, Zhejiang, China
Power Supply	: DC 5V Come from USB Port, DC 3.7V Li-ion battery
Test voltage	: AC 120V 60Hz, AC 240V 60Hz (PC Input or Adapter input), DC 3.7V Li-ion battery Only the worst case was recorded in the report.
Model name	: DV036, DVR906HD (All tests were carried on model DV036.)
Model difference	: These models have the same circuit schematic, construction, PCB Layout and critical components. Their difference in model name is only for trading purpose.
Hardware version	: V1.2_BETA02_D
Software version	: 001
Serial number	: N/A
E.U.T. Type	: Class B
Operation Frequency	: Below 108MHz(Declaration by manufacturer)
Cable	: USB Line: 0.80m, Unshielded

## 1.2 Related Submittal(s) / Grant (s)

This submittal(s) (test report) is intended for FCC ID: **YGB-DV036** filing to comply with FCC Part 15 Subpart C Class B (2016).

## 1.3 Test Methodology

Both AC mains line-conducted and radiated emission measurements were performed according to the procedures in ANSI C63.10 (2013). Radiated emission measurement was performed in semi-anechoic chamber and conducted emission measurement was performed in shield room. For radiated emission measurement, preliminary scans were performed in the semi-anechoic chamber only to determine the worst case modes. All radiated tests were performed at an antenna to EUT distance of 3 meters.

## 1.4 Equipment Modifications

Not available for this EUT intended for grant.

## 1.5 Support Device

PC	: Manufacturer: DELL M/N: Vostro 3902 S/N: 108MY02 Power Cord: 1.8m Unshielded, with core CE, FCC: DOC
LCD TV	: Manufacturer: LENOVO M/N: L2061WD S/N: 3M04769B1102083
Mouse	: Manufacturer: Logitech M/N: M-U0026 P/N: 810-002182 CE, FCC: DOC
Keyboard	: Manufacturer: SLNT M/N: KX03-SV S/N: N/A CE, FCC: DOC
Printer	: Manufacturer: Lenovo M/N: 3518 Data Cable: 1.5m Shielded Power Cord: 1.5m Unshielded with core CE, FCC: DOC
Adapter	: Model: BSYC050200UW Input: AC100-240V 50/60Hz 0.5A Output: DC 5.0V 2000mA

## 1.6 Test Facility and Location

Listed by FCC, July 03, 2014  
The Certificate Registration Number is 665078.  
Listed by Industry Canada, June 18, 2014  
The Certificate Registration Number is 9743A.

Dongguan NTC Co., Ltd.  
(Full Name: Dongguan Nore Testing Center Co., Ltd.)

Building D, Gaosheng Science and Technology Park, Hongtu Road,  
Nancheng District, Dongguan City, Guangdong, China  
(Full Name: Building D, Gaosheng Science & Technology Park,  
Zhouxi Longxi Road, Nancheng District, Dongguan, Guangdong, China.)

### 1.7 Summary of Test Results

FCC Rules	Description Of Test	Result
§15.107	AC Power Conducted Emission	Compliant
§15.109	Radiated Emission	Compliant

---

## 2. System Test Configuration

### 2.1 EUT Configuration

The EUT configuration for testing is installed on RF field strength measurement to meet the Commissions requirement and operating in a manner which intends to maximize its emission characteristics in a continuous normal application.

### 2.2 Special Accessories

Not available for this EUT intended for grant.

### 2.3 Description of test modes

The EUT has been tested under operating condition.

Test mode 1: Video recording mode

Test mode 2: Connect to PC via USB

Test mode 3: Shooting mode

Test mode 4: Charging+Video recording mode

### 3. Conducted Emissions Test

#### 3.1 Test SET-UP (Block Diagram of Configuration)

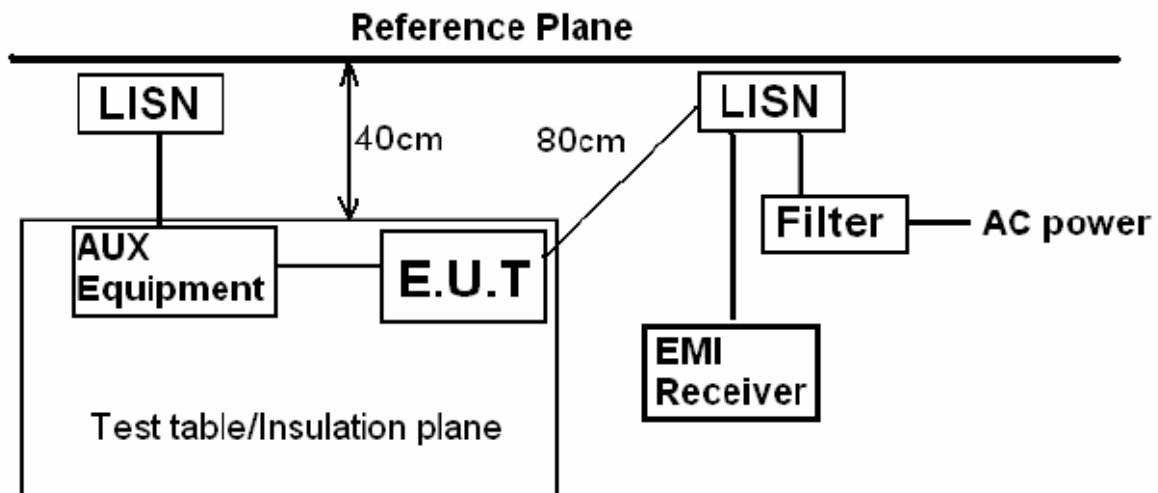

#### 3.2 Test Condition

##### Test Requirement: FCC Part 15.107

The E.U.T. is put on the 0.8 m high table and connected to the AC mains through a Artificial Mains Network (AMN). This provided a 50ohm coupling impedance for the tested equipments. Both sides of AC line are checked to find out the maximum conducted emission levels according to the FCC ANSI C63.10-2013 regulations during conducted emission test.

The bandwidth of the test receiver (R&S Test Receiver ESCI) is set at 9 KHz.

**Frequency Range: 150KHz ~ 30MHz**

**Detector: RBW 9KHz, VBW 30KHz**

**Operation Mode: Test mode 2, 4**

#### 3.3 Measurement Results

Please refer to following plots of the worst case: Test mode 2, AC 120V 60Hz.

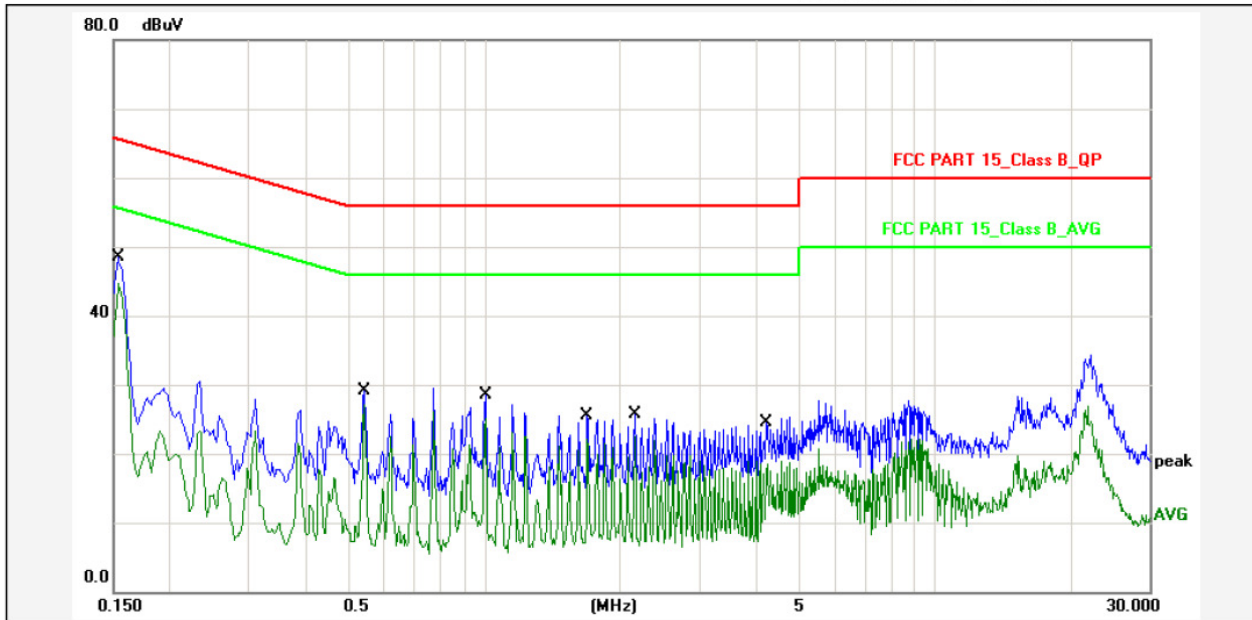

Report No.: DV036  
 Test Standard: FCC PART 15\_Class B\_QP  
 Test item: Conducted Emission  
 Applicant: SHUOYING  
 Product: Wearable Camera  
 Model No.: DV036  
 Phase: L1  
 Temp.( )/Hum.(%): 25(C) / 55 %  
 Power Rating: DC 5V(PC Input AC 120V 60Hz)  
 Test Engineer: Chilaw  
 Test Mode: Connect to PC via USB  
 Remark:

No.	Frequency (MHz)	Factor (dBuV)	Reading (dBuV)	Level (dBuV)	Limit (dBuV)	Margin (dB)	Detector	P/F	Remark
1	0.1539	10.80	35.60	46.40	65.78	-19.38	QP	P	
2	0.1539	10.80	31.80	42.60	55.78	-13.18	AVG	P	
3	0.5420	10.80	16.30	27.10	56.00	-28.90	QP	P	
4	0.5420	10.80	14.20	25.00	46.00	-21.00	AVG	P	
5	1.0060	10.80	15.80	26.60	56.00	-29.40	QP	P	
6	1.0060	10.80	12.20	23.00	46.00	-23.00	AVG	P	
7	1.6980	10.80	12.70	23.50	56.00	-32.50	QP	P	
8	1.6980	10.80	9.20	20.00	46.00	-26.00	AVG	P	
9	2.1619	10.80	12.80	23.60	56.00	-32.40	QP	P	
10	2.1619	10.80	9.60	20.40	46.00	-25.60	AVG	P	
11	4.2459	10.80	11.60	22.40	56.00	-33.60	QP	P	
12	4.2459	10.80	5.70	16.50	46.00	-29.50	AVG	P	

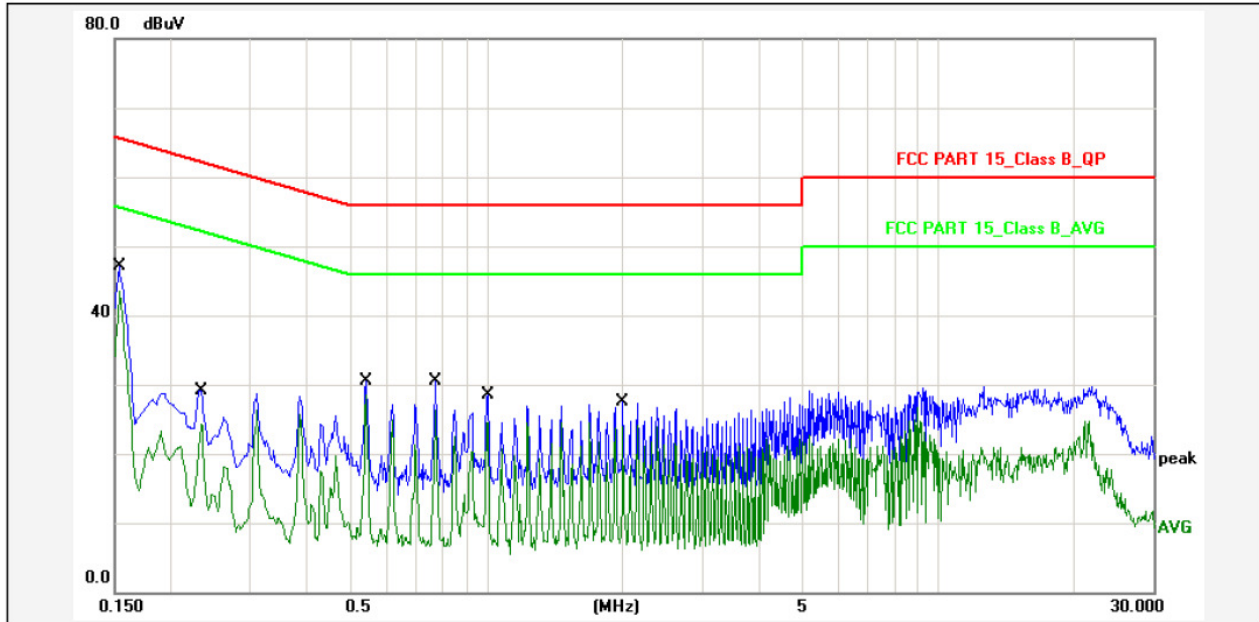

Report No.: DV036  
 Test Standard: FCC PART 15\_Class B\_QP  
 Test item: Conducted Emission  
 Applicant: SHUOYING  
 Product: Wearable Camera  
 Model No.: DV036  
 Phase: N  
 Temp.( )/Hum.(%): 25(C) / 55 %  
 Power Rating: DC 5V(PC Input AC 120V 60Hz)  
 Test Engineer: Chilaw

Test Mode: Connect to PC via USB

Remark:

No.	Frequency (MHz)	Factor (dBuV)	Reading (dBuV)	Level (dBuV)	Limit (dBuV)	Margin (dB)	Detector	P/F	Remark
1	0.1539	10.80	34.20	45.00	65.78	-20.78	QP	P	
2	0.1539	10.80	30.70	41.50	55.78	-14.28	AVG	P	
3	0.2340	10.80	16.30	27.10	62.30	-35.20	QP	P	
4	0.2340	10.80	11.40	22.20	52.30	-30.10	AVG	P	
5	0.5420	10.80	17.70	28.50	56.00	-27.50	QP	P	
6	0.5420	10.80	15.60	26.40	46.00	-19.60	AVG	P	
7	0.7740	10.80	17.60	28.40	56.00	-27.60	QP	P	
8	0.7740	10.80	13.40	24.20	46.00	-21.80	AVG	P	
9	1.0060	10.80	15.70	26.50	56.00	-29.50	QP	P	
10	1.0060	10.80	11.70	22.50	46.00	-23.50	AVG	P	
11	2.0059	10.80	14.70	25.50	56.00	-30.50	QP	P	
12	2.0059	10.80	11.10	21.90	46.00	-24.10	AVG	P	

## 4. Radiated Emission Test

### 4.1 Test SET-UP (Block Diagram of Configuration)

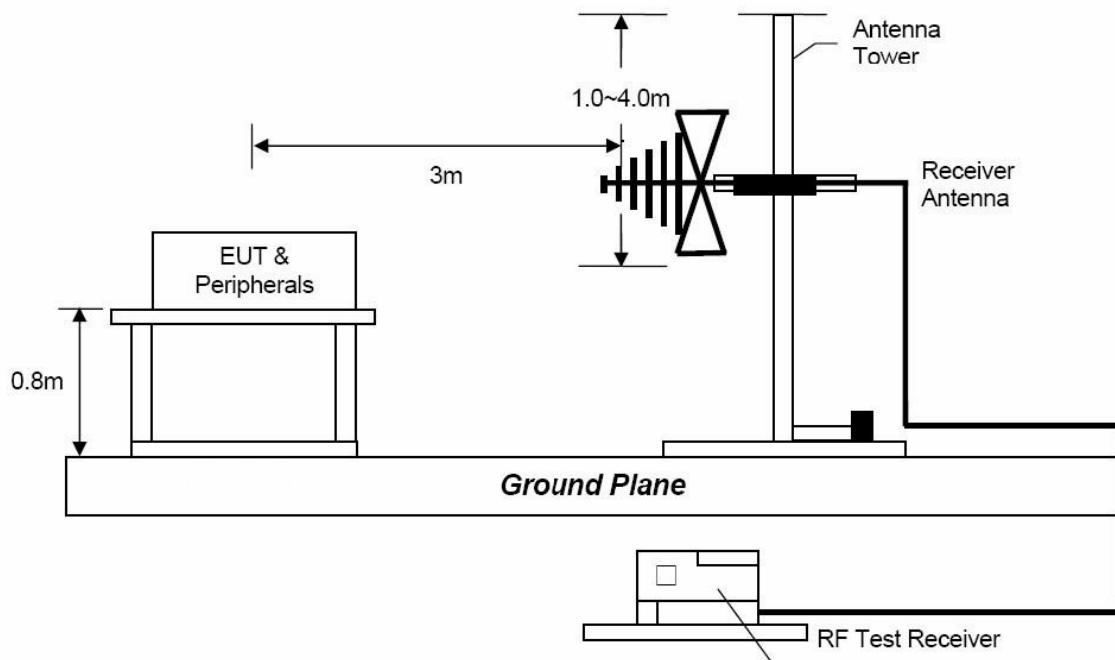

### 4.2 Measurement Procedure

E.U.T. and its simulators are placed on a turntable, which is 0.8 meter high above ground. The turntable can rotate 360 degrees to determine the position of the maximum emission level. E.U.T. is set 3.0 meters away from the receiving antenna, which is mounted on a antenna tower. The antenna can be moved up and down between 1.0 meter and 4 meters to find out the maximum emission level. Broadband antenna (calibrated bilog antenna) is used as receiving antenna. Both horizontal and vertical polarization of the antenna is set on measurement. In order to find the maximum emission levels, all of the interface cables must be manipulated according to FCC ANSI C63.10-2013 on radiated emission measurement.

The bandwidth of the EMI test receiver (R&S ESCI7) is set at 120 KHz.  
The frequency range from 30 MHz to 1000 MHz is checked.

### 4.3 Limit

Frequency range MHz	Distance Meters	Field Strengths Limit	
		$\mu\text{V}/\text{m}$	$\text{dB}(\mu\text{V})/\text{m}$
30 ~ 88	3	100	40.0
88 ~ 216	3	150	43.5
216 ~ 960	3	200	46.0
960 ~ 1000	3	500	54.0

- Remark : (1) Emission level  $(\text{dB})\mu\text{V} = 20 \log$  Emission level  $\mu\text{V}/\text{m}$   
(2) The smaller limit shall apply at the cross point between two frequency bands.  
(3) Distance is the distance in meters between the measuring instrument, antenna and the closest point of any part of the device or system.

### 4.4 Measurement Results

**Operation Mode: Test mode 1,2,3,4**

**Please refer to following plots of the worst case: Test mode 2, AC 120V 60Hz.**

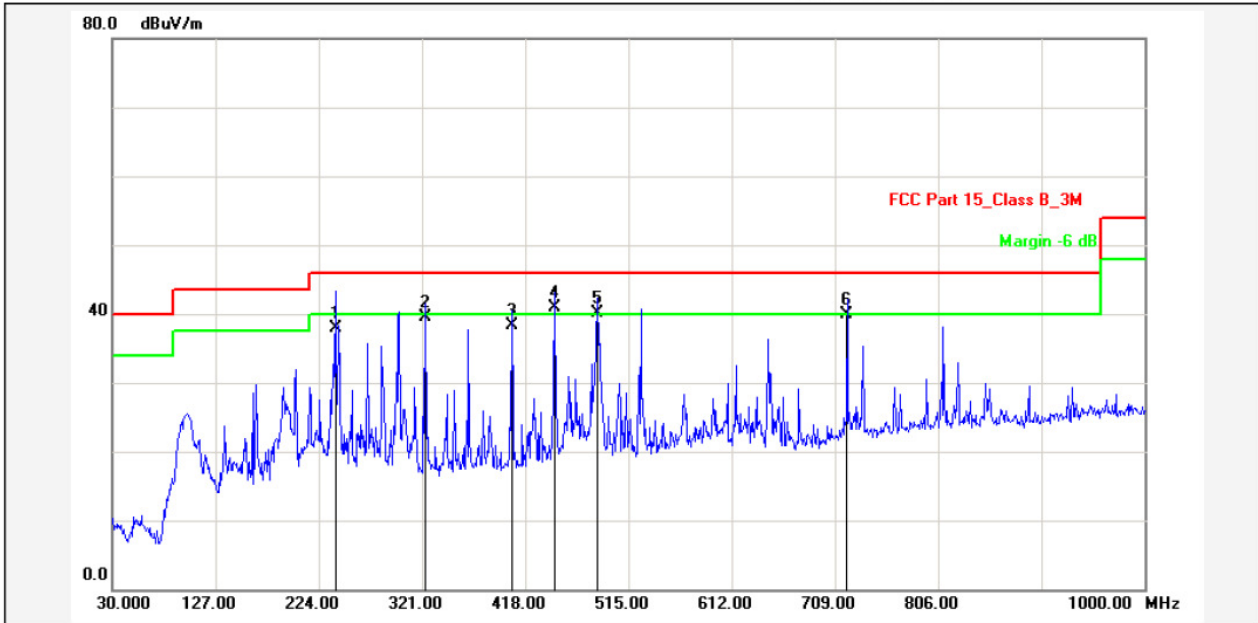

Report No.: DV036	Test Standard: FCC Part 15_Class B_3M	Test Distance: 3m
Test item: Radiation Emission	Ant. Polarization: Horizontal	Temp.(C)/Hum.(%): 22(C) / 54 %
Applicant: SHUOYING	Power Rating: DC 5V(PC Input AC120V 60Hz)	Test Engineer: Anson
Product: Wearable Camera		
Model No.: DV036		

Test Mode: Connect to PC via USB

Remark:

No.	Frequency (MHz)	Factor (dB/m)	Reading (dBuV)	Level (dBuV/m)	Limit (dBuV/m)	Margin (dB)	Detector	Height (cm)	Azimuth (deg.)	P/F	Remark
1	239.5200	-12.06	49.96	37.90	46.00	-8.10	QP			P	
2	323.9100	-9.81	49.31	39.50	46.00	-6.50	QP			P	
3	405.3899	-8.99	47.39	38.40	46.00	-7.60	QP			P	
4	445.1600	-8.08	49.08	41.00	46.00	-5.00	QP			P	
5	485.8999	-7.07	47.27	40.20	46.00	-5.80	QP			P	
6	720.6399	-3.28	43.28	40.00	46.00	-6.00	QP			P	

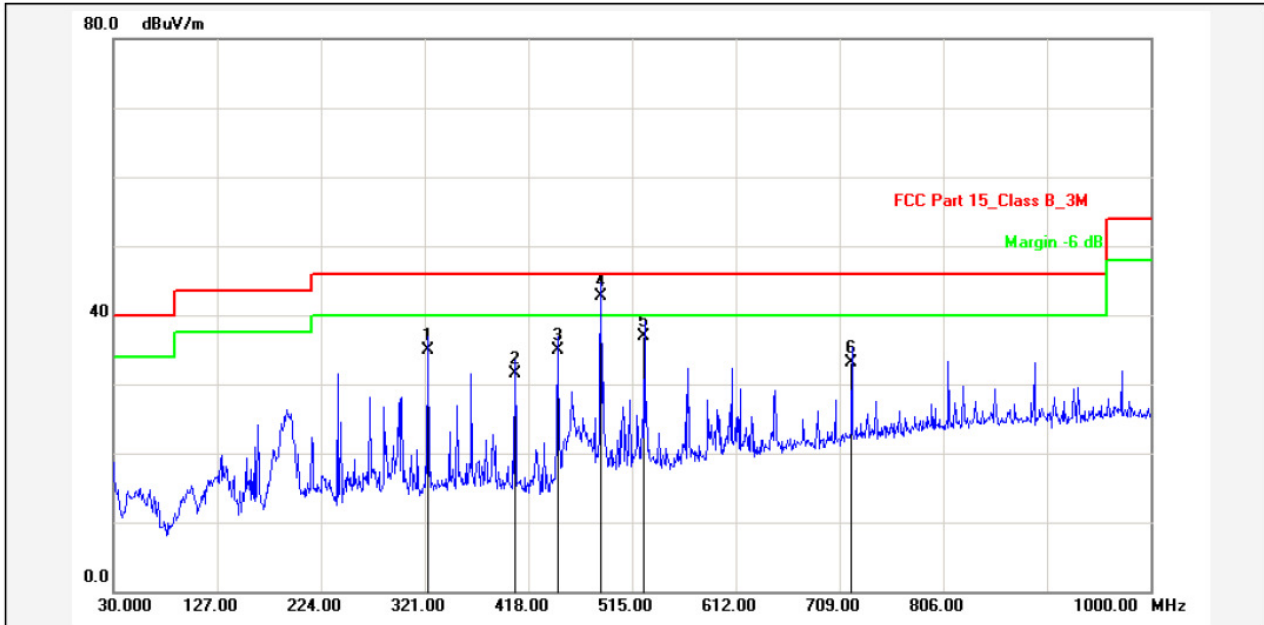

Report No.: DV036  
 Test Standard: FCC Part 15\_Class B\_3M  
 Test item: Radiation Emission  
 Applicant: SHUOYING  
 Product: Wearable Camera  
 Model No.: DV036

Test Distance: 3m  
 Ant. Polarization: Vertical  
 Temp.(C)/Hum.(%): 22(C) / 54 %  
 Power Rating: DC 5V(PC Input AC120V 60Hz)  
 Test Engineer: Anson

Test Mode: Connect to PC via USB  
 Remark:

No.	Frequency (MHz)	Factor (dB/m)	Reading (dBuV)	Level (dBuV/m)	Limit (dBuV/m)	Margin (dB)	Detector	Height (cm)	Azimuth (deg.)	P/F	Remark
1	323.9100	-11.81	46.71	34.90	46.00	-11.10	QP			P	
2	405.3899	-11.25	42.75	31.50	46.00	-14.50	QP			P	
3	445.1600	-10.82	45.72	34.90	46.00	-11.10	QP			P	
4	485.9000	-9.07	51.72	42.65	46.00	-3.35	QP			P	
5	526.6399	-8.71	45.71	37.00	46.00	-9.00	QP			P	
6	720.6399	-3.28	36.48	33.20	46.00	-12.80	QP			P	

## 5. Test Equipment List

Description	Manufacturer	Model Number	Serial Number	Characteristics	Calibration Date	Calibration Due Date
Test Receiver	Rohde & Schwarz	ESCI7	100837	9KHz~7GHz	Nov. 24, 2014	Nov. 23, 2015
Antenna	Schwarzbeck	VULB9162	9162-010	30MHz~7GHz	Nov. 27, 2014	Nov. 26, 2015
Positioning Controller	UC	UC 3000	N/A	0~360°, 1-4m	N/A	N/A
Color Monitor	SUNSP0	SP-140A	N/A	N/A	N/A	N/A
Single Phase Power Line Filter	SAEMC	PF201A-32	110210	32A	N/A	N/A
3 Phase Power Line Filter	SAEMC	PF401A-200	110318	200A	N/A	N/A
DC Power Filter	SAEMC	PF301A-200	110245	200A	N/A	N/A
Cable	Huber+Suhner	CBL2-NN-1M	22390001	9KHz~7GHz	Nov. 08, 2014	Nov. 07, 2015
Cable	Huber+Suhner	CIL02	N/A	9KHz~7GHz	Nov. 08, 2014	Nov. 07, 2015
RF Cable	Huber+Suhner	SF-104	MY16559/4	9KHz~25GHz	Mar. 06, 2016	Mar. 05, 2017
L.I.S.N.	Rohde & Schwarz	ENV 216	101317	9KHz~30MHz	Nov. 08, 2014	Nov. 07, 2015

---End---