

FCC Test Report

Report No.: RF110607C27U

FCC ID: YG7ZRF32200

Test Model: WHD200R

Series Model: WHD100R

Received Date: Nov. 10, 2015

Test Date: Dec. 02 ~ Dec. 29, 2015

Issued Date: Jan. 06, 2016

Applicant: Zinwell Corporation

Address: 7F., No.512, Yuanshan Rd., Zhonghe Dist., New Taipei City 235, Taiwan (R.O.C.)

Issued By: Bureau Veritas Consumer Products Services (H.K.) Ltd., Taoyuan Branch

Lab Address: No. 47-2, 14th Ling, Chia Pau Vil., Lin Kou Dist., New Taipei City, Taiwan, R.O.C.

Test Location: No.19, Hwa Ya 2nd Rd., Wen Hwa Vil., Kwei Shan Dist., Taoyuan City 33383, TAIWAN (R.O.C.)



This report is for your exclusive use. Any copying or replication of this report to or for any other person or entity, or use of our name or trademark, is permitted only with our prior written permission. This report sets forth our findings solely with respect to the test samples identified herein. The results set forth in this report are not indicative or representative of the quality or characteristics of the lot from which a test sample was taken or any similar or identical product unless specifically and expressly noted. Our report includes all of the tests requested by you and the results thereof based upon the information that you provided to us. You have 60 days from date of issuance of this report to notify us of any material error or omission caused by our negligence, provided, however, that such notice shall be in writing and shall specifically address the issue you wish to raise. A failure to raise such issue within the prescribed time shall constitute your unqualified acceptance of the completeness of this report, the tests conducted and the correctness of the report contents. Unless specific mention, the uncertainty of measurement has been explicitly taken into account to declare the compliance or non-compliance to the specification. The report must not be used by the client to claim product certification, approval, or endorsement by TAF or any government agencies.

Table of Contents

Release Control Record	4
1 Certificate of Conformity	5
2 Summary of Test Results	6
2.1 Measurement Uncertainty.....	6
2.2 Modification Record.....	6
3 General Information	7
3.1 General Description of EUT.....	7
3.2 Description of Test Modes.....	10
3.2.1 Test Mode Applicability and Tested Channel Detail.....	11
3.3 Duty Cycle of Test Signal.....	13
3.4 Description of Support Units.....	14
3.4.1 Configuration of System under Test.....	14
3.5 General Description of Applied Standards.....	16
4 Test Types and Results	17
4.1 Radiated Emission and Bandedge Measurement.....	17
4.1.1 Limits of Radiated Emission and Bandedge Measurement.....	17
4.1.2 Test Instruments.....	18
4.1.3 Test Procedures.....	19
4.1.4 Deviation from Test Standard.....	19
4.1.5 Test Set Up.....	20
4.1.6 EUT Operating Conditions.....	20
4.1.7 Test Results.....	21
4.2 Conducted Emission Measurement.....	38
4.2.1 Limits of Conducted Emission Measurement.....	38
4.2.2 Test Instruments.....	38
4.2.3 Test Procedures.....	38
4.2.4 Deviation from Test Standard.....	39
4.2.5 Test Setup.....	39
4.2.6 EUT Operating Conditions.....	39
4.2.7 Test Results.....	40
4.3 Transmit Power Measurement.....	44
4.3.1 Limits of Transmit Power Measurement.....	44
4.3.2 Test Setup.....	44
4.3.3 Test Instruments.....	44
4.3.4 Test Procedure.....	45
4.3.5 Deviation from Test Standard.....	45
4.3.6 EUT Operating Conditions.....	45
4.3.7 Test Result.....	46
4.4 Peak Power Spectral Density Measurement.....	50
4.4.1 Limits of Peak Power Spectral Density Measurement.....	50
4.4.2 Test Setup.....	50
4.4.3 Test Instruments.....	50
4.4.4 Test Procedures.....	50
4.4.5 Deviation from Test Standard.....	50
4.4.6 EUT Operating Conditions.....	50
4.4.7 Test Results.....	51
4.5 Frequency Stability.....	53
4.5.1 Limits of Frequency Stability Measurement.....	53
4.5.2 Test Setup.....	53
4.5.3 Test Instruments.....	53
4.5.4 Test Procedure.....	53
4.5.5 Deviation from Test Standard.....	53
4.5.6 EUT Operating Condition.....	53



4.5.7 Test Results	54
4.6 6dB Bandwidth Measurement	55
4.6.1 Limits of 6dB Bandwidth Measurement	55
4.6.2 Test Setup	55
4.6.3 Test Instruments	55
4.6.4 Test Procedure	55
4.6.5 Deviation from Test Standard	55
4.6.6 EUT Operating Condition	55
4.6.7 Test Results	56
5 Pictures of Test Arrangements	57
Appendix – Information on the Testing Laboratories	58



A D T

Release Control Record

Issue No.	Description	Date Issued
RF110607C27U	Original release	Jan. 06, 2016



A D T

1 Certificate of Conformity

Product: Wireless HD Net Connect Receiver/ Wireless HD AV Connect Receiver

Brand: ZINWELL

Test Model: WHD200R

Series Model: WHD100R

Sample Status: Engineering sample

Applicant: Zinwell Corporation

Test Date: Dec. 02 ~ Dec. 29, 2015

Standards: 47 CFR FCC Part 15, Subpart E (Section 15.407)
ANSI C63.10:2013

The above equipment has been tested by **Bureau Veritas Consumer Products Services (H.K.) Ltd., Taoyuan Branch**, and found compliance with the requirement of the above standards. The test record, data evaluation & Equipment Under Test (EUT) configurations represented herein are true and accurate accounts of the measurements of the sample's EMC characteristics under the conditions specified in this report.

Prepared by :  , **Date:** Jan. 06, 2016
Ivy Lin / Specialist

Approved by :  , **Date:** Jan. 06, 2016
Ken Liu / Senior Manager

2 Summary of Test Results

47 CFR FCC Part 15, Subpart E (Section 15.407)			
FCC Clause	Test Item	Result	Remarks
15.207 15.407(b)(6)	AC Power Conducted Emissions	Pass	Meet the requirement of limit. Minimum passing margin is -23.55dB at 0.15391MHz.
15.407(b) (1/2/3/4/6)	Radiated Emissions & Band Edge Measurement	Pass	Meet the requirement of limit. Minimum passing margin is -4.1dB at 11650.00MHz.
15.407(a)(1/2 /3)	Max Average Transmit Power	Pass	Meet the requirement of limit.
15.407(a)(1/2 /3)	Peak Power Spectral Density	Pass	Meet the requirement of limit.
15.407(e)	6dB bandwidth	Pass	Meet the requirement of limit. (U-NII-3 Band only)
15.407(g)	Frequency Stability	Pass	Meet the requirement of limit.
15.203	Antenna Requirement	Pass	No antenna connector is used.

2.1 Measurement Uncertainty

Where relevant, the following measurement uncertainty levels have been estimated for tests performed on the EUT as specified in CISPR 16-4-2:

Measurement	Frequency	Expanded Uncertainty (k=2) (
-------------	-----------	------------------------------

3 General Information

3.1 General Description of EUT

Product	Wireless HD Net Connect Receiver/ Wireless HD AV Connect Receiver
Brand	ZINWELL
Test Model	WHD200R
Series Model	WHD100R
Model Difference	Refer to Note
Sample Status	Engineering sample
Power Supply Rating	5Vdc
Modulation Technology	OFDM
Transfer Rate	100Kbps transmission, 1Gbps reception
Operating Frequency	5180 ~ 5240MHz, 5270 ~ 5310MHz, 5510 ~ 5670MHz & 5745 ~ 5825MHz
Number of Channel	5180 ~ 5240MHz: 4 for WHDI (20MHz) 2 for WHDI (40MHz) 5270 ~ 5310MHz: 2 for WHDI (40MHz) 5510 ~ 5670MHz: 3 for WHDI (40MHz) 5745 ~ 5825MHz: 5 for WHDI (20MHz) 2 for WHDI (40MHz)
Output Power	5180 ~ 5240MHz: 46.238mW 5270 ~ 5310MHz: 43.652mW 5510 ~ 5670MHz: 44.055mW 5745 ~ 5825MHz: 44.463mW
Antenna Type	Printed antenna with 6.2dBi gain x 2 (1TX, 2RX) Chip antenna with 6.2dBi gain x 3 (3RX)
Antenna Connector	NA
Accessory Device	Adapter, Remote control (Brand: ZINWELL, Model: JX-9051)
Data Cable Supplied	1.5m shielded HDMI cable with 1 core; 0.45m shielded USB cable with 1 core (used for adapter 2) 0.45m shielded USB cable without core (used for adapter 5) 1.0m shielded IR in cable without core

Note:

1. This report is prepared for FCC class II permissive change. This report is issued as a supplementary report to BV ADT report no. RF110607C27, RF110607C27-1, RF110607C27A, RF110607C27J & RF110607C27J-1. The differences compared with the original report are listed below:
 - a. Updating standard to new rule version for all bands.
 - b. Adding new adapters (adapter 4 & 5).
 - c. Adding 5825MHz (CH165) for WHDI (20MHz).
 - d. Adding functions of IR Port and USB Port for Zinwell models (WHD100R and WHD200R)
2. The EUT provides 1 completed transmitter and 5 receivers.

Modulation Mode	TX Function
WHDI (20MHz)	1TX
WHDI (40MHz)	1TX

3. All product names and models are listed as below.

Brand	Description	Model
ZINWELL	Wireless HD Net Connect Receiver	WHD100R
	Wireless HD AV Connect Receiver	WHD200R (Main test model)

4. The EUT consumes power from the following adapters. (Adapter 4 & 5 are new adapters)

Adapter 1	
Brand	SINO-AMERICAN
Model	SA110C-05S-A
Input Power	100-240Vac, 50-60Hz, 0.3A
Output Power	5Vdc, 1.5A, 7.5W
Power Line	DC 1.5m shielded USB cable with one core

Adapter 2	
Brand	Asian Power Devices Inc.
Model	WA-10K05R
Input Power	100-240Vac, 50-60Hz, 0.3A Max.
Output Power	5Vdc, 2A

Adapter 3	
Brand	Asian Power Devices Inc.
Model	WA-10P05FU
Input Power	100-240Vac, 50-60Hz, 0.3A Max.
Output Power	5Vdc, 2A
Power Line	1.5m non-shielded cable with 1 core

Adapter 4	
Brand	Asian Power Devices Inc.
Model	WB-10E05FU
Input Power	100-240Vac, 50-60Hz, 0.4A Max.
Output Power	5Vdc/ 2A
Power Line	1.45m non-shielded cable with 1 core

Adapter 5	
Brand	Asian Power Devices Inc.
Model	WB-10E05R
Input Power	100-240Vac, 50-60Hz, 0.4A Max.
Output Power	5Vdc/ 2A

3.2 Description of Test Modes

For 5180 ~ 5240MHz

4 channels are provided for WHDI (20MHz):

Channel	Frequency	Channel	Frequency
36	5180 MHz	44	5220 MHz
40	5200 MHz	48	5240 MHz

2 channels are provided for WHDI (40MHz):

Channel	Frequency	Channel	Frequency
38	5190 MHz	46	5230 MHz

For 5270 ~ 5310MHz

2 channels are provided for WHDI (40MHz):

Channel	Frequency	Channel	Frequency
54	5270 MHz	62	5310 MHz

For 5510 ~ 5670MHz

3 channels are provided for WHDI (40MHz):

Channel	Frequency	Channel	Frequency
102	5510 MHz	134	5670 MHz
110	5550 MHz		

For 5745 ~ 5825MHz:

5 channels are provided for WHDI (20MHz):

Channel	Frequency	Channel	Frequency
149	5745MHz	161	5805MHz
153	5765MHz	165	5825MHz
157	5785MHz		

2 channels are provided for WHDI (40MHz):

Channel	Frequency	Channel	Frequency
151	5755MHz	159	5795MHz

3.2.1 Test Mode Applicability and Tested Channel Detail

EUT CONFIGURE MODE	APPLICABLE TO				DESCRIPTION
	RE \geq 1G	RE $<$ 1G	PLC	APCM	
A	-	√	√	-	Adapter Model: WB-10E05FU
B	√	√	√	√	Adapter Model: WB-10E05R

Where **RE \geq 1G**: Radiated Emission above 1GHz & Bandedge Measurement
RE $<$ 1G: Radiated Emission below 1GHz
PLC: Power Line Conducted Emission
APCM: Antenna Port Conducted Measurement

Note: “-” means no effect.

Radiated Emission Test (Above 1GHz):

- Pre-Scan has been conducted to determine the worst-case mode from all possible combinations between available modulations, data rates and antenna ports (if EUT with antenna diversity architecture).
- Following channel(s) was (were) selected for the final test as listed below.

EUT CONFIGURE MODE	MODE	FREQ. BAND (MHz)	AVAILABLE CHANNEL	TESTED CHANNEL	MODULATION TECHNOLOGY	DATA RATE (Mbps)
B	WHDI (20MHz)	5180-5240	36 to 48	36, 40, 48	OFDM	100
B	WHDI (40MHz)	5190-5230	38 to 46	38, 46	OFDM	100
B	WHDI (40MHz)	5270-5310	54 to 62	54, 62	OFDM	100
B	WHDI (40MHz)	5510-5670	102 to 134	102, 110, 134	OFDM	100
B	WHDI (20MHz)	5745-5825	149 to 165	149, 157, 165	OFDM	100
B	WHDI (40MHz)	5755-5795	151 to 159	151, 159	OFDM	100

Radiated Emission Test (Below 1GHz):

- Pre-Scan has been conducted to determine the worst-case mode from all possible combinations between available modulations, data rates and antenna ports (if EUT with antenna diversity architecture).
- Following channel(s) was (were) selected for the final test as listed below.

EUT CONFIGURE MODE	MODE	FREQ. BAND (MHz)	AVAILABLE CHANNEL	TESTED CHANNEL	MODULATION TECHNOLOGY	DATA RATE (Mbps)
A, B	WHDI (40MHz)	5190-5230, 5270-5310, 5510-5670, 5755-5795	38 to 46, 54 to 62, 102 to 134, 151 to 159	46	OFDM	100

Power Line Conducted Emission Test:

- Pre-Scan has been conducted to determine the worst-case mode from all possible combinations between available modulations, data rates and antenna ports (if EUT with antenna diversity architecture).
- Following channel(s) was (were) selected for the final test as listed below.

EUT CONFIGURE MODE	MODE	FREQ. BAND (MHz)	AVAILABLE CHANNEL	TESTED CHANNEL	MODULATION TECHNOLOGY	DATA RATE (Mbps)
A, B	WHDI (40MHz)	5190-5230, 5270-5310, 5510-5670, 5755-5795	38 to 46, 54 to 62, 102 to 134, 151 to 159	46	OFDM	100

Antenna Port Conducted Measurement:

- This item includes all test value of each mode, but only includes spectrum plot of worst value of each mode.
- Pre-Scan has been conducted to determine the worst-case mode from all possible combinations between available modulations, data rates and antenna ports (if EUT with antenna diversity architecture).
- Following channel(s) was (were) selected for the final test as listed below.

EUT CONFIGURE MODE	MODE	FREQ. BAND (MHz)	AVAILABLE CHANNEL	TESTED CHANNEL	MODULATION TECHNOLOGY	DATA RATE (Mbps)
B	WHDI (20MHz)	5180-5240	36 to 48	36, 40, 48	OFDM	100
B	WHDI (40MHz)	5190-5230	38 to 46	38, 46	OFDM	100
B	WHDI (40MHz)	5270-5310	54 to 62	54, 62	OFDM	100
B	WHDI (40MHz)	5510-5670	102 to 134	102, 110, 134	OFDM	100
B	WHDI (20MHz)	5745-5825	149 to 165	149, 157, 165	OFDM	100
B	WHDI (40MHz)	5755-5795	151 to 159	151, 159	OFDM	100

Test Condition:

APPLICABLE TO	ENVIRONMENTAL CONDITIONS	INPUT POWER	TESTED BY
RE\geq1G	23deg. C, 63%RH, 22deg. C, 65%RH, 25deg. C, 65%RH	120Vac, 60Hz	Chris Lin, Alan Wu, Tank Wu
RE<1G	25deg. C, 65%RH	120Vac, 60Hz	Tank Wu
PLC	25deg. C, 60%RH	120Vac, 60Hz	Tank Wu
APCM	25deg. C, 60%RH	120Vac, 60Hz	Ted Chang

3.3 Duty Cycle of Test Signal

WHDI (20MHz): Duty cycle of test signal is 100 %, duty factor is not required.

WHDI (40MHz): Duty cycle of test signal is 100 %, duty factor is not required.

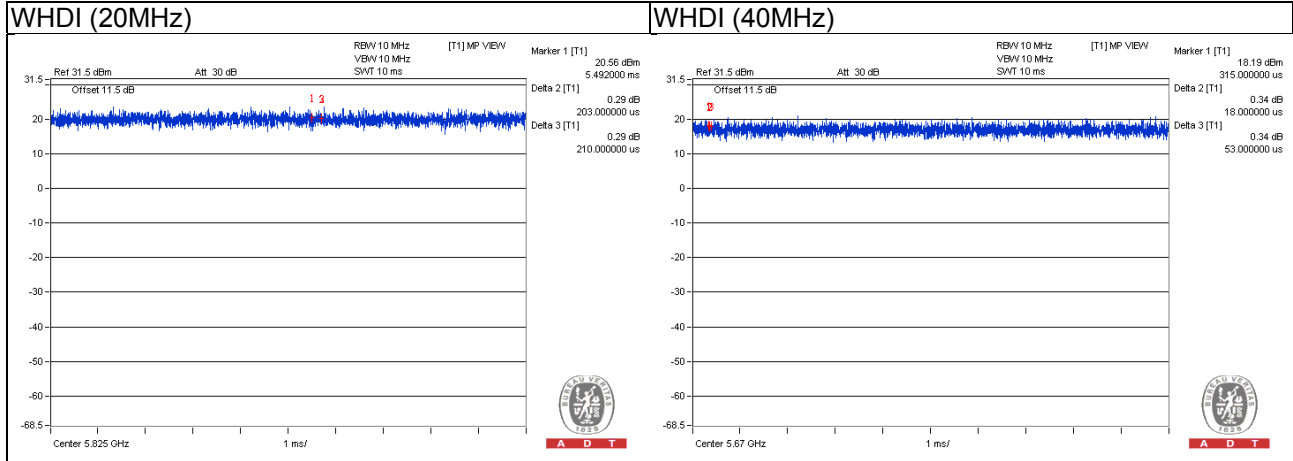

3.4 Description of Support Units

The EUT has been tested as an independent unit together with other necessary accessories or support units. The following support units or accessories were used to form a representative test configuration during the tests.

ID	Product	Brand	Model No.	Serial No.	FCC ID	Remarks
A.	TV Monitor	sony	KDL-32EX650	4365185	Verification	-
B.	Mouse	DELL	MO56UO	513021799	FCC DoC Approved	-

Note: All power cords of the above support units are non-shielded (1.8m).

ID	Descriptions	Qty.	Length (m)	Shielding (Yes/No)	Cores (Qty.)	Remarks
1.	HDMI cable	1	1.5	Y	1	Accessory of EUT
2.	DC cable	1	1.45	Y	1	Attached on adapter 4
3.	USB cable	1	0.45	Y	0	Accessory of EUT For adapter 5
4.	IR cable	1	0.95	Y	0	Accessory of the EUT
5.	USB cable	1	1.8	Y	0	-

Note: The core(s) is(are) originally attached to the cable(s).

Test Mode B

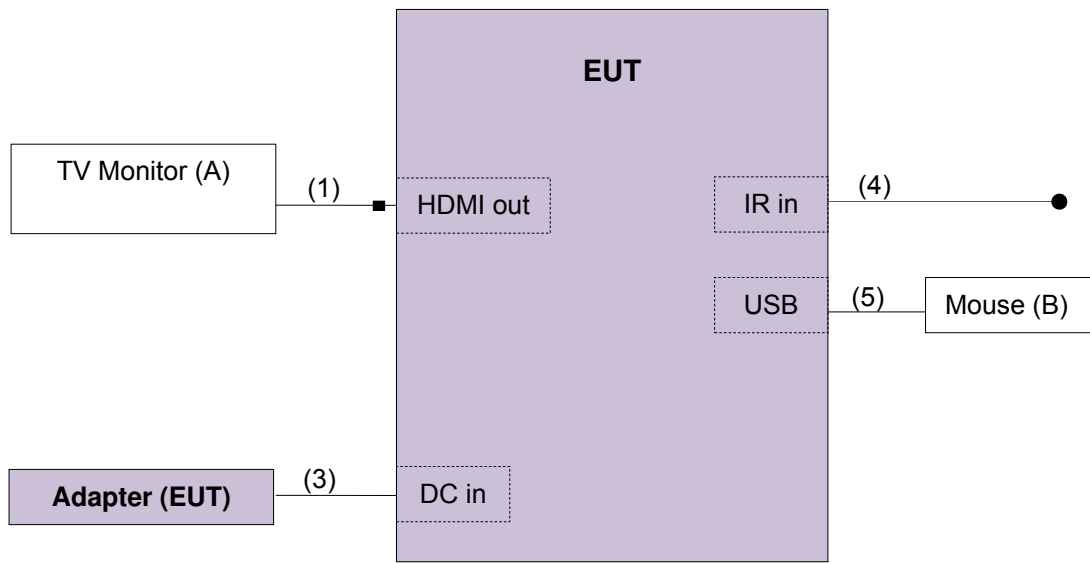

3.5 General Description of Applied Standards

The EUT is a RF Product. According to the specifications of the manufacturer, it must comply with the requirements of the following standards:

FCC Part 15, Subpart E (15.407)

789033 D02 General UNII Test Procedure New Rules v01r02

ANSI C63.10-2013

All test items have been performed and recorded as per the above standards.

Note: The EUT has been verified to comply with the requirements of FCC Part 15, Subpart B, Class B (DoC). The test report has been issued separately.

4 Test Types and Results

4.1 Radiated Emission and Bandedge Measurement

4.1.1 Limits of Radiated Emission and Bandedge Measurement

Radiated emissions which fall in the restricted bands must comply with the radiated emission limits specified as below table.

Frequencies (MHz)	Field Strength (microvolts/meter)	Measurement Distance (meters)
0.009 ~ 0.490	2400/F(kHz)	300
0.490 ~ 1.705	24000/F(kHz)	30
1.705 ~ 30.0	30	30
30 ~ 88	100	3
88 ~ 216	150	3
216 ~ 960	200	3
Above 960	500	3

Note:

1. The lower limit shall apply at the transition frequencies.
2. Emission level (dBuV/m) = 20 log Emission level (uV/m).
3. For frequencies above 1000MHz, the field strength limits are based on average detector, however, the peak field strength of any emission shall not exceed the maximum permitted average limits, specified above by more than 20dB under any condition of modulation.

LIMITS OF UNWANTED EMISSION OUT OF THE RESTRICTED BANDS

APPLICABLE TO	LIMIT	
789033 D02 General UNII Test Procedures New Rules v01r02	FIELD STRENGTH AT 3m	
	PK:74 (dBuV/m)	AV:54 (dBuV/m)
APPLICABLE TO	EIRP LIMIT	EQUIVALENT FIELD STRENGTH AT 3m
15.407(b)(1)	PK:-27 (dBm/MHz)	PK:68.2(dBuV/m)
15.407(b)(2)		
15.407(b)(3)		
15.407(b)(4)	PK:-27 (dBm/MHz) ^{*1} PK:-17 (dBm/MHz) ^{*2}	PK: 68.2(dBuV/m) ^{*1} PK:78.2 (dBuV/m) ^{*2}

Note: ^{*1}beyond 10MHz of the band edge ^{*2}within 10 MHz of band edge

The following formula is used to convert the equipment isotropic radiated power (eirp) to field strength:

$$E = \frac{1000000\sqrt{30P}}{3} \mu\text{V/m, where P is the eirp (Watts).$$

4.1.2 Test Instruments

Description & Manufacturer	Model No.	Serial No.	Cal. Date	Cal. Due
Test Receiver ROHDE & SCHWARZ	ESCI	100424	Oct. 12, 2015	Oct. 11, 2016
Spectrum Analyzer ROHDE & SCHWARZ	FSP40	100269	Mar. 30, 2015	Mar. 29, 2016
BILOG Antenna SCHWARZBECK	VULB9168	9168-148	Feb. 02, 2015	Feb. 01, 2016
HORN Antenna SCHWARZBECK	BBHA 9120 D	9120D-1169	Feb. 09, 2015	Feb. 08, 2016
HORN Antenna SCHWARZBECK	BBHA 9170	BBHA9170241	Feb. 09, 2015	Feb. 08, 2016
Preamplifier Agilent	8449B	3008A01911	Aug. 09, 2015	Aug. 08, 2016
Preamplifier Agilent	8447D	2944A10638	Aug. 09, 2015	Aug. 08, 2016
RF signal cable HUBER+SUHNER	SUCOFLEX 104	CABLE-CH9-02(309222 +248780)	Aug. 09, 2015	Aug. 08, 2016
RF signal cable HUBER+SUHNER	SUCOFLEX 104	CABLE-CH9-03(274092)	Aug. 09, 2015	Aug. 08, 2016
RF signal cable Woken	8D-FB	Cable-CH9-01	Aug. 11, 2015	Aug. 10, 2016
Software BV ADT	ADT_Radiated_ V7.6.15.9.4	NA	NA	NA
Antenna Tower EMCO	2070/2080	512.835.4684	NA	NA
Turn Table EMCO	2087-2.03	NA	NA	NA
Antenna Tower & Turn BV ADT	AT100	AT93021705	NA	NA
Turn Table BV ADT	TT100	TT93021705	NA	NA
Turn Table Controller BV ADT	SC100	SC93021705	NA	NA
26GHz ~ 40GHz Amplifier	EM26400	815221	Oct. 18, 2015	Oct. 17, 2016
High Speed Peak Power Meter	ML2495A	0824011	Jul. 09, 2015	Jul. 08, 2016
Power Sensor	MA2411B	0738171	Jul. 09, 2015	Jul. 08, 2016
WIT Standard Temperature And Humidity Chamber	TH-4S-C	W981030	Jun. 08, 2015	Jun. 07, 2016

- Note: 1. The calibration interval of the above test instruments is 12 months and the calibrations are traceable to NML/ROC and NIST/USA.
 2. The test was performed in HwaYa Chamber 9.
 3. The horn antenna and preamplifier (model: 8449B) are used only for the measurement of emission frequency above 1GHz if tested.
 4. The FCC Site Registration No. is 215374.
 5. The IC Site Registration No. is IC 7450F-9.

4.1.3 Test Procedures

- a. The EUT was placed on the top of a rotating table 0.8 meters (for below 1GHz) / 1.5 meters (for above 1GHz) above the ground at 3 meter chamber room for test. The table was rotated 360 degrees to determine the position of the highest radiation.
- b. The EUT was set 3 meters away from the interference-receiving antenna, which was mounted on the top of a variable-height antenna tower.
- c. The height of antenna is varied from one meter to four meters above the ground to determine the maximum value of the field strength. Both horizontal and vertical polarizations of the antenna are set to make the measurement.
- d. For each suspected emission, the EUT was arranged to its worst case and then the antenna was tuned to heights from 1 meter to 4 meters and the rotatable table was turned from 0 degrees to 360 degrees to find the maximum reading.
- e. The test-receiver system was set to quasi-peak detect function and specified bandwidth with maximum hold mode when the test frequency is below 1 GHz.
- f. The test-receiver system was set to peak and average detect function and specified bandwidth with maximum hold mode when the test frequency is above 1 GHz. If the peak reading value also meets average limit, measurement with the average detector is unnecessary.

Note:

1. The resolution bandwidth and video bandwidth of test receiver/spectrum analyzer is 120kHz for Quasi-peak detection (QP) at frequency below 1GHz.
2. The resolution bandwidth of test receiver/spectrum analyzer is 1 MHz and the video bandwidth is 3 MHz for Peak detection (PK) at frequency above 1GHz.
3. The resolution bandwidth of test receiver/spectrum analyzer is 1MHz and the video bandwidth is 3MHz for RMS Average (Duty cycle < 98%) for Average detection (AV) at frequency above 1GHz, then the measurement results was added to a correction factor ($10 \log(1/\text{duty cycle})$).
4. The resolution bandwidth of test receiver/spectrum analyzer is 1MHz and the video bandwidth is 10Hz (Duty cycle $\geq 98\%$) for Average detection (AV) at frequency above 1GHz.
5. All modes of operation were investigated and the worst-case emissions are reported.

4.1.4 Deviation from Test Standard

No deviation.

4.1.5 Test Set Up

<Frequency Range below 1GHz>

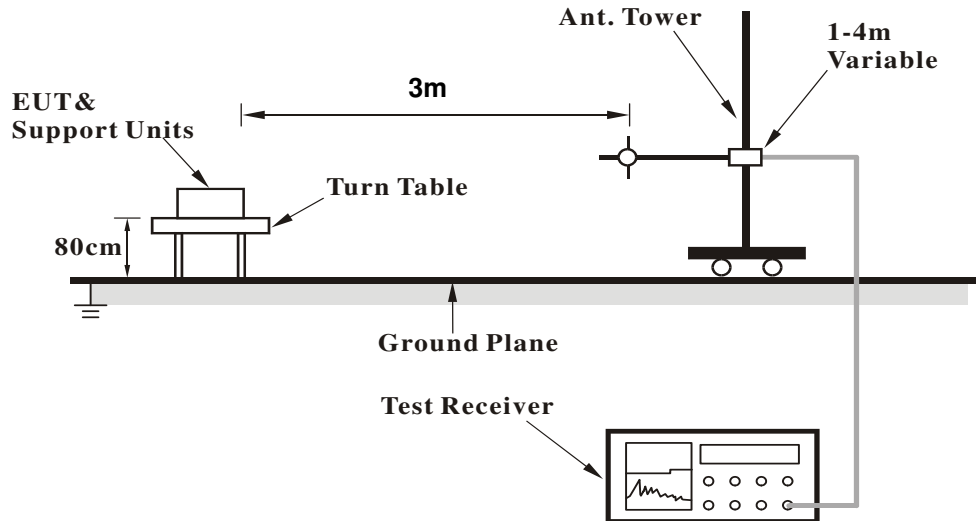

<Frequency Range above 1GHz>

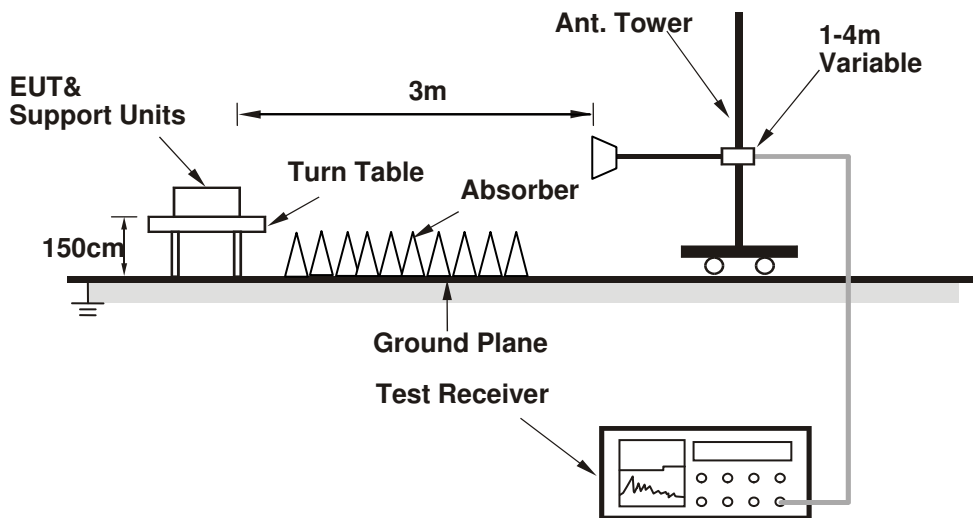

For the actual test configuration, please refer to the attached file (Test Setup Photo)

4.1.6 EUT Operating Conditions

Set the EUT under transmission condition continuously at specific channel frequency.

4.1.7 Test Results

Above 1GHz Data

WHDI (20MHz)

CHANNEL	TX Channel 36	DETECTOR FUNCTION	Peak (PK)
FREQUENCY RANGE	1GHz ~ 40GHz		Average (AV)

ANTENNA POLARITY & TEST DISTANCE: HORIZONTAL AT 3 M

NO.	FREQ. (MHz)	EMISSION LEVEL (dBuV/m)	LIMIT (dBuV/m)	MARGIN (dB)	ANTENNA HEIGHT (m)	TABLE ANGLE (Degree)	RAW VALUE (dBuV)	CORRECTION FACTOR (dB/m)
1	5150.00	55.5 PK	74.0	-18.5	1.60 H	100	50.50	5.00
2	5150.00	44.9 AV	54.0	-9.1	1.60 H	100	39.90	5.00
3	*5180.00	107.9 PK			1.57 H	98	68.80	39.10
4	*5180.00	95.0 AV			1.57 H	98	55.90	39.10
5	#10360.00	61.5 PK	74.0	-12.5	1.15 H	120	44.40	17.10
6	#10360.00	48.8 AV	54.0	-5.2	1.15 H	120	31.70	17.10

ANTENNA POLARITY & TEST DISTANCE: VERTICAL AT 3 M

NO.	FREQ. (MHz)	EMISSION LEVEL (dBuV/m)	LIMIT (dBuV/m)	MARGIN (dB)	ANTENNA HEIGHT (m)	TABLE ANGLE (Degree)	RAW VALUE (dBuV)	CORRECTION FACTOR (dB/m)
1	5150.00	57.0 PK	74.0	-17.0	1.03 V	36	52.00	5.00
2	5150.00	45.3 AV	54.0	-8.7	1.03 V	36	40.30	5.00
3	*5180.00	108.8 PK			1.00 V	32	69.70	39.10
4	*5180.00	96.3 AV			1.00 V	32	57.20	39.10
5	#10360.00	61.8 PK	74.0	-12.2	1.28 V	285	44.70	17.10
6	#10360.00	49.2 AV	54.0	-4.8	1.28 V	285	32.10	17.10

Remarks:

1. Emission Level(dBuV/m) = Raw Value(dBuV) + Correction Factor(dB/m)
2. Correction Factor(dB/m) = Antenna Factor(dB/m) + Cable Factor(dB)
3. The other emission levels were very low against the limit.
4. Margin value = Emission Level – Limit value
5. " * ": Fundamental frequency.
6. " # ": The radiated frequency is out of the restricted band.

CHANNEL	TX Channel 40	DETECTOR FUNCTION	Peak (PK)
FREQUENCY RANGE	1GHz ~ 40GHz		Average (AV)

ANTENNA POLARITY & TEST DISTANCE: HORIZONTAL AT 3 M

NO.	FREQ. (MHz)	EMISSION LEVEL (dBuV/m)	LIMIT (dBuV/m)	MARGIN (dB)	ANTENNA HEIGHT (m)	TABLE ANGLE (Degree)	RAW VALUE (dBuV)	CORRECTION FACTOR (dB/m)
1	*5200.00	107.4 PK			1.56 H	97	68.20	39.20
2	*5200.00	94.3 AV			1.56 H	97	55.10	39.20
3	#10400.00	59.7 PK	74.0	-14.3	2.45 H	263	42.40	17.30
4	#10400.00	48.3 AV	54.0	-5.7	2.45 H	263	31.00	17.30

ANTENNA POLARITY & TEST DISTANCE: VERTICAL AT 3 M

NO.	FREQ. (MHz)	EMISSION LEVEL (dBuV/m)	LIMIT (dBuV/m)	MARGIN (dB)	ANTENNA HEIGHT (m)	TABLE ANGLE (Degree)	RAW VALUE (dBuV)	CORRECTION FACTOR (dB/m)
1	*5200.00	108.5 PK			1.00 V	6	69.30	39.20
2	*5200.00	94.6 AV			1.00 V	6	55.40	39.20
3	#10400.00	59.8 PK	74.0	-14.2	2.13 V	254	42.50	17.30
4	#10400.00	48.1 AV	54.0	-5.9	2.13 V	254	30.80	17.30

Remarks:

1. Emission Level(dBuV/m) = Raw Value(dBuV) + Correction Factor(dB/m)
2. Correction Factor(dB/m) = Antenna Factor(dB/m) + Cable Factor(dB)
3. The other emission levels were very low against the limit.
4. Margin value = Emission Level – Limit value
5. " * ": Fundamental frequency.
6. " # ": The radiated frequency is out of the restricted band.

CHANNEL	TX Channel 48	DETECTOR FUNCTION	Peak (PK)
FREQUENCY RANGE	1GHz ~ 40GHz		Average (AV)

ANTENNA POLARITY & TEST DISTANCE: HORIZONTAL AT 3 M

NO.	FREQ. (MHz)	EMISSION LEVEL (dBuV/m)	LIMIT (dBuV/m)	MARGIN (dB)	ANTENNA HEIGHT (m)	TABLE ANGLE (Degree)	RAW VALUE (dBuV)	CORRECTION FACTOR (dB/m)
1	*5240.00	107.0 PK			1.22 H	97	67.80	39.20
2	*5240.00	95.5 AV			1.22 H	97	56.30	39.20
3	5350.00	56.0 PK	74.0	-18.0	1.25 H	100	50.60	5.40
4	5350.00	44.9 AV	54.0	-9.1	1.25 H	100	39.50	5.40
5	#10480.00	59.4 PK	74.0	-14.6	1.25 H	118	42.10	17.30
6	#10480.00	47.5 AV	54.0	-6.5	1.25 H	118	30.20	17.30

ANTENNA POLARITY & TEST DISTANCE: VERTICAL AT 3 M

NO.	FREQ. (MHz)	EMISSION LEVEL (dBuV/m)	LIMIT (dBuV/m)	MARGIN (dB)	ANTENNA HEIGHT (m)	TABLE ANGLE (Degree)	RAW VALUE (dBuV)	CORRECTION FACTOR (dB/m)
1	*5240.00	108.4 PK			1.00 V	5	69.20	39.20
2	*5240.00	94.7 AV			1.00 V	5	55.50	39.20
3	5350.00	57.0 PK	74.0	-17.0	1.05 V	10	51.60	5.40
4	5350.00	45.9 AV	54.0	-8.1	1.05 V	10	40.50	5.40
5	#10480.00	61.4 PK	74.0	-12.6	1.34 V	274	44.10	17.30
6	#10480.00	48.5 AV	54.0	-5.5	1.34 V	274	31.20	17.30

Remarks:

1. Emission Level(dBuV/m) = Raw Value(dBuV) + Correction Factor(dB/m)
2. Correction Factor(dB/m) = Antenna Factor(dB/m) + Cable Factor(dB)
3. The other emission levels were very low against the limit.
4. Margin value = Emission Level – Limit value
5. " * ": Fundamental frequency.
6. " # ": The radiated frequency is out of the restricted band.

CHANNEL	TX Channel 149	DETECTOR FUNCTION	Peak (PK)
FREQUENCY RANGE	1GHz ~ 40GHz		Average (AV)

ANTENNA POLARITY & TEST DISTANCE: HORIZONTAL AT 3 M

NO.	FREQ. (MHz)	EMISSION LEVEL (dBuV/m)	LIMIT (dBuV/m)	MARGIN (dB)	ANTENNA HEIGHT (m)	TABLE ANGLE (Degree)	RAW VALUE (dBuV)	CORRECTION FACTOR (dB/m)
1	#5714.90	57.4 PK	74.0	-16.6	1.00 H	92	51.40	6.00
2	#5714.90	44.2 AV	54.0	-9.8	1.00 H	92	38.20	6.00
3	#5722.90	61.4 PK	78.2	-16.8	1.00 H	92	55.30	6.10
4	#5725.00	54.0 PK	78.2	-24.2	1.00 H	92	47.90	6.10
5	*5745.00	108.2 PK			1.05 H	94	67.90	40.30
6	*5745.00	95.6 AV			1.05 H	94	55.30	40.30
7	11490.00	59.6 PK	74.0	-14.4	1.00 H	112	42.00	17.60
8	11490.00	48.9 AV	54.0	-5.1	1.00 H	112	31.30	17.60

ANTENNA POLARITY & TEST DISTANCE: VERTICAL AT 3 M

NO.	FREQ. (MHz)	EMISSION LEVEL (dBuV/m)	LIMIT (dBuV/m)	MARGIN (dB)	ANTENNA HEIGHT (m)	TABLE ANGLE (Degree)	RAW VALUE (dBuV)	CORRECTION FACTOR (dB/m)
1	#5714.90	62.7 PK	74.0	-11.3	1.17 V	120	56.70	6.00
2	#5714.90	48.1 AV	54.0	-5.9	1.17 V	120	42.10	6.00
3	#5722.90	63.9 PK	78.2	-14.3	1.17 V	120	57.80	6.10
4	#5725.00	55.5 PK	78.2	-22.7	1.17 V	120	49.40	6.10
5	*5745.00	110.5 PK			1.15 V	120	70.20	40.30
6	*5745.00	98.2 AV			1.15 V	120	57.90	40.30
7	11490.00	60.2 PK	74.0	-13.8	1.07 V	197	42.60	17.60
8	11490.00	49.1 AV	54.0	-4.9	1.07 V	197	31.50	17.60

Remarks:

1. Emission Level(dBuV/m) = Raw Value(dBuV) + Correction Factor(dB/m)
2. Correction Factor(dB/m) = Antenna Factor(dB/m) + Cable Factor(dB)
3. The other emission levels were very low against the limit.
4. Margin value = Emission Level – Limit value
5. " * ": Fundamental frequency.
6. " # ": The radiated frequency is out of the restricted band.

CHANNEL	TX Channel 157	DETECTOR FUNCTION	Peak (PK)
FREQUENCY RANGE	1GHz ~ 40GHz		Average (AV)

ANTENNA POLARITY & TEST DISTANCE: HORIZONTAL AT 3 M

NO.	FREQ. (MHz)	EMISSION LEVEL (dBuV/m)	LIMIT (dBuV/m)	MARGIN (dB)	ANTENNA HEIGHT (m)	TABLE ANGLE (Degree)	RAW VALUE (dBuV)	CORRECTION FACTOR (dB/m)
1	*5785.00	107.7 PK			1.00 H	96	67.40	40.30
2	*5785.00	95.4 AV			1.00 H	96	55.10	40.30
3	11570.00	59.5 PK	74.0	-14.5	1.00 H	111	42.00	17.50
4	11570.00	48.6 AV	54.0	-5.4	1.00 H	111	31.10	17.50

ANTENNA POLARITY & TEST DISTANCE: VERTICAL AT 3 M

NO.	FREQ. (MHz)	EMISSION LEVEL (dBuV/m)	LIMIT (dBuV/m)	MARGIN (dB)	ANTENNA HEIGHT (m)	TABLE ANGLE (Degree)	RAW VALUE (dBuV)	CORRECTION FACTOR (dB/m)
1	*5785.00	110.1 PK			1.08 V	122	69.80	40.30
2	*5785.00	97.5 AV			1.08 V	122	57.20	40.30
3	11570.00	59.9 PK	74.0	-14.1	1.01 V	195	42.40	17.50
4	11570.00	48.9 AV	54.0	-5.1	1.01 V	195	31.40	17.50

Remarks:

1. Emission Level(dBuV/m) = Raw Value(dBuV) + Correction Factor(dB/m)
2. Correction Factor(dB/m) = Antenna Factor(dB/m) + Cable Factor(dB)
3. The other emission levels were very low against the limit.
4. Margin value = Emission Level – Limit value
5. " * ": Fundamental frequency.

CHANNEL	TX Channel 165	DETECTOR FUNCTION	Peak (PK)
FREQUENCY RANGE	1GHz ~ 40GHz		Average (AV)

ANTENNA POLARITY & TEST DISTANCE: HORIZONTAL AT 3 M								
NO.	FREQ. (MHz)	EMISSION LEVEL (dBuV/m)	LIMIT (dBuV/m)	MARGIN (dB)	ANTENNA HEIGHT (m)	TABLE ANGLE (Degree)	RAW VALUE (dBuV)	CORRECTION FACTOR (dB/m)
1	*5825.00	107.0 PK			1.91 H	91	66.60	40.40
2	*5825.00	94.7 AV			1.91 H	91	54.30	40.40
3	#5850.00	53.4 PK	78.2	-24.8	1.88 H	102	47.00	6.40
4	#5853.00	58.4 PK	78.2	10.2	1.92 H	105	52.00	6.40
5	#5861.00	57.6 PK	74.0	-16.4	1.85 H	100	51.20	6.40
6	#5861.00	46.9 AV	54.0	-7.1	1.85 H	100	40.50	6.40
7	11650.00	59.9 PK	74.0	-14.1	1.00 H	63	42.60	17.30
8	11650.00	49.9 AV	54.0	-4.1	1.00 H	63	32.60	17.30

ANTENNA POLARITY & TEST DISTANCE: VERTICAL AT 3 M								
NO.	FREQ. (MHz)	EMISSION LEVEL (dBuV/m)	LIMIT (dBuV/m)	MARGIN (dB)	ANTENNA HEIGHT (m)	TABLE ANGLE (Degree)	RAW VALUE (dBuV)	CORRECTION FACTOR (dB/m)
1	*5825.00	108.4 PK			2.06 V	186	68.00	40.40
2	*5825.00	97.1 AV			2.06 V	186	56.70	40.40
3	#5850.00	56.7 PK	78.2	-21.5	1.98 V	182	50.30	6.40
4	#5853.00	60.0 PK	78.2	-18.2	2.01 V	187	53.60	6.40
5	#5861.00	59.0 PK	74.0	-15.0	2.10 V	185	52.60	6.40
6	#5861.00	47.7 AV	54.0	-6.3	2.10 V	185	41.30	6.40
7	11650.00	60.6 PK	74.0	-13.4	1.29 V	87	43.30	17.30
8	11650.00	49.7 AV	54.0	-4.3	1.29 V	87	32.40	17.30

Remarks:

1. Emission Level(dBuV/m) = Raw Value(dBuV) + Correction Factor(dB/m)
2. Correction Factor(dB/m) = Antenna Factor(dB/m) + Cable Factor(dB)
3. The other emission levels were very low against the limit.
4. Margin value = Emission Level – Limit value
5. " * ": Fundamental frequency.
6. " # ": The radiated frequency is out of the restricted band.

WHDI (40MHz)

CHANNEL	TX Channel 38	DETECTOR FUNCTION	Peak (PK)
FREQUENCY RANGE	1GHz ~ 40GHz		Average (AV)

ANTENNA POLARITY & TEST DISTANCE: HORIZONTAL AT 3 M								
NO.	FREQ. (MHz)	EMISSION LEVEL (dBuV/m)	LIMIT (dBuV/m)	MARGIN (dB)	ANTENNA HEIGHT (m)	TABLE ANGLE (Degree)	RAW VALUE (dBuV)	CORRECTION FACTOR (dB/m)
1	5150.00	58.7 PK	74.0	-15.3	1.23 H	68	54.80	3.90
2	5150.00	45.5 AV	54.0	-8.5	1.23 H	68	41.60	3.90
3	*5190.00	102.2 PK			1.18 H	68	60.70	41.50
4	*5190.00	88.9 AV			1.18 H	68	47.40	41.50
5	#10380.00	60.9 PK	74.0	-13.1	1.09 H	10	45.50	15.40
6	#10380.00	48.3 AV	54.0	-5.7	1.09 H	10	32.90	15.40

ANTENNA POLARITY & TEST DISTANCE: VERTICAL AT 3 M								
NO.	FREQ. (MHz)	EMISSION LEVEL (dBuV/m)	LIMIT (dBuV/m)	MARGIN (dB)	ANTENNA HEIGHT (m)	TABLE ANGLE (Degree)	RAW VALUE (dBuV)	CORRECTION FACTOR (dB/m)
1	5150.00	59.6 PK	74.0	-14.4	1.04 V	350	55.70	3.90
2	5150.00	46.7 AV	54.0	-7.3	1.04 V	350	42.80	3.90
3	*5190.00	103.8 PK			1.04 V	350	62.30	41.50
4	*5190.00	91.0 AV			1.04 V	350	49.50	41.50
5	#10380.00	60.5 PK	74.0	-13.5	1.19 V	183	45.10	15.40
6	#10380.00	48.2 AV	54.0	-5.8	1.19 V	183	32.80	15.40

Remarks:

1. Emission Level(dBuV/m) = Raw Value(dBuV) + Correction Factor(dB/m)
2. Correction Factor(dB/m) = Antenna Factor(dB/m) + Cable Factor(dB)
3. The other emission levels were very low against the limit.
4. Margin value = Emission Level – Limit value
5. " * ": Fundamental frequency.
6. " # ": The radiated frequency is out of the restricted band.

CHANNEL	TX Channel 46	DETECTOR FUNCTION	Peak (PK)
FREQUENCY RANGE	1GHz ~ 40GHz		Average (AV)

ANTENNA POLARITY & TEST DISTANCE: HORIZONTAL AT 3 M

NO.	FREQ. (MHz)	EMISSION LEVEL (dBuV/m)	LIMIT (dBuV/m)	MARGIN (dB)	ANTENNA HEIGHT (m)	TABLE ANGLE (Degree)	RAW VALUE (dBuV)	CORRECTION FACTOR (dB/m)
1	*5230.00	104.6 PK			1.01 H	269	63.00	41.60
2	*5230.00	92.1 AV			1.01 H	269	50.50	41.60
3	5350.00	58.8 PK	74.0	-15.2	1.01 H	269	54.80	4.00
4	5350.00	45.8 AV	54.0	-8.2	1.01 H	269	41.80	4.00
5	#10460.00	61.2 PK	74.0	-12.8	1.08 H	13	45.70	15.50
6	#10460.00	48.0 AV	54.0	-6.0	1.08 H	13	32.50	15.50

ANTENNA POLARITY & TEST DISTANCE: VERTICAL AT 3 M

NO.	FREQ. (MHz)	EMISSION LEVEL (dBuV/m)	LIMIT (dBuV/m)	MARGIN (dB)	ANTENNA HEIGHT (m)	TABLE ANGLE (Degree)	RAW VALUE (dBuV)	CORRECTION FACTOR (dB/m)
1	*5230.00	104.7 PK			1.21 V	348	63.10	41.60
2	*5230.00	92.2 AV			1.21 V	348	50.60	41.60
3	5350.00	59.2 PK	74.0	-14.8	1.21 V	348	55.20	4.00
4	5350.00	46.8 AV	54.0	-7.2	1.21 V	348	42.80	4.00
5	#10460.00	60.9 PK	74.0	-13.1	1.14 V	189	45.40	15.50
6	#10460.00	48.2 AV	54.0	-5.8	1.14 V	189	32.70	15.50

Remarks:

1. Emission Level(dBuV/m) = Raw Value(dBuV) + Correction Factor(dB/m)
2. Correction Factor(dB/m) = Antenna Factor(dB/m) + Cable Factor(dB)
3. The other emission levels were very low against the limit.
4. Margin value = Emission Level – Limit value
5. " * ": Fundamental frequency.
6. " # ": The radiated frequency is out of the restricted band.

CHANNEL	TX Channel 54	DETECTOR FUNCTION	Peak (PK)
FREQUENCY RANGE	1GHz ~ 40GHz		Average (AV)

ANTENNA POLARITY & TEST DISTANCE: HORIZONTAL AT 3 M								
NO.	FREQ. (MHz)	EMISSION LEVEL (dBuV/m)	LIMIT (dBuV/m)	MARGIN (dB)	ANTENNA HEIGHT (m)	TABLE ANGLE (Degree)	RAW VALUE (dBuV)	CORRECTION FACTOR (dB/m)
1	5150.00	62.3 PK	74.0	-11.7	1.51 H	116	57.30	5.00
2	5150.00	43.8 AV	54.0	-10.2	1.51 H	116	38.80	5.00
3	*5270.00	104.7 PK			1.59 H	119	65.50	39.20
4	*5270.00	92.9 AV			1.59 H	119	53.70	39.20
5	#10540.00	58.2 PK	74.0	-15.8	1.00 H	115	40.70	17.50
6	#10540.00	47.6 AV	54.0	-6.4	1.00 H	115	30.10	17.50
ANTENNA POLARITY & TEST DISTANCE: VERTICAL AT 3 M								
NO.	FREQ. (MHz)	EMISSION LEVEL (dBuV/m)	LIMIT (dBuV/m)	MARGIN (dB)	ANTENNA HEIGHT (m)	TABLE ANGLE (Degree)	RAW VALUE (dBuV)	CORRECTION FACTOR (dB/m)
1	5150.00	62.6 PK	74.0	-11.4	1.54 V	150	57.60	5.00
2	5150.00	44.8 AV	54.0	-9.2	1.54 V	150	39.80	5.00
3	*5270.00	106.7 PK			1.59 V	153	67.50	39.20
4	*5270.00	94.4 AV			1.59 V	153	55.20	39.20
5	#10540.00	59.3 PK	74.0	-14.7	1.04 V	194	41.80	17.50
6	#10540.00	47.8 AV	54.0	-6.2	1.04 V	194	30.30	17.50

Remarks:

1. Emission Level(dBuV/m) = Raw Value(dBuV) + Correction Factor(dB/m)
2. Correction Factor(dB/m) = Antenna Factor(dB/m) + Cable Factor(dB)
3. The other emission levels were very low against the limit.
4. Margin value = Emission Level – Limit value
5. " * ": Fundamental frequency.
6. " # ": The radiated frequency is out of the restricted band.

CHANNEL	TX Channel 62	DETECTOR FUNCTION	Peak (PK)
FREQUENCY RANGE	1GHz ~ 40GHz		Average (AV)

ANTENNA POLARITY & TEST DISTANCE: HORIZONTAL AT 3 M								
NO.	FREQ. (MHz)	EMISSION LEVEL (dBuV/m)	LIMIT (dBuV/m)	MARGIN (dB)	ANTENNA HEIGHT (m)	TABLE ANGLE (Degree)	RAW VALUE (dBuV)	CORRECTION FACTOR (dB/m)
1	*5310.00	102.5 PK			1.00 H	80	63.20	39.30
2	*5310.00	90.9 AV			1.00 H	80	51.60	39.30
3	5350.00	62.4 PK	74.0	-11.6	1.00 H	79	57.00	5.40
4	5350.00	44.6 AV	54.0	-9.4	1.00 H	79	39.20	5.40
5	10620.00	58.7 PK	74.0	-15.3	1.00 H	117	41.00	17.70
6	10620.00	48.5 AV	54.0	-5.5	1.00 H	117	30.80	17.70
ANTENNA POLARITY & TEST DISTANCE: VERTICAL AT 3 M								
NO.	FREQ. (MHz)	EMISSION LEVEL (dBuV/m)	LIMIT (dBuV/m)	MARGIN (dB)	ANTENNA HEIGHT (m)	TABLE ANGLE (Degree)	RAW VALUE (dBuV)	CORRECTION FACTOR (dB/m)
1	*5310.00	107.9 PK			1.59 V	160	68.60	39.30
2	*5310.00	94.9 AV			1.59 V	160	55.60	39.30
3	5350.00	62.9 PK	74.0	-11.1	1.51 V	156	57.50	5.40
4	5350.00	45.0 AV	54.0	-9.0	1.51 V	156	39.60	5.40
5	10620.00	59.4 PK	74.0	-14.6	1.05 V	197	41.70	17.70
6	10620.00	48.6 AV	54.0	-5.4	1.05 V	197	30.90	17.70

Remarks:

1. Emission Level(dBuV/m) = Raw Value(dBuV) + Correction Factor(dB/m)
2. Correction Factor(dB/m) = Antenna Factor(dB/m) + Cable Factor(dB)
3. The other emission levels were very low against the limit.
4. Margin value = Emission Level – Limit value
5. " * ": Fundamental frequency.

CHANNEL	TX Channel 102	DETECTOR FUNCTION	Peak (PK)
FREQUENCY RANGE	1GHz ~ 40GHz		Average (AV)

ANTENNA POLARITY & TEST DISTANCE: HORIZONTAL AT 3 M

NO.	FREQ. (MHz)	EMISSION LEVEL (dBuV/m)	LIMIT (dBuV/m)	MARGIN (dB)	ANTENNA HEIGHT (m)	TABLE ANGLE (Degree)	RAW VALUE (dBuV)	CORRECTION FACTOR (dB/m)
1	5460.00	57.3 PK	74.0	-16.7	1.06 H	91	51.70	5.60
2	5460.00	44.1 AV	54.0	-9.9	1.06 H	91	38.50	5.60
3	#5470.00	57.6 PK	74.0	-16.4	1.06 H	91	51.90	5.70
4	#5470.00	44.4 AV	54.0	-9.6	1.06 H	91	38.70	5.70
5	*5510.00	104.7 PK			1.10 H	90	65.00	39.70
6	*5510.00	92.1 AV			1.10 H	90	52.40	39.70
7	11020.00	57.7 PK	74.0	-16.3	1.00 H	115	39.20	18.50
8	11020.00	46.6 AV	54.0	-7.4	1.00 H	115	28.10	18.50

ANTENNA POLARITY & TEST DISTANCE: VERTICAL AT 3 M

NO.	FREQ. (MHz)	EMISSION LEVEL (dBuV/m)	LIMIT (dBuV/m)	MARGIN (dB)	ANTENNA HEIGHT (m)	TABLE ANGLE (Degree)	RAW VALUE (dBuV)	CORRECTION FACTOR (dB/m)
1	5460.00	61.8 PK	74.0	-12.2	1.03 V	119	56.20	5.60
2	5460.00	45.1 AV	54.0	-8.9	1.03 V	119	39.50	5.60
3	#5470.00	67.6 PK	74.0	-6.4	1.03 V	119	61.90	5.70
4	#5470.00	47.6 AV	54.0	-6.4	1.03 V	119	41.90	5.70
5	*5510.00	108.1 PK			1.05 V	118	68.40	39.70
6	*5510.00	95.8 AV			1.05 V	118	56.10	39.70
7	11020.00	58.9 PK	74.0	-15.1	1.02 V	196	40.40	18.50
8	11020.00	47.3 AV	54.0	-6.7	1.02 V	196	28.80	18.50

Remarks:

1. Emission Level(dBuV/m) = Raw Value(dBuV) + Correction Factor(dB/m)
2. Correction Factor(dB/m) = Antenna Factor(dB/m) + Cable Factor(dB)
3. The other emission levels were very low against the limit.
4. Margin value = Emission Level – Limit value
5. " * ": Fundamental frequency.
6. " # ": The radiated frequency is out of the restricted band.

CHANNEL	TX Channel 110	DETECTOR FUNCTION	Peak (PK)
FREQUENCY RANGE	1GHz ~ 40GHz		Average (AV)

ANTENNA POLARITY & TEST DISTANCE: HORIZONTAL AT 3 M

NO.	FREQ. (MHz)	EMISSION LEVEL (dBuV/m)	LIMIT (dBuV/m)	MARGIN (dB)	ANTENNA HEIGHT (m)	TABLE ANGLE (Degree)	RAW VALUE (dBuV)	CORRECTION FACTOR (dB/m)
1	*5550.00	103.7 PK			1.00 H	89	63.90	39.80
2	*5550.00	91.8 AV			1.00 H	89	52.00	39.80
3	11100.00	58.0 PK	74.0	-16.0	1.00 H	116	39.60	18.40
4	11100.00	47.2 AV	54.0	-6.8	1.00 H	116	28.80	18.40

ANTENNA POLARITY & TEST DISTANCE: VERTICAL AT 3 M

NO.	FREQ. (MHz)	EMISSION LEVEL (dBuV/m)	LIMIT (dBuV/m)	MARGIN (dB)	ANTENNA HEIGHT (m)	TABLE ANGLE (Degree)	RAW VALUE (dBuV)	CORRECTION FACTOR (dB/m)
1	*5550.00	107.4 PK			1.12 V	120	67.60	39.80
2	*5550.00	95.0 AV			1.12 V	120	55.20	39.80
3	11100.00	59.1 PK	74.0	-14.9	1.01 V	191	40.70	18.40
4	11100.00	47.5 AV	54.0	-6.5	1.01 V	191	29.10	18.40

Remarks:

1. Emission Level(dBuV/m) = Raw Value(dBuV) + Correction Factor(dB/m)
2. Correction Factor(dB/m) = Antenna Factor(dB/m) + Cable Factor(dB)
3. The other emission levels were very low against the limit.
4. Margin value = Emission Level – Limit value
5. " * ": Fundamental frequency.

CHANNEL	TX Channel 134	DETECTOR FUNCTION	Peak (PK)
FREQUENCY RANGE	1GHz ~ 40GHz		Average (AV)

ANTENNA POLARITY & TEST DISTANCE: HORIZONTAL AT 3 M								
NO.	FREQ. (MHz)	EMISSION LEVEL (dBuV/m)	LIMIT (dBuV/m)	MARGIN (dB)	ANTENNA HEIGHT (m)	TABLE ANGLE (Degree)	RAW VALUE (dBuV)	CORRECTION FACTOR (dB/m)
1	*5670.00	104.5 PK			1.00 H	94	64.40	40.10
2	*5670.00	92.2 AV			1.00 H	94	52.10	40.10
3	#5725.00	57.9 PK	74.0	-16.1	1.00 H	99	51.80	6.10
4	#5725.00	44.5 AV	54.0	-9.5	1.00 H	99	38.40	6.10
5	11340.00	57.8 PK	74.0	-16.2	1.00 H	119	39.20	18.60
6	11340.00	46.4 AV	54.0	-7.6	1.00 H	119	27.80	18.60
ANTENNA POLARITY & TEST DISTANCE: VERTICAL AT 3 M								
NO.	FREQ. (MHz)	EMISSION LEVEL (dBuV/m)	LIMIT (dBuV/m)	MARGIN (dB)	ANTENNA HEIGHT (m)	TABLE ANGLE (Degree)	RAW VALUE (dBuV)	CORRECTION FACTOR (dB/m)
1	*5670.00	107.1 PK			1.09 V	117	67.00	40.10
2	*5670.00	94.7 AV			1.09 V	117	54.60	40.10
3	#5725.00	58.1 PK	74.0	-15.9	1.01 V	111	52.00	6.10
4	#5725.00	44.8 AV	54.0	-9.2	1.01 V	111	38.70	6.10
5	11340.00	58.8 PK	74.0	-15.2	1.02 V	190	40.20	18.60
6	11340.00	47.1 AV	54.0	-6.9	1.02 V	190	28.50	18.60

Remarks:

1. Emission Level(dBuV/m) = Raw Value(dBuV) + Correction Factor(dB/m)
2. Correction Factor(dB/m) = Antenna Factor(dB/m) + Cable Factor(dB)
3. The other emission levels were very low against the limit.
4. Margin value = Emission Level – Limit value
5. " * ": Fundamental frequency.
6. " # ": The radiated frequency is out of the restricted band.

CHANNEL	TX Channel 151	DETECTOR FUNCTION	Peak (PK)
FREQUENCY RANGE	1GHz ~ 40GHz		Average (AV)

ANTENNA POLARITY & TEST DISTANCE: HORIZONTAL AT 3 M

NO.	FREQ. (MHz)	EMISSION LEVEL (dBuV/m)	LIMIT (dBuV/m)	MARGIN (dB)	ANTENNA HEIGHT (m)	TABLE ANGLE (Degree)	RAW VALUE (dBuV)	CORRECTION FACTOR (dB/m)
1	#5714.90	65.1 PK	74.0	-8.9	1.27 H	266	60.70	4.40
2	#5714.90	48.5 AV	54.0	-5.5	1.27 H	266	44.10	4.40
3	#5722.90	70.5 PK	78.2	-7.7	1.27 H	266	66.10	4.40
4	#5725.00	54.1 PK	78.2	-24.1	1.27 H	266	49.70	4.40
5	*5755.00	106.4 PK			1.27 H	266	64.20	42.20
6	*5755.00	93.3 AV			1.27 H	266	51.10	42.20
7	11510.00	60.6 PK	74.0	-13.4	1.23 H	260	45.40	15.20
8	11510.00	48.5 AV	54.0	-5.5	1.23 H	260	33.30	15.20

ANTENNA POLARITY & TEST DISTANCE: VERTICAL AT 3 M

NO.	FREQ. (MHz)	EMISSION LEVEL (dBuV/m)	LIMIT (dBuV/m)	MARGIN (dB)	ANTENNA HEIGHT (m)	TABLE ANGLE (Degree)	RAW VALUE (dBuV)	CORRECTION FACTOR (dB/m)
1	#5714.90	66.6 PK	74.0	-7.4	1.10 V	301	62.20	4.40
2	#5714.90	49.5 AV	54.0	-4.5	1.10 V	301	45.10	4.40
3	#5722.90	72.3 PK	78.2	-5.9	1.10 V	301	67.90	4.40
4	#5725.00	55.7 PK	78.2	-22.5	1.10 V	301	51.30	4.40
5	*5755.00	107.3 PK			1.10 V	301	65.10	42.20
6	*5755.00	94.4 AV			1.10 V	301	52.20	42.20
7	11510.00	60.2 PK	74.0	-13.8	1.15 V	294	45.00	15.20
8	11510.00	47.5 AV	54.0	-6.5	1.15 V	294	32.30	15.20

Remarks:

1. Emission Level(dBuV/m) = Raw Value(dBuV) + Correction Factor(dB/m)
2. Correction Factor(dB/m) = Antenna Factor(dB/m) + Cable Factor(dB)
3. The other emission levels were very low against the limit.
4. Margin value = Emission Level – Limit value
5. " * ": Fundamental frequency.
6. " # ": The radiated frequency is out of the restricted band.

CHANNEL	TX Channel 159	DETECTOR FUNCTION	Peak (PK)
FREQUENCY RANGE	1GHz ~ 40GHz		Average (AV)

ANTENNA POLARITY & TEST DISTANCE: HORIZONTAL AT 3 M

NO.	FREQ. (MHz)	EMISSION LEVEL (dBuV/m)	LIMIT (dBuV/m)	MARGIN (dB)	ANTENNA HEIGHT (m)	TABLE ANGLE (Degree)	RAW VALUE (dBuV)	CORRECTION FACTOR (dB/m)
1	*5795.00	104.5 PK			1.17 H	247	62.20	42.30
2	*5795.00	92.1 AV			1.17 H	247	49.80	42.30
3	#5850.00	45.8 PK	78.2	-32.4	1.17 H	247	41.10	4.70
4	#5852.10	60.0 PK	78.2	-18.2	1.17 H	247	55.30	4.70
5	#5860.10	58.6 PK	74.0	-15.4	1.17 H	247	53.90	4.70
6	#5860.10	45.8 AV	54.0	-8.2	1.17 H	247	41.10	4.70
7	11590.00	60.2 PK	74.0	-13.8	1.24 H	268	45.10	15.10
8	11590.00	48.5 AV	54.0	-5.5	1.24 H	268	33.40	15.10

ANTENNA POLARITY & TEST DISTANCE: VERTICAL AT 3 M

NO.	FREQ. (MHz)	EMISSION LEVEL (dBuV/m)	LIMIT (dBuV/m)	MARGIN (dB)	ANTENNA HEIGHT (m)	TABLE ANGLE (Degree)	RAW VALUE (dBuV)	CORRECTION FACTOR (dB/m)
1	*5795.00	107.0 PK			1.10 V	261	64.70	42.30
2	*5795.00	94.4 AV			1.10 V	261	52.10	42.30
3	#5850.00	45.9 PK	78.2	-32.3	1.10 V	261	41.20	4.70
4	#5852.10	59.7 PK	78.2	-18.5	1.10 V	261	55.00	4.70
5	#5860.10	58.8 PK	74.0	-15.2	1.10 V	261	54.10	4.70
6	#5860.10	46.7 AV	54.0	-7.3	1.10 V	261	42.00	4.70
7	11590.00	59.3 PK	74.0	-14.7	1.10 V	284	44.20	15.10
8	11590.00	47.7 AV	54.0	-6.3	1.10 V	284	32.60	15.10

Remarks:

1. Emission Level(dBuV/m) = Raw Value(dBuV) + Correction Factor(dB/m)
2. Correction Factor(dB/m) = Antenna Factor(dB/m) + Cable Factor(dB)
3. The other emission levels were very low against the limit.
4. Margin value = Emission Level – Limit value
5. " * ": Fundamental frequency.
6. " # ": The radiated frequency is out of the restricted band.

Below 1GHz Data:

WHDI (40MHz)

CHANNEL	TX Channel 46	DETECTOR FUNCTION	Quasi-Peak (QP)
FREQUENCY RANGE	30MHz ~ 1GHz		
TEST MODE	A		

ANTENNA POLARITY & TEST DISTANCE: HORIZONTAL AT 3 M

NO.	FREQ. (MHz)	EMISSION LEVEL (dBuV/m)	LIMIT (dBuV/m)	MARGIN (dB)	ANTENNA HEIGHT (m)	TABLE ANGLE (Degree)	RAW VALUE (dBuV)	CORRECTION FACTOR (dB/m)
1	30.00	32.7 QP	40.0	-7.3	1.24 H	209	48.30	-15.60
2	45.52	33.6 QP	40.0	-6.4	2.00 H	167	48.00	-14.40
3	173.56	25.4 QP	43.5	-18.1	1.00 H	295	39.60	-14.20
4	239.52	26.5 QP	46.0	-19.5	1.00 H	294	41.40	-14.90
5	297.72	28.6 QP	46.0	-17.4	1.00 H	280	41.20	-12.60
6	967.02	33.0 QP	54.0	-21.0	1.00 H	11	32.70	0.30

ANTENNA POLARITY & TEST DISTANCE: VERTICAL AT 3 M

NO.	FREQ. (MHz)	EMISSION LEVEL (dBuV/m)	LIMIT (dBuV/m)	MARGIN (dB)	ANTENNA HEIGHT (m)	TABLE ANGLE (Degree)	RAW VALUE (dBuV)	CORRECTION FACTOR (dB/m)
1	31.33	30.2 QP	40.0	-9.8	1.11 V	199	46.20	-16.00
2	64.92	34.4 QP	40.0	-5.6	1.50 V	157	49.50	-15.10
3	121.18	21.6 QP	43.5	-21.9	1.24 V	7	37.80	-16.20
4	161.92	23.0 QP	43.5	-20.5	1.00 V	219	36.80	-13.80
5	425.76	26.3 QP	46.0	-19.7	1.24 V	334	35.90	-9.60
6	895.24	31.6 QP	46.0	-14.4	1.50 V	15	32.90	-1.30

Remarks:

1. Emission Level(dBuV/m) = Raw Value(dBuV) + Correction Factor(dB/m)
2. Correction Factor(dB/m) = Antenna Factor(dB/m) + Cable Factor(dB)
3. The other emission levels were very low against the limit.
4. Margin value = Emission Level – Limit value

CHANNEL	TX Channel 46	DETECTOR FUNCTION	Quasi-Peak (QP)
FREQUENCY RANGE	30MHz ~ 1GHz		
TEST MODE	B		

ANTENNA POLARITY & TEST DISTANCE: HORIZONTAL AT 3 M

NO.	FREQ. (MHz)	EMISSION LEVEL (dBuV/m)	LIMIT (dBuV/m)	MARGIN (dB)	ANTENNA HEIGHT (m)	TABLE ANGLE (Degree)	RAW VALUE (dBuV)	CORRECTION FACTOR (dB/m)
1	34.55	23.9 QP	40.0	-16.1	1.52 H	299	39.50	-15.60
2	94.02	23.1 QP	43.5	-20.4	2.00 H	184	42.30	-19.20
3	175.50	27.8 QP	43.5	-15.7	1.26 H	311	42.20	-14.40
4	239.52	28.2 QP	46.0	-17.8	1.00 H	300	43.10	-14.90
5	288.02	27.3 QP	46.0	-18.7	1.00 H	298	40.10	-12.80
6	928.22	31.3 QP	46.0	-14.7	1.00 H	34	31.80	-0.50

ANTENNA POLARITY & TEST DISTANCE: VERTICAL AT 3 M

NO.	FREQ. (MHz)	EMISSION LEVEL (dBuV/m)	LIMIT (dBuV/m)	MARGIN (dB)	ANTENNA HEIGHT (m)	TABLE ANGLE (Degree)	RAW VALUE (dBuV)	CORRECTION FACTOR (dB/m)
1	31.94	35.4 QP	40.0	-4.6	1.24 V	213	51.60	-16.20
2	47.46	21.2 QP	40.0	-18.8	1.00 V	76	35.40	-14.20
3	173.56	23.2 QP	43.5	-20.3	1.00 V	350	37.40	-14.20
4	282.20	26.4 QP	46.0	-19.6	1.24 V	229	39.30	-12.90
5	441.28	26.3 QP	46.0	-19.7	1.24 V	7	35.60	-9.30
6	928.22	31.5 QP	46.0	-14.5	1.49 V	10	32.00	-0.50

Remarks:

1. Emission Level(dBuV/m) = Raw Value(dBuV) + Correction Factor(dB/m)
2. Correction Factor(dB/m) = Antenna Factor(dB/m) + Cable Factor(dB)
3. The other emission levels were very low against the limit.
4. Margin value = Emission Level – Limit value

4.2 Conducted Emission Measurement

4.2.1 Limits of Conducted Emission Measurement

Frequency (MHz)	Conducted Limit (dBuV)	
	Quasi-peak	Average
0.15 - 0.5	66 - 56	56 - 46
0.50 - 5.0	56	46
5.0 - 30.0	60	50

Note: 1.

4.2.4 Deviation from Test Standard

No deviation.

4.2.5 Test Setup

4.2.7 Test Results

WHDI (40MHz)

Phase	Line (L)	Detector Function	Quasi-Peak (QP) / Average (AV)
Channel	TX Channel 46	Test Mode	A

No	Freq. [MHz]	Corr. Factor (dB)	Reading Value [dB (uV)]		Emission Level [dB (uV)]		Limit [dB (uV)]		Margin (dB)	
			Q.P.	AV.	Q.P.	AV.	Q.P.	AV.	Q.P.	AV.
			1	0.15760	9.82	22.53	11.76	32.35	21.58	65.59
2	0.18122	9.83	19.91	1.19	29.74	11.02	64.43	54.43	-34.69	-43.41
3	0.22820	9.85	16.48	11.43	26.33	21.28	62.51	52.51	-36.19	-31.24
4	0.31021	9.86	14.97	4.94	24.83	14.80	59.96	49.96	-35.13	-35.16
5	0.60737	9.90	3.02	-3.00	12.92	6.90	56.00	46.00	-43.08	-39.10
6	10.90641	10.56	4.92	-3.35	15.48	7.21	60.00	50.00	-44.52	-42.79

Remarks:

1. Q.P. and AV. are abbreviations of quasi-peak and average individually.
2. The emission levels of other frequencies were very low against the limit.
3. Margin value = Emission level - Limit value
4. Correction factor = Insertion loss + Cable loss
5. Emission Level = Correction Factor + Reading Value.

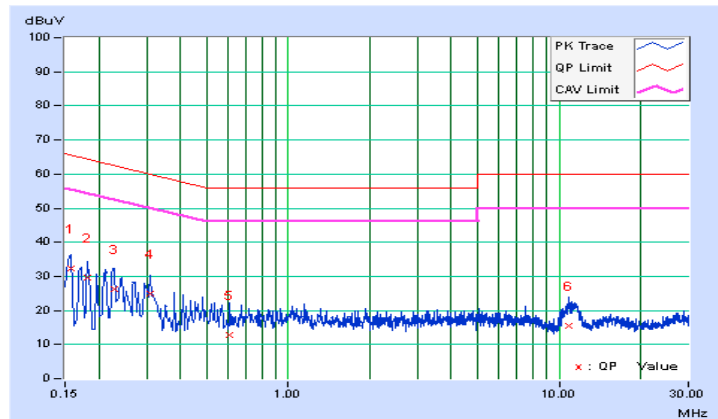

Phase	Neutral (N)	Detector Function	Quasi-Peak (QP) / Average (AV)
Channel	TX Channel 46	Test Mode	A

No	Freq. [MHz]	Corr. Factor (dB)	Reading Value [dB (uV)]		Emission Level [dB (uV)]		Limit [dB (uV)]		Margin (dB)	
			Q.P.	AV.	Q.P.	AV.	Q.P.	AV.	Q.P.	AV.
			1	0.15782	9.82	22.42	11.67	32.24	21.49	65.58
2	0.18519	9.83	18.65	1.62	28.48	11.45	64.25	54.25	-35.77	-42.80
3	0.21256	9.83	14.85	0.77	24.68	10.60	63.10	53.10	-38.42	-42.50
4	0.30640	9.86	17.51	7.32	27.37	17.18	60.07	50.07	-32.70	-32.89
5	0.90463	9.92	5.99	-0.23	15.91	9.69	56.00	46.00	-40.09	-36.31
6	10.96115	10.52	4.72	-2.71	15.24	7.81	60.00	50.00	-44.76	-42.19

Remarks:

1. Q.P. and AV. are abbreviations of quasi-peak and average individually.
2. The emission levels of other frequencies were very low against the limit.
3. Margin value = Emission level - Limit value
4. Correction factor = Insertion loss + Cable loss
5. Emission Level = Correction Factor + Reading Value.

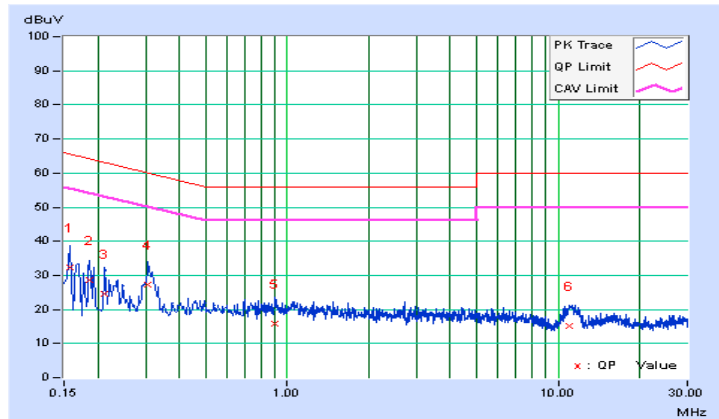

Phase	Line (L)	Detector Function	Quasi-Peak (QP) / Average (AV)
Channel	TX Channel 46	Test Mode	B

No	Freq. [MHz]	Corr. Factor (dB)	Reading Value [dB (uV)]		Emission Level [dB (uV)]		Limit [dB (uV)]		Margin (dB)	
			Q.P.	AV.	Q.P.	AV.	Q.P.	AV.	Q.P.	AV.
			1	0.15719	9.82	28.52	19.65	38.34	29.47	65.61
2	0.19717	9.84	25.07	13.96	34.91	23.80	63.73	53.73	-28.82	-29.93
3	0.35332	9.87	15.64	6.62	25.51	16.49	58.88	48.88	-33.37	-32.39
4	4.27896	10.15	7.93	2.28	18.08	12.43	56.00	46.00	-37.92	-33.57
5	10.67572	10.55	6.36	0.98	16.91	11.53	60.00	50.00	-43.09	-38.47
6	14.48797	10.77	6.47	0.95	17.24	11.72	60.00	50.00	-42.76	-38.28

Remarks:

1. Q.P. and AV. are abbreviations of quasi-peak and average individually.
2. The emission levels of other frequencies were very low against the limit.
3. Margin value = Emission level - Limit value
4. Correction factor = Insertion loss + Cable loss
5. Emission Level = Correction Factor + Reading Value.

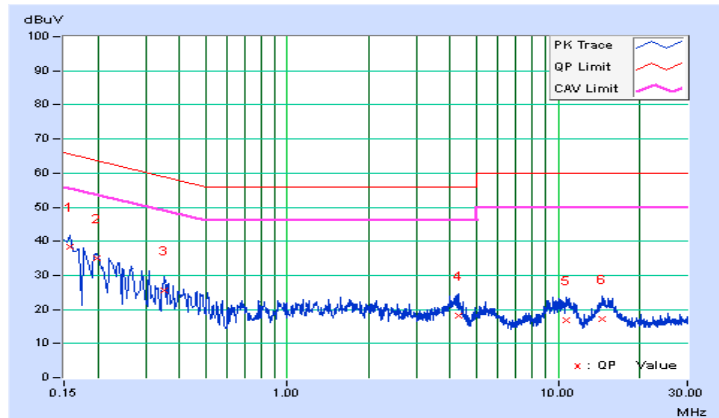

Phase	Neutral (N)	Detector Function	Quasi-Peak (QP) / Average (AV)
Channel	TX Channel 46	Test Mode	B

No	Freq. [MHz]	Corr. Factor (dB)	Reading Value [dB (uV)]		Emission Level [dB (uV)]		Limit [dB (uV)]		Margin (dB)	
			Q.P.	AV.	Q.P.	AV.	Q.P.	AV.	Q.P.	AV.
	1	0.15391	9.82	30.23	22.42	40.05	32.24	65.79	55.79	-25.74
2	0.19305	9.83	18.67	6.75	28.50	16.58	63.90	53.90	-35.41	-37.33
3	0.23961	9.84	16.26	4.73	26.10	14.57	62.11	52.11	-36.01	-37.54
4	0.26695	9.85	22.52	15.52	32.37	25.37	61.21	51.21	-28.85	-25.85
5	4.22031	10.14	5.08	-0.60	15.22	9.54	56.00	46.00	-40.78	-36.46
6	15.05101	10.71	4.02	-1.52	14.73	9.19	60.00	50.00	-45.27	-40.81

Remarks:

1. Q.P. and AV. are abbreviations of quasi-peak and average individually.
2. The emission levels of other frequencies were very low against the limit.
3. Margin value = Emission level - Limit value
4. Correction factor = Insertion loss + Cable loss
5. Emission Level = Correction Factor + Reading Value.

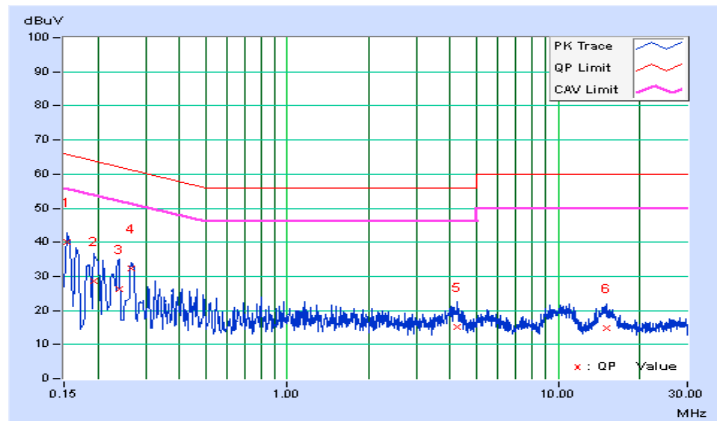

4.3 Transmit Power Measurement

4.3.1 Limits of Transmit Power Measurement

Operation Band	EUT Category	LIMIT
U-NII-1	Outdoor Access Point	1 Watt (30 dBm) (Max. e.i.r.p)

*B is the 26 dB emission bandwidth in megahertz

4.3.2 Test Setup

[For Power Output Measurement](#)

[For 26dB and Occupied Bandwidth](#)

4.3.3 Test Instruments

Refer to section 4.1.2 to get information of above instrument.

4.3.4 Test Procedure

For Average Power Measurement

Method PM is used to perform output power measurement, trigger and gating function of wide band power meter is enabled to measure max output power of TX on burst. Duty factor is not added to measured value.

For Occupied Bandwidth

The transmitter output was connected to the spectrum analyzer through an attenuator. The bandwidth of the fundamental frequency was measured by spectrum analyzer with resolution bandwidth in the range of 1% to 5% of the anticipated emission bandwidth, and a video bandwidth at least 3x the resolution bandwidth and set the detector to SAMPLE. The width of a frequency band such that, below the lower and above the upper frequency limits, the mean powers emitted are each equal to a specified percentage 0.5 %of the total mean power of a given emission.

4.3.5 Deviation from Test Standard

No deviation.

4.3.6 EUT Operating Conditions

The software provided by client to enable the EUT under transmission condition continuously at lowest, middle and highest channel frequencies individually.

4.3.7 Test Result

Power Output:

WHDI (20MHz)

Chan.	Freq. (MHz)	Maximum Conducted Power (mW)	Maximum Conducted Power (dBm)	Power Limit (dBm)	Pass / Fail
36	5180	44.055	16.44	29.80	Pass
40	5200	44.771	16.51	29.80	Pass
48	5240	43.752	16.41	29.80	Pass
149	5745	44.463	16.48	29.80	Pass
157	5785	42.954	16.33	29.80	Pass
165	5825	44.157	16.45	29.80	Pass

Note: Gain = 6.2dBi > 6dBi, so the conducted power limit shall be reduced to 30-(6.2-6) = 29.80dBm.

WHDI (40MHz)

Chan.	Freq. (MHz)	Maximum Conducted Power (mW)	Maximum Conducted Power (dBm)	Power Limit (dBm)	Pass / Fail
38	5190	44.463	16.48	29.80	Pass
46	5230	46.238	16.65	29.80	Pass
54	5270	43.251	16.36	23.80	Pass
62	5310	43.652	16.40	23.80	Pass
102	5510	43.351	16.37	23.80	Pass
110	5550	44.055	16.44	23.80	Pass
134	5670	43.551	16.39	23.80	Pass
151	5755	44.463	16.48	29.80	Pass
159	5795	42.954	16.33	29.80	Pass

Note:

- U-NII-1 & U-NII-3 Band: Gain = 6.2dBi > 6dBi, so the conducted power limit shall be reduced to 30-(6.2-6) = 29.80dBm.
- U-NII-2A, U-NII-2C Band: Gain = 6.2dBi > 6dBi, so the conducted power limit shall be reduced to 24-(6.2-6) = 23.80dBm.
- For U-NII-2A, U-NII-2C Band:
 - 11dBm + 10log(40.31)= 27.05>24dBm
 - 11dBm + 10log(39.80)= 27.00>24dBm
 - 11dBm + 10log(40.02)= 27.02>24dBm
 - 11dBm + 10log(40.23)= 27.05>24dBm
 - 11dBm + 10log(39.74)= 26.99>24dBm

26dB Bandwidth:

WHDI (20MHz)

Chan.	Freq. (MHz)	26dBc Bandwidth (MHz)	Pass / Fail
36	5180	19.73	Pass
40	5200	19.78	Pass
48	5240	19.76	Pass

WHDI (40MHz)

Chan.	Freq. (MHz)	26dBc Bandwidth (MHz)	Pass / Fail
38	5190	39.93	Pass
46	5230	40.38	Pass
54	5270	40.31	Pass
62	5310	39.80	Pass
102	5510	40.02	Pass
110	5550	40.23	Pass
134	5670	39.74	Pass

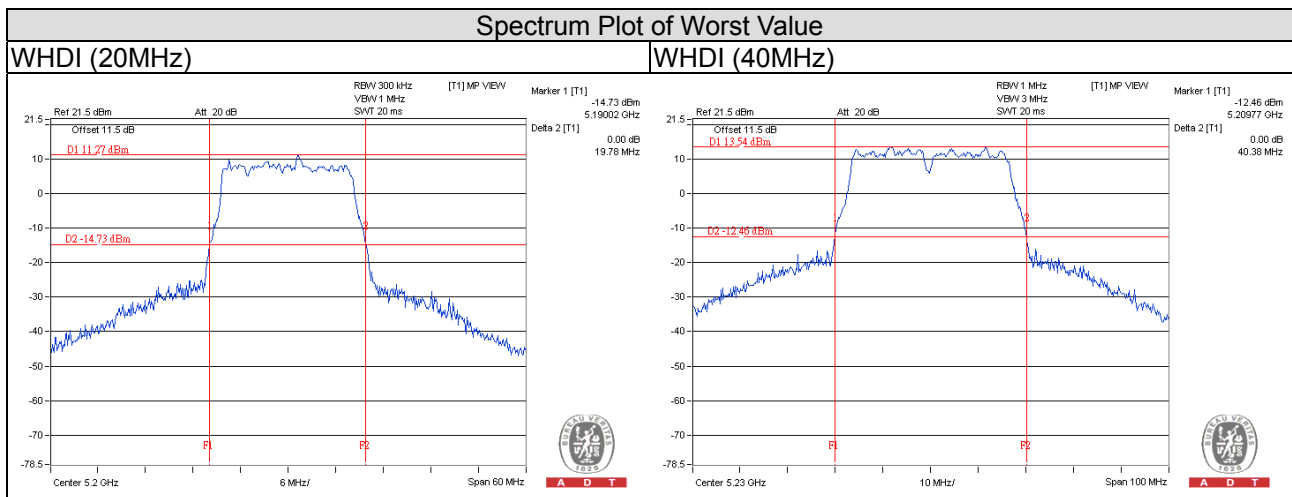

Occupied Bandwidth:

WHDI (20MHz)

Chan.	Freq. (MHz)	Occupied Bandwidth (MHz)
36	5180	16.56
40	5200	16.56
48	5240	16.56
149	5745	16.61
157	5785	16.56
165	5825	16.56

WHDI (40MHz)

Chan.	Freq. (MHz)	Occupied Bandwidth (MHz)
38	5190	33.74
46	5230	33.72
54	5270	33.84
62	5310	32.16
102	5510	32.28
110	5550	33.60
134	5670	32.88
151	5755	32.26
159	5795	33.84

Spectrum Plot of Worst Value

WHDI (20MHz)

WHDI (40MHz)

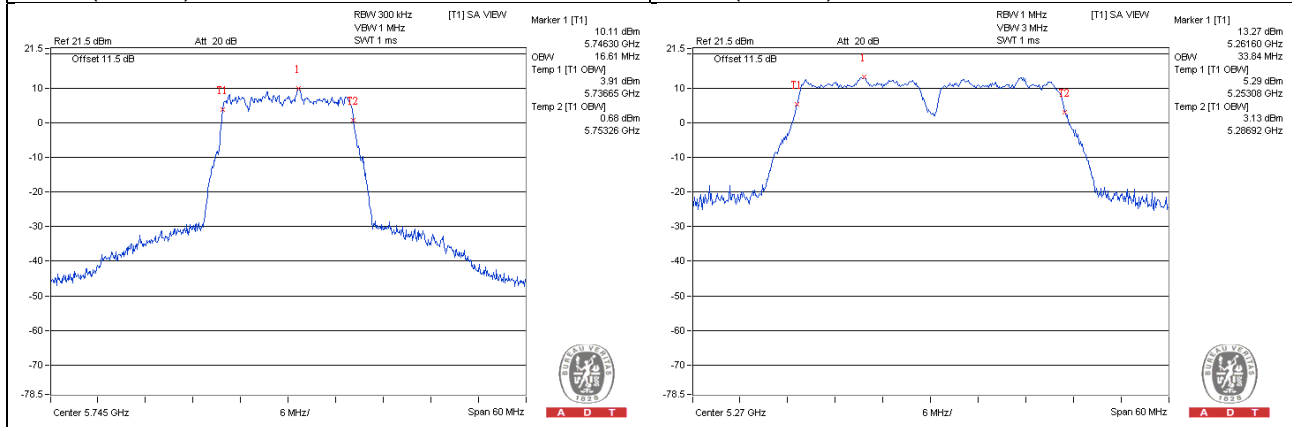

EUT MAXIMUM CONDUCTED POWER

WHDI (40MHz)

Frequency Band (MHz)	Max. Power	
	Output Power (mW)	Output Power (dBm)
5250~5350	43.652	16.40
5470~5725	44.055	16.44

4.4 Peak Power Spectral Density Measurement

4.4.1 Limits of Peak Power Spectral Density Measurement

Operation Band	EUT Category		LIMIT
U-NII-1		Outdoor Access Point	17dBm/ MHz
		Fixed point-to-point Access Point	
	√	Indoor Access Point	11dBm/ MHz
		Mobile and Portable client device	
U-NII-2A	√		11dBm/ MHz
U-NII-2C	√		11dBm/ MHz
U-NII-3	√		30dBm/ 500kHz

4.4.2 Test Setup

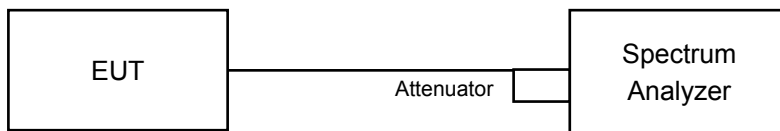

4.4.3 Test Instruments

Refer to section 4.1.2 to get information of above instrument.

4.4.4 Test Procedures

For U-NII-1, U-NII-2A, U-NII-2C band:

- Set span to encompass the entire emission bandwidth (EBW) of the signal.
- Set RBW = 1 MHz, Set VBW ≥ 3 MHz, Detector = RMS
- Sweep time = auto, trigger set to “free run”.
- Trace average at least 100 traces in power averaging mode.
- Record the max value

For U-NII-3 band:

- Set span to encompass the entire emission bandwidth (EBW) of the signal.
- Set RBW = 300 kHz, Set VBW ≥ 3 RBW, Detector = RMS
- Sweep time = auto, trigger set to “free run”.
- Trace average at least 100 traces in power averaging mode.
- Record the max value and add 10 log (1/duty cycle)
- Scale the observed power level to an equivalent value in 500 kHz by adjusting (reducing) the measured power by a bandwidth correction factor (BWCF) where $BWCF = 10\log(500\text{ kHz}/300\text{kHz})$

4.4.5 Deviation from Test Standard

No deviation.

4.4.6 EUT Operating Conditions

Same as Item 4.3.6.

4.4.7 Test Results

For U-NII-1, U-NII-2A, U-NII-2C Band

WHDI (20MHz)

Chan.	Freq. (MHz)	PSD (dBm)	Max. Limit (dBm)	Pass / Fail
36	5180	4.60	16.80	Pass
40	5200	4.69	16.80	Pass
48	5240	4.19	16.80	Pass

Note: Gain = 6.2dBi > 6dBi, so the power density limit shall be reduced to 17-(6.2-6) = 16.80dBm.

WHDI (40MHz)

Chan.	Freq. (MHz)	PSD (dBm)	Max. Limit (dBm)	Pass / Fail
38	5190	2.12	16.80	Pass
46	5230	2.06	16.80	Pass
54	5270	1.63	10.80	Pass
62	5310	1.42	10.80	Pass
102	5510	1.57	10.80	Pass
110	5550	1.56	10.80	Pass
134	5670	1.53	10.80	Pass

Note:

1. U-NII-1 Band: Gain = 6.2dBi > 6dBi, so the power density limit shall be reduced to 17-(6.2-6) = 16.80dBm.
2. U-NII-2A, U-NII-2C Band: Gain = 6.2dBi > 6dBi, so the power density limit shall be reduced to 11-(6.2-6) = 10.80dBm.

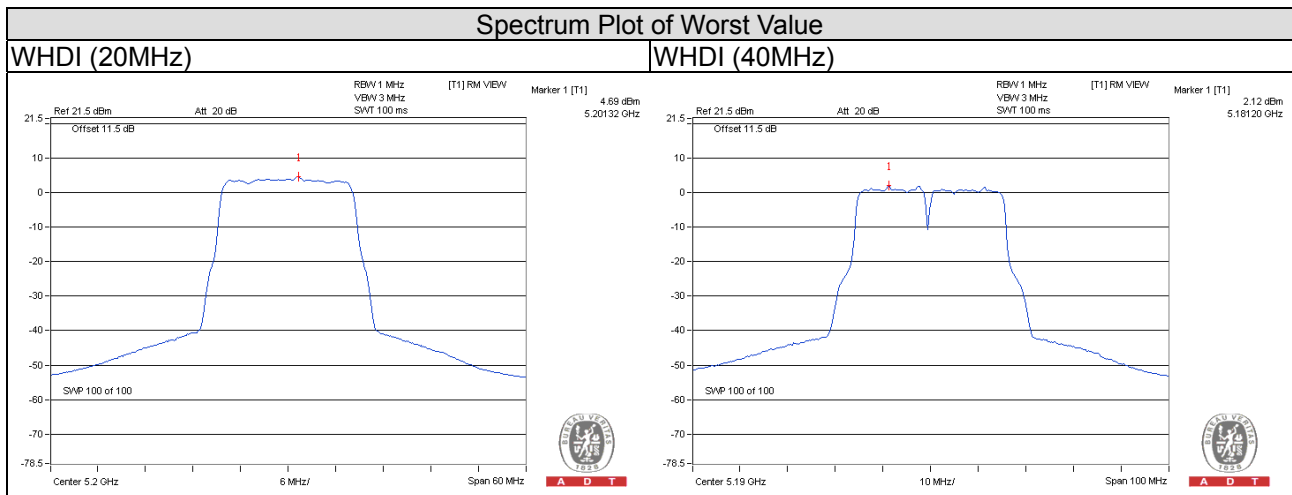

For U-NII-3 Band

WHDI (20MHz)

Chan.	Freq. (MHz)	PSD (dBm/300kHz)	PSD (dBm/500kHz)	Limit (dBm/500kHz)	Pass / Fail
149	5745	-4.01	-1.79	29.80	Pass
157	5785	-4.20	-1.98	29.80	Pass
165	5825	-3.73	-1.51	29.80	Pass

Note: Gain = 6.2dBi > 6dBi, so the power density limit shall be reduced to 30-(6.2-6) = 29.80dBm.

WHDI (40MHz)

Chan.	Freq. (MHz)	PSD (dBm/300kHz)	PSD (dBm/500kHz)	Limit (dBm/500kHz)	Pass / Fail
151	5755	-7.00	-4.78	29.80	Pass
159	5795	-6.68	-4.46	29.80	Pass

Note: Gain = 6.2dBi > 6dBi, so the power density limit shall be reduced to 30-(6.2-6) = 29.80dBm.

Spectrum Plot of Worst Value

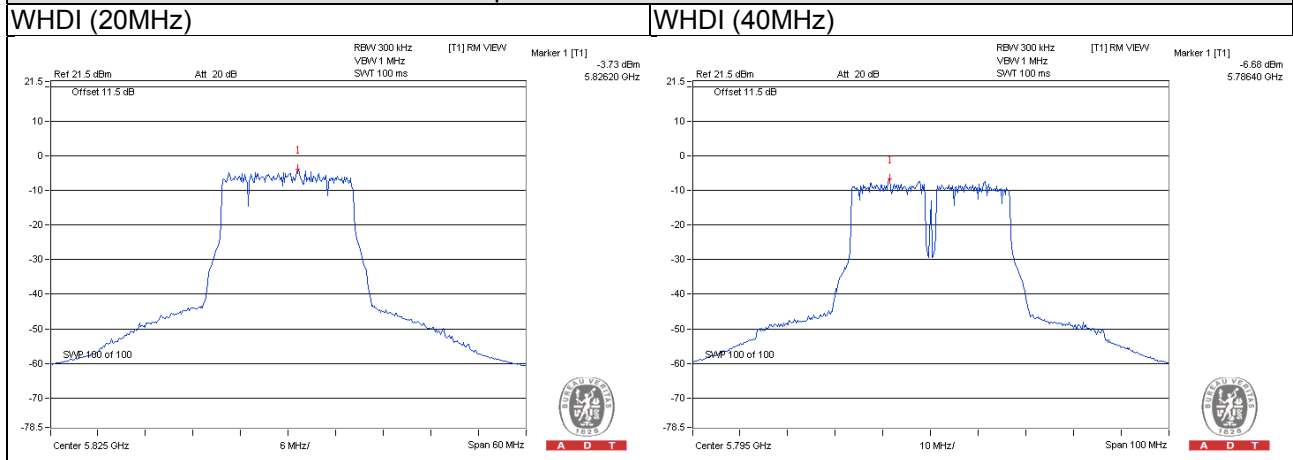

4.5 Frequency Stability

4.5.1 Limits of Frequency Stability Measurement

The frequency of the carrier signal shall be maintained within band of operation

4.5.2 Test Setup

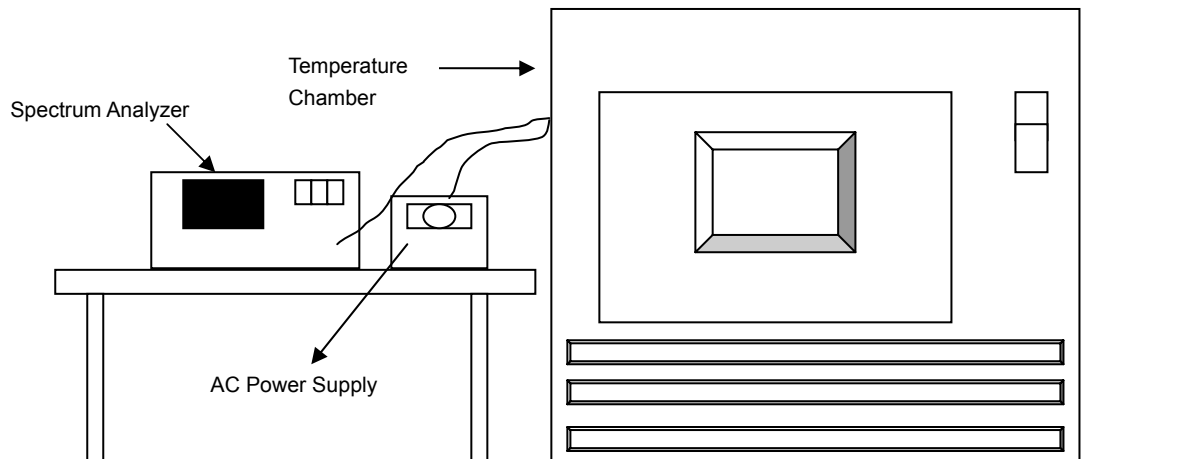

4.5.3 Test Instruments

Refer to section 4.1.2 to get information of above instrument.

4.5.4 Test Procedure

- a. The EUT was placed inside the environmental test chamber and powered by nominal AC voltage.
- b. Turn the EUT on and couple its output to a spectrum analyzer.
- c. Turn the EUT off and set the chamber to the highest temperature specified.
- d. Allow sufficient time (approximately 30 min) for the temperature of the chamber to stabilize, turn the EUT on and measure the operating frequency after 2, 5, and 10 minutes.
- e. Repeat step 2 and 3 with the temperature chamber set to the lowest temperature.
- f. The test chamber was allowed to stabilize at +20 degree C for a minimum of 30 minutes. The supply voltage was then adjusted on the EUT from 85% to 115% and the frequency record.

4.5.5 Deviation from Test Standard

No deviation.

4.5.6 EUT Operating Condition

Set the EUT transmit at un-modulation mode to test frequency stability.

4.5.7 Test Results

WHDI (40MHz)

Frequency Stability Versus Temp.
Operating Frequency: 5230MHz

Temp.
(

4.6 6dB Bandwidth Measurement

4.6.1 Limits of 6dB Bandwidth Measurement

The minimum of 6dB Bandwidth Measurement is 0.5MHz.

4.6.2 Test Setup

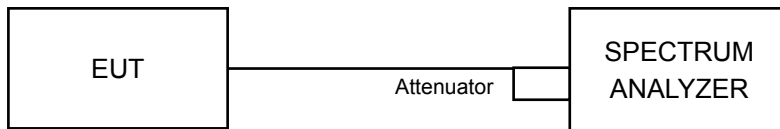

4.6.3 Test Instruments

Refer to section 4.1.2 to get information of above instrument.

4.6.4 Test Procedure

MEASUREMENT PROCEDURE REF

- Set resolution bandwidth (RBW) = 100kHz
- Set the video bandwidth (VBW) $\geq 3 \times$ RBW, Detector = Peak.
- Trace mode = max hold.
- Sweep = auto couple.
- Measure the maximum width of the emission that is constrained by the frequencies associated with the two amplitude points (upper and lower) that are attenuated by 6 dB relative to the maximum level measured in the fundamental emission

4.6.5 Deviation from Test Standard

No deviation.

4.6.6 EUT Operating Condition

The software provided by client to enable the EUT under transmission condition continuously at lowest, middle and highest channel frequencies individually.

4.6.7 Test Results

WHDI (20MHz)

Channel	Frequency (MHz)	6dB Bandwidth (MHz)	Minimum Limit (MHz)	Pass / Fail
149	5745	16.42	0.5	Pass
157	5785	16.49	0.5	Pass
165	5825	16.50	0.5	Pass

WHDI (40MHz)

Channel	Frequency (MHz)	6dB Bandwidth (MHz)	Minimum Limit (MHz)	Pass / Fail
151	5755	33.25	0.5	Pass
159	5795	33.32	0.5	Pass

Spectrum Plot of Worst Value

WHDI (20MHz)

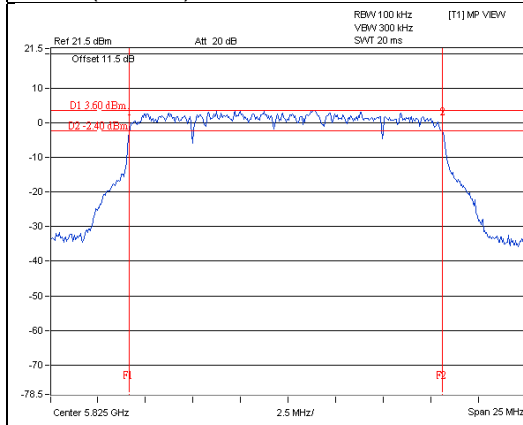

WHDI (40MHz)

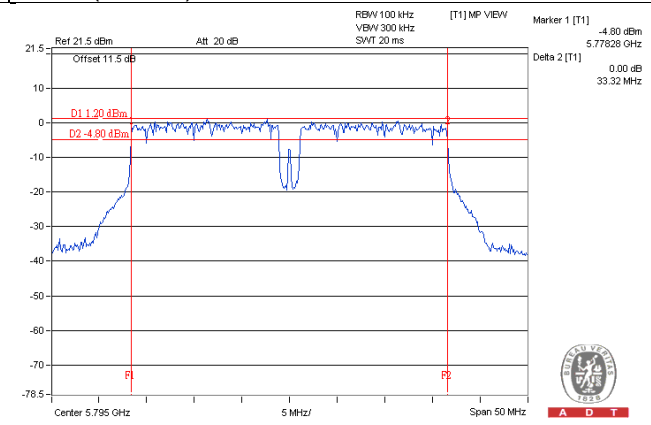

5 Pictures of Test Arrangements

Please refer to the attached file (Test Setup Photo).

Appendix – Information on the Testing Laboratories

We, Bureau Veritas Consumer Products Services (H.K.) Ltd., Taoyuan Branch, were founded in 1988 to provide our best service in EMC, Radio, Telecom and Safety consultation. Our laboratories are accredited and approved according to ISO/IEC 17025.

If you have any comments, please feel free to contact us at the following:

Linko EMC/RF Lab

Tel: 886-2-26052180

Fax: 886-2-26051924

Hsin Chu EMC/RF/Telecom Lab

Tel: 886-3-6668565

Fax: 886-3-6668323

Hwa Ya EMC/RF/Safety Lab

Tel: 886-3-3183232

Fax: 886-3-3270892

Email: service.adt@tw.bureauveritas.com

Web Site: www.bureauveritas-adt.com

The address and road map of all our labs can be found in our web site also.

--- END ---