



SPORTON International Inc.

No. 52, Hwa Ya 1st Rd., Kwei-Shan Hsiang, TaoYuan Hsien, Taiwan, R.O.C.
Ph: 886-3-327-3456 / FAX: 886-3-327-0973 / www.sporton.com.tw

FCC RADIO TEST REPORT

| | |
|------------------------|--|
| Applicant's company | Phoenix Contact GmbH & Co. KG |
| Applicant Address | Flachmarktstraße 8 32825 Blomberg / Germany |
| FCC ID | YG3MA25MP1 |
| Manufacturer's company | JJPlus Corp. |
| Manufacturer Address | 11F., No.788, Zhongzheng Rd., Zhonghe Dist., New Taipei City 235, Taiwan |

| | |
|-------------------|---|
| Product Name | MODUL MINI PCI WLAN MA25MP1 |
| Brand Name | Phoenix Contact |
| Model Name | 9158515/MA25MP1 |
| Test Rule Part(s) | 47 CFR FCC Part 15 Subpart E § 15.407 |
| Test Freq. Range | 5150 ~ 5350MHz / 5470 ~ 5725MHz |
| Received Date | Jul. 27, 2011 |
| Final Test Date | Nov. 03, 2011 |
| Submission Type | Original Equipment |
| Operating Mode | Client (without radar detection function) |



Statement

Test result included is for the IEEE 802.11n and IEEE 802.11a (5150 ~ 5350MHz / 5470 ~ 5725MHz) of the product.

The test result in this report refers exclusively to the presented test model / sample.

Without written approval of SPORTON International Inc., the test report shall not be reproduced except in full.

The measurements and test results shown in this test report were made in accordance with the procedures and found in compliance with the limit given in ANSI C63.10-2009 and 47 CFR FCC Part 15 Subpart E.

The test equipment used to perform the test is calibrated and traceable to NML/ROC.



Testing Laboratory
1190

Table of Contents

| | |
|--|----------------|
| 1. CERTIFICATE OF COMPLIANCE | 1 |
| 2. SUMMARY OF THE TEST RESULT | 2 |
| 3. GENERAL INFORMATION | 3 |
| 3.1. Product Details..... | 3 |
| 3.2. Accessories..... | 6 |
| 3.3. Table for Filed Antenna..... | 6 |
| 3.4. Table for Carrier Frequencies | 7 |
| 3.5. Table for Test Modes | 8 |
| 3.6. Table for Testing Locations..... | 11 |
| 3.7. Table for Supporting Units | 12 |
| 3.8. Table for Parameters of Test Software Setting | 12 |
| 3.9. Test Configurations | 14 |
| 4. TEST RESULT | 17 |
| 4.1. AC Power Line Conducted Emissions Measurement | 17 |
| 4.2. 99% Occupied Bandwidth Measurement | 21 |
| 4.3. Maximum Conducted Output Power Measurement | 48 |
| 4.4. Power Spectral Density Measurement | 54 |
| 4.5. Peak Excursion Measurement | 74 |
| 4.6. Radiated Emissions Measurement | 87 |
| 4.7. Band Edge Emissions Measurement | 135 |
| 4.8. Frequency Stability Measurement | 152 |
| 4.9. Antenna Requirements | 155 |
| 5. LIST OF MEASURING EQUIPMENTS | 156 |
| 6. TEST LOCATION..... | 158 |
| 7. TAF CERTIFICATE OF ACCREDITATION | 159 |
| APPENDIX A. TEST PHOTOS | A1 ~ A9 |
| APPENDIX B. MAXIMUM PERMISSIBLE EXPOSURE | B1 ~ B4 |



History of This Test Report

| REPORT NO. | VERSION | DESCRIPTION | ISSUED DATE |
|------------|---------|-------------------------|---------------|
| FR172732AA | Rev. 01 | Initial issue of report | Nov. 21, 2011 |
| | | | |
| | | | |
| | | | |
| | | | |
| | | | |
| | | | |
| | | | |
| | | | |
| | | | |
| | | | |
| | | | |
| | | | |
| | | | |
| | | | |

1. CERTIFICATE OF COMPLIANCE

Product Name : MODUL MINI PCI WLAN MA25MP1
Brand Name : Phoenix Contact
Model Name : 9158515/MA25MP1
Applicant : Phoenix Contact GmbH & Co. KG
Test Rule Part(s) : 47 CFR FCC Part 15 Subpart E § 15.407

Sporton International as requested by the applicant to evaluate the EMC performance of the product sample received on Jul. 27, 2011 would like to declare that the tested sample has been evaluated and found to be in compliance with the tested rule parts. The data recorded as well as the test configuration specified is true and accurate for showing the sample's EMC nature.

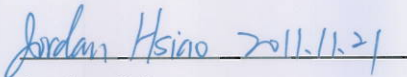

Jordan Hsiao

SPORTON INTERNATIONAL INC.

2. SUMMARY OF THE TEST RESULT

| Applied Standard: 47 CFR FCC Part 15 Subpart E | | | | |
|--|--------------|-----------------------------------|----------|-------------|
| Part | Rule Section | Description of Test | Result | Under Limit |
| 4.1 | 15.207 | AC Power Line Conducted Emissions | Complies | 19.09 dB |
| 4.2 | 15.407(a) | 26dB Spectrum Bandwidth | Complies | - |
| 4.3 | 15.407(a) | Maximum Conducted Output Power | Complies | 0.01 dB |
| 4.4 | 15.407(a) | Power Spectral Density | Complies | 0.04 dB |
| 4.5 | 15.407(a) | Peak Excursion | Complies | 5.54 dB |
| 4.6 | 15.407(b) | Radiated Emissions | Complies | 0.44 dB |
| 4.7 | 15.407(b) | Band Edge Emissions | Complies | 0.01 dB |
| 4.8 | 15.407(g) | Frequency Stability | Complies | - |
| 4.9 | 15.203 | Antenna Requirements | Complies | - |

| Test Items | Uncertainty | Remark |
|---|-----------------------|--------------------------|
| AC Power Line Conducted Emissions | ±2.3dB | Confidence levels of 95% |
| Maximum Conducted Output Power | ±0.5dB | Confidence levels of 95% |
| Power Spectral Density | ±0.5dB | Confidence levels of 95% |
| Peak Excursion | ±0.5dB | Confidence levels of 95% |
| 26dB Spectrum Bandwidth / Frequency Stability | ±8.5×10 ⁻⁸ | Confidence levels of 95% |
| Radiated Emissions (9kHz~30MHz) | ±0.8dB | Confidence levels of 95% |
| Radiated Emissions (30MHz~1000MHz) | ±1.9dB | Confidence levels of 95% |
| Radiated / Band Edge Emissions (1GHz~18GHz) | ±1.9dB | Confidence levels of 95% |
| Radiated Emissions (18GHz~40GHz) | ±1.9dB | Confidence levels of 95% |
| Temperature | ±0.7°C | Confidence levels of 95% |
| Humidity | ±3.2% | Confidence levels of 95% |
| DC / AC Power Source | ±1.4% | Confidence levels of 95% |

3. GENERAL INFORMATION

3.1. Product Details

IEEE 802.11n

| Items | Description |
|--------------------------|--|
| Product Type | WLAN (2TX, 2RX) |
| Radio Type | Intentional Transceiver |
| Power Type | From Adapter |
| Modulation | see the below table for IEEE 802.11n |
| Data Modulation | OFDM (BPSK / QPSK / 16QAM / 64QAM) |
| Data Rate (Mbps) | see the below table for IEEE 802.11n |
| Frequency Range | 5150 ~ 5350MHz / 5470 ~ 5725MHz |
| Channel Number | 16 for 20MHz bandwidth ; 8 for 40MHz bandwidth |
| Channel Band Width (99%) | Ant. 3 MCS8 (20MHz): 19.36 MHz ; MCS8 (40MHz): 43.84 MHz Ant. 4 MCS8 (20MHz): 18.08 MHz ; MCS8 (40MHz): 36.48 MHz |
| Conducted Output Power | Ant. 3 Band 1: MCS8 (20MHz): 16.97 dBm ; MCS8 (40MHz): 16.72 dBm Band 2: MCS8 (20MHz): 23.64 dBm ; MCS8 (40MHz): 22.62 dBm Band 3: MCS8 (20MHz): 23.75 dBm ; MCS8 (40MHz): 22.64 dBm Ant. 4 Band 2: MCS8 (20MHz): 13.81 dBm ; MCS8 (40MHz): 13.82 dBm Band 3: MCS8 (20MHz): 13.66 dBm ; MCS8 (40MHz): 13.59dBm |
| Carrier Frequencies | Please refer to section 3.4 |
| Antenna | Please refer to section 3.3 |

IEEE 802.11a

| Items | Description |
|--------------------------|---|
| Product Type | WLAN (2TX, 2RX) |
| Radio Type | Intentional Transceiver |
| Power Type | From Adapter |
| Modulation | OFDM for IEEE 802.11a |
| Data Modulation | OFDM (BPSK / QPSK / 16QAM / 64QAM) |
| Data Rate (Mbps) | OFDM (6/9/12/18/24/36/48/54/108) |
| Frequency Range | 5150 ~ 5350MHz / 5470 ~ 5725MHz |
| Channel Number | 16 |
| Channel Band Width (99%) | Ant. 3 11a: 17.94 MHz Ant. 4 11a: 17.28 MHz |
| Conducted Output Power | Ant.3 Band 1: 13.97 dBm ; Band 2: 20.89 dBm ; Band 3: 20.98dBm Ant.4 Band 2: 10.62 dBm ; Band 3: 10.58 dBm |
| Carrier Frequencies | Please refer to section 3.4 |
| Antenna | Please refer to section 3.3 |

Antenna & Band width

| Antenna | Single (TX) | | Two (TX) | |
|--------------|-------------|--------|----------|--------|
| | 20 MHz | 40 MHz | 20 MHz | 40 MHz |
| IEEE 802.11a | X | X | V | X |
| IEEE 802.11n | X | X | V | V |

IEEE 802.11n spec

| MCS Index | Nss | Modulation | R | NBPS | NCBPS | | NDBPS | | Datarate(Mbps) | | | |
|-----------|-----|------------|-----|------|-------|-------|-------|-------|----------------|-------|---------|-------|
| | | | | | 20MHz | 40MHz | 20MHz | 40MHz | 800nsGI | | 400nsGI | |
| | | | | | | | | | 20MHz | 40MHz | 20MHz | 40MHz |
| 0 | 1 | BPSK | 1/2 | 1 | 52 | 108 | 26 | 54 | 6.5 | 13.5 | 7.200 | 15 |
| 1 | 1 | QPSK | 1/2 | 2 | 104 | 216 | 52 | 108 | 13.0 | 27.0 | 14.400 | 30 |
| 2 | 1 | QPSK | 3/4 | 2 | 104 | 216 | 78 | 162 | 19.5 | 40.5 | 21.700 | 45 |
| 3 | 1 | 16-QAM | 1/2 | 4 | 208 | 432 | 104 | 216 | 26.0 | 54.0 | 28.900 | 60 |
| 4 | 1 | 16-QAM | 3/4 | 4 | 208 | 432 | 156 | 324 | 39.0 | 81.0 | 43.300 | 90 |
| 5 | 1 | 64-QAM | 2/3 | 6 | 312 | 648 | 208 | 432 | 52.0 | 108.0 | 57.800 | 120 |
| 6 | 1 | 64-QAM | 3/4 | 6 | 312 | 648 | 234 | 486 | 58.5 | 121.5 | 65.000 | 135 |
| 7 | 1 | 64-QAM | 5/6 | 6 | 312 | 648 | 260 | 540 | 65.0 | 135.0 | 72.200 | 150 |
| 8 | 2 | BPSK | 1/2 | 1 | 104 | 216 | 52 | 108 | 13.0 | 27.0 | 14.444 | 30 |
| 9 | 2 | QPSK | 1/2 | 2 | 208 | 432 | 104 | 216 | 26.0 | 54.0 | 28.889 | 60 |
| 10 | 2 | QPSK | 3/4 | 2 | 208 | 432 | 156 | 324 | 39.0 | 81.0 | 43.333 | 90 |
| 11 | 2 | 16-QAM | 1/2 | 4 | 416 | 864 | 208 | 432 | 52.0 | 108.0 | 57.778 | 120 |
| 12 | 2 | 16-QAM | 3/4 | 4 | 416 | 864 | 312 | 648 | 78.0 | 162.0 | 86.667 | 180 |
| 13 | 2 | 64-QAM | 2/3 | 6 | 624 | 1296 | 416 | 864 | 104.0 | 216.0 | 115.556 | 240 |
| 14 | 2 | 64-QAM | 3/4 | 6 | 624 | 1296 | 468 | 972 | 117.0 | 243.0 | 130.000 | 270 |
| 15 | 2 | 64-QAM | 5/6 | 6 | 624 | 1296 | 520 | 1080 | 130.0 | 270.0 | 144.444 | 300 |

| Symbol | Explanation |
|--------|---|
| NSS | Number of spatial streams |
| R | Code rate |
| NBPS | Number of coded bits per single carrier |
| NCBPS | Number of coded bits per symbol |
| NDBPS | Number of data bits per symbol |
| GI | guard interval |

3.2. Accessories

N/A

3.3. Table for Filed Antenna

| Ant. | Brand | Model Name | Antenna Type | Antenna Gain(dBi) | | N Type cable loss | MMCX to SMA cable loss | Gain (dBi) | |
|------|---------|---------------------------|------------------|-------------------|------|-------------------|------------------------|------------|------|
| | | | | 2.4GHz | 5GHz | | | 2.4GHz | 5GHz |
| 3 | PHOENIX | RAD-ISM-2459-ANT-FOOD-6-0 | Omni-directional | 2.4GHz | 6 | 0.5 | 0.5 | 2.4GHz | 5 |
| | | | | 5GHz | 8 | 1 | 1 | 5GHz | 6 |
| 4 | PHOENIX | RAD-ISM-5000-ANT-PAR-18-N | Parabolic | 5GHz | 18.1 | 1 | 1 | 5GHz | 16.1 |

Note: There are two sets of antennas provided to this EUT in 5GHz Band and all of them can be used as transmitting and receiving antenna.

The EUT use Connector 1 as its main transmitting/receiving antenna connector.

Connector 2 and Connector 3 support TX/RX diversity function.

Due to Connector 3 generated higher output power than Connector 2, it is selected to test in the report.

Only two antenna connectors (Connector 1 & Connector 2 or Connector 1 & Connector 3) could transmit/receive the same signal simultaneously.

Note: Due to Antenna 4 is outdoor use antenna, it is only used in Band 2, Band 3 and Band 4 of 5GHz Band.

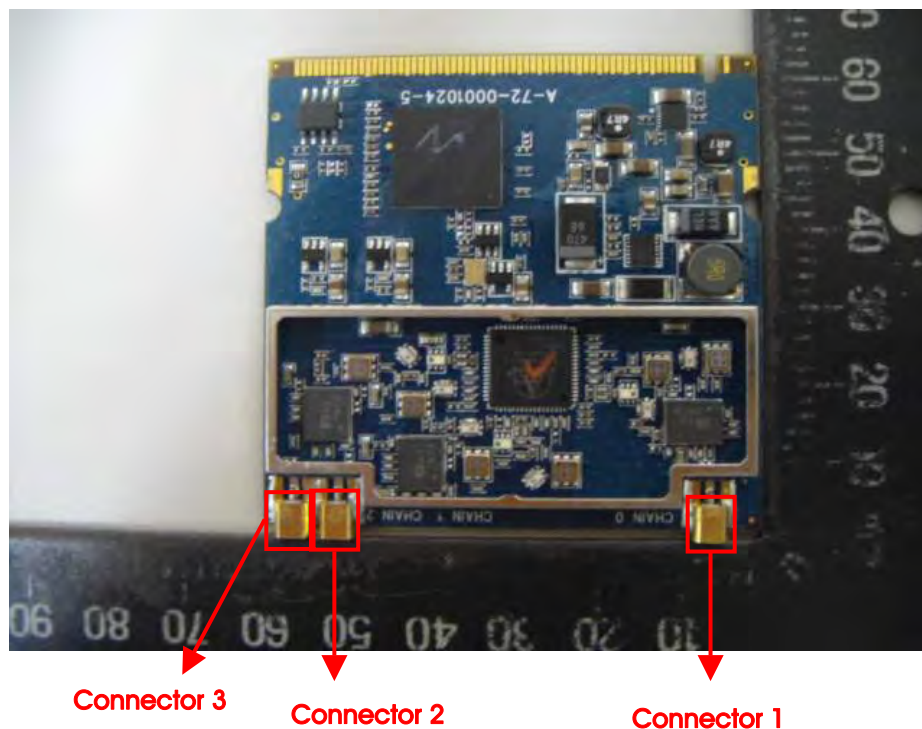

3.4. Table for Carrier Frequencies

For IEEE 802.11a, use Channel 36, 40, 44, 48, 52, 56, 60, 64, 100, 104, 108, 112, 116, 132, 136, 140.

There are two bandwidth systems for IEEE 802.11n.

For both 20MHz bandwidth systems, use Channel 36, 40, 44, 48, 52, 56, 60, 64, 100, 104, 108, 112, 116, 132, 136, 140.

For both 40MHz bandwidth systems, use Channel 38, 46, 54, 62, 102, 110, 118, 134.

| Frequency Band | Channel No. | Frequency | Channel No. | Frequency |
|-------------------------|-------------|-----------|-------------|-----------|
| 5150~5250 MHz Band 1 | 36 | 5180 MHz | 44 | 5220 MHz |
| | 38 | 5190 MHz | 46 | 5230 MHz |
| | 40 | 5200 MHz | 48 | 5240 MHz |
| 5250~5350 MHz Band 2 | 52 | 5260 MHz | 60 | 5300 MHz |
| | 54 | 5270 MHz | 62 | 5310 MHz |
| | 56 | 5280 MHz | 64 | 5320 MHz |
| 5470~5725 MHz Band 3 | 100 | 5500 MHz | 116 | 5580 MHz |
| | 102 | 5510MHz | 132 | 5660 MHz |
| | 104 | 5520 MHz | 134 | 5670 MHz |
| | 108 | 5540 MHz | 136 | 5680 MHz |
| | 110 | 5550 MHz | 140 | 5700 MHz |
| | 112 | 5560 MHz | - | - |

3.5. Table for Test Modes

Preliminary tests were performed in different data rate to find the worst radiated emission. The data rate shown in the table below is the worst-case rate with respect to the specific test item. Investigation has been done on all the possible configurations for searching the worst cases. The following table is a list of the test modes shown in this test report.

< For Ant. 3 >

| Test Items | Mode | | Data Rate | Channel | Connector |
|--|-------------|----------|-----------|-------------------|-----------|
| AC Power Conducted Emission | Normal Link | | Auto | - | - |
| Max. Conducted Output Power Power Spectral Density | MCS8/20MHz | Band 1~2 | 13Mbps | 36/40/48/52/60/64 | 1/3/1+3 |
| | | Band 3 | 13Mbps | 100/116/140 | 1/3/1+3 |
| | MCS8/40MHz | Band 1~2 | 27Mbps | 38/46/54/62 | 1/3/1+3 |
| | | Band 3 | 27Mbps | 102/110/134 | 1/3/1+3 |
| | 11a/BPSK | Band 1~2 | 6Mbps | 36/40/48/52/60/64 | 1/3/1+3 |
| | | Band 3 | 6Mbps | 100/116/140 | 1/3/1+3 |
| 26dB Spectrum Bandwidth 99% Occupied Bandwidth Measurement Peak Excursion | MCS8/20MHz | Band 1~2 | 13Mbps | 36/40/48/52/60/64 | 1+3 |
| | | Band 3 | 13Mbps | 100/116/140 | 1+3 |
| | MCS8/40MHz | Band 1~2 | 27Mbps | 38/46/54/62 | 1+3 |
| | | Band 3 | 27Mbps | 102/110/134 | 1+3 |
| | 11a/BPSK | Band 1~2 | 6Mbps | 36/40/48/52/60/64 | 1+3 |
| | | Band 3 | 6Mbps | 100/116/140 | 1+3 |
| Radiated Emission Below 1GHz | Normal Link | | Auto | - | - |
| Radiated Emission Above 1GHz | MCS8/20MHz | Band 1~2 | 13Mbps | 36/40/48/52/60/64 | 1+3 |
| | | Band 3 | 13Mbps | 100/116/140 | 1+3 |
| | MCS8/40MHz | Band 1~2 | 27Mbps | 38/46/54/62 | 1+3 |
| | | Band 3 | 27Mbps | 102/110/134 | 1+3 |
| | 11a/BPSK | Band 1~2 | 6Mbps | 36/40/48/52/60/64 | 1+3 |
| | | Band 3 | 6Mbps | 100/116/140 | 1+3 |
| Band Edge Emission | MCS8/20MHz | Band 1~2 | 13Mbps | 36/40/48/52/60/64 | 1+3 |
| | | Band 3 | 13Mbps | 100/140 | 1+3 |
| | MCS8/40MHz | Band 1~2 | 27Mbps | 38/46/54/62 | 1+3 |
| | | Band 3 | 27Mbps | 102/134 | 1+3 |



| | | | | | |
|---------------------|---------------|----------|-------|-------------------|-----|
| | 11a/BPSK | Band 1~2 | 6Mbps | 36/40/48/52/60/64 | 1+3 |
| | | Band 3 | 6Mbps | 100/140 | 1+3 |
| Frequency Stability | Un-modulation | | - | 40/60 | N/A |

< For Ant. 4 >

| Test Items | Mode | | Data Rate | Channel | Connector |
|--|---------------|--------|-----------|-------------|-----------|
| AC Power Conducted Emission | Normal Link | | Auto | - | - |
| Max. Conducted Output Power Power Spectral Density | MCS8/20MHz | Band 2 | 13Mbps | 52/60/64 | 1/3/1+3 |
| | | Band 3 | 13Mbps | 100/116/140 | 1/3/1+3 |
| | MCS8/40MHz | Band 2 | 27Mbps | 54/62 | 1/3/1+3 |
| | | Band 3 | 27Mbps | 102/110/134 | 1/3/1+3 |
| | 11a/BPSK | Band 2 | 6Mbps | 52/60/64 | 1/3/1+3 |
| | | Band 3 | 6Mbps | 100/116/140 | 1/3/1+3 |
| 26dB Spectrum Bandwidth 99% Occupied Bandwidth Measurement Peak Excursion | MCS8/20MHz | Band 2 | 13Mbps | 52/60/64 | 1+3 |
| | | Band 3 | 13Mbps | 100/116/140 | 1+3 |
| | MCS8/40MHz | Band 2 | 27Mbps | 54/62 | 1+3 |
| | | Band 3 | 27Mbps | 102/110/134 | 1+3 |
| | 11a/BPSK | Band 2 | 6Mbps | 52/60/64 | 1+3 |
| | | Band 3 | 6Mbps | 100/116/140 | 1+3 |
| Radiated Emission Below 1GHz | Normal Link | | Auto | - | - |
| Radiated Emission Above 1GHz | MCS8/20MHz | Band 2 | 13Mbps | 52/60/64 | 1+3 |
| | | Band 3 | 13Mbps | 100/116/140 | 1+3 |
| | MCS8/40MHz | Band 2 | 27Mbps | 54/62 | 1+3 |
| | | Band 3 | 27Mbps | 102/110/134 | 1+3 |
| | 11a/BPSK | Band 2 | 6Mbps | 52/60/64 | 1+3 |
| | | Band 3 | 6Mbps | 100/116/140 | 1+3 |
| Band Edge Emission | MCS8/20MHz | Band 2 | 13Mbps | 52/60/64 | 1+3 |
| | | Band 3 | 13Mbps | 100/140 | 1+3 |
| | MCS8/40MHz | Band 2 | 27Mbps | 54/62 | 1+3 |
| | | Band 3 | 27Mbps | 102/134 | 1+3 |
| | 11a/BPSK | Band 2 | 6Mbps | 52/60/64 | 1+3 |
| | | Band 3 | 6Mbps | 100/140 | 1+3 |
| Frequency Stability | Un-modulation | | - | 60 | N/A |

Note: Antenna 4 is outdoor use antenna, it is only used in Band 2, Band 3 and Band 4 of 5GHz Band.

For Conducted Emission test:

Due to Ant. 3 is the highest gain antenna, it was selected to test and record in the report.

Note: The different antenna will not affect the test result of Conducted emission test.

For Radiated Emission test below 1GHz:

Due to Ant. 3 is the highest gain antenna, it was selected to test and record in the report.

For Radiated Emission test above 1GHz:

All antennas were tested and recorded in the report.

3.6. Table for Testing Locations

| Test Site No. | Site Category | Location | FCC Reg. No. | IC File No. | VCCI Reg. No |
|---------------|---------------|----------|--------------|-------------|--------------|
| 03CH01-CB | SAC | Hsin Chu | 262045 | IC 4086D | - |
| CO01-CB | Conduction | Hsin Chu | 262045 | IC 4086D | - |
| TH01-CB | OVEN Room | Hsin Chu | - | - | - |

Open Area Test Site (OATS); Semi Anechoic Chamber (SAC); Fully Anechoic Chamber (FAC).

Please refer section 6 for Test Site Address.

3.7. Table for Supporting Units

| Support Unit | Brand | Model | FCC ID |
|--------------|--------|------------|----------------|
| Notebook | DELL | D420 | E2KWM3945ABG |
| Mouse | iCooky | AMS0706W | DoC |
| Modem | ACEEX | DM1414 | IFAXDM1414 |
| Wireless AP | Planex | GW-AP54SGX | N/A |
| Notebook | DELL | D400 | QDS-BRCM1005-D |
| Notebook | DELL | D400 | E2K24GBRL |

3.8. Table for Parameters of Test Software Setting

During testing, Channel & Power Controlling Software provided by the customer was used to control the operating channel as well as the output power level. The RF output power selection is for the setting of RF output power expected by the customer and is going to be fixed on the firmware of the final end product.

< For Ant. 3 >

Power Parameters of IEEE 802.11n MCS8 20MHz

| Test Software Version | ART Revision 0.9 BUILD#34 | | | | | | | | |
|-----------------------|---------------------------|-------------|-------------|-------------|-------------|-------------|-------------|-------------|-------------|
| Frequency | 5180 MHz | 5200 MHz | 5240 MHz | 5260 MHz | 5300 MHz | 5320 MHz | 5500 MHz | 5580 MHz | 5700 MHz |
| MCS8 20MHz | 13 | 13.5 | 13.5 | 20 | 20 | 16 | 18 | 20.5 | 14 |

Power Parameters of IEEE 802.11n MCS8 40MHz

| Test Software Version | ART Revision 0.9 BUILD#34 | | | | | | |
|-----------------------|---------------------------|----------|----------|----------|----------|----------|----------|
| Frequency | 5190 MHz | 5230 MHz | 5270 MHz | 5310 MHz | 5510 MHz | 5550 MHz | 5670 MHz |
| MCS8 40MHz | 12 | 13 | 19 | 12.5 | 15 | 19.5 | 15 |

Power Parameters of IEEE 802.11a

| Test Software Version | ART Revision 0.9 BUILD#34 | | | | | | | | |
|-----------------------|---------------------------|-------------|-------------|-------------|-------------|-------------|-------------|-------------|-------------|
| Frequency | 5180 MHz | 5200 MHz | 5240 MHz | 5260 MHz | 5300 MHz | 5320 MHz | 5500 MHz | 5580 MHz | 5700 MHz |
| IEEE 802.11a | 10. | 10.0 | 10.5 | 17.0 | 17.0 | 16.0 | 17.5 | 17.5 | 14.0 |

During the test, "ART Revision 0.9 BUILD#34" under WIN XP was executed the test program to control the EUT continuously transmit RF signal.

< For Ant. 4 >

Power Parameters of IEEE 802.11n MCS8 20MHz

| Test Software Version | ART Revision 0.9 BUILD#34 | | | | | |
|-----------------------|---------------------------|----------|----------|----------|----------|----------|
| Frequency | 5260 MHz | 5300 MHz | 5320 MHz | 5500 MHz | 5580 MHz | 5700 MHz |
| MCS8 20MHz | 10.5 | 10.5 | 10.5 | 11.5 | 11.5 | 8.5 |

Power Parameters of IEEE 802.11n MCS8 40MHz

| Test Software Version | ART Revision 0.9 BUILD#34 | | | | |
|-----------------------|---------------------------|----------|----------|----------|----------|
| Frequency | 5270 MHz | 5310 MHz | 5510 MHz | 5550 MHz | 5670 MHz |
| MCS8 40MHz | 10.5 | 4 | 4 | 11.5 | 11 |

Power Parameters of IEEE 802.11a

| Test Software Version | ART Revision 0.9 BUILD#34 | | | | | |
|-----------------------|---------------------------|----------|----------|----------|----------|----------|
| Frequency | 5260 MHz | 5300 MHz | 5320 MHz | 5500 MHz | 5580 MHz | 5700 MHz |
| IEEE 802.11a | 7.5 | 7.0 | 7.0 | 7.5 | 7.5 | 7.0 |

During the test, "ART Revision 0.9 BUILD#34" under WIN XP was executed the test program to control the EUT continuously transmit RF signal.

3.9. Test Configurations

3.9.1. Radiation Emissions Test Configuration

Test Configuration: 30MHz ~ 1GHz

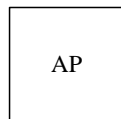
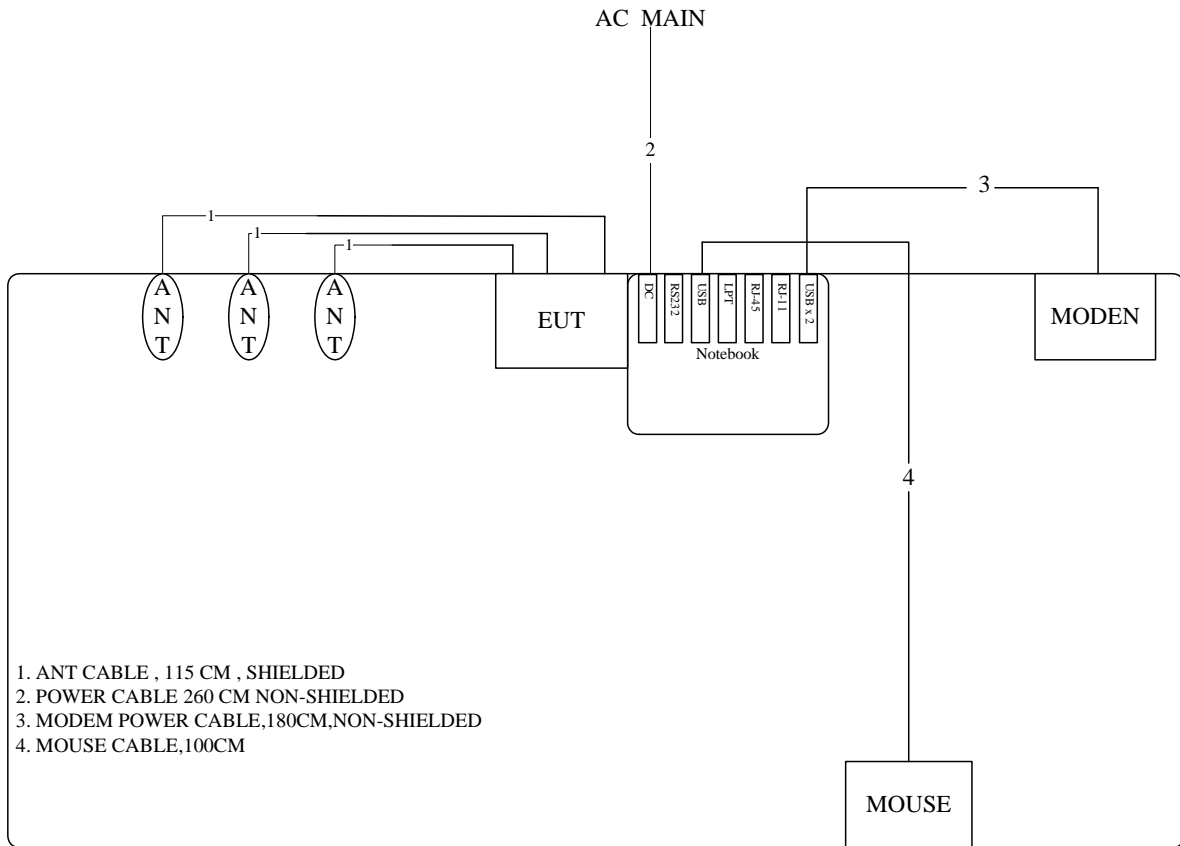

Test Configuration: above 1GHz

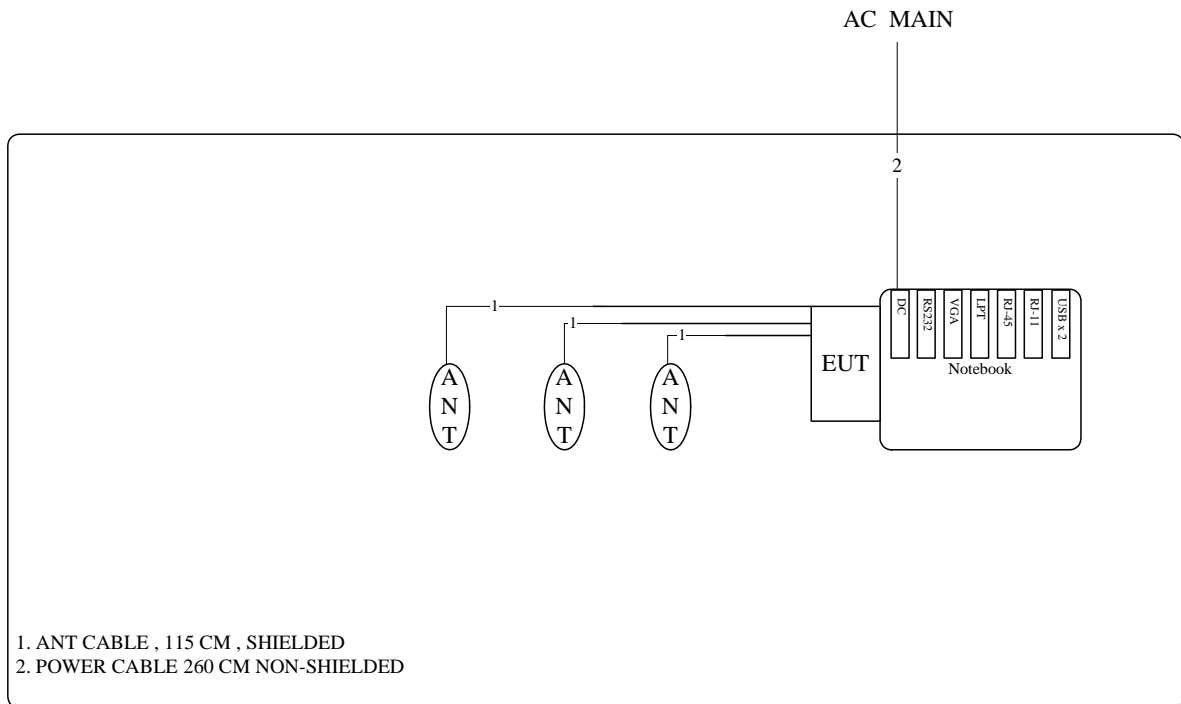

3.9.2. AC Power Line Conduction Emissions Test Configuration

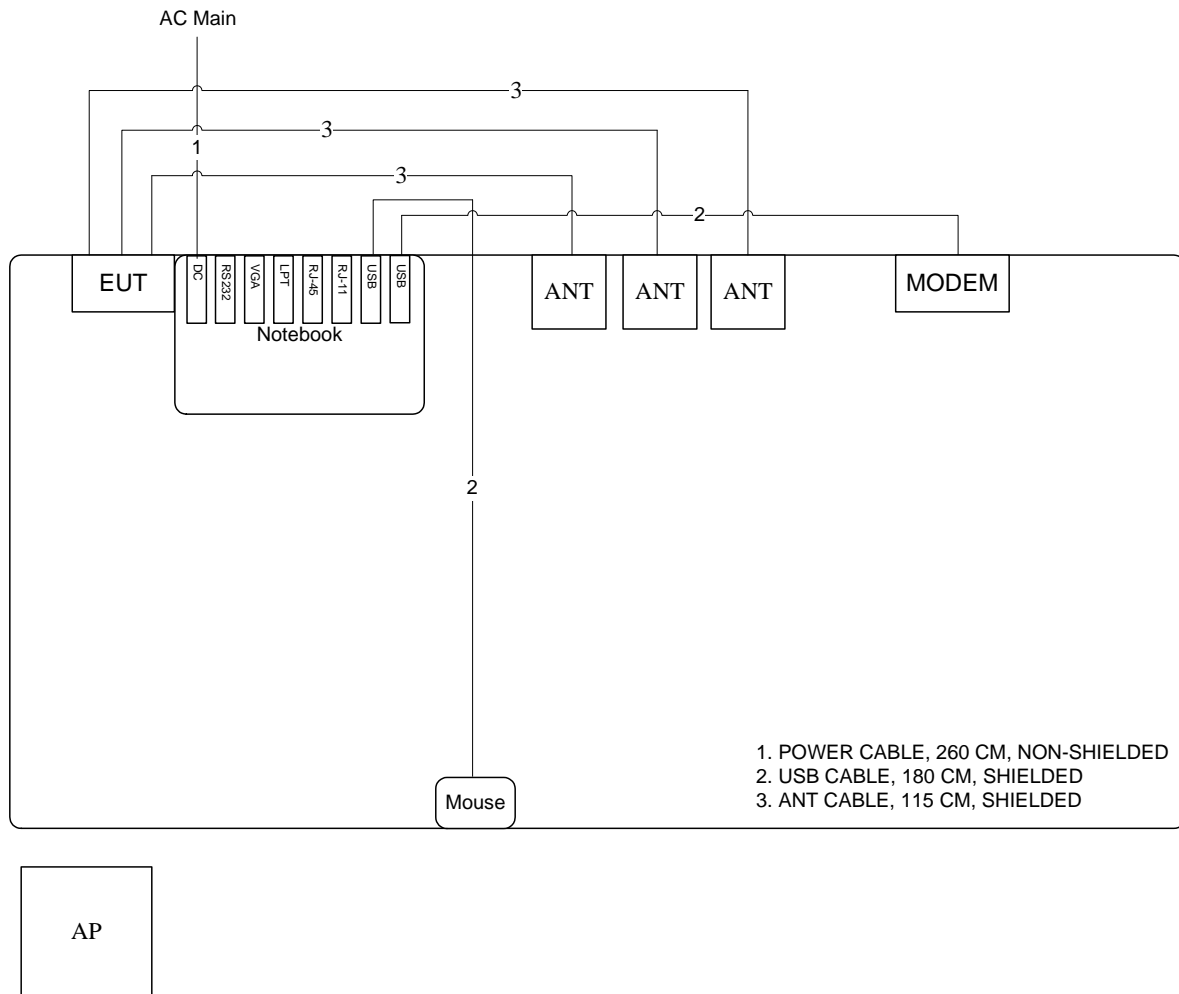

4. TEST RESULT

4.1. AC Power Line Conducted Emissions Measurement

4.1.1. Limit

For this product that is designed to connect to the AC power line, the radio frequency voltage that is conducted back onto the AC power line on any frequency or frequencies within the band 150 kHz to 30 MHz shall not exceed below limits table.

| Frequency (MHz) | QP Limit (dBuV) | AV Limit (dBuV) |
|-----------------|-----------------|-----------------|
| 0.15~0.5 | 66~56 | 56~46 |
| 0.5~5 | 56 | 46 |
| 5~30 | 60 | 50 |

4.1.2. Measuring Instruments and Setting

Please refer to section 5 of equipments list in this report. The following table is the setting of the receiver.

| Receiver Parameters | Setting |
|---------------------|----------|
| Attenuation | 10 dB |
| Start Frequency | 0.15 MHz |
| Stop Frequency | 30 MHz |
| IF Bandwidth | 9 KHz |

4.1.3. Test Procedures

1. Configure the EUT according to ANSI C63.10. The EUT or host of EUT has to be placed 0.4 meter far from the conducting wall of the shielding room and at least 80 centimeters from any other grounded conducting surface.
2. Connect EUT or host of EUT to the power mains through a line impedance stabilization network (LISN).
3. All the support units are connected to the other LISNs. The LISN should provide 50uH/50ohms coupling impedance.
4. The frequency range from 150 KHz to 30 MHz was searched.
5. Set the test-receiver system to Peak Detect Function and Specified Bandwidth with Maximum Hold Mode.
6. The measurement has to be done between each power line and ground at the power terminal.

4.1.4. Test Setup Layout

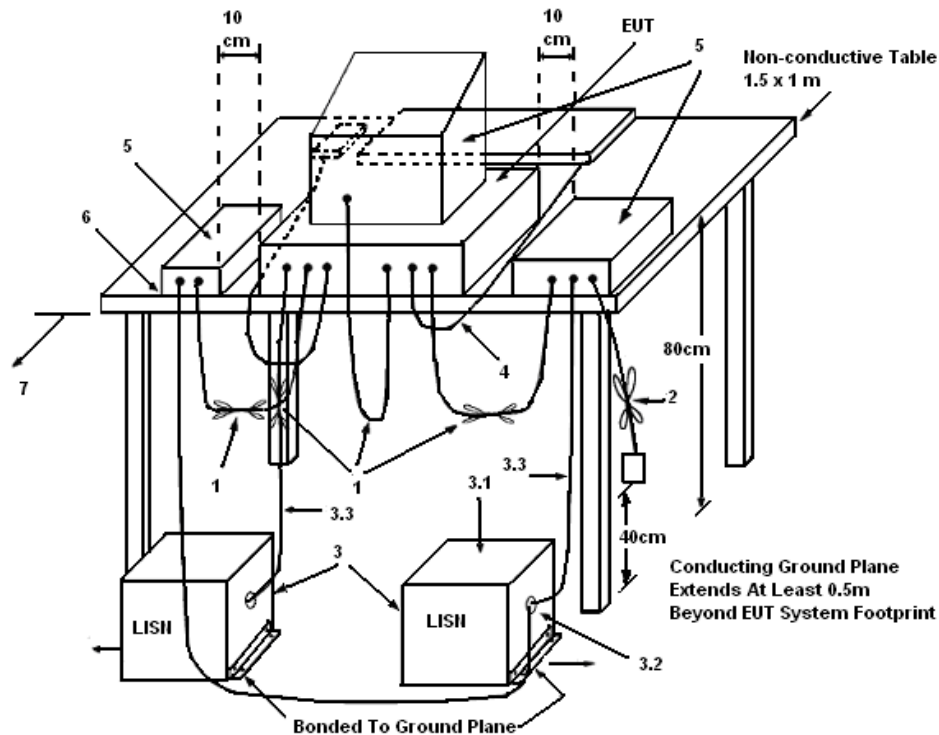

LEGEND:

- (1) Interconnecting cables that hang closer than 40 cm to the ground plane shall be folded back and forth in the center forming a bundle 30 to 40 cm long.
- (2) I/O cables that are not connected to a peripheral shall be bundled in the center. The end of the cable may be terminated, if required, using the correct terminating impedance. The overall length shall not exceed 1 m.
- (3) EUT connected to one LISN. Unused LISN measuring port connectors shall be terminated in 50 Ω . LISN can be placed on top of, or immediately beneath, reference ground plane.
 - (3.1) All other equipment powered from additional LISN(s).
 - (3.2) Multiple outlet strip can be used for multiple power cords of non-EUT equipment.
 - (3.3) LISN at least 80 cm from nearest part of EUT chassis.
- (4) Cables of hand-operated devices, such as keyboards, mice, etc., shall be placed as for normal use.
- (5) Non-EUT components of EUT system being tested.
- (6) Rear of EUT, including peripherals, shall all be aligned and flush with rear of tabletop.
- (7) Rear of tabletop shall be 40 cm removed from a vertical conducting plane that is bonded to the ground plane.

4.1.5. Test Deviation

There is no deviation with the original standard.

4.1.6. EUT Operation during Test

The EUT was placed on the test table and programmed in normal function.

4.1.7. Results of AC Power Line Conducted Emissions Measurement

| | | | |
|---------------|-------------|----------|------|
| Temperature | 24°C | Humidity | 55% |
| Test Engineer | Ryo Fan | Phase | Line |
| Configuration | Normal Link | | |

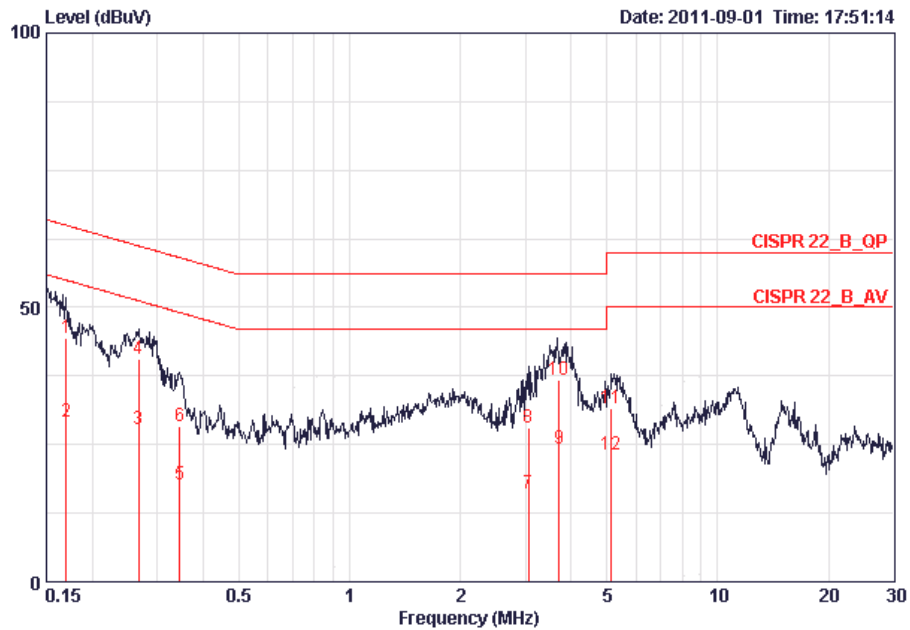

| | Freq | Level | Over Limit | Limit Line | Read Level | LISN Factor | Cable Loss | Remark |
|----|---------|-------|------------|------------|------------|-------------|------------|---------|
| | MHz | dBuV | dB | dBuV | dBuV | dB | dB | |
| 1 | 0.16944 | 44.32 | -20.66 | 64.99 | 44.06 | 0.06 | 0.20 | QP |
| 2 | 0.16944 | 29.22 | -25.76 | 54.99 | 28.96 | 0.06 | 0.20 | AVERAGE |
| 3 | 0.26724 | 27.68 | -23.52 | 51.20 | 27.44 | 0.04 | 0.20 | AVERAGE |
| 4 | 0.26724 | 40.57 | -20.63 | 61.20 | 40.33 | 0.04 | 0.20 | QP |
| 5 | 0.34463 | 17.61 | -31.48 | 49.09 | 17.38 | 0.03 | 0.20 | AVERAGE |
| 6 | 0.34463 | 28.37 | -30.72 | 59.09 | 28.14 | 0.03 | 0.20 | QP |
| 7 | 3.058 | 16.06 | -29.94 | 46.00 | 15.77 | 0.08 | 0.21 | AVERAGE |
| 8 | 3.058 | 28.06 | -27.94 | 56.00 | 27.77 | 0.08 | 0.21 | QP |
| 9 | 3.701 | 24.19 | -21.81 | 46.00 | 23.80 | 0.09 | 0.30 | AVERAGE |
| 10 | 3.701 | 36.91 | -19.09 | 56.00 | 36.52 | 0.09 | 0.30 | QP |
| 11 | 5.139 | 31.54 | -28.46 | 60.00 | 31.07 | 0.17 | 0.30 | QP |
| 12 | 5.139 | 23.25 | -26.75 | 50.00 | 22.78 | 0.17 | 0.30 | AVERAGE |

| | | | |
|---------------|-------------|----------|---------|
| Temperature | 24°C | Humidity | 55% |
| Test Engineer | Ryo Fan | Phase | Neutral |
| Configuration | Normal Link | | |

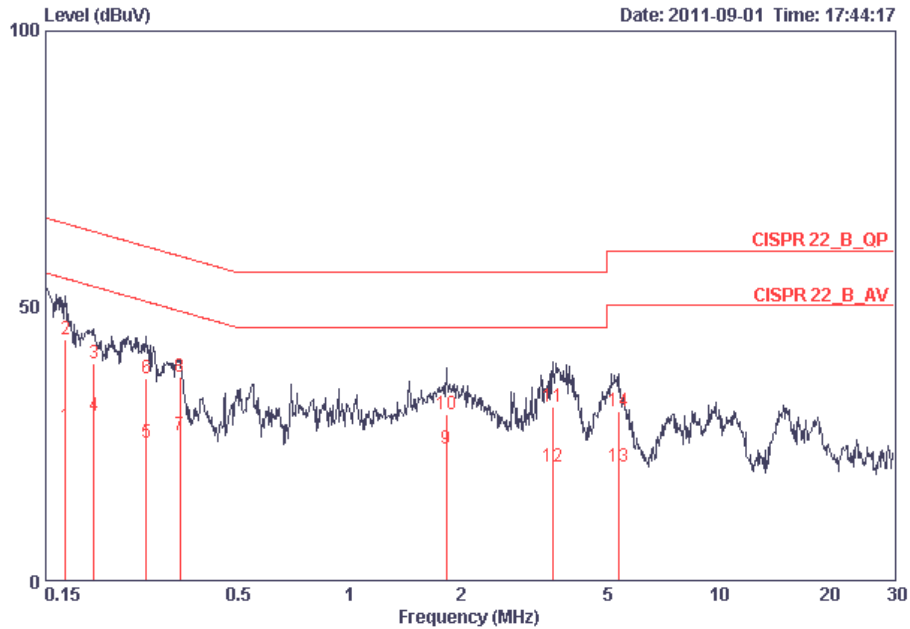

| | Freq | Level | Over | Limit | Read | LISN | Cable | Remark |
|----|---------|-------|--------|-------|-------|--------|-------|---------|
| | MHz | dBuV | Limit | Line | Level | Factor | Loss | |
| | | | dB | dBuV | dBuV | dB | dB | |
| 1 | 0.16944 | 28.04 | -26.94 | 54.99 | 27.75 | 0.09 | 0.20 | AVERAGE |
| 2 | 0.16944 | 43.97 | -21.01 | 64.99 | 43.68 | 0.09 | 0.20 | QP |
| 3 | 0.20289 | 39.61 | -23.88 | 63.49 | 39.33 | 0.08 | 0.20 | QP |
| 4 | 0.20289 | 30.00 | -23.49 | 53.49 | 29.72 | 0.08 | 0.20 | AVERAGE |
| 5 | 0.28178 | 24.96 | -25.81 | 50.76 | 24.68 | 0.08 | 0.20 | AVERAGE |
| 6 | 0.28178 | 36.78 | -23.99 | 60.76 | 36.50 | 0.08 | 0.20 | QP |
| 7 | 0.34646 | 26.55 | -22.49 | 49.05 | 26.28 | 0.07 | 0.20 | AVERAGE |
| 8 | 0.34646 | 37.15 | -21.89 | 59.05 | 36.88 | 0.07 | 0.20 | QP |
| 9 | 1.829 | 24.02 | -21.98 | 46.00 | 23.76 | 0.09 | 0.17 | AVERAGE |
| 10 | 1.829 | 30.22 | -25.78 | 56.00 | 29.96 | 0.09 | 0.17 | QP |
| 11 | 3.565 | 31.52 | -24.48 | 56.00 | 31.09 | 0.13 | 0.30 | QP |
| 12 | 3.565 | 20.70 | -25.30 | 46.00 | 20.27 | 0.13 | 0.30 | AVERAGE |
| 13 | 5.362 | 20.61 | -29.39 | 50.00 | 20.09 | 0.22 | 0.30 | AVERAGE |
| 14 | 5.362 | 30.81 | -29.19 | 60.00 | 30.29 | 0.22 | 0.30 | QP |

Note:

Level = Read Level + LISN Factor + Cable Loss.

4.2. 99% Occupied Bandwidth Measurement

4.2.1. Limit

No restriction limits. But resolution bandwidth within band edge measurement is 1% of the 99% occupied bandwidth.

4.2.2. Measuring Instruments and Setting

Please refer to section 5 of equipments list in this report. The following table is the setting of the spectrum analyzer.

| Spectrum Parameters | Setting |
|---------------------|------------------|
| Attenuation | Auto |
| Span Frequency | > 26dB Bandwidth |
| RB | 300 kHz |
| VB | 1000 kHz |
| Detector | Peak |
| Trace | Max Hold |
| Sweep Time | Auto |

4.2.3. Test Procedures

1. The transmitter output (antenna port) was connected to the spectrum analyzer in peak hold mode.
2. The resolution bandwidth of 300 kHz and the video bandwidth of 1000 kHz were used.
3. Measured the spectrum width with power higher than 26dB below carrier.

4.2.4. Test Setup Layout

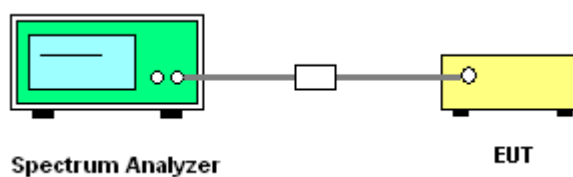

4.2.5. Test Deviation

There is no deviation with the original standard.

4.2.6. EUT Operation during Test

The EUT was programmed to be in continuously transmitting mode.

4.2.7. Test Result of 99% Occupied Bandwidth

< For Ant. 3 >

| | | | |
|----------------------|---------|-----------------------|-----------------------|
| Temperature | 25°C | Humidity | 56% |
| Test Engineer | Sean Ku | Configurations | IEEE 802.11n / Ant. 3 |

Configuration IEEE 802.11n MCS8 20MHz / Connector 1 + Connector 3

| Channel | Frequency | 26dB Bandwidth (MHz) | 99% Occupied Bandwidth (MHz) |
|---------|-----------|----------------------|------------------------------|
| 36 | 5180 MHz | 24.00 | 17.92 |
| 40 | 5200 MHz | 24.64 | 17.92 |
| 48 | 5240 MHz | 23.36 | 18.08 |
| 52 | 5260 MHz | 27.84 | 18.56 |
| 60 | 5300 MHz | 28.48 | 18.40 |
| 64 | 5320 MHz | 23.68 | 17.92 |
| 100 | 5500 MHz | 24.08 | 17.82 |
| 116 | 5580 MHz | 33.76 | 19.36 |
| 140 | 5700 MHz | 22.81 | 17.94 |

Configuration IEEE 802.11n MCS8 40MHz / Connector 1 + Connector 3

| Channel | Frequency | 26dB Bandwidth (MHz) | 99% Occupied Bandwidth (MHz) |
|---------|-----------|----------------------|------------------------------|
| 38 | 5190 MHz | 36.80 | 43.84 |
| 46 | 5230 MHz | 44.48 | 36.48 |
| 54 | 5270 MHz | 47.36 | 36.80 |
| 62 | 5310 MHz | 43.84 | 36.48 |
| 102 | 5510MHz | 41.68 | 36.35 |
| 110 | 5550 MHz | 71.68 | 37.12 |
| 134 | 5670 MHz | 43.99 | 36.58 |

< For Ant. 3 >

| | | | |
|----------------------|---------|-----------------------|-----------------------|
| Temperature | 25°C | Humidity | 56% |
| Test Engineer | Sean Ku | Configurations | IEEE 802.11a / Ant. 3 |

Configuration IEEE 802.11a / Connector 1 + Connector 3

| Channel | Frequency | 26dB Bandwidth (MHz) | 99% Occupied Bandwidth (MHz) |
|---------|-----------|----------------------|------------------------------|
| 36 | 5180 MHz | 23.84 | 17.44 |
| 40 | 5200 MHz | 23.84 | 17.28 |
| 48 | 5240 MHz | 23.04 | 17.28 |
| 52 | 5260 MHz | 23.84 | 17.44 |
| 60 | 5300 MHz | 24.16 | 17.44 |
| 64 | 5320 MHz | 23.84 | 17.44 |
| 100 | 5500 MHz | 22.81 | 17.82 |
| 116 | 5580 MHz | 26.08 | 17.60 |
| 140 | 5700 MHz | 23.27 | 17.94 |

< For Ant. 4 >

| | | | |
|----------------------|---------|-----------------------|-----------------------|
| Temperature | 25°C | Humidity | 56% |
| Test Engineer | Sean Ku | Configurations | IEEE 802.11n / Ant. 4 |

Configuration IEEE 802.11n MCS8 20MHz / Connector 1 + Connector 3

| Channel | Frequency | 26dB Bandwidth (MHz) | 99% Occupied Bandwidth (MHz) |
|---------|-----------|----------------------|------------------------------|
| 52 | 5260 MHz | 23.04 | 17.92 |
| 60 | 5300 MHz | 23.52 | 18.08 |
| 64 | 5320 MHz | 23.36 | 18.08 |
| 100 | 5500 MHz | 22.88 | 17.92 |
| 116 | 5580 MHz | 23.36 | 17.92 |
| 140 | 5700 MHz | 23.04 | 17.82 |

Configuration IEEE 802.11n MCS8 40MHz / Connector 1 + Connector 3

| Channel | Frequency | 26dB Bandwidth (MHz) | 99% Occupied Bandwidth (MHz) |
|---------|-----------|----------------------|------------------------------|
| 54 | 5270 MHz | 43.52 | 36.48 |
| 62 | 5310 MHz | 43.84 | 36.48 |
| 102 | 5510MHz | 41.91 | 36.35 |
| 110 | 5550 MHz | 44.48 | 36.48 |
| 134 | 5670 MHz | 45.12 | 36.48 |

< For Ant. 4 >

| | | | |
|----------------------|---------|-----------------------|-----------------------|
| Temperature | 25°C | Humidity | 56% |
| Test Engineer | Sean Ku | Configurations | IEEE 802.11a / Ant. 4 |

Configuration IEEE 802.11a / Connector 1 + Connector 3

| Channel | Frequency | 26dB Bandwidth (MHz) | 99% Occupied Bandwidth (MHz) |
|---------|-----------|----------------------|------------------------------|
| 52 | 5260 MHz | 21.44 | 16.64 |
| 60 | 5300 MHz | 22.08 | 16.64 |
| 64 | 5320 MHz | 21.60 | 16.64 |
| 100 | 5500 MHz | 22.72 | 17.12 |
| 116 | 5580 MHz | 23.36 | 17.28 |
| 140 | 5700 MHz | 20.96 | 16.32 |

< For Ant. 3 >

26 dB Bandwidth Plot on Configuration IEEE 802.11n MCS8 20MHz / Connector 1 + Connector 3/
Ant. 3 / 5180 MHz

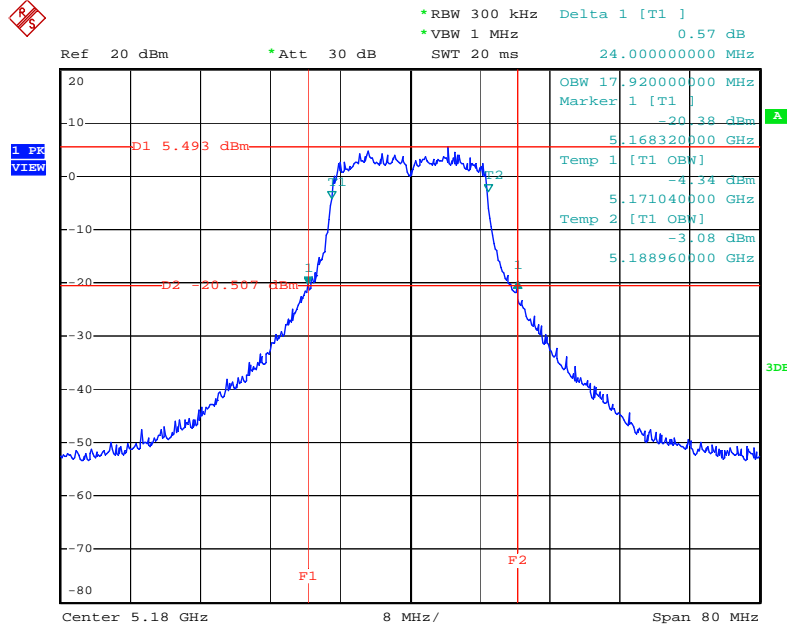

Date: 29.AUG.2011 17:10:17

26 dB Bandwidth Plot on Configuration IEEE 802.11n MCS8 20MHz / Connector 1 + Connector 3/
Ant. 3 / 5200 MHz

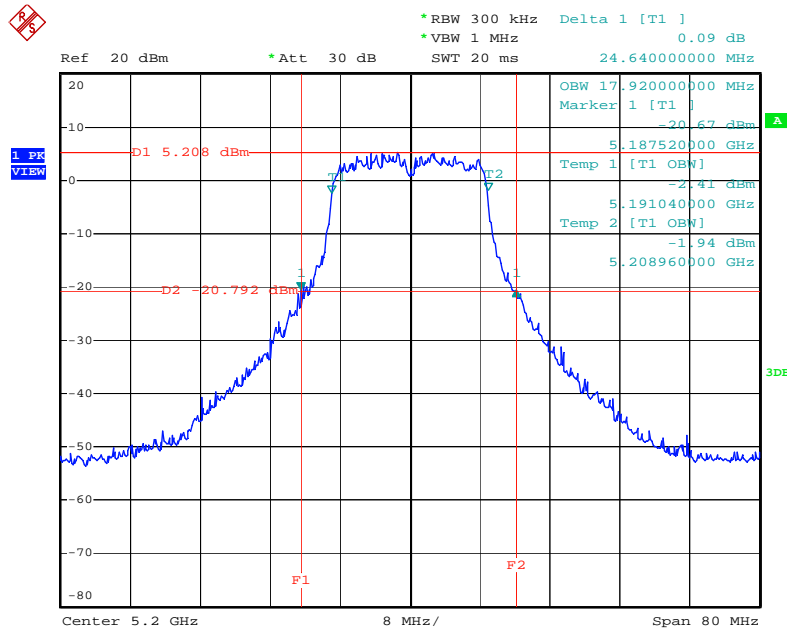

Date: 29.AUG.2011 17:11:08

< For Ant. 3 >

26 dB Bandwidth Plot on Configuration IEEE 802.11n MCS8 20MHz / Connector 1 + Connector 3/
Ant. 3 / 5240 MHz

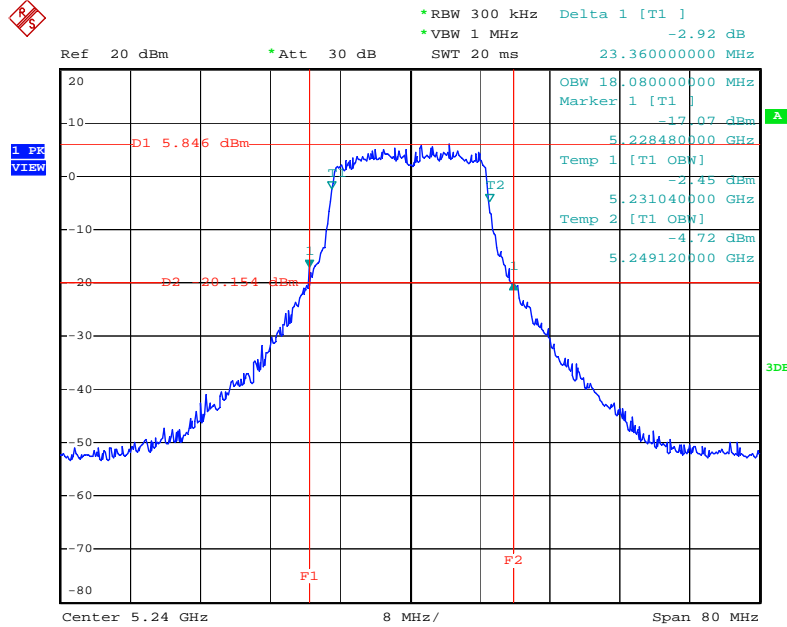

Date: 29.AUG.2011 17:11:41

26 dB Bandwidth Plot on Configuration IEEE 802.11n MCS8 20MHz / Connector 1 + Connector 3/
Ant. 3 / 5260 MHz

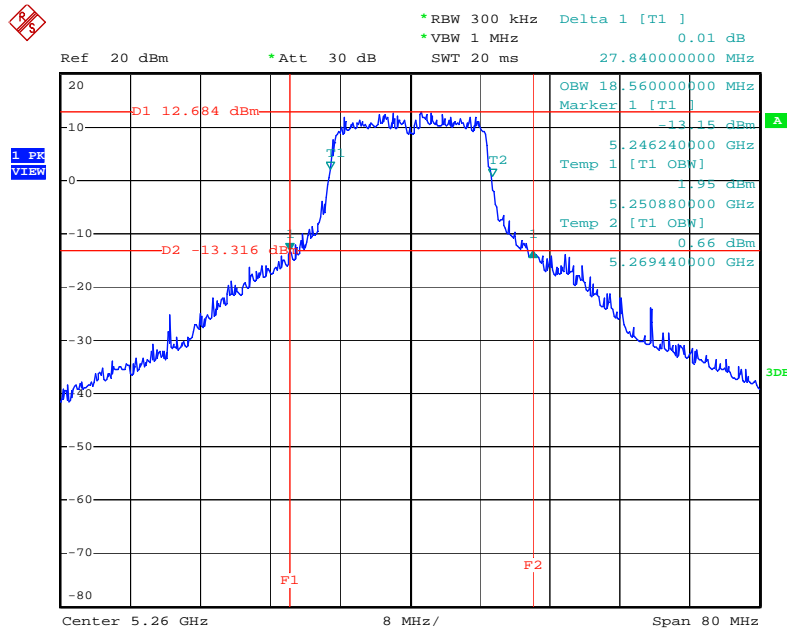

Date: 29.AUG.2011 17:12:40

< For Ant. 3 >

26 dB Bandwidth Plot on Configuration IEEE 802.11n MCS8 20MHz / Connector 1 + Connector 3/
Ant. 3 / 5300 MHz

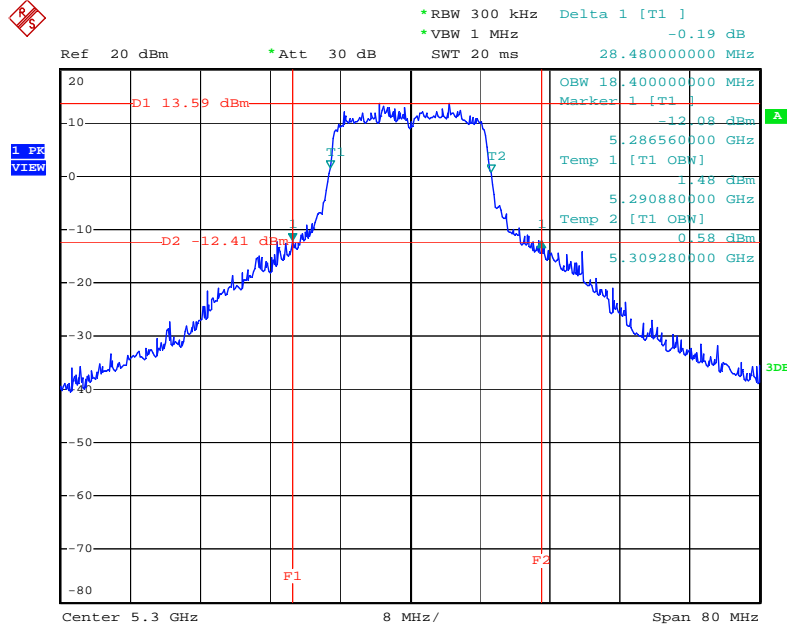

Date: 29.AUG.2011 17:13:15

26 dB Bandwidth Plot on Configuration IEEE 802.11n MCS8 20MHz / Connector 1 + Connector 3/
Ant. 3 / 5320 MHz

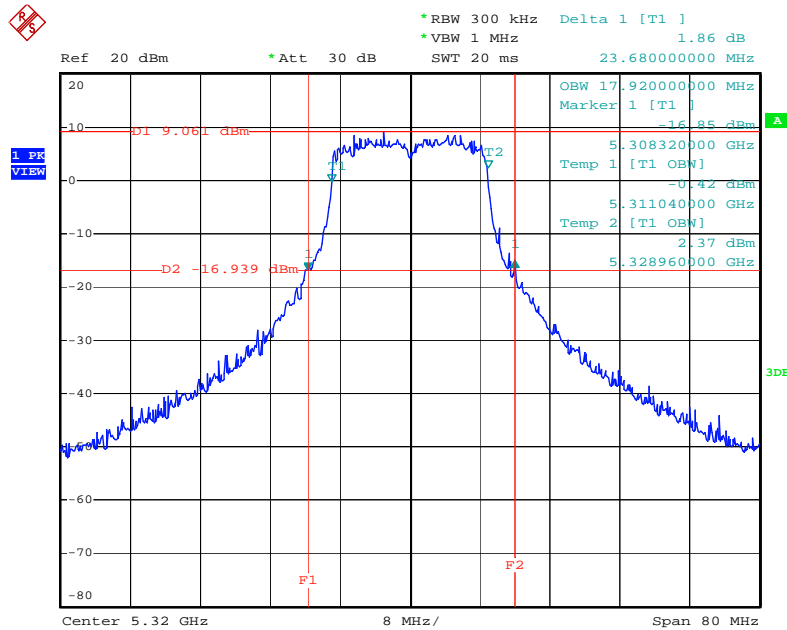

Date: 29.AUG.2011 17:13:53

< For Ant. 3 >

26 dB Bandwidth Plot on Configuration IEEE 802.11n MCS8 20MHz / Connector 1 + Connector 3/
Ant. 3 / 5500 MHz

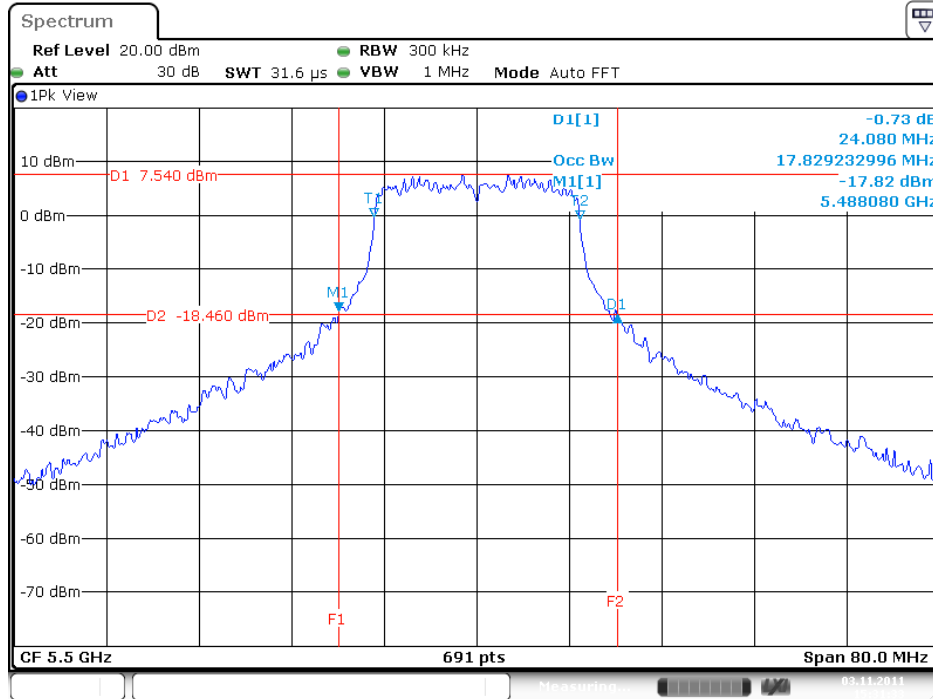

Date: 3.NOV.2011 15:31:34

26 dB Bandwidth Plot on Configuration IEEE 802.11n MCS8 20MHz / Connector 1 + Connector 3/
Ant. 3 / 5580 MHz

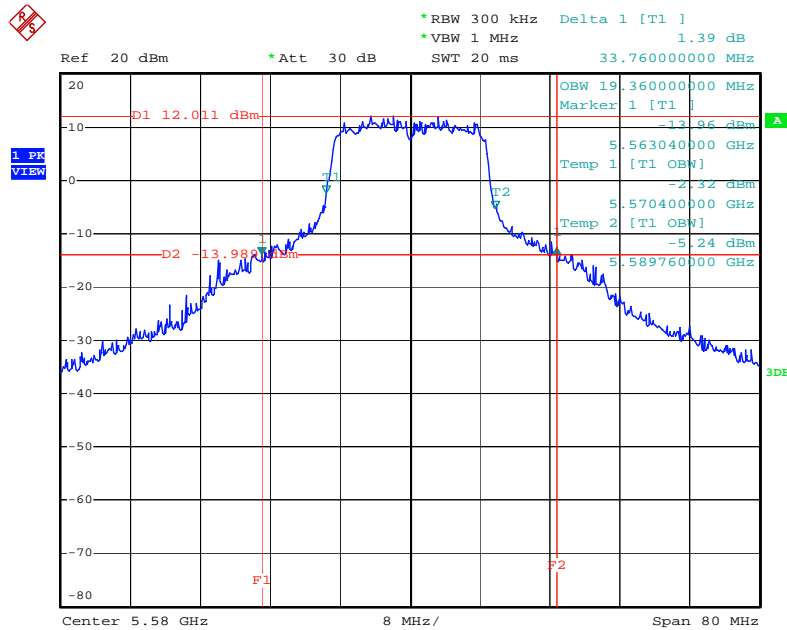

Date: 29.AUG.2011 17:36:12

< For Ant. 3 >

26 dB Bandwidth Plot on Configuration IEEE 802.11n MCS8 20MHz / Connector 1 + Connector 3/
Ant. 3 / 5700 MHz

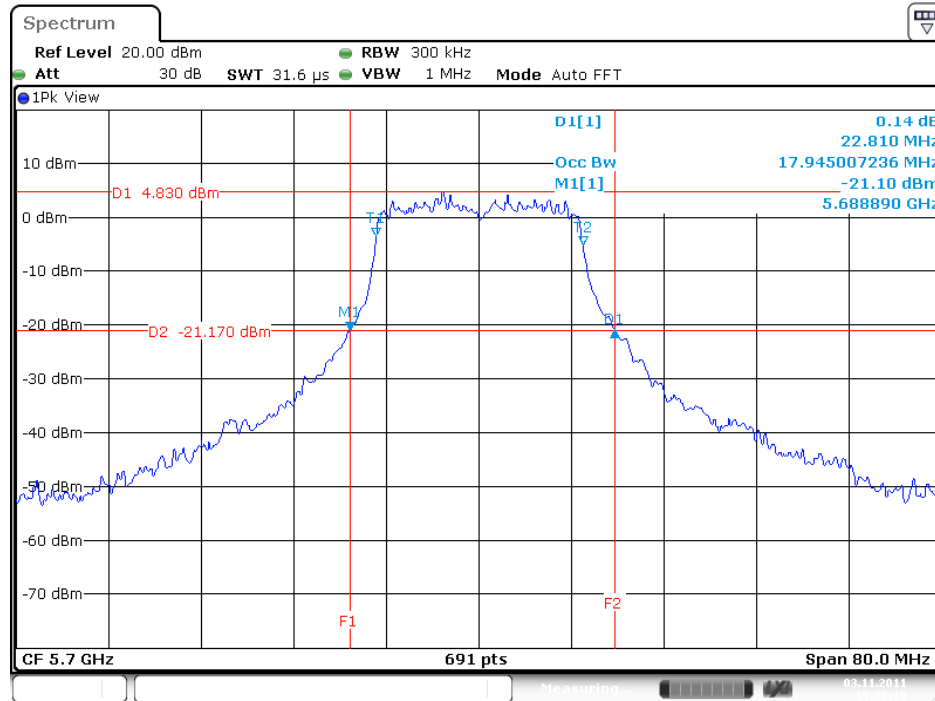

26 dB Bandwidth Plot on Configuration IEEE 802.11n MCS8 40MHz / Connector 1 + Connector 3/
Ant. 3 / 5190 MHz

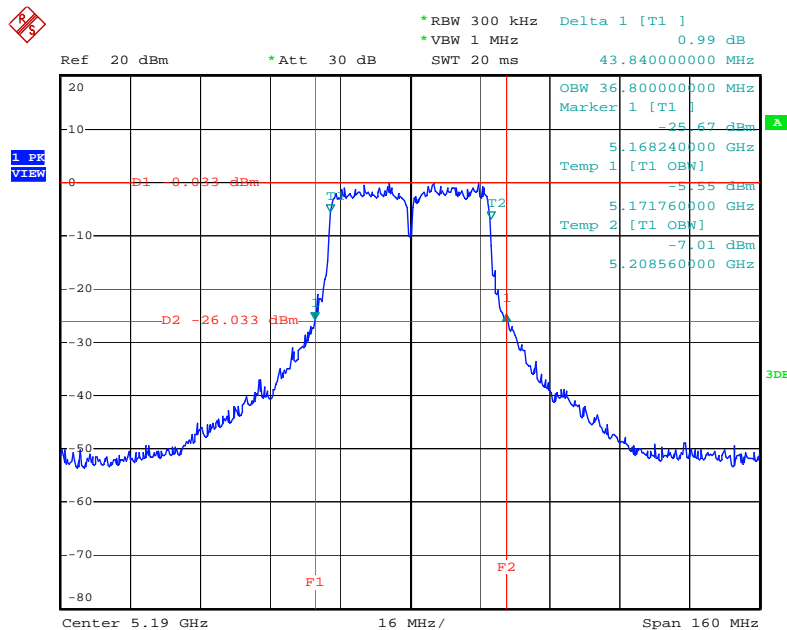

< For Ant. 3 >

26 dB Bandwidth Plot on Configuration IEEE 802.11n MCS8 40MHz / Connector 1 + Connector 3/
Ant. 3 / 5230 MHz

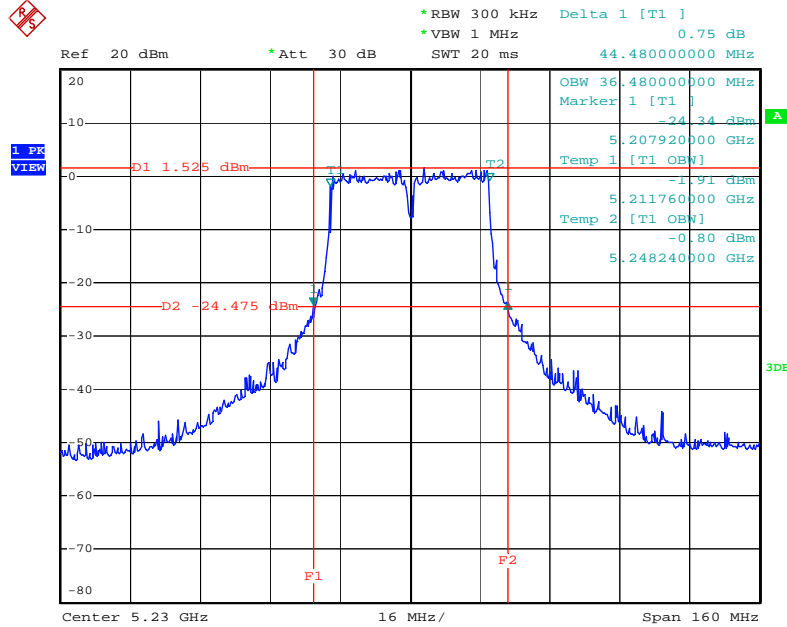

Date: 29.AUG.2011 17:56:17

26 dB Bandwidth Plot on Configuration IEEE 802.11n MCS8 40MHz / Connector 1 + Connector 3/
Ant. 3 / 5270 MHz

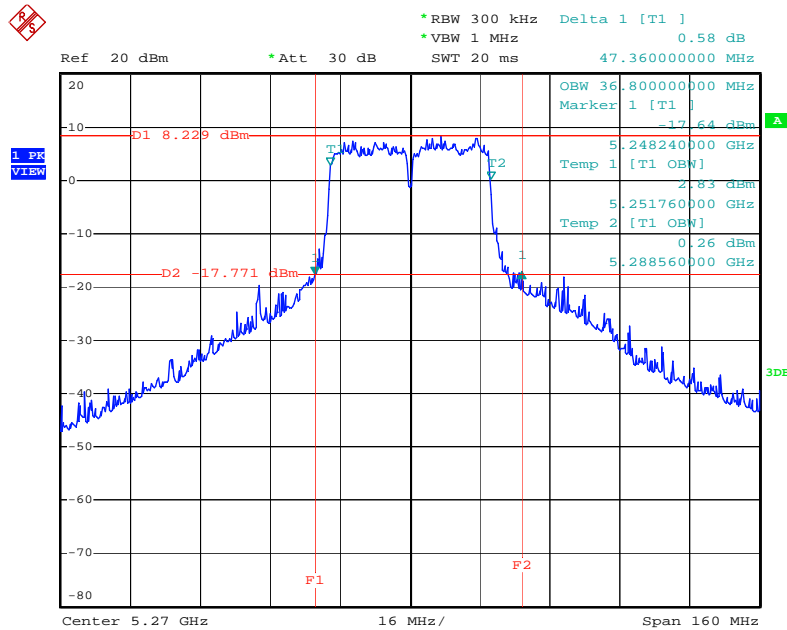

Date: 29.AUG.2011 17:57:19

< For Ant. 3 >

26 dB Bandwidth Plot on Configuration IEEE 802.11n MCS8 40MHz / Connector 1 + Connector 3/
Ant. 3 / 5310 MHz

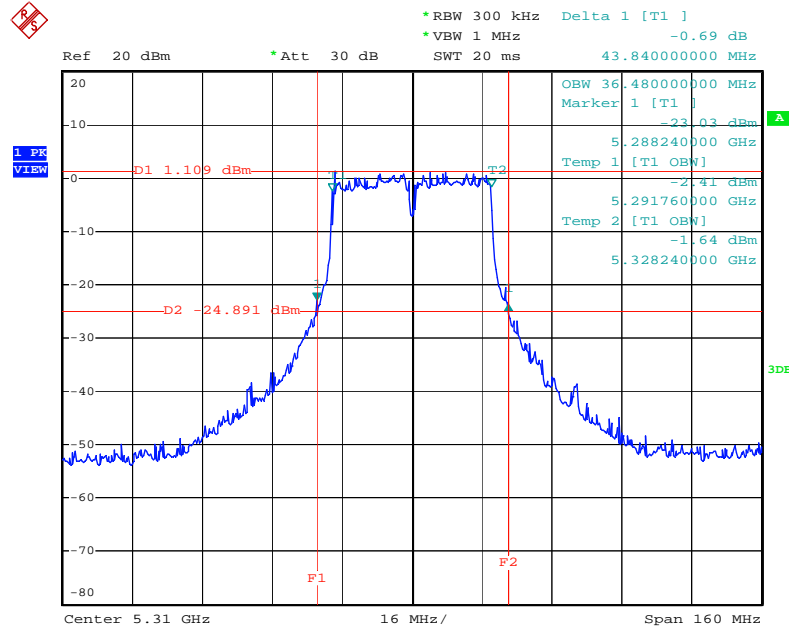

Date: 29.AUG.2011 17:58:04

26 dB Bandwidth Plot on Configuration IEEE 802.11n MCS8 40MHz / Connector 1 + Connector 3/
Ant. 3 / 5510MHz

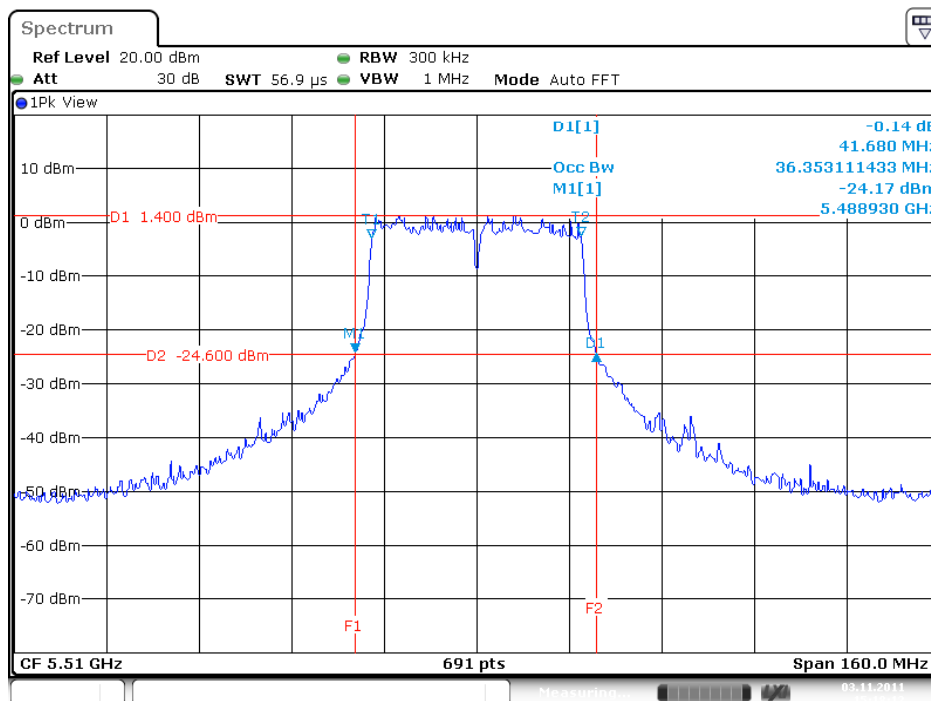

Date: 3.NOV.2011 15:18:12

< For Ant. 3 >

26 dB Bandwidth Plot on Configuration IEEE 802.11n MCS8 40MHz / Connector 1 + Connector 3/
Ant. 3 / 5550 MHz

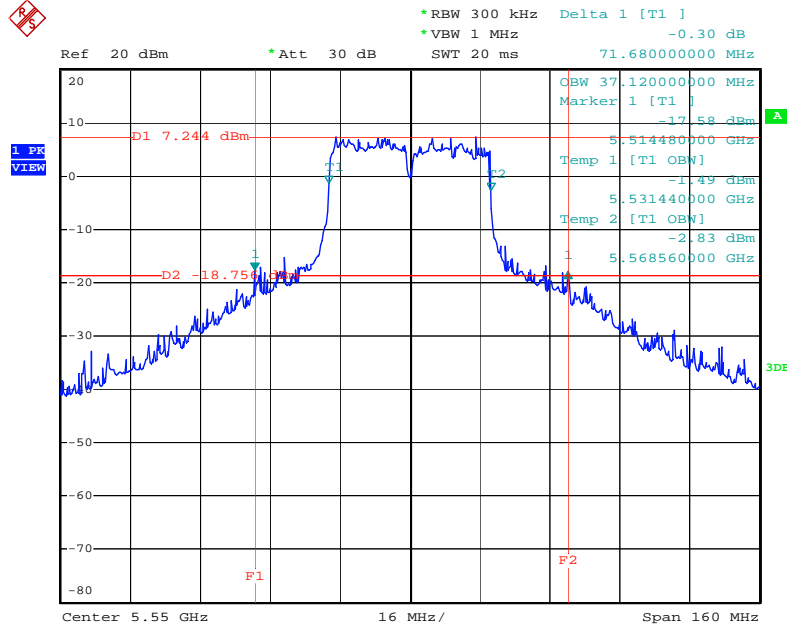

Date: 29.AUG.2011 18:00:12

26 dB Bandwidth Plot on Configuration IEEE 802.11n MCS8 40MHz / Connector 1 + Connector 3/
Ant. 3 / 5670 MHz

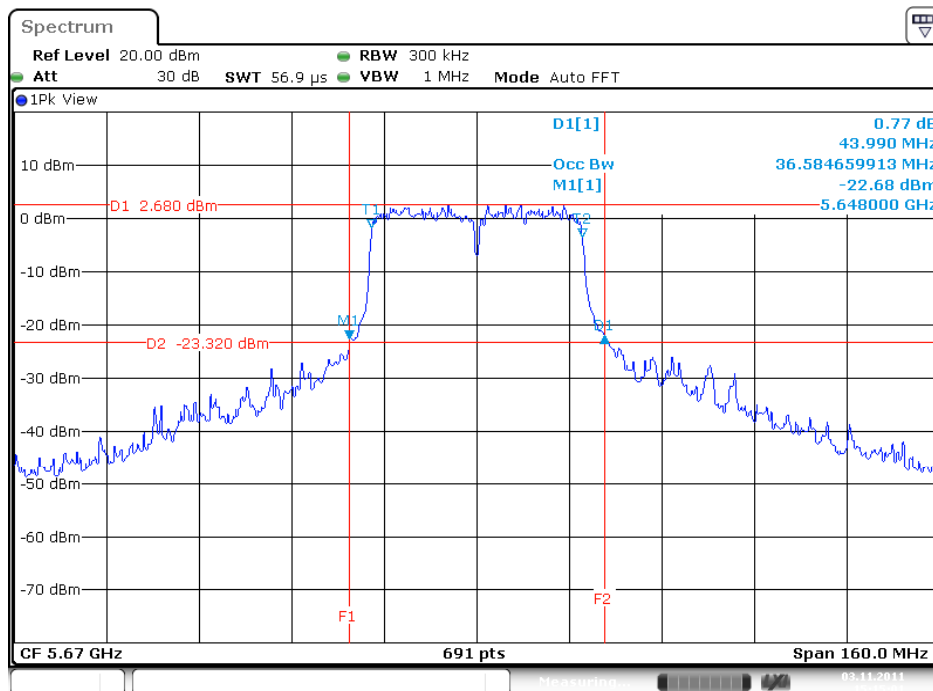

Date: 3.NOV.2011 15:15:01

< For Ant. 3 >

26 dB Bandwidth Plot on Configuration IEEE 802.11a / Connector 1 + Connector 3/ Ant. 3 / 5180 MHz

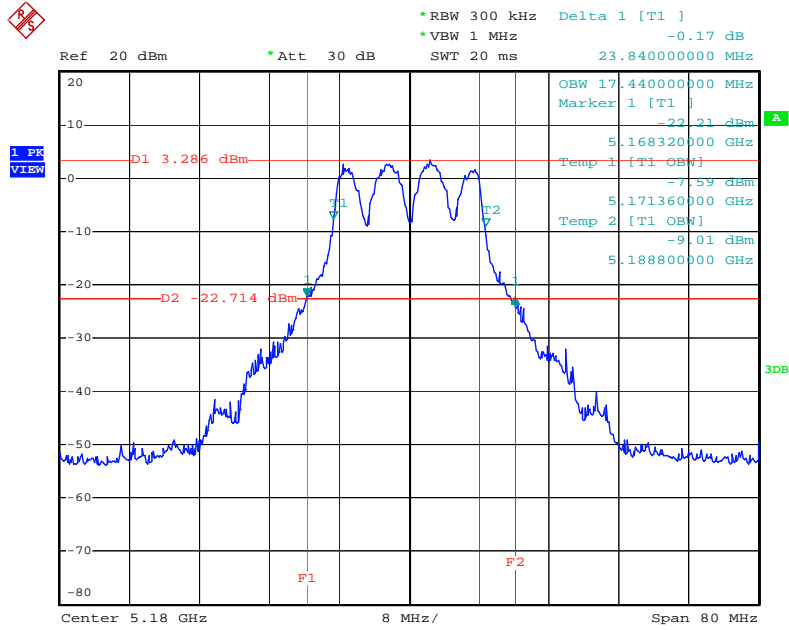

Date: 29.AUG.2011 16:59:36

26 dB Bandwidth Plot on Configuration IEEE 802.11a / Connector 1 + Connector 3/ Ant. 3 / 5200 MHz

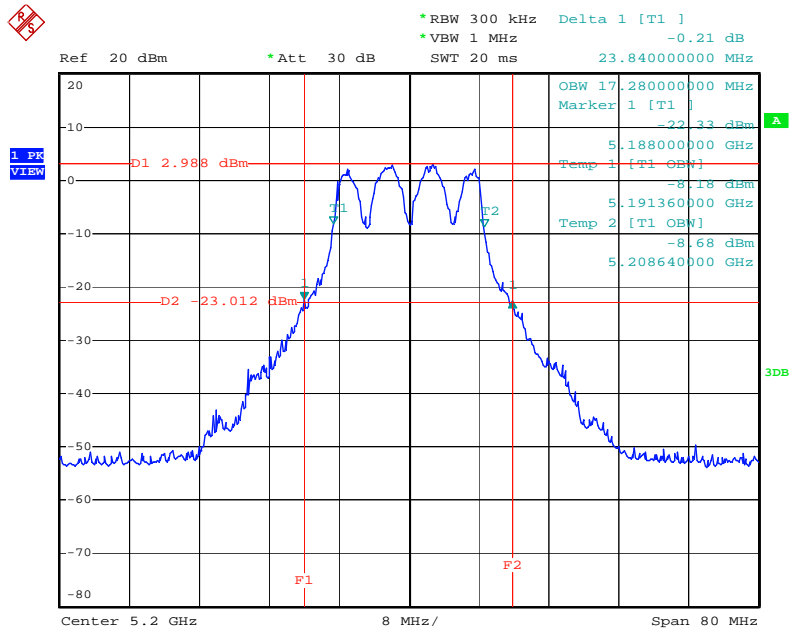

Date: 29.AUG.2011 17:00:36

< For Ant. 3 >

26 dB Bandwidth Plot on Configuration IEEE 802.11a / Connector 1 + Connector 3/ Ant. 3 / 5240 MHz

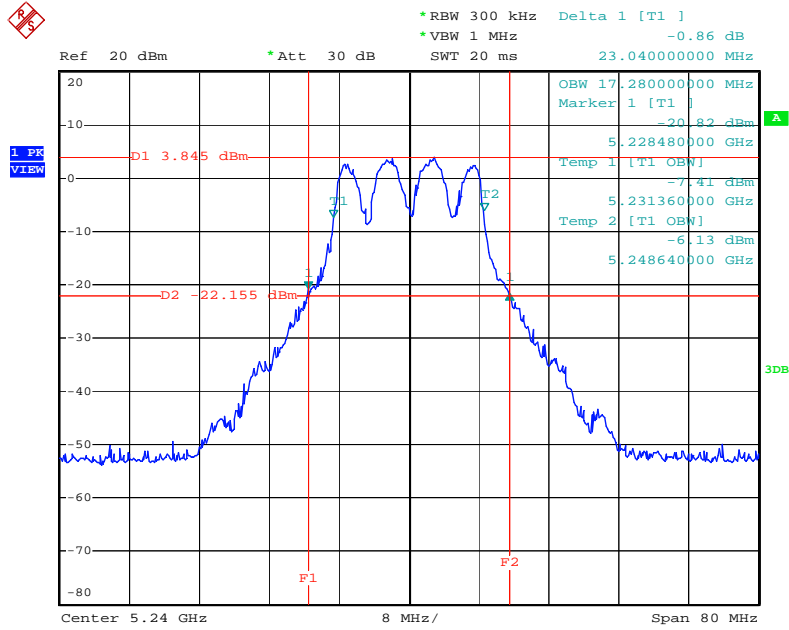

Date: 29.AUG.2011 17:02:24

26 dB Bandwidth Plot on Configuration IEEE 802.11a / Connector 1 + Connector 3/ Ant. 3 / 5260 MHz

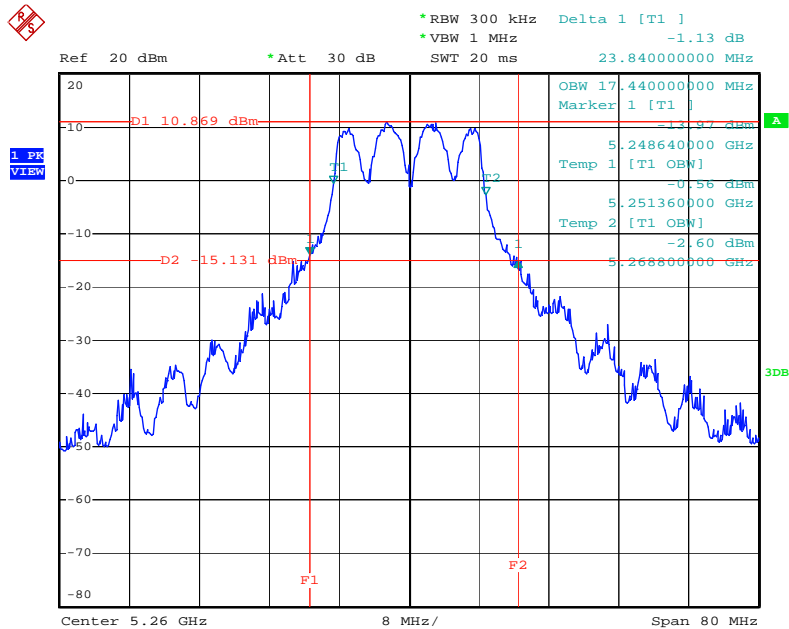

Date: 29.AUG.2011 17:03:54

< For Ant. 3 >

26 dB Bandwidth Plot on Configuration IEEE 802.11a / Connector 1 + Connector 3/ Ant. 3 / 5300 MHz

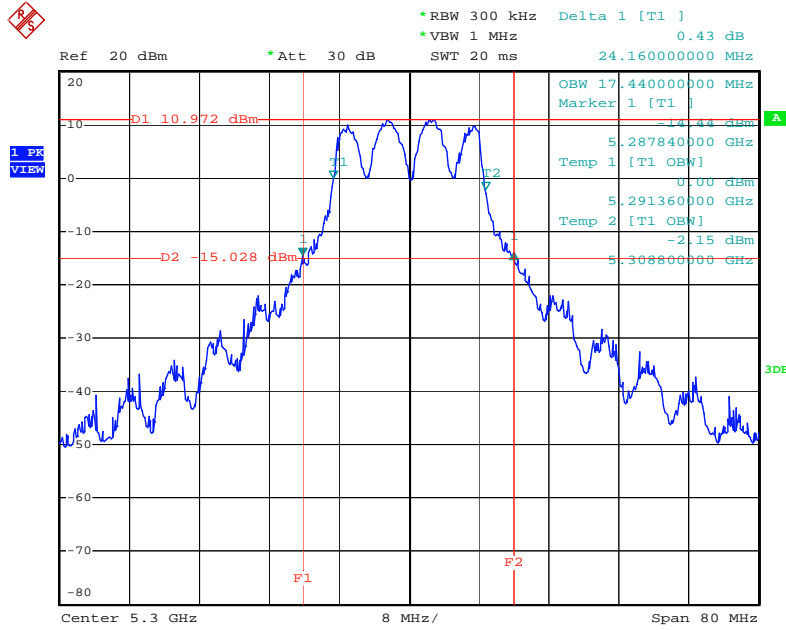

Date: 29.AUG.2011 17:04:38

26 dB Bandwidth Plot on Configuration IEEE 802.11a / Connector 1 + Connector 3/ Ant. 3 / 5320 MHz

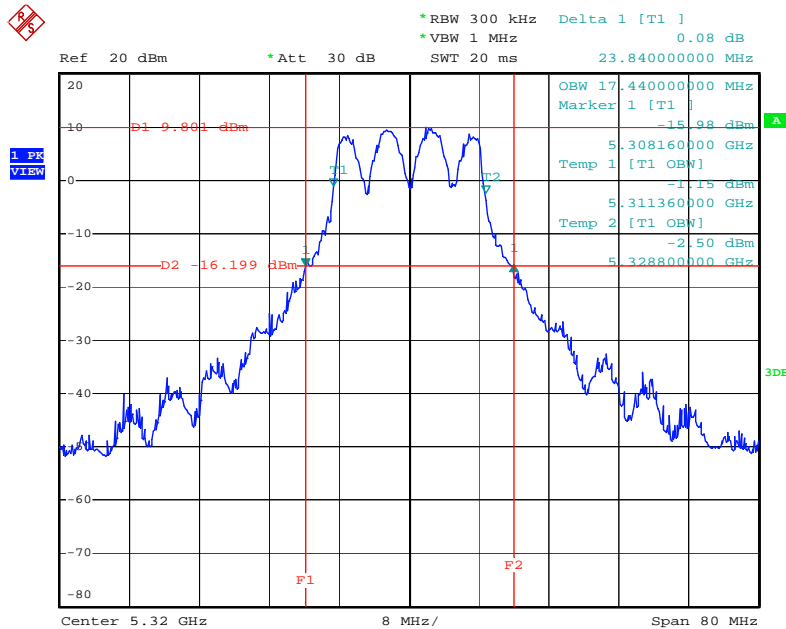

Date: 29.AUG.2011 17:05:13

< For Ant. 3 >

26 dB Bandwidth Plot on Configuration IEEE 802.11a / Connector 1 + Connector 3/ Ant. 3 / 5500 MHz

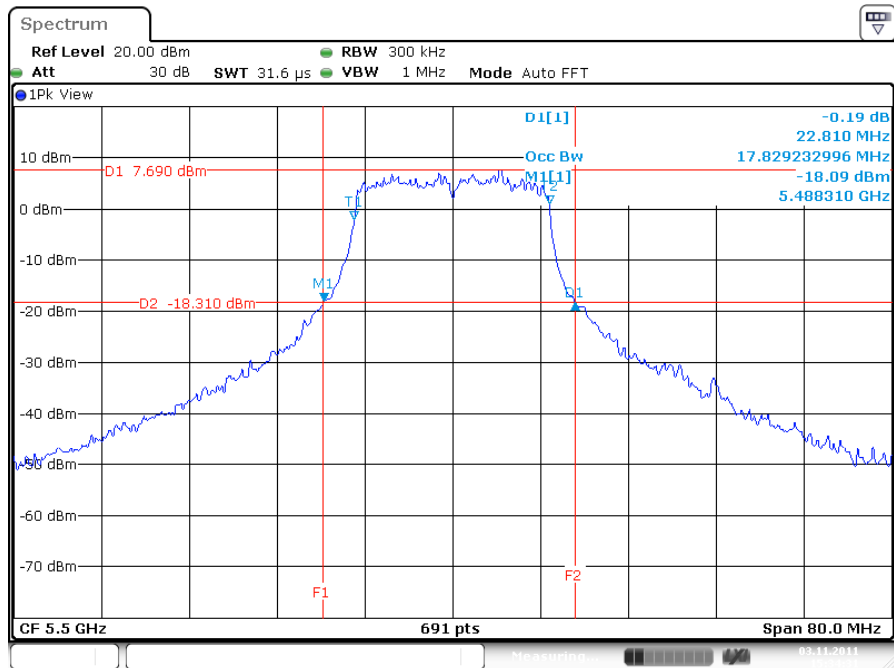

Date: 3.NOV.2011 15:34:31

26 dB Bandwidth Plot on Configuration IEEE 802.11a / Connector 1 + Connector 3/ Ant. 3 / 5580 MHz

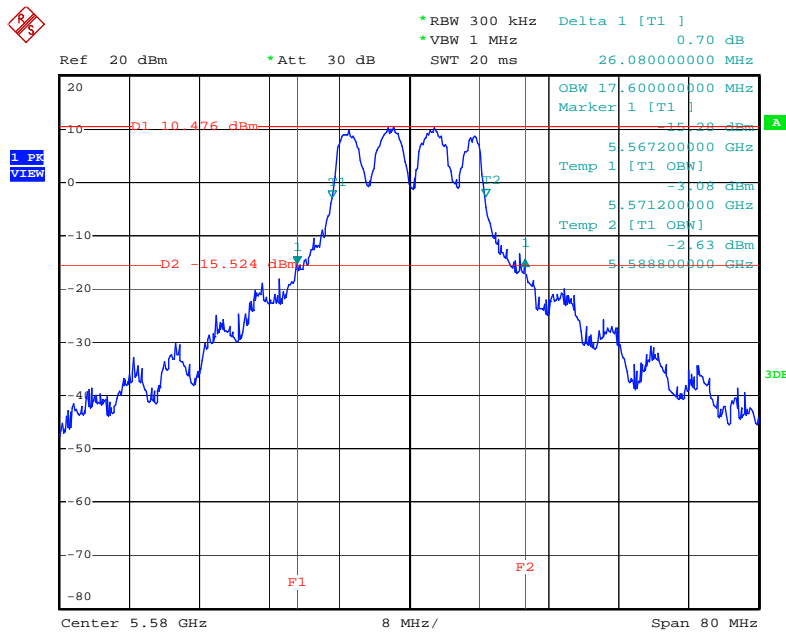

Date: 29.AUG.2011 17:07:26

< For Ant. 3 >

26 dB Bandwidth Plot on Configuration IEEE 802.11a / Connector 1 + Connector 3/ Ant. 3 / 5700 MHz

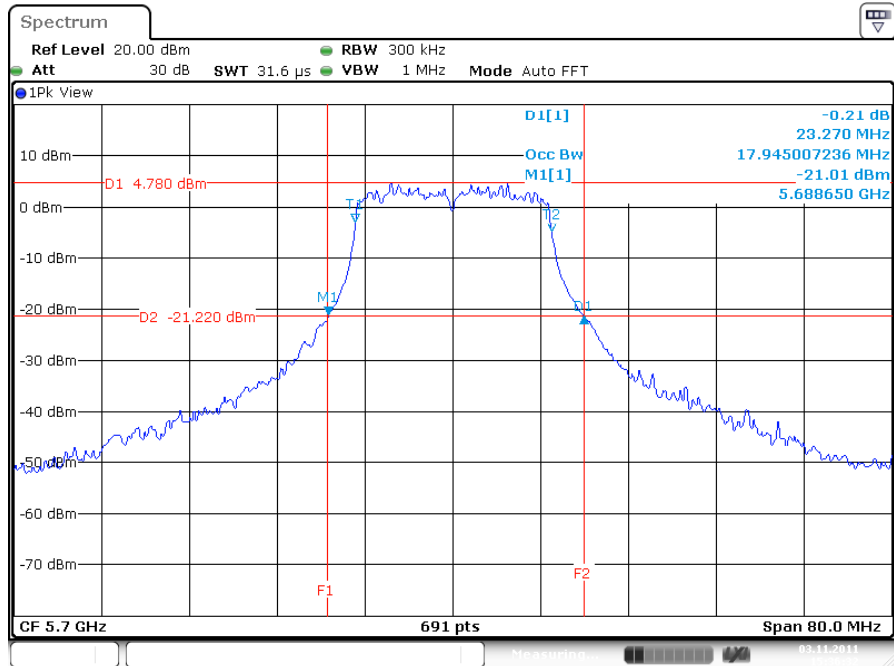

Date: 3.NOV.2011 15:36:32

< For Ant. 4 >

26 dB Bandwidth Plot on Configuration IEEE 802.11n MCS8 20MHz / Connector 1 + Connector 3/
Ant. 4 / 5260 MHz

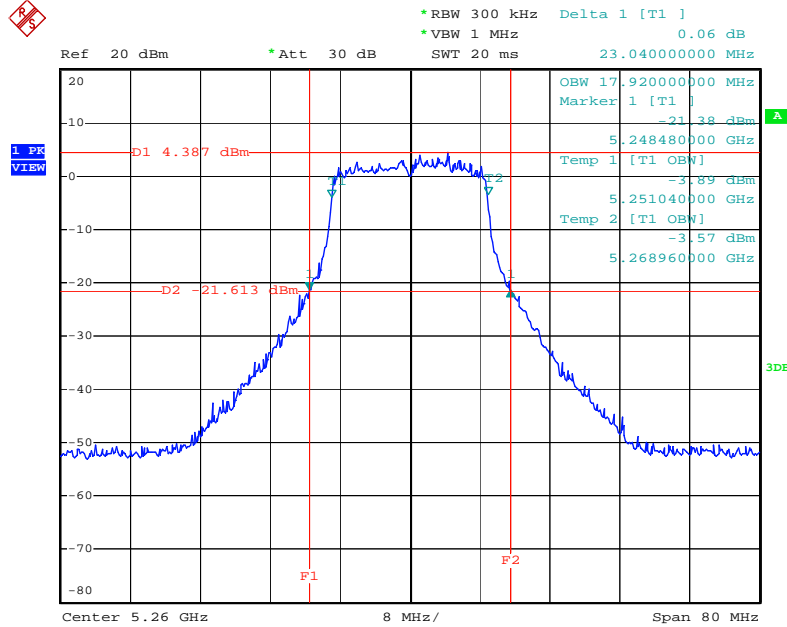

Date: 30.AUG.2011 22:07:12

26 dB Bandwidth Plot on Configuration IEEE 802.11n MCS8 20MHz / Connector 1 + Connector 3/
Ant. 4 / 5300 MHz

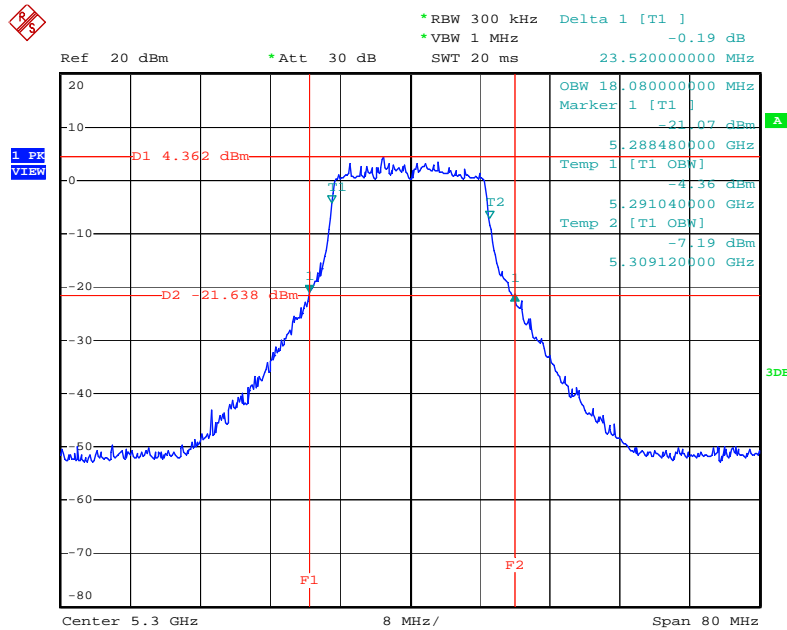

Date: 30.AUG.2011 22:06:18

< For Ant. 4 >

26 dB Bandwidth Plot on Configuration IEEE 802.11n MCS8 20MHz / Connector 1 + Connector 3/
Ant. 4 / 5320 MHz

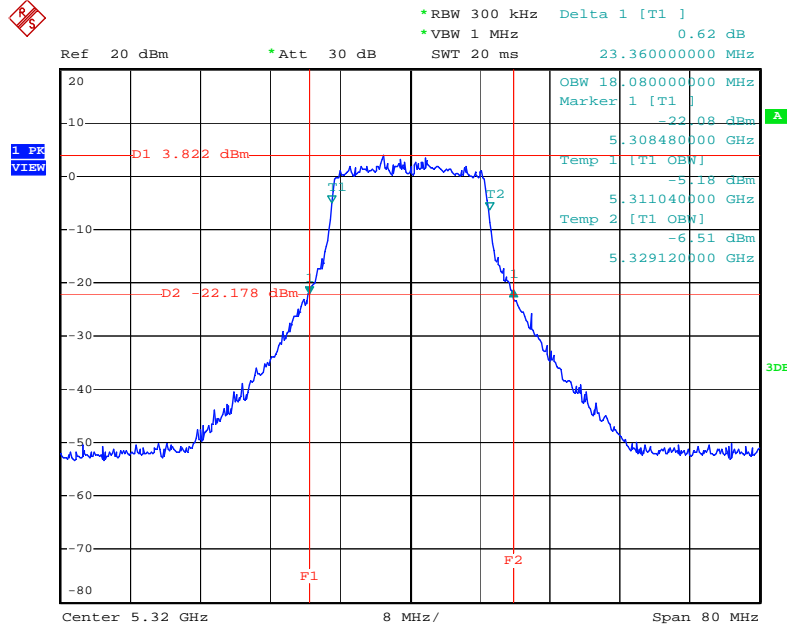

Date: 30.AUG.2011 22:05:29

26 dB Bandwidth Plot on Configuration IEEE 802.11n MCS8 20MHz / Connector 1 + Connector 3/
Ant. 4 / 5500 MHz

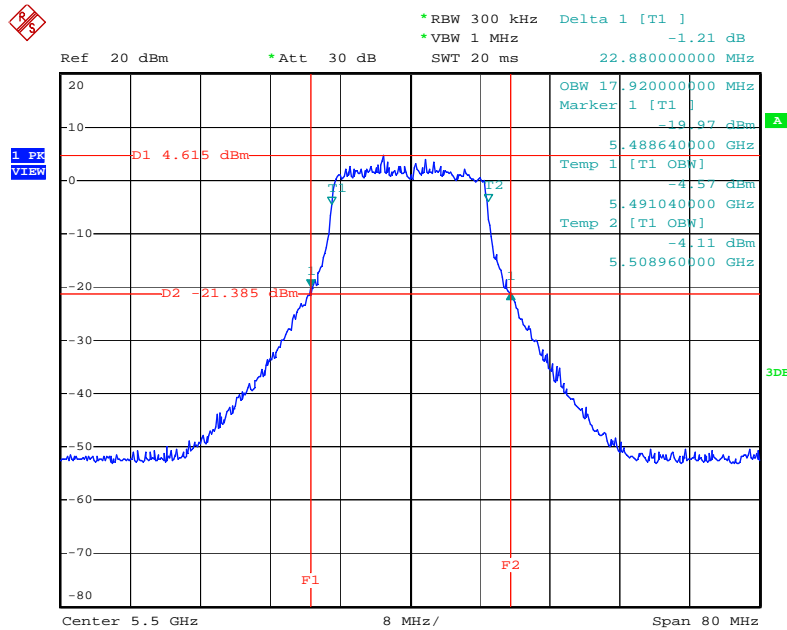

Date: 30.AUG.2011 22:04:32

< For Ant. 4 >

26 dB Bandwidth Plot on Configuration IEEE 802.11n MCS8 20MHz / Connector 1 + Connector 3/
Ant. 4 / 5580 MHz

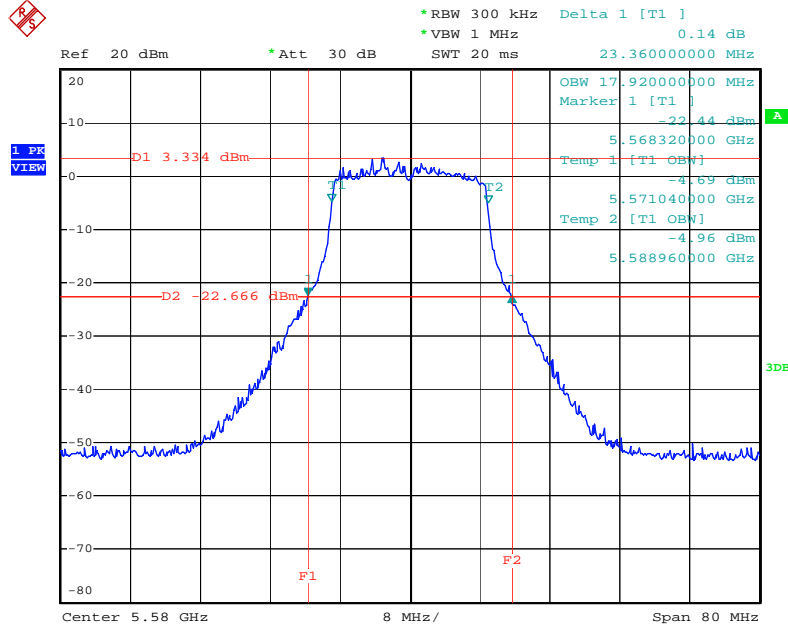

Date: 30.AUG.2011 22:03:36

26 dB Bandwidth Plot on Configuration IEEE 802.11n MCS8 20MHz / Connector 1 + Connector 3/
Ant. 4 / 5700 MHz

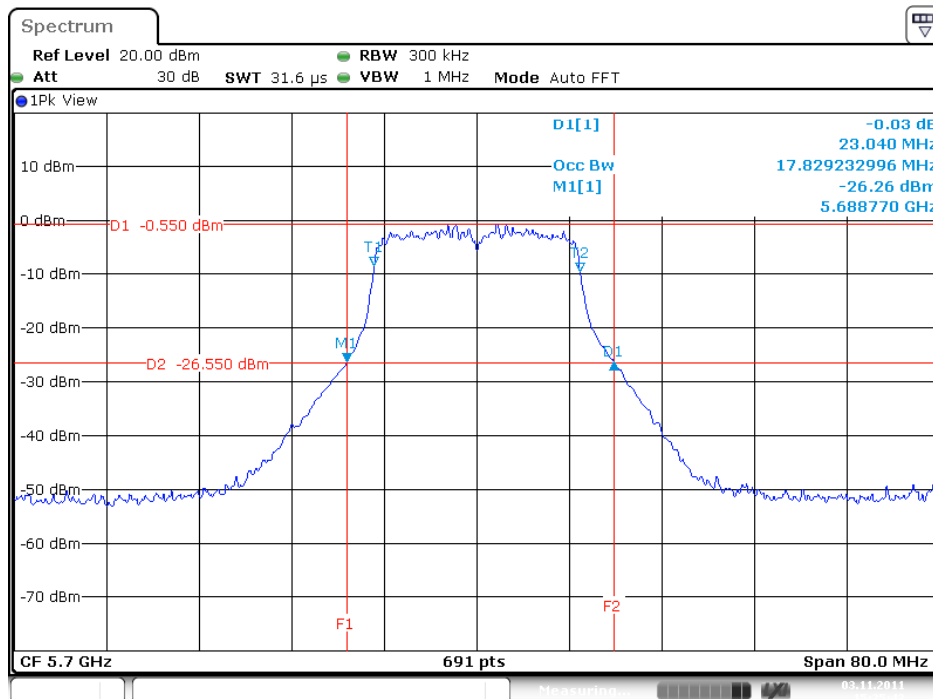

< For Ant. 4 >

26 dB Bandwidth Plot on Configuration IEEE 802.11n MCS8 40MHz / Connector 1 + Connector 3/
Ant. 4 / 5270 MHz

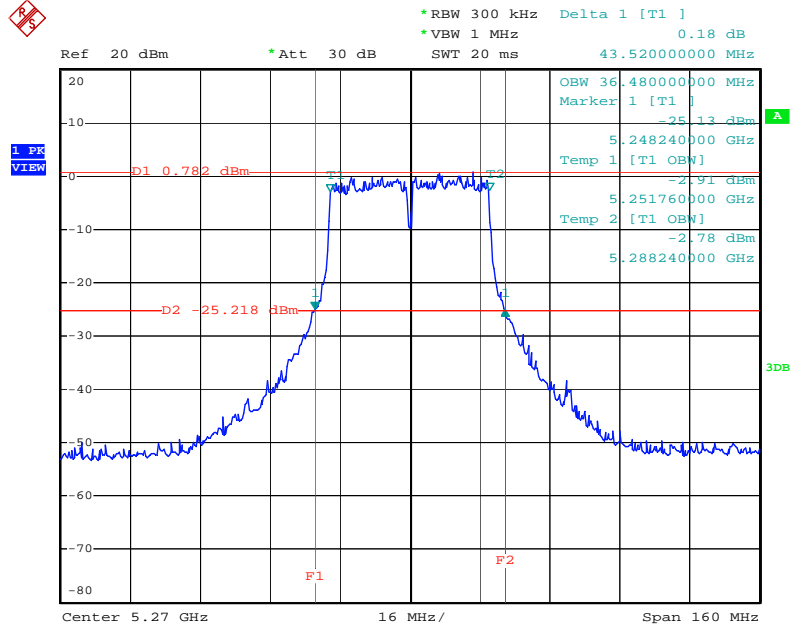

Date: 30.AUG.2011 22:09:24

26 dB Bandwidth Plot on Configuration IEEE 802.11n MCS8 40MHz / Connector 1 + Connector 3/
Ant. 4 / 5310 MHz

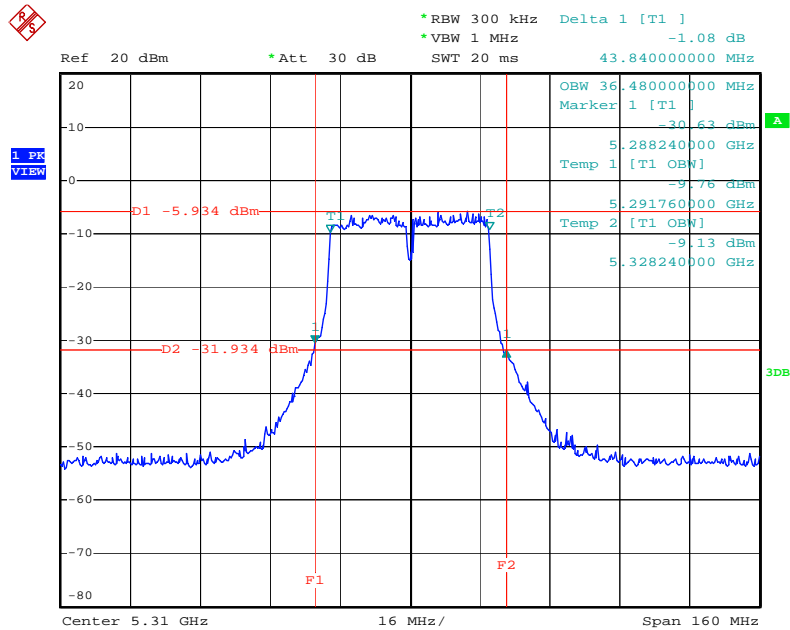

Date: 30.AUG.2011 22:12:09

< For Ant. 4 >

26 dB Bandwidth Plot on Configuration IEEE 802.11n MCS8 40MHz / Connector 1 + Connector 3/
Ant. 4 / 5510MHz

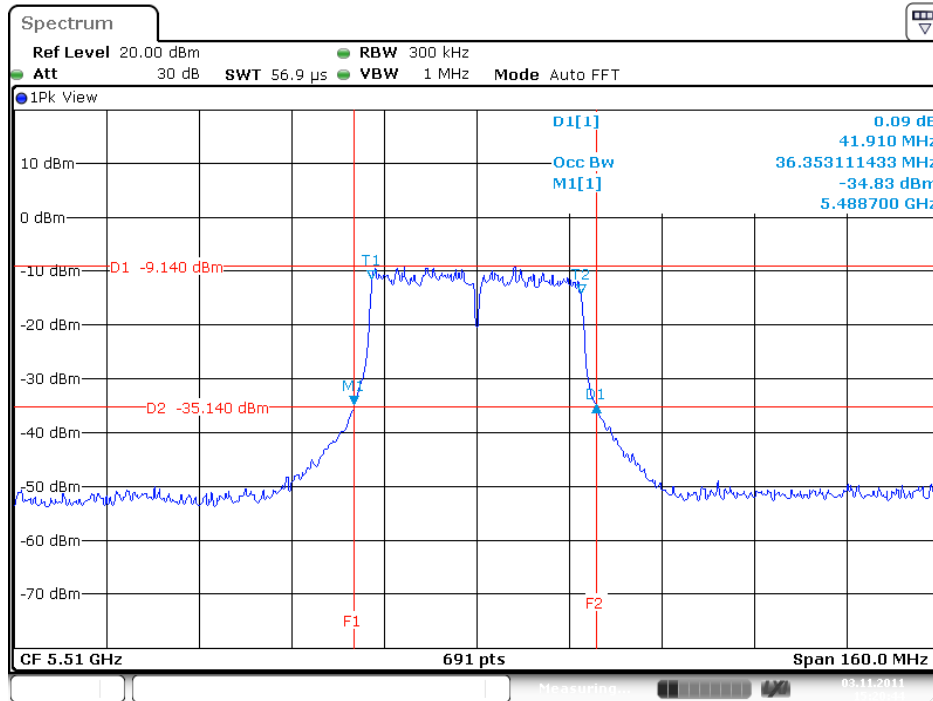

26 dB Bandwidth Plot on Configuration IEEE 802.11n MCS8 40MHz / Connector 1 + Connector 3/
Ant. 4 / 5550 MHz

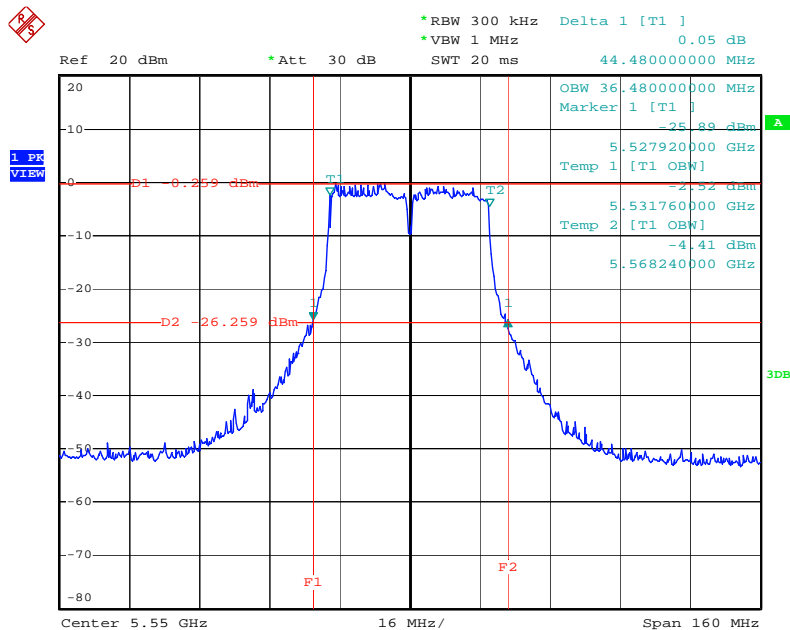

< For Ant. 4 >

26 dB Bandwidth Plot on Configuration IEEE 802.11n MCS8 40MHz / Connector 1 + Connector 3/
Ant. 4 / 5670 MHz

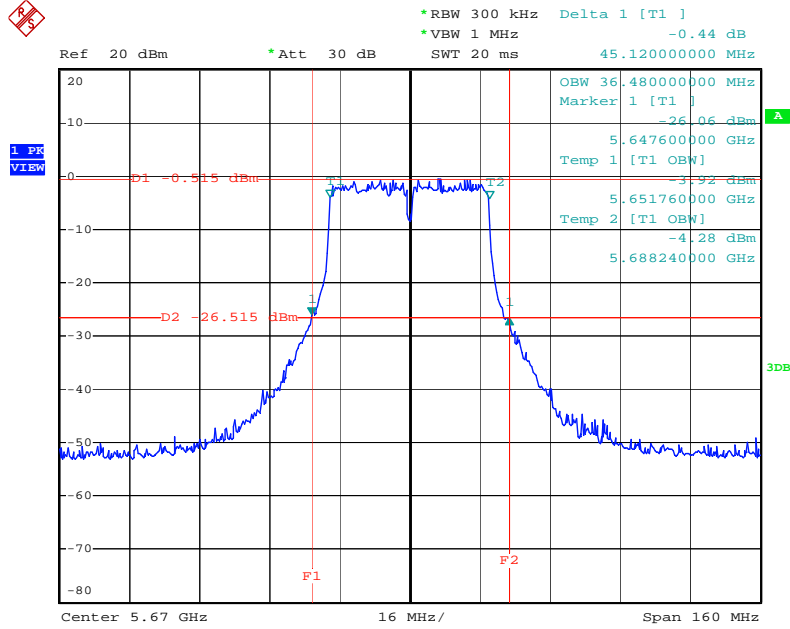

Date: 30.AUG.2011 22:15:19

26 dB Bandwidth Plot on Configuration IEEE 802.11a / Connector 1 + Connector 3/ Ant. 4 / 5260 MHz

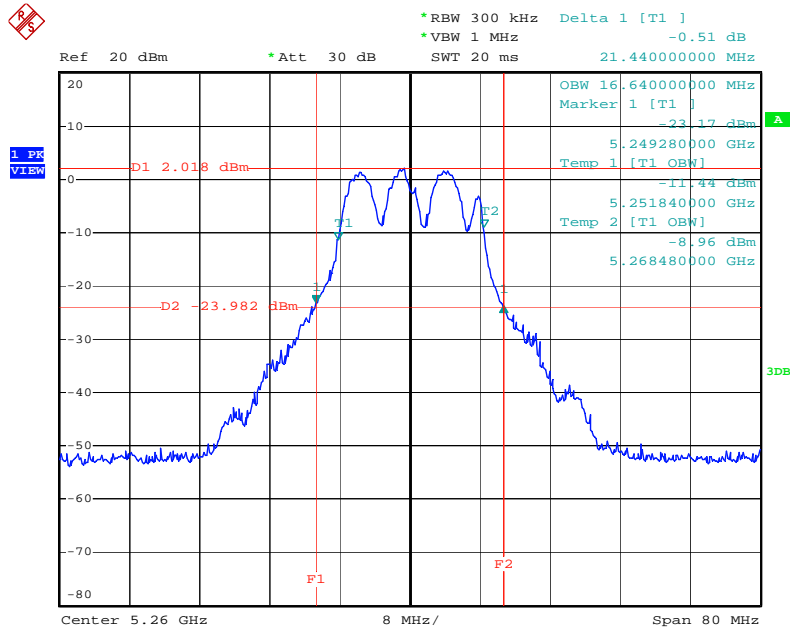

Date: 30.AUG.2011 21:53:39

< For Ant. 4 >

26 dB Bandwidth Plot on Configuration IEEE 802.11a / Connector 1 + Connector 3/ Ant. 4 / 5300 MHz

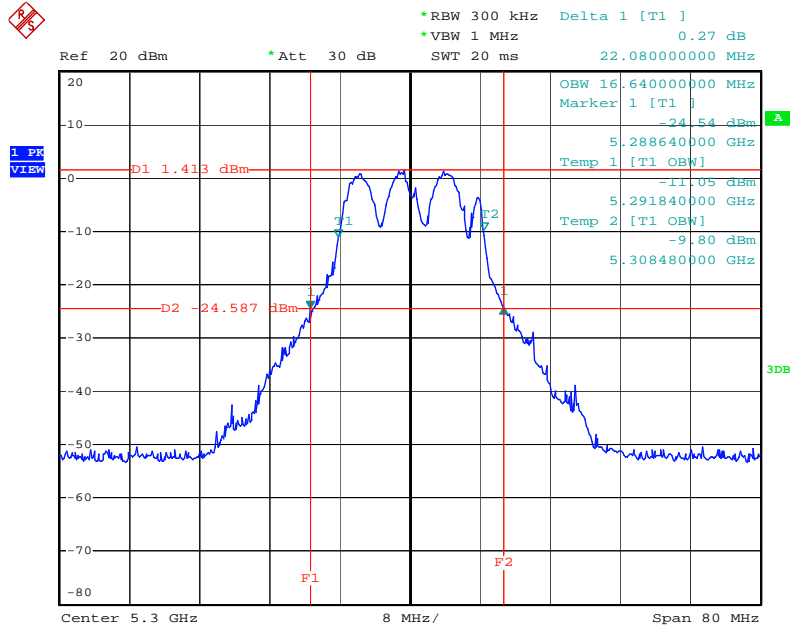

Date: 30.AUG.2011 21:54:55

26 dB Bandwidth Plot on Configuration IEEE 802.11a / Connector 1 + Connector 3/ Ant. 4 / 5320 MHz

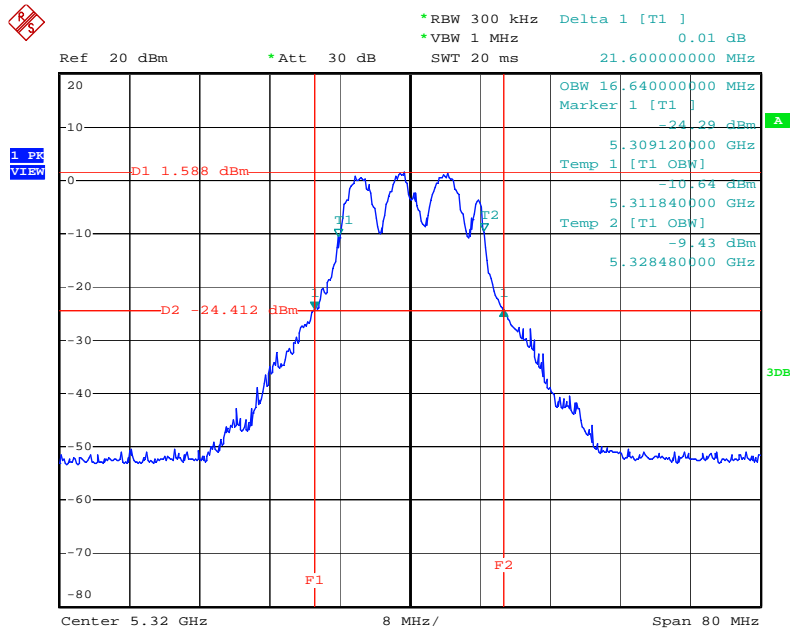

Date: 30.AUG.2011 21:56:49

< For Ant. 4 >

26 dB Bandwidth Plot on Configuration IEEE 802.11a / Connector 1 + Connector 3/ Ant. 4 / 5500 MHz

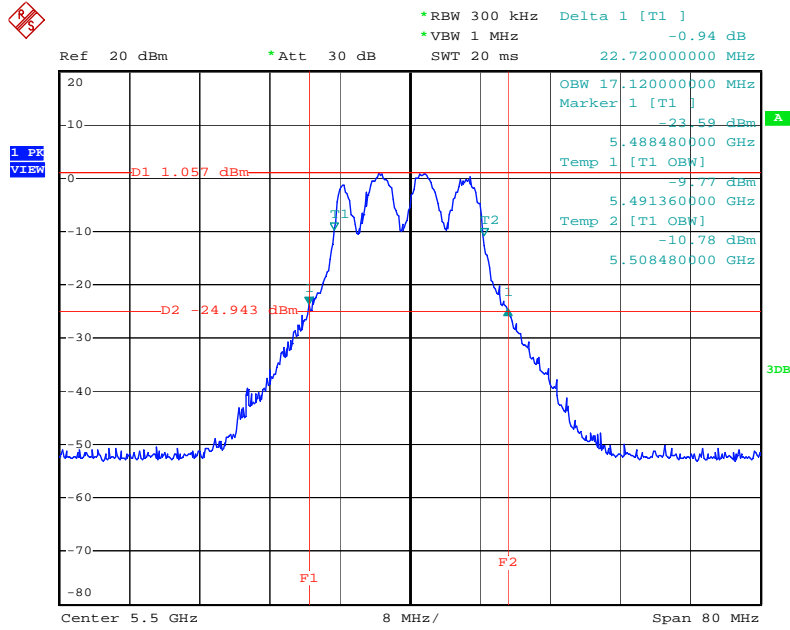

Date: 30.AUG.2011 21:57:51

26 dB Bandwidth Plot on Configuration IEEE 802.11a / Connector 1 + Connector 3/ Ant. 4 / 5580 MHz

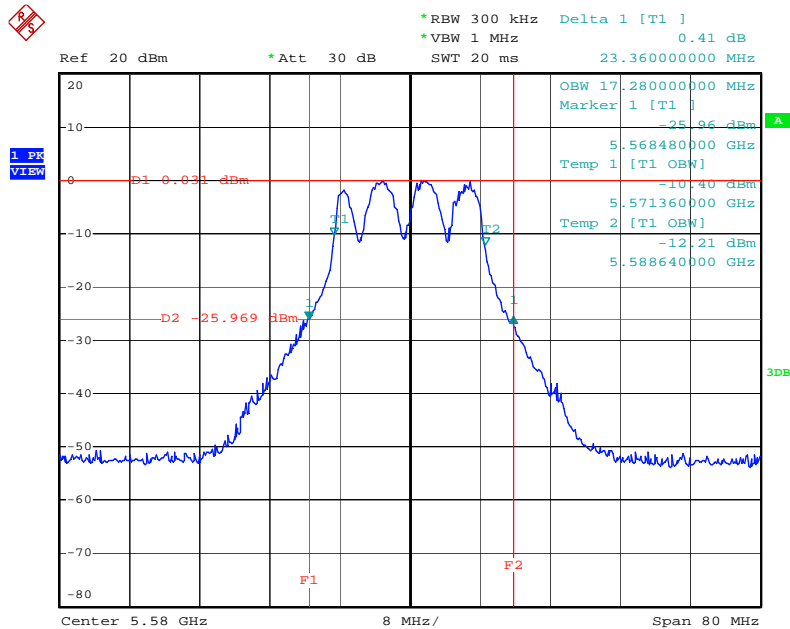

Date: 30.AUG.2011 21:58:46

< For Ant. 4 >

26 dB Bandwidth Plot on Configuration IEEE 802.11a / Connector 1 + Connector 3/ Ant. 4 / 5700 MHz

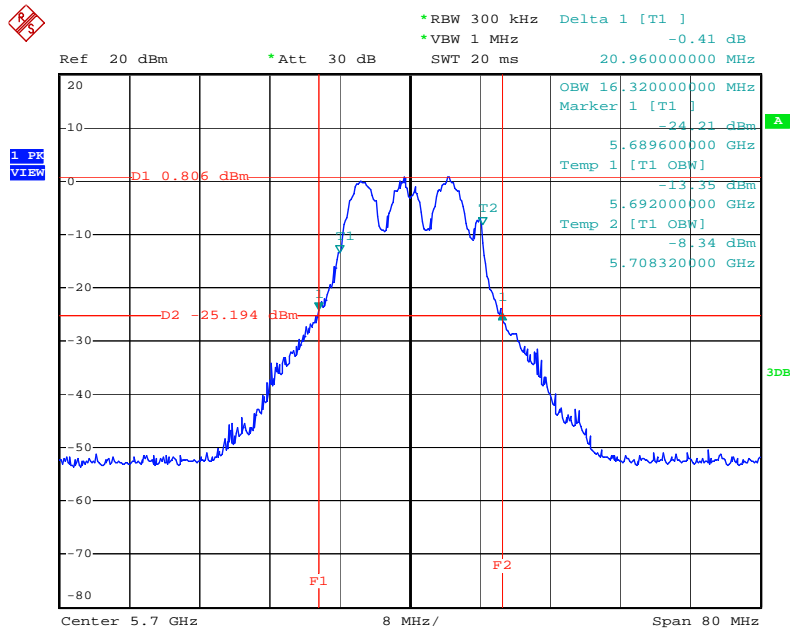

Date: 30.AUG.2011 22:00:43

4.3. Maximum Conducted Output Power Measurement

4.3.1. Limit

For the band 5.15~5.25 GHz, the maximum conducted output power over the frequency band of operation shall not exceed the lesser of 50 mW (17dBm) or $4 \text{ dBm} + 10\log B$, where B is the 26 dB emissions bandwidth in MHz. If transmitting antennas of directional gain greater than 6 dBi are used, both the maximum conducted output power and the peak power spectral density shall be reduced by the amount in dB that the directional gain of the antenna exceeds 6 dBi.

For the 5.25-5.35 GHz and 5.470-5.725 GHz bands, the maximum conducted output power over the frequency bands of operation shall not exceed the lesser of 250 mW (24dBm) or $11 \text{ dBm} + 10\log B$, where B is the 26-dB emission bandwidth in MHz. If transmitting antennas of directional gain greater than 6 dBi are used, both the maximum conducted output power and the peak power spectral density shall be reduced by the amount in dB that the directional gain of the antenna exceeds 6 dBi.

For the band 5.725~5.825 GHz, the maximum conducted output power over the frequency band of operation shall not exceed the lesser of 1 W or $17 \text{ dBm} + 10 \log B$, where B is the 26-dB emission bandwidth in MHz. In addition, the peak power spectral density shall not exceed 17 dBm in any 1 MHz band. If transmitting antennas of directional gain greater than 6 dBi are used, both the maximum conducted output power and the peak power spectral density shall be reduced by the amount in dB that the directional gain of the antenna exceeds 6 dBi. However, fixed point-to-point U-NII devices operating in this band may employ transmitting antennas with directional gain up to 23 dBi without any corresponding reduction in the transmitter peak output power or peak power spectral density. For fixed, point-to-point U-NII transmitters that employ a directional antenna gain greater than 23 dBi, a 1 dB reduction in peak transmitter power and peak power spectral density for each 1 dB of antenna gain in excess of 23 dBi would be required.

4.3.2. Measuring Instruments and Setting

The following table is the setting of the peak power meter.

| Power Meter Parameter | Setting |
|-----------------------|--|
| Bandwidth | 50MHz bandwidth is greater than the EUT emission bandwidth |
| Detector | AVERAGE |

4.3.3. Test Procedures

| Spectrum Parameter | Setting |
|------------------------|---|
| RF Output Power Method | <input checked="" type="checkbox"/> ANSI C63.10 clause 6.10.2.1 (a) power meter method |
| RF Output Power Method | <input type="checkbox"/> ANSI C63.10 clause 6.10.2.1 (b) channel integration method |
| RF Output Power Method | <input type="checkbox"/> ANSI C63.10 clause 6.10.3.1 Method 1 - spectral trace averaging |
| RF Output Power Method | <input type="checkbox"/> ANSI C63.10 clause 6.10.3.2 Method 2 - zero-span mode with trace averaging |

4.3.4. Test Setup Layout

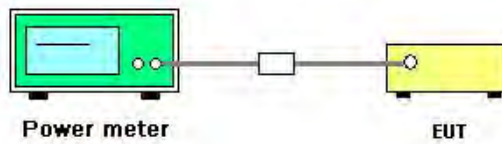

4.3.5. Test Deviation

There is no deviation with the original standard.

4.3.6. EUT Operation during Test

The EUT was programmed to be in continuously transmitting mode.

4.3.7. Test Result of Maximum Conducted Output Power

< For Ant. 3 >

| | | | |
|---------------|---------------|----------------|-----------------------|
| Temperature | 25°C | Humidity | 56% |
| Test Engineer | Sean Ku | Configurations | IEEE 802.11n / Ant. 3 |
| Test Date | Aug. 29, 2011 | | |

Configuration IEEE 802.11n MCS8 20MHz

| Channel | Frequency | Conducted Power (dBm) | | total Conducted Power (dBm) | Max. Limit (dBm) | Result |
|---------|-----------|-----------------------|-------------|--------------------------------------|---------------------|----------|
| | | Connector 1 | Connector 3 | | | |
| 36 | 5180 MHz | 13.69 | 13.88 | 16.80 | 17.00 | Complies |
| 40 | 5200 MHz | 13.96 | 13.95 | 16.97 | 17.00 | Complies |
| 48 | 5240 MHz | 14.10 | 13.73 | 16.93 | 17.00 | Complies |
| 52 | 5260 MHz | 20.67 | 20.57 | 23.63 | 24.00 | Complies |
| 60 | 5300 MHz | 20.57 | 20.68 | 23.64 | 24.00 | Complies |
| 64 | 5320 MHz | 16.49 | 16.34 | 19.43 | 24.00 | Complies |
| 100 | 5500 MHz | 18.24 | 18.48 | 21.37 | 24.00 | Complies |
| 116 | 5580 MHz | 20.58 | 20.90 | 23.75 | 24.00 | Complies |
| 140 | 5700 MHz | 13.76 | 14.86 | 17.36 | 24.00 | Complis |

Configuration IEEE 802.11n MCS8 40MHz

| Channel | Frequency | Conducted Power (dBm) | | total Conducted Power (dBm) | Max. Limit (dBm) | Result |
|---------|-----------|-----------------------|-------------|--------------------------------------|---------------------|----------|
| | | Connector 1 | Connector 3 | | | |
| 38 | 5190 MHz | 12.35 | 12.57 | 15.47 | 17.00 | Complies |
| 46 | 5230 MHz | 13.97 | 13.43 | 16.72 | 17.00 | Complies |
| 54 | 5270 MHz | 19.65 | 19.56 | 22.62 | 24.00 | Complies |
| 62 | 5310 MHz | 13.28 | 12.31 | 15.83 | 24.00 | Complies |
| 102 | 5510MHz | 15.10 | 14.89 | 18.01 | 24.00 | Complies |
| 110 | 5550 MHz | 19.25 | 19.97 | 22.64 | 24.00 | Complies |
| 134 | 5670 MHz | 15.21 | 15.90 | 18.58 | 24.00 | Complies |

< For Ant. 3 >

| | | | |
|---------------|---------------|----------------|-----------------------|
| Temperature | 25°C | Humidity | 56% |
| Test Engineer | Sean Ku | Configurations | IEEE 802.11a / Ant. 3 |
| Test Date | Aug. 29, 2011 | | |

Configuration IEEE 802.11a

| Channel | Frequency | Conducted Power (dBm) | | total Conducted Power (dBm) | Max. Limit (dBm) | Result |
|---------|-----------|-----------------------|-------------|--------------------------------------|---------------------|----------|
| | | Connector 1 | Connector 3 | | | |
| 36 | 5180 MHz | 10.52 | 11.35 | 13.97 | 13.99 | Complies |
| 40 | 5200 MHz | 10.26 | 10.99 | 13.65 | 13.99 | Complies |
| 48 | 5240 MHz | 10.64 | 10.90 | 13.78 | 13.99 | Complies |
| 52 | 5260 MHz | 18.04 | 17.63 | 20.85 | 20.99 | Complies |
| 60 | 5300 MHz | 17.99 | 17.76 | 20.89 | 20.99 | Complies |
| 64 | 5320 MHz | 16.77 | 16.52 | 19.66 | 20.99 | Complies |
| 100 | 5500 MHz | 17.61 | 18.15 | 20.90 | 20.99 | Complies |
| 116 | 5580 MHz | 17.54 | 18.36 | 20.98 | 20.99 | Complies |
| 140 | 5700 MHz | 13.98 | 14.86 | 17.45 | 20.99 | Complis |

NOTE: Directional gain = 6 dBi + 10log(2) = 9.01 dBi > 6dBi so the band1 conducted power limit = (17 or 4 + 10log B) - Directional gain - 6

NOTE: Directional gain = 6 dBi + 10log(2) = 9.01 dBi > 6dBi so the band2/band3 conducted power limit = (24 or 11 + 10log B) - Directional gain - 6

< For Ant. 4 >

| | | | |
|----------------------|---------------|-----------------------|-----------------------|
| Temperature | 25°C | Humidity | 56% |
| Test Engineer | Sean Ku | Configurations | IEEE 802.11n / Ant. 4 |
| Test Date | Aug. 29, 2011 | | |

Configuration IEEE 802.11n MCS8 20MHz

| Channel | Frequency | Conducted Power (dBm) | | total Conducted Power (dBm) | Max. Limit (dBm) | Result |
|---------|-----------|-----------------------|-------------|--------------------------------------|---------------------|-----------------|
| | | Connector 1 | Connector 3 | | | |
| 52 | 5260 MHz | 10.51 | 10.77 | 13.65 | 13.90 | Complies |
| 60 | 5300 MHz | 10.85 | 10.75 | 13.81 | 13.90 | Complies |
| 64 | 5320 MHz | 10.78 | 10.36 | 13.59 | 13.90 | Complies |
| 100 | 5500 MHz | 9.71 | 11.42 | 13.66 | 13.90 | Complies |
| 116 | 5580 MHz | 9.40 | 11.45 | 13.56 | 13.90 | Complies |
| 140 | 5700 MHz | 7.11 | 8.88 | 11.09 | 13.90 | Complis |

Configuration IEEE 802.11n MCS8 40MHz

| Channel | Frequency | Conducted Power (dBm) | | total Conducted Power (dBm) | Max. Limit (dBm) | Result |
|---------|-----------|-----------------------|-------------|--------------------------------------|---------------------|-----------------|
| | | Connector 1 | Connector 3 | | | |
| 54 | 5270 MHz | 10.77 | 10.84 | 13.82 | 13.90 | Complies |
| 62 | 5310 MHz | 4.96 | 4.57 | 7.78 | 13.90 | Complies |
| 102 | 5510MHz | 4.55 | 4.31 | 7.44 | 13.90 | Complies |
| 110 | 5550 MHz | 9.78 | 11.23 | 13.58 | 13.90 | Complies |
| 134 | 5670 MHz | 10.06 | 11.04 | 13.59 | 13.90 | Complies |

< For Ant. 4 >

| | | | |
|---------------|---------------|----------------|-----------------------|
| Temperature | 25°C | Humidity | 56% |
| Test Engineer | Sean Ku | Configurations | IEEE 802.11a / Ant. 4 |
| Test Date | Aug. 29, 2011 | | |

Configuration IEEE 802.11a

| Channel | Frequency | Conducted Power (dBm) | | total Conducted Power (dBm) | Max. Limit (dBm) | Result |
|---------|-----------|-----------------------|-------------|--------------------------------------|---------------------|----------|
| | | Connector 1 | Connector 3 | | | |
| 52 | 5260 MHz | 7.76 | 7.12 | 10.46 | 10.89 | Complies |
| 60 | 5300 MHz | 7.65 | 7.29 | 10.48 | 10.89 | Complies |
| 64 | 5320 MHz | 7.84 | 7.37 | 10.62 | 10.89 | Complies |
| 100 | 5500 MHz | 7.76 | 7.12 | 10.46 | 10.89 | Complies |
| 116 | 5580 MHz | 7.18 | 7.68 | 10.45 | 10.89 | Complies |
| 140 | 5700 MHz | 6.35 | 8.52 | 10.58 | 10.89 | Complis |

NOTE: Directional gain = 16.11dBi + 10log(2)=19.11dBi > 6dBi so the band2/band3 conducted power limit = (24 or 4 + 10log B)-Directional gain-6

4.4. Power Spectral Density Measurement

4.4.1. Limit

The power spectral density is defined as the highest level of power in dBm per MHz generated by the transmitter within the power envelope. The following table is power spectral density limits and decrease power density limit rule refer to section 4.3.1.

| Frequency Range | Power Spectral Density limit (dBm/MHz) |
|-----------------|--|
| 5.15~5.25 GHz | 4 |
| 5.25-5.35 GHz | 11 |
| 5470-5725 | 11 |

4.4.2. Measuring Instruments and Setting

Please refer to section 5 of equipments list in this report. The following table is the setting of the spectrum analyzer.

| Spectrum Parameter | Setting |
|--------------------|--|
| Attenuation | Auto |
| Span Frequency | Encompass the entire emissions bandwidth (EBW) of the signal |
| RB | 1000 kHz |
| VB | 3000 kHz |
| Detector | SAMPLE |
| Trace | AVERAGE |
| Sweep Time | Auto |
| Trace Average | 100 times |

4.4.3. Test Procedures

1. The test procedure is the same as section 4.6.3.
2. Trace A, Set RBW = 1MHz, VBW = 3MHz, Span >26dB bandwidth, Max. hold.
3. Delta Mark trace A Maximum frequency and trace B same frequency.
4. Repeat the above procedure until measurements for all frequencies were complete.

4.4.4. Test Setup Layout

This test setup layout is the same as that shown in section 4.6.4.

4.4.5. Test Deviation

There is no deviation with the original standard.

4.4.6. EUT Operation during Test

The EUT was programmed to be in continuously transmitting mode.

4.4.7. Test Result of Power Spectral Density

< For Ant. 3 >

| | | | |
|---------------|---------|----------------|-----------------------|
| Temperature | 25°C | Humidity | 56 % |
| Test Engineer | Sean Ku | Configurations | IEEE 802.11n / Ant. 3 |

Configuration IEEE 802.11n MCS8 20MHz

| Channel | Frequency | Power Density (dBm/3kHz) | | Total Power Density (dBm/3kHz) | Max. Limit (dBm/3kHz) | Result |
|---------|-----------|--------------------------|-------------|--------------------------------|-----------------------|----------|
| | | Connector 1 | Connector 3 | | | |
| 36 | 5180 MHz | 0.54 | 0.92 | 3.74 | 4.00 | Complies |
| 40 | 5200 MHz | 1.11 | 0.59 | 3.87 | 4.00 | Complies |
| 48 | 5240 MHz | 1.01 | -0.01 | 3.54 | 4.00 | Complies |
| 52 | 5260 MHz | 7.78 | 6.91 | 10.38 | 11.00 | Complies |
| 60 | 5300 MHz | 7.27 | 7.11 | 10.20 | 11.00 | Complies |
| 64 | 5320 MHz | 2.96 | 2.53 | 5.76 | 11.00 | Complies |
| 100 | 5500 MHz | -0.02 | 1.25 | 3.67 | 11.00 | Complies |
| 116 | 5580 MHz | 6.99 | 7.94 | 10.50 | 11.00 | Complies |
| 140 | 5700 MHz | 4.05 | 4.81 | 7.46 | 11.00 | Complies |

Configuration IEEE 802.11n MCS8 40MHz

| Channel | Frequency | Power Density (dBm/3kHz) | | Total Power Density (dBm/3kHz) | Max. Limit (dBm/3kHz) | Result |
|---------|-----------|--------------------------|-------------|--------------------------------|-----------------------|----------|
| | | Connector 1 | Connector 3 | | | |
| 38 | 5190 MHz | -4.36 | -4.22 | -1.28 | 4.00 | Complies |
| 46 | 5230 MHz | -2.66 | -3.63 | -0.11 | 4.00 | Complies |
| 54 | 5270 MHz | 3.29 | 2.25 | 5.81 | 11.00 | Complies |
| 62 | 5310 MHz | -4.04 | -4.73 | -1.36 | 11.00 | Complies |
| 102 | 5510MHz | -2.16 | -2.57 | 0.65 | 11.00 | Complies |
| 110 | 5550 MHz | 3.41 | 3.62 | 6.53 | 11.00 | Complies |
| 134 | 5670 MHz | -3.25 | -1.16 | 0.93 | 11.00 | Complies |

< For Ant. 3 >

| | | | |
|----------------------|---------|-----------------------|-----------------------|
| Temperature | 25°C | Humidity | 56 % |
| Test Engineer | Sean Ku | Configurations | IEEE 802.11a / Ant. 3 |

Configuration IEEE 802.11a

| Channel | Frequency | Power Density (dBm/3kHz) | | Total Power Density (dBm/3kHz) | Max. Limit (dBm/3kHz) | Result |
|---------|-----------|--------------------------|-------------|--------------------------------|-----------------------|----------|
| | | Connector 1 | Connector 3 | | | |
| 36 | 5180 MHz | -2.66 | -1.88 | 0.76 | 0.99 | Complies |
| 40 | 5200 MHz | -2.54 | -2.22 | 0.63 | 0.99 | Complies |
| 48 | 5240 MHz | -2.08 | -3.09 | 0.45 | 0.99 | Complies |
| 52 | 5260 MHz | 5.42 | 4.15 | 7.84 | 7.99 | Complies |
| 60 | 5300 MHz | 4.94 | 4.07 | 7.54 | 7.99 | Complies |
| 64 | 5320 MHz | 3.62 | 2.74 | 6.21 | 7.99 | Complies |
| 100 | 5500 MHz | 4.62 | 5.14 | 7.90 | 7.99 | Complies |
| 116 | 5580 MHz | 4.65 | 5.07 | 7.88 | 7.99 | Complies |
| 140 | 5700 MHz | 0.87 | 0.85 | 3.87 | 7.99 | Complies |

Note: All the test values were listed in the report.

For plots, only the channel with maximum results was shown.

< For Ant. 4 >

| | | | |
|----------------------|---------|-----------------------|-----------------------|
| Temperature | 25°C | Humidity | 56 % |
| Test Engineer | Sean Ku | Configurations | IEEE 802.11n / Ant. 4 |

Configuration IEEE 802.11n MCS8 20MHz

| Channel | Frequency | Power Density (dBm/3kHz) | | Total Power Density (dBm/3kHz) | Max. Limit (dBm/3kHz) | Result |
|---------|-----------|--------------------------|-------------|--------------------------------|-----------------------|----------|
| | | Connector 1 | Connector 3 | | | |
| 52 | 5260 MHz | -2.24 | -2.18 | 0.80 | 0.90 | Complies |
| 60 | 5300 MHz | -2.65 | -2.00 | 0.70 | 0.90 | Complies |
| 64 | 5320 MHz | -2.57 | -2.55 | 0.45 | 0.90 | Complies |
| 100 | 5500 MHz | -2.29 | -2.16 | 0.79 | 0.90 | Complies |
| 116 | 5580 MHz | -2.70 | -1.67 | 0.86 | 0.90 | Complies |
| 140 | 5700 MHz | -6.11 | -5.27 | -2.66 | 0.90 | Complies |

Configuration IEEE 802.11n MCS8 40MHz

| Channel | Frequency | Power Density (dBm/3kHz) | | Total Power Density (dBm/3kHz) | Max. Limit (dBm/3kHz) | Result |
|---------|-----------|--------------------------|-------------|--------------------------------|-----------------------|----------|
| | | Connector 1 | Connector 3 | | | |
| 54 | 5270 MHz | -5.26 | -5.33 | -2.28 | 0.90 | Complies |
| 62 | 5310 MHz | -11.16 | -11.93 | -8.52 | 0.90 | Complies |
| 102 | 5510MHz | -12.60 | -13.08 | -9.82 | 0.90 | Complies |
| 110 | 5550 MHz | -4.91 | -3.88 | -1.35 | 0.90 | Complies |
| 134 | 5670 MHz | -6.63 | -4.58 | -2.47 | 0.90 | Complies |

< For Ant. 4 >

| | | | |
|----------------------|---------|-----------------------|-----------------------|
| Temperature | 25°C | Humidity | 56 % |
| Test Engineer | Sean Ku | Configurations | IEEE 802.11a / Ant. 4 |

Configuration IEEE 802.11a

| Channel | Frequency | Power Density (dBm/3kHz) | | Total Power Density (dBm/3kHz) | Max. Limit (dBm/3kHz) | Result |
|---------|-----------|--------------------------|-------------|--------------------------------|-----------------------|----------|
| | | Connector 1 | Connector 3 | | | |
| 52 | 5260 MHz | -5.16 | -5.16 | -2.15 | -2.11 | Complies |
| 60 | 5300 MHz | -5.17 | -5.89 | -2.50 | -2.11 | Complies |
| 64 | 5320 MHz | -5.21 | -5.94 | -2.55 | -2.11 | Complies |
| 100 | 5500 MHz | -4.78 | -5.73 | -2.22 | -2.11 | Complies |
| 116 | 5580 MHz | -4.96 | -5.52 | -2.22 | -2.11 | Complies |
| 140 | 5700 MHz | -5.39 | -5.13 | -2.25 | -2.11 | Complies |

Note: All the test values were listed in the report.

For plots, only the channel with maximum results was shown.

< For Ant. 3 >

Power Density Plot on Configuration IEEE 802.11n MCS8 20MHz / Connector 1 / Ant. 3 / 5200 MHz

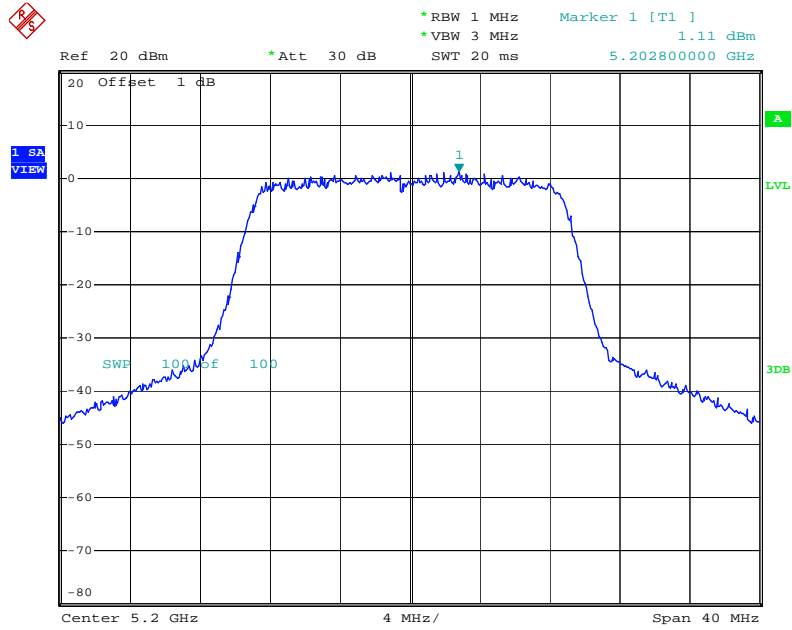

Date: 29.AUG.2011 19:51:09

Power Density Plot on Configuration IEEE 802.11n MCS8 20MHz / Connector 3/ Ant. 3 / 5200 MHz

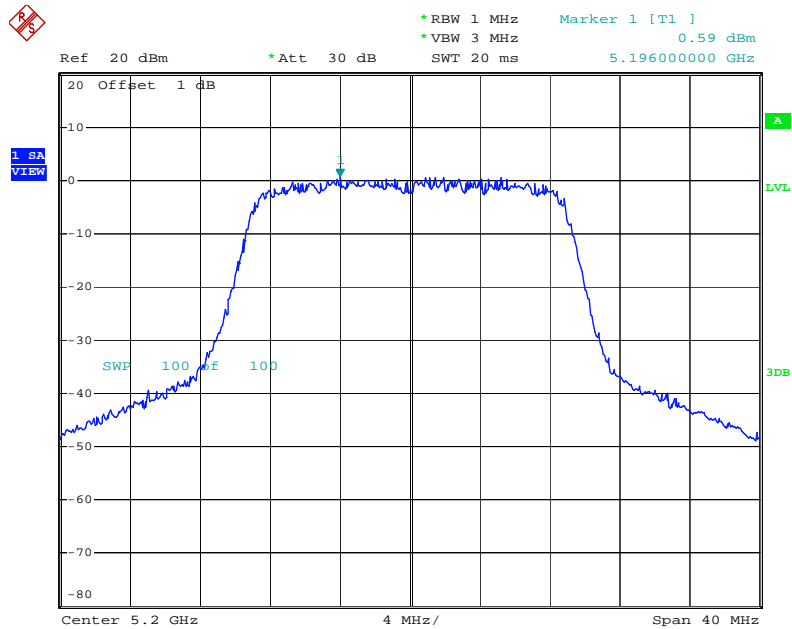

Date: 29.AUG.2011 19:50:14

< For Ant. 3 >

Power Density Plot on Configuration IEEE 802.11n MCS8 20MHz / Connector 1 / Ant. 3 / 5260 MHz

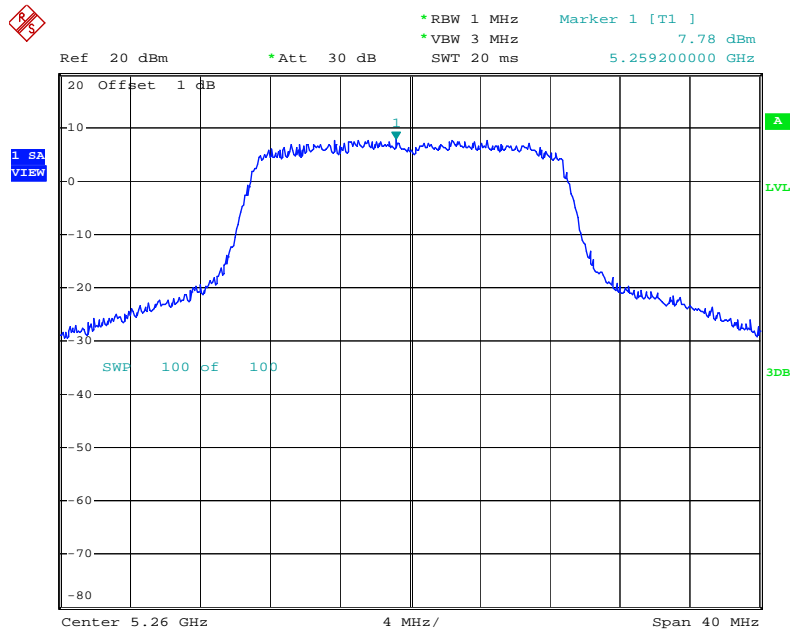

Date: 29.AUG.2011 19:54:26

Power Density Plot on Configuration IEEE 802.11n MCS8 20MHz / Connector 3/ Ant. 3 / 5260 MHz

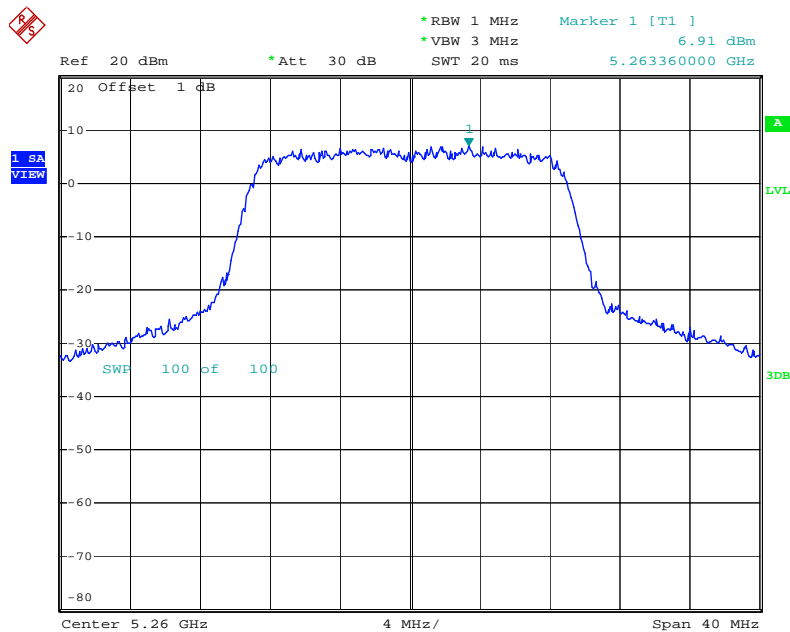

Date: 29.AUG.2011 19:53:42

< For Ant. 3 >

Power Density Plot on Configuration IEEE 802.11n MCS8 20MHz / Connector 1 / Ant. 3 / 5580 MHz

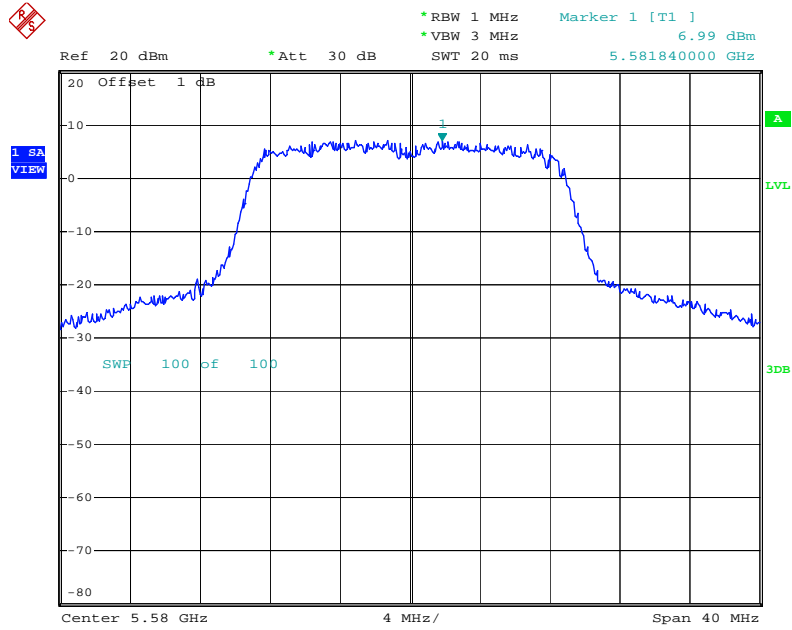

Date: 29.AUG.2011 20:01:23

Power Density Plot on Configuration IEEE 802.11n MCS8 20MHz / Connector 3/ Ant. 3 / 5580 MHz

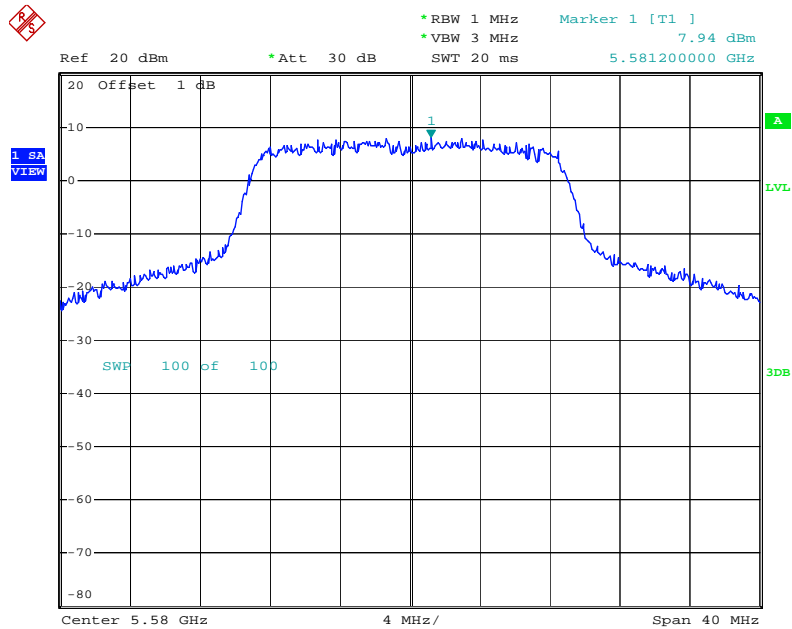

Date: 29.AUG.2011 20:00:40

< For Ant. 3 >

Power Density Plot on Configuration IEEE 802.11n MCS8 40MHz / Connector 1 / Ant. 3 / 5230 MHz

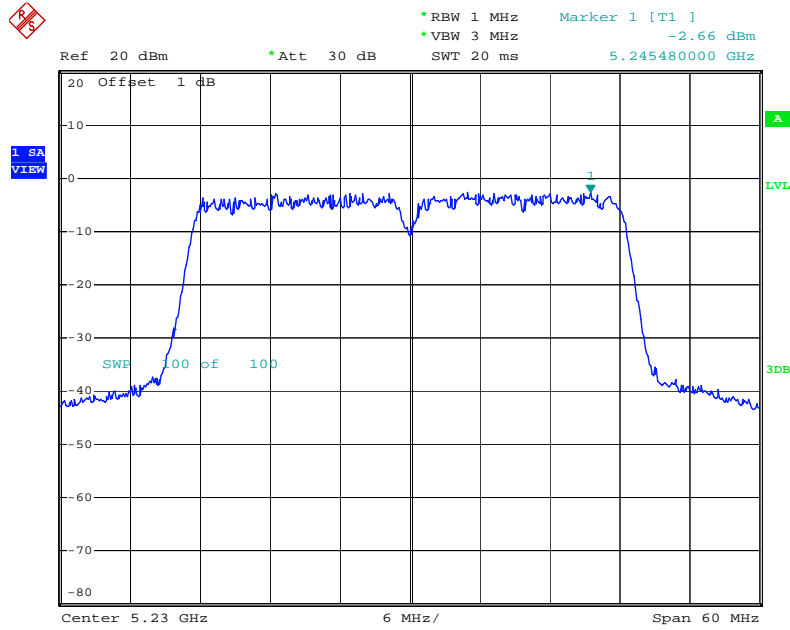

Date: 29.AUG.2011 20:12:43

Power Density Plot on Configuration IEEE 802.11n MCS8 40MHz / Connector 3/ Ant. 3 / 5230 MHz

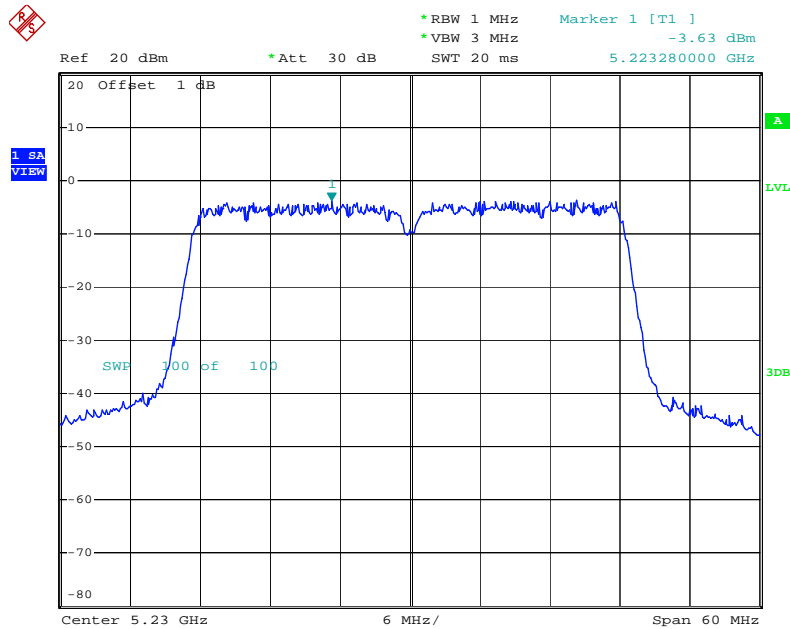

Date: 29.AUG.2011 20:11:50

< For Ant. 3 >

Power Density Plot on Configuration IEEE 802.11n MCS8 40MHz / Connector 1 / Ant. 3 / 5270 MHz

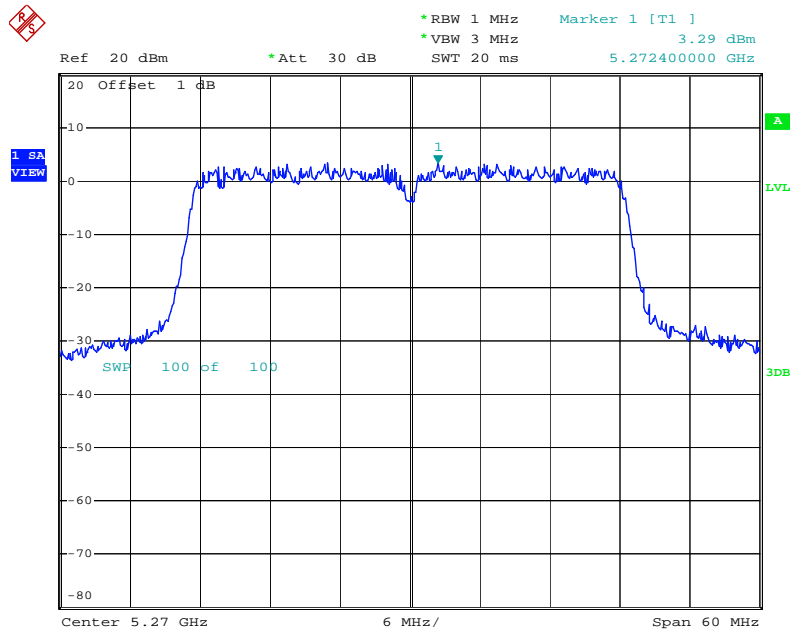

Date: 29.AUG.2011 20:13:27

Power Density Plot on Configuration IEEE 802.11n MCS8 40MHz / Connector 3/ Ant. 3 / 5270 MHz

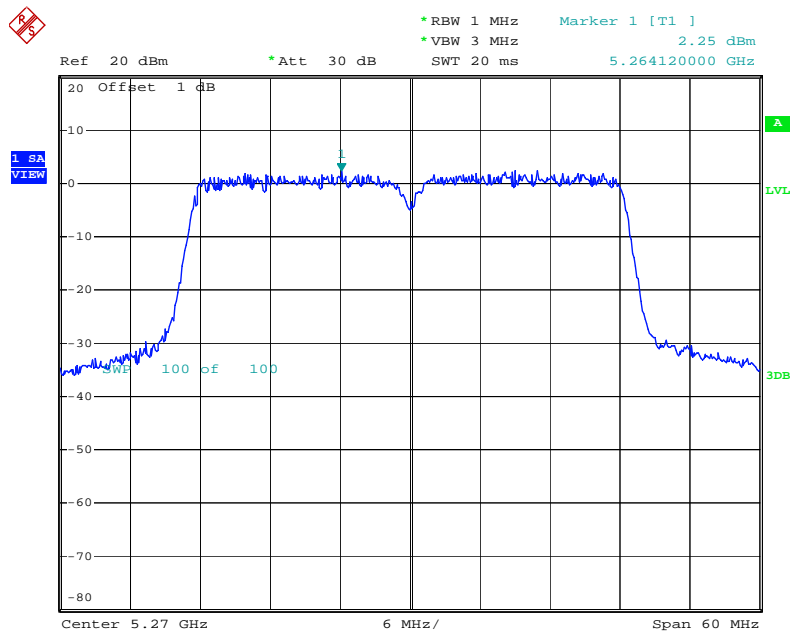

Date: 29.AUG.2011 20:14:15

< For Ant. 3 >

Power Density Plot on Configuration IEEE 802.11n MCS8 40MHz / Connector 1 / Ant. 3 / 5550 MHz

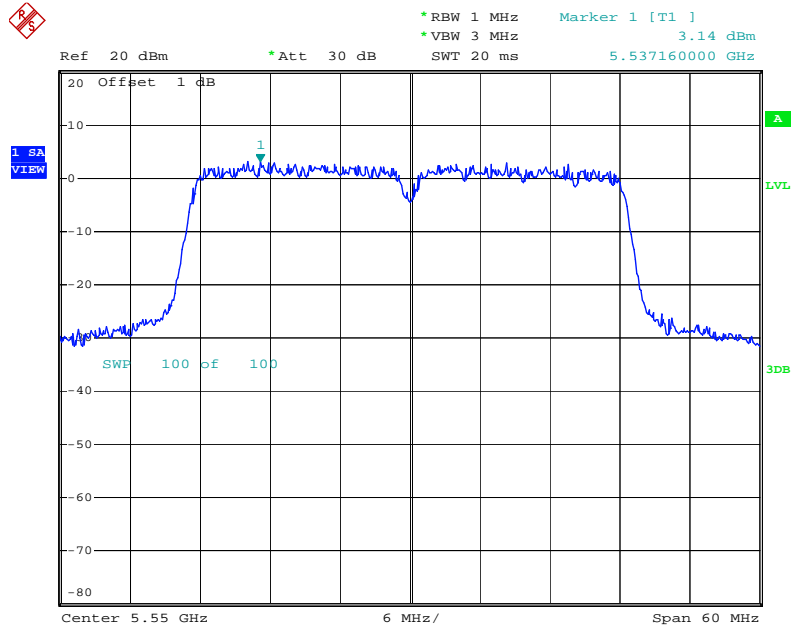

Date: 29.AUG.2011 20:06:29

Power Density Plot on Configuration IEEE 802.11n MCS8 40MHz / Connector 3/ Ant. 3 / 5550 MHz

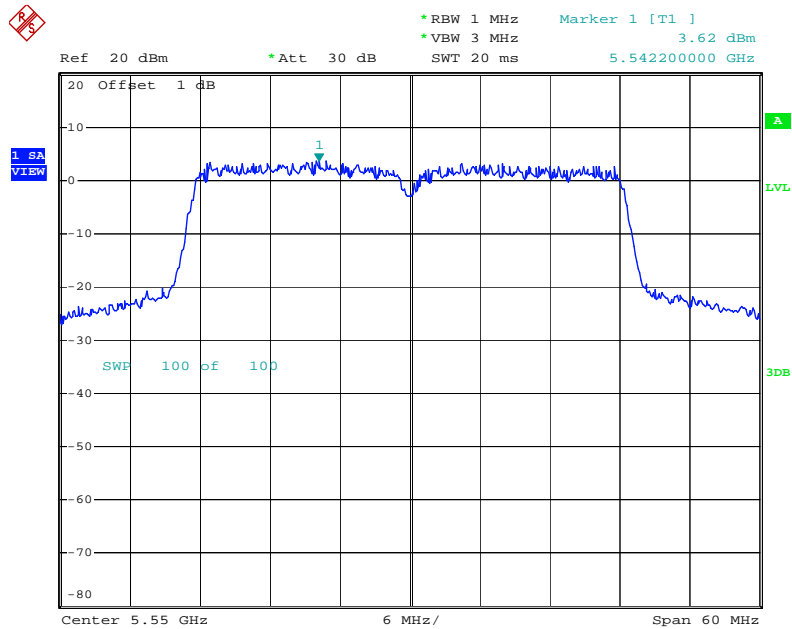

Date: 29.AUG.2011 20:07:04

< For Ant. 3 >

Power Density Plot on Configuration IEEE 802.11a / Connector 1 / Ant. 3 / 5180 MHz

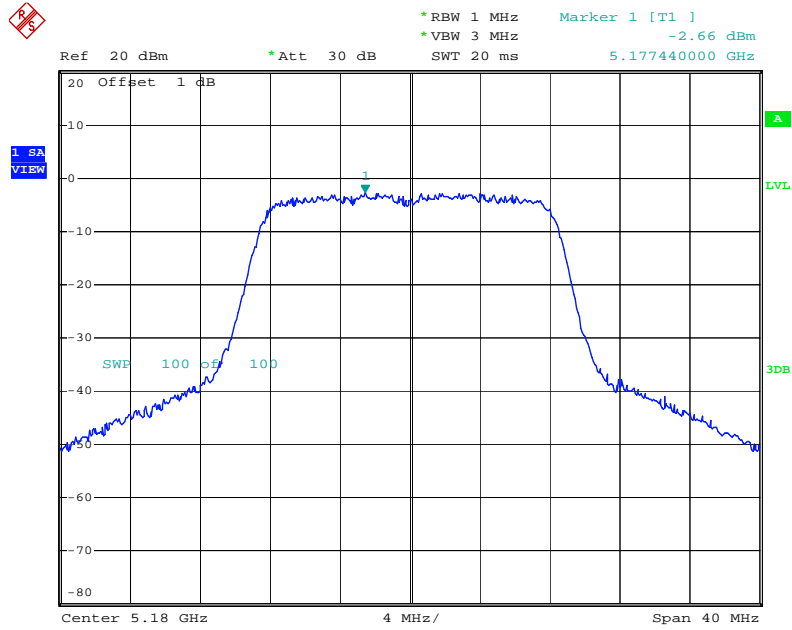

Date: 29.AUG.2011 18:22:13

Power Density Plot on Configuration IEEE 802.11a / Connector 3/ Ant. 3 / 5180 MHz

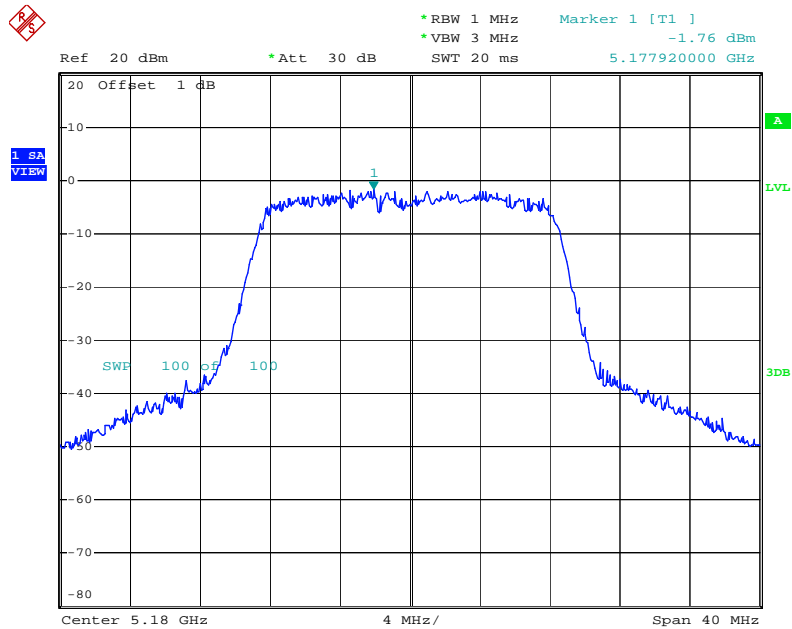

Date: 29.AUG.2011 18:14:30

< For Ant. 3 >

Power Density Plot on Configuration IEEE 802.11a / Connector 1 / Ant. 3 / 5260 MHz

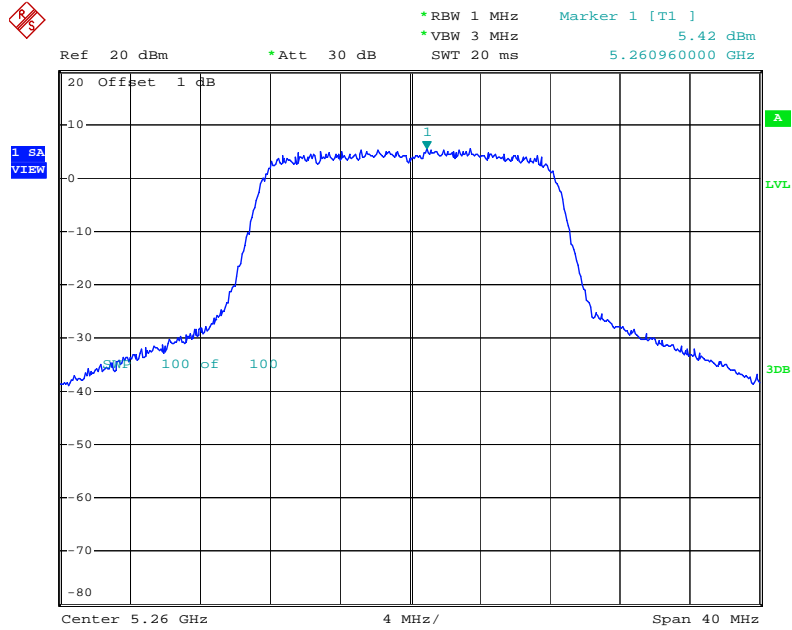

Date: 29.AUG.2011 18:31:25

Power Density Plot on Configuration IEEE 802.11a / Connector 3/ Ant. 3 / 5260 MHz

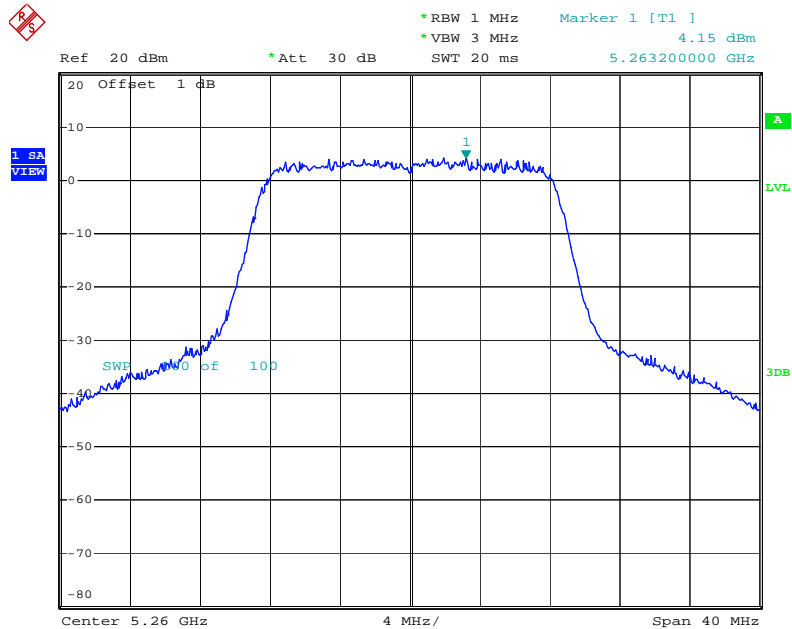

Date: 29.AUG.2011 18:29:06

< For Ant. 3 >

Power Density Plot on Configuration IEEE 802.11a / Connector 1 / Ant. 3 / 5500 MHz

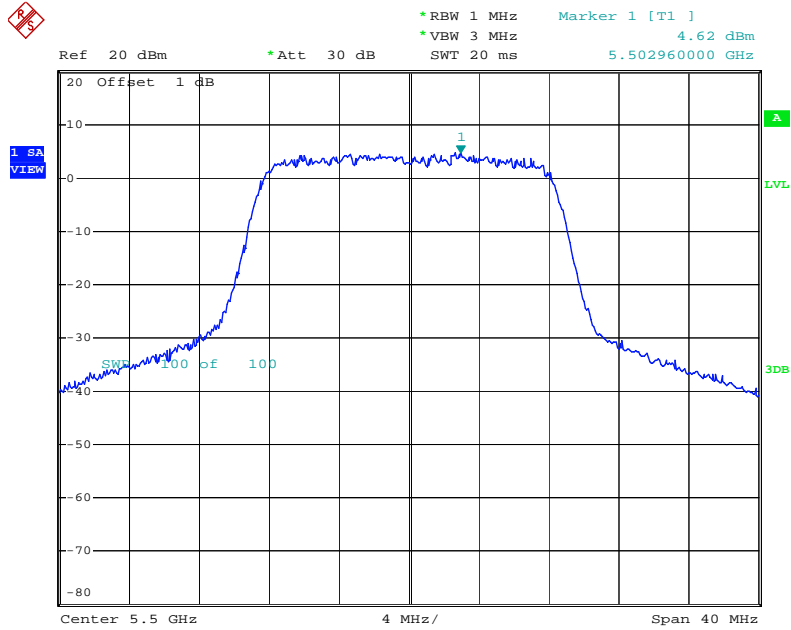

Date: 29.AUG.2011 19:27:20

Power Density Plot on Configuration IEEE 802.11a / Connector 3/ Ant. 3 / 5500 MHz

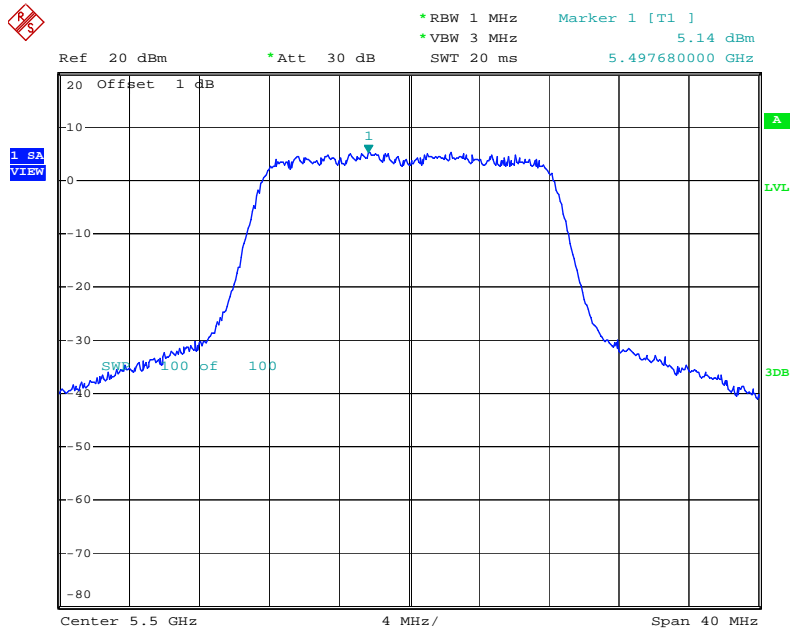

Date: 29.AUG.2011 19:25:00

< For Ant. 4 >

Power Density Plot on Configuration IEEE 802.11n MCS8 20MHz / Connector 1 / Ant. 4 / 5260 MHz

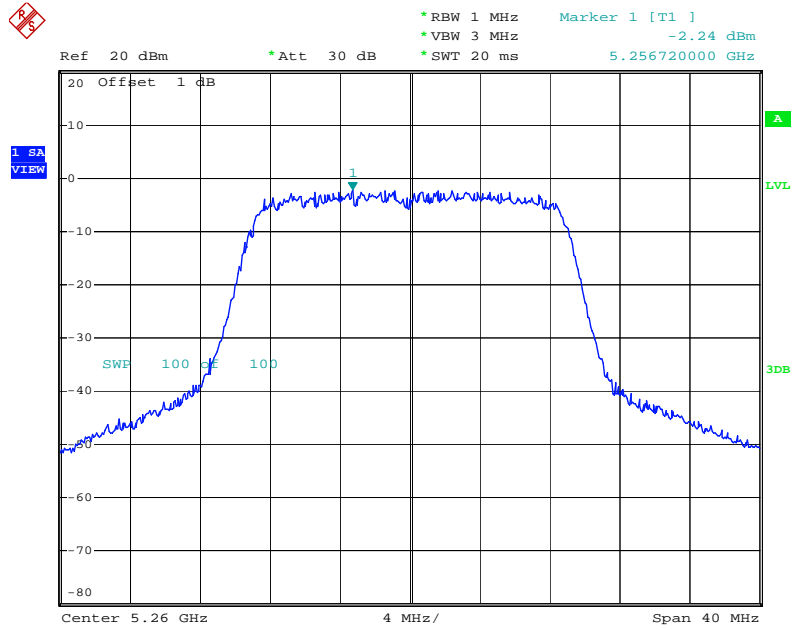

Date: 30.AUG.2011 20:55:55

Power Density Plot on Configuration IEEE 802.11n MCS8 20MHz / Connector 3/ Ant. 4 / 5260 MHz

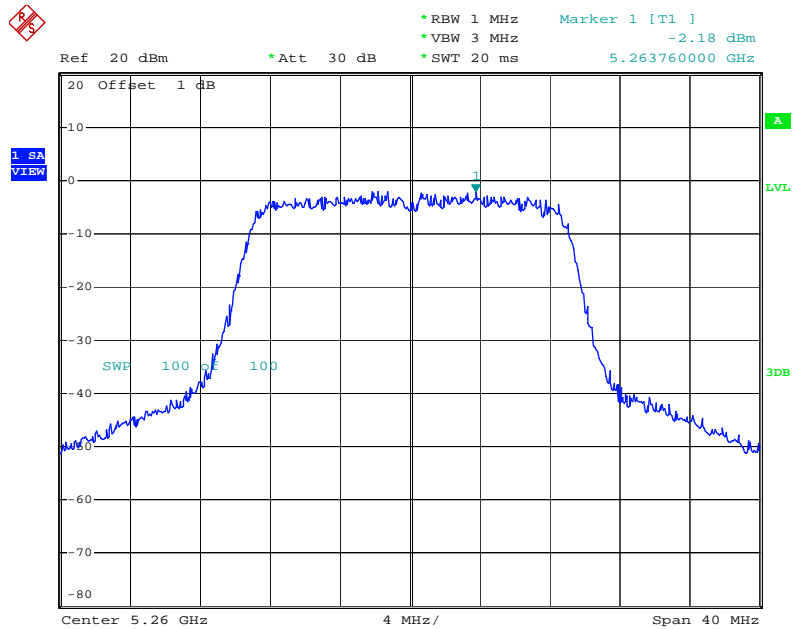

Date: 30.AUG.2011 21:17:52

< For Ant. 4 >

Power Density Plot on Configuration IEEE 802.11n MCS8 20MHz / Connector 1 / Ant. 4 / 5580 MHz

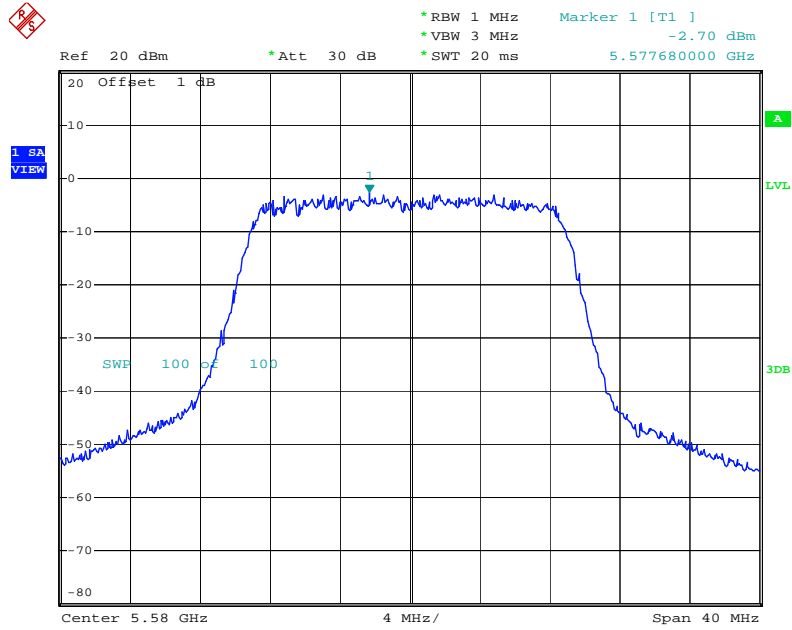

Date: 30.AUG.2011 21:03:45

Power Density Plot on Configuration IEEE 802.11n MCS8 20MHz / Connector 3/ Ant. 4 / 5580 MHz

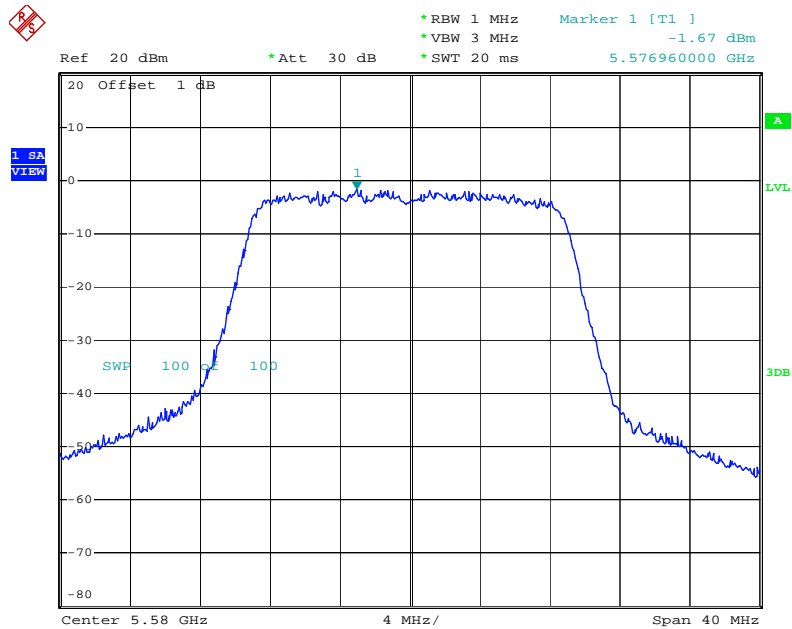

Date: 30.AUG.2011 21:10:20

< For Ant. 4 >

Power Density Plot on Configuration IEEE 802.11n MCS8 40MHz / Connector 1 / Ant. 4 / 5270 MHz

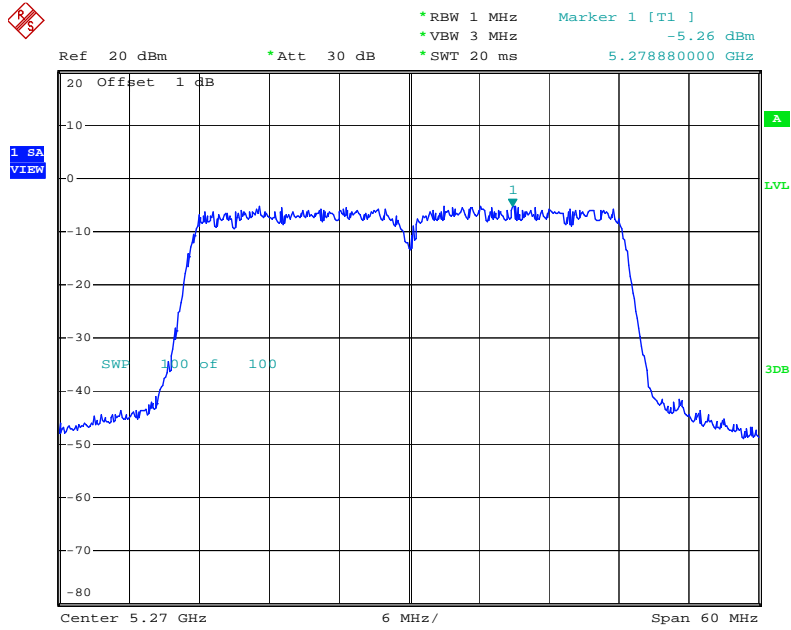

Date: 30.AUG.2011 21:34:59

Power Density Plot on Configuration IEEE 802.11n MCS8 40MHz / Connector 3/ Ant. 4 / 5270 MHz

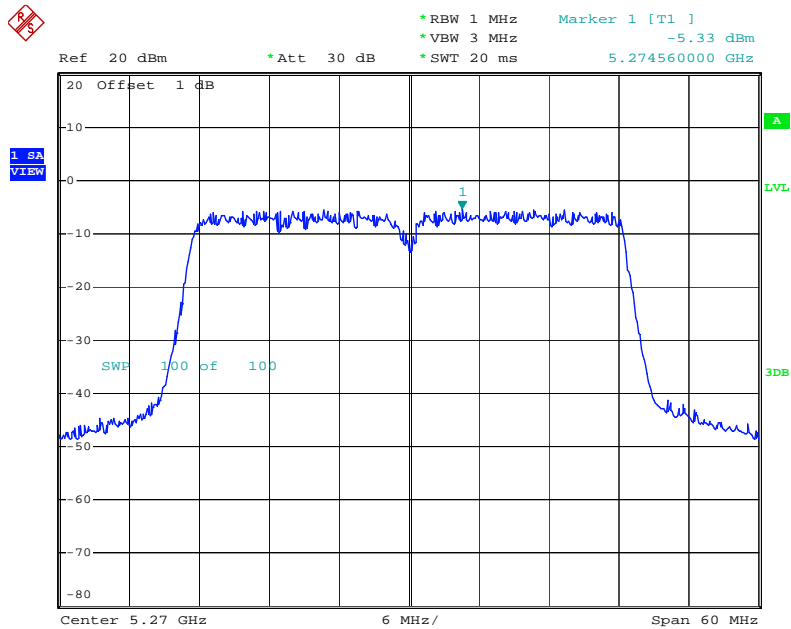

Date: 30.AUG.2011 21:19:46

< For Ant. 4 >

Power Density Plot on Configuration IEEE 802.11n MCS8 40MHz / Connector 1 / Ant. 4 / 5550 MHz

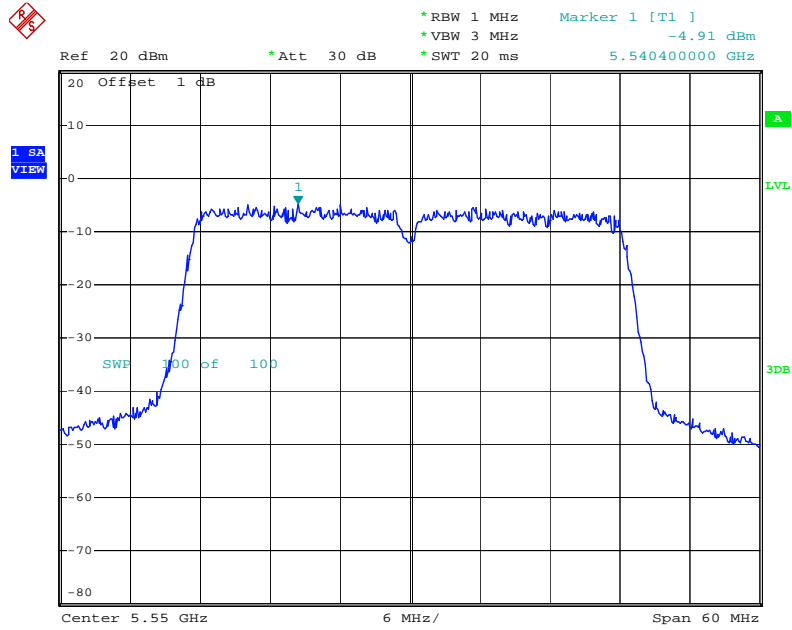

Date: 30.AUG.2011 21:30:16

Power Density Plot on Configuration IEEE 802.11n MCS8 40MHz / Connector 3/ Ant. 4 / 5550 MHz

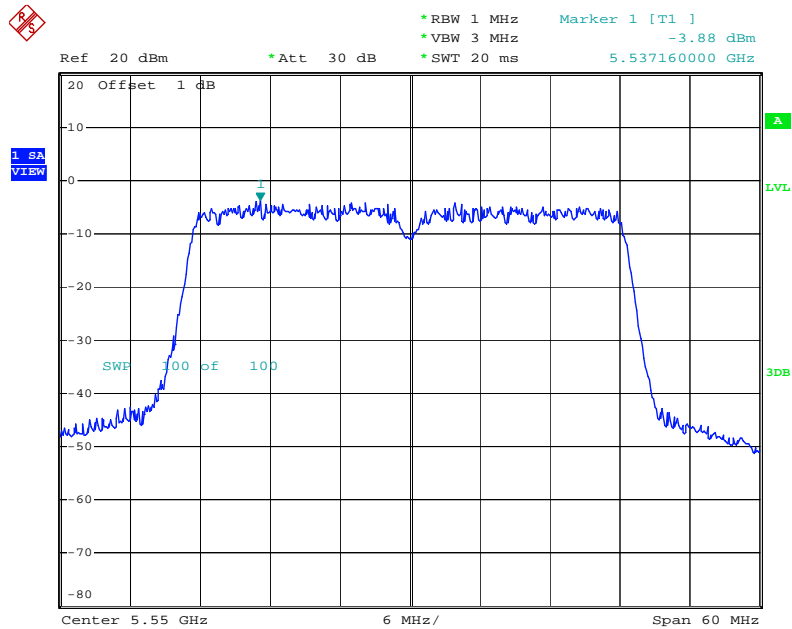

Date: 30.AUG.2011 21:24:34

< For Ant. 4 >

Power Density Plot on Configuration IEEE 802.11a / Connector 1 / Ant. 4 / 5260 MHz

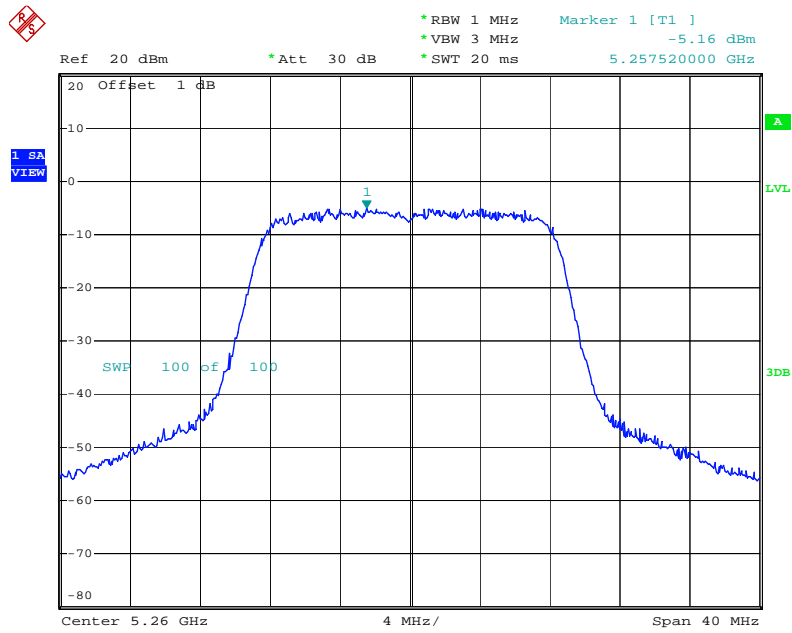

Date: 30.AUG.2011 19:44:12

Power Density Plot on Configuration IEEE 802.11a / Connector 3/ Ant. 4 / 5260 MHz

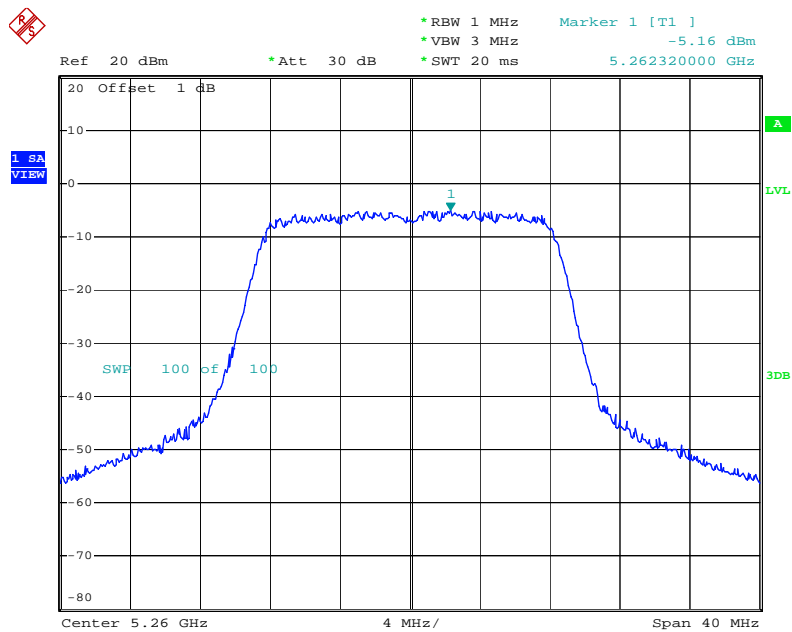

Date: 30.AUG.2011 20:38:36

< For Ant. 4 >

Power Density Plot on Configuration IEEE 802.11a / Connector 1 / Ant. 4 / 5580 MHz

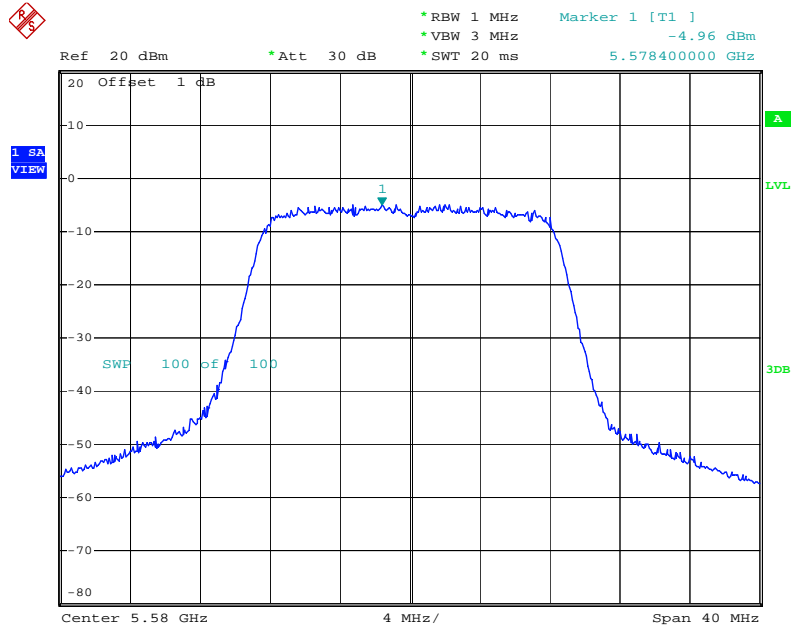

Date: 30.AUG.2011 20:49:01

Power Density Plot on Configuration IEEE 802.11a / Connector 3/ Ant. 4 / 5580 MHz

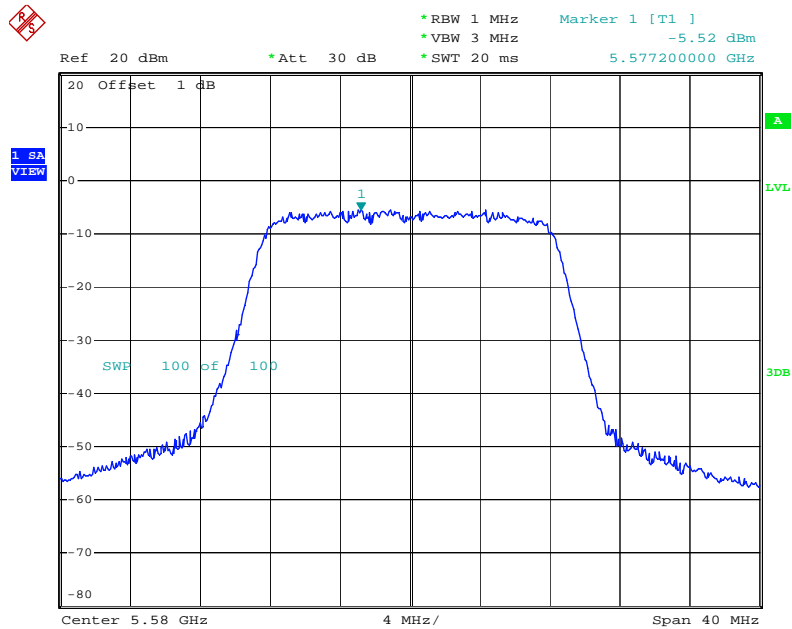

Date: 30.AUG.2011 20:43:09

4.5. Peak Excursion Measurement

4.5.1. Limit

The ratio of the peak excursion of the modulation envelope (measured using a peak hold function) to the maximum conducted output power (measured as specified above) shall not exceed 13 dB across any 1 MHz bandwidth or the emissions bandwidth whichever is less.

4.5.2. Measuring Instruments and Setting

Please refer to section 5 of equipments list in this report. The following table is the setting of the spectrum analyzer.

| Spectrum Parameter | Setting |
|--------------------|--|
| Attenuation | Auto |
| Span Frequency | Encompass the entire emissions bandwidth (EBW) of the signal |
| RB | 1000 kHz (Peak Trace) / 1000 kHz (Average Trace) |
| VB | 3000 kHz (Peak Trace) / 300 kHz (Average Trace) |
| Detector | Peak (Peak Trace) / Sample (Average Trace) |
| Trace | Max Hold |
| Sweep Time | 60s |

4.5.3. Test Procedures

1. The test procedure is the same as section 4.6.3.
2. Trace A, Set RBW = 1MHz, VBW = 3MHz, Span >26dB bandwidth, Max. hold.
3. Delta Mark trace A Maximum frequency and trace B same frequency.
4. Repeat the above procedure until measurements for all frequencies were complete.

4.5.4. Test Setup Layout

This test setup layout is the same as that shown in section 4.6.4.

4.5.5. Test Deviation

There is no deviation with the original standard.

4.5.6. EUT Operation during Test

The EUT was programmed to be in continuously transmitting mode.

4.5.7. Test Result of Peak Excursion

< For Ant. 3 >

| | | | |
|---------------|---------|----------------|-----------------------|
| Temperature | 25°C | Humidity | 56% |
| Test Engineer | Sean Ku | Configurations | IEEE 802.11n / Ant. 3 |

Configuration IEEE 802.11n MCS8 20MHz / Connector 1 + Connector 3

| Channel | Frequency | Peak Excursion (dB) | Max. Limit (dB) | Result |
|---------|-----------|---------------------|-----------------|----------|
| 36 | 5180 MHz | 6.50 | 13 | Complies |
| 40 | 5200 MHz | 5.35 | 13 | Complies |
| 48 | 5240 MHz | 4.78 | 13 | Complies |
| 52 | 5260 MHz | 5.54 | 13 | Complies |
| 60 | 5300 MHz | 4.60 | 13 | Complies |
| 64 | 5320 MHz | 3.93 | 13 | Complies |
| 100 | 5500 MHz | 5.12 | 13 | Complies |
| 116 | 5580 MHz | 4.19 | 13 | Complies |
| 140 | 5700 MHz | 7.55 | 13 | Complies |

Configuration IEEE 802.11n MCS8 40MHz / Connector 1 + Connector 3

| Channel | Frequency | Peak Excursion (dB) | Max. Limit (dB) | Result |
|---------|-----------|---------------------|-----------------|----------|
| 38 | 5190 MHz | 5.10 | 13 | Complies |
| 46 | 5230 MHz | 5.79 | 13 | Complies |
| 54 | 5270 MHz | 5.49 | 13 | Complies |
| 62 | 5310 MHz | 5.54 | 13 | Complies |
| 102 | 5510MHz | 5.77 | 13 | Complies |
| 110 | 5550 MHz | 5.10 | 13 | Complies |
| 134 | 5670 MHz | 6.69 | 13 | Complies |

< For Ant. 3 >

| | | | |
|----------------------|---------|-----------------------|-----------------------|
| Temperature | 25°C | Humidity | 56% |
| Test Engineer | Sean Ku | Configurations | IEEE 802.11a / Ant. 3 |

Configuration IEEE 802.11a / Connector 1 + Connector 3

| Channel | Frequency | Peak Excursion (dB) | Max. Limit (dB) | Result |
|---------|-----------|---------------------|-----------------|----------|
| 36 | 5180 MHz | 4.76 | 13 | Complies |
| 40 | 5200 MHz | 3.70 | 13 | Complies |
| 48 | 5240 MHz | 4.82 | 13 | Complies |
| 52 | 5260 MHz | 5.15 | 13 | Complies |
| 60 | 5300 MHz | 4.78 | 13 | Complies |
| 64 | 5320 MHz | 5.22 | 13 | Complies |
| 100 | 5500 MHz | 5.09 | 13 | Complies |
| 116 | 5580 MHz | 5.00 | 13 | Complies |
| 140 | 5700 MHz | 6.34 | 13 | Complies |

Note: All the test values were listed in the report.

For plots, only the channel with maximum results was shown.

< For Ant. 4 >

| | | | |
|----------------------|---------|-----------------------|-----------------------|
| Temperature | 25°C | Humidity | 56% |
| Test Engineer | Sean Ku | Configurations | IEEE 802.11n / Ant. 4 |

Configuration IEEE 802.11n MCS8 20MHz / Connector 1 + Connector 3

| Channel | Frequency | Peak Excursion (dB) | Max. Limit (dB) | Result |
|---------|-----------|---------------------|-----------------|----------|
| 52 | 5260 MHz | 6.32 | 13 | Complies |
| 60 | 5300 MHz | 5.82 | 13 | Complies |
| 64 | 5320 MHz | 5.60 | 13 | Complies |
| 100 | 5500 MHz | 5.00 | 13 | Complies |
| 116 | 5580 MHz | 6.28 | 13 | Complies |
| 140 | 5700 MHz | 4.87 | 13 | Complies |

Configuration IEEE 802.11n MCS8 40MHz / Connector 1 + Connector 3

| Channel | Frequency | Peak Excursion (dB) | Max. Limit (dB) | Result |
|---------|-----------|---------------------|-----------------|----------|
| 54 | 5270 MHz | 5.21 | 13 | Complies |
| 62 | 5310 MHz | 4.82 | 13 | Complies |
| 102 | 5510MHz | 6.28 | 13 | Complies |
| 110 | 5550 MHz | 4.79 | 13 | Complies |
| 134 | 5670 MHz | 5.57 | 13 | Complies |

< For Ant. 4 >

| | | | |
|----------------------|---------|-----------------------|-----------------------|
| Temperature | 25°C | Humidity | 56% |
| Test Engineer | Sean Ku | Configurations | IEEE 802.11a / Ant. 4 |

Configuration IEEE 802.11a / Connector 1 + Connector 3

| Channel | Frequency | Peak Excursion (dB) | Max. Limit (dB) | Result |
|---------|-----------|---------------------|-----------------|----------|
| 52 | 5260 MHz | 5.59 | 13 | Complies |
| 60 | 5300 MHz | 5.41 | 13 | Complies |
| 64 | 5320 MHz | 4.86 | 13 | Complies |
| 100 | 5500 MHz | 5.08 | 13 | Complies |
| 116 | 5580 MHz | 5.32 | 13 | Complies |
| 140 | 5700 MHz | 4.77 | 13 | Complies |

Note: All the test values were listed in the report.

For plots, only the channel with maximum results was shown.

< For Ant. 3 >

Peak Excursion Plot on Configuration IEEE 802.11n MCS8 20MHz / Connector 1 + Connector 3 /
Ant. 3 / 5180 MHz

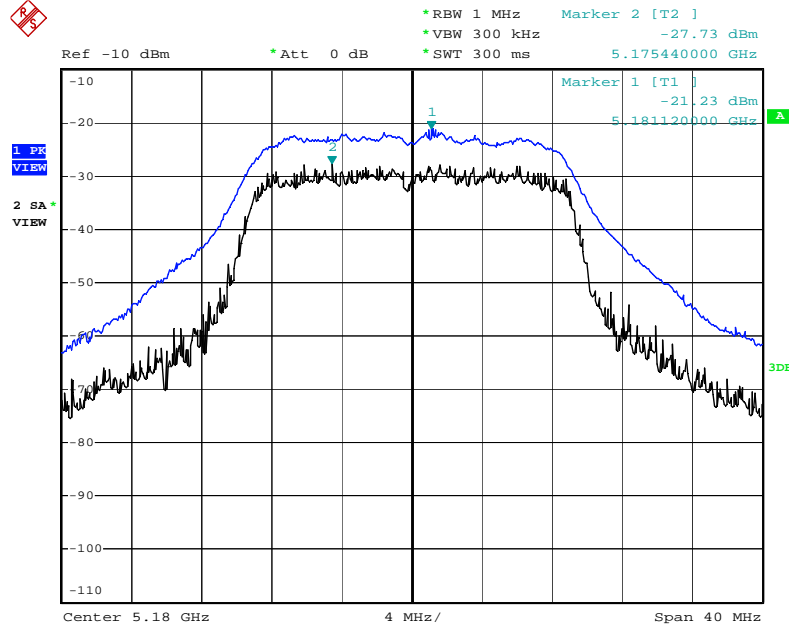

Date: 29.AUG.2011 20:33:08

Peak Excursion Plot on Configuration IEEE 802.11n MCS8 20MHz / Connector 1 + Connector 3 /
Ant. 3 / 5260 MHz

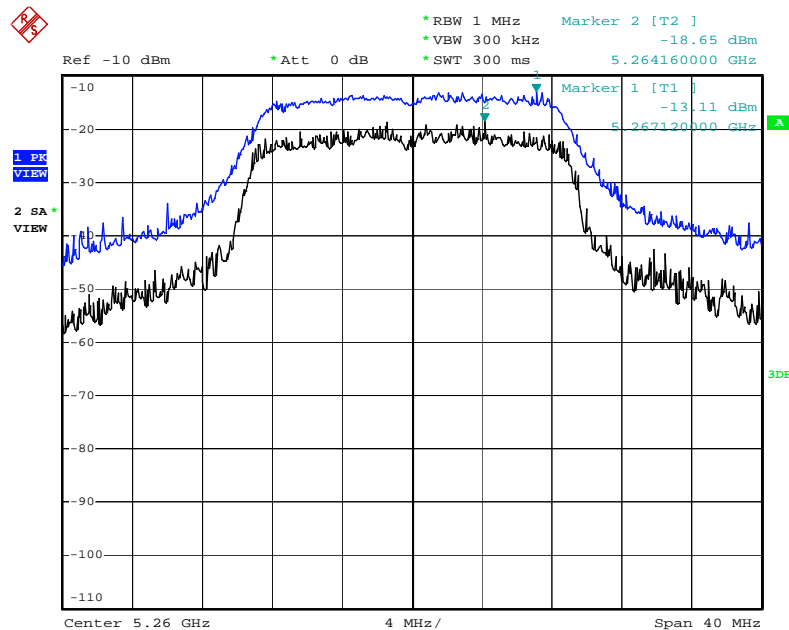

Date: 29.AUG.2011 20:36:54

< For Ant. 3 >

Peak Excursion Plot on Configuration IEEE 802.11n MCS8 20MHz / Connector 1 + Connector 3 / Ant. 3 / 5700 MHz

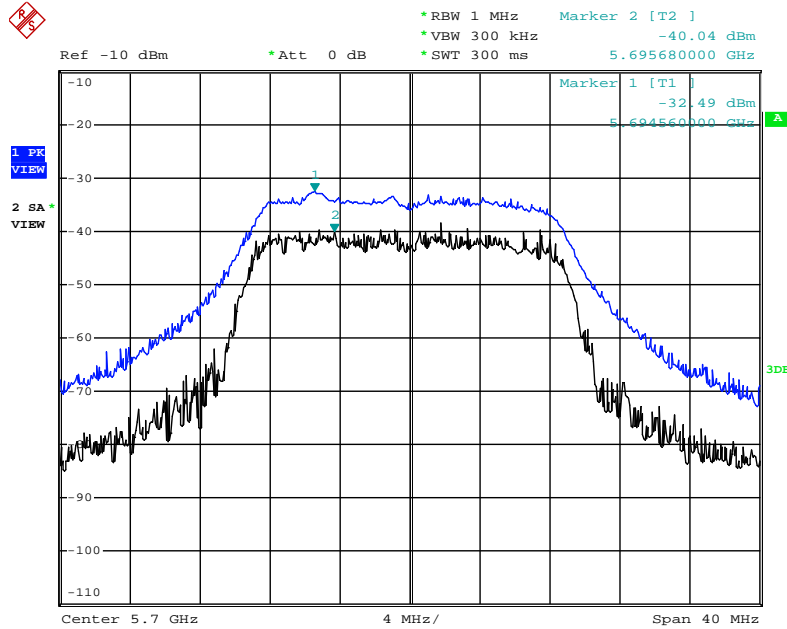

Date: 3.NOV.2011 22:33:02

Peak Excursion Plot on Configuration IEEE 802.11n MCS8 40MHz / Connector 1 + Connector 3 / Ant. 3 / 5230MHz

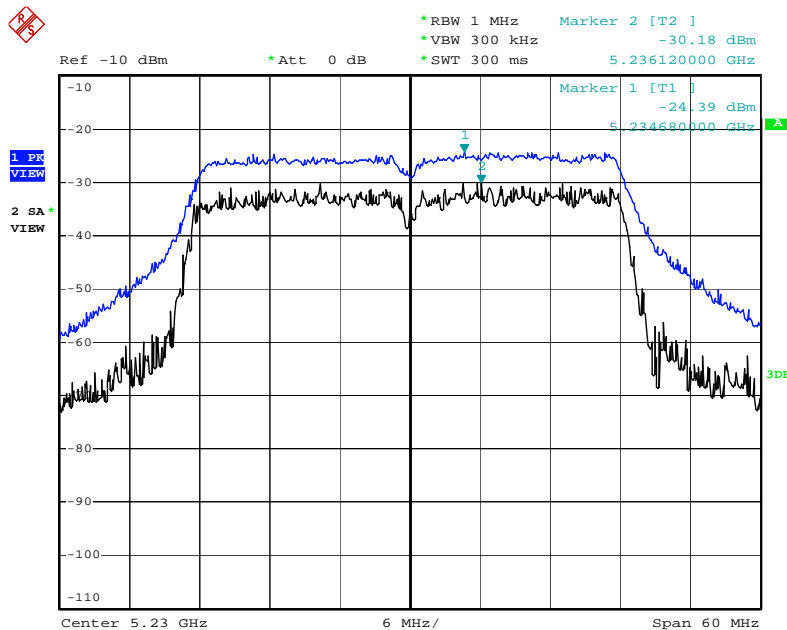

Date: 29.AUG.2011 20:45:18

< For Ant. 3 >

Peak Excursion Plot on Configuration IEEE 802.11n MCS8 40MHz / Connector 1 + Connector 3 / Ant. 3 / 5310MHz

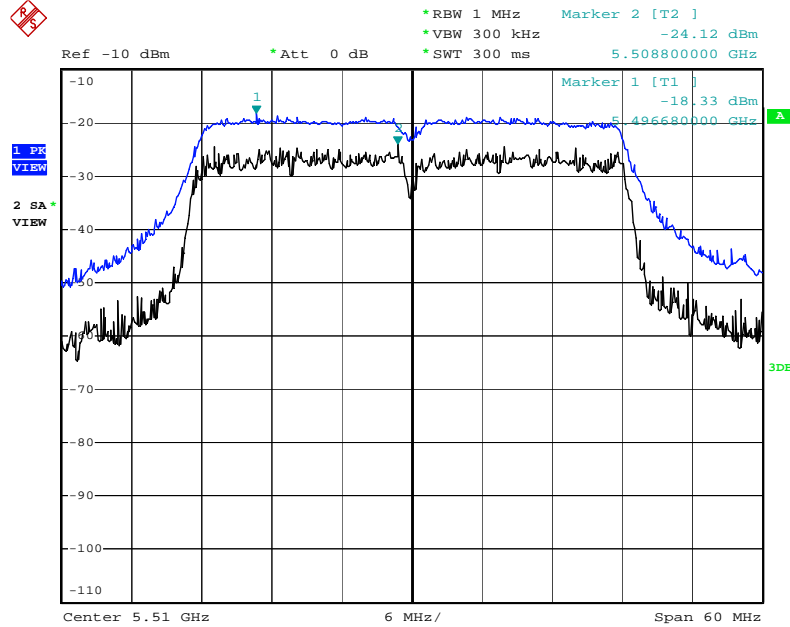

Date: 29.AUG.2011 20:48:34

Peak Excursion Plot on Configuration IEEE 802.11n MCS8 40MHz / Connector 1 + Connector 3 / Ant. 3 / 5670MHz

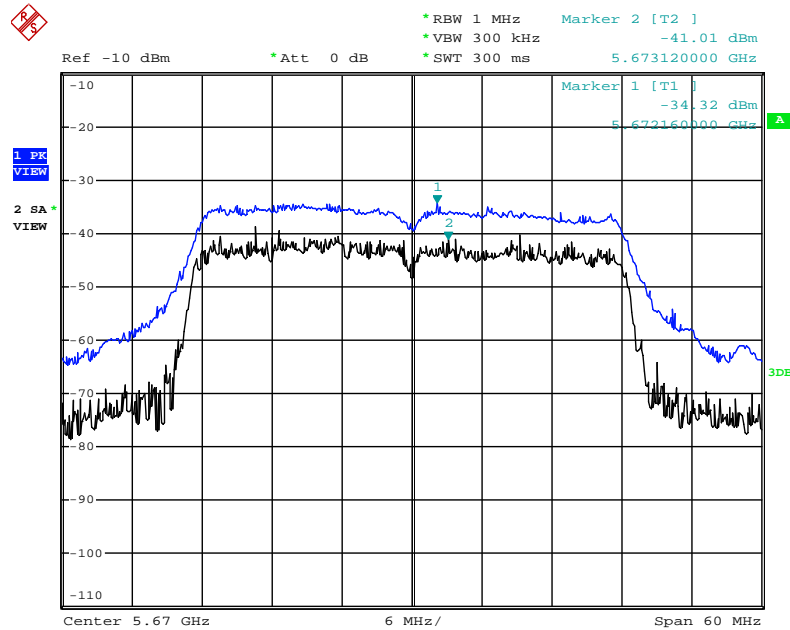

Date: 3.NOV.2011 22:11:56

< For Ant. 3 >

Peak Excursion Plot on Configuration IEEE 802.11a / Connector 1 + Connector 3 /
Ant. 3 / 5240MHz

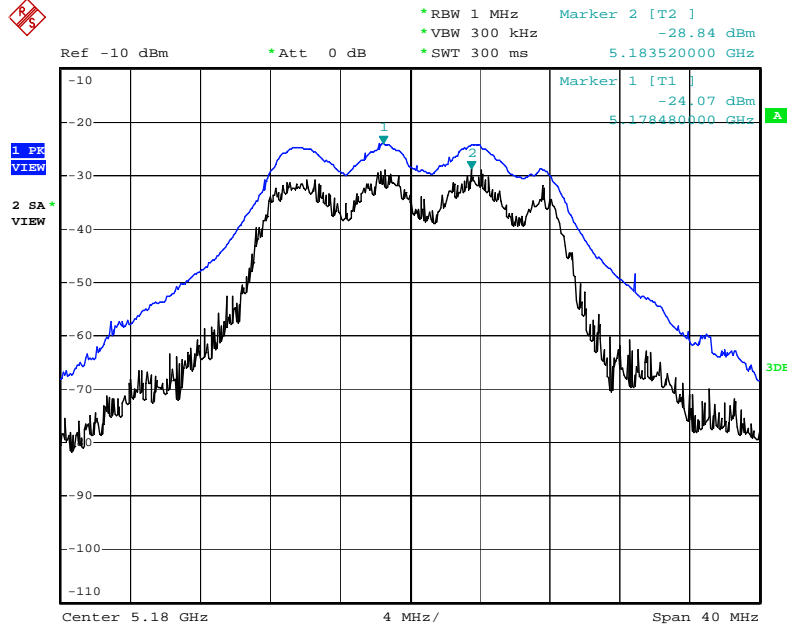

Date: 29.AUG.2011 20:23:20

Peak Excursion Plot on Configuration IEEE 802.11a / Connector 1 + Connector 3 /
Ant. 3 / 5320 MHz

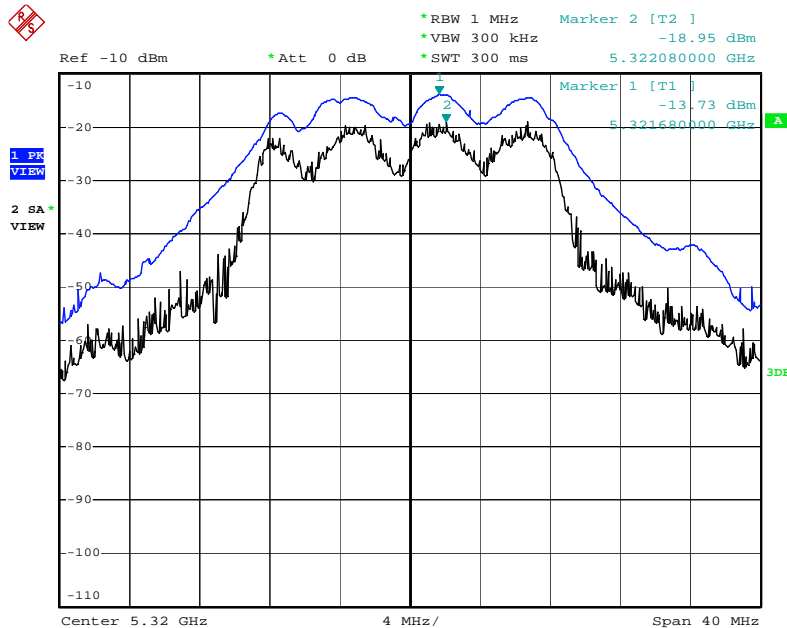

Date: 29.AUG.2011 20:28:31

< For Ant. 3 >

Peak Excursion Plot on Configuration IEEE 802.11a / Connector 1 + Connector 3 /
Ant. 3 / 5700MHz

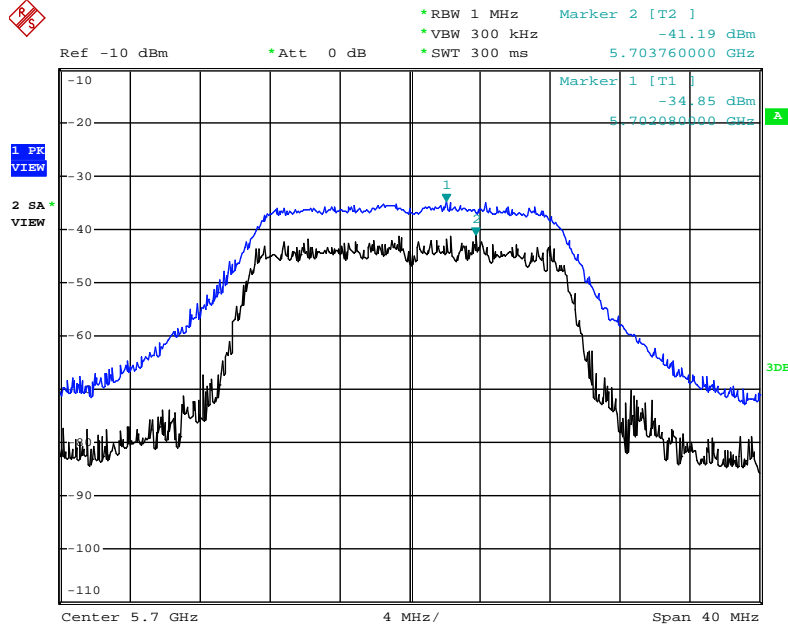

Date: 3.NOV.2011 22:20:32

< For Ant. 4 >

Peak Excursion Plot on Configuration IEEE 802.11n MCS8 20MHz / Connector 1 + Connector 3 / Ant. 4 / 5260 MHz

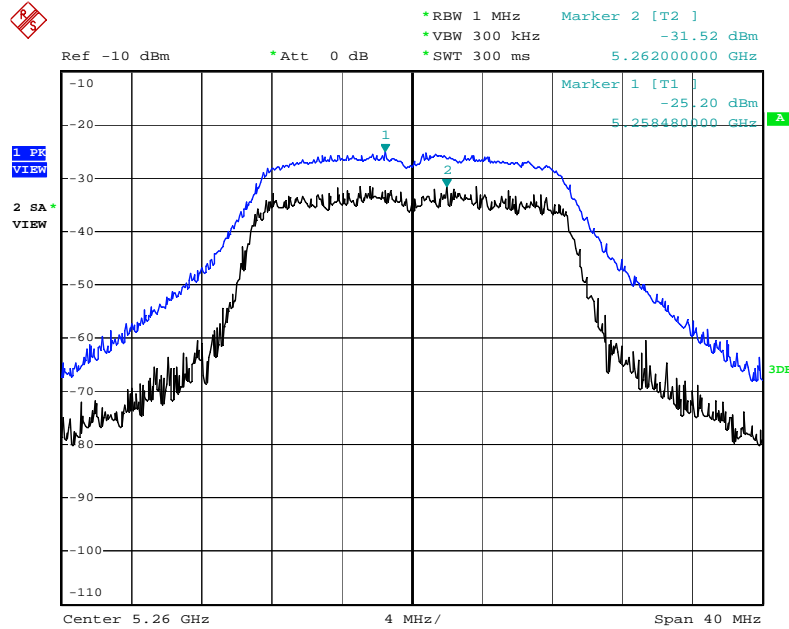

Date: 30.AUG.2011 22:49:43

Peak Excursion Plot on Configuration IEEE 802.11n MCS8 20MHz / Connector 1 + Connector 3 / Ant. 4 / 5580 MHz

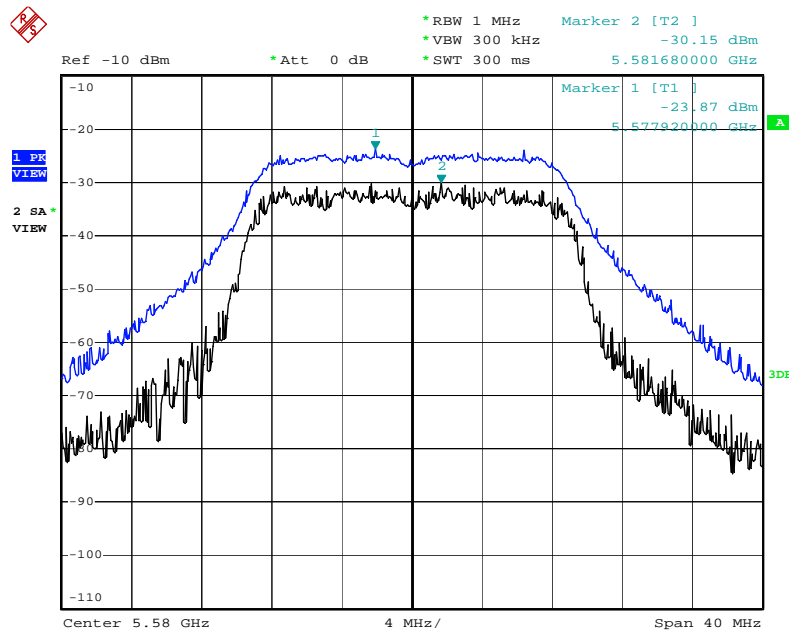

Date: 30.AUG.2011 22:45:13

< For Ant. 4 >

Peak Excursion Plot on Configuration IEEE 802.11n MCS8 40MHz / Connector 1 + Connector 3 / Ant. 4 / 5270MHz

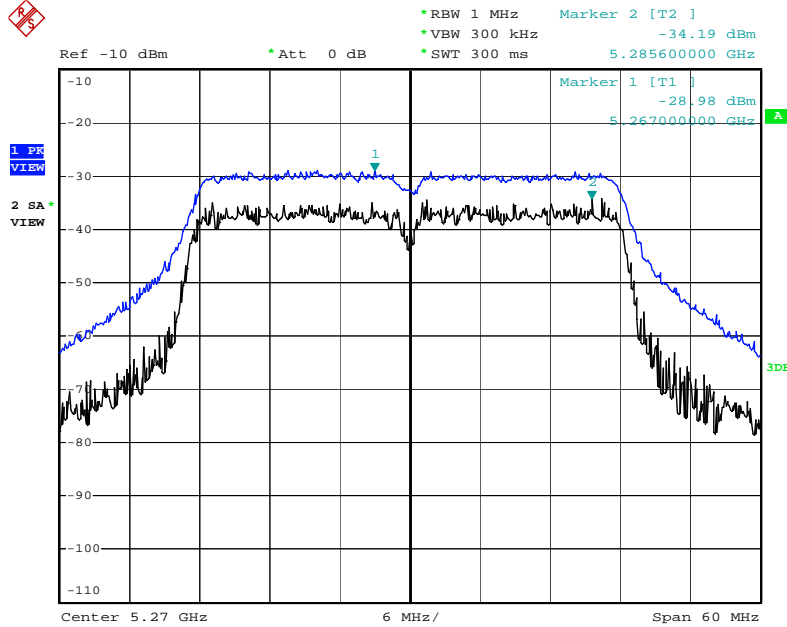

Date: 30.AUG.2011 22:52:12

Peak Excursion Plot on Configuration IEEE 802.11n MCS8 40MHz / Connector 1 + Connector 3 / Ant. 4 / 5510 MHz

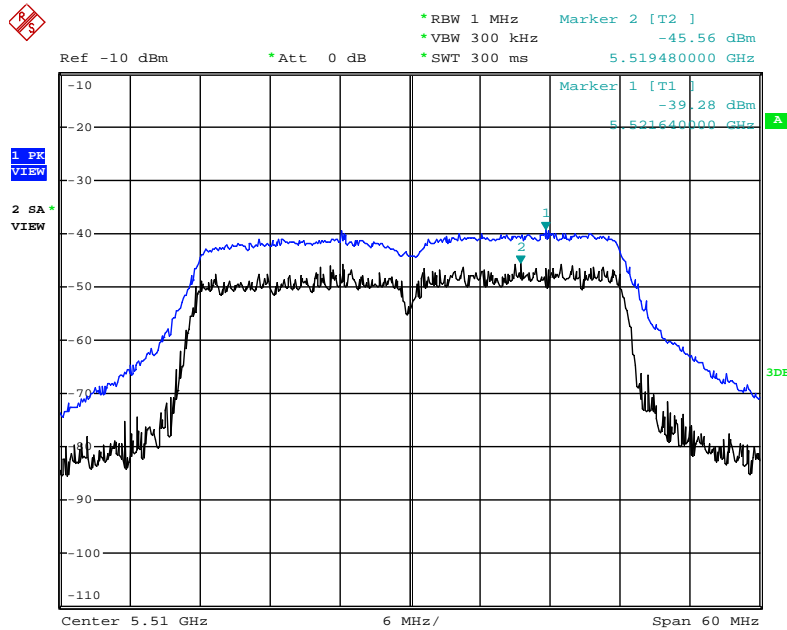

Date: 3.NOV.2011 22:14:13

< For Ant. 4 >

**Peak Excursion Plot on Configuration IEEE 802.11a / Connector 1 + Connector 3 /
Ant. 4 / 5260MHz**

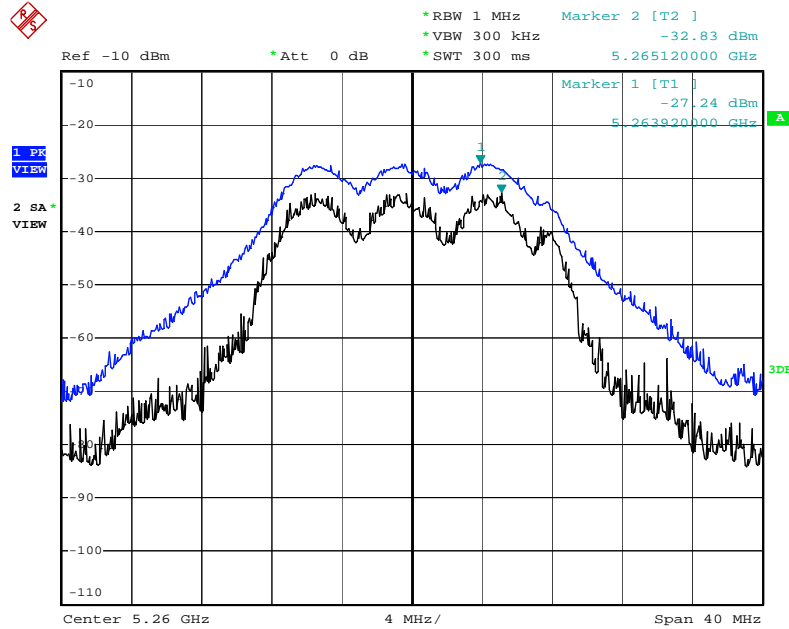

Date: 30.AUG.2011 22:35:52

**Peak Excursion Plot on Configuration IEEE 802.11a / Connector 1 + Connector 3 /
Ant. 4 / 5580 MHz**

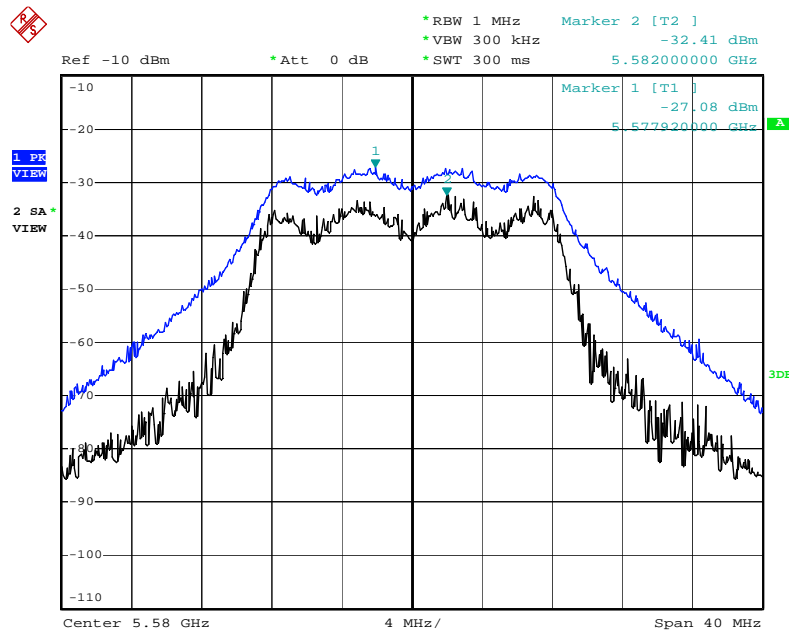

Date: 30.AUG.2011 22:41:02

4.6. Radiated Emissions Measurement

4.6.1. Limit

For transmitters operating in the 5.15-5.35 GHz band: all emissions outside of the 5.15-5.35 GHz band shall not exceed an EIRP of -27 dBm/MHz (68.3dBuV/m at 3m). For transmitters operating in the 5.470-5.725 GHz band: all emissions outside of the 5.470-5.725 GHz band shall not exceed an EIRP of -27 dBm/MHz (68.3dBuV/m at 3m). For transmitters operating in the 5.725-5.825 GHz band: all emissions within the frequency range from the band edge to 10 MHz above or below the band edge shall not exceed an EIRP of -17 dBm/MHz (78.3dBuV/m at 3m); for frequencies 10 MHz or greater above or below the band edge, emissions shall not exceed an EIRP of -27 dBm/MHz (68.3dBuV/m at 3m). In addition, in case the emission falls within the restricted band specified on 15.205(a), then the 15.209(a) limit in the table below has to be followed.

| Frequencies (MHz) | Field Strength (microrvolts/meter) | Measurement Distance (meters) |
|-------------------|------------------------------------|-------------------------------|
| 0.009~0.490 | 2400/F(KHz) | 300 |
| 0.490~1.705 | 24000/F(KHz) | 30 |
| 1.705~30.0 | 30 | 30 |
| 30~88 | 100 | 3 |
| 88~216 | 150 | 3 |
| 216~960 | 200 | 3 |
| Above 960 | 500 | 3 |

4.6.2. Measuring Instruments and Setting

Please refer to section 5 of equipments list in this report. The following table is the setting of spectrum analyzer and receiver.

| Spectrum Parameter | Setting |
|---|--|
| Attenuation | Auto |
| Start Frequency | 1000 MHz |
| Stop Frequency | 40 GHz |
| RB / VB (Emission in restricted band) | 1MHz / 1MHz for Peak, 1 MHz / 10Hz for Average |
| RB / VB (Emission in non-restricted band) | 1000KHz / 1000KHz for peak |

| Receiver Parameter | Setting |
|------------------------|----------------------------------|
| Attenuation | Auto |
| Start ~ Stop Frequency | 9kHz~150kHz / RB 200Hz for QP |
| Start ~ Stop Frequency | 150kHz~30MHz / RB 9kHz for QP |
| Start ~ Stop Frequency | 30MHz~1000MHz / RB 120kHz for QP |

4.6.3. Test Procedures

1. Configure the EUT according to ANSI C63.10. The EUT was placed on the top of the turntable 0.8 meter above ground. The phase center of the receiving antenna mounted on the top of a height-variable antenna tower was placed 3 meters far away from the turntable.
2. Power on the EUT and all the supporting units. The turntable was rotated by 360 degrees to determine the position of the highest radiation.
3. The height of the broadband receiving antenna was varied between one meter and four meters above ground to find the maximum emissions field strength of both horizontal and vertical polarization.
4. For each suspected emissions, the antenna tower was scan (from 1 M to 4 M) and then the turntable was rotated (from 0 degree to 360 degrees) to find the maximum reading.
5. Set the test-receiver system to Peak or CISPR quasi-peak Detect Function with specified bandwidth under Maximum Hold Mode.
6. For emissions above 1GHz, use 1MHz VBW and RBW for peak reading. Then 1MHz RBW and 10Hz VBW for average reading in spectrum analyzer.
7. When the radiated emissions limits are expressed in terms of the average value of the emissions, and pulsed operation is employed, the measurement field strength shall be determined by averaging over one complete pulse train, including blanking intervals, as long as the pulse train does not exceed 0.1 seconds. As an alternative (provided the transmitter operates for longer than 0.1 seconds) or in cases where the pulse train exceeds 0.1 seconds, the measured field strength shall be determined from the average absolute voltage during a 0.1 second interval during which the field strength is at its maximum value.
8. If the emissions level of the EUT in peak mode was 3 dB lower than the average limit specified, then testing will be stopped and peak values of EUT will be reported, otherwise, the emissions which do not have 3 dB margin will be repeated one by one using the quasi-peak method for below 1GHz.
9. For testing above 1GHz, the emissions level of the EUT in peak mode was lower than average limit (that means the emissions level in peak mode also complies with the limit in average mode), then testing will be stopped and peak values of EUT will be reported, otherwise, the emissions will be measured in average mode again and reported.
10. In case the emission is lower than 30MHz, loop antenna has to be used for measurement and the recorded data should be QP measured by receiver. High – Low scan is not required in this case.

4.6.4. Test Setup Layout

For radiated emissions below 1GHz

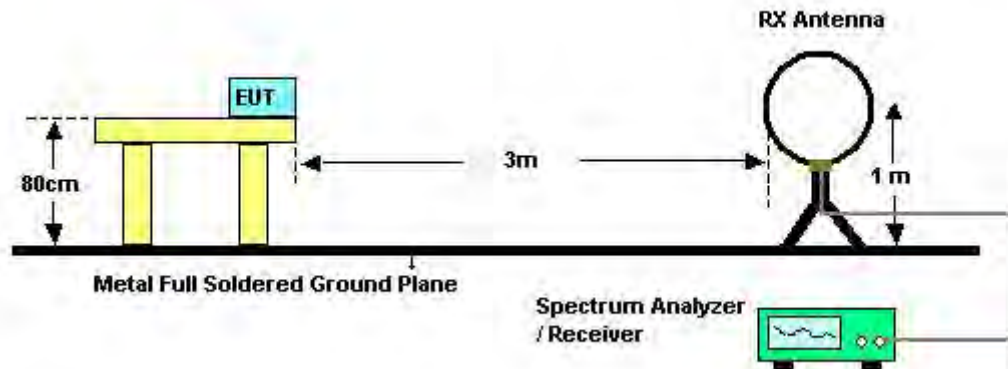

For radiated emissions above 1GHz

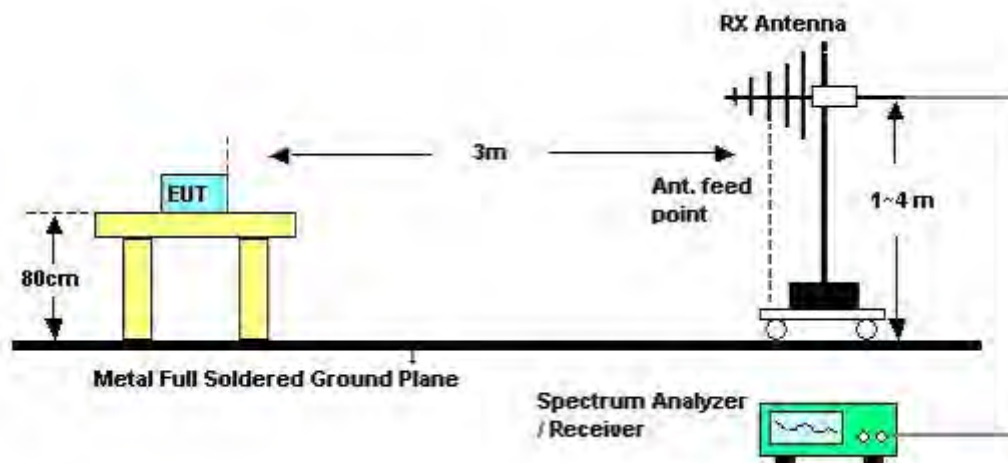

4.6.5. Test Deviation

There is no deviation with the original standard.

4.6.6. EUT Operation during Test

The EUT was programmed to be in continuously transmitting mode.

4.6.7. Results of Radiated Emissions (9kHz~30MHz)

| | | | |
|----------------------|---------------|-----------------------|-------------|
| Temperature | 24°C | Humidity | 63% |
| Test Engineer | Serway Li | Configurations | Normal Link |
| Test Date | Sep. 01, 2011 | | |

| Freq. (MHz) | Level (dBuV) | Over Limit (dB) | Limit Line (dBuV) | Remark |
|--------------------|---------------------|------------------------|--------------------------|---------------|
| - | - | - | - | See Note |

Note:

The amplitude of spurious emissions that are attenuated by more than 20dB below the permissible value has no need to be reported.

Distance extrapolation factor = $40 \log(\text{specific distance} / \text{test distance})$ (dB);

Limit line = specific limits (dBuV) + distance extrapolation factor.

4.6.8. Results of Radiated Emissions (30MHz~1GHz)

| | | | |
|---------------|-----------|----------------|-------------|
| Temperature | 24°C | Humidity | 63% |
| Test Engineer | Serway Li | Configurations | Normal Link |

Horizontal

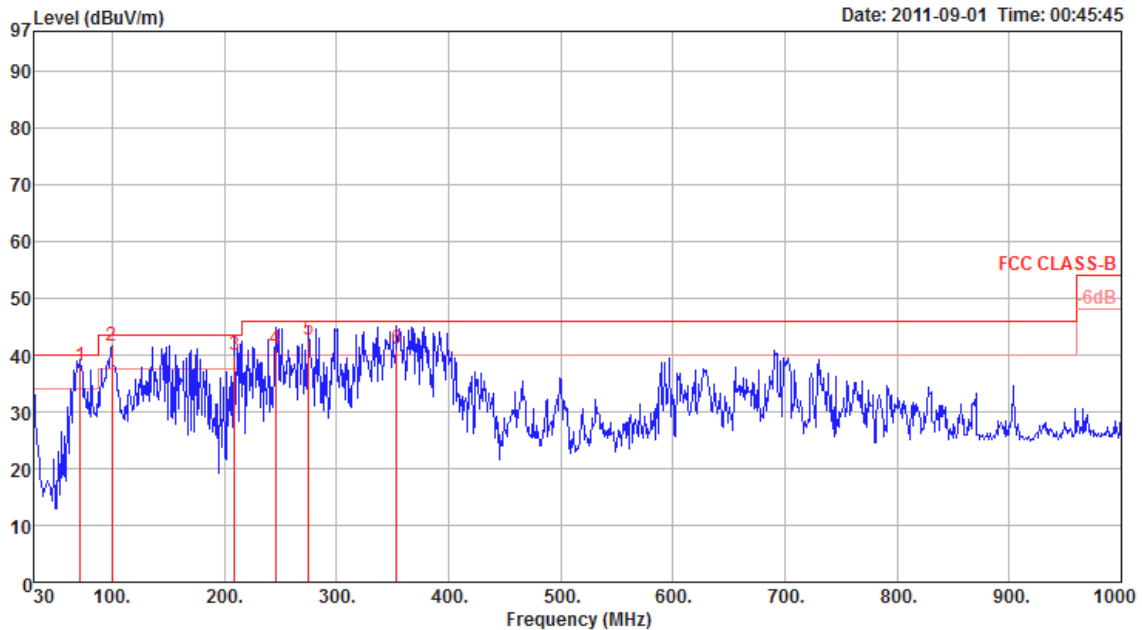

| | Freq | Level | Limit | Over | Read | Cable | Preamp | Antenna | T/Pos | A/Pos | Remark | Pol/Phase |
|---|--------|--------|--------|-------|-------|-------|--------|---------|-------|-------|--------|------------|
| | MHz | dBuV/m | dBuV/m | dB | dBuV | dB | dB | dB/m | deg | cm | | |
| 1 | 71.74 | 38.09 | 40.00 | -1.91 | 58.39 | 1.28 | 27.71 | 6.13 | 182 | 100 | QP | HORIZONTAL |
| 2 | 99.84 | 41.65 | 43.50 | -1.85 | 56.87 | 1.50 | 27.60 | 10.88 | 126 | 100 | QP | HORIZONTAL |
| 3 | 209.45 | 40.00 | 43.50 | -3.50 | 55.76 | 2.17 | 27.08 | 9.15 | 179 | 100 | QP | HORIZONTAL |
| 4 | 245.34 | 40.97 | 46.00 | -5.03 | 53.19 | 2.34 | 27.01 | 12.45 | 189 | 100 | QP | HORIZONTAL |
| 5 | 275.41 | 42.74 | 46.00 | -3.26 | 54.05 | 2.51 | 26.95 | 13.13 | 215 | 100 | QP | HORIZONTAL |
| 6 | 353.98 | 41.05 | 46.00 | -4.95 | 50.44 | 2.81 | 27.28 | 15.08 | 256 | 100 | QP | HORIZONTAL |

Vertical

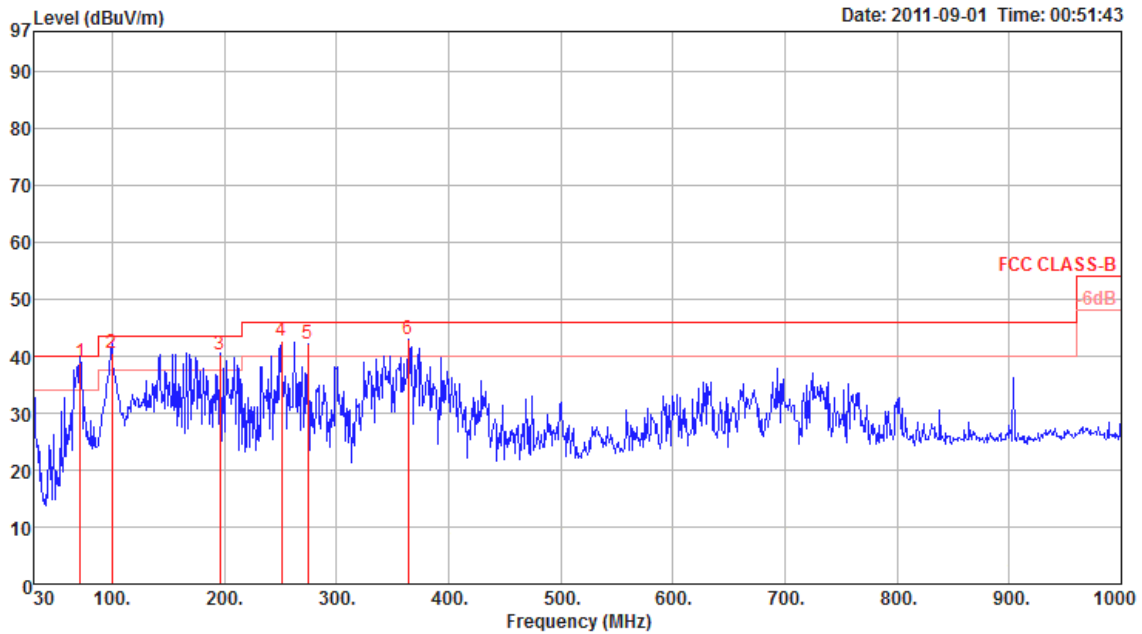

| | Freq | Level | Limit | Over | Read | Cable | Preamp | Antenna | T/Pos | A/Pos | Remark | Pol/Phase |
|---|------|--------|--------|-------|-------|-------|--------|---------|-------|-------|----------|-----------|
| | MHz | dBuV/m | dBuV/m | dB | dBuV | dB | dB | dB/m | deg | cm | | |
| 1 | q | 71.71 | 38.87 | 40.00 | -1.13 | 59.17 | 1.28 | 27.71 | 6.13 | 169 | 100 QP | VERTICAL |
| 2 | ! | 99.84 | 40.53 | 43.50 | -2.97 | 55.75 | 1.50 | 27.60 | 10.88 | 157 | 100 QP | VERTICAL |
| 3 | ! | 195.87 | 40.25 | 43.50 | -3.25 | 55.70 | 2.07 | 27.12 | 9.60 | 0 | 100 Peak | VERTICAL |
| 4 | ! | 251.16 | 42.80 | 46.00 | -3.20 | 54.67 | 2.38 | 27.00 | 12.75 | 0 | 100 Peak | VERTICAL |
| 5 | ! | 274.44 | 42.26 | 46.00 | -3.74 | 53.63 | 2.50 | 26.95 | 13.08 | 0 | 100 Peak | VERTICAL |
| 6 | p | 363.68 | 42.89 | 46.00 | -3.11 | 52.09 | 2.85 | 27.35 | 15.30 | 0 | 100 Peak | VERTICAL |

Note:

The amplitude of spurious emissions that are attenuated by more than 20dB below the permissible value has no need to be reported.

Emission level (dBuV/m) = 20 log Emission level (uV/m).

Corrected Reading: Antenna Factor + Cable Loss + Read Level - Preamp Factor = Level.

4.6.9. Results for Radiated Emissions (1GHz~40GHz)

<For Ant. 3>

| | | | |
|----------------------|---------------|-----------------------|--|
| Temperature | 20°C | Humidity | 63% |
| Test Engineer | Serway Li | Configurations | IEEE 802.11n MCS8 20MHz Ch 36 / Ant.3 / Connector 1 + Connector 3 |
| Test Date | Aug. 24, 2011 | | |

Horizontal

| | Freq | Level | Limit | Over | Read | Cable | Preamp | Antenna | T/Pos | A/Pos | Remark | Pol/Phase |
|-----|----------|--------|--------|--------|-------|-------|--------|---------|-------|-------|---------|------------|
| | MHz | dBuV/m | dBuV/m | dB | dBuV | dB | dB | dB/m | deg | cm | | |
| 1 p | 15536.12 | 56.94 | 74.00 | -17.06 | 45.33 | 8.07 | 34.69 | 38.23 | 331 | 100 | Peak | HORIZONTAL |
| 2 a | 15539.88 | 42.62 | 54.00 | -11.38 | 31.01 | 8.07 | 34.69 | 38.23 | 331 | 100 | Average | HORIZONTAL |

Vertical

| | Freq | Level | Limit | Over | Read | Cable | Preamp | Antenna | T/Pos | A/Pos | Remark | Pol/Phase |
|-----|----------|--------|--------|--------|-------|-------|--------|---------|-------|-------|---------|-----------|
| | MHz | dBuV/m | dBuV/m | dB | dBuV | dB | dB | dB/m | deg | cm | | |
| 1 a | 15515.40 | 42.93 | 54.00 | -11.07 | 31.33 | 8.05 | 34.67 | 38.22 | 112 | 100 | Average | VERTICAL |
| 2 p | 15538.12 | 55.50 | 74.00 | -18.50 | 43.89 | 8.07 | 34.69 | 38.23 | 112 | 100 | Peak | VERTICAL |



| | | | |
|----------------------|---------------|-----------------------|--|
| Temperature | 20°C | Humidity | 63% |
| Test Engineer | Serway Li | Configurations | IEEE 802.11n MCS8 20MHz Ch 40 / Ant.3 / Connector 1 + Connector 3 |
| Test Date | Aug. 24, 2011 | | |

Horizontal

| | Freq | Level | Limit | Over | Read | Cable | Preamp | Antenna | T/Pos | A/Pos | Remark | Pol/Phase |
|-----|----------|--------|--------|-------|-------|-------|--------|---------|-------|-------|---------|------------|
| | MHz | dBuV/m | dBuV/m | dB | dBuV | dB | dB | dB/m | deg | cm | | |
| 1 a | 15601.40 | 53.56 | 54.00 | -0.44 | 41.92 | 8.11 | 34.77 | 38.30 | 314 | 111 | Average | HORIZONTAL |
| 2 p | 15609.50 | 71.51 | 74.00 | -2.49 | 59.87 | 8.11 | 34.77 | 38.30 | 314 | 111 | Peak | HORIZONTAL |

Vertical

| | Freq | Level | Limit | Over | Read | Cable | Preamp | Antenna | T/Pos | A/Pos | Remark | Pol/Phase |
|-----|----------|--------|--------|-------|-------|-------|--------|---------|-------|-------|---------|-----------|
| | MHz | dBuV/m | dBuV/m | dB | dBuV | dB | dB | dB/m | deg | cm | | |
| 1 p | 15597.48 | 71.31 | 74.00 | -2.69 | 59.65 | 8.10 | 34.74 | 38.30 | 335 | 132 | Peak | VERTICAL |
| 2 a | 15598.52 | 53.49 | 54.00 | -0.51 | 41.83 | 8.10 | 34.74 | 38.30 | 335 | 132 | Average | VERTICAL |

| | | | |
|----------------------|---------------|-----------------------|--|
| Temperature | 20°C | Humidity | 63% |
| Test Engineer | Serway Li | Configurations | IEEE 802.11n MCS8 20MHz Ch 48 / Ant.3 / Connector 1 + Connector 3 |
| Test Date | Aug. 24, 2011 | | |

Horizontal

| | Freq | Level | Limit | Over | Read | Cable | Preamp | Antenna | T/Pos | A/Pos | Remark | Pol/Phase |
|-----|----------|--------|--------|--------|-------|-------|--------|---------|-------|-------|---------|------------|
| | MHz | dBuV/m | dBuV/m | dB | dBuV | dB | dB | dB/m | deg | cm | | |
| 1 a | 15721.40 | 47.42 | 54.00 | -6.58 | 35.68 | 8.18 | 34.86 | 38.42 | 302 | 100 | Average | HORIZONTAL |
| 2 p | 15722.32 | 63.66 | 74.00 | -10.34 | 51.92 | 8.18 | 34.86 | 38.42 | 302 | 100 | Peak | HORIZONTAL |

Vertical

| | Freq | Level | Limit | Over | Read | Cable | Preamp | Antenna | T/Pos | A/Pos | Remark | Pol/Phase |
|-----|----------|--------|--------|-------|-------|-------|--------|---------|-------|-------|---------|-----------|
| | MHz | dBuV/m | dBuV/m | dB | dBuV | dB | dB | dB/m | deg | cm | | |
| 1 p | 15716.96 | 65.93 | 74.00 | -8.07 | 54.19 | 8.18 | 34.86 | 38.42 | 337 | 102 | Peak | VERTICAL |
| 2 a | 15721.28 | 49.18 | 54.00 | -4.82 | 37.44 | 8.18 | 34.86 | 38.42 | 337 | 102 | Average | VERTICAL |



| | | | |
|----------------------|---------------|-----------------------|--|
| Temperature | 20°C | Humidity | 63% |
| Test Engineer | Serway Li | Configurations | IEEE 802.11n MCS8 20MHz Ch 52 / Ant.3 / Connector 1 + Connector 3 |
| Test Date | Aug. 24, 2011 | | |

Horizontal

| | Freq | Level | Limit | Over | Read | Cable | Preamp | Antenna | T/Pos | A/Pos | Remark | Pol/Phase |
|-----|----------|--------|--------|-------|-------|-------|--------|---------|-------|-------|---------|------------|
| | MHz | dBuV/m | dBuV/m | dB | dBuV | dB | dB | dB/m | deg | cm | | |
| 1 a | 15780.88 | 47.44 | 54.00 | -6.56 | 35.68 | 8.22 | 34.94 | 38.48 | 306 | 116 | Average | HORIZONTAL |
| 2 p | 15786.52 | 64.02 | 74.00 | -9.98 | 52.25 | 8.22 | 34.94 | 38.49 | 306 | 116 | Peak | HORIZONTAL |

Vertical

| | Freq | Level | Limit | Over | Read | Cable | Preamp | Antenna | T/Pos | A/Pos | Remark | Pol/Phase |
|-----|----------|--------|--------|--------|-------|-------|--------|---------|-------|-------|---------|-----------|
| | MHz | dBuV/m | dBuV/m | dB | dBuV | dB | dB | dB/m | deg | cm | | |
| 1 a | 15779.52 | 43.99 | 54.00 | -10.01 | 32.23 | 8.22 | 34.94 | 38.48 | 343 | 100 | Average | VERTICAL |
| 2 p | 15788.92 | 60.62 | 74.00 | -13.38 | 48.85 | 8.22 | 34.94 | 38.49 | 343 | 100 | Peak | VERTICAL |



| | | | |
|----------------------|---------------|-----------------------|--|
| Temperature | 20°C | Humidity | 63% |
| Test Engineer | Serway Li | Configurations | IEEE 802.11n MCS8 20MHz Ch 60 / Ant.3 / Connector 1 + Connector 3 |
| Test Date | Aug. 24, 2011 | | |

Horizontal

| | Freq | Level | Limit | Over | Read | Cable | Preamp | Antenna | T/Pos | A/Pos | Remark | Pol/Phase |
|-----|----------|--------|--------|-------|-------|-------|--------|---------|-------|-------|---------|------------|
| | MHz | dBuV/m | dBuV/m | dB | dBuV | dB | dB | dB/m | deg | cm | | |
| 1 a | 15900.60 | 50.27 | 54.00 | -3.73 | 38.40 | 8.29 | 35.03 | 38.61 | 304 | 115 | Average | HORIZONTAL |
| 2 p | 15901.60 | 67.85 | 74.00 | -6.15 | 55.98 | 8.29 | 35.03 | 38.61 | 304 | 115 | Peak | HORIZONTAL |

Vertical

| | Freq | Level | Limit | Over | Read | Cable | Preamp | Antenna | T/Pos | A/Pos | Remark | Pol/Phase |
|-----|----------|--------|--------|-------|-------|-------|--------|---------|-------|-------|---------|-----------|
| | MHz | dBuV/m | dBuV/m | dB | dBuV | dB | dB | dB/m | deg | cm | | |
| 1 p | 15892.60 | 64.10 | 74.00 | -9.90 | 52.24 | 8.29 | 35.03 | 38.60 | 334 | 125 | Peak | VERTICAL |
| 2 a | 15903.08 | 47.61 | 54.00 | -6.39 | 35.74 | 8.29 | 35.03 | 38.61 | 334 | 125 | Average | VERTICAL |

| | | | |
|----------------------|---------------|-----------------------|--|
| Temperature | 20°C | Humidity | 63% |
| Test Engineer | Serway Li | Configurations | IEEE 802.11n MCS8 20MHz Ch 64 / Ant.3 / Connector 1 + Connector 3 |
| Test Date | Aug. 24, 2011 | | |

Horizontal

| | Freq | Level | Limit | Over | Read | Cable | Preamp | Antenna | T/Pos | A/Pos | Remark | Pol/Phase |
|-----|----------|--------|--------|--------|-------|-------|--------|---------|-------|-------|---------|------------|
| | MHz | dBuV/m | dBuV/m | dB | dBuV | dB | dB | dB/m | deg | cm | | |
| 1 | 10638.00 | 51.53 | 74.00 | -22.47 | 41.38 | 6.66 | 35.05 | 38.54 | 87 | 100 | Peak | HORIZONTAL |
| 2 | 10639.06 | 38.69 | 54.00 | -15.31 | 28.54 | 6.66 | 35.05 | 38.54 | 87 | 100 | Average | HORIZONTAL |
| 3 p | 15958.61 | 56.35 | 74.00 | -17.65 | 44.46 | 8.33 | 35.11 | 38.67 | 257 | 100 | Peak | HORIZONTAL |
| 4 a | 15960.26 | 43.67 | 54.00 | -10.33 | 31.78 | 8.33 | 35.11 | 38.67 | 257 | 100 | Average | HORIZONTAL |

Vertical

| | Freq | Level | Limit | Over | Read | Cable | Preamp | Antenna | T/Pos | A/Pos | Remark | Pol/Phase |
|-----|----------|--------|--------|--------|-------|-------|--------|---------|-------|-------|---------|-----------|
| | MHz | dBuV/m | dBuV/m | dB | dBuV | dB | dB | dB/m | deg | cm | | |
| 1 | 10639.38 | 38.72 | 54.00 | -15.28 | 28.57 | 6.66 | 35.05 | 38.54 | 262 | 100 | Average | VERTICAL |
| 2 | 10640.88 | 51.69 | 74.00 | -22.31 | 41.54 | 6.66 | 35.05 | 38.54 | 262 | 100 | Peak | VERTICAL |
| 3 a | 15960.38 | 43.58 | 54.00 | -10.42 | 31.69 | 8.33 | 35.11 | 38.67 | 146 | 100 | Average | VERTICAL |
| 4 p | 15961.18 | 57.05 | 74.00 | -16.95 | 45.16 | 8.33 | 35.11 | 38.67 | 146 | 100 | Peak | VERTICAL |



| | | | |
|----------------------|---------------|-----------------------|--|
| Temperature | 20°C | Humidity | 63% |
| Test Engineer | Serway Li | Configurations | IEEE 802.11n MCS8 20MHz Ch 100 / Ant.3 / Connector 1 + Connector 3 |
| Test Date | Aug. 24, 2011 | | |

Horizontal

| | Freq | Level | Limit | Over | Read | Cable | Preamp | Antenna | T/Pos | A/Pos | Remark | Pol/Phase |
|-----|----------|--------|--------|--------|-------|-------|--------|---------|-------|-------|---------|------------|
| | MHz | dBuV/m | dBuV/m | dB | dBuV | dB | dB | dB/m | deg | cm | | |
| 1 p | 11000.63 | 50.11 | 74.00 | -23.89 | 39.88 | 6.52 | 34.69 | 38.40 | 258 | 100 | Peak | HORIZONTAL |
| 2 a | 11002.48 | 37.84 | 54.00 | -16.16 | 27.61 | 6.52 | 34.69 | 38.40 | 258 | 100 | Average | HORIZONTAL |

Vertical

| | Freq | Level | Limit | Over | Read | Cable | Preamp | Antenna | T/Pos | A/Pos | Remark | Pol/Phase |
|-----|----------|--------|--------|--------|-------|-------|--------|---------|-------|-------|---------|-----------|
| | MHz | dBuV/m | dBuV/m | dB | dBuV | dB | dB | dB/m | deg | cm | | |
| 1 a | 10999.75 | 39.71 | 54.00 | -14.29 | 29.48 | 6.52 | 34.69 | 38.40 | 142 | 100 | Average | VERTICAL |
| 2 p | 10999.98 | 55.10 | 74.00 | -18.90 | 44.87 | 6.52 | 34.69 | 38.40 | 142 | 100 | Peak | VERTICAL |

| | | | |
|----------------------|---------------|-----------------------|---|
| Temperature | 20°C | Humidity | 63% |
| Test Engineer | Serway Li | Configurations | IEEE 802.11n MCS8 20MHz Ch 116 / Ant.3 / Connector 1 + Connector 3 |
| Test Date | Aug. 24, 2011 | | |

Horizontal

| | Freq | Level | Limit | Over | Read | Cable | Preamp | Antenna | T/Pos | A/Pos | Remark | Pol/Phase |
|-----|----------|--------|--------|--------|-------|-------|--------|---------|-------|-------|---------|------------|
| | MHz | dBuV/m | dBuV/m | dB | dBuV | dB | dB | dB/m | deg | cm | | |
| 1 p | 11160.06 | 62.12 | 74.00 | -11.88 | 51.76 | 6.64 | 34.71 | 38.43 | 237 | 125 | Peak | HORIZONTAL |
| 2 a | 11160.36 | 45.34 | 54.00 | -8.66 | 34.98 | 6.64 | 34.71 | 38.43 | 237 | 125 | Average | HORIZONTAL |

Vertical

| | Freq | Level | Limit | Over | Read | Cable | Preamp | Antenna | T/Pos | A/Pos | Remark | Pol/Phase |
|-----|----------|--------|--------|--------|-------|-------|--------|---------|-------|-------|---------|-----------|
| | MHz | dBuV/m | dBuV/m | dB | dBuV | dB | dB | dB/m | deg | cm | | |
| 1 p | 11158.01 | 61.19 | 74.00 | -12.81 | 50.83 | 6.64 | 34.71 | 38.43 | 311 | 100 | Peak | VERTICAL |
| 2 a | 11158.29 | 48.98 | 54.00 | -5.02 | 38.62 | 6.64 | 34.71 | 38.43 | 311 | 100 | Average | VERTICAL |



| | | | |
|----------------------|---------------|-----------------------|--|
| Temperature | 20°C | Humidity | 63% |
| Test Engineer | Serway Li | Configurations | IEEE 802.11n MCS8 20MHz Ch 140 / Ant.3 / Connector 1 + Connector 3 |
| Test Date | Aug. 24, 2011 | | |

Horizontal

| | Freq | Level | Limit | Over | Read | Cable | Preamp | Antenna | T/Pos | A/Pos | Remark | Pol/Phase |
|-----|----------|--------|--------|--------|-------|-------|--------|---------|-------|-------|---------|------------|
| | MHz | dBuV/m | dBuV/m | dB | dBuV | dB | dB | dB/m | deg | cm | | |
| 1 p | 11403.20 | 49.67 | 74.00 | -24.33 | 39.08 | 6.85 | 34.74 | 38.48 | 146 | 100 | Peak | HORIZONTAL |
| 2 a | 11404.52 | 38.20 | 54.00 | -15.80 | 27.61 | 6.85 | 34.74 | 38.48 | 146 | 100 | Average | HORIZONTAL |

Vertical

| | Freq | Level | Limit | Over | Read | Cable | Preamp | Antenna | T/Pos | A/Pos | Remark | Pol/Phase |
|-----|----------|--------|--------|--------|-------|-------|--------|---------|-------|-------|---------|-----------|
| | MHz | dBuV/m | dBuV/m | dB | dBuV | dB | dB | dB/m | deg | cm | | |
| 1 a | 11401.08 | 38.20 | 54.00 | -15.80 | 27.61 | 6.85 | 34.74 | 38.48 | 302 | 156 | Average | VERTICAL |
| 2 p | 11403.32 | 51.97 | 74.00 | -22.03 | 41.38 | 6.85 | 34.74 | 38.48 | 302 | 156 | Peak | VERTICAL |



| | | | |
|----------------------|---------------|-----------------------|--|
| Temperature | 20°C | Humidity | 63% |
| Test Engineer | Serway Li | Configurations | IEEE 802.11n MCS8 40MHz Ch 38 / Ant.3 / Connector 1 + Connector 3 |
| Test Date | Aug. 24, 2011 | | |

Horizontal

| | Freq | Level | Limit | Over | Read | Cable | Preamp | Antenna | T/Pos | A/Pos | Remark | Pol/Phase |
|-----|----------|--------|--------|--------|-------|-------|--------|---------|-------|-------|---------|------------|
| | MHz | dBuV/m | dBuV/m | dB | dBuV | dB | dB | dB/m | deg | cm | | |
| 1 p | 15569.60 | 54.61 | 74.00 | -19.39 | 42.98 | 8.08 | 34.72 | 38.27 | 240 | 100 | Peak | HORIZONTAL |
| 2 a | 15570.18 | 42.21 | 54.00 | -11.79 | 30.58 | 8.08 | 34.72 | 38.27 | 240 | 100 | Average | HORIZONTAL |

Vertical

| | Freq | Level | Limit | Over | Read | Cable | Preamp | Antenna | T/Pos | A/Pos | Remark | Pol/Phase |
|-----|----------|--------|--------|--------|-------|-------|--------|---------|-------|-------|---------|-----------|
| | MHz | dBuV/m | dBuV/m | dB | dBuV | dB | dB | dB/m | deg | cm | | |
| 1 a | 15569.73 | 42.10 | 54.00 | -11.90 | 30.47 | 8.08 | 34.72 | 38.27 | 274 | 100 | Average | VERTICAL |
| 2 p | 15569.90 | 52.74 | 74.00 | -21.26 | 41.11 | 8.08 | 34.72 | 38.27 | 274 | 100 | Peak | VERTICAL |



| | | | |
|----------------------|---------------|-----------------------|--|
| Temperature | 20°C | Humidity | 63% |
| Test Engineer | Serway Li | Configurations | IEEE 802.11n MCS8 40MHz Ch 46 / Ant.3 / Connector 1 + Connector 3 |
| Test Date | Aug. 24, 2011 | | |

Horizontal

| | Freq | Level | Limit | Over | Read | Cable | Preamp | Antenna | T/Pos | A/Pos | Remark | Pol/Phase |
|-----|----------|--------|--------|--------|-------|-------|--------|---------|-------|-------|---------|------------|
| | MHz | dBuV/m | dBuV/m | dB | dBuV | dB | dB | dB/m | deg | cm | | |
| 1 p | 15689.93 | 52.82 | 74.00 | -21.18 | 41.11 | 8.16 | 34.84 | 38.39 | 203 | 100 | Peak | HORIZONTAL |
| 2 a | 15690.19 | 42.14 | 54.00 | -11.86 | 30.43 | 8.16 | 34.84 | 38.39 | 203 | 100 | Average | HORIZONTAL |

Vertical

| | Freq | Level | Limit | Over | Read | Cable | Preamp | Antenna | T/Pos | A/Pos | Remark | Pol/Phase |
|-----|----------|--------|--------|--------|-------|-------|--------|---------|-------|-------|---------|-----------|
| | MHz | dBuV/m | dBuV/m | dB | dBuV | dB | dB | dB/m | deg | cm | | |
| 1 p | 15690.15 | 53.10 | 74.00 | -20.90 | 41.39 | 8.16 | 34.84 | 38.39 | 162 | 100 | Peak | VERTICAL |
| 2 a | 15690.40 | 42.39 | 54.00 | -11.61 | 30.68 | 8.16 | 34.84 | 38.39 | 162 | 100 | Average | VERTICAL |



| | | | |
|----------------------|---------------|-----------------------|--|
| Temperature | 20°C | Humidity | 63% |
| Test Engineer | Serway Li | Configurations | IEEE 802.11n MCS8 40MHz Ch 54 / Ant.3 / Connector 1 + Connector 3 |
| Test Date | Aug. 24, 2011 | | |

Horizontal

| | Freq | Level | Limit | Over | Read | Cable | Preamp | Antenna | T/Pos | A/Pos | Remark | Pol/Phase |
|-----|----------|--------|--------|--------|-------|-------|--------|---------|-------|-------|---------|------------|
| | MHz | dBuV/m | dBuV/m | dB | dBuV | dB | dB | dB/m | deg | cm | | |
| 1 p | 15809.77 | 54.63 | 74.00 | -19.37 | 42.84 | 8.24 | 34.96 | 38.51 | 198 | 100 | Peak | HORIZONTAL |
| 2 a | 15810.36 | 42.22 | 54.00 | -11.78 | 30.43 | 8.24 | 34.96 | 38.51 | 198 | 100 | Average | HORIZONTAL |

Vertical

| | Freq | Level | Limit | Over | Read | Cable | Preamp | Antenna | T/Pos | A/Pos | Remark | Pol/Phase |
|-----|----------|--------|--------|--------|-------|-------|--------|---------|-------|-------|---------|-----------|
| | MHz | dBuV/m | dBuV/m | dB | dBuV | dB | dB | dB/m | deg | cm | | |
| 1 a | 15809.66 | 42.02 | 54.00 | -11.98 | 30.23 | 8.24 | 34.96 | 38.51 | 149 | 100 | Average | VERTICAL |
| 2 p | 15809.93 | 53.11 | 74.00 | -20.89 | 41.32 | 8.24 | 34.96 | 38.51 | 149 | 100 | Peak | VERTICAL |

| | | | |
|----------------------|---------------|-----------------------|--|
| Temperature | 20°C | Humidity | 63% |
| Test Engineer | Serway Li | Configurations | IEEE 802.11n MCS8 40MHz Ch 62 / Ant.3 / Connector 1 + Connector 3 |
| Test Date | Aug. 24, 2011 | | |

Horizontal

| | Freq | Level | Limit | Over | Read | Cable | Preamp | Antenna | T/Pos | A/Pos | Remark | Pol/Phase |
|-----|----------|--------|--------|--------|-------|-------|--------|---------|-------|-------|---------|------------|
| | MHz | dBuV/m | dBuV/m | dB | dBuV | dB | dB | dB/m | deg | cm | | |
| 1 a | 10619.87 | 38.80 | 54.00 | -15.20 | 28.66 | 6.67 | 35.08 | 38.55 | 45 | 100 | Average | HORIZONTAL |
| 2 p | 10620.32 | 52.11 | 74.00 | -21.89 | 41.97 | 6.67 | 35.08 | 38.55 | 45 | 100 | Peak | HORIZONTAL |

Vertical

| | Freq | Level | Limit | Over | Read | Cable | Preamp | Antenna | T/Pos | A/Pos | Remark | Pol/Phase |
|-----|----------|--------|--------|--------|-------|-------|--------|---------|-------|-------|---------|-----------|
| | MHz | dBuV/m | dBuV/m | dB | dBuV | dB | dB | dB/m | deg | cm | | |
| 1 a | 10619.71 | 38.77 | 54.00 | -15.23 | 28.63 | 6.67 | 35.08 | 38.55 | 178 | 100 | Average | VERTICAL |
| 2 p | 10619.80 | 51.46 | 74.00 | -22.54 | 41.32 | 6.67 | 35.08 | 38.55 | 178 | 100 | Peak | VERTICAL |



| | | | |
|----------------------|---------------|-----------------------|--|
| Temperature | 20°C | Humidity | 63% |
| Test Engineer | Serway Li | Configurations | IEEE 802.11n MCS8 40MHz Ch 102 / Ant.3 / Connector 1 + Connector 3 |
| Test Date | Aug. 24, 2011 | | |

Horizontal

| | Freq | Level | Limit | Over | Read | Cable | Preamp | Antenna | T/Pos | A/Pos | Remark | Pol/Phase |
|-----|----------|--------|--------|--------|-------|-------|--------|---------|-------|-------|---------|------------|
| | MHz | dBuV/m | dBuV/m | dB | dBuV | dB | dB | dB/m | deg | cm | | |
| 1 p | 11019.74 | 50.97 | 74.00 | -23.03 | 40.72 | 6.54 | 34.69 | 38.40 | 253 | 100 | Peak | HORIZONTAL |
| 2 a | 11019.84 | 37.89 | 54.00 | -16.11 | 27.64 | 6.54 | 34.69 | 38.40 | 253 | 100 | Average | HORIZONTAL |

Vertical

| | Freq | Level | Limit | Over | Read | Cable | Preamp | Antenna | T/Pos | A/Pos | Remark | Pol/Phase |
|-----|----------|--------|--------|--------|-------|-------|--------|---------|-------|-------|---------|-----------|
| | MHz | dBuV/m | dBuV/m | dB | dBuV | dB | dB | dB/m | deg | cm | | |
| 1 a | 11020.12 | 38.26 | 54.00 | -15.74 | 28.01 | 6.54 | 34.69 | 38.40 | 150 | 100 | Average | VERTICAL |
| 2 p | 11020.30 | 50.26 | 74.00 | -23.74 | 40.01 | 6.54 | 34.69 | 38.40 | 150 | 100 | Peak | VERTICAL |

| | | | |
|----------------------|---------------|-----------------------|--|
| Temperature | 20°C | Humidity | 63% |
| Test Engineer | Serway Li | Configurations | IEEE 802.11n MCS8 40MHz Ch 110 / Ant.3 / Connector 1 + Connector 3 |
| Test Date | Aug. 24, 2011 | | |

Horizontal

| | Freq | Level | Limit | Over | Read | Cable | Preamp | Antenna | T/Pos | A/Pos | Remark | Pol/Phase |
|-----|----------|--------|--------|--------|-------|-------|--------|---------|-------|-------|---------|------------|
| | MHz | dBuV/m | dBuV/m | dB | dBuV | dB | dB | dB/m | deg | cm | | |
| 1 a | 11099.66 | 40.68 | 54.00 | -13.32 | 30.36 | 6.60 | 34.70 | 38.42 | 234 | 100 | Average | HORIZONTAL |
| 2 p | 11100.05 | 56.16 | 74.00 | -17.84 | 45.84 | 6.60 | 34.70 | 38.42 | 234 | 100 | Peak | HORIZONTAL |

Vertical

| | Freq | Level | Limit | Over | Read | Cable | Preamp | Antenna | T/Pos | A/Pos | Remark | Pol/Phase |
|-----|----------|--------|--------|--------|-------|-------|--------|---------|-------|-------|---------|-----------|
| | MHz | dBuV/m | dBuV/m | dB | dBuV | dB | dB | dB/m | deg | cm | | |
| 1 p | 11099.93 | 63.87 | 74.00 | -10.13 | 53.55 | 6.60 | 34.70 | 38.42 | 311 | 108 | Peak | VERTICAL |
| 2 a | 11099.99 | 45.94 | 54.00 | -8.06 | 35.62 | 6.60 | 34.70 | 38.42 | 311 | 108 | Average | VERTICAL |



| | | | |
|----------------------|---------------|-----------------------|--|
| Temperature | 20°C | Humidity | 63% |
| Test Engineer | Serway Li | Configurations | IEEE 802.11n MCS8 40MHz Ch 134 / Ant.3 / Connector 1 + Connector 3 |
| Test Date | Aug. 24, 2011 | | |

Horizontal

| | Freq | Level | Limit | Over | Read | Cable | Preamp | Antenna | T/Pos | A/Pos | Remark | Pol/Phase |
|-----|----------|--------|--------|--------|-------|-------|--------|---------|-------|-------|---------|------------|
| | MHz | dBuV/m | dBuV/m | dB | dBuV | dB | dB | dB/m | deg | cm | | |
| 1 p | 11339.96 | 59.46 | 74.00 | -14.54 | 48.93 | 6.79 | 34.73 | 38.47 | 260 | 100 | Peak | HORIZONTAL |
| 2 a | 11340.21 | 42.14 | 54.00 | -11.86 | 31.61 | 6.79 | 34.73 | 38.47 | 260 | 100 | Average | HORIZONTAL |

Vertical

| | Freq | Level | Limit | Over | Read | Cable | Preamp | Antenna | T/Pos | A/Pos | Remark | Pol/Phase |
|-----|----------|--------|--------|--------|-------|-------|--------|---------|-------|-------|---------|-----------|
| | MHz | dBuV/m | dBuV/m | dB | dBuV | dB | dB | dB/m | deg | cm | | |
| 1 p | 11343.66 | 59.83 | 74.00 | -14.17 | 49.28 | 6.81 | 34.73 | 38.47 | 25 | 100 | Peak | VERTICAL |
| 2 a | 11343.69 | 46.61 | 54.00 | -7.39 | 36.06 | 6.81 | 34.73 | 38.47 | 25 | 100 | Average | VERTICAL |

| | | | |
|----------------------|---------------|-----------------------|---|
| Temperature | 20°C | Humidity | 63% |
| Test Engineer | Serway Li | Configurations | IEEE 802.11a Ch 36 / Ant.3 / Connector 1 + Connector 3 |
| Test Date | Aug. 24, 2011 | | |

Horizontal

| | Freq | Level | Limit | Over | Read | Cable | Preamp | Antenna | T/Pos | A/Pos | Remark | Pol/Phase |
|-----|----------|--------|--------|--------|-------|-------|--------|---------|-------|-------|---------|------------|
| | MHz | dBuV/m | dBuV/m | dB | dBuV | dB | dB | dB/m | deg | cm | | |
| 1 p | 15539.58 | 56.13 | 74.00 | -17.87 | 44.52 | 8.07 | 34.69 | 38.23 | 309 | 100 | Peak | HORIZONTAL |
| 2 a | 15540.00 | 41.85 | 54.00 | -12.15 | 30.24 | 8.07 | 34.69 | 38.23 | 309 | 100 | Average | HORIZONTAL |

Vertical

| | Freq | Level | Limit | Over | Read | Cable | Preamp | Antenna | T/Pos | A/Pos | Remark | Pol/Phase |
|-----|----------|--------|--------|--------|-------|-------|--------|---------|-------|-------|---------|-----------|
| | MHz | dBuV/m | dBuV/m | dB | dBuV | dB | dB | dB/m | deg | cm | | |
| 1 a | 15539.56 | 43.16 | 54.00 | -10.84 | 31.55 | 8.07 | 34.69 | 38.23 | 188 | 100 | Average | VERTICAL |
| 2 p | 15540.11 | 54.67 | 74.00 | -19.33 | 43.06 | 8.07 | 34.69 | 38.23 | 188 | 100 | Peak | VERTICAL |

| | | | |
|----------------------|---------------|-----------------------|---|
| Temperature | 20°C | Humidity | 63% |
| Test Engineer | Serway Li | Configurations | IEEE 802.11a Ch 40 / Ant.3 / Connector 1 + Connector 3 |
| Test Date | Aug. 24, 2011 | | |

Horizontal

| | Freq | Level | Limit | Over | Read | Cable | Preamp | Antenna | T/Pos | A/Pos | Remark | Pol/Phase |
|-----|----------|--------|--------|-------|-------|-------|--------|---------|-------|-------|---------|------------|
| | MHz | dBuV/m | dBuV/m | dB | dBuV | dB | dB | dB/m | deg | cm | | |
| 1 a | 15606.00 | 49.83 | 54.00 | -4.17 | 38.19 | 8.11 | 34.77 | 38.30 | 297 | 118 | Average | HORIZONTAL |
| 2 p | 15606.90 | 69.26 | 74.00 | -4.74 | 57.62 | 8.11 | 34.77 | 38.30 | 297 | 118 | Peak | HORIZONTAL |

Vertical

| | Freq | Level | Limit | Over | Read | Cable | Preamp | Antenna | T/Pos | A/Pos | Remark | Pol/Phase |
|-----|----------|--------|--------|-------|-------|-------|--------|---------|-------|-------|---------|-----------|
| | MHz | dBuV/m | dBuV/m | dB | dBuV | dB | dB | dB/m | deg | cm | | |
| 1 p | 15601.64 | 68.37 | 74.00 | -5.63 | 56.73 | 8.11 | 34.77 | 38.30 | 349 | 101 | Peak | VERTICAL |
| 2 a | 15602.05 | 51.72 | 54.00 | -2.28 | 40.08 | 8.11 | 34.77 | 38.30 | 349 | 101 | Average | VERTICAL |

| | | | |
|----------------------|---------------|-----------------------|---|
| Temperature | 20°C | Humidity | 63% |
| Test Engineer | Serway Li | Configurations | IEEE 802.11a Ch 48 / Ant.3 / Connector 1 + Connector 3 |
| Test Date | Aug. 24, 2011 | | |

Horizontal

| | Freq | Level | Limit | Over | Read | Cable | Preamp | Antenna | T/Pos | A/Pos | Remark | Pol/Phase |
|-----|----------|--------|--------|-------|-------|-------|--------|---------|-------|-------|---------|------------|
| | MHz | dBuV/m | dBuV/m | dB | dBuV | dB | dB | dB/m | deg | cm | | |
| 1 a | 15720.16 | 50.70 | 54.00 | -3.30 | 38.96 | 8.18 | 34.86 | 38.42 | 308 | 112 | Average | HORIZONTAL |
| 2 p | 15720.47 | 67.98 | 74.00 | -6.02 | 56.24 | 8.18 | 34.86 | 38.42 | 308 | 112 | Peak | HORIZONTAL |

Vertical

| | Freq | Level | Limit | Over | Read | Cable | Preamp | Antenna | T/Pos | A/Pos | Remark | Pol/Phase |
|-----|----------|--------|--------|-------|-------|-------|--------|---------|-------|-------|---------|------------|
| | MHz | dBuV/m | dBuV/m | dB | dBuV | dB | dB | dB/m | deg | cm | | |
| 1 a | 15720.16 | 50.70 | 54.00 | -3.30 | 38.96 | 8.18 | 34.86 | 38.42 | 308 | 112 | Average | HORIZONTAL |
| 2 p | 15720.47 | 67.98 | 74.00 | -6.02 | 56.24 | 8.18 | 34.86 | 38.42 | 308 | 112 | Peak | HORIZONTAL |



| | | | |
|----------------------|---------------|-----------------------|---|
| Temperature | 20°C | Humidity | 63% |
| Test Engineer | Serway Li | Configurations | IEEE 802.11a Ch 52 / Ant.3 / Connector 1 + Connector 3 |
| Test Date | Aug. 24, 2011 | | |

Horizontal

| | Freq | Level | Limit | Over | Read | Cable | Preamp | Antenna | T/Pos | A/Pos | Remark | Pol/Phase |
|-----|----------|--------|--------|--------|-------|-------|--------|---------|-------|-------|---------|------------|
| | MHz | dBuV/m | dBuV/m | dB | dBuV | dB | dB | dB/m | deg | cm | | |
| 1 p | 15779.67 | 61.09 | 74.00 | -12.91 | 49.33 | 8.22 | 34.94 | 38.48 | 3 | 100 | Peak | HORIZONTAL |
| 2 a | 15779.84 | 46.50 | 54.00 | -7.50 | 34.74 | 8.22 | 34.94 | 38.48 | 3 | 100 | Average | HORIZONTAL |

Vertical

| | Freq | Level | Limit | Over | Read | Cable | Preamp | Antenna | T/Pos | A/Pos | Remark | Pol/Phase |
|-----|----------|--------|--------|-------|-------|-------|--------|---------|-------|-------|---------|-----------|
| | MHz | dBuV/m | dBuV/m | dB | dBuV | dB | dB | dB/m | deg | cm | | |
| 1 p | 15778.43 | 64.74 | 74.00 | -9.26 | 52.98 | 8.22 | 34.94 | 38.48 | 301 | 120 | Peak | VERTICAL |
| 2 a | 15778.83 | 49.03 | 54.00 | -4.97 | 37.27 | 8.22 | 34.94 | 38.48 | 301 | 120 | Average | VERTICAL |

| | | | |
|----------------------|---------------|-----------------------|---|
| Temperature | 20°C | Humidity | 63% |
| Test Engineer | Serway Li | Configurations | IEEE 802.11a Ch 60 / Ant.3 / Connector 1 + Connector 3 |
| Test Date | Aug. 24, 2011 | | |

Horizontal

| | Freq | Level | Limit | Over | Read | Cable | Preamp | Antenna | T/Pos | A/Pos | Remark | Pol/Phase |
|-----|----------|--------|--------|--------|-------|-------|--------|---------|-------|-------|---------|------------|
| | MHz | dBuV/m | dBuV/m | dB | dBuV | dB | dB | dB/m | deg | cm | | |
| 1 | 10602.90 | 50.55 | 74.00 | -23.45 | 40.40 | 6.67 | 35.08 | 38.56 | 159 | 100 | Peak | HORIZONTAL |
| 2 | 10602.90 | 38.81 | 54.00 | -15.19 | 28.66 | 6.67 | 35.08 | 38.56 | 159 | 100 | Average | HORIZONTAL |
| 3 p | 15902.26 | 72.40 | 74.00 | -1.60 | 60.53 | 8.29 | 35.03 | 38.61 | 309 | 116 | Peak | HORIZONTAL |
| 4 a | 15902.99 | 51.87 | 54.00 | -2.13 | 40.00 | 8.29 | 35.03 | 38.61 | 309 | 116 | Average | HORIZONTAL |

Vertical

| | Freq | Level | Limit | Over | Read | Cable | Preamp | Antenna | T/Pos | A/Pos | Remark | Pol/Phase |
|-----|----------|--------|--------|--------|-------|-------|--------|---------|-------|-------|---------|-----------|
| | MHz | dBuV/m | dBuV/m | dB | dBuV | dB | dB | dB/m | deg | cm | | |
| 1 | 10602.90 | 49.97 | 74.00 | -24.03 | 39.82 | 6.67 | 35.08 | 38.56 | 297 | 100 | Peak | VERTICAL |
| 2 | 10602.90 | 39.30 | 54.00 | -14.70 | 29.15 | 6.67 | 35.08 | 38.56 | 297 | 100 | Average | VERTICAL |
| 3 p | 15903.12 | 67.14 | 74.00 | -6.86 | 55.27 | 8.29 | 35.03 | 38.61 | 3 | 100 | Peak | VERTICAL |
| 4 a | 15903.76 | 48.10 | 54.00 | -5.90 | 36.23 | 8.29 | 35.03 | 38.61 | 3 | 100 | Average | VERTICAL |

| | | | |
|----------------------|---------------|-----------------------|---|
| Temperature | 20°C | Humidity | 63% |
| Test Engineer | Serway Li | Configurations | IEEE 802.11a Ch 64 / Ant.3 / Connector 1 + Connector 3 |
| Test Date | Aug. 24, 2011 | | |

Horizontal

| | Freq | Level | Limit | Over | Read | Cable | Preamp | Antenna | T/Pos | A/Pos | Remark | Pol/Phase |
|-----|----------|--------|--------|--------|-------|-------|--------|---------|-------|-------|---------|------------|
| | MHz | dBuV/m | dBuV/m | dB | dBuV | dB | dB | dB/m | deg | cm | | |
| 1 | 10639.86 | 38.70 | 54.00 | -15.30 | 28.55 | 6.66 | 35.05 | 38.54 | 289 | 100 | Average | HORIZONTAL |
| 2 | 10639.97 | 51.23 | 74.00 | -22.77 | 41.08 | 6.66 | 35.05 | 38.54 | 289 | 100 | Peak | HORIZONTAL |
| 3 p | 15959.97 | 55.76 | 74.00 | -18.24 | 43.87 | 8.33 | 35.11 | 38.67 | 352 | 109 | Peak | HORIZONTAL |
| 4 a | 15960.20 | 43.72 | 54.00 | -10.28 | 31.83 | 8.33 | 35.11 | 38.67 | 352 | 109 | Average | HORIZONTAL |

Vertical

| | Freq | Level | Limit | Over | Read | Cable | Preamp | Antenna | T/Pos | A/Pos | Remark | Pol/Phase |
|-----|----------|--------|--------|--------|-------|-------|--------|---------|-------|-------|---------|-----------|
| | MHz | dBuV/m | dBuV/m | dB | dBuV | dB | dB | dB/m | deg | cm | | |
| 1 | 10640.10 | 38.58 | 54.00 | -15.42 | 28.43 | 6.66 | 35.05 | 38.54 | 198 | 100 | Average | VERTICAL |
| 2 | 10640.14 | 52.02 | 74.00 | -21.98 | 41.87 | 6.66 | 35.05 | 38.54 | 198 | 100 | Peak | VERTICAL |
| 3 p | 15960.34 | 55.87 | 74.00 | -18.13 | 43.98 | 8.33 | 35.11 | 38.67 | 149 | 100 | Peak | VERTICAL |
| 4 a | 15960.36 | 43.29 | 54.00 | -10.71 | 31.40 | 8.33 | 35.11 | 38.67 | 149 | 100 | Average | VERTICAL |

| | | | |
|----------------------|---------------|-----------------------|--|
| Temperature | 20°C | Humidity | 63% |
| Test Engineer | Serway Li | Configurations | IEEE 802.11a Ch 100 / Ant.3 / Connector 1 + Connector 3 |
| Test Date | Aug. 24, 2011 | | |

Horizontal

| | Freq | Level | Limit | Over | Read | Cable | Preamp | Antenna | T/Pos | A/Pos | Remark | Pol/Phase |
|-----|----------|--------|--------|--------|-------|-------|--------|---------|-------|-------|---------|------------|
| | MHz | dBuV/m | dBuV/m | dB | dBuV | dB | dB | dB/m | deg | cm | | |
| 1 a | 11001.80 | 37.75 | 54.00 | -16.25 | 27.52 | 6.52 | 34.69 | 38.40 | 93 | 100 | Average | HORIZONTAL |
| 2 p | 11007.88 | 50.27 | 74.00 | -23.73 | 40.04 | 6.52 | 34.69 | 38.40 | 94 | 100 | Peak | HORIZONTAL |

Vertical

| | Freq | Level | Limit | Over | Read | Cable | Preamp | Antenna | T/Pos | A/Pos | Remark | Pol/Phase |
|-----|----------|--------|--------|--------|-------|-------|--------|---------|-------|-------|---------|-----------|
| | MHz | dBuV/m | dBuV/m | dB | dBuV | dB | dB | dB/m | deg | cm | | |
| 1 a | 11001.84 | 39.92 | 54.00 | -14.08 | 29.69 | 6.52 | 34.69 | 38.40 | 261 | 128 | Average | VERTICAL |
| 2 p | 11001.96 | 53.50 | 74.00 | -20.50 | 43.27 | 6.52 | 34.69 | 38.40 | 261 | 128 | Peak | VERTICAL |

| | | | |
|----------------------|---------------|-----------------------|--|
| Temperature | 20°C | Humidity | 63% |
| Test Engineer | Serway Li | Configurations | IEEE 802.11a Ch 116 / Ant.3 / Connector 1 + Connector 3 |
| Test Date | Aug. 24, 2011 | | |

Horizontal

| | Freq | Level | Limit | Over | Read | Cable | Preamp | Antenna | T/Pos | A/Pos | Remark | Pol/Phase |
|-----|----------|--------|--------|--------|-------|-------|--------|---------|-------|-------|---------|------------|
| | MHz | dBuV/m | dBuV/m | dB | dBuV | dB | dB | dB/m | deg | cm | | |
| 1 a | 11158.78 | 48.32 | 54.00 | -5.68 | 37.96 | 6.64 | 34.71 | 38.43 | 304 | 116 | Average | HORIZONTAL |
| 2 p | 11158.79 | 61.15 | 74.00 | -12.85 | 50.79 | 6.64 | 34.71 | 38.43 | 304 | 116 | Peak | HORIZONTAL |

Vertical

| | Freq | Level | Limit | Over | Read | Cable | Preamp | Antenna | T/Pos | A/Pos | Remark | Pol/Phase |
|-----|----------|--------|--------|--------|-------|-------|--------|---------|-------|-------|---------|-----------|
| | MHz | dBuV/m | dBuV/m | dB | dBuV | dB | dB | dB/m | deg | cm | | |
| 1 p | 11158.75 | 63.64 | 74.00 | -10.36 | 53.28 | 6.64 | 34.71 | 38.43 | 30 | 100 | Peak | VERTICAL |
| 2 a | 11158.75 | 49.77 | 54.00 | -4.23 | 39.41 | 6.64 | 34.71 | 38.43 | 30 | 100 | Average | VERTICAL |

| | | | |
|----------------------|---------------|-----------------------|--|
| Temperature | 20°C | Humidity | 63% |
| Test Engineer | Serway Li | Configurations | IEEE 802.11a Ch 140 / Ant.3 / Connector 1 + Connector 3 |
| Test Date | Aug. 24, 2011 | | |

Horizontal

| | Freq | Level | Limit | Over | Read | Cable | Preamp | Antenna | T/Pos | A/Pos | Remark | Pol/Phase |
|-----|----------|--------|--------|--------|-------|-------|--------|---------|-------|-------|---------|------------|
| | MHz | dBuV/m | dBuV/m | dB | dBuV | dB | dB | dB/m | deg | cm | | |
| 1 a | 11398.28 | 40.31 | 54.00 | -13.69 | 29.72 | 6.85 | 34.74 | 38.48 | 302 | 124 | Average | HORIZONTAL |
| 2 p | 11398.40 | 54.47 | 74.00 | -19.53 | 43.88 | 6.85 | 34.74 | 38.48 | 302 | 124 | Peak | HORIZONTAL |

Vertical

| | Freq | Level | Limit | Over | Read | Cable | Preamp | Antenna | T/Pos | A/Pos | Remark | Pol/Phase |
|-----|----------|--------|--------|--------|-------|-------|--------|---------|-------|-------|---------|-----------|
| | MHz | dBuV/m | dBuV/m | dB | dBuV | dB | dB | dB/m | deg | cm | | |
| 1 a | 11398.48 | 40.68 | 54.00 | -13.32 | 30.09 | 6.85 | 34.74 | 38.48 | 144 | 136 | Average | VERTICAL |
| 2 p | 11402.60 | 53.46 | 74.00 | -20.54 | 42.87 | 6.85 | 34.74 | 38.48 | 144 | 136 | Peak | VERTICAL |

<For Ant. 4>

| | | | |
|----------------------|---------------|-----------------------|--|
| Temperature | 20°C | Humidity | 63% |
| Test Engineer | Serway Li | Configurations | IEEE 802.11n MCS8 20MHz Ch 52 / Ant.4 / Connector 1 + Connector 3 |
| Test Date | Aug. 24, 2011 | | |

Horizontal

| | Freq | Level | Limit | Over | Read | Cable | Preamp | Antenna | T/Pos | A/Pos | Remark | Pol/Phase |
|-----|----------|--------|--------|--------|-------|-------|--------|---------|-------|-------|---------|------------|
| | MHz | dBuV/m | dBuV/m | dB | dBuV | dB | dB | dB/m | deg | cm | | |
| 1 p | 15777.72 | 54.88 | 74.00 | -19.12 | 43.12 | 8.22 | 34.94 | 38.48 | 139 | 100 | Peak | HORIZONTAL |
| 2 a | 15783.02 | 42.33 | 54.00 | -11.67 | 30.56 | 8.22 | 34.94 | 38.49 | 139 | 100 | Average | HORIZONTAL |

Vertical

| | Freq | Level | Limit | Over | Read | Cable | Preamp | Antenna | T/Pos | A/Pos | Remark | Pol/Phase |
|-----|----------|--------|--------|--------|-------|-------|--------|---------|-------|-------|---------|-----------|
| | MHz | dBuV/m | dBuV/m | dB | dBuV | dB | dB | dB/m | deg | cm | | |
| 1 p | 15775.98 | 54.65 | 74.00 | -19.35 | 42.87 | 8.21 | 34.91 | 38.48 | 261 | 100 | Peak | VERTICAL |
| 2 a | 15784.56 | 42.23 | 54.00 | -11.77 | 30.46 | 8.22 | 34.94 | 38.49 | 261 | 100 | Average | VERTICAL |

| | | | |
|----------------------|---------------|-----------------------|--|
| Temperature | 20°C | Humidity | 63% |
| Test Engineer | Serway Li | Configurations | IEEE 802.11n MCS8 20MHz Ch 60 / Ant.4 / Connector 1 + Connector 3 |
| Test Date | Aug. 24, 2011 | | |

Horizontal

| | Freq | Level | Limit | Over | Read | Cable | Preamp | Antenna | T/Pos | A/Pos | Remark | Pol/Phase |
|-----|----------|--------|--------|--------|-------|-------|--------|---------|-------|-------|---------|------------|
| | MHz | dBuV/m | dBuV/m | dB | dBuV | dB | dB | dB/m | deg | cm | | |
| 1 p | 15896.98 | 55.96 | 74.00 | -18.04 | 44.10 | 8.29 | 35.03 | 38.60 | 247 | 100 | Peak | HORIZONTAL |
| 2 a | 15899.00 | 42.67 | 54.00 | -11.33 | 30.81 | 8.29 | 35.03 | 38.60 | 247 | 100 | Average | HORIZONTAL |

Vertical

| | Freq | Level | Limit | Over | Read | Cable | Preamp | Antenna | T/Pos | A/Pos | Remark | Pol/Phase |
|-----|----------|--------|--------|--------|-------|-------|--------|---------|-------|-------|---------|-----------|
| | MHz | dBuV/m | dBuV/m | dB | dBuV | dB | dB | dB/m | deg | cm | | |
| 1 p | 15895.82 | 55.05 | 74.00 | -18.95 | 43.19 | 8.29 | 35.03 | 38.60 | 132 | 100 | Peak | VERTICAL |
| 2 a | 15900.32 | 42.61 | 54.00 | -11.39 | 30.75 | 8.29 | 35.03 | 38.60 | 132 | 100 | Average | VERTICAL |

| | | | |
|----------------------|---------------|-----------------------|--|
| Temperature | 20°C | Humidity | 63% |
| Test Engineer | Serway Li | Configurations | IEEE 802.11n MCS8 20MHz Ch 64 / Ant.4 / Connector 1 + Connector 3 |
| Test Date | Aug. 24, 2011 | | |

Horizontal

| | Freq | Level | Limit | Over | Read | Cable | Preamp | Antenna | T/Pos | A/Pos | Remark | Pol/Phase |
|-----|----------|--------|--------|--------|-------|-------|--------|---------|-------|-------|---------|------------|
| | MHz | dBuV/m | dBuV/m | dB | dBuV | dB | dB | dB/m | deg | cm | | |
| 1 a | 15960.74 | 43.63 | 54.00 | -10.37 | 31.74 | 8.33 | 35.11 | 38.67 | 279 | 100 | Average | HORIZONTAL |
| 2 p | 15962.80 | 56.63 | 74.00 | -17.37 | 44.74 | 8.33 | 35.11 | 38.67 | 279 | 100 | Peak | HORIZONTAL |

Vertical

| | Freq | Level | Limit | Over | Read | Cable | Preamp | Antenna | T/Pos | A/Pos | Remark | Pol/Phase |
|-----|----------|--------|--------|--------|-------|-------|--------|---------|-------|-------|---------|-----------|
| | MHz | dBuV/m | dBuV/m | dB | dBuV | dB | dB | dB/m | deg | cm | | |
| 1 a | 15962.36 | 43.56 | 54.00 | -10.44 | 31.67 | 8.33 | 35.11 | 38.67 | 90 | 100 | Average | VERTICAL |
| 2 p | 15964.86 | 56.47 | 74.00 | -17.53 | 44.58 | 8.33 | 35.11 | 38.67 | 90 | 100 | Peak | VERTICAL |



| | | | |
|----------------------|---------------|-----------------------|--|
| Temperature | 20°C | Humidity | 63% |
| Test Engineer | Serway Li | Configurations | IEEE 802.11n MCS8 20MHz Ch 100 / Ant.4 / Connector 1 + Connector 3 |
| Test Date | Aug. 24, 2011 | | |

Horizontal

| | Freq | Level | Limit | Over | Read | Cable | Preamp | Antenna | T/Pos | A/Pos | Remark | Pol/Phase |
|-----|----------|--------|--------|--------|-------|-------|--------|---------|-------|-------|---------|------------|
| | MHz | dBuV/m | dBuV/m | dB | dBuV | dB | dB | dB/m | deg | cm | | |
| 1 p | 11001.50 | 49.79 | 74.00 | -24.21 | 39.56 | 6.52 | 34.69 | 38.40 | 101 | 100 | Peak | HORIZONTAL |
| 2 a | 11003.20 | 37.17 | 54.00 | -16.83 | 26.94 | 6.52 | 34.69 | 38.40 | 101 | 100 | Average | HORIZONTAL |

Vertical

| | Freq | Level | Limit | Over | Read | Cable | Preamp | Antenna | T/Pos | A/Pos | Remark | Pol/Phase |
|-----|----------|--------|--------|--------|-------|-------|--------|---------|-------|-------|---------|-----------|
| | MHz | dBuV/m | dBuV/m | dB | dBuV | dB | dB | dB/m | deg | cm | | |
| 1 p | 10997.32 | 49.25 | 74.00 | -24.75 | 39.02 | 6.52 | 34.69 | 38.40 | 287 | 100 | Peak | VERTICAL |
| 2 a | 11003.26 | 37.17 | 54.00 | -16.83 | 26.94 | 6.52 | 34.69 | 38.40 | 287 | 100 | Average | VERTICAL |

| | | | |
|----------------------|---------------|-----------------------|--|
| Temperature | 20°C | Humidity | 63% |
| Test Engineer | Serway Li | Configurations | IEEE 802.11n MCS8 20MHz Ch 116 / Ant.4 / Connector 1 + Connector 3 |
| Test Date | Aug. 24, 2011 | | |

Horizontal

| | Freq | Level | Limit | Over | Read | Cable | Preamp | Antenna | T/Pos | A/Pos | Remark | Pol/Phase |
|-----|----------|--------|--------|--------|-------|-------|--------|---------|-------|-------|---------|------------|
| | MHz | dBuV/m | dBuV/m | dB | dBuV | dB | dB | dB/m | deg | cm | | |
| 1 a | 11155.46 | 39.51 | 54.00 | -14.49 | 29.15 | 6.64 | 34.71 | 38.43 | 262 | 100 | Average | HORIZONTAL |
| 2 p | 11160.16 | 49.74 | 74.00 | -24.26 | 39.38 | 6.64 | 34.71 | 38.43 | 262 | 100 | Peak | HORIZONTAL |

Vertical

| | Freq | Level | Limit | Over | Read | Cable | Preamp | Antenna | T/Pos | A/Pos | Remark | Pol/Phase |
|-----|----------|--------|--------|--------|-------|-------|--------|---------|-------|-------|---------|-----------|
| | MHz | dBuV/m | dBuV/m | dB | dBuV | dB | dB | dB/m | deg | cm | | |
| 1 a | 11155.82 | 40.15 | 54.00 | -13.85 | 29.79 | 6.64 | 34.71 | 38.43 | 112 | 100 | Average | VERTICAL |
| 2 p | 11161.78 | 53.43 | 74.00 | -20.57 | 43.05 | 6.66 | 34.71 | 38.43 | 112 | 100 | Peak | VERTICAL |

| | | | |
|----------------------|---------------|-----------------------|--|
| Temperature | 20°C | Humidity | 63% |
| Test Engineer | Serway Li | Configurations | IEEE 802.11n MCS8 20MHz Ch 140 / Ant.4 / Connector 1 + Connector 3 |
| Test Date | Aug. 24, 2011 | | |

Horizontal

| | Freq | Level | Limit | Over | Read | Cable | Preamp | Antenna | T/Pos | A/Pos | Remark | Pol/Phase |
|-----|----------|--------|--------|--------|-------|-------|--------|---------|-------|-------|---------|------------|
| | MHz | dBuV/m | dBuV/m | dB | dBuV | dB | dB | dB/m | deg | cm | | |
| 1 a | 11395.06 | 38.22 | 54.00 | -15.78 | 27.63 | 6.85 | 34.74 | 38.48 | 121 | 100 | Average | HORIZONTAL |
| 2 p | 11398.20 | 50.70 | 74.00 | -23.30 | 40.11 | 6.85 | 34.74 | 38.48 | 121 | 100 | Peak | HORIZONTAL |

Vertical

| | Freq | Level | Limit | Over | Read | Cable | Preamp | Antenna | T/Pos | A/Pos | Remark | Pol/Phase |
|-----|----------|--------|--------|--------|-------|-------|--------|---------|-------|-------|---------|-----------|
| | MHz | dBuV/m | dBuV/m | dB | dBuV | dB | dB | dB/m | deg | cm | | |
| 1 p | 11402.84 | 51.17 | 74.00 | -22.83 | 40.58 | 6.85 | 34.74 | 38.48 | 237 | 100 | Peak | VERTICAL |
| 2 a | 11403.26 | 38.17 | 54.00 | -15.83 | 27.58 | 6.85 | 34.74 | 38.48 | 237 | 100 | Average | VERTICAL |



| | | | |
|----------------------|---------------|-----------------------|--|
| Temperature | 20°C | Humidity | 63% |
| Test Engineer | Serway Li | Configurations | IEEE 802.11n MCS8 40MHz Ch 54 / Ant.4 / Connector 1 + Connector 3 |
| Test Date | Aug. 24, 2011 | | |

Horizontal

| | Freq | Level | Limit | Over | Read | Cable | Preamp | Antenna | T/Pos | A/Pos | Remark | Pol/Phase |
|-----|----------|--------|--------|--------|-------|-------|--------|---------|-------|-------|---------|------------|
| | MHz | dBuV/m | dBuV/m | dB | dBuV | dB | dB | dB/m | deg | cm | | |
| 1 p | 15790.50 | 54.10 | 74.00 | -19.90 | 42.33 | 8.22 | 34.94 | 38.49 | 302 | 100 | Peak | HORIZONTAL |
| 2 a | 15819.80 | 42.52 | 54.00 | -11.48 | 30.71 | 8.24 | 34.96 | 38.53 | 302 | 100 | Average | HORIZONTAL |

Vertical

| | Freq | Level | Limit | Over | Read | Cable | Preamp | Antenna | T/Pos | A/Pos | Remark | Pol/Phase |
|-----|----------|--------|--------|--------|-------|-------|--------|---------|-------|-------|---------|-----------|
| | MHz | dBuV/m | dBuV/m | dB | dBuV | dB | dB | dB/m | deg | cm | | |
| 1 p | 15806.00 | 55.07 | 74.00 | -18.93 | 43.28 | 8.24 | 34.96 | 38.51 | 126 | 100 | Peak | VERTICAL |
| 2 a | 15809.00 | 42.40 | 54.00 | -11.60 | 30.61 | 8.24 | 34.96 | 38.51 | 126 | 100 | Average | VERTICAL |

| | | | |
|----------------------|---------------|-----------------------|--|
| Temperature | 20°C | Humidity | 63% |
| Test Engineer | Serway Li | Configurations | IEEE 802.11n MCS8 40MHz Ch 62 / Ant.4 / Connector 1 + Connector 3 |
| Test Date | Aug. 24, 2011 | | |

Horizontal

| | Freq | Level | Limit | Over | Read | Cable | Preamp | Antenna | T/Pos | A/Pos | Remark | Pol/Phase |
|-----|----------|--------|--------|--------|-------|-------|--------|---------|-------|-------|---------|------------|
| | MHz | dBuV/m | dBuV/m | dB | dBuV | dB | dB | dB/m | deg | cm | | |
| 1 | 10607.00 | 38.67 | 54.00 | -15.33 | 28.52 | 6.67 | 35.08 | 38.56 | 110 | 100 | Average | HORIZONTAL |
| 2 | 10631.00 | 50.87 | 74.00 | -23.13 | 40.72 | 6.66 | 35.05 | 38.54 | 110 | 100 | Peak | HORIZONTAL |
| 3 p | 15949.70 | 55.36 | 74.00 | -18.64 | 43.47 | 8.32 | 35.08 | 38.65 | 50 | 100 | Peak | HORIZONTAL |
| 4 a | 15951.40 | 43.37 | 54.00 | -10.63 | 31.48 | 8.32 | 35.08 | 38.65 | 50 | 100 | Average | HORIZONTAL |

Vertical

| | Freq | Level | Limit | Over | Read | Cable | Preamp | Antenna | T/Pos | A/Pos | Remark | Pol/Phase |
|-----|----------|--------|--------|--------|-------|-------|--------|---------|-------|-------|---------|-----------|
| | MHz | dBuV/m | dBuV/m | dB | dBuV | dB | dB | dB/m | deg | cm | | |
| 1 | 10615.20 | 38.73 | 54.00 | -15.27 | 28.59 | 6.67 | 35.08 | 38.55 | 265 | 100 | Average | VERTICAL |
| 2 | 10699.20 | 51.80 | 74.00 | -22.20 | 41.64 | 6.64 | 35.00 | 38.52 | 265 | 100 | Peak | VERTICAL |
| 3 a | 15951.40 | 43.52 | 54.00 | -10.48 | 31.63 | 8.32 | 35.08 | 38.65 | 296 | 100 | Average | VERTICAL |
| 4 p | 15952.30 | 55.05 | 74.00 | -18.95 | 43.14 | 8.32 | 35.08 | 38.67 | 296 | 100 | Peak | VERTICAL |



| | | | |
|----------------------|---------------|-----------------------|--|
| Temperature | 20°C | Humidity | 63% |
| Test Engineer | Serway Li | Configurations | IEEE 802.11n MCS8 40MHz Ch 102 / Ant.4 / Connector 1 + Connector 3 |
| Test Date | Aug. 24, 2011 | | |

Horizontal

| | Freq | Level | Limit | Over | Read | Cable | Preamp | Antenna | T/Pos | A/Pos | Remark | Pol/Phase |
|-----|----------|--------|--------|--------|-------|-------|--------|---------|-------|-------|---------|------------|
| | MHz | dBuV/m | dBuV/m | dB | dBuV | dB | dB | dB/m | deg | cm | | |
| 1 p | 11033.40 | 50.62 | 74.00 | -23.38 | 40.36 | 6.54 | 34.69 | 38.41 | 290 | 100 | Peak | HORIZONTAL |
| 2 a | 11037.50 | 38.66 | 54.00 | -15.34 | 28.39 | 6.56 | 34.70 | 38.41 | 290 | 100 | Average | HORIZONTAL |

Vertical

| | Freq | Level | Limit | Over | Read | Cable | Preamp | Antenna | T/Pos | A/Pos | Remark | Pol/Phase |
|-----|----------|--------|--------|--------|-------|-------|--------|---------|-------|-------|---------|-----------|
| | MHz | dBuV/m | dBuV/m | dB | dBuV | dB | dB | dB/m | deg | cm | | |
| 1 a | 11020.80 | 38.61 | 54.00 | -15.39 | 28.36 | 6.54 | 34.69 | 38.40 | 79 | 100 | Average | VERTICAL |
| 2 p | 11043.80 | 50.86 | 74.00 | -23.14 | 40.59 | 6.56 | 34.70 | 38.41 | 79 | 100 | Peak | VERTICAL |

| | | | |
|----------------------|---------------|-----------------------|---|
| Temperature | 20°C | Humidity | 63% |
| Test Engineer | Serway Li | Configurations | IEEE 802.11n MCS8 40MHz Ch 110 / Ant.4 / Connector 1 + Connector 3 |
| Test Date | Aug. 24, 2011 | | |

Horizontal

| | Freq | Level | Limit | Over | Read | Cable | Preamp | Antenna | T/Pos | A/Pos | Remark | Pol/Phase |
|-----|----------|--------|--------|--------|-------|-------|--------|---------|-------|-------|---------|------------|
| | MHz | dBuV/m | dBuV/m | dB | dBuV | dB | dB | dB/m | deg | cm | | |
| 1 a | 11115.70 | 39.44 | 54.00 | -14.56 | 29.10 | 6.62 | 34.70 | 38.42 | 67 | 100 | Average | HORIZONTAL |
| 2 p | 11124.60 | 52.42 | 74.00 | -21.58 | 42.07 | 6.62 | 34.70 | 38.43 | 67 | 100 | Peak | HORIZONTAL |

Vertical

| | Freq | Level | Limit | Over | Read | Cable | Preamp | Antenna | T/Pos | A/Pos | Remark | Pol/Phase |
|-----|----------|--------|--------|--------|-------|-------|--------|---------|-------|-------|---------|-----------|
| | MHz | dBuV/m | dBuV/m | dB | dBuV | dB | dB | dB/m | deg | cm | | |
| 1 a | 11119.10 | 39.49 | 54.00 | -14.51 | 29.15 | 6.62 | 34.70 | 38.42 | 306 | 100 | Average | VERTICAL |
| 2 p | 11124.50 | 51.52 | 74.00 | -22.48 | 41.17 | 6.62 | 34.70 | 38.43 | 306 | 100 | Peak | VERTICAL |



| | | | |
|----------------------|---------------|-----------------------|--|
| Temperature | 20°C | Humidity | 63% |
| Test Engineer | Serway Li | Configurations | IEEE 802.11n MCS8 40MHz Ch 134 / Ant.4 / Connector 1 + Connector 3 |
| Test Date | Aug. 24, 2011 | | |

Horizontal

| | Freq | Level | Limit | Over | Read | Cable | Preamp | Antenna | T/Pos | A/Pos | Remark | Pol/Phase |
|-----|----------|--------|--------|--------|-------|-------|--------|---------|-------|-------|---------|------------|
| | MHz | dBuV/m | dBuV/m | dB | dBuV | dB | dB | dB/m | deg | cm | | |
| 1 p | 11347.90 | 50.76 | 74.00 | -23.24 | 40.21 | 6.81 | 34.73 | 38.47 | 280 | 100 | Peak | HORIZONTAL |
| 2 a | 11349.70 | 38.68 | 54.00 | -15.32 | 28.13 | 6.81 | 34.73 | 38.47 | 280 | 100 | Average | HORIZONTAL |

Vertical

| | Freq | Level | Limit | Over | Read | Cable | Preamp | Antenna | T/Pos | A/Pos | Remark | Pol/Phase |
|-----|----------|--------|--------|--------|-------|-------|--------|---------|-------|-------|---------|-----------|
| | MHz | dBuV/m | dBuV/m | dB | dBuV | dB | dB | dB/m | deg | cm | | |
| 1 a | 11331.10 | 38.55 | 54.00 | -15.45 | 28.02 | 6.79 | 34.73 | 38.47 | 100 | 100 | Average | VERTICAL |
| 2 p | 11360.30 | 50.75 | 74.00 | -23.25 | 40.20 | 6.81 | 34.73 | 38.47 | 100 | 100 | Peak | VERTICAL |



| | | | |
|----------------------|---------------|-----------------------|---|
| Temperature | 20°C | Humidity | 63% |
| Test Engineer | Serway Li | Configurations | IEEE 802.11a Ch 52 / Ant.4 / Connector 1 + Connector 3 |
| Test Date | Aug. 24, 2011 | | |

Horizontal

| | Freq | Level | Limit | Over | Read | Cable | Preamp | Antenna | T/Pos | A/Pos | Remark | Pol/Phase |
|-----|----------|--------|--------|--------|-------|-------|--------|---------|-------|-------|---------|------------|
| | MHz | dBuV/m | dBuV/m | dB | dBuV | dB | dB | dB/m | deg | cm | | |
| 1 a | 15779.20 | 42.34 | 54.00 | -11.66 | 30.58 | 8.22 | 34.94 | 38.48 | 290 | 100 | Average | HORIZONTAL |
| 2 p | 15781.68 | 63.38 | 74.00 | -10.62 | 51.61 | 8.22 | 34.94 | 38.49 | 290 | 100 | Peak | HORIZONTAL |

Vertical

| | Freq | Level | Limit | Over | Read | Cable | Preamp | Antenna | T/Pos | A/Pos | Remark | Pol/Phase |
|-----|----------|--------|--------|--------|-------|-------|--------|---------|-------|-------|---------|-----------|
| | MHz | dBuV/m | dBuV/m | dB | dBuV | dB | dB | dB/m | deg | cm | | |
| 1 a | 15779.72 | 42.11 | 54.00 | -11.89 | 30.35 | 8.22 | 34.94 | 38.48 | 164 | 100 | Average | VERTICAL |
| 2 p | 15787.32 | 54.51 | 74.00 | -19.49 | 42.74 | 8.22 | 34.94 | 38.49 | 164 | 100 | Peak | VERTICAL |

| | | | |
|----------------------|---------------|-----------------------|---|
| Temperature | 20°C | Humidity | 63% |
| Test Engineer | Serway Li | Configurations | IEEE 802.11a Ch 60 / Ant.4 / Connector 1 + Connector 3 |
| Test Date | Aug. 24, 2011 | | |

Horizontal

| | Freq | Level | Limit | Over | Read | Cable | Preamp | Antenna | T/Pos | A/Pos | Remark | Pol/Phase |
|-----|----------|--------|--------|--------|-------|-------|--------|---------|-------|-------|---------|------------|
| | MHz | dBuV/m | dBuV/m | dB | dBuV | dB | dB | dB/m | deg | cm | | |
| 1 a | 15890.16 | 42.83 | 54.00 | -11.17 | 30.97 | 8.29 | 35.03 | 38.60 | 258 | 100 | Average | HORIZONTAL |
| 2 p | 15895.72 | 54.95 | 74.00 | -19.05 | 43.09 | 8.29 | 35.03 | 38.60 | 258 | 100 | Peak | HORIZONTAL |

Vertical

| | Freq | Level | Limit | Over | Read | Cable | Preamp | Antenna | T/Pos | A/Pos | Remark | Pol/Phase |
|-----|----------|--------|--------|--------|-------|-------|--------|---------|-------|-------|---------|-----------|
| | MHz | dBuV/m | dBuV/m | dB | dBuV | dB | dB | dB/m | deg | cm | | |
| 1 a | 15895.96 | 42.75 | 54.00 | -11.25 | 30.89 | 8.29 | 35.03 | 38.60 | 105 | 100 | Average | VERTICAL |
| 2 p | 15904.20 | 55.96 | 74.00 | -18.04 | 44.09 | 8.29 | 35.03 | 38.61 | 105 | 100 | Peak | VERTICAL |

| | | | |
|----------------------|---------------|-----------------------|---|
| Temperature | 20°C | Humidity | 63% |
| Test Engineer | Serway Li | Configurations | IEEE 802.11a Ch 64 / Ant.4 / Connector 1 + Connector 3 |
| Test Date | Aug. 24, 2011 | | |

Horizontal

| | Freq | Level | Limit | Over | Read | Cable | Preamp | Antenna | T/Pos | A/Pos | Remark | Pol/Phase |
|-----|----------|--------|--------|--------|-------|-------|--------|---------|-------|-------|---------|------------|
| | MHz | dBuV/m | dBuV/m | dB | dBuV | dB | dB | dB/m | deg | cm | | |
| 1 a | 15961.00 | 43.36 | 54.00 | -10.64 | 31.47 | 8.33 | 35.11 | 38.67 | 260 | 100 | Average | HORIZONTAL |
| 2 p | 15963.84 | 56.01 | 74.00 | -17.99 | 44.12 | 8.33 | 35.11 | 38.67 | 260 | 100 | Peak | HORIZONTAL |

Vertical

| | Freq | Level | Limit | Over | Read | Cable | Preamp | Antenna | T/Pos | A/Pos | Remark | Pol/Phase |
|-----|----------|--------|--------|--------|-------|-------|--------|---------|-------|-------|---------|-----------|
| | MHz | dBuV/m | dBuV/m | dB | dBuV | dB | dB | dB/m | deg | cm | | |
| 1 p | 15957.42 | 55.67 | 74.00 | -18.33 | 43.78 | 8.33 | 35.11 | 38.67 | 94 | 100 | Peak | VERTICAL |
| 2 a | 15959.82 | 43.69 | 54.00 | -10.31 | 31.80 | 8.33 | 35.11 | 38.67 | 94 | 100 | Average | VERTICAL |



| | | | |
|----------------------|---------------|-----------------------|--|
| Temperature | 20°C | Humidity | 63% |
| Test Engineer | Serway Li | Configurations | IEEE 802.11a Ch 100 / Ant.4 / Connector 1 + Connector 3 |
| Test Date | Aug. 24, 2011 | | |

Horizontal

| | Freq | Level | Limit | Over | Read | Cable | Preamp | Antenna | T/Pos | A/Pos | Remark | Pol/Phase |
|-----|----------|--------|--------|--------|-------|-------|--------|---------|-------|-------|---------|------------|
| | MHz | dBuV/m | dBuV/m | dB | dBuV | dB | dB | dB/m | deg | cm | | |
| 1 p | 10999.50 | 50.00 | 74.00 | -24.00 | 39.77 | 6.52 | 34.69 | 38.40 | 220 | 100 | Peak | HORIZONTAL |
| 2 a | 11000.64 | 37.35 | 54.00 | -16.65 | 27.12 | 6.52 | 34.69 | 38.40 | 220 | 100 | Average | HORIZONTAL |

Vertical

| | Freq | Level | Limit | Over | Read | Cable | Preamp | Antenna | T/Pos | A/Pos | Remark | Pol/Phase |
|-----|----------|--------|--------|--------|-------|-------|--------|---------|-------|-------|---------|-----------|
| | MHz | dBuV/m | dBuV/m | dB | dBuV | dB | dB | dB/m | deg | cm | | |
| 1 p | 11002.18 | 49.73 | 74.00 | -24.27 | 39.50 | 6.52 | 34.69 | 38.40 | 120 | 100 | Peak | VERTICAL |
| 2 a | 11003.58 | 37.50 | 54.00 | -16.50 | 27.27 | 6.52 | 34.69 | 38.40 | 120 | 100 | Average | VERTICAL |

| | | | |
|----------------------|---------------|-----------------------|--|
| Temperature | 20°C | Humidity | 63% |
| Test Engineer | Serway Li | Configurations | IEEE 802.11a Ch 116 / Ant.4 / Connector 1 + Connector 3 |
| Test Date | Aug. 24, 2011 | | |

Horizontal

| | Freq | Level | Limit | Over | Read | Cable | Preamp | Antenna | T/Pos | A/Pos | Remark | Pol/Phase |
|-----|----------|--------|--------|--------|-------|-------|--------|---------|-------|-------|---------|------------|
| | MHz | dBuV/m | dBuV/m | dB | dBuV | dB | dB | dB/m | deg | cm | | |
| 1 a | 11156.12 | 39.45 | 54.00 | -14.55 | 29.09 | 6.64 | 34.71 | 38.43 | 166 | 100 | Average | HORIZONTAL |
| 2 p | 11157.30 | 52.49 | 74.00 | -21.51 | 42.13 | 6.64 | 34.71 | 38.43 | 166 | 100 | Peak | HORIZONTAL |

Vertical

| | Freq | Level | Limit | Over | Read | Cable | Preamp | Antenna | T/Pos | A/Pos | Remark | Pol/Phase |
|-----|----------|--------|--------|--------|-------|-------|--------|---------|-------|-------|---------|-----------|
| | MHz | dBuV/m | dBuV/m | dB | dBuV | dB | dB | dB/m | deg | cm | | |
| 1 a | 11156.56 | 39.84 | 54.00 | -14.16 | 29.48 | 6.64 | 34.71 | 38.43 | 211 | 100 | Average | VERTICAL |
| 2 p | 11159.16 | 52.32 | 74.00 | -21.68 | 41.96 | 6.64 | 34.71 | 38.43 | 211 | 100 | Peak | VERTICAL |

| | | | |
|----------------------|---------------|-----------------------|--|
| Temperature | 20°C | Humidity | 63% |
| Test Engineer | Serway Li | Configurations | IEEE 802.11a Ch 140 / Ant.4 / Connector 1 + Connector 3 |
| Test Date | Aug. 24, 2011 | | |

Horizontal

| | Freq | Level | Limit | Over | Read | Cable | Preamp | Antenna | T/Pos | A/Pos | Remark | Pol/Phase |
|-----|----------|--------|--------|--------|-------|-------|--------|---------|-------|-------|---------|------------|
| | MHz | dBuV/m | dBuV/m | dB | dBuV | dB | dB | dB/m | deg | cm | | |
| 1 p | 11395.18 | 50.66 | 74.00 | -23.34 | 40.07 | 6.85 | 34.74 | 38.48 | 130 | 100 | Peak | HORIZONTAL |
| 2 a | 11400.76 | 37.50 | 54.00 | -16.50 | 26.91 | 6.85 | 34.74 | 38.48 | 129 | 100 | Average | HORIZONTAL |

Vertical

| | Freq | Level | Limit | Over | Read | Cable | Preamp | Antenna | T/Pos | A/Pos | Remark | Pol/Phase |
|-----|----------|--------|--------|--------|-------|-------|--------|---------|-------|-------|---------|-----------|
| | MHz | dBuV/m | dBuV/m | dB | dBuV | dB | dB | dB/m | deg | cm | | |
| 1 a | 11398.58 | 38.29 | 54.00 | -15.71 | 27.70 | 6.85 | 34.74 | 38.48 | 252 | 100 | Average | VERTICAL |
| 2 p | 11401.48 | 52.00 | 74.00 | -22.00 | 41.41 | 6.85 | 34.74 | 38.48 | 252 | 100 | Peak | VERTICAL |

Note:

The amplitude of spurious emissions that are attenuated by more than 20dB below the permissible value has no need to be reported.

Emission level (dBuV/m) = 20 log Emission level (uV/m).

Corrected Reading: Antenna Factor + Cable Loss + Read Level - Preamp Factor = Level.

4.7. Band Edge Emissions Measurement

4.7.1. Limit

For transmitters operating in the 5.15-5.35 GHz band: all emissions outside of the 5.15-5.35 GHz band shall not exceed an EIRP of -27 dBm/MHz (68.3dBuV/m at 3m). For transmitters operating in the 5.470-5.725 GHz band: all emissions outside of the 5.470-5.725 GHz band shall not exceed an EIRP of -27 dBm/MHz (68.3dBuV/m at 3m). For transmitters operating in the 5.725-5.825 GHz band: all emissions within the frequency range from the band edge to 10 MHz above or below the band edge shall not exceed an EIRP of -17 dBm/MHz (78.3dBuV/m at 3m); for frequencies 10 MHz or greater above or below the band edge, emissions shall not exceed an EIRP of -27 dBm/MHz (68.3dBuV/m at 3m). In addition, in case the emission falls within the restricted band specified on 15.205(a), then the 15.209(a) limit in the table below has to be followed.

| Frequencies (MHz) | Field Strength (micovolts/meter) | Measurement Distance (meters) |
|-------------------|----------------------------------|-------------------------------|
| 0.009~0.490 | 2400/F(KHz) | 300 |
| 0.490~1.705 | 24000/F(KHz) | 30 |
| 1.705~30.0 | 30 | 30 |
| 30~88 | 100 | 3 |
| 88~216 | 150 | 3 |
| 216~960 | 200 | 3 |
| Above 960 | 500 | 3 |

4.7.2. Measuring Instruments and Setting

Please refer to section 5 of equipments list in this report. The following table is the setting of the spectrum analyzer.

| Spectrum Parameter | Setting |
|---|---|
| Attenuation | Auto |
| Span Frequency | 100 MHz |
| RB / VB (Emission in restricted band) | 1 MHz / 1MHz for Peak, 1 MHz / 10Hz for Average |
| RB / VB (Emission in non-restricted band) | 1 MHz / 1 MHz for Peak |

4.7.3. Test Procedures

- The test procedure is the same as section 4.6.3, only the frequency range investigated is limited to 100MHz around bandedges.
- In case the emission is fail due to the used RB/VB is too wide, marker-delta method of FCC Public Notice DA00-705 will be followed.

4.7.4. Test Setup Layout

This test setup layout is the same as that shown in section 4.6.4.

4.7.5. Test Deviation

There is no deviation with the original standard.

4.7.6. EUT Operation during Test

The EUT was programmed to be in continuously transmitting mode.

4.7.7. Test Result of Band Edge and Fundamental Emissions

< For Ant. 3 >

| | | | |
|----------------------|---------------|-----------------------|---|
| Temperature | 20°C | Humidity | 63% |
| Test Engineer | Serway Li | Configurations | IEEE 802.11n MCS8 20MHz Ch 36, 40, 48 /Ant.3 /Connector 1 + Connector 3 |
| Test Date | Aug. 24, 2011 | | |

Channel 36

| | Freq | Level | Limit | Over | Read | Cable | Preamp | Antenna | T/Pos | A/Pos | Remark | Pol/Phase |
|-----|---------|--------|--------|-------|-------|-------|--------|---------|-------|-------|---------|------------|
| | MHz | dBuV/m | dBuV/m | dB | dBuV | dB | dB | dB/m | deg | cm | | |
| 1 | 5150.00 | 65.52 | 74.00 | -8.48 | 27.78 | 4.67 | 0.00 | 33.07 | 348 | 180 | Peak | HORIZONTAL |
| 2 l | 5150.00 | 53.02 | 54.00 | -0.98 | 15.28 | 4.67 | 0.00 | 33.07 | 348 | 180 | Average | HORIZONTAL |
| 3 a | 5178.80 | 103.04 | | | | 4.70 | 0.00 | 33.13 | 348 | 180 | Average | HORIZONTAL |
| 4 p | 5182.00 | 115.57 | | | | 4.70 | 0.00 | 33.13 | 348 | 180 | Peak | HORIZONTAL |

Item 3, 4 are the fundamental frequency at 5180 MHz.

Channel 40

| | Freq | Level | Limit | Over | Read | Cable | Preamp | Antenna | T/Pos | A/Pos | Remark | Pol/Phase |
|-----|---------|--------|--------|--------|-------|-------|--------|---------|-------|-------|---------|------------|
| | MHz | dBuV/m | dBuV/m | dB | dBuV | dB | dB | dB/m | deg | cm | | |
| 1 | 5147.60 | 60.77 | 74.00 | -13.23 | 23.03 | 4.67 | 0.00 | 33.07 | 345 | 181 | Peak | HORIZONTAL |
| 2 | 5150.00 | 45.33 | 54.00 | -8.67 | 7.59 | 4.67 | 0.00 | 33.07 | 345 | 181 | Average | HORIZONTAL |
| 3 p | 5196.80 | 119.15 | | | | 4.74 | 0.00 | 33.16 | 345 | 181 | Peak | HORIZONTAL |
| 4 a | 5202.40 | 106.41 | | | | 4.74 | 0.00 | 33.16 | 345 | 181 | Average | HORIZONTAL |

Item 3, 4 are the fundamental frequency at 5200 MHz.

Channel 48

| | Freq | Level | Limit | Over | Read | Cable | Preamp | Antenna | T/Pos | A/Pos | Remark | Pol/Phase |
|-----|---------|--------|--------|--------|-------|-------|--------|---------|-------|-------|---------|------------|
| | MHz | dBuV/m | dBuV/m | dB | dBuV | dB | dB | dB/m | deg | cm | | |
| 1 | 5150.00 | 54.26 | 74.00 | -19.74 | 16.52 | 4.67 | 0.00 | 33.07 | 346 | 181 | Peak | HORIZONTAL |
| 2 | 5150.00 | 43.99 | 54.00 | -10.01 | 6.25 | 4.67 | 0.00 | 33.07 | 346 | 181 | Average | HORIZONTAL |
| 3 a | 5241.20 | 107.31 | | | | 4.78 | 0.00 | 33.22 | 346 | 181 | Average | HORIZONTAL |
| 4 p | 5242.80 | 118.28 | | | | 4.78 | 0.00 | 33.25 | 346 | 181 | Peak | HORIZONTAL |

Item 3, 4 are the fundamental frequency at 5240 MHz.

< For Ant. 3 >

| | | | |
|----------------------|---------------|-----------------------|--|
| Temperature | 20°C | Humidity | 63% |
| Test Engineer | Serway Li | Configurations | IEEE 802.11n MCS8 20MHz Ch 52, 60, 64 /Ant.3 /Connector 1 + Connector 3 |
| Test Date | Aug. 24, 2011 | | |

Channel 52

| | Freq | Level | Limit | Over | Read | Cable | Preamp | Antenna | T/Pos | A/Pos | Remark | Pol/Phase |
|-----|---------|--------|--------|--------|-------|-------|--------|---------|-------|-------|---------|------------|
| | MHz | dBuV/m | dBuV/m | dB | dBuV | dB | dB | dB/m | deg | cm | | |
| 1 a | 5261.20 | 107.52 | | | | 4.81 | 0.00 | 33.28 | 347 | 180 | Average | HORIZONTAL |
| 2 p | 5265.60 | 117.63 | | | | 4.81 | 0.00 | 33.28 | 347 | 180 | Peak | HORIZONTAL |
| 3 | 5350.00 | 55.84 | 74.00 | -18.16 | 17.45 | 4.96 | 0.00 | 33.43 | 347 | 180 | Peak | HORIZONTAL |
| 4 | 5350.00 | 45.91 | 54.00 | -8.09 | 7.52 | 4.96 | 0.00 | 33.43 | 347 | 180 | Average | HORIZONTAL |

Item 1, 2 are the fundamental frequency at 5260 MHz.

Channel 60

| | Freq | Level | Limit | Over | Read | Cable | Preamp | Antenna | T/Pos | A/Pos | Remark | Pol/Phase |
|-----|---------|--------|--------|-------|-------|-------|--------|---------|-------|-------|---------|------------|
| | MHz | dBuV/m | dBuV/m | dB | dBuV | dB | dB | dB/m | deg | cm | | |
| 1 p | 5296.80 | 120.50 | | | | 4.89 | 0.00 | 33.34 | 346 | 180 | Peak | HORIZONTAL |
| 2 a | 5302.40 | 108.36 | | | | 4.89 | 0.00 | 33.34 | 346 | 180 | Average | HORIZONTAL |
| 3 ! | 5350.00 | 68.78 | 74.00 | -5.22 | 30.39 | 4.96 | 0.00 | 33.43 | 346 | 180 | Peak | HORIZONTAL |
| 4 ! | 5350.00 | 53.30 | 54.00 | -0.70 | 14.91 | 4.96 | 0.00 | 33.43 | 346 | 180 | Average | HORIZONTAL |

Item 1, 2 are the fundamental frequency at 5300 MHz.

Channel 64

| | Freq | Level | Limit | Over | Read | Cable | Preamp | Antenna | T/Pos | A/Pos | Remark | Pol/Phase |
|-----|---------|--------|--------|-------|-------|-------|--------|---------|-------|-------|---------|------------|
| | MHz | dBuV/m | dBuV/m | dB | dBuV | dB | dB | dB/m | deg | cm | | |
| 1 p | 5321.20 | 116.61 | | | | 4.89 | 0.00 | 33.37 | 346 | 177 | Peak | HORIZONTAL |
| 2 a | 5322.40 | 104.34 | | | | 4.92 | 0.00 | 33.37 | 346 | 177 | Average | HORIZONTAL |
| 3 | 5350.00 | 65.50 | 74.00 | -8.50 | 27.11 | 4.96 | 0.00 | 33.43 | 346 | 177 | Peak | HORIZONTAL |
| 4 ! | 5350.00 | 53.20 | 54.00 | -0.80 | 14.81 | 4.96 | 0.00 | 33.43 | 346 | 177 | Average | HORIZONTAL |

Item 1, 2 are the fundamental frequency at 5320 MHz.

< For Ant. 3 >

| | | | |
|----------------------|---------------|-----------------------|--|
| Temperature | 20°C | Humidity | 63% |
| Test Engineer | Serway Li | Configurations | IEEE 802.11n MCS8 20MHz Ch 100, 140 /Ant.3 /Connector 1 + Connector 3 |
| Test Date | Nov. 01, 2011 | | |

Channel 100

| | Freq | Level | Limit Line | Over Limit | Read Level | CableAntenna Loss | Antenna Factor | Preamp Factor | Remark | A/Pos | T/Pos | Pol/Phase |
|---|---------|--------|------------|------------|------------|-------------------|----------------|---------------|---------|-------|-------|-----------|
| | MHz | dBuV/m | dBuV/m | dB | dBuV | dB | dB/m | dB | | cm | deg | |
| 1 | 5460.00 | 46.81 | 54.00 | -7.19 | 9.08 | 3.52 | 34.21 | 0.00 | Average | 104 | 345 | VERTICAL |
| 2 | 5460.00 | 59.29 | 74.00 | -14.71 | 21.56 | 3.52 | 34.21 | 0.00 | Peak | 104 | 345 | VERTICAL |
| 3 | 5470.00 | 67.68 | 68.30 | -0.62 | 29.92 | 3.52 | 34.24 | 0.00 | Peak | 104 | 345 | VERTICAL |
| 4 | 5496.80 | 115.35 | | | | 3.53 | 34.26 | 0.00 | Peak | 104 | 345 | VERTICAL |
| 5 | 5501.60 | 103.60 | | | | 3.54 | 34.28 | 0.00 | Average | 104 | 345 | VERTICAL |

Item 4, 5 are the fundamental frequency at 5500 MHz.

Channel 140

| | Freq | Level | Limit Line | Over Limit | Read Level | CableAntenna Loss | Antenna Factor | Preamp Factor | Remark | A/Pos | T/Pos | Pol/Phase |
|---|---------|--------|------------|------------|------------|-------------------|----------------|---------------|---------|-------|-------|------------|
| | MHz | dBuV/m | dBuV/m | dB | dBuV | dB | dB/m | dB | | cm | deg | |
| 1 | 5694.40 | 109.56 | | | | 3.59 | 34.34 | 0.00 | Peak | 165 | 46 | HORIZONTAL |
| 2 | 5698.80 | 97.34 | | | | 3.59 | 34.34 | 0.00 | Average | 165 | 46 | HORIZONTAL |
| 3 | 5725.00 | 67.53 | 68.30 | -0.77 | 29.59 | 3.60 | 34.34 | 0.00 | Peak | 165 | 46 | HORIZONTAL |

Item 1, 2 are the fundamental frequency at 5700 MHz.

< For Ant. 3 >

| | | | |
|----------------------|---------------|-----------------------|---|
| Temperature | 20°C | Humidity | 63% |
| Test Engineer | Serway Li | Configurations | IEEE 802.11n MCS8 40MHz Ch 38, 46, /Ant.3 /Connector 1 + Connector 3 |
| Test Date | Aug. 24, 2011 | | |

Channel 38

| | Freq | Level | Limit | Over | Read | Cable | Preamp | Antenna | T/Pos | A/Pos | Remark | Pol/Phase |
|---|---------|--------|--------|-------|-------|-------|--------|---------|-------|-------|---------|------------|
| | MHz | dBuV/m | dBuV/m | dB | dBuV | dB | dB | dB/m | deg | cm | | |
| 1 | 5150.00 | 65.03 | 74.00 | -8.97 | 27.29 | 4.67 | 0.00 | 33.07 | 349 | 182 | Peak | HORIZONTAL |
| 2 | 5150.00 | 53.89 | 54.00 | -0.11 | 16.15 | 4.67 | 0.00 | 33.07 | 349 | 182 | Average | HORIZONTAL |
| 3 | 5196.40 | 106.72 | | | | 4.74 | 0.00 | 33.16 | 349 | 182 | Peak | HORIZONTAL |
| 4 | 5204.00 | 94.18 | | | | 4.74 | 0.00 | 33.16 | 349 | 182 | Average | HORIZONTAL |

Item 3, 4 are the fundamental frequency at 5190 MHz.

Channel 46

| | Freq | Level | Limit | Over | Read | Cable | Preamp | Antenna | T/Pos | A/Pos | Remark | Pol/Phase |
|---|---------|--------|--------|-------|-------|-------|--------|---------|-------|-------|---------|------------|
| | MHz | dBuV/m | dBuV/m | dB | dBuV | dB | dB | dB/m | deg | cm | | |
| 1 | 5150.00 | 66.82 | 74.00 | -7.18 | 29.08 | 4.67 | 0.00 | 33.07 | 349 | 179 | Peak | HORIZONTAL |
| 2 | 5150.00 | 53.32 | 54.00 | -0.68 | 15.58 | 4.67 | 0.00 | 33.07 | 349 | 179 | Average | HORIZONTAL |
| 3 | 5235.60 | 115.95 | | | | 4.78 | 0.00 | 33.22 | 349 | 179 | Peak | HORIZONTAL |
| 4 | 5237.60 | 103.64 | | | | 4.78 | 0.00 | 33.22 | 349 | 179 | Average | HORIZONTAL |

Item 3, 4 are the fundamental frequency at 5230 MHz.

< For Ant. 3 >

| | | | |
|----------------------|---------------|-----------------------|--|
| Temperature | 20°C | Humidity | 63% |
| Test Engineer | Serway Li | Configurations | IEEE 802.11n MCS8 40MHz Ch 54, 62, /Ant.3 /Connector 1 + Connector 3 |
| Test Date | Aug. 24, 2011 | | |

Channel 54

| | Freq | Level | Limit | Over | Read | Cable | Preamp | Antenna | T/Pos | A/Pos | Remark | Pol/Phase |
|-----|---------|--------|--------|-------|-------|-------|--------|---------|-------|-------|---------|------------|
| | MHz | dBuV/m | dBuV/m | dB | dBuV | dB | dB | dB/m | deg | cm | | |
| 1 p | 5275.60 | 115.91 | | | | 4.85 | 0.00 | 33.31 | 346 | 180 | Peak | HORIZONTAL |
| 2 a | 5285.20 | 102.86 | | | | 4.85 | 0.00 | 33.31 | 346 | 180 | Average | HORIZONTAL |
| 3 ! | 5350.00 | 69.33 | 74.00 | -4.67 | 30.94 | 4.96 | 0.00 | 33.43 | 346 | 180 | Peak | HORIZONTAL |
| 4 ! | 5350.00 | 53.85 | 54.00 | -0.15 | 15.46 | 4.96 | 0.00 | 33.43 | 346 | 180 | Average | HORIZONTAL |

Item 1, 2 are the fundamental frequency at 5270 MHz.

Channel 62

| | Freq | Level | Limit | Over | Read | Cable | Preamp | Antenna | T/Pos | A/Pos | Remark | Pol/Phase |
|-----|---------|--------|--------|-------|-------|-------|--------|---------|-------|-------|---------|------------|
| | MHz | dBuV/m | dBuV/m | dB | dBuV | dB | dB | dB/m | deg | cm | | |
| 1 a | 5321.20 | 94.46 | | | | 4.89 | 0.00 | 33.37 | 347 | 182 | Average | HORIZONTAL |
| 2 p | 5324.80 | 106.72 | | | | 4.92 | 0.00 | 33.37 | 347 | 182 | Peak | HORIZONTAL |
| 3 | 5350.00 | 64.41 | 74.00 | -9.59 | 26.02 | 4.96 | 0.00 | 33.43 | 347 | 182 | Peak | HORIZONTAL |
| 4 ! | 5350.00 | 53.81 | 54.00 | -0.19 | 15.42 | 4.96 | 0.00 | 33.43 | 347 | 182 | Average | HORIZONTAL |

Item 1, 2 are the fundamental frequency at 5310 MHz.

< For Ant. 3 >

| | | | |
|----------------------|---------------|-----------------------|--|
| Temperature | 20°C | Humidity | 63% |
| Test Engineer | Serway Li | Configurations | IEEE 802.11n MCS8 40MHz Ch 102, 134 /Ant.3 /Connector 1 + Connector 3 |
| Test Date | Nov. 01, 2011 | | |

Channel 102

| | Freq | Level | Limit Line | Over Limit | Read Level | CableAntenna Loss | Antenna Factor | Preamp Factor | Remark | A/Pos | T/Pos | Pol/Phase |
|---|---------|--------|---------------|---------------|---------------|----------------------|-------------------|------------------|---------|-------|-------|------------|
| | MHz | dBuV/m | dBuV/m | dB | dBuV | dB | dB/m | dB | | cm | deg | |
| 1 | 5456.80 | 65.57 | 74.00 | -8.43 | 27.86 | 3.52 | 34.19 | 0.00 | Peak | 170 | 39 | HORIZONTAL |
| 2 | 5460.00 | 47.61 | 54.00 | -6.39 | 9.90 | 3.52 | 34.19 | 0.00 | Average | 170 | 39 | HORIZONTAL |
| 3 | 5470.00 | 67.26 | 68.30 | -1.04 | 29.53 | 3.52 | 34.21 | 0.00 | Peak | 170 | 39 | HORIZONTAL |
| 4 | 5501.20 | 96.49 | | | | 3.54 | 34.25 | 0.00 | Average | 170 | 39 | HORIZONTAL |
| 5 | 5521.20 | 109.05 | | | | 3.54 | 34.27 | 0.00 | Peak | 170 | 39 | HORIZONTAL |

Item 3, 4 are the fundamental frequency at 5510 MHz.

Channel 134

| | Freq | Level | Limit Line | Over Limit | Read Level | CableAntenna Loss | Antenna Factor | Preamp Factor | Remark | A/Pos | T/Pos | Pol/Phase |
|---|---------|--------|---------------|---------------|---------------|----------------------|-------------------|------------------|---------|-------|-------|------------|
| | MHz | dBuV/m | dBuV/m | dB | dBuV | dB | dB/m | dB | | cm | deg | |
| 1 | 5655.20 | 109.20 | | | | 3.59 | 34.33 | 0.00 | Peak | 183 | 41 | HORIZONTAL |
| 2 | 5658.80 | 96.79 | | | | 3.59 | 34.33 | 0.00 | Average | 183 | 41 | HORIZONTAL |
| 3 | 5727.40 | 68.06 | 68.30 | -0.24 | 30.12 | 3.60 | 34.34 | 0.00 | Peak | 183 | 41 | HORIZONTAL |

Item 1, 2 are the fundamental frequency at 5670 MHz.

< For Ant. 3 >

| | | | |
|----------------------|---------------|-----------------------|---|
| Temperature | 20°C | Humidity | 63% |
| Test Engineer | Serway Li | Configurations | IEEE 802.11a Ch 36, 40, 48 /Ant.3 /Connector 1 + Connector 3 |
| Test Date | Aug. 24, 2011 | | |

Channel 36

| | Freq | Level | Limit | Over | Read | Cable | Preamp | Antenna | T/Pos | A/Pos | Remark | Pol/Phase |
|-----|---------|--------|--------|-------|-------|-------|--------|---------|-------|-------|---------|------------|
| | MHz | dBuV/m | dBuV/m | dB | dBuV | dB | dB | dB/m | deg | cm | | |
| 1 ! | 5147.20 | 71.06 | 74.00 | -2.94 | 33.32 | 4.67 | 0.00 | 33.07 | 346 | 171 | Peak | HORIZONTAL |
| 2 ! | 5148.20 | 53.14 | 54.00 | -0.86 | 15.40 | 4.67 | 0.00 | 33.07 | 346 | 171 | Average | HORIZONTAL |
| 3 a | 5182.40 | 108.39 | | | | 4.70 | 0.00 | 33.13 | 346 | 171 | Average | HORIZONTAL |
| 4 p | 5182.80 | 117.35 | | | | 4.70 | 0.00 | 33.13 | 346 | 171 | Peak | HORIZONTAL |

Item 3, 4 are the fundamental frequency at 5180 MHz.

Channel 40

| | Freq | Level | Limit | Over | Read | Cable | Preamp | Antenna | T/Pos | A/Pos | Remark | Pol/Phase |
|-----|---------|--------|--------|-------|-------|-------|--------|---------|-------|-------|---------|------------|
| | MHz | dBuV/m | dBuV/m | dB | dBuV | dB | dB | dB/m | deg | cm | | |
| 1 ! | 5149.60 | 70.03 | 74.00 | -3.97 | 32.29 | 4.67 | 0.00 | 33.07 | 346 | 186 | Peak | HORIZONTAL |
| 2 ! | 5150.00 | 50.33 | 54.00 | -3.67 | 12.59 | 4.67 | 0.00 | 33.07 | 346 | 186 | Average | HORIZONTAL |
| 3 p | 5204.80 | 121.17 | | | | 4.74 | 0.00 | 33.16 | 346 | 186 | Peak | HORIZONTAL |
| 4 a | 5204.80 | 111.80 | | | | 4.74 | 0.00 | 33.16 | 346 | 186 | Average | HORIZONTAL |

Item 3, 4 are the fundamental frequency at 5200 MHz.

Channel 48

| | Freq | Level | Limit | Over | Read | Cable | Preamp | Antenna | T/Pos | A/Pos | Remark | Pol/Phase |
|-----|---------|--------|--------|--------|-------|-------|--------|---------|-------|-------|---------|------------|
| | MHz | dBuV/m | dBuV/m | dB | dBuV | dB | dB | dB/m | deg | cm | | |
| 1 | 5150.00 | 53.42 | 74.00 | -20.58 | 15.68 | 4.67 | 0.00 | 33.07 | 350 | 180 | Peak | HORIZONTAL |
| 2 | 5150.00 | 44.11 | 54.00 | -9.89 | 6.37 | 4.67 | 0.00 | 33.07 | 350 | 180 | Average | HORIZONTAL |
| 3 a | 5238.00 | 107.79 | | | | 4.78 | 0.00 | 33.22 | 350 | 180 | Average | HORIZONTAL |
| 4 p | 5242.80 | 116.95 | | | | 4.78 | 0.00 | 33.25 | 350 | 180 | Peak | HORIZONTAL |

Item 3, 4 are the fundamental frequency at 5240 MHz.

< For Ant. 3 >

| | | | |
|----------------------|---------------|-----------------------|---|
| Temperature | 20°C | Humidity | 63% |
| Test Engineer | Serway Li | Configurations | IEEE 802.11a Ch 52, 60, 64 /Ant.3 /Connector 1 + Connector 3 |
| Test Date | Aug. 24, 2011 | | |

Channel 52

| | Freq | Level | Limit | Over | Read | Cable | Preamp | Antenna | T/Pos | A/Pos | Remark | Pol/Phase |
|-----|---------|--------|--------|--------|-------|-------|--------|---------|-------|-------|---------|------------|
| | MHz | dBuV/m | dBuV/m | dB | dBuV | dB | dB | dB/m | deg | cm | | |
| 1 a | 5259.20 | 109.05 | | | | 4.81 | 0.00 | 33.28 | 346 | 180 | Average | HORIZONTAL |
| 2 p | 5264.80 | 118.37 | | | | 4.81 | 0.00 | 33.28 | 346 | 180 | Peak | HORIZONTAL |
| 3 | 5350.00 | 56.45 | 74.00 | -17.55 | 18.06 | 4.96 | 0.00 | 33.43 | 346 | 180 | Peak | HORIZONTAL |
| 4 | 5350.00 | 45.97 | 54.00 | -8.03 | 7.58 | 4.96 | 0.00 | 33.43 | 346 | 180 | Average | HORIZONTAL |

Item 1, 2 are the fundamental frequency at 5260 MHz.

Channel 60

| | Freq | Level | Limit | Over | Read | Cable | Preamp | Antenna | T/Pos | A/Pos | Remark | Pol/Phase |
|-----|---------|--------|--------|-------|-------|-------|--------|---------|-------|-------|---------|------------|
| | MHz | dBuV/m | dBuV/m | dB | dBuV | dB | dB | dB/m | deg | cm | | |
| 1 p | 5296.80 | 122.23 | | | | 4.89 | 0.00 | 33.34 | 347 | 180 | Peak | HORIZONTAL |
| 2 a | 5301.60 | 112.22 | | | | 4.89 | 0.00 | 33.34 | 347 | 180 | Average | HORIZONTAL |
| 3 ! | 5351.20 | 73.81 | 74.00 | -0.19 | 35.42 | 4.96 | 0.00 | 33.43 | 347 | 180 | Peak | HORIZONTAL |
| 4 ! | 5352.00 | 53.88 | 54.00 | -0.12 | 15.49 | 4.96 | 0.00 | 33.43 | 347 | 180 | Average | HORIZONTAL |

Item 1, 2 are the fundamental frequency at 5300 MHz.

Channel 64

| | Freq | Level | Limit | Over | Read | Cable | Preamp | Antenna | T/Pos | A/Pos | Remark | Pol/Phase |
|-----|---------|--------|--------|-------|-------|-------|--------|---------|-------|-------|---------|------------|
| | MHz | dBuV/m | dBuV/m | dB | dBuV | dB | dB | dB/m | deg | cm | | |
| 1 a | 5319.40 | 107.19 | | | | 4.89 | 0.00 | 33.37 | 347 | 180 | Average | HORIZONTAL |
| 2 p | 5324.60 | 117.36 | | | | 4.92 | 0.00 | 33.37 | 347 | 180 | Peak | HORIZONTAL |
| 3 ! | 5350.00 | 68.53 | 74.00 | -5.47 | 30.14 | 4.96 | 0.00 | 33.43 | 347 | 180 | Peak | HORIZONTAL |
| 4 ! | 5350.00 | 53.33 | 54.00 | -0.67 | 14.94 | 4.96 | 0.00 | 33.43 | 347 | 180 | Average | HORIZONTAL |

Item 1, 2 are the fundamental frequency at 5320 MHz.

< For Ant. 3 >

| | | | |
|----------------------|---------------|-----------------------|---|
| Temperature | 20°C | Humidity | 63% |
| Test Engineer | Serway Li | Configurations | IEEE 802.11a Ch 100, 140 /Ant.3 /Connector 1 + Connector 3 |
| Test Date | Nov. 01, 2011 | | |

Channel 100

| | Freq | Level | Limit Line | Over Limit | Read Level | CableAntenna Loss | Antenna Factor | Preamp Factor | Remark | A/Pos | T/Pos | Pol/Phase |
|---|---------|--------|------------|------------|------------|-------------------|----------------|---------------|---------|-------|-------|------------|
| | MHz | dBuV/m | dBuV/m | dB | dBuV | dB | dB/m | dB | | cm | deg | |
| 1 | 5459.80 | 44.18 | 54.00 | -9.82 | 6.47 | 3.52 | 34.19 | 0.00 | Average | 166 | 25 | HORIZONTAL |
| 2 | 5459.80 | 59.64 | 74.00 | -14.36 | 21.93 | 3.52 | 34.19 | 0.00 | Peak | 166 | 25 | HORIZONTAL |
| 3 | 5470.00 | 68.25 | 68.30 | -0.05 | 30.52 | 3.52 | 34.21 | 0.00 | Peak | 166 | 25 | HORIZONTAL |
| 4 | 5500.80 | 105.30 | | | | 3.54 | 34.23 | 0.00 | Average | 166 | 25 | HORIZONTAL |
| 5 | 5505.60 | 115.47 | | | | 3.54 | 34.25 | 0.00 | Peak | 166 | 25 | HORIZONTAL |

Item 4, 5 are the fundamental frequency at 5500 MHz.

Channel 140

| | Freq | Level | Limit Line | Over Limit | Read Level | CableAntenna Loss | Antenna Factor | Preamp Factor | Remark | A/Pos | T/Pos | Pol/Phase |
|---|---------|--------|------------|------------|------------|-------------------|----------------|---------------|---------|-------|-------|------------|
| | MHz | dBuV/m | dBuV/m | dB | dBuV | dB | dB/m | dB | | cm | deg | |
| 1 | 5697.80 | 100.71 | | | | 3.59 | 34.34 | 0.00 | Average | 166 | 44 | HORIZONTAL |
| 2 | 5697.80 | 111.45 | | | | 3.59 | 34.34 | 0.00 | Peak | 166 | 44 | HORIZONTAL |
| 3 | 5725.00 | 67.75 | 68.30 | -0.55 | 29.81 | 3.60 | 34.34 | 0.00 | Peak | 166 | 44 | HORIZONTAL |

Item 1, 2 are the fundamental frequency at 5700 MHz.

< For Ant. 4 >

| | | | |
|----------------------|---------------|-----------------------|--|
| Temperature | 20°C | Humidity | 63% |
| Test Engineer | Serway Li | Configurations | IEEE 802.11n MCS8 20MHz Ch 52, 60, 64 /Ant.4 /Connector 1 + Connector 3 |
| Test Date | Aug. 24, 2011 | | |

Channel 52

| | Freq | Level | Limit | Over | Read | Cable | Preamp | Antenna | T/Pos | A/Pos | Remark | Pol/Phase |
|-----|---------|--------|--------|-------|-------|-------|--------|---------|-------|-------|---------|-----------|
| | MHz | dBuV/m | dBuV/m | dB | dBuV | dB | dB | dB/m | deg | cm | | |
| 1 a | 5259.20 | 115.09 | | | | 4.81 | 0.00 | 33.28 | 11 | 115 | Average | VERTICAL |
| 2 p | 5264.80 | 124.87 | | | | 4.81 | 0.00 | 33.28 | 11 | 115 | Peak | VERTICAL |
| 3 | 5350.00 | 65.14 | 74.00 | -8.86 | 26.75 | 4.96 | 0.00 | 33.43 | 11 | 115 | Peak | VERTICAL |
| 4 ! | 5350.00 | 53.11 | 54.00 | -0.89 | 14.72 | 4.96 | 0.00 | 33.43 | 11 | 115 | Average | VERTICAL |

Item 1, 2 are the fundamental frequency at 5260 MHz.

Channel 60

| | Freq | Level | Limit | Over | Read | Cable | Preamp | Antenna | T/Pos | A/Pos | Remark | Pol/Phase |
|-----|---------|--------|--------|-------|-------|-------|--------|---------|-------|-------|---------|-----------|
| | MHz | dBuV/m | dBuV/m | dB | dBuV | dB | dB | dB/m | deg | cm | | |
| 1 p | 5295.60 | 124.98 | | | | 4.85 | 0.00 | 33.34 | 6 | 107 | Peak | VERTICAL |
| 2 a | 5300.80 | 115.91 | | | | 4.89 | 0.00 | 33.34 | 6 | 107 | Average | VERTICAL |
| 3 | 5350.00 | 65.47 | 74.00 | -8.53 | 27.08 | 4.96 | 0.00 | 33.43 | 6 | 107 | Peak | VERTICAL |
| 4 ! | 5350.00 | 53.08 | 54.00 | -0.92 | 14.69 | 4.96 | 0.00 | 33.43 | 6 | 107 | Average | VERTICAL |

Item 1, 2 are the fundamental frequency at 5300 MHz.

Channel 64

| | Freq | Level | Limit | Over | Read | Cable | Preamp | Antenna | T/Pos | A/Pos | Remark | Pol/Phase |
|-----|---------|--------|--------|-------|-------|-------|--------|---------|-------|-------|---------|-----------|
| | MHz | dBuV/m | dBuV/m | dB | dBuV | dB | dB | dB/m | deg | cm | | |
| 1 p | 5315.60 | 121.28 | | | | 4.89 | 0.00 | 33.37 | 356 | 141 | Peak | VERTICAL |
| 2 a | 5324.80 | 111.42 | | | | 4.92 | 0.00 | 33.37 | 356 | 141 | Average | VERTICAL |
| 3 ! | 5350.00 | 53.36 | 54.00 | -0.64 | 14.97 | 4.96 | 0.00 | 33.43 | 356 | 141 | Average | VERTICAL |
| 4 ! | 5351.40 | 70.94 | 74.00 | -3.06 | 32.55 | 4.96 | 0.00 | 33.43 | 356 | 141 | Peak | VERTICAL |

Item 1, 2 are the fundamental frequency at 5320 MHz.

< For Ant. 4 >

| | | | |
|----------------------|---------------|-----------------------|--|
| Temperature | 20°C | Humidity | 63% |
| Test Engineer | Serway Li | Configurations | IEEE 802.11n MCS8 20MHz Ch 100, 140 /Ant.4 /Connector 1 + Connector 3 |
| Test Date | Nov. 01, 2011 | | |

Channel 100

| | Freq | Level | Limit | Over | Read | CableAntenna | Preamp | Remark | A/Pos | T/Pos | Pol/Phase |
|---|---------|--------|--------|-------|-------|--------------|--------|--------------|-------|-------|-----------|
| | MHz | dBuV/m | dBuV/m | dB | dBuV | dB | dB/m | dB | cm | deg | |
| 1 | 5697.00 | 116.68 | | | | 3.59 | 34.34 | 0.00 Peak | 120 | 352 | VERTICAL |
| 2 | 5701.60 | 104.82 | | | | 3.59 | 34.34 | 0.00 Average | 120 | 352 | VERTICAL |
| 3 | 5725.00 | 68.26 | 68.30 | -0.04 | 30.32 | 3.60 | 34.34 | 0.00 Peak | 120 | 352 | VERTICAL |

Item 1, 2 are the fundamental frequency at 5500 MHz.

Channel 140

| | Freq | Level | Limit | Over | Read | CableAntenna | Preamp | Remark | A/Pos | T/Pos | Pol/Phase |
|---|---------|--------|--------|--------|-------|--------------|--------|--------------|-------|-------|-----------|
| | MHz | dBuV/m | dBuV/m | dB | dBuV | dB | dB/m | dB | cm | deg | |
| 1 | 5460.00 | 50.61 | 54.00 | -3.39 | 12.88 | 3.52 | 34.21 | 0.00 Average | 100 | 348 | VERTICAL |
| 2 | 5460.00 | 63.49 | 74.00 | -10.51 | 25.76 | 3.52 | 34.21 | 0.00 Peak | 100 | 348 | VERTICAL |
| 3 | 5469.80 | 66.98 | 68.30 | -1.32 | 29.22 | 3.52 | 34.24 | 0.00 Peak | 100 | 348 | VERTICAL |
| 4 | 5501.20 | 121.39 | | | | 3.54 | 34.28 | 0.00 Peak | 100 | 348 | VERTICAL |
| 5 | 5501.40 | 108.21 | | | | 3.54 | 34.28 | 0.00 Average | 100 | 348 | VERTICAL |

Item 4, 5 are the fundamental frequency at 5700 MHz.

< For Ant. 4 >

| | | | |
|----------------------|---------------|-----------------------|---|
| Temperature | 20°C | Humidity | 63% |
| Test Engineer | Serway Li | Configurations | IEEE 802.11n MCS8 40MHz Ch 54, 62, /Ant.4 /Connector 1 + Connector 3 |
| Test Date | Aug. 24, 2011 | | |

Channel 54

| | Freq | Level | Limit | Over | Read | Cable | Preamp | Antenna | T/Pos | A/Pos | Remark | Pol/Phase |
|-----|---------|--------|--------|-------|-------|-------|--------|---------|-------|-------|---------|-----------|
| | MHz | dBuV/m | dBuV/m | dB | dBuV | dB | dB | dB/m | deg | cm | | |
| 1 p | 5262.40 | 120.34 | | | | 4.81 | 0.00 | 33.28 | 10 | 107 | Peak | VERTICAL |
| 2 a | 5287.20 | 107.36 | | | | 4.85 | 0.00 | 33.31 | 10 | 107 | Average | VERTICAL |
| 3 ! | 5350.00 | 65.13 | 74.00 | -8.87 | 26.74 | 4.96 | 0.00 | 33.43 | 10 | 107 | Peak | VERTICAL |
| 4 ! | 5350.00 | 53.02 | 54.00 | -0.98 | 14.63 | 4.96 | 0.00 | 33.43 | 10 | 107 | Average | VERTICAL |

Item 1, 2 are the fundamental frequency at 5270 MHz.

Channel 62

| | Freq | Level | Limit | Over | Read | Cable | Preamp | Antenna | T/Pos | A/Pos | Remark | Pol/Phase |
|-----|---------|--------|--------|-------|-------|-------|--------|---------|-------|-------|---------|-----------|
| | MHz | dBuV/m | dBuV/m | dB | dBuV | dB | dB | dB/m | deg | cm | | |
| 1 a | 5317.20 | 99.81 | | | | 4.89 | 0.00 | 33.37 | 8 | 107 | Average | VERTICAL |
| 2 p | 5320.00 | 112.78 | | | | 4.89 | 0.00 | 33.37 | 8 | 107 | Peak | VERTICAL |
| 3 ! | 5350.00 | 69.46 | 74.00 | -4.54 | 31.07 | 4.96 | 0.00 | 33.43 | 8 | 107 | Peak | VERTICAL |
| 4 ! | 5350.00 | 53.61 | 54.00 | -0.39 | 15.22 | 4.96 | 0.00 | 33.43 | 8 | 107 | Average | VERTICAL |

Item 1, 2 are the fundamental frequency at 5310 MHz.

< For Ant. 4 >

| | | | |
|----------------------|---------------|-----------------------|--|
| Temperature | 20°C | Humidity | 63% |
| Test Engineer | Serway Li | Configurations | IEEE 802.11n MCS8 40MHz Ch 102, 134 /Ant.4 /Connector 1 + Connector 3 |
| Test Date | Nov. 01, 2011 | | |

Channel 102

| | Freq | Level | Limit Line | Over Limit | Read Level | CableAntenna Loss | Antenna Factor | Preamp Factor | Remark | A/Pos | T/Pos | Pol/Phase |
|---|---------|--------|------------|------------|------------|-------------------|----------------|---------------|---------|-------|-------|-----------|
| | MHz | dBuV/m | dBuV/m | dB | dBuV | dB | dB/m | dB | | cm | deg | |
| 1 | 5457.60 | 62.58 | 74.00 | -11.42 | 24.85 | 3.52 | 34.21 | 0.00 | Peak | 100 | 352 | VERTICAL |
| 2 | 5460.00 | 50.43 | 54.00 | -3.57 | 12.70 | 3.52 | 34.21 | 0.00 | Average | 100 | 352 | VERTICAL |
| 3 | 5470.00 | 67.69 | 68.30 | -0.61 | 29.93 | 3.52 | 34.24 | 0.00 | Peak | 100 | 352 | VERTICAL |
| 4 | 5494.00 | 111.13 | | | | 3.53 | 34.26 | 0.00 | Peak | 100 | 352 | VERTICAL |
| 5 | 5502.00 | 98.87 | | | | 3.54 | 34.28 | 0.00 | Average | 100 | 352 | VERTICAL |

Item 4, 5 are the fundamental frequency at 5510 MHz.

Channel 134

| | Freq | Level | Limit Line | Over Limit | Read Level | CableAntenna Loss | Antenna Factor | Preamp Factor | Remark | A/Pos | T/Pos | Pol/Phase |
|---|---------|--------|------------|------------|------------|-------------------|----------------|---------------|---------|-------|-------|-----------|
| | MHz | dBuV/m | dBuV/m | dB | dBuV | dB | dB/m | dB | | cm | deg | |
| 1 | 5654.40 | 116.26 | | | | 3.59 | 34.33 | 0.00 | Peak | 100 | 347 | VERTICAL |
| 2 | 5662.40 | 103.99 | | | | 3.59 | 34.33 | 0.00 | Average | 100 | 347 | VERTICAL |
| 3 | 5726.60 | 68.29 | 68.30 | -0.01 | 30.35 | 3.60 | 34.34 | 0.00 | Peak | 100 | 347 | VERTICAL |

Item 1, 2 are the fundamental frequency at 5670 MHz.

< For Ant. 4 >

| | | | |
|----------------------|---------------|-----------------------|---|
| Temperature | 20°C | Humidity | 63% |
| Test Engineer | Serway Li | Configurations | IEEE 802.11a Ch 52, 60, 64 /Ant.4 /Connector 1 + Connector 3 |
| Test Date | Aug. 24, 2011 | | |

Channel 52

| | Freq | Level | Limit | Over | Read | Cable | Preamp | Antenna | T/Pos | A/Pos | Remark | Pol/Phase |
|-----|---------|--------|--------|-------|-------|-------|--------|---------|-------|-------|---------|-----------|
| | MHz | dBuV/m | dBuV/m | dB | dBuV | dB | dB | dB/m | deg | cm | | |
| 1 a | 5259.20 | 115.09 | | | | 4.81 | 0.00 | 33.28 | 11 | 115 | Average | VERTICAL |
| 2 p | 5264.80 | 124.87 | | | | 4.81 | 0.00 | 33.28 | 11 | 115 | Peak | VERTICAL |
| 3 | 5350.00 | 65.14 | 74.00 | -8.86 | 26.75 | 4.96 | 0.00 | 33.43 | 11 | 115 | Peak | VERTICAL |
| 4 ! | 5350.00 | 53.11 | 54.00 | -0.89 | 14.72 | 4.96 | 0.00 | 33.43 | 11 | 115 | Average | VERTICAL |

Item 1, 2 are the fundamental frequency at 5260 MHz.

Channel 60

| | Freq | Level | Limit | Over | Read | Cable | Preamp | Antenna | T/Pos | A/Pos | Remark | Pol/Phase |
|-----|---------|--------|--------|-------|-------|-------|--------|---------|-------|-------|---------|-----------|
| | MHz | dBuV/m | dBuV/m | dB | dBuV | dB | dB | dB/m | deg | cm | | |
| 1 p | 5295.60 | 124.98 | | | | 4.85 | 0.00 | 33.34 | 6 | 107 | Peak | VERTICAL |
| 2 a | 5300.80 | 115.91 | | | | 4.89 | 0.00 | 33.34 | 6 | 107 | Average | VERTICAL |
| 3 | 5350.00 | 65.47 | 74.00 | -8.53 | 27.08 | 4.96 | 0.00 | 33.43 | 6 | 107 | Peak | VERTICAL |
| 4 ! | 5350.00 | 53.08 | 54.00 | -0.92 | 14.69 | 4.96 | 0.00 | 33.43 | 6 | 107 | Average | VERTICAL |

Item 1, 2 are the fundamental frequency at 5300 MHz.

Channel 64

| | Freq | Level | Limit | Over | Read | Cable | Preamp | Antenna | T/Pos | A/Pos | Remark | Pol/Phase |
|-----|---------|--------|--------|-------|-------|-------|--------|---------|-------|-------|---------|-----------|
| | MHz | dBuV/m | dBuV/m | dB | dBuV | dB | dB | dB/m | deg | cm | | |
| 1 p | 5315.60 | 121.28 | | | | 4.89 | 0.00 | 33.37 | 356 | 141 | Peak | VERTICAL |
| 2 a | 5324.80 | 111.42 | | | | 4.92 | 0.00 | 33.37 | 356 | 141 | Average | VERTICAL |
| 3 ! | 5350.00 | 53.36 | 54.00 | -0.64 | 14.97 | 4.96 | 0.00 | 33.43 | 356 | 141 | Average | VERTICAL |
| 4 ! | 5351.40 | 70.94 | 74.00 | -3.06 | 32.55 | 4.96 | 0.00 | 33.43 | 356 | 141 | Peak | VERTICAL |

Item 1, 2 are the fundamental frequency at 5320 MHz.

< For Ant. 4 >

| | | | |
|----------------------|---------------|-----------------------|---|
| Temperature | 20°C | Humidity | 63% |
| Test Engineer | Serway Li | Configurations | IEEE 802.11a Ch 100, 140 /Ant.4 /Connector 1 + Connector 3 |
| Test Date | Nov. 01, 2011 | | |

Channel 100

| | Freq | Level | Limit Line | Over Limit | Read Level | Cable Loss | Antenna Factor | Preamp Factor | Remark | A/Pos | T/Pos | Pol/Phase |
|---|---------|--------|------------|------------|------------|------------|----------------|---------------|---------|-------|-------|-----------|
| | MHz | dBuV/m | dBuV/m | dB | dBuV | dB | dB/m | dB | | cm | deg | |
| 1 | 5460.00 | 50.77 | 54.00 | -3.23 | 13.04 | 3.52 | 34.21 | 0.00 | Average | 116 | 354 | VERTICAL |
| 2 | 5460.00 | 63.83 | 74.00 | -10.17 | 26.10 | 3.52 | 34.21 | 0.00 | Peak | 116 | 354 | VERTICAL |
| 3 | 5470.00 | 67.35 | 68.30 | -0.95 | 29.59 | 3.52 | 34.24 | 0.00 | Peak | 116 | 354 | VERTICAL |
| 4 | 5502.00 | 110.66 | | | | 3.54 | 34.28 | 0.00 | Average | 116 | 354 | VERTICAL |
| 5 | 5502.00 | 121.12 | | | | 3.54 | 34.28 | 0.00 | Peak | 116 | 354 | VERTICAL |

Item 4, 5 are the fundamental frequency at 5500 MHz.

Channel 140

| | Freq | Level | Limit Line | Over Limit | Read Level | Cable Loss | Antenna Factor | Preamp Factor | Remark | A/Pos | T/Pos | Pol/Phase |
|---|---------|--------|------------|------------|------------|------------|----------------|---------------|---------|-------|-------|-----------|
| | MHz | dBuV/m | dBuV/m | dB | dBuV | dB | dB/m | dB | | cm | deg | |
| 1 | 5698.60 | 107.99 | | | | 3.59 | 34.34 | 0.00 | Average | 118 | 351 | VERTICAL |
| 2 | 5703.20 | 118.13 | | | | 3.59 | 34.34 | 0.00 | Peak | 118 | 351 | VERTICAL |
| 3 | 5725.00 | 67.47 | 68.30 | -0.83 | 29.53 | 3.60 | 34.34 | 0.00 | Peak | 118 | 351 | VERTICAL |

Item 1, 2 are the fundamental frequency at 5700 MHz.

Note:

Emission level (dBuV/m) = 20 log Emission level (uV/m)

Corrected Reading: Antenna Factor + Cable Loss + Read Level - Preamp Factor = Level

4.8. Frequency Stability Measurement

4.8.1. Limit

Manufacturers of U-NII devices are responsible for ensuring frequency stability such that an emissions is maintained within the band of operation under all conditions of normal operation as specified in the user's manual or $\pm 20\text{ppm}$ (IEEE 802.11 specification).

4.8.2. Measuring Instruments and Setting

Please refer to section 5 of equipments list in this report. The following table is the setting of the spectrum analyzer.

| Spectrum Parameter | Setting |
|--------------------|--|
| Attenuation | Auto |
| Span Frequency | Entire absence of modulation emissions bandwidth |
| RB | 10 kHz |
| VB | 10 kHz |
| Sweep Time | Auto |

4.8.3. Test Procedures

1. The transmitter output (antenna port) was connected to the spectrum analyzer.
2. EUT have transmitted absence of modulation signal and fixed channelize.
3. Set the spectrum analyzer span to view the entire absence of modulation emissions bandwidth.
4. Set RBW = 10 kHz, VBW = 10 kHz with peak detector and maxhold settings.
5. f_c is declaring of channel frequency. Then the frequency error formula is $(f_c - f) / f_c \times 10^6$ ppm and the limit is less than $\pm 20\text{ppm}$ (IEEE 802.11 specification).
6. The test extreme voltage is to change the primary supply voltage from 85 to 115 percent of the nominal value
7. Extreme temperature rule is $-30^\circ\text{C} \sim 50^\circ\text{C}$.

4.8.4. Test Setup Layout

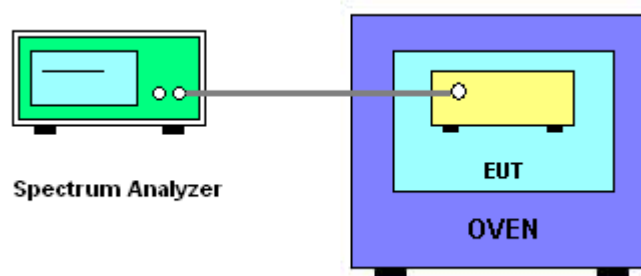

4.8.5. Test Deviation

There is no deviation with the original standard.

4.8.6. EUT Operation during Test

The EUT was programmed to be in continuously un-modulation transmitting mode.

4.8.7. Test Result of Frequency Stability

<For Ant. 3>

Voltage vs. Frequency Stability

| Voltage | Measurement Frequency (MHz) | |
|----------------------|-----------------------------|-----------|
| | 5200 | 5300 |
| (V) | | |
| 126.50 | 5199.9976 | 5299.9883 |
| 110.00 | 5199.9975 | 5299.9985 |
| 93.50 | 5200.0030 | 5300.0050 |
| Max. Deviation (MHz) | 0.005600 | 0.009900 |
| Max. Deviation (ppm) | 1.08 | 1.87 |

Temperature vs. Frequency Stability

| Temperature | Measurement Frequency (MHz) | |
|----------------------|-----------------------------|-----------|
| | 5200 | 5300 |
| (°C) | | |
| -30 | 5200.0004 | 5300.0002 |
| -20 | 5200.0005 | 5300.0002 |
| -10 | 5200.0006 | 5300.0001 |
| 0 | 5200.0005 | 5300.0000 |
| 10 | 5199.9887 | 5299.9986 |
| 20 | 5199.9986 | 5299.9988 |
| 30 | 5199.9984 | 5299.9987 |
| 40 | 5199.9986 | 5299.9988 |
| 50 | 5199.9984 | 5299.9989 |
| Max. Deviation (MHz) | 0.011300 | 0.001400 |
| Max. Deviation (ppm) | 2.17 | 0.2642 |

<For Ant. 4>

Voltage vs. Frequency Stability

| Voltage | Measurement Frequency (MHz) | |
|----------------------|-----------------------------|-----------|
| | 5260 | 5320 |
| (V) | | |
| 126.50 | 5199.9976 | 5319.9883 |
| 110.00 | 5199.9975 | 5319.9985 |
| 93.50 | 5200.0030 | 5320.0050 |
| Max. Deviation (MHz) | 0.005600 | 0.009900 |
| Max. Deviation (ppm) | 1.08 | 1.86 |

Temperature vs. Frequency Stability

| Temperature | Measurement Frequency (MHz) | |
|----------------------|-----------------------------|-----------|
| | 5260 | 5320 |
| (°C) | | |
| -30 | 5260.0004 | 5320.0002 |
| -20 | 5260.0005 | 5320.0002 |
| -10 | 5260.0006 | 5320.0001 |
| 0 | 5260.0005 | 5320.0000 |
| 10 | 5259.9887 | 5319.9986 |
| 20 | 5259.9986 | 5319.9988 |
| 30 | 5259.9984 | 5319.9987 |
| 40 | 5259.9986 | 5319.9988 |
| 50 | 5259.9984 | 5319.9989 |
| Max. Deviation (MHz) | 0.011300 | 0.001400 |
| Max. Deviation (ppm) | 2.15 | 0.2632 |

4.9. Antenna Requirements

4.9.1. Limit

Except for special regulations, the Low-power Radio-frequency Devices must not be equipped with any jacket for installing an antenna with extension cable. An intentional radiator shall be designed to ensure that no antenna other than that furnished by the responsible party shall be used with the device. The use of a permanently attached antenna or of an antenna that uses a unique coupling to the intentional radiator shall be considered sufficient to comply with the provisions of this Section. The manufacturer may design the unit so that the user can replace a broken antenna, but the use of a standard antenna jack or electrical connector is prohibited. Further, this requirement does not apply to intentional radiators that must be professionally installed.

4.9.2. Antenna Connector Construction

Please refer to section 3.3 in this test report; antenna connector complied with the requirements.

5. LIST OF MEASURING EQUIPMENTS

| Instrument | Manufacturer | Model No. | Serial No. | Characteristics | Calibration Date | Remark |
|-------------------|--------------|------------------|-------------|------------------|------------------|-----------------------|
| EMI Test Receiver | R&S | ESCS 30 | 100377 | 9kHz ~ 2.75GHz | Sep. 14, 2010 | Conduction (CO01-CB) |
| LISN | F.C.C. | FCC-LISN-50-16-2 | 04083 | 150kHz ~ 100MHz | Oct. 28, 2010 | Conduction (CO01-CB) |
| V- LISN | Schwarzbeck | NSLK 8127 | 8127-478 | 9K ~ 30MHz | Nov. 16, 2010 | Conduction (CO01-CB) |
| PULSE LIMITER | R&S | ESH3-Z2 | 100430 | 9K~30MHz | Jan. 04, 2011 | Conduction (CO01-CB) |
| COND Cable | - | Cable | - | 0.15MHz~30MHz | Dec. 4, 2010 | Conduction (CO01-CB) |
| BILOG ANTENNA | Schaffner | CBL6112D | 22021 | 20MHz ~ 2GHz | Oct. 17, 2010 | Radiation (03CH01-CB) |
| BILOG ANTENNA | Schaffner | CBL6112D | 22021 | 20MHz ~ 2GHz | Oct. 17, 2011 | Radiation (03CH01-CB) |
| Horn Antenna | EMCO | 3115 | 00075790 | 750MHz~18GHz | Nov. 22, 2010 | Radiation (03CH01-CB) |
| Horn Antenna | SCHWARZBEAK | BBHA 9170 | BBHA9170252 | 15GHz ~ 40GHz | Oct. 08, 2010 | Radiation (03CH01-CB) |
| Horn Antenna | SCHWARZBEAK | BBHA 9170 | BBHA9170252 | 15GHz ~ 40GHz | Oct. 08, 2011 | Radiation (03CH01-CB) |
| Pre-Amplifier | Agilent | 8447D | 2944A10991 | 0.1MHz ~ 1.3GHz | Nov. 17, 2010 | Radiation (03CH01-CB) |
| Pre-Amplifier | Agilent | 8449B | 3008A02310 | 1GHz ~ 26.5GHz | Nov. 23, 2010 | Radiation (03CH01-CB) |
| Pre-Amplifier | WM | TF-130N-R1 | 923365 | 26.5GHz ~ 40GHz | Jul. 29, 2011 | Radiation (03CH01-CB) |
| Spectrum analyzer | R&S | FSP | 100304 | 9kHz ~ 40GHz | Nov. 22, 2010 | Radiation (03CH01-CB) |
| EMI Test Receiver | R&S | ESCS 30 | 100355 | 9KHz ~ 2.75GHz | Mar. 22, 2011 | Radiation (03CH01-CB) |
| Loop Antenna | Teseq | HLA 6120 | 24155 | 9 kHz - 30 MHz | Sep. 09, 2010* | Radiation (03CH01-CB) |
| Turn Table | INN CO | CO 2000 | N/A | 0 ~ 360 degree | N/A | Radiation (03CH01-CB) |
| Antenna Mast | INN CO | CO2000 | N/A | 1 m - 4 m | N/A | Radiation (03CH01-CB) |
| RF Cable-low | Woken | Low Cable-1 | N/A | 30 MHz - 1 GHz | Nov. 17, 2010 | Radiation (03CH01-CB) |
| RF Cable-high | Woken | High Cable-1 | N/A | 1 GHz ~ 26.5 GHz | Nov. 17, 2010 | Radiation (03CH01-CB) |
| RF Cable-high | Woken | High Cable-2 | N/A | 1 GHz ~ 26.5 GHz | Nov. 17, 2010 | Radiation (03CH01-CB) |
| RF Cable-high | Woken | High Cable-3 | N/A | 1 GHz - 40 GHz | Nov. 17, 2010 | Radiation (03CH01-CB) |
| RF Cable-high | Woken | High Cable-4 | N/A | 1 GHz - 40 GHz | Nov. 17, 2010 | Radiation (03CH01-CB) |
| Spectrum analyzer | R&S | FSV30 | 101026 | 9KHz~30GHz | Jul. 27, 2011 | Conducted (TH01-CB) |

| Instrument | Manufacturer | Model No. | Serial No. | Characteristics | Calibration Date | Remark |
|----------------------------|--------------|---------------|------------|------------------|------------------|---------------------|
| Temp. and Humidity Chamber | Ten Billion | TTH-D3SP | TBN-931011 | -30~100 degree | May 20, 2011 | Conducted (TH01-CB) |
| Thermo-Hygro Meter | N/A | HC 520 | #1 | 15~70 degree | Nov. 02, 2010 | Conducted (TH01-CB) |
| Thermo-Hygro Meter | N/A | HC 520 | #1 | 15~70 degree | Nov. 02, 2011 | Conducted (TH01-CB) |
| RF Power Divider | HP | 11636A | 00306 | 2GHz ~ 18GHz | N/A | Conducted (TH01-CB) |
| RF Power Splitter | Anaren | 44100 | 1839 | 2GHz ~ 18GHz | N/A | Conducted (TH01-CB) |
| RF Power Splitter | Anaren | 42100 | 17930 | 2GHz ~ 18GHz | N/A | Conducted (TH01-CB) |
| EPM-P Series Power Meter | Agilent | E4416A | GB41291199 | 50MHz – 18GHz | Sep. 09, 2010 | Conducted (TH01-CB) |
| EPM-P Series Power Meter | Agilent | E4416A | GB41291199 | 50MHz – 18GHz | Sep. 09, 2011 | Conducted (TH01-CB) |
| Peak an Avg Power Sensor | Agilent | E9327A | US40442088 | 50MHz – 18GHz | Sep. 09, 2010 | Conducted (TH01-CB) |
| Peak an Avg Power Sensor | Agilent | E9327A | US40442088 | 50MHz – 18GHz | Sep. 09, 2011 | Conducted (TH01-CB) |
| Horn Antenna | COM-POWER | AH-118 | 071187 | 1GHz – 18GHz | Mar. 18, 2011 | Conducted (TH01-CB) |
| Horn Antenna | COM-POWER | AH-118 | 071042 | 1GHz – 18GHz | Oct. 14, 2010 | Radiation (TH01-CB) |
| Horn Antenna | COM-POWER | AH-118 | 071042 | 1GHz – 18GHz | Oct. 14, 2011 | Radiation (TH01-CB) |
| RF Cable-high | Woken | High Cable-7 | - | 1 GHz – 26.5 GHz | Nov. 17, 2010 | Conducted (TH01-CB) |
| RF Cable-high | Woken | High Cable-8 | - | 1 GHz – 26.5 GHz | Nov. 17, 2010 | Conducted (TH01-CB) |
| RF Cable-high | Woken | High Cable-9 | - | 1 GHz – 26.5 GHz | Nov. 17, 2010 | Conducted (TH01-CB) |
| RF Cable-high | Woken | High Cable-10 | - | 1 GHz – 26.5 GHz | Nov. 17, 2010 | Conducted (TH01-CB) |
| RF Cable-high | Woken | High Cable-11 | - | 1 GHz – 26.5 GHz | Nov. 17, 2010 | Conducted (TH01-CB) |
| RF Cable-high | Woken | High Cable-12 | - | 1 GHz – 26.5 GHz | Nov. 17, 2010 | Conducted (TH01-CB) |
| RF Cable-high | Woken | High Cable-13 | - | 1 GHz – 26.5 GHz | Nov. 17, 2010 | Conducted (TH01-CB) |
| Power Sensor | Anritsu | MA2411B | 0917223 | 300MHz~40GHz | Sep. 13, 2010 | Conducted (TH01-CB) |
| Power Sensor | Anritsu | MA2411B | 0917223 | 300MHz~40GHz | Sep. 13, 2011 | Conducted (TH01-CB) |
| Power Meter | Anritsu | ML2495A | 1035008 | 300MHz~40GHz | Sep. 08, 2010 | Conducted (TH01-CB) |
| Power Meter | Anritsu | ML2495A | 1035008 | 300MHz~40GHz | Sep. 08, 2011 | Conducted (TH01-CB) |

Note: Calibration Interval of instruments listed above is one year.

“**” Calibration Interval of instruments listed above is two years.

NCR means Non-Calibration required.

6. TEST LOCATION

| | |
|--------|--|
| SHIJR | ADD : 6Fl., No. 106, Sec. 1, Shintai 5th Rd., Shijr City, Taipei, Taiwan 221, R.O.C. TEL : 886-2-2696-2468 FAX : 886-2-2696-2255 |
| HWA YA | ADD : No. 52, Hwa Ya 1st Rd., Kwei-Shan Hsiang, Tao Yuan Hsien, Taiwan, R.O.C. TEL : 886-3-327-3456 FAX : 886-3-318-0055 |
| LINKOU | ADD : No. 30-2, Dingfu Tsuen, Linkou Shiang, Taipei, Taiwan 244, R.O.C TEL : 886-2-2601-1640 FAX : 886-2-2601-1695 |
| DUNGHU | ADD : No. 3, Lane 238, Kangle St., Neihu Chiu, Taipei, Taiwan 114, R.O.C. TEL : 886-2-2631-4739 FAX : 886-2-2631-9740 |
| JUNGHE | ADD : 7Fl., No. 758, Jungjeng Rd., Junghe City, Taipei, Taiwan 235, R.O.C. TEL : 886-2-8227-2020 FAX : 886-2-8227-2626 |
| NEIHU | ADD : 4Fl., No. 339, Hsin Hu 2 nd Rd., Taipei 114, Taiwan, R.O.C. TEL : 886-2-2794-8886 FAX : 886-2-2794-9777 |
| JHUBEI | ADD : No.8, Lane 724, Bo-ai St., Jhubei City, HsinChu County 302, Taiwan, R.O.C. TEL : 886-3-656-9065 FAX : 886-3-656-9085 |

7. TAF CERTIFICATE OF ACCREDITATION



Certificate No. : L1190-110702

財團法人全國認證基金會
Taiwan Accreditation Foundation

Certificate of Accreditation

This is to certify that

Sporton International Inc.
EMC & Wireless Communications Laboratory
No.52, Hwa Ya 1st Road, Hwa Ya Technology Park, Kwei-Shan Hsiang, Tao Yuan Hsien,
Taiwan, R.O.C.

is accredited in respect of laboratory

| | |
|---------------------------------------|--|
| Accreditation Criteria | : ISO/IEC 17025:2005 |
| Accreditation Number | : 1190 |
| Originally Accredited | : December 15, 2003 |
| Effective Period | : January 10, 2010 to January 09, 2013 |
| Accredited Scope | : Testing Field, see described in the Appendix |
| Specific Accreditation Program | : Accreditation Program for Designated Testing Laboratory for Commodities Inspection Accreditation Program for Telecommunication Equipment Testing Laboratory Accreditation Program for BSMI Mutual Recognition Arrangement with Foreign Authorities |

Jay-San Chen
President, Taiwan Accreditation Foundation
Date : July 02, 2011

P1, total 22 pages

The Appendix forms an integral part of this Certificate, which shall be invalid when use without the Appendix