

Test Report

Report Number:

F161419E3 3rd Version

Equipment under Test (EUT):

ILB BT ADIO MUX

Applicant:

PHOENIX CONTACT Electronics GmbH

Manufacturer:

PHOENIX CONTACT Electronics GmbH





Deutsche
Akkreditierungsstelle
D-PL-17186-01-01
D-PL-17186-01-02
D-PL-17186-01-03

References

- [1] **ANSI C63.10-2013**, American National Standard of Procedures for Compliance Testing of Unlicensed Wireless Devices
- [2] **FCC CFR 47 Part 15 (November 2016)**, Radio Frequency Devices
- [3] **RSS-247 (May 2015)**, Digital Transmission Systems (DTSs), Frequency Hopping Systems (FHSs) and Licence-Exempt Local Area Network (LE-LAN) Devices
- [4] **RSS-Gen Issue 4 (November 2014)**, General Requirements for Compliance of Radio Apparatus

Test Result

The requirements of the tests performed as shown in the overview (clause 4) were fulfilled by the equipment under test.
The complete test results are presented in the following.

Test engineer:	Paul NEUFELD		06.02.2017
	Name	Signature	Date
Authorized reviewer:	Bernd STEINER		06.02.2017
	Name	Signature	Date

This test report is only valid in its original form.

Any reproduction of its contents in extracts without written permission of the accredited test laboratory PHOENIX TESTLAB GmbH is prohibited.

The test results herein refer only to the tested sample. PHOENIX TESTLAB GmbH is not responsible for any generalisations or conclusions drawn from these test results concerning further samples. Any modification of the tested samples is prohibited and leads to the invalidity of this test report. Each page necessarily contains the PHOENIX TESTLAB Logo and the TEST REPORT NUMBER.

This test report is valid in hardcopy form as well as in electronic form.

Contents	Page
1 Identification.....	4
1.1 Applicant.....	4
1.2 Manufacturer	4
1.3 Test Laboratory	4
1.4 EUT (Equipment Under Test).....	5
1.5 Technical Data of Equipment.....	6
1.6 Dates	7
2 Operational States.....	7
3 Additional Information.....	7
4 Overview	8
5 Results.....	9
5.1 Duty cycle.....	9
5.2 Maximum conducted output power	9
5.2.1 Method of measurement	9
5.2.2 Test results	10
5.3 DTS Bandwidth	11
5.3.1 Method of measurement	11
5.3.2 Test result.....	12
5.4 Peak Power Spectral Density.....	13
5.4.1 Method of measurement	13
5.4.2 Test result.....	14
5.5 Band-edge compliance	15
5.5.1 Method of measurement (band edges next to unrestricted bands (conducted))	15
5.5.2 Test result.....	16
5.5.3 Method of measurement (band edges next to restricted bands (conducted))	17
5.5.4 Test results	17
5.6 Maximum unwanted emissions	20
5.6.1 Method of measurement (conducted emissions in the restricted bands).....	20
5.6.2 Method of measurement (conducted emissions in the unrestricted bands).....	22
5.6.3 Test results (conducted emissions).....	23
5.6.4 Method of measurement (radiated emissions).....	28
5.6.5 Test results (radiated emissions) – cabinet emissions.....	35
5.7 Conducted emissions on power supply lines (150 kHz to 30 MHz).....	45
6 Test equipment and ancillaries used for tests.....	47
7 Report History	48
8 List of Annexes.....	48

1 Identification

1.1 Applicant

Name:	PHOENIX CONTACT Electronics GmbH
Address:	Dringenauer Straße 30, 31812 Bad Pyrmont
Country:	Germany
Name for contact purposes:	Daniel Klein
Phone:	+47 5281 946 3385
Fax:	+47 5281 946 1111
eMail Address:	danielklein@phoenixcontact.com
Applicant represented during the test by the following person:	-Partly: Mr. Maik Stemme

1.2 Manufacturer

Name:	PHOENIX CONTACT Electronics GmbH
Address:	Dringenauer Straße 30, 31812 Bad Pyrmont
Country:	Germany
Name for contact purposes:	Daniel Klein
Phone:	+47 5281 946 3385
Fax:	+47 5281 946 1111
eMail Address:	danielklein@phoenixcontact.com
Applicant represented during the test by the following person:	-Partly: Mr. Maik Stemme

1.3 Test Laboratory

The tests were carried out by: **PHOENIX TESTLAB GmbH**
Königswinkel 10
32825 Blomberg
Germany

accredited by Deutsche Akkreditierungsstelle GmbH (DAkKS) in compliance with DIN EN ISO/IEC 17025 under Reg. No. D-PL-17186-01-02, FCC Test Firm Accreditation with the registration number 469623, designation number DE0004 and Industry Canada Test site registration SITE# IC3469A-1.

1.4 EUT (Equipment Under Test)

Test object: *	Wireless-MUX set
Type / PMN: *	ILB BT ADIO MUX
FCC ID: *	YG3ADIOMUX
IC: *	4720B-ADIOMUX
Serial number: *	Preproduction series
PCB identifier: *	9778519_05
HVIN (Hardware Version Identification Number): *	ILB BT ADIO MUX
FVIN (Firmware Version Identification Number): *	110
Hardware version: *	9778633_11
Software version: *	FW: 110

Channel 00	RX:	2402 MHz	TX:	2402 MHz
Channel 19	RX:	2440 MHz	TX:	2440 MHz
Channel 39	RX:	2480 MHz	TX:	2480 MHz

1.5 Technical Data of Equipment

Fulfills Bluetooth specification: *	4.0					
Antenna type: *	See antenna list below.					
Antenna gain: *	See antenna list below.					
Antenna connector: *	See antenna list below.					
Power supply - EUT	U _{nom} =	24.0 V DC	U _{min} =	19.2 V DC	U _{max} =	30.5 V DC
Type of modulation: *	GFSK					
Operating frequency range:*	2402 MHz to 2480 MHz					
Number of channels: *	40					
Temperature range: *	-40 °C to +70 °C					
Lowest / highest Internal clock frequency: *	32.768 kHz / 24 MHz					

* Declared by the applicant

Ancillary devices (supplied by the applicant):

Pin to RS232 converter	Assembled by the applicant
Test Laptop	Fujitsu LIFEBOOK E751

Table 1 Antenna specifications

Antenna name	Manufacturer	Antenna type	Gain [dBi]
RAD-ISM-2400-ANT-OMNI-2-1-RSMA	PHOENIX CONTACT GmbH & Co. KG	Omnidirectional antenna	2
RAD-ISM-2400-ANT-VAN-3-0-RSMA	PHOENIX CONTACT GmbH & Co. KG	Omnidirectional antenna	3
RAD-ISM-2400-ANT-OMNI-6-0	PHOENIX CONTACT GmbH & Co. KG	Omnidirectional antenna	6
RAD-ISM-2459-ANT-FOOD-6-0	PHOENIX CONTACT GmbH & Co. KG	Omnidirectional antenna	6
RAD-2400-ANT-OMNI-6-0-SW	PHOENIX CONTACT GmbH & Co. KG	Omnidirectional antenna	6
ANT-DIR-2459-01	PHOENIX CONTACT GmbH & Co. KG	Panel antenna	9

The following external I/O cables were used:

Identification	Connector		Length
	EUT	Ancillary	
EUT	Temporary pin connectors at the bottom of the EUT	RS232 interface	1 m *
EUT	PWR1	DC Power supply	1 m *

*: Length during the test if no other specified.

1.6 Dates

Date of receipt of test sample:	30.08.2016
Start of test:	30.08.2016
End of test:	29.09.2016

2 Operational States

The ILB BT ADIO MUX is a wireless-MUX set. It consists of two devices with 16 digital inputs and outputs and 2 analog inputs and outputs (0 - 20 mA, 0 - 10 V) each. The EUT is supplied with 24 V DC.

All tests were performed on the SMA reverse interface of the EUT.

For the test a serial connector was connected to pin interfaces, which were soldered to the PCB of the EUT by the manufacturer. A software called HCI Tester 2.3.5.0 was used to send commands to the EUT, for the purpose of setting the EUT into test mode.

The output power was set to +5 dBm for all tests.

The following operation modes were identified as worst case condition and used during the tests:

Operation mode	Description of the operation mode	BT mode	BT channel	Modulation	Data rate / Mbps
1	Continuous transmitting on 2402 MHz	BTLE	0	GFSK	1 MBit/s
2	Continuous transmitting on 2440 MHz	BTLE	19	GFSK	1 MBit/s
3	Continuous transmitting on 2480 MHz	BTLE	39	GFSK	1 MBit/s

3 Additional Information

The only modifications made at the samples were pin connectors which soldered to the PCB of the EUT.

4 Overview

Application	Frequency range [MHz]	FCC 47 CFR Part 15 section [2]	RSS-247 [3] or RSS-Gen, Issue 4 [4]	Status	Refer page
Maximum Peak Output Power	2400.0 - 2483.5	15.247 (b) (3), (4)	5.4 (2) [3]	Passed	9 et seq
DTS Bandwidth	2400.0 - 2483.5	15.247 (a) (2)	5.2 (1) [3]	Passed	11 et seq
Peak Power Spectral Density	2400.0 - 2483.5	15.247 (e)	5.2 (2) [3]	Passed	13 et seq
Band edge compliance	2400.0 - 2483.5	15.247 (d)	5.5 [3] 8.9 [4], 8.10 [4]	Passed	15 et seq.
Radiated emissions (transmitter)	0.009 – 26,500	15.247 (d) 15.205 (a) 15.209 (a)	5.5 [3] 8.9 [4], 8.10 [4]	Passed	20 et seq.
Conducted emissions on supply line	0.15 - 30	15.207 (a)	8.8 [4]	Passed	45 et seq.

5 Results

5.1 Duty cycle

The EUT was transmitting in test-mode with 100 % duty cycle, therefore no duty cycle measurements and duty cycle related reductions needed to be performed for the following test cases.

5.2 Maximum conducted output power

5.2.1 Method of measurement

The EUT has to be connected to the power meter via a low loss cable.

Acceptable measurement configurations

The measurement procedures described herein are based on the use of an antenna-port conducted test configuration.

PKPM1 – Peak power meter method was used for this test. The procedure is described in chapter 11.9.1.3 of document [1].

The measurement was performed at the upper and lower end and the middle of the assigned frequency band.

Test set-up:

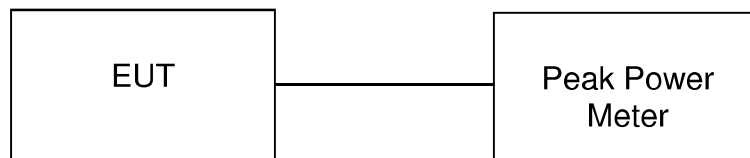

5.2.2 Test results

Ambient temperature	22 °C	Relative humidity	62 %
---------------------	-------	-------------------	------

The highest antenna gain is 9 dBi, therefore the peak limit is reduced by 3 dB.

Operation Mode	Maximum Peak output power [dBm]	Margin [dB]	Peak limit [dBm]
1	4.0	23.0	27.0
2	3.7	23.3	27.0
3	3.4	23.6	27.0
Measurement uncertainty		+0.66 dB / -0.72 dB	

Test: Passed

TEST EQUIPMENT USED FOR THE TEST:

60, 61

5.3 DTS Bandwidth

5.3.1 Method of measurement

The relating measurements were carried out in a conducting manner. Therefore, the antenna connector was directly connected to a spectrum analyser. The measurement procedure refers to part 11.8.1 of document [1].

- Set RBW = 100 kHz.
- Set the video bandwidth (VBW) $\geq 3 \times$ RBW.
- Detector = Peak.
- Trace mode = max hold.
- Sweep = auto couple.
- Allow the trace to stabilize.
- Measure the maximum width of the emission that is constrained by the frequencies associated with the two outermost amplitude points (upper and lower frequencies) that are attenuated by 6 dB relative to the maximum level measured in the fundamental emission.

5.3.2 Test result

Ambient temperature	22 °C	Relative humidity	59 %
---------------------	-------	-------------------	------

The following results were measured at the antenna port of the EUT. The plot shows an exemplary measurement result for the worst documented case. The other results are listed in the following table.

161419_6dB-BW_BTLE_BT1.wmf: 6-dB Bandwidth (operation mode 1):

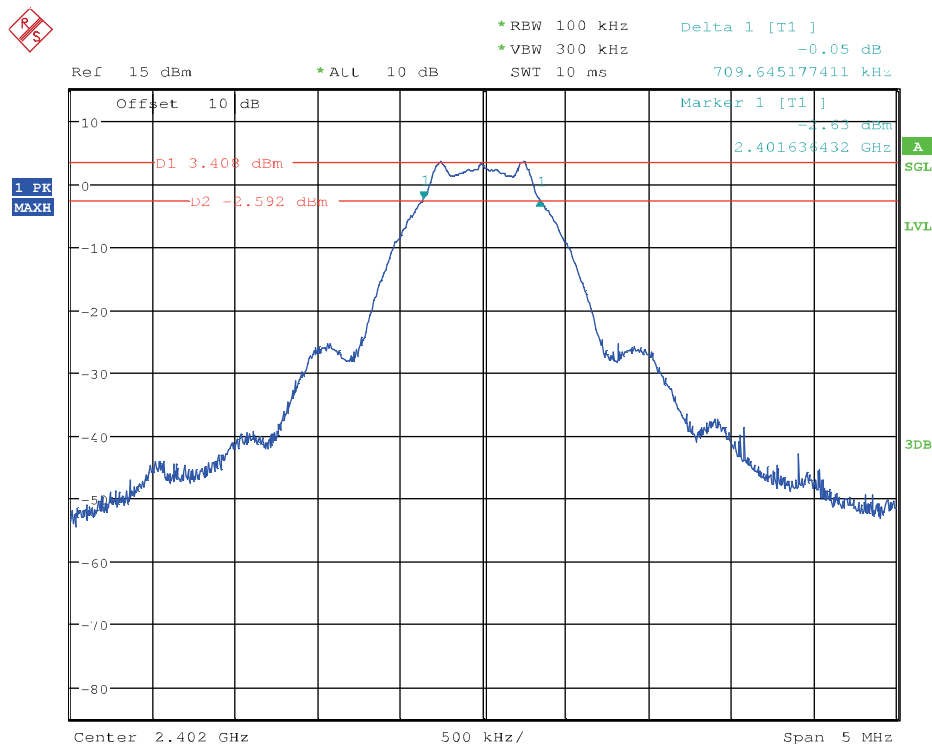

Operation Mode	Center Frequency [MHz]	Minimum 6-dB Bandwidth Limit [MHz]	6 dB Bandwidth [MHz]	Result
1	2402	0.5	0.710	Passed
2	2440	0.5	0.727	Passed
3	2480	0.5	0.735	Passed
Measurement uncertainty			+0.66 dB / -0.72 dB	

Test: Passed

TEST EQUIPMENT USED FOR THE TEST:

30

5.4 Peak Power Spectral Density

5.4.1 Method of measurement

The relating measurements were carried out in a conducting manner. Therefore, the antenna connector was directly connected to a spectrum analyser. The measurement procedure refers to part 11.10.2 of document [1].

- Set analyser center frequency to DTS channel center frequency
- Set the span to 1.5 times the DTS bandwidth.
- Set the RBW to: $3 \text{ kHz} \leq \text{RBW} \leq 100 \text{ kHz}$.
- Set the VBW $\geq 3 \times \text{RBW}$.
- Detector = peak.
- Sweep time = auto couple.
- Trace mode = max hold.
- Allow trace to fully stabilize.
- Use the peak marker function to determine the maximum amplitude level within the RBW.
- If measured value exceeds limit, reduce RBW (not less than 3 kHz) and repeat.

5.4.2 Test result

Ambient temperature	22 °C	Relative humidity	59 %
---------------------	-------	-------------------	------

The following results were measured at the antenna port of the EUT. The plot shows an exemplary measurement result for the worst documented case. The other results are listed in the following table.

The highest antenna gain is 9 dBi, therefore the peak limit is reduced by 3 dB.

161419 PwrSpecDens BTLE BT1.wmf: Power Spectral Density (operation mode 1):

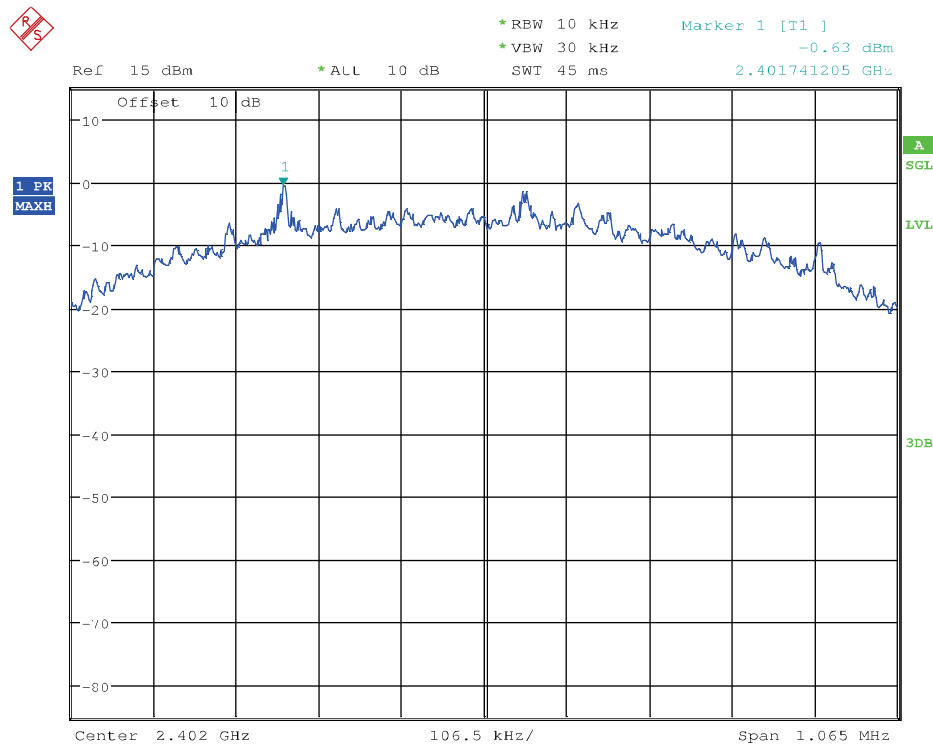

Operation Mode	Peak Frequency [MHz]	Power Spectral Density Limit [dBm/3kHz]	Power Spectral Density Reading [dBm / 10 kHz]	Margin[dB]	Result
1	2401.741	5	-0.6	5.6	Passed
2	2439.740	5	-0.9	5.9	Passed
3	2479.737	5	-1.1	6.1	Passed
Measurement uncertainty			+0.66 dB / -0.72 dB		

Test: Passed

TEST EQUIPMENT USED FOR THE TEST:

30

5.5 Band-edge compliance

5.5.1 Method of measurement (band edges next to unrestricted bands (conducted))

The relating measurements were carried out in a conducting manner. Therefore, the antenna connector was directly connected to a spectrum analyser. The measurement procedure refers to part 11.11.2 and 11.11.3 of document [1].

Measurement Procedure Reference – Reference Level:

- RBW = 100 kHz.
- VBW \geq 300 kHz.
- Set the span to \geq 1.5 times the DTS Bandwidth.
- Detector = Peak.
- Sweep time = auto couple.
- Trace mode = max hold.
- Allow trace to fully stabilise.
- Use the peak marker function to determine the the maximum PSD level.

Measurement Procedure – Unwanted Emissions

- Set the center frequency and span to encompass the frequency range to be measured.
- RBW = 100 kHz.
- VBW \geq 300 kHz.
- Detector = Peak.
- Ensure that the number of measurement points \geq span/RBW.
- Sweep time = auto couple.
- Trace Mode = max hold.
- Allow the trace to stabilise.
- Use the peak marker function to determine the maximum amplitude level.

The measurement procedure at the band edges was simplified by performing the measurement in just one plot. Both, the in-band-emission and the unwanted emission were be encompassed by the span. After trace stabilization, the maximum peak was be determined by a peak detector and the value was marked by an appropriate limit line. The second limit line, which is 20 dB below the first, marks the limit for the emissions in the unrestricted band. A maximum-peak-detector marks the highest emission in the unrestricted band next to the band edge.

The measurements were performed at the lower end of the 2.4 GHz band.

5.5.2 Test result

The following results were measured at the antenna port of the EUT. The plot shows an exemplary measurement result for the worst documented case. The other results are listed in the following table.

161419 BandEdgeUnrestr BTLE BT1.wmf: conducted band-edge compliance (operation mode 1):

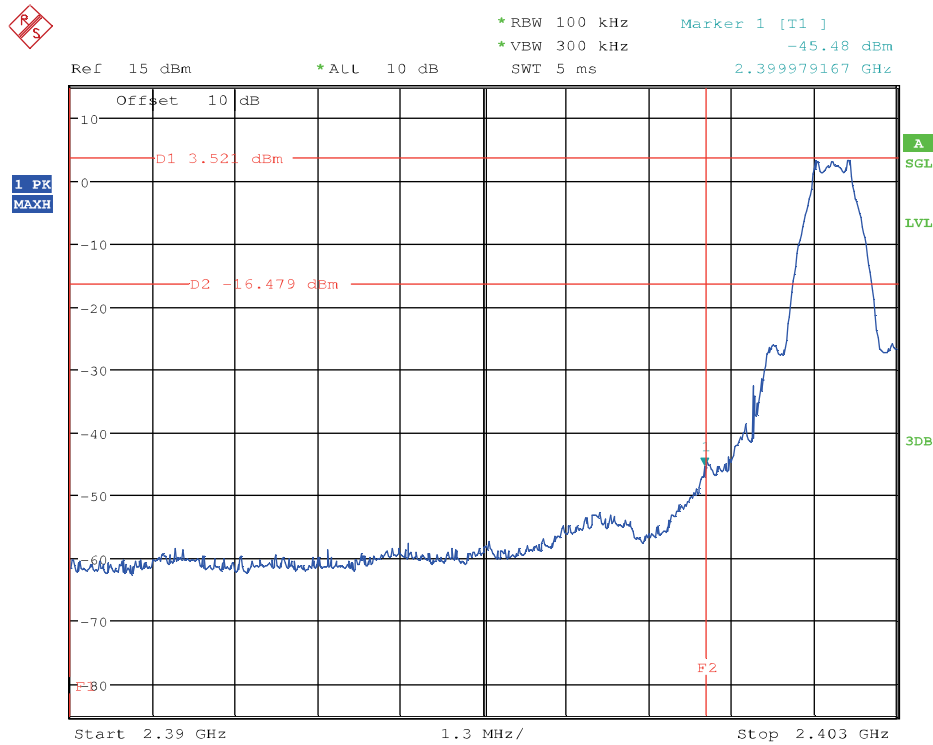

BT Mode	BT Channel	Emission Frequency [MHz]	Reference Level [dBm]	Limit [dBm]	Emission Level [dBm]	Margin [dB]	Result
BTLE	BT1	2399.979	3.5	-16.5	-45.2	28.7	Passed

Test: Passed

TEST EQUIPMENT USED FOR THE TEST:

30

5.5.3 Method of measurement (band edges next to restricted bands (conducted))

The same test set-up as used for the final conducted emission measurement shall be used (refer also subclause 5.6.1 of this test report).

After trace stabilisation the marker shall be set on the signal peak. The frequency line shall be set on the edge of the assigned frequency band. Now set the second marker on the emission at the band-edge, or on the highest modulation product outside of the band, if this level is higher than that at the band-edge. The level of the measured field strength shall be compared to the general limits specified in § 15.205.

The measurement was performed at the lower and the upper end of the 2.4 GHz band.

5.5.4 Test results

Ambient temperature	22 °C	Relative humidity	59 %
---------------------	-------	-------------------	------

The plot shows an exemplary measurement result for the worst documented case. The other results are listed in the following table.

161419 BandEdgeRestr BTLE BT1.wmf: conducted band-edge compliance (operation mode 1):

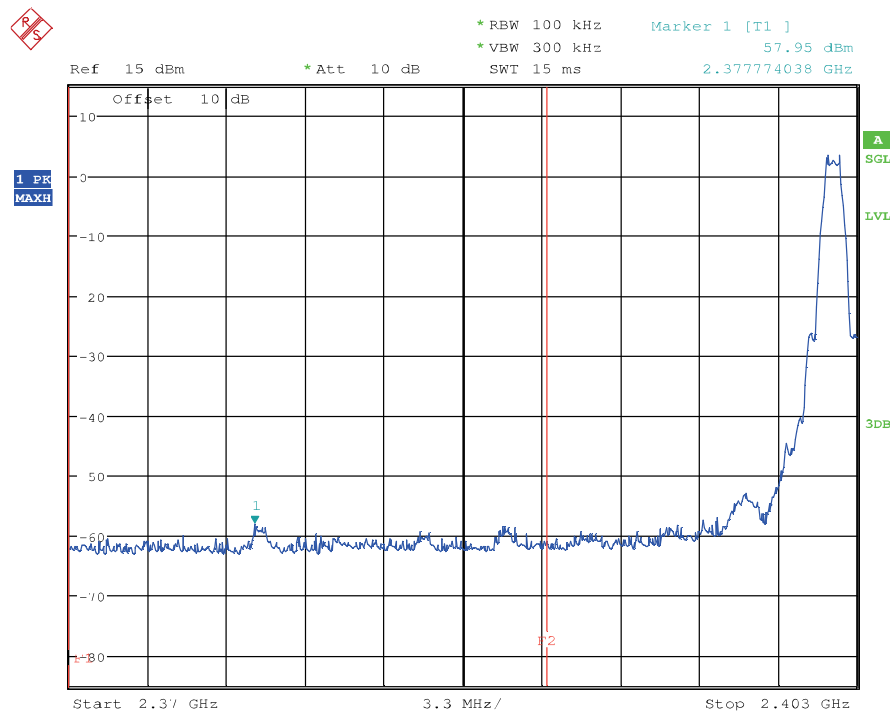

161419_BandEdgeRestr_BTLE_BTLE39.wmf: conducted band-edge compliance (operation mode 3):

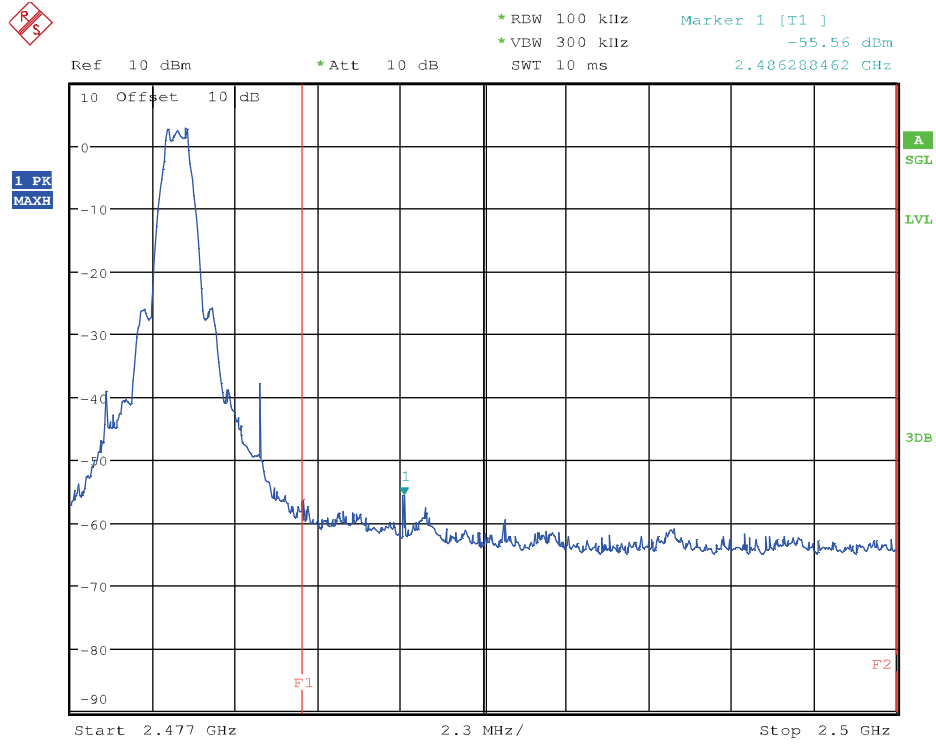

Band Edge Compliance, channel 0 (Operation mode 1)									
BT Mode	Channel	Frequency [MHz]	Field Strength [dBuV/m]	Peak Limit [dBuV/m]	Margin [dB]	Reading [dBm]	Antenna Gain + Array Gain [dBi]	Result	Restricted Band?
BTLE	BTLE0	2377.894	53.5	74.0	20.5	-51.1	9.0	Passed	Y
BT Mode	Channel	Frequency [MHz]	Field Strength [dBuV/m]	Average Limit [dBuV/m]	Margin [dB]	Reading [dBm]	Antenna Gain + Array Gain [dBi]	Result	Restricted Band?
BTLE	BTLE0	2377.974	44.6	54.0	9.4	-61.1	9.0	Passed	Y
Measurement uncertainty				+0.66 dB / -0.72 dB					

Band Edge Compliance, channel 39 (Operation mode 3)									
BT Mode	Channel	Frequency [MHz]	Field Strength [dBuV/m]	Peak Limit [dBuV/m]	Margin [dB]	Reading [dBm]	Antenna Gain + Array Gain [dBi]	Result	Restricted Band?
BTLE	BTLE39	2484.473	68.3	74.0	5.7	-37.0	9.0	Passed	Y
BT Mode	Channel	Frequency [MHz]	Field Strength [dBuV/m]	Average Limit [dBuV/m]	Margin [dB]	Reading [dBm]	Antenna Gain + Array Gain [dBi]	Result	Restricted Band?
BTLE	BTLE39	2483.788	46.5	54.0	7.5	-58.8	9.0	Passed	Y
Measurement uncertainty				+0.66 dB / -0.72 dB					

Test: Passed

TEST EQUIPMENT USED FOR THE TEST:
30

5.6 Maximum unwanted emissions

5.6.1 Method of measurement (conducted emissions in the restricted bands)

The relating measurements were carried out in a conducting manner. Therefore, the antenna connector was directly mounted to a spectrum analyser. The measurement procedure refers to part 11.12.2.2 in document [1].

If emissions were detected during the preliminary measurements, they were measured using the following measurement procedures:

Procedure for average measurement: 11.12.2.5.2 – Trace averaging across ON and OFF times of the EUT transmissions followed by duty cycle correction:

If continuous transmission of the EUT ($D \geq 98\%$) cannot be achieved and the duty cycle is constant (duty cycle variations are less than $\pm 2\%$), then the following procedure shall be used:

- The EUT shall be configured to operate at the maximum achievable duty cycle.
- Measure the duty cycle D of the transmitter output signal as described in 11.6 in [1].
- Set the RBW = 1 MHz (unless otherwise specified).
- Set the VBW $\geq 3 \times$ RBW.
- Detector = power average (RMS).
- Ensure that the number of measurement points in the sweep to $\geq 2 \times$ (span/RBW).
- Averaging type = power
- Sweep time = auto
- Perform a trace average of at least 100 traces
- Correct the resulting measurement value by adding the duty cycle correction value (only applicable if not transmit continuously).

Peak measurement procedure: 11.12.2.4 in [1]

- Set the analyzer span to encompass the entire unwanted emission bandwidth.
- Set the RBW = specified in Table 2.
- Set the VBW \geq RBW.
- Set sweep time = auto.
- Detector = peak.
- Trace mode = max hold.
- Allow the trace to stabilize.
- Use the peak marker function to determine the peak power over the emission bandwidth.

Table 2 RBW as a function of frequency

Frequency	RBW
9-150 kHz	200-300 Hz
0.15-30 MHz	9-10 kHz
30-1000 MHz	100-120 kHz
> 1000 MHz	1 MHz

5.6.1.1 Limit calculations

The following general procedure is described in chapter 11.12.2.2 in [1].

- a) Measure the conducted output power (in dBm) using the detector specified by the appropriate regulatory agency (see 11.12.2.3 through 11.12.2.5 for guidance regarding measurement procedures for determining quasi-peak, peak, and average conducted output power, respectively).
- b) Add the maximum transmit antenna gain (in dBi) to the measured output power level to determine the EIRP (see 11.12.2.6 for guidance on determining the applicable antenna gain).
- c) Add the appropriate maximum ground reflection factor to the EIRP (6 dB for frequencies ≤ 30 MHz; 4.7 dB for frequencies between 30 MHz and 1000 MHz, inclusive; and 0 dB for frequencies > 1000 MHz).
- d) For MIMO devices, measure the power of each chain and sum the EIRP of all chains in linear terms (i.e., watts and mW).
- e) Convert the resultant EIRP to an equivalent electric field strength using the following relationship:

$$E = EIRP - 20\log(d) + 104.8 \quad (1)$$

where

E is the electric field strength in dB μ V/m
 EIRP is the equivalent isotropically radiated power in dBm
 d is the specified measurement distance in m

- f) Compare the resultant electric field strength level with the applicable regulatory limit.
- g) C Perform the radiated spurious emission test.

Chapter 14 in [1] states, that for transmitters with multiple outputs in the same band, summing of emissions and accounting for array gain have to be considered.

For this test report the procedure of summing of emissions as described in 14.3.2.2 in [1] was used.

To account for directional gain which might occur in case of N transmit antennas, the directional has to be calculated as

$$G_{Dir} = G_{Ant} + 10\log(N)dB_i ,$$

whereby N is the number of antennas.

This EUT has only one antenna port, therefore no calculation for multiple ports have to be performed.

5.6.2 Method of measurement (conducted emissions in the unrestricted bands)

In any 100 kHz outside the authorized frequency band, the power shall be attenuated by 20 dB, compared to the highest in band power in any 100 kHz. This shall be demonstrated by using the peak power procedure. The reference level shall be measured using the procedure described in 5.6.2.1 and the emission level according to procedure 5.6.2.2. The procedures are based on chapter 11.11.2 and 11.11.3 in [1].

5.6.2.1 Reference level measurement

- a) Set instrument center frequency to DTS channel center frequency.
- b) Set the span to ≥ 1.5 times the DTS bandwidth.
- c) Set the RBW = 100 kHz.
- d) Set the VBW $\geq 3 \times$ RBW.
- e) Detector = peak.
- f) Sweep time = auto couple.
- g) Trace mode = max hold.
- h) Allow trace to fully stabilize.
- i) Use the peak marker function to determine the maximum PSD level.

5.6.2.2 Emission level measurement

- a) Set the center frequency and span to encompass frequency range to be measured.
- b) Set the RBW = 100 kHz.
- c) Set the VBW $\geq 3 \times$ RBW.
- d) Detector = peak.
- e) Ensure that the number of measurement points \geq span/RBW
- f) Sweep time = auto couple.
- g) Trace mode = max hold.
- h) Allow trace to fully stabilize.
- i) Use the peak marker function to determine the maximum amplitude level.

5.6.3 Test results (conducted emissions)

5.6.3.1 Emissions below 1 GHz

No significant emissions up to 20 dB to the limit were found in the frequency range below 30 MHz, therefore no results are submitted below. The emissions from 30 MHz to 1 GHz were failed during the conducted measurements; therefore they were repeated as radiated measurements.

161419 SpurEmiss0.03-1G_BTLE_0.wmf: conducted spurious emissions (operation mode 1):

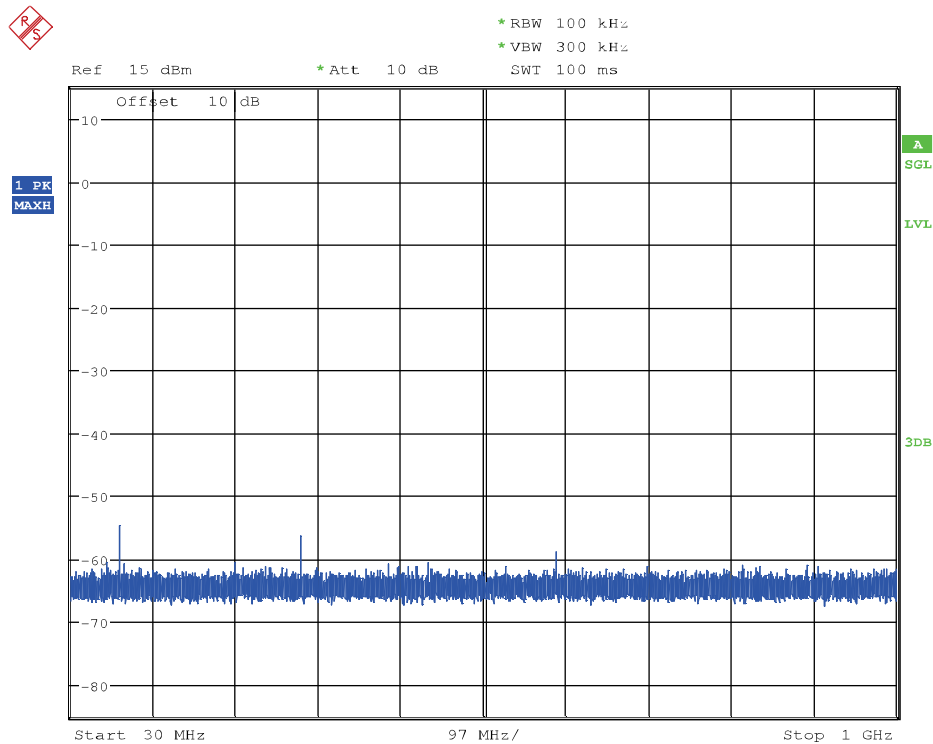

5.6.3.2 Emissions above 1 GHz

Ambient temperature	22 °C	Relative humidity	59 %
---------------------	-------	-------------------	------

161419 SpurEmiss1-4G BTLE 0.wmf: conducted spurious emissions (operation mode 1):

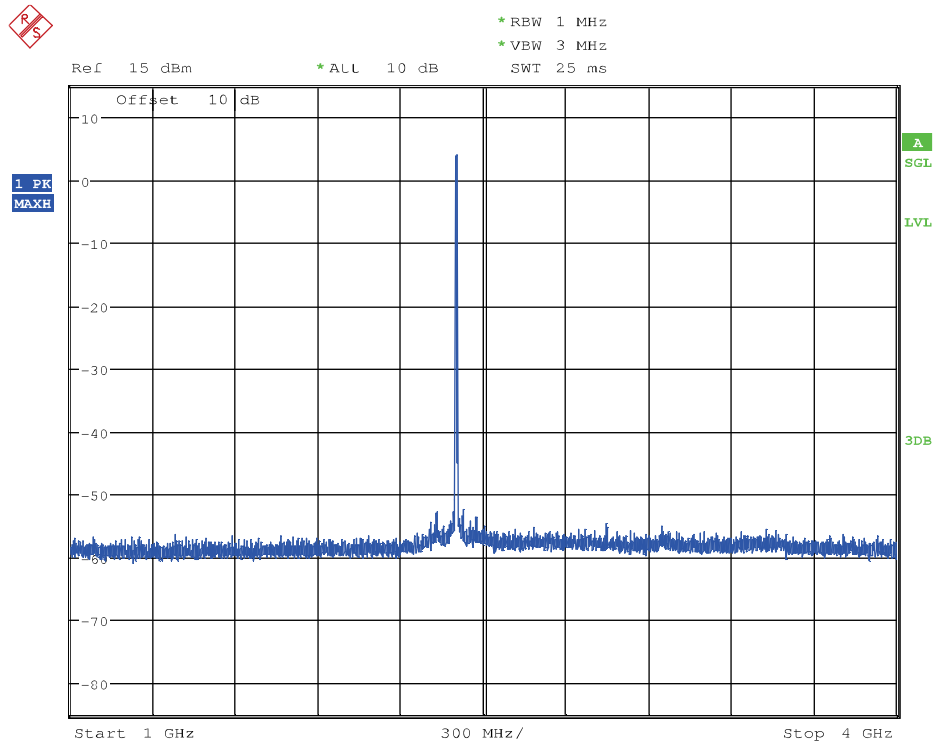

Spurious Emissions, channel 0 (Operation mode 1)									
Peak Emission – Restricted Band									
BT Mode	Channel	Frequency [MHz]	Field Strength [dBuV/m]	Max Peak Limit [dBuV/m]	Margin [dB]	Reading [dBm]	Antenna Gain + Array Gain [dBi]	Result	Restricted Band?
BTLE	BLE0	2329.730	52.4	74.0	21.6	-52.2	9.0	Passed	Y
BTLE	BLE0	2498.200	50.4	74.0	23.6	-54.1	9.0	Passed	Y
BTLE	BLE0	4803.460	55.4	74.0	18.6	-49.2	9.0	Passed	Y
Average Emission – Restricted Band									
BT Mode	Channel	Frequency [MHz]	Field Strength [dBuV/m]	Average Limit [dBuV/m]	Margin [dB]	Reading [dBm]	Antenna Gain + Array Gain [dBi]	Result	Restricted Band?
BTLE	BLE0	2329.960	47.4	54.0	6.6	-58.2	9.0	Passed	Y
BTLE	BLE0	2497.950	43.6	54.0	10.4	-62.1	9.0	Passed	Y
BTLE	BLE0	4803.980	51.8	54.0	2.2	-53.8	9.0	Passed	Y
No emissions were found in the non-restricted Bands									

Spurious Emissions, channel 19 (Operation mode 2)									
Peak Emission – Restricted Band									
BT Mode	Channel	Frequency [MHz]	Field Strength [dBuV/m]	Max Peak Limit [dBuV/m]	Margin [dB]	Reading [dBm]	Antenna Gain + Array Gain [dBi]	Result	Restricted Band?
BTLE	BTLE19	2367.910	51.7	74.0	22.3	-52.9	9.0	Passed	Y
BTLE	BTLE19	4880.490	54.7	74.0	19.3	-49.8	9.0	Passed	Y
Average Emission – Restricted Band									
BT Mode	Channel	Frequency [MHz]	Field Strength [dBuV/m]	Average Limit [dBuV/m]	Margin [dB]	Reading [dBm]	Antenna Gain + Array Gain [dBi]	Result	Restricted Band?
BTLE	BTLE19	2367.900	45.8	54.0	8.2	-59.8	9.0	BTLE	Y
BTLE	BTLE19	4880.000	50.7	54.0	3.3	-54.9	9.0	BTLE	Y
Emissions in the non-restricted Bands									

Spurious Emissions, channel 39 (Operation mode 3)									
Peak Emission – Restricted Band									
BT Mode	Channel	Frequency [MHz]	Field Strength [dBuV/m]	Max Peak Limit [dBuV/m]	Margin [dB]	Reading [dBm]	Antenna Gain + Array Gain [dBi]	Result	Restricted Band?
BTLE	BTLE39	2383.840	52.5	74.0	21.5	-52.8	9.0	Passed	Y
BTLE	BTLE39	4960.210	55.0	74.0	19.0	-50.3	9.0	Passed	Y
Average Emission – Restricted Band									
BT Mode	Channel	Frequency [MHz]	Field Strength [dBuV/m]	Average Limit [dBuV/m]	Margin [dB]	Reading [dBm]	Antenna Gain + Array Gain [dBi]	Result	Restricted Band?
BTLE	BTLE39	2383.900	45.5	54.0	8.5	-59.8	9.0	Passed	Y
BTLE	BTLE39	4959.910	49.1	54.0	4.9	-56.3	9.0	Passed	Y
No emissions were found in the non-restricted Bands									

Test: **Passed**

TEST EQUIPMENT USED FOR THE TEST:
30

5.6.4 Method of measurement (radiated emissions)

The radiated emission measurement is subdivided into five stages.

- A preliminary measurement carried out in a fully anechoic chamber with a fixed antenna height in the frequency range 9 kHz to 1 GHz.
- A final measurement carried out on an outdoor test site without reflecting ground plane and a fixed antenna height in the frequency range 9 kHz to 30 MHz.
- A final measurement carried out on an open area test site with reflecting ground plane and various antenna height in the frequency range 30 MHz to 1 GHz.
- A preliminary measurement carried out in a fully anechoic chamber with a variable antenna distance and height in the frequency range above 1 GHz.
- A final measurement carried out in a fully anechoic chamber with a fixed antenna height in the frequency range above 1 GHz.

Preliminary measurement (9 kHz to 30 MHz):

In the first stage a preliminary measurement will be performed in a shielded room with a measuring distance of 3 meters. Table top devices will set up on a non-conducting turn device on the height of 1.5m. Floor-standing devices will be placed directly on the turntable/ground plane. The set-up of the Equipment under test will be in accordance to [1].

The frequency range 9 kHz to 30 MHz will be monitored with a spectrum analyser while the system and its cables will be manipulated to find out the configuration with the maximum emission levels if applicable. The EMI Receiver will be set to MAX Hold mode. The EUT and the measuring antenna will be rotated around their vertical axis to found the maximum emissions.

The resolution bandwidth of the spectrum analyser will be set to the following values:

Frequency range	Resolution bandwidth
9 kHz to 150 kHz	200 Hz
150 kHz to 30 MHz	10 kHz

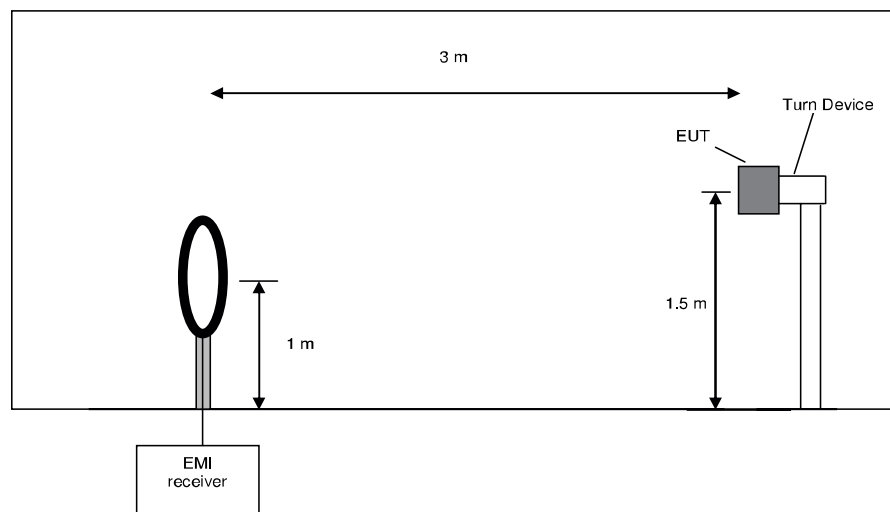

Preliminary measurement procedure:

Prescans were performed in the frequency range 9 kHz to 150 kHz and 150 kHz to 30 MHz.

Prescans were performed in the frequency range 30 MHz to 230 MHz and 230 MHz to 1 GHz.
The following procedure will be used:

1. Monitor the frequency range at horizontal polarisation and a EUT azimuth of 0 °.
2. Manipulate the system cables within the range to produce the maximum level of emission.
3. Rotate the EUT by 360 ° to maximize the detected signals.
4. Repeat 1) to 3) with the vertical polarisation of the measuring antenna.
5. Make a hardcopy of the spectrum.
6. Repeat 1) to 5) with the EUT raised by an angle of 0° (45°, 90°) according to 6.6.5.4 in [1].
7. Measure the frequency of the detected emissions with a lower span and resolution bandwidth to increase the accuracy and note the frequency value.

Final measurement (9 kHz to 30 MHz):

In the second stage a final measurement will be performed on an open area test site with no conducting ground plane in a measuring distances of 3 m, 10 m and 30 m. In the case where larger measuring distances are required the results will be extrapolated based on the values measured on the closer distances according to Section 15.31 (f) (2) [2]. The final measurement will be performed with a EMI Receiver set to Quasi Peak detector except for the frequency bands 9 kHz to 90 kHz and 110 kHz to 490 kHz where an average detector will be used according Section 15.209 (d) [2].

On the frequencies, which were detected during the preliminary measurements, the final measurement will be performed while rotating the EUT and the measuring antenna in the range of 0 ° to 360 ° around their vertical axis until the maximum value is found.

The resolution bandwidth of the EMI Receiver will be set to the following values:

Frequency range	Resolution bandwidth
9 kHz to 150 kHz	200 Hz
150 kHz to 30 MHz	9 kHz

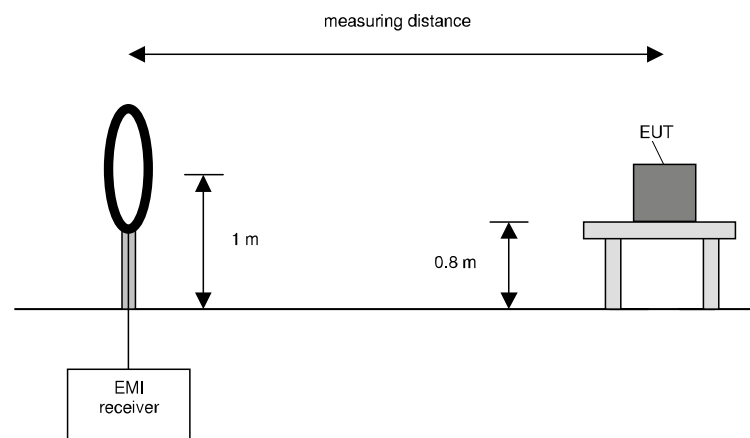

Final measurement procedure:

The following procedure will be used:

- 1) Monitor the frequency range with the measuring antenna at vertical orientation parallel to the EUT at an azimuth of 0 °.
- 2) Rotate the EUT by 360 ° to maximize the detected signals and note the azimuth and orientation.
- 3) Rotate the measuring antenna to find the maximum and note the value.
- 4) Rotate the measuring antenna and repeat steps 1) to 3) until the maximum value is found.
- 5) Repeat steps 1) to 4) with the other orthogonal axes of the EUT (if the EUT is a module and might be used in a handheld equipment application).

Preliminary measurement (30 MHz to 1 GHz)

In the first stage a preliminary measurement will be performed in a fully anechoic chamber with a measuring distance of 3 meter. Table top devices will set up on a non-conducting turn device on the height of 1.5m. Floor-standing devices will be placed directly on the turntable/ground plane. The set up of the Equipment under test will be in accordance to [1].

The frequency range 30 MHz to 1 GHz will be measured with an EMI Receiver set to MAX Hold mode and a resolution bandwidth of 100 kHz. The measurement will be performed in horizontal and vertical polarisation of the measuring antenna and while rotating the EUT in its vertical axis in the range of 0 ° to 360 °. This measurement is repeated after raising the EUT in 30° steps according 6.6.5.4 in [1].

The resolution bandwidth of the EMI Receiver will be set to the following values:

Frequency range	Resolution bandwidth
30 MHz to 230 MHz	100 kHz
230 MHz to 1 GHz	100 kHz

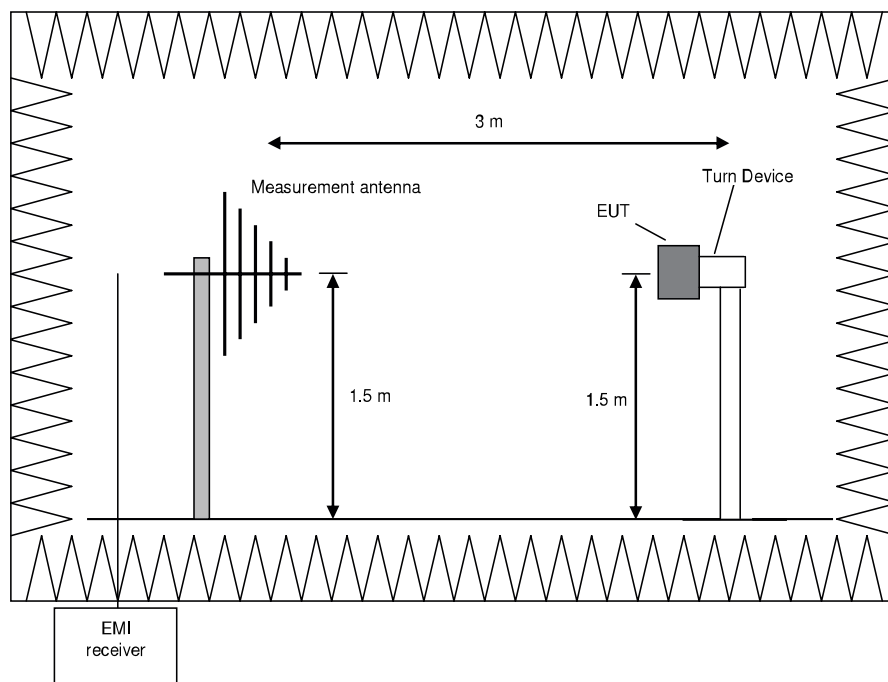

Procedure preliminary measurement:

Prescans were performed in the frequency range 30 MHz to 230 MHz and 230 MHz to 1 GHz.

The following procedure will be used:

8. Monitor the frequency range at horizontal polarisation and a EUT azimuth of 0 °.
9. Manipulate the system cables within the range to produce the maximum level of emission.
10. Rotate the EUT by 360 ° to maximize the detected signals.
11. Repeat 1) to 3) with the vertical polarisation of the measuring antenna.
12. Make a hardcopy of the spectrum.
13. Repeat 1) to 5) with the EUT raised by an angle of 0° (45°, 90°) according to 6.6.5.4 in [1].
14. Measure the frequency of the detected emissions with a lower span and resolution bandwidth to increase the accuracy and note the frequency value.

Final measurement (30 MHz to 1 GHz)

A final measurement on an open area test site will be performed on selected frequencies found in the preliminary measurement. During this test the EUT will be rotated in the range of 0 ° to 360 °, the measuring antenna will be set to horizontal and vertical polarisation and raised and lowered in the range from 1 m to 4 m to find the maximum level of emissions.

The resolution bandwidth of the EMI Receiver will be set to the following values:

Frequency range	Resolution bandwidth
30 MHz to 1 GHz	120 kHz

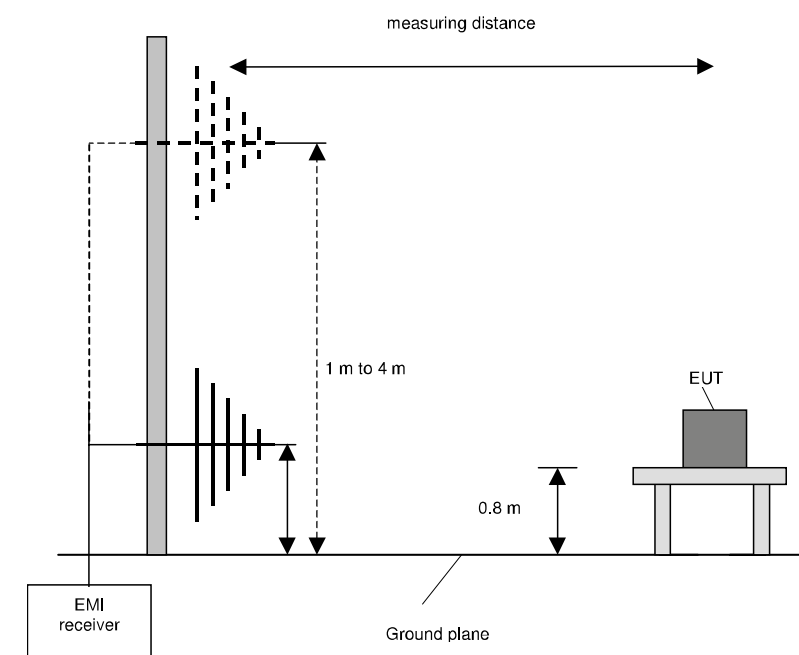

Procedure final measurement:

The following procedure will be used:

- 1) Measure on the selected frequencies at an antenna height of 1 m and a EUT azimuth of 23 °.
- 2) Move the antenna from 1 m to 4 m and note the maximum value at each frequency.
- 3) Rotate the EUT by 45 ° and repeat 2) until an azimuth of 337 ° is reached.
- 4) Repeat 1) to 3) for the other orthogonal antenna polarization.
- 5) Move the antenna and the turntable to the position where the maximum value is detected.
- 6) Measure while moving the antenna slowly +/- 1 m.
- 7) Set the antenna to the position where the maximum value is found.
- 8) Measure while moving the turntable +/- 45 °.
- 9) Set the turntable to the azimuth where the maximum value is found.
- 10) Measure with Final detector (QP and AV) and note the value.
- 11) Repeat 5) to 10) for each frequency.
- 12) Repeat 1) to 11) for each orthogonal axes of the EUT (because of EUT is a module and might be used in a handheld equipment application).

Preliminary and final measurement (1 GHz to 40 GHz)

This measurement will be performed in a fully anechoic chamber. Table top devices will set up on a non-conducting turn device on the height of 1.5m. The set-up of the Equipment under test will be in accordance to [1].

Preliminary measurement (1 GHz to 40 GHz)

The frequency range will be divided into different sub ranges depending of the frequency range of the used horn antenna. The spectrum analyser set to MAX Hold mode and a resolution bandwidth of 100 kHz. The measurement will be performed in horizontal and vertical polarisation of the measuring antenna and while rotating the EUT in its vertical axis in the range of 0 ° to 360 °. This measurement is repeated after raising the EUT in 30° steps according 6.6.5.4 in [1].

The resolution bandwidth of the EMI Receiver will be set to the following values:

Frequency range	Resolution bandwidth
1 GHz to 4 GHz	100 kHz
4 GHz to 12 GHz	100 kHz
12 GHz to 18 GHz	100 kHz
18 GHz to 25 / 26.5 GHz	100 kHz
26.5 GHz to 40 GHz	100 kHz

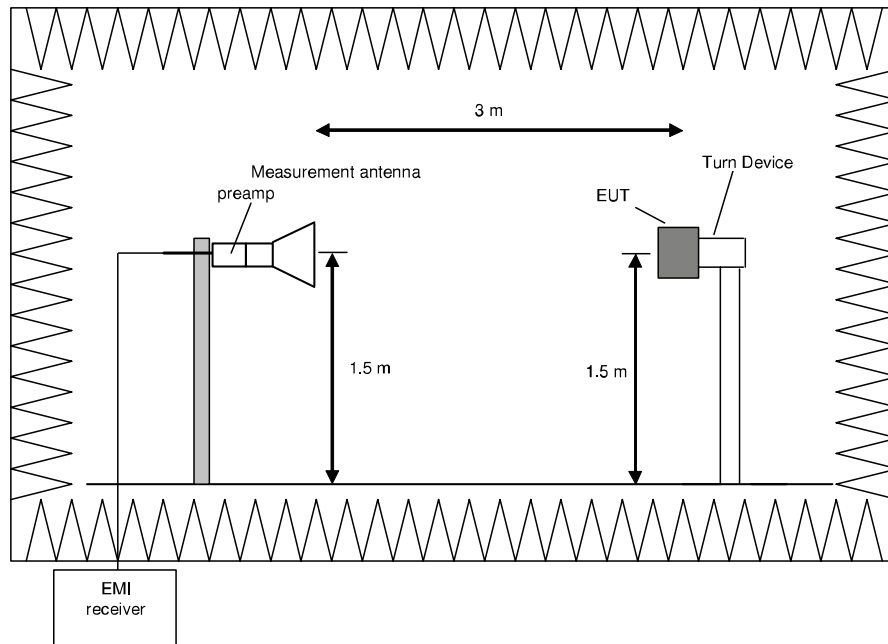

Procedure preliminary measurement:

Prescans were performed in the frequency range 1 to 40 GHz.

The following procedure will be used:

1. Monitor the frequency range at horizontal polarisation and a EUT azimuth of 0 °.
2. Rotate the EUT by 360° to maximize the detected signals.
3. Repeat 1) to 2) with the vertical polarisation of the measuring antenna.
4. Make a hardcopy of the spectrum.
5. Repeat 1) to 4) with the EUT raised by an angle of 30° (60°, 90°, 120° and 150°) according to 6.6.5.4 in [1].
6. Measure the frequency of the detected emissions with a lower span and resolution bandwidth to increase the accuracy and note the frequency value.
7. The measurement antenna polarisation, with the according EUT position (Turntable and Turn device) which produces the highest emission for each frequency will be used for the final measurement. The six closest values to the applicable limit will be used for the final measurement.

Final measurement (1 GHz to 40 GHz)

The frequency range will be divided into different sub ranges depending of the frequency range of the used horn antenna. The EMI Receiver set to peak and average mode and a resolution bandwidth of 1 MHz. The measurement will be performed by rotating the turntable through 0 to 360° in the worst-case EUT orientation which was obtained during the preliminary measurements.

The resolution bandwidth of the EMI Receiver will be set to the following values:

Frequency range	Resolution bandwidth
1 GHz to 4 GHz	1 MHz
4 GHz to 12 GHz	1 MHz
12 GHz to 18 GHz	1 MHz
18 GHz to 25 / 26.5 GHz	1 MHz
26.5 GHz to 40 GHz	1 MHz

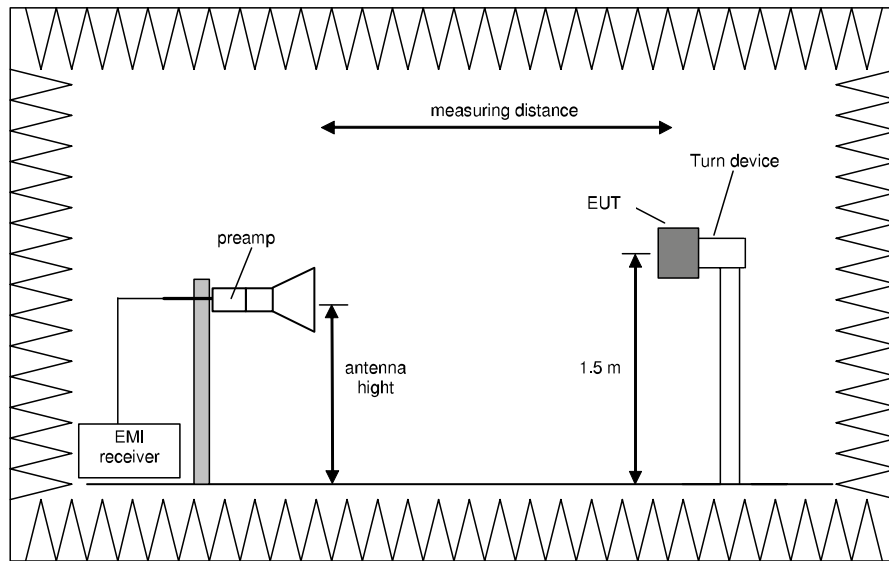

Procedure of measurement:

The measurements were performed in the frequency ranges 1 GHz to 4 GHz, 4 GHz to 12 GHz, 12 GHz to 18 GHz, 18 GHz to 25 /26.5 GHz and 26.5 GHz to 40 GHz.

The following procedure will be used:

- 1) Set the turntable and the turn device to obtain the worst-case emission for the first frequency identified in the preliminary measurements.
- 2) Set the measurement antenna polarisation to the orientation with the highest emission for the first frequency identified in the preliminary measurements.
- 3) Set the spectrum analyser to EMI mode with peak and average detector activated.
- 4) Rotate the turntable from 0° to 360° to find the TT Pos. that produces the highest emissions.
- 5) Note the highest displayed peak and average values
- 6) Repeat the steps 1) to 5) for each frequency detected during the preliminary measurements.

5.6.5 Test results (radiated emissions) – cabinet emissions

5.6.5.1 Preliminary radiated emission measurement

Ambient temperature	22 °C	Relative humidity	59 %
---------------------	-------	-------------------	------

- Position of EUT:** The EUT was set-up on an EUT turn device of a height of 1.5 m. The distance between EUT and antenna was 3 m.
- Cable guide:** For detail information of test set-up and the cable guide refer to the pictures in the annex A in the test report.
- Test record:** No radiated emissions at the band edges were found during the preliminary radiated measurements, therefore no plots and final results are submitted below.
- Supply voltage:** During all measurements the host of the EUT was powered with 24 V via an AC/DC Adapter.
- Remark:** Document [3] states in 12.7.4.2, that in case of conducted measurements, additional radiated cabinet emission measurements must be performed. All radiated emissions were performed with the worst case antenna configuration, namely the “ANT-DIR-2459-01” antenna.
- The emissions from 150 kHz to 1 MHz did not originate from the radio part of the EUT, therefore these emissions are not documented in the final results. The tests were repeated with an EUT with deactivated RF stack, which was provided by the applicant. The results were equal to the results of the EUT with active RF transmission.

5.6.5.2 Final radiated measurements

Transmitter operates at the lower end of the assigned frequency band (operation mode 1)

Result measured with the peak detector:

Frequency MHz	Meas. Result dB μ V/m	Limit dB μ V/m	Margin dB	Readings dB μ V	Antenna factor 1/m	Preamp dB	Cable loss dB	Height cm	Pol.	TT Pos.
4803.5	55.1	74.0	18.9	43.0	32.6	24.9	4.4	150	Hor.	133°
7206.8	54.3	74.0	19.7	37.2	35.7	24.1	5.4	150	Vert.	70°
9607	56.2	74.0	17.8	36.5	37.3	23.9	6.3	150	Hor.	126°
Measurement uncertainty				+2.2 dB / -3.6 dB						

Result measured with the average detector:

Frequency MHz	Meas. Result dB μ V/m	Limit dB μ V/m	Margin dB	Readings dB μ V	Antenna factor 1/m	Preamp dB	Cable loss dB	Height cm	Pol.	TT Pos.
4803.50	47.9	54.0	6.1	35.8	32.6	24.9	4.4	150	Hor.	93°
7206.80	44.0	54.0	10.0	26.9	35.7	24.1	5.4	150	Vert.	66°
9607.00	45.9	54.0	8.1	26.2	37.3	23.9	6.3	150	Hor.	126°
+2.2 dB / -3.6 dB				+2.2 dB / -3.6 dB						

Transmitter operates at the middle of the assigned frequency band (operation mode 2)

Result measured with the peak detector:

Frequency MHz	Meas. Result dB μ V/m	Limit dB μ V/m	Margin dB	Readings dB μ V	Antenna factor 1/m	Preamp dB	Cable loss dB	Height cm	Pol.	TT Pos.
4880.5	52.9	74.0	21.1	40.8	32.8	25.1	4.4	150	Hor.	70°
7320.8	53.2	74.0	20.8	35.4	36.2	23.9	5.5	150	Vert.	54°
9760.1	53.1	74.0	20.9	32.9	37.3	23.4	6.4	150	Hor.	160°
17081.7	44.3	74.0	29.7	36.5	33.8	28.2	2.2	150	Vert.	127°
Measurement uncertainty					+2.2 dB / -3.6 dB					

Result measured with the average detector:

Frequency MHz	Meas. Result dB μ V/m	Limit dB μ V/m	Margin dB	Readings dB μ V	Antenna factor 1/m	Preamp dB	Cable loss dB	Height cm	Pol.	TT Pos.
4880.50	45.2	54.0	8.8	33.1	32.8	25.1	4.4	150	Hor.	87°
7320.80	42.3	54.0	11.7	24.5	36.2	23.9	5.5	150	Hor.	79°
9760.10	41.1	54.0	12.9	20.9	37.3	23.4	6.4	150	Hor.	160°
17081.70	33.1	54.0	20.9	25.3	33.8	28.2	2.2	150	Vert.	127°
+2.2 dB / -3.6 dB					+2.2 dB / -3.6 dB					

Transmitter operates at the upper end of the assigned frequency band (operation mode 3)

Result measured with the peak detector:

Frequency MHz	Meas. Result dB μ V/m	Limit dB μ V/m	Margin dB	Readings dB μ V	Antenna factor 1/m	Preamp dB	Cable loss dB	Height cm	Pol.	TT Pos.
4959.5	54.9	74.0	19.1	42.8	32.9	25.2	4.4	150	Hor.	93°
7439.2	53.7	74.0	20.3	36.0	36.3	24.1	5.5	150	Hor.	86°
9918.9	56.5	74.0	17.5	36.2	37.4	23.5	6.4	150	Hor.	45°
Measurement uncertainty					+2.2 dB / -3.6 dB					

Result measured with the average detector:

Frequency MHz	Meas. Result dB μ V/m	Limit dB μ V/m	Margin dB	Readings dB μ V	Antenna factor 1/m	Preamp dB	Cable loss dB	Height cm	Pol.	TT Pos.
4959.50	47.6	54.0	6.4	35.5	32.9	25.2	4.4	150	Hor.	93°
7439.20	43.5	54.0	10.5	25.8	36.3	24.1	5.5	150	Hor.	78°
9918.90	46.7	54.0	7.3	26.4	37.4	23.5	6.4	150	Hor.	52°
+2.2 dB / -3.6 dB					+2.2 dB / -3.6 dB					

5.6.5.3 Preliminary radiated emission measurement at the band edges

Ambient temperature	22 °C	Relative humidity	59 %
---------------------	-------	-------------------	------

Position of EUT: The EUT was set-up on an EUT turn device of a height of 1.5 m. The distance between EUT and antenna was 3 m.

Cable guide: For detail information of test set-up and the cable guide refer to the pictures in the annex A in the test report.

Supply voltage: During all measurements the host of the EUT was powered with 24 V via an AC/DC Adapter.

Remark: Document [3] states in 12.7.4.2, that in case of conducted measurements, additional radiated cabinet emission measurements must be performed. All radiated emissions were performed with the worst case antenna configuration, namely the "ANT-DIR-2459-01" antenna.

No Emissions were found in the frequency range below 2.39 GHz (as can be seen in the plot below), therefore no emissions were measured in that frequency range.

Transmitter operates at the lower end of the assigned frequency band (operation mode 1)

161419_ch0_BandEdgeUnRestr_0°.wmf: Band Edge Emissions – Lower band-edge (operation mode 1):

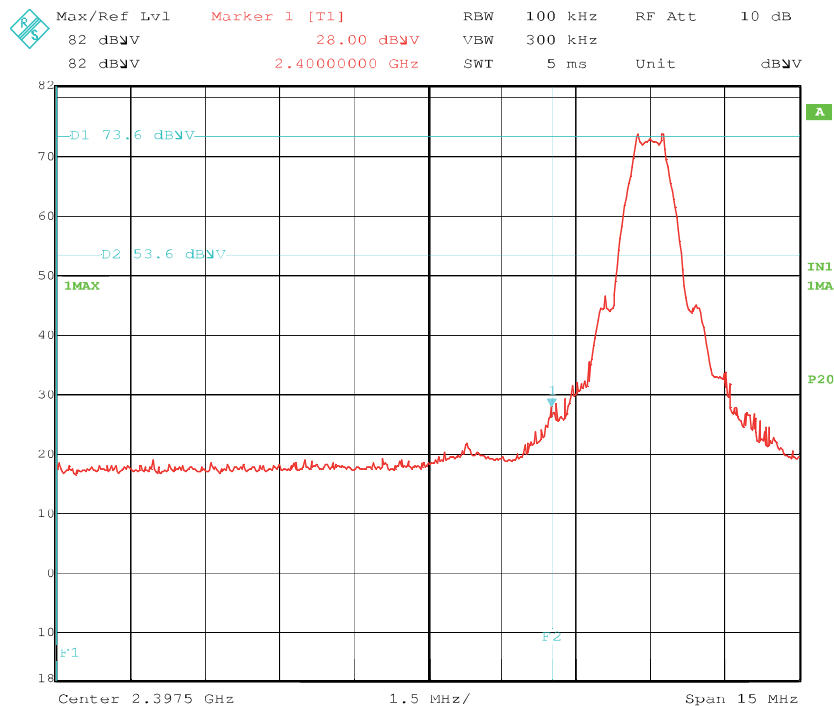

161419_ch39_BandEdgeRestr_90°.wmf: Band Edge Emissions – Upper band-edge (operation mode 3):

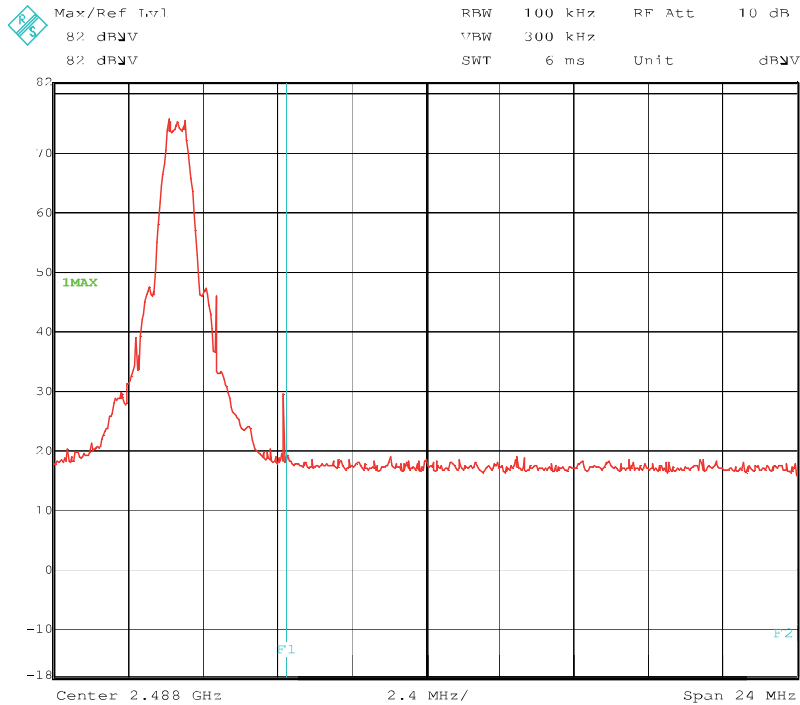

Transmitter operates at the lower end of the assigned frequency band (operation mode 1)

BT Mode	BT Channel	Emission Frequency [MHz]	Reference Level [dBμV]	Limit [dBμV]	Emission Level [dBm]	Margin [dB]	Result
BTLE	BT1	2400.000	73.6	53.6	28.0	25.6	Passed

Transmitter operates at the upper end of the assigned frequency band (operation mode 3)

Result measured with the peak detector:

Frequency MHz	Meas. Result dBμV/m	Limit dBμV/m	Margin dB	Readings dBμV	Antenna factor 1/m	Preamp dB	Cable loss dB	Height cm	Pol.	TT Pos.
2484.0	68.4	74.00	5.6	36.0	28.6	0.0	3.8	150	Hor.	360°
Measurement uncertainty				+2.2 dB / -3.6 dB						

Result measured with the average detector:

Frequency MHz	Meas. Result dBμV/m	Limit dBμV/m	Margin dB	Readings dBμV	Antenna factor 1/m	Preamp dB	Cable loss dB	Height cm	Pol.	TT Pos.
2484.0	46.8	54.0	7.2	14.4	28.6	0.0	3.8	150	Hor.	360°
+2.2 dB / -3.6 dB				+2.2 dB / -3.6 dB						

TEST EQUIPMENT USED FOR THE TEST:
29, 31 - 39, 41 - 51

5.7 Conducted emissions on power supply lines (150 kHz to 30 MHz)

Ambient temperature	20 °C	Relative humidity	52 %
---------------------	-------	-------------------	------

- Position of EUT:** For this test a pair of EUTs, which were already paired, were set up to operate in normal mode. Normal mode means, the EUTs were continuously exchanging the status of their analogue and digital Inputs during the test with a repetition mode of 10 Hz.
- Cable guide:** For detail information of test set-up and the cable guide refer to the pictures in annex A of this test report.
- Test record:** All results are shown in the following.
- Supply voltage:** Measurement performed with US 120V/60Hz. For the test a power supply type "MINI-PS-100-240AC/24DC/1.3" by Phoenix Contact was used. The power supply provided 24 V DC.

The curves in the diagram only represent for each frequency point the maximum measured value of all preliminary measurements which were made for each power supply line. The top measured curve represents the peak measurement and the bottom measured curve the average measurement. The quasi-peak measured points are marked by "∧" and the average measured points by "+".

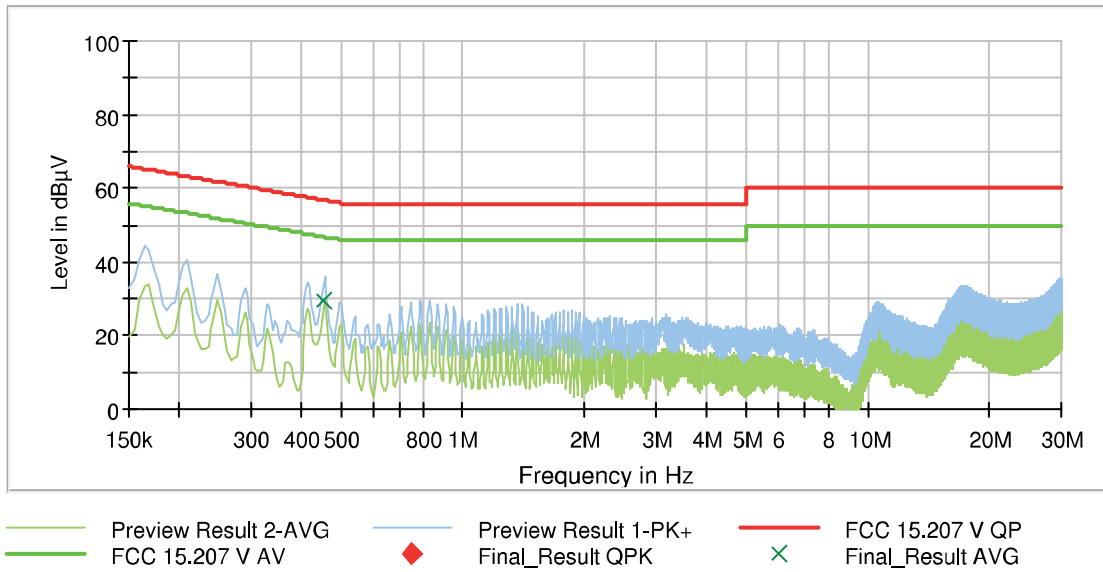

Data record name: 161419_PLCond.Rtf

Final Result

Frequency (MHz)	QuasiPeak (dBµV)	Average (dBµV)	Limit (dBµV)	Margin (dB)	Meas. Time (ms)	Bandwidth (kHz)	Line	PE	Corr. (dB)
0.454200	---	29.63	46.80	17.17	5000.0	9.000	L1	GND	9.9

Test: Passed

TEST EQUIPMENT USED FOR THE TEST:

1 – 5

6 Test equipment and ancillaries used for tests

No.	Test equipment	Type	Manufacturer	Serial No.	PM. No.	Cal. Date	Cal. Due
1	Shielded chamber M47	-	Albatross Projects	B83117-C6439-T262 -	480662	Weekly verification (system cal.)	
2	EMI Receiver	ESIB 26	Rohde & Schwarz	1088.7490	481182	15.02.2016	15.02.2018
3	LISN	NSLK8128	Schwarzbeck	8128155	480058	16.02.2016	16.02.2018
4	High pass filter	HR 0.13- 5ENN	FSY Microwave Inc.	DC 0109 SN 002	480340	Weekly verification (system cal.)	
5	EMI Software	ES-K1	Rohde & Schwarz	-	480111	-	-
29	Fully anechoic chamber M20	-	Albatross Projects	B83107-E2439-T232	480303	Weekly verification (system cal.)	
30	Spectrum analyser	FSU	Rohde & Schwarz	200125	480956	17.02.2016	17.02.2017
31	Measuring receiver	ESI 40	Rohde & Schwarz	100064	480355	16.04.2016	16.04.2017
32	Controller	MCU	Maturo	MCU/043/971107	480832	-	-
33	Turntable	DS420HE	Deisel	420/620/80	480315	-	-
34	Antenna support	AS615P	Deisel	615/310	480187	-	-
36	Antenna	3115 A	EMCO	9609-4918	480183	10.11.2014	10.11.2016
37	Standard Gain Horn 11.9 GHz – 18 GHz	18240-20	Flann Microwave	483	480294	Six month verification (system cal.)	
39	Standard Gain Horn 17.9 GHz – 26.7 GHz	20240-20	Flann Microwave	411	480297	Six month verification (system cal.)	
40	Standard Gain Horn Antenne 26.4 – 40.1 GHz	22240-20	Flann Microwave	469	480299	Six month verification (system cal.)	
41	RF-cable No. 3	Sucoflex 106B	Huber&Suhner	0563/6B / Kabel 3	480670	Weekly verification (system cal.)	
42	RF-cable No. 40	Sucoflex 106B	Huber&Suhner	0708/6B / Kabel 40	481330	Weekly verification (system cal.)	
43	Loop antenna	HFH2-Z2	Rohde & Schwarz	832609/014	480059	29.02.2016	29.02.2018
44	Antenna	CBL6112 B	Chase	2688	480328	14.04.2014	14.04.2017
46	RF-cable 2 m	KPS-1533- 800-KPS	Insulated Wire	-	480302	Six month verification (system cal.)	
49	Preamplifier	JS3- 00101200- 23-5A	Miteq	681851	480337	18.02.2016	18.02.2018
50	Preamplifier	JS3- 12001800- 16-5A	Miteq	571667	480343	18.02.2016	18.02.2018
51	Preamplifier	JS3- 18002600- 20-5A	Miteq	658697	480342	17.02.2016	17.02.2018
60	Power Meter	NRVD	Rohde & Schwarz	833697/030	480589	18.02.2016	18.02.2018
61	Peak Power Sensor	NRV-Z32	Rohde & Schwarz	849745/016	480551	18.02.2016	18.02.2018
72	4 GHz High Pass Filter	WHKX4.0/18 G-8SS	Wainwright Instruments	1	480587	Weekly verification (system cal.)	

7 Report History

Report Number	Date	Comment
F161419E3	30.11.2016	Initial Test Report
F161419E3 2 nd Version	17.01.2017	Change of HVIN to ILB BT ADIO MUX
F161419E3 3 rd Version	06.02.2017	Adding antenna to antenna list, changes in antenna list

8 List of Annexes

ANNEX A	TEST SETUP PHOTOS	8 pages
	161419_01.jpg	Test setup - conducted tests
	161419_07.jpg	Test setup - Radiated emission anechoic chamber
	161419_08.jpg	Test setup - Radiated emission anechoic chamber
	161419_09.jpg	Test setup - Radiated emission anechoic chamber
	161419_10.jpg	Test setup - Radiated emission anechoic chamber
	161419_11.jpg	Test setup - Radiated emission anechoic chamber
	161419_12.jpg	Test setup - Radiated emission anechoic chamber
	161419_18.jpg	Test setup – conducted emissions on power supply lines
ANNEX B	EXTERNAL PHOTOS	2 pages
	161419_02.jpg	EUT – 3D top view
	161419_03.jpg	EUT – 3D bottom view
ANNEX C	INTERNAL PHOTOS	3 page
	161419_04.jpg	EUT – inside view
	161419_05.jpg	Main PCB – top view
	161419_06.jpg	Main PCB – bottom view