



PHOENIX
TESTLAB

Königswinkel 10
32825 Blomberg, Germany
Phone: +49 (0) 52 35 / 95 00-0
Fax: +49 (0) 52 35 / 95 00-10
office@phoenix-testlab.de
www.phoenix-testlab.de

Test Report

Report Number:

F161629E2 3rd Version

Equipment under Test (EUT):

**WLAN module
SX-PCEAN2C**

Applicant:

PHOENIX CONTACT Electronics GmbH

Manufacturer:

PHOENIX CONTACT Electronics GmbH



Deutsche
Akkreditierungsstelle
D-PL-17186-01-01
D-PL-17186-01-02
D-PL-17186-01-03

References

- [1] **ANSI C63.10-2013**, American National Standard of Procedures for Compliance Testing of Unlicensed Wireless Devices
- [2] **FCC CFR 47 Part 15 (April 2017)**, Radio Frequency Devices
- [3] **RSS-247 (March 2017)**, Digital Transmission Systems (DTSs), Frequency Hopping Systems (FHSs) and Licence-Exempt Local Area Network (LE-LAN) Devices
- [4] **RSS-Gen Issue 4 (November 2014)**, General Requirements for Compliance of Radio Apparatus

Test Result

The requirements of the tests performed as shown in the overview (clause 4) were fulfilled by the equipment under test. The complete test results are presented in the following.

tested and
written by:

Paul NEUFELD

Name



Signature

20.04.2017

Date

Authorized
reviewer:

Bernd STEINER

Name



Signature

20.04.2017

Date

This test report is only valid in its original form.

Any reproduction of its contents in extracts without written permission of the accredited test laboratory PHOENIX TESTLAB GmbH is prohibited.

The test results herein refer only to the tested sample. PHOENIX TESTLAB GmbH is not responsible for any generalisations or conclusions drawn from these test results concerning further samples. Any modification of the tested samples is prohibited and leads to the invalidity of this test report. Each page necessarily contains the PHOENIX TESTLAB Logo and the TEST REPORT NUMBER.

Contents:	Page
1 Identification.....	4
1.1 Applicant.....	4
1.2 Manufacturer.....	4
1.3 Test Laboratory.....	4
1.4 EUT (Equipment Under Test).....	5
1.5 Technical Data of Equipment.....	7
1.6 Dates.....	7
2 Operational States.....	8
3 Additional Information.....	9
4 Overview.....	10
5 Results.....	11
5.1 Duty cycle.....	11
5.2 Maximum conducted output power.....	14
5.3 UNII Bandwidth.....	17
5.4 Peak Power Spectral Density.....	21
5.5 Band-edge compliance.....	24
5.6 Maximum unwanted emissions.....	32
5.7 Conducted emissions on power supply lines (150 kHz to 30 MHz).....	104
6 Test Equipment.....	107
7 Report History.....	108
8 List of Annexes.....	108

1 Identification

1.1 Applicant

Name:	PHOENIX CONTACT Electronics GmbH
Address:	Dringenauer Str. 30 31812 Bad Pyrmont
Country:	Germany
Name for contact purposes:	Andreas Pape
Phone:	+49 5281 9 46-1545
Fax:	+49 5281 9 46-2398
eMail Address:	apape@phoenixcontact.com
Applicant represented during the test by the following person:	none

1.2 Manufacturer

Name:	PHOENIX CONTACT Electronics GmbH
Address:	Dringenauer Str. 30 31812 Bad Pyrmont
Country:	Germany
Name for contact purposes:	Andreas Pape
Phone:	+49 5281 9 46-1545
Fax:	+49 5281 9 46-2398
eMail Address:	apape@phoenixcontact.com
Applicant represented during the test by the following person:	none

1.3 Test Laboratory

The tests were carried out by: **PHOENIX TESTLAB GmbH**
Königswinkel 10
32825 Blomberg
Germany

Accredited by *Deutsche Akkreditierungsstelle GmbH* in compliance with
DIN EN ISO/IEC 17025 under Reg. No. < **D-PL-17186-01-02** >.

1.4 EUT (Equipment Under Test)

Test object: *	WLAN module
Model / PMN: *	SX-PCEAN2
FCC ID: *	YG3-SXPCEAN2
IC Company number / UPN: *	4720B-SXPCEAN2
HVIN:*	SX-PCEAN2
HMN:*	-
Order number: *	Not applicable
Serial number: *	EUT 1: M7007690 (antenna port conducted measurements) EUT 2: M7019820 (radiated measurements)
PCB identifier: *	PW101650BX
Hardware version / FVIN: *	ZXE0326301* ²
Software version (Radiated test mode): *	0.00.20_ALPHA_TX99
Software version (Final Version): *	1.00

* Declared by the applicant

*² The manufacturer does not provide a hardware-version, but instead updates the order number of the WLAN module. Therefore the order number is submitted here.

802.11 a/n20 channels

Channel 36	RX:	5180 MHz	TX:	5180 MHz
Channel 40	RX:	5200 MHz	TX:	5200 MHz
Channel 44	RX:	5220 MHz	TX:	5220 MHz
Channel 48	RX:	5240 MHz	TX:	5240 MHz
Channel 149	RX:	5745 MHz	TX:	5745 MHz
Channel 153	RX:	5765 MHz	TX:	5765 MHz
Channel 157	RX:	5785 MHz	TX:	5785 MHz
Channel 161	RX:	5805 MHz	TX:	5805 MHz
Channel 165	RX:	5825 MHz	TX:	5825 MHz

02.11 n40 channels

Channel 38	RX:	5190 MHz	TX:	5190 MHz
Channel 46	RX:	5230 MHz	TX:	5230 MHz
Channel 151	RX:	5755 MHz	TX:	5755 MHz
Channel 159	RX:	5795 MHz	TX:	5795 MHz

Ancillary Equipment:

Evaluation Board:	9068231_02 by Phoenix Contact Electronics GmbH*
Cables:	Ethernet cable* Serial cable (USB-plug)* Power Supply cable*
Usb to serial adapter	DIGITUS DA-70156 serial to USB adapter
Laptop:	Fujitsu S7220

*Provided by the applicant

1.5 Technical Data of Equipment

Fulfills WLAN specification: *	IEEE, 802.11a, 802.11n HT20 + HT40,					
Antenna type: *	Directional antenna (EUT ant port 0) Omnidirectional antenna (EUT ant port 1)					
Antenna name: *	2JZ0102 (EUT ant port 0) 2JZ0102 (EUT ant port 1)					
Antenna gain: *	5 dBi peak (EUT ant port 0) 2 dBi peak (EUT ant port 1) 3.8 dBi (Directional gain with ant. Port 0&1 combined – calculated according to ANSI C63.10 clause 14.4.3.2.4 b)					
Antenna connector: *	U.FL					
Power supply:	DC					
Supply voltage Evaluation Board:	U _{nom} =	24.0 V DC	U _{min} =	18.0 V DC	U _{max} =	32.0 V DC
Power supply:	DC					
Supply voltage WLAN module:	U _{nom} =	3.3 V DC	U _{min} =	2.805 V DC	U _{max} =	3.795 V DC
Type of modulation: *	802.11a: OFDM 802.11n: OFDM					
Operating frequency range:*	2412 MHz to 2462 MHz, 5180 MHz to 5240 MHz, 5745 MHz to 5825 MHz					
Number of channels: *	21 (802.11 a/n20), 9 (802.11 n40)					
Temperature range: *	0°C to 60°C					
Lowest / highest internal clock frequency: *	32 kHz / 5825 MHz					

1.6 Dates

Date of receipt of test sample:	05.10.2016
Start of test:	05.10.2016
End of test:	27.01.2017

2 Operational States

The EUT is MIMO WLAN module for integration into various hosts. The EUT operates in the 2.4 GHz und 5 GHz bands. This test report shows the results of the 5 GHz band only.

The test modes were set using an ancillary laptop with software called "Atheros Radio Test 2 (artgui.exe)", which was connected to the EUT via Ethernet connection.

The following operation modes were identified as worst case condition and used during the tests:

Operation mode	Description of the operation mode	Antenna port	WLAN channel	WLAN mode	Data rate / Mbps
1	Continuous transmitting on 5180 MHz	0	36	802.11a	9 Mbps
2	Continuous transmitting on 5200 MHz	0	40	802.11a	9 Mbps
3	Continuous transmitting on 5240 MHz	0	48	802.11a	9 Mbps
4	Continuous transmitting on 5745 MHz	0	149	802.11a	9 Mbps
5	Continuous transmitting on 5785 MHz	0	157	802.11a	9 Mbps
6	Continuous transmitting on 5825 MHz	0	165	802.11a	9 Mbps
7	Continuous transmitting on 5180 MHz	1	36	802.11a	9 Mbps
8	Continuous transmitting on 5200 MHz	1	40	802.11a	9 Mbps
9	Continuous transmitting on 5240 MHz	1	48	802.11a	9 Mbps
10	Continuous transmitting on 5745 MHz	1	149	802.11a	9 Mbps
11	Continuous transmitting on 5785 MHz	1	157	802.11a	9 Mbps
12	Continuous transmitting on 5825 MHz	1	165	802.11a	9 Mbps
13	Continuous transmitting on 5180 MHz	0	36	802.11n20	6.5 Mbps
14	Continuous transmitting on 5200 MHz	0	40	802.11n20	6.5 Mbps
15	Continuous transmitting on 5240 MHz	0	48	802.11n20	6.5 Mbps
16	Continuous transmitting on 5745 MHz	0	149	802.11n20	6.5 Mbps
17	Continuous transmitting on 5785 MHz	0	157	802.11n20	6.5 Mbps
18	Continuous transmitting on 5825 MHz	0	165	802.11n20	6.5 Mbps
19	Continuous transmitting on 5180 MHz	1	36	802.11n20	6.5 Mbps
20	Continuous transmitting on 5200 MHz	1	40	802.11n20	6.5 Mbps
21	Continuous transmitting on 5240 MHz	1	48	802.11n20	6.5 Mbps
22	Continuous transmitting on 5745 MHz	1	149	802.11n20	6.5 Mbps
23	Continuous transmitting on 5785 MHz	1	157	802.11n20	6.5 Mbps
24	Continuous transmitting on 5825 MHz	1	165	802.11n20	6.5 Mbps
25	Continuous transmitting on 5180 MHz	0&1	36	802.11n20	13 Mbps
26	Continuous transmitting on 5200 MHz	0&1	40	802.11n20	13 Mbps
27	Continuous transmitting on 5240 MHz	0&1	48	802.11n20	13 Mbps
28	Continuous transmitting on 5745 MHz	0&1	149	802.11n20	13 Mbps
29	Continuous transmitting on 5785 MHz	0&1	157	802.11n20	13 Mbps
30	Continuous transmitting on 5825 MHz	0&1	165	802.11n20	13 Mbps
31	Continuous transmitting on 5190 MHz	0	38	802.11n40	13 Mbps
32	Continuous transmitting on 5210 MHz	0	42	802.11n40	13 Mbps
33	Continuous transmitting on 5755 MHz	0	151	802.11n40	13 Mbps
34	Continuous transmitting on 5795 MHz	0	159	802.11n40	13 Mbps

35	Continuous transmitting on 5190 MHz	1	38	802.11n40	13 Mbps
36	Continuous transmitting on 5210 MHz	1	42	802.11n40	13 Mbps
37	Continuous transmitting on 5755 MHz	1	151	802.11n40	13 Mbps
38	Continuous transmitting on 5795 MHz	1	159	802.11n40	13 Mbps
39	Continuous transmitting on 5190 MHz	0&1	38	802.11n40	26 Mbps
40	Continuous transmitting on 5210 MHz	0&1	42	802.11n40	26 Mbps
41	Continuous transmitting on 5755 MHz	0&1	151	802.11n40	26 Mbps
42	Continuous transmitting on 5795 MHz	0&1	159	802.11n40	26 Mbps

Power Settings for all measurements:

	Channel 36 – 48	Channel 149 - 165
802.11a	12.5	12.5
802.11n20	13.5	13.0
802.11n40	11.5	11.0

3 Additional Information

All tests were performed with unmodified samples.

For the conducted tests, both antenna ports were calculated with 5 dBi antenna where applicable, since this is the worst case.

EUT:

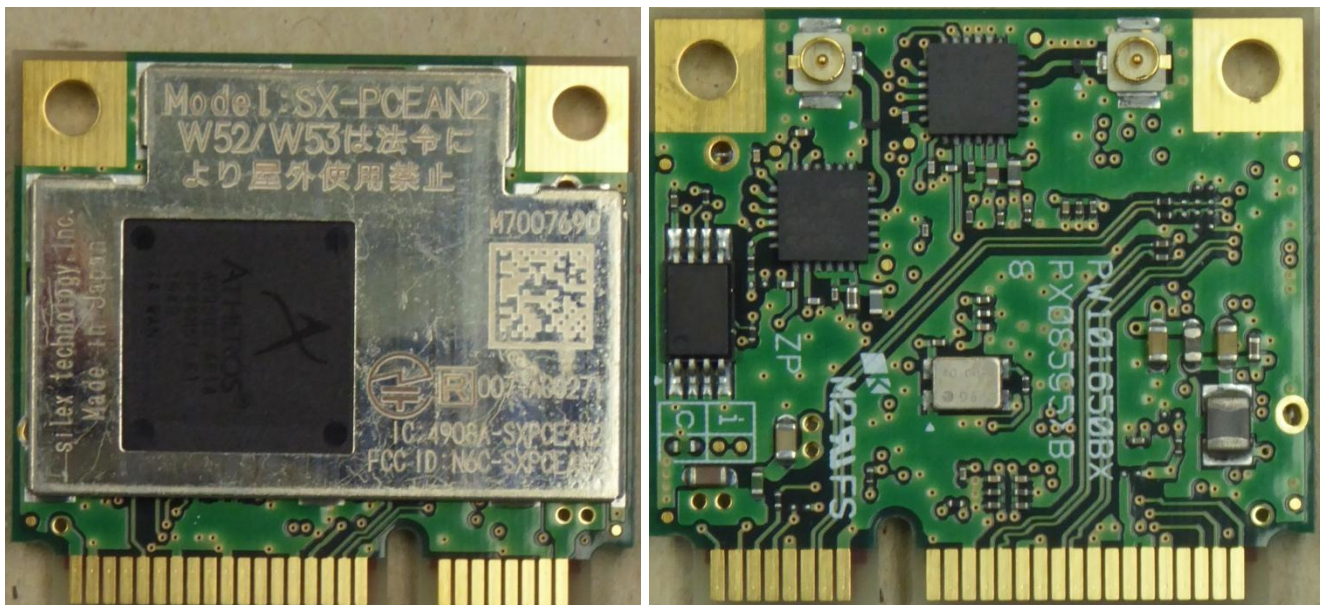

4 Overview

Application	Frequency range [MHz]	FCC 47 CFR Part 15 section [2]	RSS-247 [3] or RSS-Gen, Issue 4 [4]	Status	Refer page
Maximum Peak Output Power	5150 – 5250 5725 - 5850	15.407 (a)	6.2.1 (1)[3] 6.2.4 (1)[3]	Passed	13 et seq
UNII Bandwidth	5150 – 5250 5725 - 5850	15.403 (i)	- 6.2.4 (1) [3]	Passed	17 et seq
Peak Power Spectral Density	5150 – 5250 5725 - 5850	15.407 (a)(5)	6.2.1 (1)[3] 6.2.4 (1)[3]	Passed	21 et seq
Frequency Stability	5150 – 5250	15.407 (g)	-	Passed	24 et seq.
Band edge compliance	5150 – 5250 5725 - 5850	15.407 (b)	6.2.1 (2)[3] 6.2.4 (2)[3]	Passed	32 et seq.
Radiated emissions (transmitter)	0.009 - 40,000	15.407 (b) 15.205 (a) 15.209 (a)	8.9 [4], 6.2.1 (2)[3] 6.2.4 (2)[3]	Passed	32 et seq.
Conducted emissions on supply line	0.15 - 30	15.207 (a)	8.8 [4]	Passed	104 et seq.

5 Results

5.1 Duty cycle

5.1.1 Method of measurement

The measurement was performed as a conducted measurement.

Acceptable measurement configurations

The measurement procedures described herein are based on the use of radiated measurements.

The method described in chapter 12.2 b) 2) of document [1] was used to perform the following test.

The measurement was only performed on only one frequency, because the timing behaviour was found to be independent of the selected channel.

The following measurement technique was used:

The zero-span mode on a spectrum analyzer or EMI receiver, if the response time and spacing between bins on the sweep are sufficient to permit accurate measurements of the ON and OFF times of the transmitted signal.

- Set the center frequency of the instrument to the center frequency of the transmission.
- Set $RBW \geq OBW$ if possible; otherwise, set RBW to the largest available value.
- Set $VBW \geq RBW$.
- Set detector = peak or average.
- The zero-span measurement method shall not be used unless both RBW and VBW are $> 50/T$ and the number of sweep points across duration T exceeds 100. (For example, if VBW and/or RBW are limited to 3 MHz, then the zero-span method of measuring duty cycle shall not be used if $T \leq 16.7$ microseconds.)

5.1.2 Test results

Ambient temperature	22 °C	Relative humidity	40 %
---------------------	-------	-------------------	------

The following calculations for the settings are only submitted for the worst case, therefore the other results can be assumed to be passed as well.

$$T_{TX} = 372\mu s \quad (1)$$

$$\frac{50}{T_{TX}} = \frac{50}{372\mu s} = 134.408kHz \leq 80MHz(RBW) \leq 80MHz(VBW) \quad (2)$$

Measurement Points 1001 for 450 μs 372 μs = 8270 measurement points Signal has 8270 measurement points (and fulfils the requirement of at least 100 Points resolution for the signal).

The plot below shows the duty cycle measurement for the worst documented case (802.11n40 MCS8). All other measurements are submitted without plots.

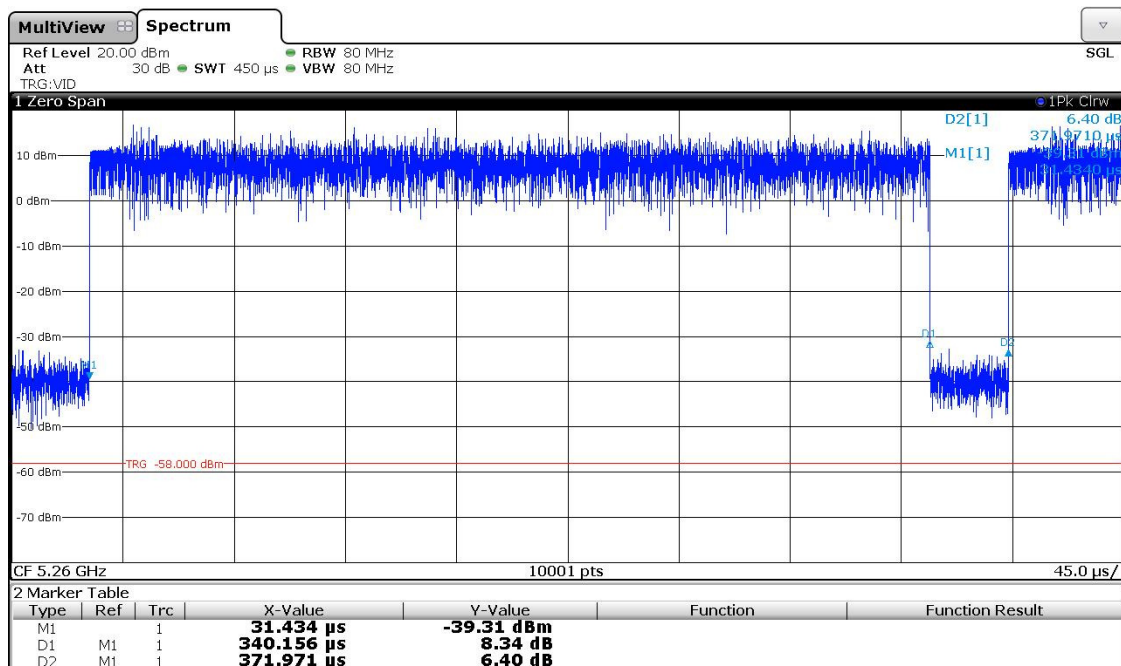

$$T_{TX_On} = 340\mu s \quad (3)$$

$$T_{TX_Period} = 372\mu s \quad (4)$$

If power averaging (RMS) mode was used in step f), then the applicable correction factor is $10 \log(1/x)$, where x is the duty cycle.

$$x = \frac{340\mu s}{372\mu s} = 0.914 = 91.4\% \quad (5)$$

$$\text{Correction factor: } 10 \cdot \log\left(\frac{1}{x}\right) = 10 \cdot \log\left(\frac{1}{0.914}\right) = 10 \cdot \log\left(\frac{1}{0.914}\right) = 0.4dB \quad (6)$$

Therefore, for average measurements a correction factor of 0.4 dB is use in all tests with n20 modulation. The results for the other modulation are submitted without calculation below:

802.11a with 6 Mbps: 0.2 dB correction factor
 802.11n20 with 6.5 Mbps (MCS0): 0.1 dB correction factor
 802.11n20 with 13 Mbps (MCS8): 0.3 dB correction factor
 802.11n40 with 13 Mbps (MCS0): 0.2 dB correction factor
 802.11n40 with 26 Mbps (MCS8): 0.4 dB correction factor

TEST EQUIPMENT USED FOR THE TEST:

7

5.2 Maximum conducted output power

5.2.1 Method of measurement

The EUT was measured conducted at the antenna ports with the aid of an average power meter.

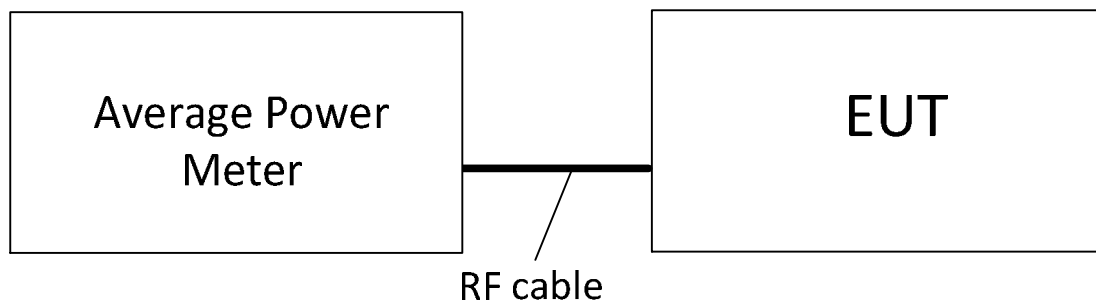

Acceptable measurement configurations

Procedure 12.3.3.1 in [1] was used for the following test.

Method PM is Measurement using an RF average power meter. The procedure for this method is as follows:

- 1) Measurements may be performed using a wideband RF power meter with a thermocouple detector or equivalent if all of the following conditions are satisfied:
 - a) The EUT is configured to transmit continuously, or to transmit with a constant duty cycle.
 - b) At all times when the EUT is transmitting, it shall be transmitting at its maximum power control level.
 - c) The integration period of the power meter exceeds the repetition period of the transmitted signal by at least a factor of five.
- 2) If the transmitter does not transmit continuously, measure the duty cycle D of the transmitter output signal as described in 12.2.
- 3) Measure the average power of the transmitter. This measurement is an average over both the ON and OFF periods of the transmitter.
- 4) Adjust the measurement in dBm by adding $[10 \log (1 / D)]$, where D is the duty cycle {e.g., $[10 \log (1 / 0.25)]$, if the duty cycle is 25%}.

The measurement was performed at the upper and lower end and the middle of the assigned frequency band.

5.2.2 Test results

Ambient temperature	22 °C	Relative humidity	62 %
---------------------	-------	-------------------	------

All antenna gains are below 6 dBi, therefore no conducted output limit reduction is necessary. The following power values are already adjusted by the duty cycle correction values as calculated in 5.1.2.

The limit for the 5.15 – 5.25 GHz band was compared to 21 dBm, therefore not elevation angle consideration has to be made.

Operation mode	Frequency [MHz]	Conducted output power ant. port 0 [dBm]	Conducted output power ant. port 1 [dBm]	Conducted output power ant. port 0&1 combined [dBm]	EIRP power [dBm]	Limit [dBm]
1	5180	10.8			15.8	21
2	5200	10.9			15.9	21
3	5240	10.3			15.3	21
4	5745	10.1			15.1	30
5	5785	10.4			15.4	30
6	5825	9.9			14.9	30
7	5180		11.9		13.9	21
8	5200		12.1		14.1	21
9	5240		12.1		14.1	21
10	5745		9.6		11.6	30
11	5785		9.8		11.8	30
12	5825		9.6		11.6	30
13	5180	12.7			17.7	21
14	5200	11.7			16.7	21
15	5240	11.7			16.7	21
16	5745	10.7			15.7	30
17	5785	10.6			15.6	30
18	5825	10.2			15.2	30
19	5180		13.1		15.1	21
20	5200		12.9		14.9	21
21	5240		13.0		15.0	21
22	5745		10.1		12.1	30
23	5785		9.8		11.8	30
24	5825		10.1		12.1	30
25	5180	12.9	13.2	16.1	19.9	21
26	5200	12.5	13.5	16.0	19.8	21
27	5240	12.5	13.3	15.9	19.7	21
28	5745	11.1	9.9	13.6	17.4	30
29	5785	11.1	9.9	13.6	17.4	30
30	5825	10.8	10.4	13.6	17.4	30
31	5190	10.1			15.1	21
32	5210	9.2			14.2	21
33	5755	8.6			13.6	30
34	5795	8.6			13.6	30

35	5190		11.4		13.4	21
36	5210		11.4		13.4	21
37	5755		7.7		9.7	30
38	5795		8.9		10.9	30
39	5190	10.3	11.5	14.0	17.8	21
40	5210	10.2	11.5	13.9	17.7	21
41	5755	8.4	7.8	11.1	14.9	30
42	5795	8.6	8.7	11.7	15.5	30

Test: Passed

TEST EQUIPMENT USED FOR THE TEST:

60, 61

5.3 UNII Bandwidth

5.3.1 Method of measurement

The EUT was tested with a spectrum analyzer connected to the antenna ports via an RF switch.

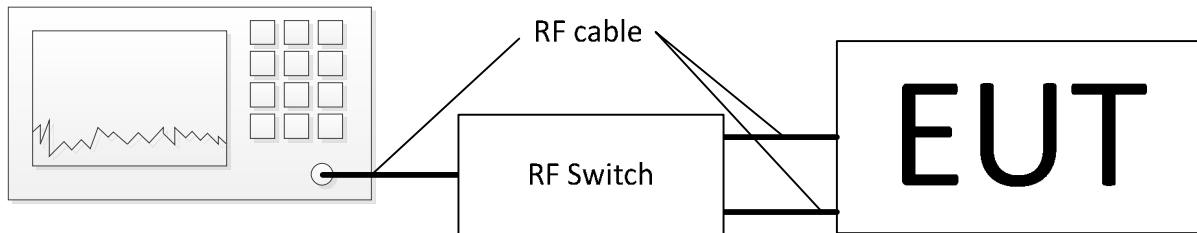

For the test of antenna port 0 and 1 transmitting simultaneously, the traces of the individual antenna ports were summed in linear terms as described in 14.3.2.2 in document [1].

The measurement procedure refers to part 12.4.1 of document [1].

- Set RBW = approximately 1% of the emission bandwidth.
- Set the VBW > RBW.
- Detector = Peak.
- Trace mode = max hold.
- Measure the maximum width of the emission that is 26 dB down from the peak of the emission. Compare this with the RBW setting of the analyser. Readjust RBW and repeat measurement as needed until the RBW/EBW ratio is approximately 1%.

5.3.2 Test result

Ambient temperature	22 °C	Relative humidity	59 %
---------------------	-------	-------------------	------

The following results were measured at the antenna port of the EUT. The plots show exemplary measurement results for the worst documented cases. The other results are listed in the following table.

WLAN1100 ant0&1 26dB BW n20 36.wmf: 26-dB Bandwidth (operation mode 25):

26 dB Bandwidth

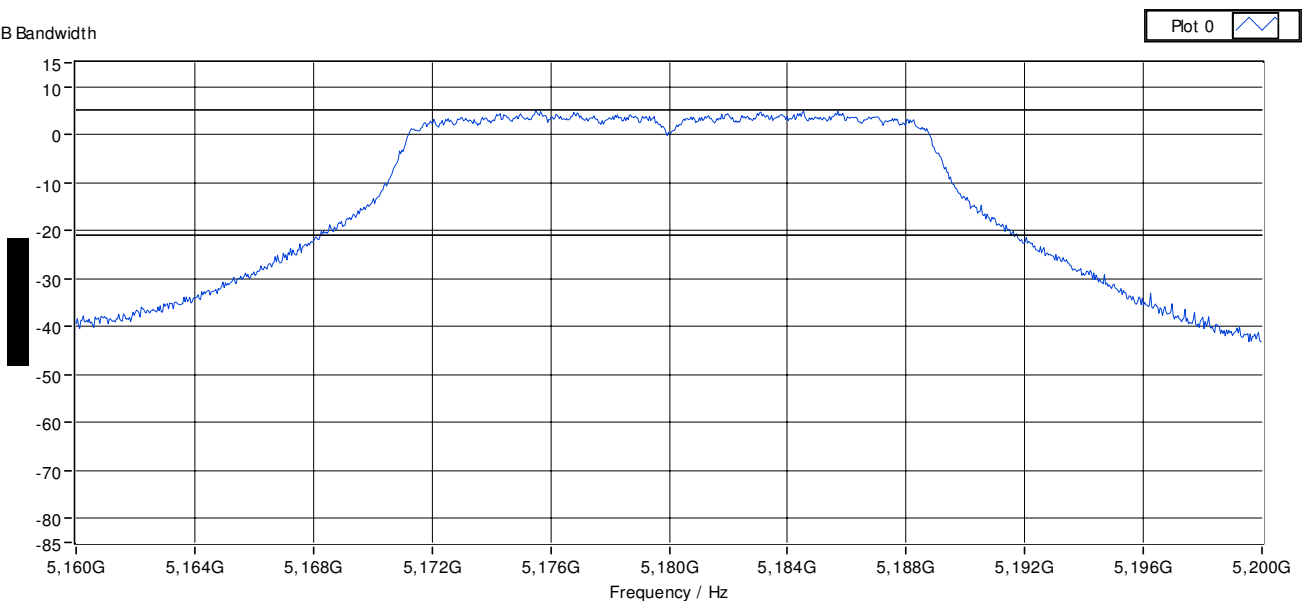

WLAN1100 ant0&1 99%BW n20 157.wmf: 99% Bandwidth (operation mode 29):

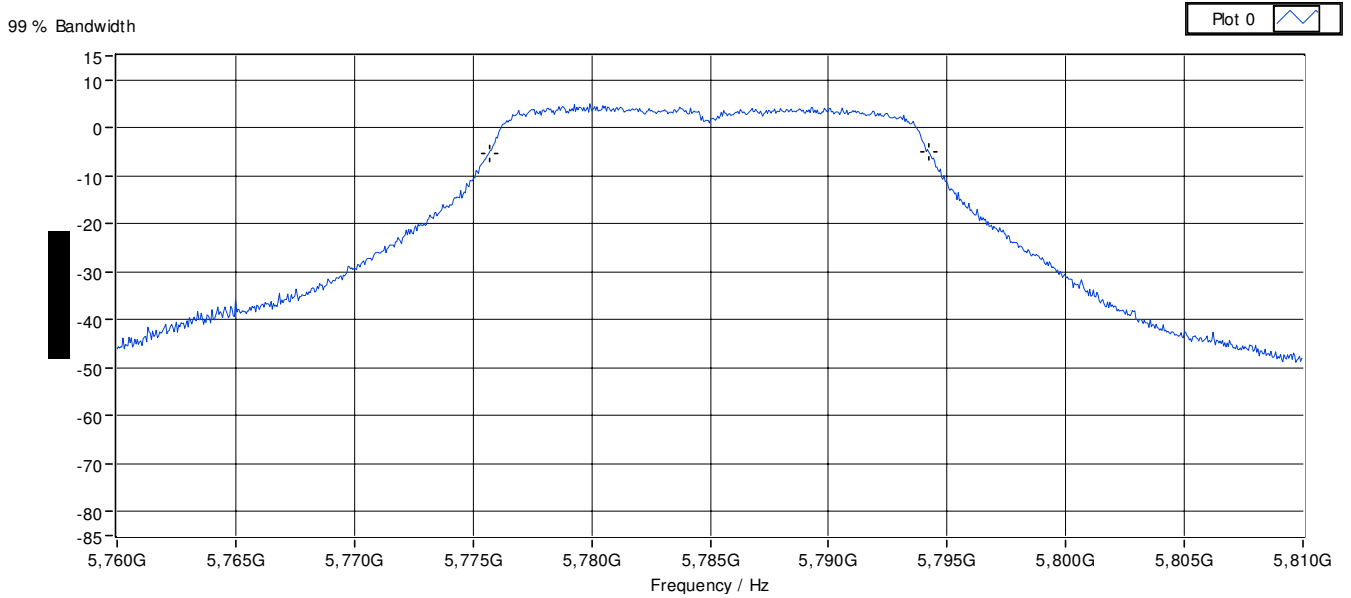

WLAN1100 ant0 6dB-BW a 157.wmf: 6-dB Bandwidth (operation mode 5):

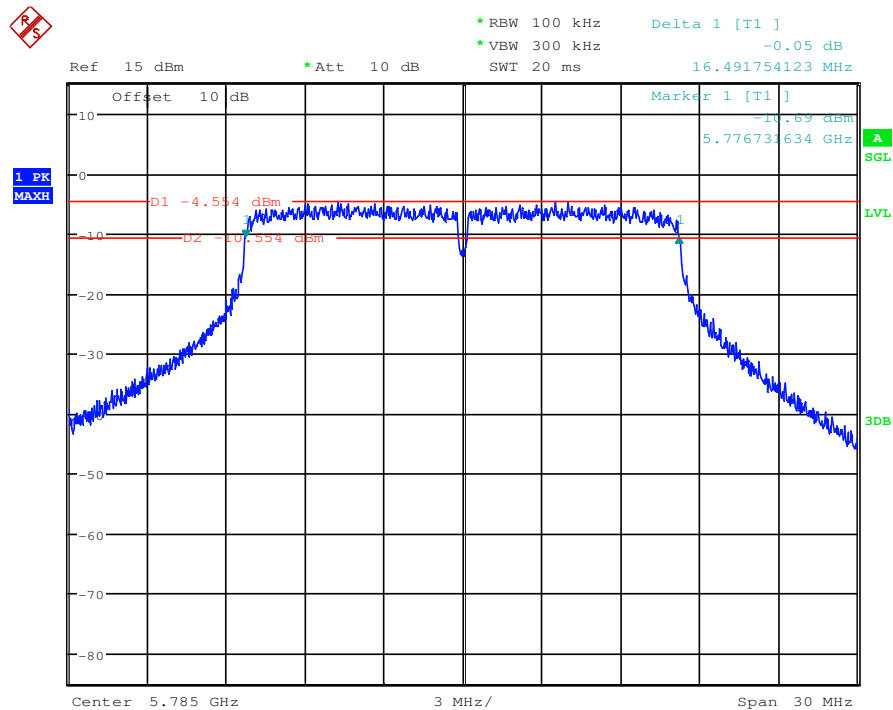

Operation mode	Frequency [MHz]	26 dB Bandwidth [MHz]	99% Bandwidth [MHz]	6 Bandwidth [MHz]
1	5180	24.176	17.950	-
2	5200	24.496	18.000	-
3	5240	23.816	17.950	-

Operation mode	Frequency [MHz]	26 dB Bandwidth [MHz]	99% Bandwidth [MHz]	6 Bandwidth [MHz]
4	5745	23.816	17.950	16.597
5	5785	23.776	17.950	16.492
6	5825	24.096	17.950	16.567
7	5180	23.936	17.950	-
8	5200	23.656	17.950	-
9	5240	23.656	17.900	-
10	5745	24.056	17.950	16.567
11	5785	24.176	18.000	16.582
12	5825	24.016	17.950	16.567
13	5180	24.336	18.850	-
14	5200	24.695	18.850	-
15	5240	24.575	18.900	-
16	5745	24.655	18.850	17.676
17	5785	24.655	18.900	17.736
18	5825	24.535	18.900	17.661
19	5180	24.735	18.850	-
20	5200	24.296	18.900	-
21	5240	24.016	18.900	-
22	5745	24.496	18.850	17.736
23	5785	24.535	18.900	17.721
24	5825	24.775	18.900	17.721
25	5180	23.536	18.531	-
26	5200	23.616	18.531	-
27	5240	23.536	18.531	-
28	5745	23.656	17.832	18.531
29	5785	23.976	17.802	18.531
30	5825	23.696	17.862	18.482
31	5190	47.752	37.760	-
32	5210	47.752	37.920	-
33	5755	48.751	37.840	36.557
34	5795	48.052	37.760	36.557
35	5190	46.753	37.840	-
36	5210	46.953	37.840	-
37	5755	47.852	37.840	36.557
38	5795	47.952	37.840	36.557
39	5190	46.034	37.562	-
40	5210	46.114	37.642	-
41	5755	45.794	37.722	36.563
42	5795	46.593	37.642	36.513

Test: Passed

TEST EQUIPMENT USED FOR THE TEST:

6 – 10, 30

5.4 Peak Power Spectral Density

5.4.1 Method of measurement

The EUT was tested with a spectrum analyzer connected to the antenna ports via an RF switch.

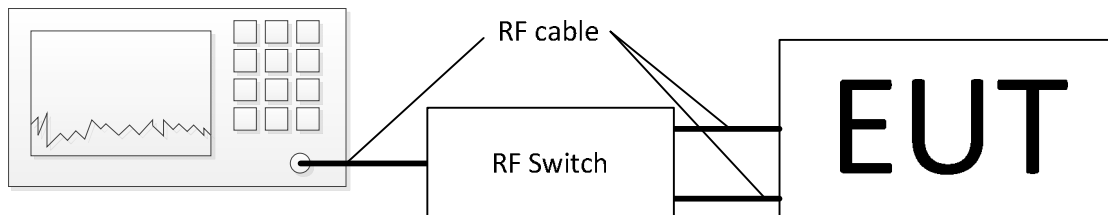

For the test of antenna port 0 and 1 transmitting simultaneously, the traces of the individual antenna ports were summed in linear terms as described in 14.3.2.2 in document [1].

The measurement procedure refers to part 12.5 of document [1].

Method SA-2 was used for this measurement.

- Measure the duty cycle D of the transmitter output signal as described in 12.2.
- Set span to encompass the entire 26 dB EBW or 99% OBW of the signal.
- Set RBW = 1 MHz.
- Set VBW \geq 3 MHz.
- Number of points in sweep \geq $[2 \times \text{span} / \text{RBW}]$. (This gives bin-to-bin spacing \leq RBW / 2, so that narrowband signals are not lost between frequency bins.)
- Sweep time = auto.
- Detector = RMS (i.e., power averaging), if available. Otherwise, use sample detector mode. Do not use sweep triggering. Allow the sweep to "free run."
- Trace average at least 100 traces in power averaging (rms) mode; however, the number of traces to be averaged shall be increased above 100 as needed such that the average accurately represents the true average over the ON and OFF periods of the transmitter.
- Use the peak search function on the instrument to find the peak of the spectrum.
- add $[10 \log (1 / D)]$, where D is the duty cycle, to the peak of the spectrum.
- The result is the PPSD.

The measurements were carried out at each antenna port separately.

5.4.2 Test result

Ambient temperature	22 °C	Relative humidity	59 %
---------------------	-------	-------------------	------

The following results were measured at the antenna port of the EUT. The plot shows an exemplary measurement result for the worst documented case. The other results are listed in the following table.

WLAN1100 ant0&1 PwrSpecDens n20 36.wmf.wmf: Power Spectral Density (operation mode 25):

Power Spectral Density Result

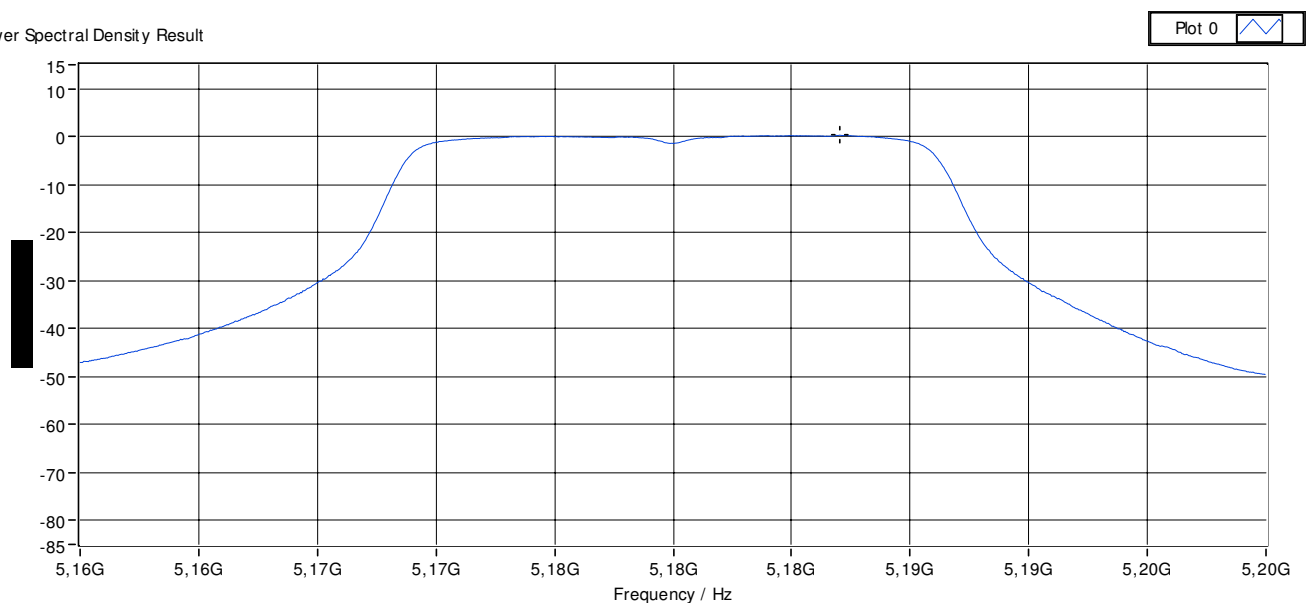

Operation Mode	Peak Frequency [MHz]	Power Spectral Density Limit [dBm/MHz]	Power Spectral Density Reading [dBm / MHz]	Result
1	5185.610	11	-0.9	Passed
2	5204.200	11	-1.1	Passed
3	5243.960	11	-1.7	Passed
7	5185.610	11	-0.4	Passed
8	5203.900	11	-0.1	Passed
9	5244.050	11	-0.9	Passed
13	5185.600	11	0.0	Passed
14	5204.040	11	-0.7	Passed
15	5244.200	11	-1.1	Passed
19	5185.680	11	-0.1	Passed
20	5204.120	11	0.1	Passed
21	5244.040	11	-0.0	Passed
25	5185.614	11	0.3	Passed
26	5204.016	11	0.1	Passed
27	5244.056	11	-0.4	Passed
31	5199.660	4	-5.3	Passed
32	5199.720	4	-6.0	Passed

Operation Mode	Peak Frequency [MHz]	Power Spectral Density Limit [dBm/MHz]	Power Spectral Density Reading [dBm / MHz]	Result
35	5199.960	4	-5.1	Passed
36	5240.020	4	-5.4	Passed
39	5200.579	11	-4.4	Passed
40	5240.699	11	-5.2	Passed
Measurement uncertainty			+0.66 dB / -0.72 dB	

Operation Mode	Peak Frequency [MHz]	Power Spectral Density Limit [dBm / 500 kHz]	Power Spectral Density Reading [dBm / 500 kHz]	Result
4	5739.960	30	-5.0	Passed
5	5780.050	30	-5.3	Passed
6	5820.080	30	-5.8	Passed
10	5739.810	30	-5.7	Passed
11	5780.260	30	-5.9	Passed
12	5820.290	30	-6.3	Passed
16	5740.000	30	-4.8	Passed
17	5780.200	30	-5.2	Passed
18	5820.240	30	-6.1	Passed
22	5740.080	30	-5.6	Passed
23	5780.080	30	-6.0	Passed
24	5820.000	30	-6.4	Passed
28	5740.025	30	-6.0	Passed
29	5780.305	30	-6.2	Passed
30	5820.145	30	-6.7	Passed
33	5743.620	30	-10.1	Passed
34	5784.020	30	-10.8	Passed
37	5743.440	30	-10.8	Passed
38	5784.140	30	-10.2	Passed
41	5743.761	30	-10.4	Passed
42	5784.061	30	-10.8	Passed
Measurement uncertainty			+0.66 dB / -0.72 dB	

Test: Passed

TEST EQUIPMENT USED FOR THE TEST:

6 – 10, 30

5.5 Band-edge compliance

5.5.1 Method of measurement (band edges next to unrestricted bands (conducted))

The EUT was tested with a spectrum analyzer connected to the antenna ports.

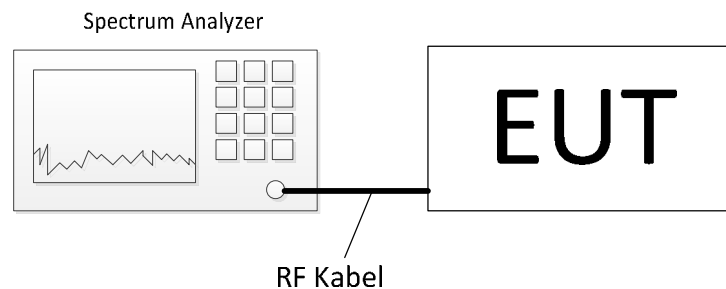

The relating measurements were carried out in a conducting manner. Therefore, the antenna connector was directly connected to a spectrum analyser. The measurement procedure refers to part 11.11.2 and 11.11.3 of document [1].

The relating measurements were carried out in a conducting manner. Therefore, the antenna connector was directly connected to a spectrum analyser. The measurement procedure refers to part 12.7.6 of document [1].

Measurement Procedure – Unwanted Emissions

- Set the center frequency and span to encompass the frequency range to be measured.
- RBW = 1 MHz. (100 kHz for frequencies below 1 GHz)
- VBW \geq 3 MHz. (300 kHz for frequencies below 1 GHz)
- Detector = Peak.
- Sweep time = auto couple.
- Trace Mode = max hold.
- Use the peak marker function to determine the maximum amplitude level. Allow sweeps to continue until the trace stabilizes. Note that if the transmission is not continuous, then the time required for the trace to stabilize will increase by a factor of approximately $1/D$, where D is the duty cycle. For example, at 50% duty cycle, the measurement time will increase by a factor of two, relative to measurement time for continuous transmission.

The measurements were performed at the lower and upper end of the applicable 5 GHz bands.

5.5.2 Test result (band edges next to unrestricted bands (conducted))

Ambient temperature	22 °C
---------------------	-------

Relative humidity	59 %
-------------------	------

The following results were measured at the antenna port of the EUT. The plot shows an exemplary measurement result for the worst documented case. The other results are listed in the following table.

WLAN1100_ant0&1_BandEdgeUnRestr_2_n40_149.wmf: conducted band-edge compliance (operation mode 33):

Band Edge Emissions Result

Plot 0 

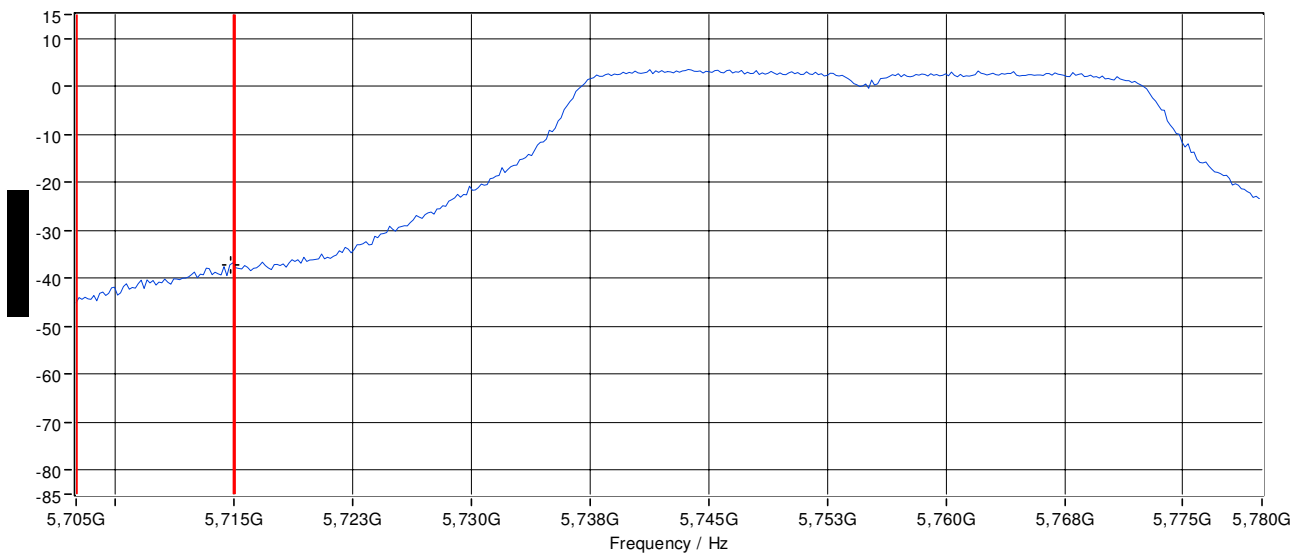

Operation mode	Antenna port	Emission Frequency [MHz]	Limit [dBm]	Emission Level [dBm]	Margin [dB]	Result
4	0	5724.880	-17.0	-24.3	7.3	Passed
4	0	5714.607	-27.0	-34.2	7.2	Passed
6	0	5850.264	-17.0	-34.8	17.8	Passed
6	0	5860.304	-27.0	-42.0	15.0	Passed
10	1	5724.663	-17.0	-30.0	13.0	Passed
10	1	5713.373	-27.0	-38.9	11.9	Passed
13	1	5850.048	-17.0	-36.8	19.8	Passed
13	1	5860.569	-27.0	-44.8	17.8	Passed
16	0	5724.519	-17.0	-27.1	10.1	Passed
16	0	5712.668	-27.0	-34.3	7.3	Passed
18	0	5852.716	-17.0	-36.2	19.2	Passed
18	0	5860.040	-27.0	-44.8	17.8	Passed
22	1	5724.447	-17.0	-29.5	12.5	Passed
22	1	5712.228	-27.0	-38.3	11.3	Passed
24	1	5853.365	-17.0	-35.7	18.7	Passed
24	1	5860.657	-27.0	-42.9	15.9	Passed
28	0&1	5724.177	-31.5	-17.0	14.5	Passed
28	0&1	5714.850	-43.8	-27.0	16.8	Passed
30	0&1	5850.025	-47.2	-17.0	30.2	Passed
30	0&1	5860.723	-50.5	-27.0	23.5	Passed
33	0	5724.792	-17.0	-28.5	11.5	Passed
33	0	5712.332	-27.0	-32.0	5.0	Passed
34	0	5852.933	-17.0	-49.9	32.9	Passed
34	0	5861.987	-27.0	-52.0	25.0	Passed
37	1	5724.792	-17.0	-28.6	11.6	Passed
37	1	5710.769	-27.0	-35.4	8.4	Passed
38	1	5851.923	-17.0	-45.8	28.8	Passed
38	1	5860.064	-27.0	-47.0	20.0	Passed
41	0&1	5724.726	-30.5	-17.0	13.5	Passed
41	0&1	5714.726	-37.2	-27.0	10.2	Passed
42	0&1	5858.429	-49.3	-17.0	32.3	Passed
42	0&1	5860.524	-50.1	-27.0	23.1	Passed

Test: Passed

TEST EQUIPMENT USED FOR THE TEST:
6 – 10, 30

5.5.3 Method of measurement (band edges next to restricted bands (conducted))

The same test set-up as used for the final conducted emission measurement shall be used (refer also subclause 5.6.1 of this test report).

After trace stabilisation the marker shall be set on the signal peak. The frequency line shall be set on the edge of the assigned frequency band. Now set the second marker on the emission at the band-edge, or on the highest modulation product outside of the band, if this level is higher than that at the band-edge. The level of the measured field strength shall be compared to the general limits specified in § 15.205.

The measurement was performed at the lower and the upper end of the 2.4 GHz band.

The calculation was performed with the following formula as described in chapter 11.12.2.2 e) in [1]:

$$E [\text{dB}\mu\text{V}/\text{m}] = EIRP [\text{dBm}] - 20\log(d) + 104.8 + G_{\text{Ant}} [\text{dBi}] + G_{\text{Array}} [\text{dB}] + Att_{\text{MeasCable}} [\text{dB}] + Att_{\text{RF-Switch}} [\text{dB}]$$

$E [\text{dB}\mu\text{V}/\text{m}]$ = Field Strength [$\text{dB}\mu\text{V}/\text{m}$]

$EIRP [\text{dBm}]$ = Reading [dBm]

d = measurement distance in m

$G_{\text{Ant}} [\text{dBi}]$ = Gain of the EUT antenna

$G_{\text{Array}} [\text{dB}]$ = Array Gain [in case of multiple transmitting antenna port]

$Att_{\text{MeasCable}} [\text{dB}]$ = Attenuation of the measurement cables

$Att_{\text{RF-Switch}} [\text{dB}]$ = Attenuation of the RF Switch

5.5.4 Test result (band edges next to restricted bands (conducted))

Ambient temperature	22 °C	Relative humidity	59 %
---------------------	-------	-------------------	------

The plot shows an exemplary measurement result for the worst documented case. The other results are listed in the following tables.

WLAN1100 ant1 BandEdgeRestr n40 36.wmf: conducted band-edge compliance (operation mode 35):

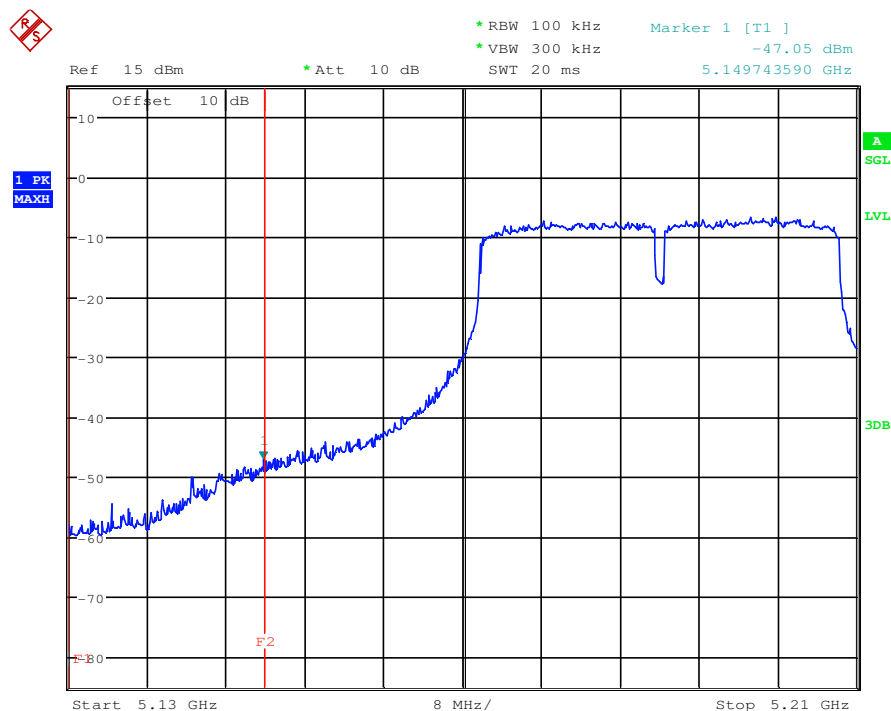

Band Edge Compliance, a-mode, channel 36, antenna port 0 (Operation mode 1)							
Operation Mode	Frequency [MHz]	Field Strength [dBuV/m]	Peak Limit [dBuV/m]	Margin [dB]	Reading [dBm]	Antenna Gain + Array Gain [dBi]	Result
1	5149.968	67.4	74.0	6.6	-34.9	5.0	Passed
Operation Mode	Frequency [MHz]	Field Strength [dBuV/m]	Average Limit [dBuV/m]	Margin [dB]	Reading [dBm]	Antenna Gain + Array Gain [dBi]	Result
1	5149.908	45.6	54.0	8.4	-56.8	5.0	Passed
Measurement uncertainty				+0.66 dB / -0.72 dB			

Band Edge Compliance, a-mode, channel 36, antenna port 1 (Operation mode 7)							
Operation Mode	Frequency [MHz]	Field Strength [dBuV/m]	Peak Limit [dBuV/m]	Margin [dB]	Reading [dBm]	Antenna Gain + Array Gain [dBi]	Result
13	5149.340	62.7	74.0	11.3	-38.4	5.0	Passed
Operation Mode	Frequency [MHz]	Field Strength [dBuV/m]	Average Limit [dBuV/m]	Margin [dB]	Reading [dBm]	Antenna Gain + Array Gain [dBi]	Result
13	5149.910	42.2	54.0	11.8	-59.0	5.0	Passed
Measurement uncertainty				+0.66 dB / -0.72 dB			

Band Edge Compliance, n20-mode, channel 36, antenna port 0 (Operation mode 13)							
Operation Mode	Frequency [MHz]	Field Strength [dBuV/m]	Peak Limit [dBuV/m]	Margin [dB]	Reading [dBm]	Antenna Gain + Array Gain [dBi]	Result
25	5147.474	71.3	74.0	2.7	-29.8	5.0	Passed
Operation Mode	Frequency [MHz]	Field Strength [dBuV/m]	Average Limit [dBuV/m]	Margin [dB]	Reading [dBm]	Antenna Gain + Array Gain [dBi]	Result
25	5149.904	46.6	54.0	7.4	-54.6	5.0	Passed
Measurement uncertainty				+0.66 dB / -0.72 dB			

Band Edge Compliance, n20-mode, channel 36, antenna port 1 (Operation mode 19)							
Operation Mode	Frequency [MHz]	Field Strength [dBuV/m]	Peak Limit [dBuV/m]	Margin [dB]	Reading [dBm]	Antenna Gain + Array Gain [dBi]	Result
37	5148.344	69.6	74.0	4.4	-31.6	5.0	Passed
Operation Mode	Frequency [MHz]	Field Strength [dBuV/m]	Average Limit [dBuV/m]	Margin [dB]	Reading [dBm]	Antenna Gain + Array Gain [dBi]	Result
37	5149.844	46.4	54.0	7.6	-54.8	5.0	Passed
Measurement uncertainty				+0.66 dB / -0.72 dB			

Band Edge Compliance, n20-mode, channel 36, antenna port 0&1 (Operation mode 25)							
Operation Mode	Frequency [MHz]	Field Strength [dBuV/m]	Peak Limit [dBuV/m]	Margin [dB]	Reading [dBm]	Antenna Gain + Array Gain [dBi]	Result
49	5147.252	66.9	74.0	7.1	-32.2	3.8	Passed
Operation Mode	Frequency [MHz]	Field Strength [dBuV/m]	Average Limit [dBuV/m]	Margin [dB]	Reading [dBm]	Antenna Gain + Array Gain [dBi]	Result
49	5148.992	44.1	54.0	9.9	-54.9	3.8	Passed
Measurement uncertainty				+0.66 dB / -0.72 dB			

Band Edge Compliance, n40-mode, channel 38, antenna port 0 (Operation mode 31)							
Operation Mode	Frequency [MHz]	Field Strength [dBuV/m]	Peak Limit [dBuV/m]	Margin [dB]	Reading [dBm]	Antenna Gain + Array Gain [dBi]	Result
61	5415.230	54.3	74.0	19.7	-47.0	5.0	Passed
Operation Mode	Frequency [MHz]	Field Strength [dBuV/m]	Average Limit [dBuV/m]	Margin [dB]	Reading [dBm]	Antenna Gain + Array Gain [dBi]	Result
61	5417.750	41.9	54.0	12.1	-59.4	5.0	Passed
Measurement uncertainty				+0.66 dB / -0.72 dB			

Band Edge Compliance, n40-mode, channel 38, antenna port 1 (Operation mode 35)							
Operation Mode	Frequency [MHz]	Field Strength [dBuV/m]	Peak Limit [dBuV/m]	Margin [dB]	Reading [dBm]	Antenna Gain + Array Gain [dBi]	Result
70	5147.554	69.8	74.0	4.2	-31.4	5.0	Passed
Operation Mode	Frequency [MHz]	Field Strength [dBuV/m]	Average Limit [dBuV/m]	Margin [dB]	Reading [dBm]	Antenna Gain + Array Gain [dBi]	Result
70	5150.014	52.6	54.0	1.4	-48.6	5.0	Passed
Measurement uncertainty				+0.66 dB / -0.72 dB			

Band Edge Compliance, n40-mode, channel 38, antenna port 0&1 (Operation mode 39)							
Operation Mode	Frequency [MHz]	Field Strength [dBuV/m]	Peak Limit [dBuV/m]	Margin [dB]	Reading [dBm]	Antenna Gain + Array Gain [dBi]	Result
79	5149.066	67.4	74.0	6.6	-32.0	3.8	Passed
Operation Mode	Frequency [MHz]	Field Strength [dBuV/m]	Average Limit [dBuV/m]	Margin [dB]	Reading [dBm]	Antenna Gain + Array Gain [dBi]	Result
79	5149.894	49.8	54.0	4.2	-49.5	3.8	Passed
Measurement uncertainty				+0.66 dB / -0.72 dB			

Test: Passed

TEST EQUIPMENT USED FOR THE TEST:

6 – 10, 30

5.6 Maximum unwanted emissions

5.6.1 Method of measurement (conducted emissions in the restricted bands)

The relating measurements were carried out in a conducting manner. Therefore, the antenna connector was directly mounted to a spectrum analyser. The measurement procedure refers to parts 12.7.5, 12.7.6 and 12.7.7.2 in [1].

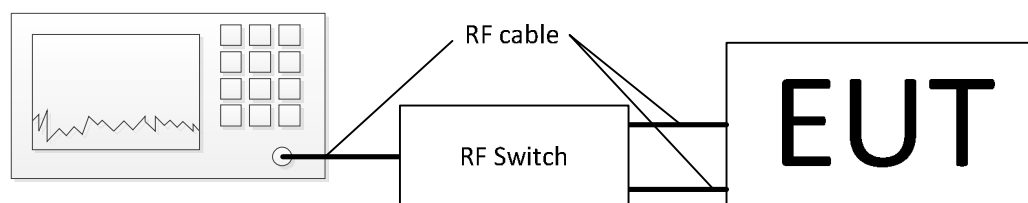

If emissions were detected during the preliminary measurements, they were measured using the following measurement procedures:

Peak measurement procedure:

- Set the analyzer span to encompass the entire unwanted emission bandwidth.
- Set the RBW = specified in Table 1.
- Set the VBW $\geq [3 \times \text{RBW}]$.
- Set sweep time = auto.
- Detector = peak.
- Trace mode = max hold.
- Allow the trace to stabilize.
- Use the peak marker function to determine the peak power over the emission bandwidth.

Average measurement procedure:

- RBW = 1 MHz.
- VBW $\geq [3 \times \text{RBW}]$.
- Detector = RMS (power averaging), if $[\text{span} / (\# \text{ of points in sweep})] \leq \text{RBW} / 2$. Satisfying this condition can require increasing the number of points in the sweep or reducing the span. If the condition is not satisfied, then the detector mode shall be set to peak.
- Averaging type = power (i.e., rms)
- Sweep time = auto.
- Perform a trace average of at least 100 traces if the transmission is continuous. If the transmission is not continuous, then the number of traces shall be increased by a factor of $1 / D$, where D is the duty cycle. For example, with 50% duty cycle, at least 200 traces shall be averaged. (If a specific emission is demonstrated to be continuous—i.e., 100% duty cycle—then rather than turning ON and OFF with the transmit cycle, at least 100 traces shall be averaged.)
- Add the correction factor $[10 \log (1 / D)]$, where D is the duty cycle to the measured value (if the EUT transmitting at a duty cycle less than 98%)

Table 1 RBW as a function of frequency

Frequency	RBW
9-150 kHz	200-300 Hz
0.15-30 MHz	9-10 kHz
30-1000 MHz	100-120 kHz
> 1000 MHz	1 MHz

The measurements were carried out at each antenna port.

If an emission fails the conducted test, the measurement will be repeated in a radiated manner.

5.6.1.1 Limit calculations

The following general procedure is described in chapter 12.7.2 of [1].

- a) Measure the conducted output power (in dBm) using the procedures described in **Fehler! Verweisquelle konnte nicht gefunden werden..**
- b) Add the maximum transmit antenna gain (in dBi) to the measured output power level to determine the EIRP level
- c) Add the appropriate maximum ground reflections factor to the EIRP level (6 dB for frequencies \leq , 30 MHz, 4.7 for frequencies between 30 MHz and 1000 MHz, inclusive and 0 dB for frequencies $>$ 1000 MHz)
- d) For devices with multiple antenna ports, measure the power of each individual chain and sum the EIRP of all chains in linear terms (e.g., Watts, mW)
- e) Convert the resultant level to an equivalent electric field strength using the following relationships:

$$E. = EIRP - 20\log(d) + 104.8 \quad (1)$$

Where:

E. = electric field strength, in dB μ V/m

EIRP = equivalent isotropic radiated power, in dBm

d = specified measurement distance, in meters

- f) Compare the resultant electric field strength to the applicable limit

Document [1] states in chapter 14, that for transmitters with multiple outputs in the same band, summing of emissions and accounting for array gain have to be considered.

For combining emissions from multiple outputs, the spurious emissions at each output have to be measured and $10 \log(N)$ has to be added to the resulting value, whereby N refers to the number of outputs.

To account for directional gain which might occur in case of N transmit antennas in the test mode spatial multiplexing, which is the mode the EUT uses, the directional gain has to be calculated as:

$$10\log \left[\sum_{j=1}^{N_{SS}} \left\{ \sum_{k=1}^{N_{Ant}} g_{j,k} \right\}^2 / N_{Ant} \right]$$

Whereby

N_{SS} is the number of independent spatial streams of data.

N_{Ant} is the total number of antennas

$g_{j,k}$ is $10^{G_k/20}$ if the k th antenna is being fed by spatial stream j , or zero if it is not

G_k is the gain in dBi of the k th antenna

For the antennas of this EUT which have 5 and 2 dBi antenna gain, the combined antenna gain results in a value of 3.8 dBi directional antenna gain.

5.6.2 Method of measurement (conducted emissions in the unrestricted bands)

The measurement was performed as described in H)2) in document [3].

5.6.2.1 Emission level measurement

Measurement Procedure – Unwanted Emissions

- Set the center frequency and span to encompass the frequency range to be measured.
- RBW = 1 MHz. (100 kHz for frequencies below 1 GHz)
- VBW \geq 3 MHz. (300 kHz for frequencies below 1 GHz)
- Detector = Peak.
- Sweep time = auto couple.
- Trace Mode = max hold.
- Use the peak marker function to determine the maximum amplitude level. Allow sweeps to continue until the trace stabilizes. Note that if the transmission is not continuous, then the time required for the trace to stabilize will increase by a factor of approximately $1/D$, where D is the duty cycle. For example, at 50% duty cycle, the measurement time will increase by a factor of two, relative to measurement time for continuous transmission.

The limit of -27 dBm/MHz was specified in 15.407 (b) (1).

For transmitters operating in the frequency band 5.725 – 5.85 the spurious emissions shall not be greater than – 17 dBm/MHz at frequencies greater than 10 MHz from the band edges.

5.6.3 Test results (conducted emissions)

5.6.3.1 Emissions below 1 GHz

The emissions below 1 GHz were equal for all modulations, channels and data rates, therefore these emissions were only tested as radiated tests with the dedicated antennas. The results can be found in 5.6.5.2.

5.6.3.2 Emissions above 1 GHz

Ambient temperature	22 °C	Relative humidity	59 %
---------------------	-------	-------------------	------

The following results were measured at antenna port of the EUT. Only the plots for the worst case emissions are submitted below. The frequency range 18 – 26 GHz and 26 to 40 GHz has shown no emissions, therefore only an exemplar plot is submitted below.

All emissions that did not pass the conducted test, were repeated as radiated measurements.

WLAN1100 ant0 SpurEmiss1-4G n20 165.wmf: conducted spurious emissions (operation mode 16):

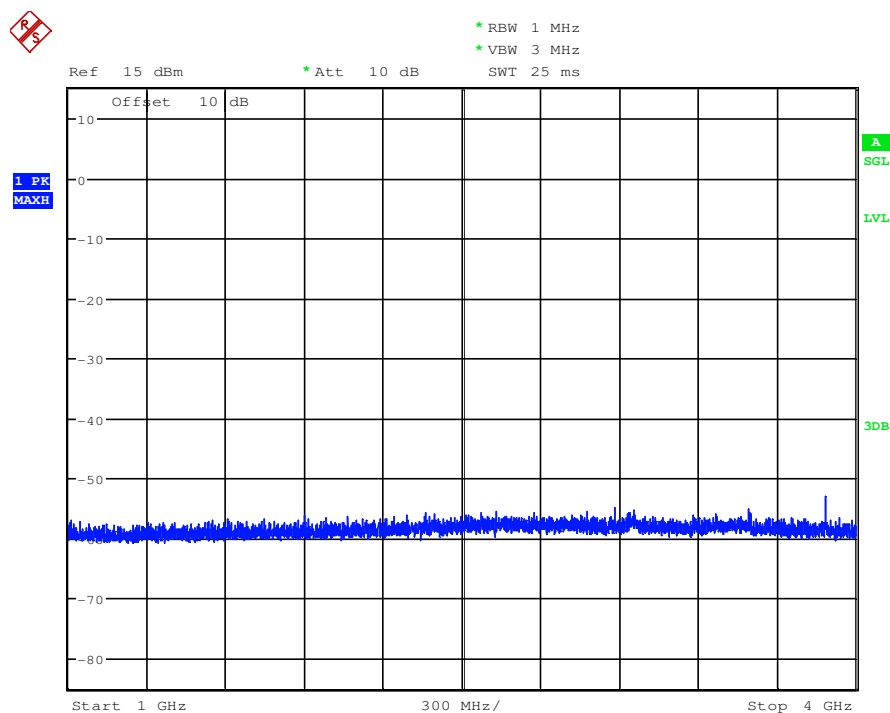

WLAN1100_ant0_SpurEmiss4-12G_a_48.wmf: conducted spurious emissions (operation mode 3):

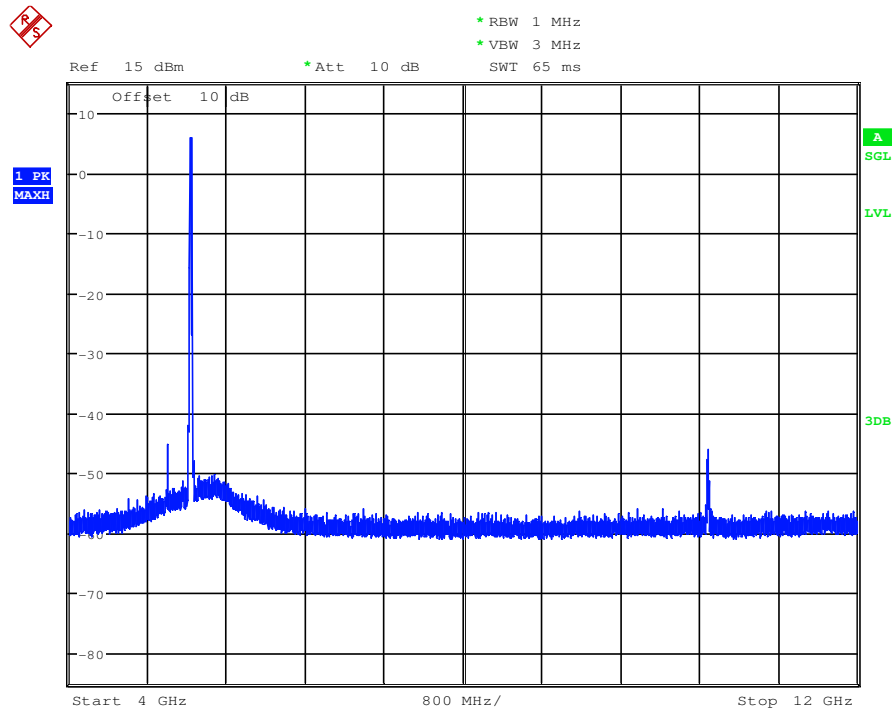

WLAN1100_ant1_SpurEmiss12-18G_n20_36.wmf: conducted spurious emissions (operation mode 19):

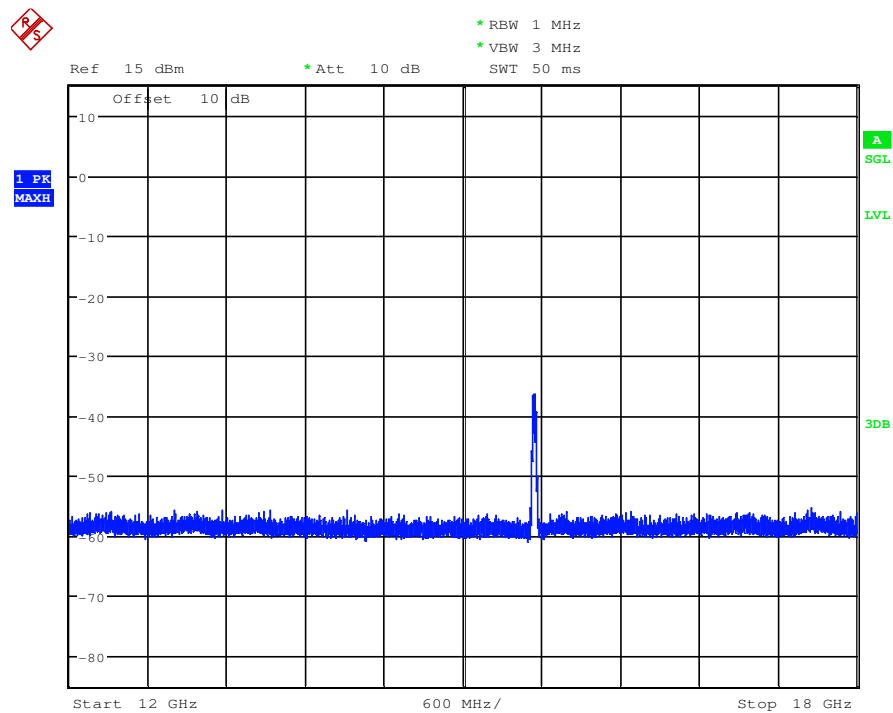

Spurious Emissions, a-mode, channel 36, antenna port 0 (Operation mode 1)							
Peak Emission – Restricted Band							
Operation Mode	Frequency [MHz]	Field Strength [dBuV/m]	Peak Limit [dBuV/m]	Margin [dB]	Reading [dBm]	Antenna Gain + Array Gain [dBi]	Result
1	15535.170	56.1	74.0	17.9	-46.1	5.0	Passed
Average Emission – Restricted Band							
Operation Mode	Frequency [MHz]	Field Strength [dBuV/m]	Average Limit [dBuV/m]	Margin [dB]	Reading [dBm]	Antenna Gain + Array Gain [dBi]	Result
1	15541.350	36.4	54.0	17.6	-65.7	5.0	Passed
Emissions in the non-restricted Bands							
Operation Mode	Frequency [MHz]	Reading [dBm]	Limit [dBm]	Margin [dB]	Result		
1	2503.320	-53.9	-27.0	26.9	Passed		
1	5505.960	-46.3	-27.0	19.3	Passed		
1	6906.680	-49.8	-27.0	22.8	Passed		
1	10359.440	-42.7	-27.0	15.7	Passed		
Measurement uncertainty				+0.66 dB / -0.72 dB			

Spurious Emissions, a-mode, channel 40, antenna port 0 (Operation mode 2)							
Peak Emission – Restricted Band							
Operation Mode	Frequency [MHz]	Field Strength [dBuV/m]	Peak Limit [dBuV/m]	Margin [dB]	Reading [dBm]	Antenna Gain + Array Gain [dBi]	Result
2	15590.640	56.9	74.0	17.1	-45.2	5.0	Passed
Average Emission – Restricted Band							
Operation Mode	Frequency [MHz]	Field Strength [dBuV/m]	Average Limit [dBuV/m]	Margin [dB]	Reading [dBm]	Antenna Gain + Array Gain [dBi]	Result
2	15599.600	36.3	54.0	17.7	-65.8	5.0	Passed
Emissions in the non-restricted Bands							
Operation Mode	Frequency [MHz]	Reading [dBm]	Limit [dBm]	Margin [dB]	Result		
2	2624.680	-53.7	-27.0	26.7	Passed		
2	10402.510	-41.4	-27.0	14.4	Passed		
2	6933.210	-49.9	-27.0	22.9	Passed		
2	5278.270	-45.7	-27.0	18.7	Passed		
Measurement uncertainty				+0.66 dB / -0.72 dB			

Spurious Emissions, a-mode, channel 48, antenna port 0 (Operation mode 3)							
Peak Emission – Restricted Band							
Operation Mode	Frequency [MHz]	Field Strength [dBuV/m]	Peak Limit [dBuV/m]	Margin [dB]	Reading [dBm]	Antenna Gain + Array Gain [dBi]	Result
3	5000.090	57.1	74.0	16.9	-44.1	5.0	Passed
3	5396.310	53.0	74.0	21.0	-48.3	5.0	Passed
3	15715.950	53.5	74.0	20.5	-48.7	5.0	Passed
Average Emission – Restricted Band							
Operation Mode	Frequency [MHz]	Field Strength [dBuV/m]	Average Limit [dBuV/m]	Margin [dB]	Reading [dBm]	Antenna Gain + Array Gain [dBi]	Result
3	4999.820	52.9	54.0	1.1	-48.4	5.0	Passed
3	5400.100	40.4	54.0	13.6	-60.9	5.0	Passed
3	15719.650	36.5	54.0	17.5	-65.7	5.0	Passed
Emissions in the non-restricted Bands							
Operation Mode	Frequency [MHz]	Reading [dBm]	Limit [dBm]	Margin [dB]	Result		
3	2933.650	-53.6	-27.0	26.6	Passed		
3	10471.850	-42.1	-27.0	15.1	Passed		
Measurement uncertainty				+0.66 dB / -0.72 dB			

Spurious Emissions, a-mode, channel 149, antenna port 0 (Operation mode 4)							
Peak Emission – Restricted Band							
Operation Mode	Frequency [MHz]	Field Strength [dBuV/m]	Peak Limit [dBuV/m]	Margin [dB]	Reading [dBm]	Antenna Gain + Array Gain [dBi]	Result
10	11490.149	63.7	74.0	10.3	-38.1	5.0	Passed
Average Emission – Restricted Band							
Operation Mode	Frequency [MHz]	Field Strength [dBuV/m]	Average Limit [dBuV/m]	Margin [dB]	Reading [dBm]	Antenna Gain + Array Gain [dBi]	Result
10	11489.709	49.6	54.0	4.4	-52.2	5.0	Passed
Emissions in the non-restricted Bands							
Operation Mode	Frequency [MHz]	Reading [dBm]	Limit [dBm]	Margin [dB]	Result		
10	5714.607	-34.2	-27.0	7.2	Passed		
10	5724.880	-24.3	-17.0	7.3	Passed		
10	17230.650	-37.1	-27.0	10.1	Passed		
Measurement uncertainty				+0.66 dB / -0.72 dB			

Spurious Emissions, a-mode, channel 157, antenna port 0 (Operation mode 5)							
Peak Emission – Restricted Band							
Operation Mode	Frequency [MHz]	Field Strength [dBuV/m]	Peak Limit [dBuV/m]	Margin [dB]	Reading [dBm]	Antenna Gain + Array Gain [dBi]	Result
11	11570.587	63.7	74.0	10.3	-38.2	5.0	Passed
Average Emission – Restricted Band							
Operation Mode	Frequency [MHz]	Field Strength [dBuV/m]	Average Limit [dBuV/m]	Margin [dB]	Reading [dBm]	Antenna Gain + Array Gain [dBi]	Result
11	11569.767	49.7	54.0	4.3	-52.3	5.0	Passed
Emissions in the non-restricted Bands							
Operation Mode	Frequency [MHz]	Reading [dBm]	Limit [dBm]	Margin [dB]	Result		
11	17356.730	-37.4	-27.0	10.4	Passed		
Measurement uncertainty				+0.66 dB / -0.72 dB			

Spurious Emissions, a-mode, channel 165, antenna port 0 (Operation mode 6)							
Peak Emission – Restricted Band							
Operation Mode	Frequency [MHz]	Field Strength [dBuV/m]	Peak Limit [dBuV/m]	Margin [dB]	Reading [dBm]	Antenna Gain + Array Gain [dBi]	Result
12	3883.250	51.9	74.0	22.1	-49.2	5.0	Passed
12	11650.503	63.8	74.0	10.2	-38.0	5.0	Passed
Average Emission – Restricted Band							
Operation Mode	Frequency [MHz]	Field Strength [dBuV/m]	Average Limit [dBuV/m]	Margin [dB]	Reading [dBm]	Antenna Gain + Array Gain [dBi]	Result
12	3883.320	45.0	54.0	9.0	-56.1	5.0	Passed
12	11650.033	49.8	54.0	4.2	-52.0	5.0	Passed
Emissions in the non-restricted Bands							
Operation Mode	Frequency [MHz]	Reading [dBm]	Limit [dBm]	Margin [dB]	Result		
12	5860.304	-42.0	-27.0	15.0	Passed		
12	5850.264	-34.8	-17.0	17.8	Passed		
12	17477.290	-39.0	-27.0	12.0	Passed		
Measurement uncertainty				+0.66 dB / -0.72 dB			

Spurious Emissions, a-mode, channel 36, antenna port 1 (Operation mode 7)							
Peak Emission – Restricted Band							
Operation Mode	Frequency [MHz]	Field Strength [dBuV/m]	Peak Limit [dBuV/m]	Margin [dB]	Reading [dBm]	Antenna Gain + Array Gain [dBi]	Result
13	5120.080	56.0	74.0	18.0	-45.3	5.0	Passed
13	4879.960	51.4	74.0	22.6	-49.9	5.0	Passed
13	5080.260	53.1	74.0	20.9	-48.2	5.0	Passed
13	15534.060	69.3	74.0	4.7	-32.8	5.0	Passed
Average Emission – Restricted Band							
Operation Mode	Frequency [MHz]	Field Strength [dBuV/m]	Average Limit [dBuV/m]	Margin [dB]	Reading [dBm]	Antenna Gain + Array Gain [dBi]	Result
13	5119.990	48.3	54.0	5.7	-52.9	5.0	Passed
13	4879.960	43.5	54.0	10.5	-57.7	5.0	Passed
13	5079.920	44.1	54.0	9.9	-57.1	5.0	Passed
13	15539.200	44.8	54.0	9.2	-57.3	5.0	Passed
Emissions in the non-restricted Bands							
Operation Mode	Frequency [MHz]	Reading [dBm]	Limit [dBm]	Margin [dB]	Result		
13	2934.280	-53.2	-27.0	26.2	Passed		
13	10362.510	-40.4	-27.0	13.4	Passed		
13	5479.970	-39.6	-27.0	12.6	Passed		
13	5259.170	-43.3	-27.0	16.3	Passed		
Measurement uncertainty				+0.66 dB / -0.72 dB			

Spurious Emissions, a-mode, channel 40, antenna port 1 (Operation mode 8)							
Peak Emission – Restricted Band							
Operation Mode	Frequency [MHz]	Field Strength [dBuV/m]	Peak Limit [dBuV/m]	Margin [dB]	Reading [dBm]	Antenna Gain + Array Gain [dBi]	Result
14	5119.930	54.9	74.0	19.1	-46.3	5.0	Passed
14	5079.680	52.5	74.0	21.5	-48.7	5.0	Passed
14	4879.830	49.9	74.0	24.1	-51.3	5.0	Passed
14	15607.170	69.2	74.0	4.8	-33.0	5.0	Passed
Average Emission – Restricted Band							
Operation Mode	Frequency [MHz]	Field Strength [dBuV/m]	Average Limit [dBuV/m]	Margin [dB]	Reading [dBm]	Antenna Gain + Array Gain [dBi]	Result
14	5119.920	46.5	54.0	7.5	-54.7	5.0	Passed
14	5080.060	42.1	54.0	11.9	-59.2	5.0	Passed
14	4879.930	41.5	54.0	12.5	-59.7	5.0	Passed
14	15602.930	45.1	54.0	8.9	-57.1	5.0	Passed
Emissions in the non-restricted Bands							
Operation Mode	Frequency [MHz]	Reading [dBm]	Limit [dBm]	Margin [dB]	Result		
14	10405.560	-39.6	-27.0	12.6	Passed		
14	5479.870	-42.1	-27.0	15.1	Passed		
14	5275.400	-44.8	-27.0	17.8	Passed		
Measurement uncertainty					+0.66 dB / -0.72 dB		

Spurious Emissions, a-mode, channel 48, antenna port 1 (Operation mode 9)							
Peak Emission – Restricted Band							
Operation Mode	Frequency [MHz]	Field Strength [dBuV/m]	Peak Limit [dBuV/m]	Margin [dB]	Reading [dBm]	Antenna Gain + Array Gain [dBi]	Result
15	5120.090	54.2	74.0	19.8	-47.0	5.0	Passed
15	4879.750	49.8	74.0	24.2	-51.5	5.0	Passed
15	5439.560	58.2	74.0	15.8	-43.1	5.0	Passed
15	15723.700	66.6	74.0	7.4	-35.6	5.0	Passed
Average Emission – Restricted Band							
Operation Mode	Frequency [MHz]	Field Strength [dBuV/m]	Average Limit [dBuV/m]	Margin [dB]	Reading [dBm]	Antenna Gain + Array Gain [dBi]	Result
15	5119.980	46.1	54.0	7.9	-55.2	5.0	Passed
15	4879.950	41.5	54.0	12.5	-59.8	5.0	Passed
15	5440.000	46.3	54.0	7.7	-55.0	5.0	Passed
15	15720.670	44.4	54.0	9.6	-57.7	5.0	Passed
Emissions in the non-restricted Bands							
Operation Mode	Frequency [MHz]	Reading [dBm]	Limit [dBm]	Margin [dB]	Result		
15	2523.880	-53.5	-27.0	26.5	Passed		
15	10478.980	-39.3	-27.0	12.3	Passed		
Measurement uncertainty					+0.66 dB / -0.72 dB		

Spurious Emissions, a-mode, channel 149, antenna port 1 (Operation mode 10)							
Peak Emission – Restricted Band							
Operation Mode	Frequency [MHz]	Field Strength [dBuV/m]	Peak Limit [dBuV/m]	Margin [dB]	Reading [dBm]	Antenna Gain + Array Gain [dBi]	Result
22	5359.692	56.8	74.0	17.2	-44.4	5.0	Passed
22	5439.916	57.9	74.0	16.1	-43.4	5.0	Passed
22	5119.935	53.3	74.0	20.7	-48.0	5.0	Passed
22	11492.537	58.7	74.0	15.3	-43.0	5.0	Passed
Average Emission – Restricted Band							
Operation Mode	Frequency [MHz]	Field Strength [dBuV/m]	Average Limit [dBuV/m]	Margin [dB]	Reading [dBm]	Antenna Gain + Array Gain [dBi]	Result
22	5359.952	47.3	54.0	6.7	-53.9	5.0	Passed
22	5440.006	46.7	54.0	7.3	-54.5	5.0	Passed
22	5120.055	45.8	54.0	8.2	-55.5	5.0	Passed
22	11490.297	44.6	54.0	9.4	-57.2	5.0	Passed
Emissions in the non-restricted Bands							
Operation Mode	Frequency [MHz]	Reading [dBm]	Limit [dBm]	Margin [dB]	Result		
22	5320.291	-43.5	-27.0	16.5	Passed		
22	5479.464	-42.5	-27.0	15.5	Passed		
22	17237.810	-40.1	-27.0	13.1	Passed		
Measurement uncertainty					+0.66 dB / -0.72 dB		

Spurious Emissions, a-mode, channel 157, antenna port 1 (Operation mode 11)							
Peak Emission – Restricted Band							
Operation Mode	Frequency [MHz]	Field Strength [dBuV/m]	Peak Limit [dBuV/m]	Margin [dB]	Reading [dBm]	Antenna Gain + Array Gain [dBi]	Result
23	5360.132	56.7	74.0	17.3	-44.5	5.0	Passed
23	5453.297	56.9	74.0	17.1	-44.4	5.0	Passed
23	11569.680	58.9	74.0	15.1	-43.0	5.0	Passed
Average Emission – Restricted Band							
Operation Mode	Frequency [MHz]	Field Strength [dBuV/m]	Average Limit [dBuV/m]	Margin [dB]	Reading [dBm]	Antenna Gain + Array Gain [dBi]	Result
23	5359.952	46.8	54.0	7.2	-54.5	5.0	Passed
23	5456.127	45.1	54.0	8.9	-56.2	5.0	Passed
23	11569.910	45.2	54.0	8.8	-56.7	5.0	Passed
Emissions in the non-restricted Bands							
Operation Mode	Frequency [MHz]	Reading [dBm]	Limit [dBm]	Margin [dB]	Result		
23	5320.121	-43.3	-27.0	16.3	Passed		
23	5480.007	-42.1	-27.0	15.1	Passed		
23	5559.848	-42.6	-27.0	15.6	Passed		
23	17355.360	-36.7	-27.0	9.7	Passed		
Measurement uncertainty				+0.66 dB / -0.72 dB			

Spurious Emissions, a-mode, channel 165, antenna port 1 (Operation mode 12)							
Peak Emission – Restricted Band							
Operation Mode	Frequency [MHz]	Field Strength [dBuV/m]	Peak Limit [dBuV/m]	Margin [dB]	Reading [dBm]	Antenna Gain + Array Gain [dBi]	Result
24	5360.270	58.9	74.0	15.1	-42.3	5.0	Passed
24	5440.030	59.9	74.0	14.1	-41.3	5.0	Passed
24	11649.645	57.8	74.0	16.2	-44.0	5.0	Passed
Average Emission – Restricted Band							
Operation Mode	Frequency [MHz]	Field Strength [dBuV/m]	Average Limit [dBuV/m]	Margin [dB]	Reading [dBm]	Antenna Gain + Array Gain [dBi]	Result
24	5359.960	49.4	54.0	4.6	-51.9	5.0	Passed
24	5440.040	49.2	54.0	4.8	-52.0	5.0	Passed
24	11650.445	43.8	54.0	10.2	-58.0	5.0	Passed
Emissions in the non-restricted Bands							
Operation Mode	Frequency [MHz]	Reading [dBm]	Limit [dBm]	Margin [dB]	Result		
24	5479.812	-39.8	-27.0	12.8	Passed		
24	5319.810	-41.2	-27.0	14.2	Passed		
24	5559.842	-40.9	-27.0	13.9	Passed		
24	5240.238	-43.8	-27.0	16.8	Passed		
24	17467.600	-39.2	-27.0	12.2	Passed		
Measurement uncertainty					+0.66 dB / -0.72 dB		

Spurious Emissions, n20-mode, channel 36, antenna port 0 (Operation mode 13)							
Peak Emission – Restricted Band							
Operation Mode	Frequency [MHz]	Field Strength [dBuV/m]	Peak Limit [dBuV/m]	Margin [dB]	Reading [dBm]	Antenna Gain + Array Gain [dBi]	Result
25	15545.190	60.3	74.0	13.7	-41.8	5.0	Passed
Average Emission – Restricted Band							
Operation Mode	Frequency [MHz]	Field Strength [dBuV/m]	Average Limit [dBuV/m]	Margin [dB]	Reading [dBm]	Antenna Gain + Array Gain [dBi]	Result
25	15543.680	37.8	54.0	16.2	-64.4	5.0	Passed
Emissions in the non-restricted Bands							
Operation Mode	Frequency [MHz]	Reading [dBm]	Limit [dBm]	Margin [dB]			Result
25	5570.840	-43.7	-27.0	16.7			Passed
25	5280.130	-44.2	-27.0	17.2			Passed
25	6906.630	-46.8	-27.0	19.8			Passed
25	10360.640	-40.3	-27.0	13.3			Passed
Measurement uncertainty				+0.66 dB / -0.72 dB			

Spurious Emissions, n20-mode, channel 40, antenna port 0 (Operation mode 14)							
Peak Emission – Restricted Band							
Operation Mode	Frequency [MHz]	Field Strength [dBuV/m]	Peak Limit [dBuV/m]	Margin [dB]	Reading [dBm]	Antenna Gain + Array Gain [dBi]	Result
26	2792.740	46.8	74.0	27.2	-54.2	5.0	Passed
26	5400.530	53.6	74.0	20.4	-47.6	5.0	Passed
26	15596.480	58.2	74.0	15.8	-44.1	5.0	Passed
Average Emission – Restricted Band							
Operation Mode	Frequency [MHz]	Field Strength [dBuV/m]	Average Limit [dBuV/m]	Margin [dB]	Reading [dBm]	Antenna Gain + Array Gain [dBi]	Result
26	2791.770	35.6	54.0	18.4	-65.4	5.0	Passed
26	5400.080	41.7	54.0	12.3	-59.5	5.0	Passed
26	15597.170	37.1	54.0	16.9	-65.1	5.0	Passed
Emissions in the non-restricted Bands							
Operation Mode	Frequency [MHz]	Reading [dBm]	Limit [dBm]	Margin [dB]			Result
26	10400.580	-40.5	-27.0	13.5			Passed
26	5282.470	-45.4	-27.0	18.4			Passed
26	6933.110	-50.2	-27.0	23.2			Passed
Measurement uncertainty				+0.66 dB / -0.72 dB			

Spurious Emissions, n20-mode, channel 48, antenna port 0 (Operation mode 15)							
Peak Emission – Restricted Band							
Operation Mode	Frequency [MHz]	Field Strength [dBuV/m]	Peak Limit [dBuV/m]	Margin [dB]	Reading [dBm]	Antenna Gain + Array Gain [dBi]	Result
27	5369.040	53.8	74.0	20.2	-47.5	5.0	Passed
27	15718.940	56.1	74.0	17.9	-46.0	5.0	Passed
Average Emission – Restricted Band							
Operation Mode	Frequency [MHz]	Field Strength [dBuV/m]	Average Limit [dBuV/m]	Margin [dB]	Reading [dBm]	Antenna Gain + Array Gain [dBi]	Result
27	5374.740	41.9	54.0	12.1	-59.4	5.0	Passed
27	15720.580	36.9	54.0	17.1	-65.2	5.0	Passed
Emissions in the non-restricted Bands							
Operation Mode	Frequency [MHz]	Reading [dBm]	Limit [dBm]	Margin [dB]	Result		
27	10473.590	-40.8	-27.0	13.8	Passed		
27	6986.680	-51.2	-27.0	24.2	Passed		
Measurement uncertainty				+0.66 dB / -0.72 dB			

Spurious Emissions, n20-mode, channel 149, antenna port 0 (Operation mode 16)							
Peak Emission – Restricted Band							
Operation Mode	Frequency [MHz]	Field Strength [dBuV/m]	Peak Limit [dBuV/m]	Margin [dB]	Reading [dBm]	Antenna Gain + Array Gain [dBi]	Result
34	3829.760	48.9	74.0	25.1	-52.2	5.0	Passed
34	4999.712	57.3	74.0	16.7	-43.9	5.0	Passed
34	11491.409	62.6	74.0	11.4	-39.1	5.0	Passed
Average Emission – Restricted Band							
Operation Mode	Frequency [MHz]	Field Strength [dBuV/m]	Average Limit [dBuV/m]	Margin [dB]	Reading [dBm]	Antenna Gain + Array Gain [dBi]	Result
34	3830.030	40.2	54.0	13.8	-60.8	5.0	Passed
34	4999.822	52.9	54.0	1.1	-48.3	5.0	Passed
34	11490.739	47.1	54.0	6.9	-54.7	5.0	Passed
Emissions in the non-restricted Bands							
Operation Mode	Frequency [MHz]	Reading [dBm]	Limit [dBm]	Margin [dB]	Result		
34	5614.620	-48.0	-27.0	21.0	Passed		
34	5829.506	-48.8	-27.0	21.8	Passed		
34	17237.930	-37.1	-27.0	10.1	Passed		
Measurement uncertainty				+0.66 dB / -0.72 dB			

Spurious Emissions, n20-mode, channel 157, antenna port 0 (Operation mode 17)							
Peak Emission – Restricted Band							
Operation Mode	Frequency [MHz]	Field Strength [dBuV/m]	Peak Limit [dBuV/m]	Margin [dB]	Reading [dBm]	Antenna Gain + Array Gain [dBi]	Result
35	3856.330	48.6	74.0	25.4	-52.5	5.0	Passed
35	4999.770	57.1	74.0	16.9	-44.1	5.0	Passed
35	11571.872	61.1	74.0	12.9	-40.8	5.0	Passed
Average Emission – Restricted Band							
Operation Mode	Frequency [MHz]	Field Strength [dBuV/m]	Average Limit [dBuV/m]	Margin [dB]	Reading [dBm]	Antenna Gain + Array Gain [dBi]	Result
35	3856.650	41.1	54.0	12.9	-60.0	5.0	Passed
35	4999.780	52.7	54.0	1.3	-48.5	5.0	Passed
35	11569.322	47.1	54.0	6.9	-54.8	5.0	Passed
Emissions in the non-restricted Bands							
Operation Mode	Frequency [MHz]	Reading [dBm]	Limit [dBm]	Margin [dB]	Result		
35	5518.323	-47.4	-27.0	20.4	Passed		
35	17353.530	-38.5	-27.0	11.5	Passed		
Measurement uncertainty				+0.66 dB / -0.72 dB			

Spurious Emissions, n20-mode, channel 165, antenna port 0 (Operation mode 18)							
Peak Emission – Restricted Band							
Operation Mode	Frequency [MHz]	Field Strength [dBuV/m]	Peak Limit [dBuV/m]	Margin [dB]	Reading [dBm]	Antenna Gain + Array Gain [dBi]	Result
36	3883.170	50.6	74.0	23.4	-50.5	5.0	Passed
36	11649.272	60.7	74.0	13.3	-41.1	5.0	Passed
Average Emission – Restricted Band							
Operation Mode	Frequency [MHz]	Field Strength [dBuV/m]	Average Limit [dBuV/m]	Margin [dB]	Reading [dBm]	Antenna Gain + Array Gain [dBi]	Result
36	3883.300	43.5	54.0	10.5	-57.6	5.0	Passed
36	11649.372	46.5	54.0	7.5	-55.3	5.0	Passed
Emissions in the non-restricted Bands							
Operation Mode	Frequency [MHz]	Reading [dBm]	Limit [dBm]	Margin [dB]	Result		
36	17476.960	-42.4	-27.0	15.4	Passed		
Measurement uncertainty				+0.66 dB / -0.72 dB			

Spurious Emissions, n20-mode, channel 36, antenna port 1 (Operation mode 19)							
Peak Emission – Restricted Band							
Operation Mode	Frequency [MHz]	Field Strength [dBuV/m]	Peak Limit [dBuV/m]	Margin [dB]	Reading [dBm]	Antenna Gain + Array Gain [dBi]	Result
37	5120.090	55.9	74.0	18.1	-45.4	5.0	Passed
37	5079.870	53.5	74.0	20.5	-47.7	5.0	Passed
37	4959.850	51.3	74.0	22.7	-49.9	5.0	Passed
37	15541.040	70.7	74.0	3.3	-31.4	5.0	Passed
Average Emission – Restricted Band							
Operation Mode	Frequency [MHz]	Field Strength [dBuV/m]	Average Limit [dBuV/m]	Margin [dB]	Reading [dBm]	Antenna Gain + Array Gain [dBi]	Result
37	5120.000	48.4	54.0	5.6	-52.8	5.0	Passed
37	5079.930	44.2	54.0	9.8	-57.0	5.0	Passed
37	4959.920	42.2	54.0	11.8	-59.0	5.0	Passed
37	15540.780	47.9	54.0	6.1	-54.3	5.0	Passed
Emissions in the non-restricted Bands							
Operation Mode	Frequency [MHz]	Reading [dBm]	Limit [dBm]	Margin [dB]	Result		
37	3498.970	-53.5	-27.0	26.5	Passed		
37	10360.350	-39.7	-27.0	12.7	Passed		
37	5479.830	-39.9	-27.0	12.9	Passed		
37	6906.560	-50.9	-27.0	23.9	Passed		
Measurement uncertainty				+0.66 dB / -0.72 dB			

Spurious Emissions, n20-mode, channel 40, antenna port 1 (Operation mode 20)							
Peak Emission – Restricted Band							
Operation Mode	Frequency [MHz]	Field Strength [dBuV/m]	Peak Limit [dBuV/m]	Margin [dB]	Reading [dBm]	Antenna Gain + Array Gain [dBi]	Result
38	5120.270	56.7	74.0	17.3	-44.6	5.0	Passed
38	5079.850	53.6	74.0	20.4	-47.6	5.0	Passed
38	4879.790	51.8	74.0	22.2	-49.5	5.0	Passed
38	4959.860	51.8	74.0	22.2	-49.4	5.0	Passed
38	5433.520	59.1	74.0	14.9	-42.1	5.0	Passed
38	15602.200	70.5	74.0	3.5	-31.7	5.0	Passed
Average Emission – Restricted Band							
Operation Mode	Frequency [MHz]	Field Strength [dBuV/m]	Average Limit [dBuV/m]	Margin [dB]	Reading [dBm]	Antenna Gain + Array Gain [dBi]	Result
38	5119.990	48.5	54.0	5.5	-52.7	5.0	Passed
38	5079.980	44.1	54.0	9.9	-57.1	5.0	Passed
38	4880.000	43.4	54.0	10.6	-57.9	5.0	Passed
38	4959.940	42.2	54.0	11.8	-59.0	5.0	Passed
38	5434.830	47.2	54.0	6.8	-54.0	5.0	Passed
38	15601.190	47.9	54.0	6.1	-54.3	5.0	Passed
Emissions in the non-restricted Bands							
Operation Mode	Frequency [MHz]	Reading [dBm]	Limit [dBm]	Margin [dB]	Result		
38	3099.070	-53.6	-27.0	26.6	Passed		
38	10395.760	-37.8	-27.0	10.8	Passed		
Measurement uncertainty				+0.66 dB / -0.72 dB			

Spurious Emissions, n20-mode, channel 48, antenna port 1 (Operation mode 21)							
Peak Emission – Restricted Band							
Operation Mode	Frequency [MHz]	Field Strength [dBuV/m]	Peak Limit [dBuV/m]	Margin [dB]	Reading [dBm]	Antenna Gain + Array Gain [dBi]	Result
39	5119.760	54.0	74.0	20.0	-47.2	5.0	Passed
39	4879.960	49.9	74.0	24.1	-51.3	5.0	Passed
39	4999.620	51.4	74.0	22.6	-49.9	5.0	Passed
39	5079.920	51.5	74.0	22.5	-49.7	5.0	Passed
39	15723.990	69.7	74.0	4.3	-32.4	5.0	Passed
Average Emission – Restricted Band							
Operation Mode	Frequency [MHz]	Field Strength [dBuV/m]	Average Limit [dBuV/m]	Margin [dB]	Reading [dBm]	Antenna Gain + Array Gain [dBi]	Result
39	5119.990	46.2	54.0	7.8	-55.0	5.0	Passed
39	4879.920	41.4	54.0	12.6	-59.9	5.0	Passed
39	4999.940	39.9	54.0	14.1	-61.3	5.0	Passed
39	5079.990	42.1	54.0	11.9	-59.2	5.0	Passed
39	15722.650	47.8	54.0	6.2	-54.4	5.0	Passed
Emissions in the non-restricted Bands							
Operation Mode	Frequency [MHz]	Reading [dBm]	Limit [dBm]	Margin [dB]	Result		
39	10480.930	-38.0	-27.0	11.0	Passed		
39	5320.020	-42.5	-27.0	15.5	Passed		
39	6987.050	-51.6	-27.0	24.6	Passed		
Measurement uncertainty				+0.66 dB / -0.72 dB			

Spurious Emissions, n20-mode, channel 149, antenna port 1 (Operation mode 22)							
Peak Emission – Restricted Band							
Operation Mode	Frequency [MHz]	Field Strength [dBuV/m]	Peak Limit [dBuV/m]	Margin [dB]	Reading [dBm]	Antenna Gain + Array Gain [dBi]	Result
46	5359.712	57.6	74.0	16.4	-43.7	5.0	Passed
46	5439.743	57.2	74.0	16.8	-44.1	5.0	Passed
46	5119.885	53.4	74.0	20.6	-47.8	5.0	Passed
46	11491.619	59.6	74.0	14.4	-42.2	5.0	Passed
Average Emission – Restricted Band							
Operation Mode	Frequency [MHz]	Field Strength [dBuV/m]	Average Limit [dBuV/m]	Margin [dB]	Reading [dBm]	Antenna Gain + Array Gain [dBi]	Result
46	5359.892	47.0	54.0	7.0	-54.3	5.0	Passed
46	5439.933	46.6	54.0	7.4	-54.6	5.0	Passed
46	5119.975	45.7	54.0	8.3	-55.6	5.0	Passed
46	11489.589	44.9	54.0	9.1	-56.8	5.0	Passed
Emissions in the non-restricted Bands							
Operation Mode	Frequency [MHz]	Reading [dBm]	Limit [dBm]	Margin [dB]	Result		
46	5320.021	-43.2	-27.0	16.2	Passed		
46	5480.064	-41.9	-27.0	14.9	Passed		
46	5560.508	-43.2	-27.0	16.2	Passed		
46	17236.310	-38.8	-27.0	11.8	Passed		
Measurement uncertainty				+0.66 dB / -0.72 dB			

Spurious Emissions, n20-mode, channel 157, antenna port 1 (Operation mode 23)							
Peak Emission – Restricted Band							
Operation Mode	Frequency [MHz]	Field Strength [dBuV/m]	Peak Limit [dBuV/m]	Margin [dB]	Reading [dBm]	Antenna Gain + Array Gain [dBi]	Result
47	5359.990	57.0	74.0	17.0	-44.3	5.0	Passed
47	5119.955	53.4	74.0	20.6	-47.8	5.0	Passed
47	5439.852	57.6	74.0	16.4	-43.7	5.0	Passed
47	11571.510	59.3	74.0	14.7	-42.6	5.0	Passed
Average Emission – Restricted Band							
Operation Mode	Frequency [MHz]	Field Strength [dBuV/m]	Average Limit [dBuV/m]	Margin [dB]	Reading [dBm]	Antenna Gain + Array Gain [dBi]	Result
47	5359.970	46.7	54.0	7.3	-54.5	5.0	Passed
47	5119.935	45.6	54.0	8.4	-55.7	5.0	Passed
47	5439.922	46.7	54.0	7.3	-54.5	5.0	Passed
47	11569.710	45.3	54.0	8.7	-56.7	5.0	Passed
Emissions in the non-restricted Bands							
Operation Mode	Frequency [MHz]	Reading [dBm]	Limit [dBm]	Margin [dB]	Result		
47	5320.200	-43.4	-27.0	16.4	Passed		
47	5479.783	-41.8	-27.0	14.8	Passed		
47	5559.995	-43.1	-27.0	16.1	Passed		
47	17353.580	-37.2	-27.0	10.2	Passed		
Measurement uncertainty				+0.66 dB / -0.72 dB			

Spurious Emissions, n20-mode, channel 165, antenna port 1 (Operation mode 24)							
Peak Emission – Restricted Band							
Operation Mode	Frequency [MHz]	Field Strength [dBuV/m]	Peak Limit [dBuV/m]	Margin [dB]	Reading [dBm]	Antenna Gain + Array Gain [dBi]	Result
48	5360.130	58.9	74.0	15.1	-42.4	5.0	Passed
48	5440.762	59.7	74.0	14.3	-41.5	5.0	Passed
48	5120.225	55.4	74.0	18.6	-45.9	5.0	Passed
48	5419.703	60.2	74.0	13.8	-41.1	5.0	Passed
48	11650.719	57.8	74.0	16.2	-44.0	5.0	Passed
Average Emission – Restricted Band							
Operation Mode	Frequency [MHz]	Field Strength [dBuV/m]	Average Limit [dBuV/m]	Margin [dB]	Reading [dBm]	Antenna Gain + Array Gain [dBi]	Result
48	5360.020	49.2	54.0	4.8	-52.1	5.0	Passed
48	5440.002	49.0	54.0	5.0	-52.3	5.0	Passed
48	5119.965	47.7	54.0	6.3	-53.5	5.0	Passed
48	5420.283	47.1	54.0	6.9	-54.2	5.0	Passed
48	11649.479	43.9	54.0	10.1	-57.9	5.0	Passed
Emissions in the non-restricted Bands							
Operation Mode	Frequency [MHz]	Reading [dBm]	Limit [dBm]	Margin [dB]	Result		
48	5319.850	-41.1	-27.0	14.1	Passed		
48	5479.472	-39.6	-27.0	12.6	Passed		
48	17476.370	-37.9	-27.0	10.9	Passed		
Measurement uncertainty				+0.66 dB / -0.72 dB			

Spurious Emissions, n20-mode, channel 36, antenna port 0&1 (Operation mode 25)							
Peak Emission – Restricted Band							
Operation Mode	Frequency [MHz]	Field Strength [dBuV/m]	Peak Limit [dBuV/m]	Margin [dB]	Reading [dBm]	Antenna Gain + Array Gain [dBi]	Result
49	5084.440	53.7	74.0	20.3	-45.4	3.8	Passed
49	5118.000	53.9	74.0	20.1	-45.1	3.8	Passed
49	4961.250	51.9	74.0	22.1	-47.1	3.8	Passed
49	4880.250	51.1	74.0	22.9	-48.0	3.8	Passed
49	5394.040	56.7	74.0	17.3	-42.4	3.8	Passed
49	15547.870	59.4	74.0	14.6	-39.7	3.8	Passed
Average Emission – Restricted Band							
Operation Mode	Frequency [MHz]	Field Strength [dBuV/m]	Average Limit [dBuV/m]	Margin [dB]	Reading [dBm]	Antenna Gain + Array Gain [dBi]	Result
49	5084.840	44.2	54.0	9.8	-54.9	3.8	Passed
49	5124.830	43.4	54.0	10.6	-55.7	3.8	Passed
49	4962.650	40.3	54.0	13.7	-58.7	3.8	Passed
49	4884.830	40.4	54.0	13.6	-58.7	3.8	Passed
49	5395.500	44.3	54.0	9.7	-54.8	3.8	Passed
49	15539.270	37.3	54.0	16.7	-61.8	3.8	Passed
Emissions in the non-restricted Bands							
Operation Mode	Frequency [MHz]	Reading [dBm]	Limit [dBm]	Margin [dB]	Result		
49	5464.830	-43.3	-27.0	16.3	Passed		
49	6906.620	-48.8	-27.0	21.8	Passed		
49	10356.010	-46.6	-27.0	19.6	Passed		
Measurement uncertainty				+0.66 dB / -0.72 dB			

Spurious Emissions, n20-mode, channel 40, antenna port 0&1 (Operation mode 26)							
Peak Emission – Restricted Band							
Operation Mode	Frequency [MHz]	Field Strength [dBuV/m]	Peak Limit [dBuV/m]	Margin [dB]	Reading [dBm]	Antenna Gain + Array Gain [dBi]	Result
50	4999.850	55.7	74.0	18.3	-43.4	3.8	Passed
50	5075.620	52.9	74.0	21.1	-46.1	3.8	Passed
50	5119.150	53.6	74.0	20.4	-45.5	3.8	Passed
50	4924.280	50.5	74.0	23.5	-48.6	3.8	Passed
50	15604.500	59.2	74.0	14.8	-39.8	3.8	Passed
Average Emission – Restricted Band							
Operation Mode	Frequency [MHz]	Field Strength [dBuV/m]	Average Limit [dBuV/m]	Margin [dB]	Reading [dBm]	Antenna Gain + Array Gain [dBi]	Result
50	4999.820	50.7	54.0	3.3	-48.3	3.8	Passed
50	5079.770	43.9	54.0	10.1	-55.2	3.8	Passed
50	5117.240	43.0	54.0	11.0	-56.0	3.8	Passed
50	4919.990	39.5	54.0	14.5	-59.6	3.8	Passed
50	15602.320	37.4	54.0	16.6	-61.6	3.8	Passed
Emissions in the non-restricted Bands							
Operation Mode	Frequency [MHz]	Reading [dBm]	Limit [dBm]	Margin [dB]	Result		
50	5281.640	-44.3	-27.0	17.3	Passed		
50	5488.330	-43.7	-27.0	16.7	Passed		
50	5280.620	-43.5	-27.0	16.5	Passed		
50	10404.990	-45.5	-27.0	18.5	Passed		
Measurement uncertainty				+0.66 dB / -0.72 dB			

Spurious Emissions, n20-mode, channel 48, antenna port 0&1 (Operation mode 27)							
Peak Emission – Restricted Band							
Operation Mode	Frequency [MHz]	Field Strength [dBuV/m]	Peak Limit [dBuV/m]	Margin [dB]	Reading [dBm]	Antenna Gain + Array Gain [dBi]	Result
51	4999.810	55.4	74.0	18.6	-43.7	3.8	Passed
51	5083.220	51.7	74.0	22.3	-47.3	3.8	Passed
51	5121.570	51.8	74.0	22.2	-47.3	3.8	Passed
51	15727.170	57.6	74.0	16.4	-41.4	3.8	Passed
Average Emission – Restricted Band							
Operation Mode	Frequency [MHz]	Field Strength [dBuV/m]	Average Limit [dBuV/m]	Margin [dB]	Reading [dBm]	Antenna Gain + Array Gain [dBi]	Result
51	4999.840	50.5	54.0	3.5	-48.5	3.8	Passed
51	5079.970	42.0	54.0	12.0	-57.1	3.8	Passed
51	5124.700	41.3	54.0	12.7	-57.8	3.8	Passed
51	15725.250	37.7	54.0	16.3	-61.3	3.8	Passed
51							
Operation Mode	Frequency [MHz]	Reading [dBm]	Limit [dBm]	Margin [dB]	Result		
51	5499.390	-45.3	-27.0	18.3	Passed		
51	10478.880	-46.0	-27.0	19.0	Passed		
51	6986.510	-51.3	-27.0	24.3	Passed		
Measurement uncertainty					+0.66 dB / -0.72 dB		

Spurious Emissions, n20-mode, channel 149, antenna port 0&1 (Operation mode 28)							
Peak Emission – Restricted Band							
Operation Mode	Frequency [MHz]	Field Strength [dBuV/m]	Peak Limit [dBuV/m]	Margin [dB]	Reading [dBm]	Antenna Gain + Array Gain [dBi]	Result
58	3829.790	47.7	74.0	26.3	-51.3	3.8	Passed
58	4999.809	54.3	74.0	19.7	-44.7	3.8	Passed
58	5363.112	53.7	74.0	20.3	-45.4	3.8	Passed
58	5438.223	54.2	74.0	19.8	-44.8	3.8	Passed
58	5078.014	51.0	74.0	23.0	-48.1	3.8	Passed
58	11492.200	55.8	74.0	18.2	-43.2	3.8	Passed
Average Emission – Restricted Band							
Operation Mode	Frequency [MHz]	Field Strength [dBuV/m]	Average Limit [dBuV/m]	Margin [dB]	Reading [dBm]	Antenna Gain + Array Gain [dBi]	Result
58	3829.990	38.9	54.0	15.1	-60.2	3.8	Passed
58	4999.839	49.5	54.0	4.5	-49.6	3.8	Passed
58	5359.842	43.4	54.0	10.6	-55.7	3.8	Passed
58	5439.893	43.3	54.0	10.7	-55.8	3.8	Passed
58	5079.804	41.8	54.0	12.2	-57.3	3.8	Passed
58	11490.630	42.1	54.0	11.9	-56.9	3.8	Passed
Emissions in the non-restricted Bands							
Operation Mode	Frequency [MHz]	Reading [dBm]	Limit [dBm]	Margin [dB]	Result		
58	5319.971	-45.0	-27.0	18.0	Passed		
58	5522.488	-45.6	-27.0	18.6	Passed		
58	5912.330	-52.0	-27.0	25.0	Passed		
58	17240.380	-50.6	-27.0	23.6	Passed		
Measurement uncertainty				+0.66 dB / -0.72 dB			

Spurious Emissions, n20-mode, channel 157, antenna port 0&1 (Operation mode 29)							
Peak Emission – Restricted Band							
Operation Mode	Frequency [MHz]	Field Strength [dBuV/m]	Peak Limit [dBuV/m]	Margin [dB]	Reading [dBm]	Antenna Gain + Array Gain [dBi]	Result
59	3856.720	48.0	74.0	26.0	-51.0	3.8	Passed
59	5077.945	51.1	74.0	22.9	-47.9	3.8	Passed
59	5359.700	53.6	74.0	20.4	-45.4	3.8	Passed
59	4999.903	54.8	74.0	19.2	-44.3	3.8	Passed
59	11573.070	56.2	74.0	17.8	-42.8	3.8	Passed
Average Emission – Restricted Band							
Operation Mode	Frequency [MHz]	Field Strength [dBuV/m]	Average Limit [dBuV/m]	Margin [dB]	Reading [dBm]	Antenna Gain + Array Gain [dBi]	Result
59	3856.670	39.5	54.0	14.5	-59.6	3.8	Passed
59	5080.065	41.7	54.0	12.3	-57.4	3.8	Passed
59	5359.840	43.2	54.0	10.8	-55.9	3.8	Passed
59	4999.852	49.2	54.0	4.8	-49.8	3.8	Passed
59	11570.740	42.3	54.0	11.7	-56.8	3.8	Passed
Emissions in the non-restricted Bands							
Operation Mode	Frequency [MHz]	Reading [dBm]	Limit [dBm]	Margin [dB]	Result		
59	5322.560	-45.5	-27.0	18.5	Passed		
59	5484.453	-44.7	-27.0	17.7	Passed		
59	5520.002	-44.9	-27.0	17.9	Passed		
59	17349.260	-51.5	-27.0	24.5	Passed		
Measurement uncertainty				+0.66 dB / -0.72 dB			

Spurious Emissions, n20-mode, channel 165, antenna port 0&1 (Operation mode 30)							
Peak Emission – Restricted Band							
Operation Mode	Frequency [MHz]	Field Strength [dBuV/m]	Peak Limit [dBuV/m]	Margin [dB]	Reading [dBm]	Antenna Gain + Array Gain [dBi]	Result
60	3883.550	48.7	74.0	25.3	-50.3	3.8	Passed
60	4999.720	55.6	74.0	18.4	-43.4	3.8	Passed
60	5357.970	55.8	74.0	18.2	-43.2	3.8	Passed
60	5439.323	56.4	74.0	17.6	-42.7	3.8	Passed
60	5080.755	52.9	74.0	21.1	-46.1	3.8	Passed
60	11651.177	55.1	74.0	18.9	-43.9	3.8	Passed
Average Emission – Restricted Band							
Operation Mode	Frequency [MHz]	Field Strength [dBuV/m]	Average Limit [dBuV/m]	Margin [dB]	Reading [dBm]	Antenna Gain + Array Gain [dBi]	Result
60	3883.300	41.4	54.0	12.6	-57.6	3.8	Passed
60	4999.840	50.9	54.0	3.1	-48.1	3.8	Passed
60	5360.100	45.2	54.0	8.8	-53.9	3.8	Passed
60	5440.083	45.2	54.0	8.8	-53.8	3.8	Passed
60	5079.645	43.6	54.0	10.4	-55.4	3.8	Passed
60	11649.877	41.8	54.0	12.2	-57.2	3.8	Passed
Emissions in the non-restricted Bands							
Operation Mode	Frequency [MHz]	Reading [dBm]	Limit [dBm]	Margin [dB]	Result		
60	5319.780	-43.5	-27.0	16.5	Passed		
60	5476.903	-43.0	-27.0	16.0	Passed		
60	5521.623	-43.1	-27.0	16.1	Passed		
60	5243.780	-45.7	-27.0	18.7	Passed		
Measurement uncertainty				+0.66 dB / -0.72 dB			

Spurious Emissions, n40-mode, channel 38, antenna port 0 (Operation mode 31)							
Peak Emission – Restricted Band							
Operation Mode	Frequency [MHz]	Field Strength [dBuV/m]	Peak Limit [dBuV/m]	Margin [dB]	Reading [dBm]	Antenna Gain + Array Gain [dBi]	Result
61	5415.230	54.3	74.0	19.7	-47.0	5.0	Passed
Average Emission – Restricted Band							
Operation Mode	Frequency [MHz]	Field Strength [dBuV/m]	Average Limit [dBuV/m]	Margin [dB]	Reading [dBm]	Antenna Gain + Array Gain [dBi]	Result
61	5417.750	41.9	54.0	12.1	-59.4	5.0	Passed
Emissions in the non-restricted Bands							
Operation Mode	Frequency [MHz]	Reading [dBm]	Limit [dBm]	Margin [dB]	Result		
61	5265.310	-46.9	-27.0	19.9	Passed		
61	6919.860	-50.2	-27.0	23.2	Passed		
61	10382.420	-49.1	-27.0	22.1	Passed		
Measurement uncertainty					+0.66 dB / -0.72 dB		

Spurious Emissions, n40-mode, channel 46, antenna port 0 (Operation mode 32)							
Peak Emission – Restricted Band							
Operation Mode	Frequency [MHz]	Field Strength [dBuV/m]	Peak Limit [dBuV/m]	Margin [dB]	Reading [dBm]	Antenna Gain + Array Gain [dBi]	Result
62	4999.920	56.9	74.0	17.1	-44.3	5.0	Passed
62	5067.470	50.3	74.0	23.7	-51.0	5.0	Passed
Average Emission – Restricted Band							
Operation Mode	Frequency [MHz]	Field Strength [dBuV/m]	Average Limit [dBuV/m]	Margin [dB]	Reading [dBm]	Antenna Gain + Array Gain [dBi]	Result
62	4999.820	52.5	54.0	1.5	-48.7	5.0	Passed
62	5071.030	38.6	54.0	15.4	-62.6	5.0	Passed
Emissions in the non-restricted Bands							
Operation Mode	Frequency [MHz]	Reading [dBm]	Limit [dBm]	Margin [dB]	Result		
62	5472.990	-47.2	-27.0	20.2	Passed		
62	6973.220	-51.8	-27.0	24.8	Passed		
Measurement uncertainty					+0.66 dB / -0.72 dB		

Spurious Emissions, n40-mode, channel 151, antenna port 0 (Operation mode 33)							
Peak Emission – Restricted Band							
Operation Mode	Frequency [MHz]	Field Strength [dBuV/m]	Peak Limit [dBuV/m]	Margin [dB]	Reading [dBm]	Antenna Gain + Array Gain [dBi]	Result
68	3836.660	47.7	74.0	26.3	-53.4	5.0	Passed
68	4999.733	55.2	74.0	18.8	-46.1	5.0	Passed
68	5430.745	50.2	74.0	23.8	-51.1	5.0	Passed
68	11508.410	54.5	74.0	19.5	-47.3	5.0	Passed
Average Emission – Restricted Band							
Operation Mode	Frequency [MHz]	Field Strength [dBuV/m]	Average Limit [dBuV/m]	Margin [dB]	Reading [dBm]	Antenna Gain + Array Gain [dBi]	Result
68	3836.650	39.2	54.0	14.8	-61.9	5.0	Passed
68	4999.833	50.6	54.0	3.4	-50.7	5.0	Passed
68	5426.305	38.2	54.0	15.8	-63.1	5.0	Passed
68	11509.260	40.5	54.0	13.5	-61.3	5.0	Passed
Emissions in the non-restricted Bands							
Operation Mode	Frequency [MHz]	Reading [dBm]	Limit [dBm]	Margin [dB]	Result		
68	-	-	-	-	-		
Measurement uncertainty			+0.66 dB / -0.72 dB				

Spurious Emissions, n40-mode, channel 159, antenna port 0 (Operation mode 34)							
Peak Emission – Restricted Band							
Operation Mode	Frequency [MHz]	Field Strength [dBuV/m]	Peak Limit [dBuV/m]	Margin [dB]	Reading [dBm]	Antenna Gain + Array Gain [dBi]	Result
69	3863.240	48.9	74.0	25.1	-52.2	5.0	Passed
69	4999.660	56.4	74.0	17.6	-44.8	5.0	Passed
69	11588.923	54.9	74.0	19.1	-47.1	5.0	Passed
Average Emission – Restricted Band							
Operation Mode	Frequency [MHz]	Field Strength [dBuV/m]	Average Limit [dBuV/m]	Margin [dB]	Reading [dBm]	Antenna Gain + Array Gain [dBi]	Result
69	3863.290	40.9	54.0	13.1	-60.2	5.0	Passed
69	4999.820	52.4	54.0	1.6	-48.8	5.0	Passed
69	11589.773	40.3	54.0	13.7	-61.7	5.0	Passed
Emissions in the non-restricted Bands							
Operation Mode	Frequency [MHz]	Reading [dBm]	Limit [dBm]	Margin [dB]	Result		
69	5487.530	-48.6	-27.0	21.6	Passed		
Measurement uncertainty			+0.66 dB / -0.72 dB				

Spurious Emissions, n40-mode, channel 38, antenna port 1 (Operation mode 35)							
Peak Emission – Restricted Band							
Operation Mode	Frequency [MHz]	Field Strength [dBuV/m]	Peak Limit [dBuV/m]	Margin [dB]	Reading [dBm]	Antenna Gain + Array Gain [dBi]	Result
70	5122.170	60.2	74.0	13.8	-41.1	5.0	Passed
70	5080.010	51.4	74.0	22.6	-49.8	5.0	Passed
70	4880.290	49.7	74.0	24.3	-51.5	5.0	Passed
70	5402.510	57.3	74.0	16.7	-44.0	5.0	Passed
70	15581.350	60.3	74.0	13.7	-41.9	5.0	Passed
Average Emission – Restricted Band							
Operation Mode	Frequency [MHz]	Field Strength [dBuV/m]	Average Limit [dBuV/m]	Margin [dB]	Reading [dBm]	Antenna Gain + Array Gain [dBi]	Result
70	5119.960	46.4	54.0	7.6	-54.8	5.0	Passed
70	5079.950	41.9	54.0	12.1	-59.3	5.0	Passed
70	4879.950	41.4	54.0	12.6	-59.8	5.0	Passed
70	5401.750	44.8	54.0	9.2	-56.4	5.0	Passed
70	15581.310	38.7	54.0	15.3	-63.6	5.0	Passed
Emissions in the non-restricted Bands							
Operation Mode	Frequency [MHz]	Reading [dBm]	Limit [dBm]	Margin [dB]	Result		
70	2571.530	-53.9	-27.0	26.9	Passed		
70	5248.060	-38.9	-27.0	11.9	Passed		
70	5537.250	-43.7	-27.0	16.7	Passed		
70	6920.100	-50.5	-27.0	23.5	Passed		
70	10384.850	-45.7	-27.0	18.7	Passed		
Measurement uncertainty				+0.66 dB / -0.72 dB			

Spurious Emissions, n40-mode, channel 46, antenna port 1 (Operation mode 36)							
Peak Emission – Restricted Band							
Operation Mode	Frequency [MHz]	Field Strength [dBuV/m]	Peak Limit [dBuV/m]	Margin [dB]	Reading [dBm]	Antenna Gain + Array Gain [dBi]	Result
71	5120.160	54.1	74.0	19.9	-47.1	5.0	Passed
71	4879.980	49.8	74.0	24.2	-51.5	5.0	Passed
71	4960.030	50.3	74.0	23.7	-50.9	5.0	Passed
71	5080.920	51.4	74.0	22.6	-49.9	5.0	Passed
71	15689.030	57.3	74.0	16.7	-44.8	5.0	Passed
Average Emission – Restricted Band							
Operation Mode	Frequency [MHz]	Field Strength [dBuV/m]	Average Limit [dBuV/m]	Margin [dB]	Reading [dBm]	Antenna Gain + Array Gain [dBi]	Result
71	5119.980	46.3	54.0	7.7	-55.0	5.0	Passed
71	4880.030	41.5	54.0	12.5	-59.7	5.0	Passed
71	4960.020	40.4	54.0	13.6	-60.8	5.0	Passed
71	5080.010	41.7	54.0	12.3	-59.6	5.0	Passed
71	15693.370	37.5	54.0	16.5	-64.6	5.0	Passed
Emissions in the non-restricted Bands							
Operation Mode	Frequency [MHz]	Reading [dBm]	Limit [dBm]	Margin [dB]	Result		
71	5458.340	-42.8	-27.0	15.8	Passed		
71	6973.290	-50.7	-27.0	23.7	Passed		
71	10468.180	-48.2	-27.0	21.2	Passed		
Measurement uncertainty				+0.66 dB / -0.72 dB			

Spurious Emissions, n40-mode, channel 151, antenna port 1 (Operation mode 37)							
Peak Emission – Restricted Band							
Operation Mode	Frequency [MHz]	Field Strength [dBuV/m]	Peak Limit [dBuV/m]	Margin [dB]	Reading [dBm]	Antenna Gain + Array Gain [dBi]	Result
77	3836.920	46.1	74.0	27.9	-55.0	5.0	Passed
77	5360.132	56.8	74.0	17.2	-44.5	5.0	Passed
77	5439.743	56.9	74.0	17.1	-44.3	5.0	Passed
77	5120.034	53.0	74.0	21.0	-48.2	5.0	Passed
77	11509.320	51.8	74.0	22.2	-50.0	5.0	Passed
Average Emission – Restricted Band							
Operation Mode	Frequency [MHz]	Field Strength [dBuV/m]	Average Limit [dBuV/m]	Margin [dB]	Reading [dBm]	Antenna Gain + Array Gain [dBi]	Result
77	3836.670	35.6	54.0	18.4	-65.5	5.0	Passed
77	5359.952	46.6	54.0	7.4	-54.6	5.0	Passed
77	5440.013	46.4	54.0	7.6	-54.8	5.0	Passed
77	5119.965	45.5	54.0	8.5	-55.7	5.0	Passed
77	11509.920	38.9	54.0	15.1	-62.9	5.0	Passed
Emissions in the non-restricted Bands							
Operation Mode	Frequency [MHz]	Reading [dBm]	Limit [dBm]	Margin [dB]	Result		
77	5320.561	-43.6	-27.0	16.6	Passed		
77	5479.624	-42.9	-27.0	15.9	Passed		
77	5560.028	-43.6	-27.0	16.6	Passed		
77	5240.020	-46.6	-27.0	19.6	Passed		
77	17268.890	-50.4	-27.0	23.4	Passed		
Measurement uncertainty				+0.66 dB / -0.72 dB			

Spurious Emissions, n40-mode, channel 159, antenna port 1 (Operation mode 38)							
Peak Emission – Restricted Band							
Operation Mode	Frequency [MHz]	Field Strength [dBuV/m]	Peak Limit [dBuV/m]	Margin [dB]	Reading [dBm]	Antenna Gain + Array Gain [dBi]	Result
78	5359.730	55.9	74.0	18.1	-45.3	5.0	Passed
78	5439.552	56.7	74.0	17.3	-44.6	5.0	Passed
78	5119.905	52.8	74.0	21.2	-48.4	5.0	Passed
78	11584.023	53.4	74.0	20.6	-48.6	5.0	Passed
Average Emission – Restricted Band							
Operation Mode	Frequency [MHz]	Field Strength [dBuV/m]	Average Limit [dBuV/m]	Margin [dB]	Reading [dBm]	Antenna Gain + Array Gain [dBi]	Result
78	5359.970	46.4	54.0	7.6	-54.8	5.0	Passed
78	5440.052	46.4	54.0	7.6	-54.9	5.0	Passed
78	5120.005	45.3	54.0	8.7	-55.9	5.0	Passed
78	11588.933	40.3	54.0	13.7	-61.7	5.0	Passed
Emissions in the non-restricted Bands							
Operation Mode	Frequency [MHz]	Reading [dBm]	Limit [dBm]	Margin [dB]	Result		
78	3024.130	-53.8	-27.0	26.8	Passed		
78	5320.120	-43.7	-27.0	16.7	Passed		
78	5479.752	-42.7	-27.0	15.7	Passed		
78	5559.855	-43.6	-27.0	16.6	Passed		
78	17385.560	-48.2	-27.0	21.2	Passed		
Measurement uncertainty				+0.66 dB / -0.72 dB			

Spurious Emissions, n40-mode, channel 38, antenna port 0&1 (Operation mode 39)							
Peak Emission – Restricted Band							
Operation Mode	Frequency [MHz]	Field Strength [dBuV/m]	Peak Limit [dBuV/m]	Margin [dB]	Reading [dBm]	Antenna Gain + Array Gain [dBi]	Result
79	4999.690	55.4	74.0	18.6	-43.7	3.8	Passed
79	5078.970	51.8	74.0	22.2	-47.3	3.8	Passed
79	5123.430	53.2	74.0	20.8	-45.8	3.8	Passed
79	4880.370	49.5	74.0	24.5	-49.6	3.8	Passed
79	15582.650	49.9	74.0	24.1	-49.2	3.8	Passed
Average Emission – Restricted Band							
Operation Mode	Frequency [MHz]	Field Strength [dBuV/m]	Average Limit [dBuV/m]	Margin [dB]	Reading [dBm]	Antenna Gain + Array Gain [dBi]	Result
79	4999.800	50.5	54.0	3.5	-48.6	3.8	Passed
79	5084.790	42.2	54.0	11.8	-56.8	3.8	Passed
79	5124.850	41.3	54.0	12.7	-57.8	3.8	Passed
79	4884.030	38.9	54.0	15.1	-60.2	3.8	Passed
79	15582.510	35.4	54.0	18.6	-63.7	3.8	Passed
Emissions in the non-restricted Bands							
Operation Mode	Frequency [MHz]	Reading [dBm]	Limit [dBm]	Margin [dB]	Result		
79	5468.180	-45.5	-27.0	18.5	Passed		
79	5479.750	-44.9	-27.0	17.9	Passed		
Measurement uncertainty				+0.66 dB / -0.72 dB			

Spurious Emissions, n40-mode, channel 46, antenna port 0&1 (Operation mode 40)							
Peak Emission – Restricted Band							
Operation Mode	Frequency [MHz]	Field Strength [dBuV/m]	Peak Limit [dBuV/m]	Margin [dB]	Reading [dBm]	Antenna Gain + Array Gain [dBi]	Result
80	4999.780	54.3	74.0	19.7	-44.7	3.8	Passed
80	5078.510	51.0	74.0	23.0	-48.0	3.8	Passed
80	5124.560	51.1	74.0	22.9	-47.9	3.8	Passed
80	4882.290	49.2	74.0	24.8	-49.9	3.8	Passed
Average Emission – Restricted Band							
Operation Mode	Frequency [MHz]	Field Strength [dBuV/m]	Average Limit [dBuV/m]	Margin [dB]	Reading [dBm]	Antenna Gain + Array Gain [dBi]	Result
80	4999.820	49.1	54.0	4.9	-50.0	3.8	Passed
80	5079.950	41.9	54.0	12.1	-57.1	3.8	Passed
80	5124.740	40.9	54.0	13.1	-58.2	3.8	Passed
80	4883.070	38.6	54.0	15.4	-60.4	3.8	Passed
Emissions in the non-restricted Bands							
Operation Mode	Frequency [MHz]	Reading [dBm]	Limit [dBm]	Margin [dB]	Result		
80	5527.900	-46.2	-27.0	19.2	Passed		
80	5464.110	-46.1	-27.0	19.1	Passed		
Measurement uncertainty					+0.66 dB / -0.72 dB		

Spurious Emissions, n40-mode, channel 151, antenna port 0&1 (Operation mode 41)							
Peak Emission – Restricted Band							
Operation Mode	Frequency [MHz]	Field Strength [dBuV/m]	Peak Limit [dBuV/m]	Margin [dB]	Reading [dBm]	Antenna Gain + Array Gain [dBi]	Result
86	3836.610	47.6	74.0	26.4	-51.4	3.8	Passed
86	4999.742	53.3	74.0	20.7	-45.7	3.8	Passed
86	4859.722	48.2	74.0	25.8	-50.8	3.8	Passed
86	5357.812	53.6	74.0	20.4	-45.5	3.8	Passed
86	5083.864	50.8	74.0	23.2	-48.3	3.8	Passed
86	5403.322	53.7	74.0	20.3	-45.4	3.8	Passed
86	11509.980	49.8	74.0	24.2	-49.3	3.8	Passed
Average Emission – Restricted Band							
Operation Mode	Frequency [MHz]	Field Strength [dBuV/m]	Average Limit [dBuV/m]	Margin [dB]	Reading [dBm]	Antenna Gain + Array Gain [dBi]	Result
86	3836.620	38.4	54.0	15.6	-60.7	3.8	Passed
86	4999.822	47.7	54.0	6.3	-51.3	3.8	Passed
86	4861.042	36.5	54.0	17.5	-62.5	3.8	Passed
86	5359.992	43.0	54.0	11.0	-56.1	3.8	Passed
86	5080.204	41.6	54.0	12.4	-57.5	3.8	Passed
86	5400.032	42.1	54.0	11.9	-56.9	3.8	Passed
86	11508.930	37.6	54.0	16.4	-61.4	3.8	Passed
Emissions in the non-restricted Bands							
Operation Mode	Frequency [MHz]	Reading [dBm]	Limit [dBm]	Margin [dB]	Result		
86	5322.181	-45.9	-27.0	18.9	Passed		
86	5479.684	-45.6	-27.0	18.6	Passed		
Measurement uncertainty				+0.66 dB / -0.72 dB			

Spurious Emissions, n40-mode, channel 159, antenna port 0&1 (Operation mode 42)							
Peak Emission – Restricted Band							
Operation Mode	Frequency [MHz]	Field Strength [dBuV/m]	Peak Limit [dBuV/m]	Margin [dB]	Reading [dBm]	Antenna Gain + Array Gain [dBi]	Result
87	3863.300	48.4	74.0	25.6	-50.6	3.8	Passed
87	4999.992	54.7	74.0	19.3	-44.4	3.8	Passed
87	5358.522	53.7	74.0	20.3	-45.4	3.8	Passed
87	5440.116	54.1	74.0	19.9	-45.0	3.8	Passed
87	11598.270	49.8	74.0	24.2	-49.3	3.8	Passed
Average Emission – Restricted Band							
Operation Mode	Frequency [MHz]	Field Strength [dBuV/m]	Average Limit [dBuV/m]	Margin [dB]	Reading [dBm]	Antenna Gain + Array Gain [dBi]	Result
87	3863.300	39.8	54.0	14.2	-59.2	3.8	Passed
87	4999.832	49.4	54.0	4.6	-49.7	3.8	Passed
87	5359.982	43.0	54.0	11.0	-56.0	3.8	Passed
87	5439.866	43.0	54.0	11.0	-56.0	3.8	Passed
87	11589.320	37.6	54.0	16.4	-61.5	3.8	Passed
Emissions in the non-restricted Bands							
Operation Mode	Frequency [MHz]	Reading [dBm]	Limit [dBm]	Margin [dB]	Result		
87	5319.841	-45.2	-27.0	18.2	Passed		
87	5520.467	-45.5	-27.0	18.5	Passed		
87	5477.217	-45.3	-27.0	18.3	Passed		
87	5275.180	-46.9	-27.0	19.9	Passed		
87	5240.736	-47.4	-27.0	20.4	Passed		
Measurement uncertainty				+0.66 dB / -0.72 dB			

Test: Passed

TEST EQUIPMENT USED FOR THE TEST:
6 – 10, 30

5.6.4 Method of measurement (radiated emissions)

The radiated emission measurement is subdivided into five stages.

- A preliminary measurement carried out in a fully anechoic chamber with a fixed antenna height in the frequency range 9 kHz to 1 GHz.
- A final measurement carried out on an outdoor test site without reflecting ground plane and a fixed antenna height in the frequency range 9 kHz to 30 MHz.
- A final measurement carried out on an open area test site with reflecting ground plane and various antenna height in the frequency range 30 MHz to 1 GHz.
- A preliminary measurement carried out in a fully anechoic chamber with a variable antenna distance and height in the frequency range 1 GHz to 25 / 40 GHz.
- A final measurement carried out in a fully anechoic chamber with a fixed antenna height in the frequency range 1 GHz to 25 / 40 GHz.

Preliminary measurement (9 kHz to 30 MHz):

In the first stage a preliminary measurement will be performed in a shielded room with a measuring distance of 3 meters. Tabletop and moular devices will set up on a EUT turn device on a height of 1.5 m and a height of 80 cm. Floor-standing devices will be placed directly on the turntable/ground plane. The set up of the Equipment under test will be in accordance to [1].

The frequency range 9 kHz to 30 MHz will be monitored with a spectrum analyser while the system and its cables will be manipulated to find out the configuration with the maximum emission levels if applicable. The EMI Receiver will be set to MAX Hold mode. The EUT and the measuring antenna will be rotated around their vertical axis to found the maximum emissions.

The resolution bandwidth of the spectrum analyser will be set to the following values:

Frequency range	Resolution bandwidth
9 kHz to 150 kHz	200 Hz
150 kHz to 30 MHz	10 kHz

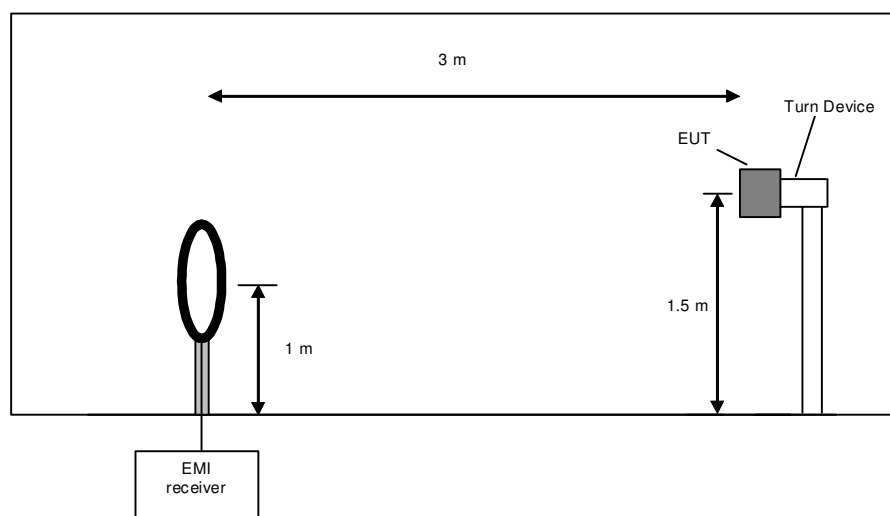

Preliminary measurement procedure:

Prescans were performed in the frequency range 9 kHz to 150 kHz and 150 kHz to 30 MHz.

The following procedure will be used:

- 1) Monitor the frequency range at horizontal polarisation and a EUT azimuth of 0 °.
- 2) Manipulate the system cables within the range to produce the maximum level of emission.
- 3) Rotate the EUT by 360 ° to maximize the detected signals.
- 4) Make a hardcopy of the spectrum.
- 5) Measure the frequencies of highest detected emission with a lower span and resolution bandwidth to increase the accuracy and note the frequency value.
- 6) Repeat steps 1) to 5) with the other orthogonal axes of the EUT (because of EUT is a module and might be used in a handheld equipment application).
- 7) Rotate the measuring antenna and repeat steps 1) to 5).

Final measurement (9 kHz to 30 MHz):

In the second stage a final measurement will be performed on an open area test site with no conducting ground plane in a measuring distances of 3 m, 10 m and 30 m. In the case where larger measuring distances are required the results will be extrapolated based on the values measured on the closer distances according to Section 15.31 (f) (2) [2]. The final measurement will be performed with a EMI Receiver set to Quasi Peak detector except for the frequency bands 9 kHz to 90 kHz and 110 kHz to 490 kHz where an average detector will be used according Section 15.209 (d) [2].

On the frequencies, which were detected during the preliminary measurements, the final measurement will be performed while rotating the EUT and the measuring antenna in the range of 0 ° to 360 ° around their vertical axis until the maximum value is found.

The resolution bandwidth of the EMI Receiver will be set to the following values:

Frequency range	Resolution bandwidth
9 kHz to 150 kHz	200 Hz
150 kHz to 30 MHz	9 kHz

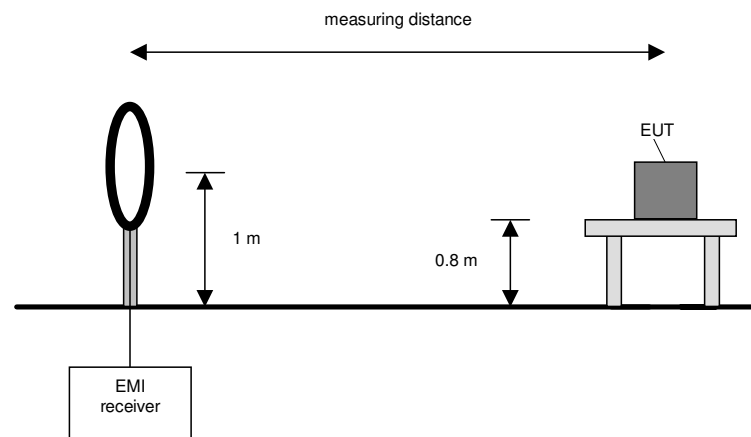

Final measurement procedure:

The following procedure will be used:

- 1) Monitor the frequency range with the measuring antenna at vertical orientation parallel to the EUT at an azimuth of 0 °.
- 2) Rotate the EUT by 360 ° to maximize the detected signals and note the azimuth and orientation.
- 3) Rotate the measuring antenna to find the maximum and note the value.
- 4) Rotate the measuring antenna and repeat steps 1) to 3) until the maximum value is found.
- 5) Repeat steps 1) to 4) with the other orthogonal axes of the EUT (if the EUT is a module and might be used in a handheld equipment application).

Preliminary measurement (30 MHz to 1 GHz)

In the first stage a preliminary measurement will be performed in a fully anechoic chamber with a measuring distance of 3 meter. Table top devices will set up on a non-conducting turn device on the height of 1.5m. Floor-standing devices will be placed directly on the turntable/ground plane. The set up of the Equipment under test will be in accordance to [1].

The frequency range 30 MHz to 1 GHz will be measured with an EMI Receiver set to MAX Hold mode and a resolution bandwidth of 100 kHz. The measurement will be performed in horizontal and vertical polarisation of the measuring antenna and while rotating the EUT in its vertical axis in the range of 0 ° to 360 °. This measurement is repeated after raising the EUT in 30° steps according 6.6.5.4 in [1].

The resolution bandwidth of the EMI Receiver will be set to the following values:

Frequency range	Resolution bandwidth
30 MHz to 230 MHz	100 kHz
230 MHz to 1 GHz	100 kHz

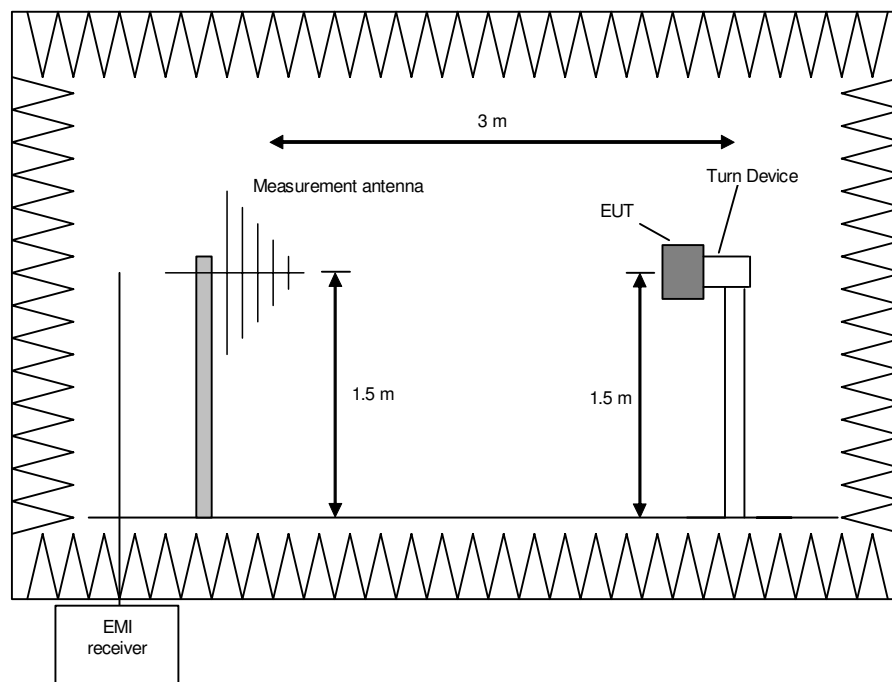

Procedure preliminary measurement:

Prescans were performed in the frequency range 30 MHz to 230 MHz and 230 MHz to 1 GHz.
The following procedure will be used:

1. Monitor the frequency range at horizontal polarisation and a EUT azimuth of 0 °.
2. Manipulate the system cables within the range to produce the maximum level of emission.
3. Rotate the EUT by 360 ° to maximize the detected signals.
4. Repeat 1) to 3) with the vertical polarisation of the measuring antenna.
5. Make a hardcopy of the spectrum.
6. Repeat 1) to 5) with the EUT raised by an angle of 30° (60°, 90°, 120° and 150°) according to 6.6.5.4 in [1].
7. Measure the frequency of the detected emissions with a lower span and resolution bandwidth to increase the accuracy and note the frequency value.

Final measurement (30 MHz to 1 GHz)

A final measurement on an open area test site will be performed on selected frequencies found in the preliminary measurement. During this test the EUT will be rotated in the range of 0 ° to 360 °, the measuring antenna will be set to horizontal and vertical polarisation and raised and lowered in the range from 1 m to 4 m to find the maximum level of emissions.

The resolution bandwidth of the EMI Receiver will be set to the following values:

Frequency range	Resolution bandwidth
30 MHz to 1 GHz	120 kHz

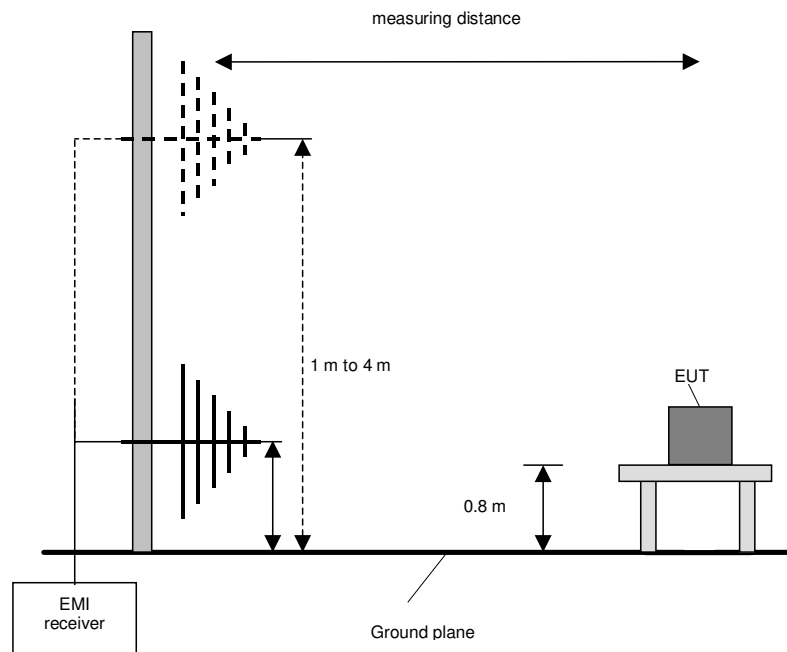

Procedure final measurement:

The following procedure will be used:

- 1) Measure on the selected frequencies at an antenna height of 1 m and a EUT azimuth of 23 °.
- 2) Move the antenna from 1 m to 4 m and note the maximum value at each frequency.
- 3) Rotate the EUT by 45 ° and repeat 2) until an azimuth of 337 ° is reached.
- 4) Repeat 1) to 3) for the other orthogonal antenna polarization.
- 5) Move the antenna and the turntable to the position where the maximum value is detected.
- 6) Measure while moving the antenna slowly +/- 1 m.
- 7) Set the antenna to the position where the maximum value is found.
- 8) Measure while moving the turntable +/- 45 °.
- 9) Set the turntable to the azimuth where the maximum value is found.
- 10) Measure with Final detector (QP and AV) and note the value.
- 11) Repeat 5) to 10) for each frequency.
- 12) Repeat 1) to 11) for each orthogonal axes of the EUT (because of EUT is a module and might be used in a handheld equipment application).

Preliminary and final measurement (1 GHz to 40 GHz)

This measurement will be performed in a fully anechoic chamber. Table top devices will set up on a non-conducting turn device on the height of 1.5m. The set-up of the Equipment under test will be in accordance to [1].

Preliminary measurement (1 GHz to 40 GHz)

The frequency range will be divided into different sub ranges depending of the frequency range of the used horn antenna. The spectrum analyser set to MAX Hold mode and a resolution bandwidth of 100 kHz. The measurement will be performed in horizontal and vertical polarisation of the measuring antenna and while rotating the EUT in its vertical axis in the range of 0 ° to 360 °. This measurement is repeated after raising the EUT in 30° steps according 6.6.5.4 in [1].

The resolution bandwidth of the EMI Receiver will be set to the following values:

Frequency range	Resolution bandwidth
1 GHz to 4 GHz	100 kHz
4 GHz to 12 GHz	100 kHz
12 GHz to 18 GHz	100 kHz
18 GHz to 25 / 26.5 GHz	100 kHz
26.5 GHz to 40 GHz	100 kHz

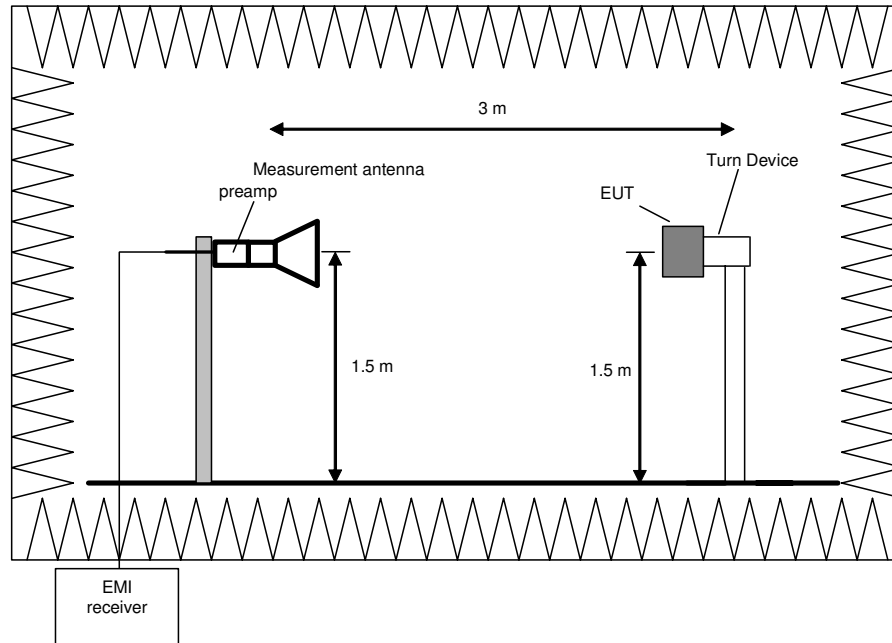

Procedure preliminary measurement:

Prescans were performed in the frequency range 1 to 40 GHz.

The following procedure will be used:

1. Monitor the frequency range at horizontal polarisation and a EUT azimuth of 0°.
2. Rotate the EUT by 360° to maximize the detected signals.
3. Repeat 1) to 2) with the vertical polarisation of the measuring antenna.
4. Make a hardcopy of the spectrum.
5. Repeat 1) to 4) with the EUT raised by an angle of 30° (60°, 90°, 120° and 150°) according to 6.6.5.4 in [1].
6. Measure the frequency of the detected emissions with a lower span and resolution bandwidth to increase the accuracy and note the frequency value.
7. The measurement antenna polarisation, with the according EUT position (Turntable and Turn device) which produces the highest emission for each frequency will be used for the final measurement. The six closest values to the applicable limit will be used for the final measurement.

Final measurement (1 GHz to 25 GHz)

The frequency range will be divided into different sub ranges depending of the frequency range of the used horn antenna. The EMI Receiver set to peak and average mode and a resolution bandwidth of 1 MHz. The measurement will be performed by rotating the turntable through 0 to 360° in the worst-case EUT orientation which was obtained during the preliminary measurements.

The resolution bandwidth of the EMI Receiver will be set to the following values:

Frequency range	Resolution bandwidth
1 GHz to 4 GHz	1 MHz
4 GHz to 12 GHz	1 MHz
12 GHz to 18 GHz	1 MHz
18 GHz to 25 / 26.5 GHz	1 MHz
26.5 GHz to 40 GHz	1 MHz

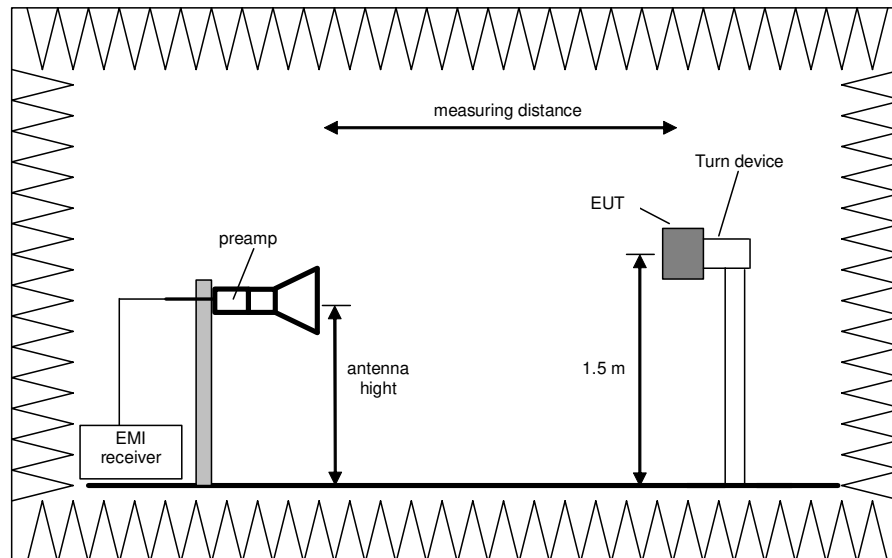

Procedure of measurement:

The measurements were performed in the frequency ranges 1 GHz to 4 GHz, 4 GHz to 12 GHz, 12 GHz to 18 GHz, 18 GHz to 25 GHz.

The following procedure will be used:

- 1) Set the turntable and the turn device to obtain the worst-case emission for the first frequency identified in the preliminary measurements.
- 2) Set the measurement antenna polarisation to the orientation with the highest emission for the first frequency identified in the preliminary measurements.
- 3) Set the spectrum analyser to EMI mode with peak and average detector activated.
- 4) Rotate the turntable from 0° to 360° to find the EUT angle that produces the highest emissions.
- 5) Note the highest displayed peak and average values
- 6) Repeat the steps 1) to 5) for each frequency detected during the preliminary measurements.

5.6.5 Test results (radiated emissions) – Emissions with dedicated antennas

5.6.5.1 Preliminary radiated emission measurement

Ambient temperature	21 °C	Relative humidity	51 %
---------------------	-------	-------------------	------

- Position of EUT:** The EUT was set-up on a non-conducting table of a height of 0.8 m or an EUT turn device of a height of 1.5 m. The distance between EUT and antenna was 3 m.
- Cable guide:** For detail information of test set-up and the cable guide refer to the pictures in Testsetup Foto annex.
- Test record:** All results are shown in the following.
- Supply voltage:** During all measurements the host of the EUT was powered with 24 V DC via an laboratory power supply.
- Remark:** Document [1] states in 11.12.2.1, that in case of conducted measurements, additional radiated cabinet emission measurements must be performed. The measurements were performed at the worst case modulations for each frequency range.
- No emissions up to 20 dB to the limit were found below 30 MHz, therefore only the plots of the worst case emissions are submitted for every frequency range above 30 GHz in the preliminary results.
- The Emissions below 1 GHz were equal for all antenna ports, transmit frequencies, modulation schemes and data rates. Therefore only the results of an exemplary test case are submitted below.

161224_ch36_a-mode_ant0_30M-1G.wmf: Spurious emissions from 30 MHz to 1 GHz (operation mode 1):

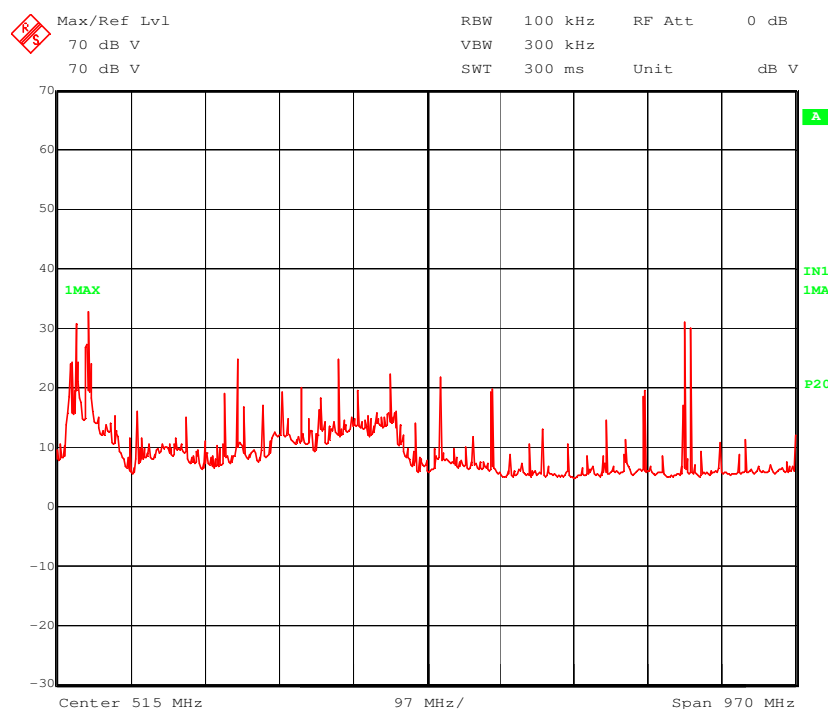

161629 n20 ch36 12-18G ver 0°.wmf: Spurious emissions from 12 to 18 GHz (operation mode 19):

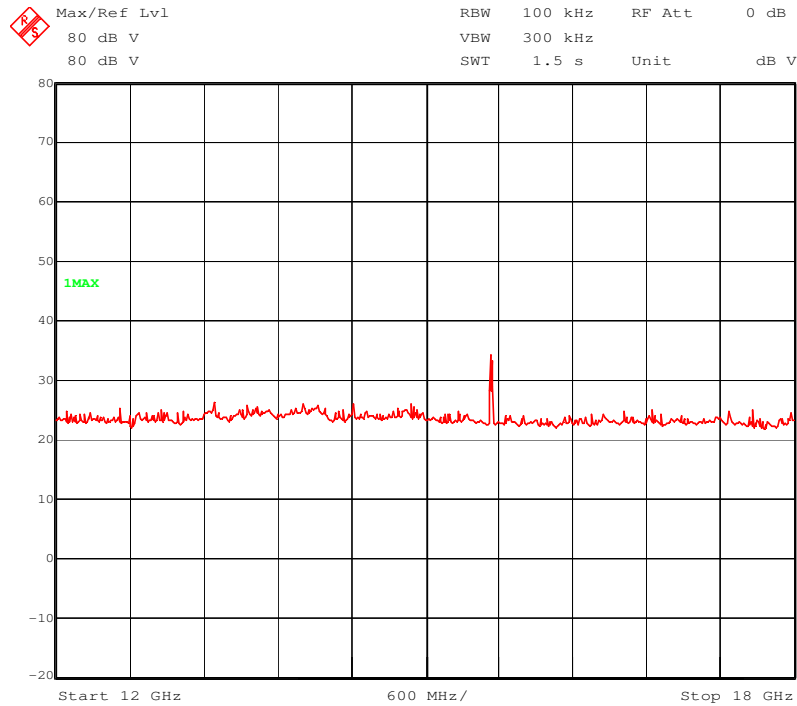

161224 ch165 n20 18-26.5G ant1 Ver.wmf: Spurious emissions from 18 – 26.5 GHz (operation mode 24):

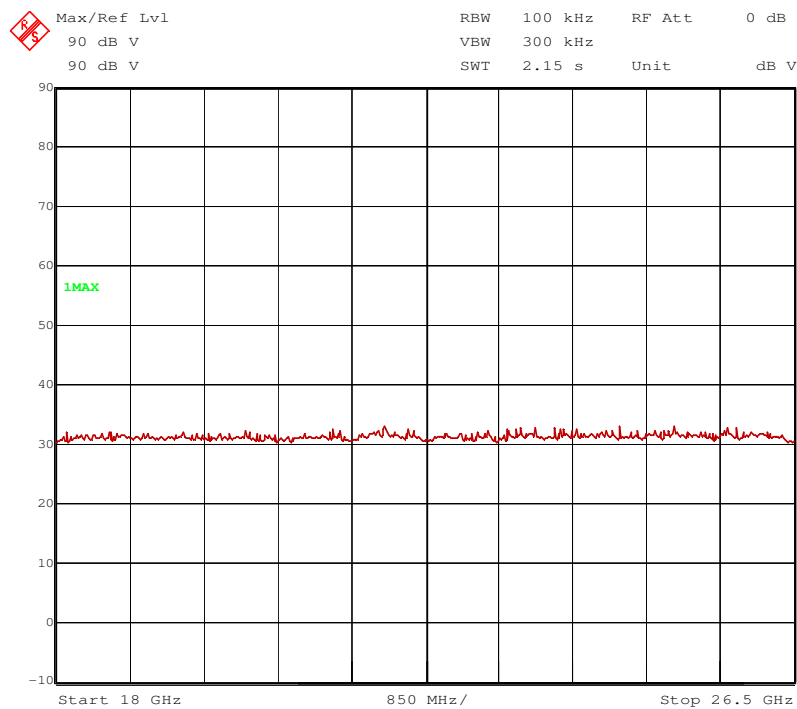

161224 ch165 n20 26.5-40G ant1 Ver.wmf: Spurious emissions from 26.5 - 40 GHz (operation mode 24):

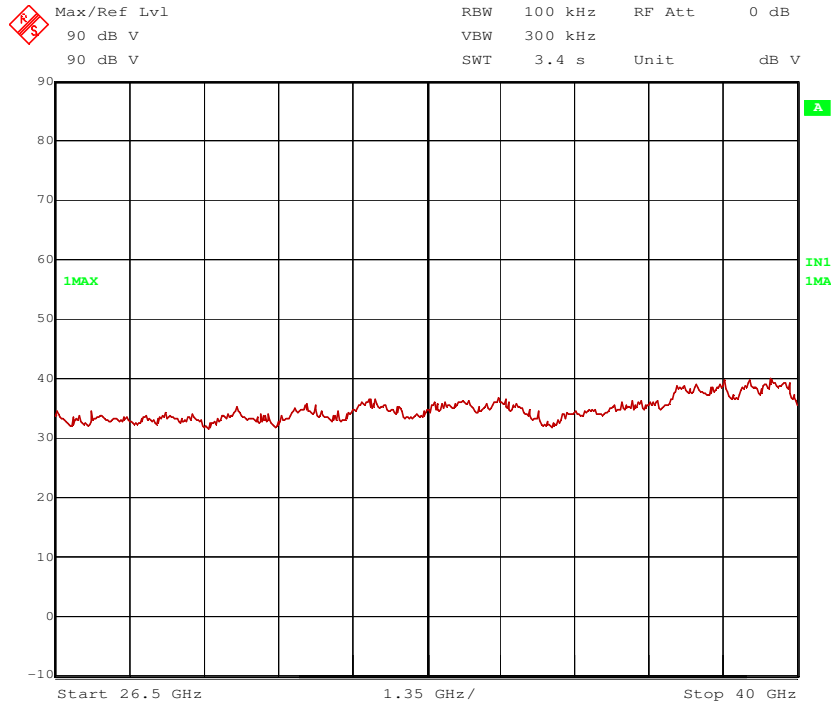

TEST EQUIPMENT USED FOR THE TEST:
29, 31 – 52, 72

5.6.5.2 Final radiated emission measurement (9 kHz to 1 GHz)

Ambient temperature	22 °C	Relative humidity	55 %
---------------------	-------	-------------------	------

- Position of EUT: The EUT was set-up on table with the height of 0.8 m.
- Cable guide: For detail information of test set-up and the cable guide refer to the pictures in test setup photos.
- Test record: All results are shown in the following.
- Supply voltage: During all measurements the host of the EUT was powered with 24 V DC via an laboratory power supply.
- Resolution bandwidth: For all measurements a resolution bandwidth of 100 kHz was used.
- Additional information: All emissions below 30 MHz were more than 20 dB to the limit line, therefore no results are submitted below.

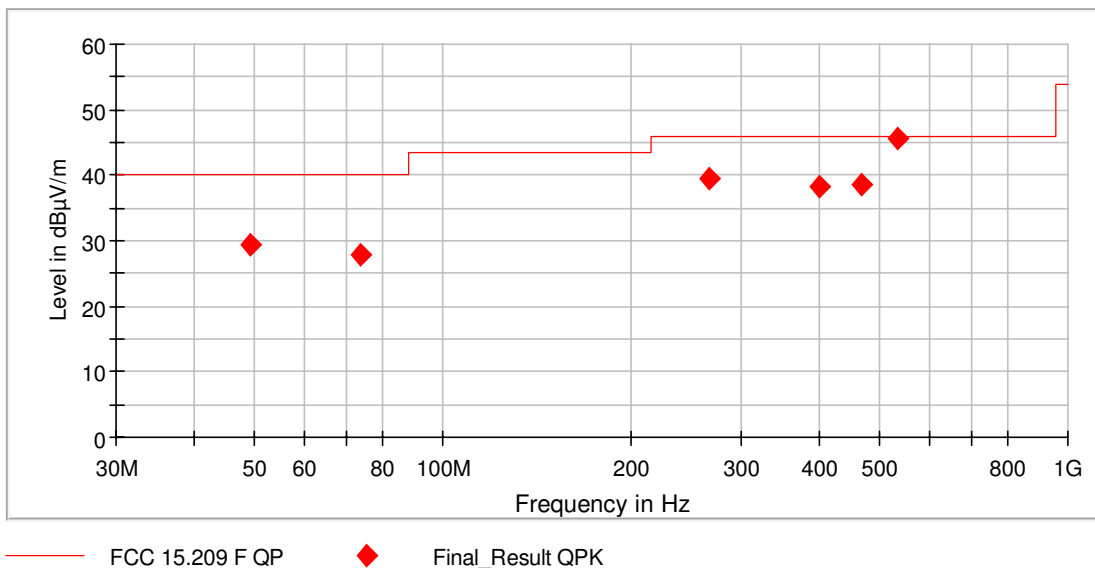

Final_Result

Frequency [MHz]	QuasiPeak [dB μ V/m]	Limit [dB μ V/m]	Margin [dB]	Meas. Time [ms]	Bandwidth [kHz]	Height [cm]	Pol	Azimuth [deg]	Corr. [dB]
49.173	29.42	40.00	10.58	1000.0	120.000	106.0	V	148.0	16.9
73.740	27.79	40.00	12.21	1000.0	120.000	150.0	V	328.0	14.8
266.674	39.39	46.00	6.61	1000.0	120.000	103.0	H	288.0	21.3
400.000	38.28	46.00	7.72	1000.0	120.000	103.0	H	285.0	25.4
466.660	38.64	46.00	7.36	1000.0	120.000	120.0	V	233.0	26.9
533.336	45.56	46.00	0.44	1000.0	120.000	101.0	V	154.0	28.6
Measurement uncertainty					+2.2 dB / -3.6 dB				

5.6.5.3 Final radiated emission measurement (1 GHz to 25 GHz)

Ambient temperature	22 °C	Relative humidity	55 %
---------------------	-------	-------------------	------

- Position of EUT: The EUT was set-up on an EUT turn device of a height of 1.5 m. The distance between EUT and antenna was 3 m.
- Cable guide: For detail information of test set-up and the cable guide refer to the pictures in test setup photos.
- Test record: All results are shown in the following.
- Supply voltage: During all measurements the host of the EUT was powered with 24 V DC via an laboratory power supply.
- Resolution bandwidth: For all measurements a resolution bandwidth of 1 MHz was used.
- Additional information: For simplification all values were compared to the restricted band limits.

Transmitter operates at operation mode 1

Result measured with the peak detector:

Frequency MHz	Meas. Result [dB μ V/m]	Limit [dB μ V/m]	Margin dB	Readings [dB μ V]	Antenna factor [1/m]	Preamp [dB]	Cable loss [dB]	TT pos	EUT angle	Pol.
2499.9	60.5	74.0	13.5	29.0	28.5	0.0	3.0	231°	60°	Hor.
4999.8	53.4	74.0	20.6	40.8	33.1	24.9	4.5	254°	60°	Hor.
10371.0	57.7	74.0	16.3	36.9	37.6	23.5	6.6	262°	60°	Hor.
Measurement uncertainty					+2.2 dB / -3.6 dB					

Result measured with the average detector:

Frequency MHz	Meas. Result [dB μ V/m]	Limit [dB μ V/m]	Margin dB	Readings [dB μ V]	Antenna factor [1/m]	Preamp [dB]	Cable loss [dB]	TT pos	EUT angle	Pol.
2499.9	51.9	54.0	2.1	20.4	28.5	0.0	3.0	220°	60°	Hor.
4999.8	49.0	54.0	5.0	36.4	33.1	24.9	4.5	262°	60°	Hor.
10371.0	42.4	54.0	11.6	21.6	37.6	23.5	6.6	262°	60°	Hor.
Measurement uncertainty					+2.2 dB / -3.6 dB					

Transmitter operates at operation mode 2

Result measured with the peak detector:

Frequency MHz	Meas. Result [dB μ V/m]	Limit [dB μ V/m]	Margin dB	Readings [dB μ V]	Antenna factor [1/m]	Preamp [dB]	Cable loss [dB]	TT pos	EUT angle	Pol.
2499.9	60.1	74.0	13.9	28.6	28.5	0.0	3.0	227°	60°	Hor.
4999.8	53.3	74.0	20.7	40.7	33.1	24.9	4.5	26°	60°	Hor.
10399.1	58.1	74.0	15.9	37.3	37.6	23.4	6.6	262°	60°	Hor.
Measurement uncertainty					+2.2 dB / -3.6 dB					

Result measured with the average detector:

Frequency MHz	Meas. Result [dB μ V/m]	Limit [dB μ V/m]	Margin dB	Readings [dB μ V]	Antenna factor [1/m]	Preamp [dB]	Cable loss [dB]	TT pos	EUT angle	Pol.
2499.9	52.0	54.0	2.0	20.5	28.5	0.0	3.0	223°	60°	Hor.
4999.8	49.1	54.0	4.9	36.5	33.1	24.9	4.5	116°	60°	Hor.
10399.1	44.3	54.0	9.7	23.5	37.6	23.4	6.6	262°	60°	Hor.
Measurement uncertainty					+2.2 dB / -3.6 dB					

Transmitter operates at operation mode 3

Result measured with the peak detector:

Frequency MHz	Meas. Result [dB μ V/m]	Limit [dB μ V/m]	Margin dB	Readings [dB μ V]	Antenna factor [1/m]	Preamp [dB]	Cable loss [dB]	TT pos	EUT angle	Pol.
2499.9	59.7	74.0	14.3	28.2	28.5	0.0	3.0	175°	150°	Hor.
4999.8	51.9	74.0	22.1	39.3	33.1	24.9	4.5	336°	150°	Vert.
Measurement uncertainty					+2.2 dB / -3.6 dB					

Result measured with the average detector:

Frequency MHz	Meas. Result [dB μ V/m]	Limit [dB μ V/m]	Margin dB	Readings [dB μ V]	Antenna factor [1/m]	Preamp [dB]	Cable loss [dB]	TT pos	EUT angle	Pol.
2499.9	50.9	54.0	3.1	19.4	28.5	0.0	3.0	223°	150°	Hor.
4999.8	47.5	54.0	6.5	34.9	33.1	24.9	4.5	336°	150°	Vert.
Measurement uncertainty					+2.2 dB / -3.6 dB					

Transmitter operates at operation mode 4

Result measured with the peak detector:

Frequency MHz	Meas. Result [dB μ V/m]	Limit [dB μ V/m]	Margin dB	Readings [dB μ V]	Antenna factor [1/m]	Preamp [dB]	Cable loss [dB]	TT pos	EUT angle	Pol.
2499.5	59.3	74.0	14.7	27.8	28.5	0.0	3.0	252°	60°	Hor.
4999.9	52.2	74.0	21.8	39.6	33.1	24.9	4.5	345°	90°	Hor.
Measurement uncertainty					+2.2 dB / -3.6 dB					

Result measured with the average detector:

Frequency MHz	Meas. Result [dB μ V/m]	Limit [dB μ V/m]	Margin dB	Readings [dB μ V]	Antenna factor [1/m]	Preamp [dB]	Cable loss [dB]	TT pos	EUT angle	Pol.
2499.5	48.3	54.0	5.7	16.8	28.5	0.0	3.0	252°	60°	Hor.
4999.9	47.5	54.0	6.5	34.9	33.1	24.9	4.5	345°	90°	Hor.
Measurement uncertainty					+2.2 dB / -3.6 dB					

Transmitter operates at operation mode 5

Result measured with the peak detector:

Frequency MHz	Meas. Result [dB μ V/m]	Limit [dB μ V/m]	Margin dB	Readings [dB μ V]	Antenna factor [1/m]	Preamp [dB]	Cable loss [dB]	TT pos	EUT angle	Pol.
2499.5	59.3	74.0	14.7	27.8	28.5	0.0	3.0	236°	90°	Hor.
4999.9	52.6	74.0	21.4	40.0	33.1	24.9	4.5	123°	60°	Hor.
Measurement uncertainty					+2.2 dB / -3.6 dB					

Result measured with the average detector:

Frequency MHz	Meas. Result [dB μ V/m]	Limit [dB μ V/m]	Margin dB	Readings [dB μ V]	Antenna factor [1/m]	Preamp [dB]	Cable loss [dB]	TT pos	EUT angle	Pol.
2499.5	47.1	54.0	6.9	15.6	28.5	0.0	3.0	224°	90°	Hor.
4999.9	47.9	54.0	6.1	35.3	33.1	24.9	4.5	254°	60°	Hor.
Measurement uncertainty					+2.2 dB / -3.6 dB					

Transmitter operates at operation mode 6

Result measured with the peak detector:

Frequency MHz	Meas. Result [dB μ V/m]	Limit [dB μ V/m]	Margin dB	Readings [dB μ V]	Antenna factor [1/m]	Preamp [dB]	Cable loss [dB]	TT pos	EUT angle	Pol.
2499.5	59.5	74.0	14.5	28.0	28.5	0.0	3.0	214°	150°	Hor.
4999.9	53.2	74.0	20.8	40.6	33.1	24.9	4.5	265°	60°	Hor.
Measurement uncertainty					+2.2 dB / -3.6 dB					

Result measured with the average detector:

Frequency MHz	Meas. Result [dB μ V/m]	Limit [dB μ V/m]	Margin dB	Readings [dB μ V]	Antenna factor [1/m]	Preamp [dB]	Cable loss [dB]	TT pos	EUT angle	Pol.
2499.5	47.6	54.0	6.4	16.1	28.5	0.0	3.0	230°	150°	Hor.
4999.9	49.1	54.0	4.9	36.5	33.1	24.9	4.5	258°	60°	Hor.
Measurement uncertainty					+2.2 dB / -3.6 dB					

Transmitter operates at operation mode 11

Result measured with the peak detector:

Frequency MHz	Meas. Result [dB μ V/m]	Limit [dB μ V/m]	Margin dB	Readings [dB μ V]	Antenna factor [1/m]	Preamp [dB]	Cable loss [dB]	TT pos	EUT angle	Pol.
17231.9	48.5	74.0	25.5	39.4	33.8	28.6	4.0	82°	150°	Vert.
Measurement uncertainty					+2.2 dB / -3.6 dB					

Result measured with the average detector:

Frequency MHz	Meas. Result [dB μ V/m]	Limit [dB μ V/m]	Margin dB	Readings [dB μ V]	Antenna factor [1/m]	Preamp [dB]	Cable loss [dB]	TT pos	EUT angle	Pol.
17231.9	35.2	54.0	18.8	26.1	33.8	28.6	4.0	85°	150°	Vert.
Measurement uncertainty					+2.2 dB / -3.6 dB					

Transmitter operates at operation mode 13

Result measured with the peak detector:

Frequency MHz	Meas. Result [dB μ V/m]	Limit [dB μ V/m]	Margin dB	Readings [dB μ V]	Antenna factor [1/m]	Preamp [dB]	Cable loss [dB]	TT pos	EUT angle	Pol.
5000.0	54.1	74.0	19.9	41.3	33.1	24.8	4.5	340°	150°	Vert.
10357.7	61.1	74.0	12.9	40.6	37.6	23.7	6.6	266°	60°	Hor.
Measurement uncertainty					+2.2 dB / -3.6 dB					

Result measured with the average detector:

Frequency MHz	Meas. Result [dB μ V/m]	Limit [dB μ V/m]	Margin dB	Readings [dB μ V]	Antenna factor [1/m]	Preamp [dB]	Cable loss [dB]	TT pos	EUT angle	Pol.
5000.0	49.9	54.0	4.1	37.1	33.1	24.8	4.5	340°	150°	Vert.
10357.7	46.1	54.0	7.9	25.6	37.6	23.7	6.6	266°	60°	Hor.
Measurement uncertainty					+2.2 dB / -3.6 dB					

Transmitter operates at operation mode 14

Result measured with the peak detector:

Frequency MHz	Meas. Result [dB μ V/m]	Limit [dB μ V/m]	Margin dB	Readings [dB μ V]	Antenna factor [1/m]	Preamp [dB]	Cable loss [dB]	TT pos	EUT angle	Pol.
2499.9	59.8	74.0	14.2	28.3	28.5	0.0	3.0	217°	90°	Hor.
4999.8	53.2	74.0	20.8	40.6	33.1	24.9	4.5	115°	60°	Hor.
10406.6	58.8	74.0	15.2	38.1	37.6	23.6	6.7	257°	60°	Hor.
Measurement uncertainty					+2.2 dB / -3.6 dB					

Result measured with the average detector:

Frequency MHz	Meas. Result [dB μ V/m]	Limit [dB μ V/m]	Margin dB	Readings [dB μ V]	Antenna factor [1/m]	Preamp [dB]	Cable loss [dB]	TT pos	EUT angle	Pol.
2499.9	49.2	54.0	4.8	17.7	28.5	0.0	3.0	213°	90°	Hor.
4999.8	49.0	54.0	5.0	36.4	33.1	24.9	4.5	122°	60°	Hor.
10406.6	43.9	54.0	10.1	23.2	37.6	23.6	6.7	262°	60°	Hor.
Measurement uncertainty					+2.2 dB / -3.6 dB					

Transmitter operates at operation mode 15

Result measured with the peak detector:

Frequency MHz	Meas. Result [dB μ V/m]	Limit [dB μ V/m]	Margin dB	Readings [dB μ V]	Antenna factor [1/m]	Preamp [dB]	Cable loss [dB]	TT pos	EUT angle	Pol.
2499.5	59.4	74.0	14.6	27.9	28.5	0.0	3.0	226°	60°	Hor.
5000.0	54.3	74.0	19.7	41.5	33.1	24.8	4.5	335°	150°	Vert.
10480.7	58.8	74.0	15.2	38.4	37.5	23.7	6.6	266°	60°	Hor.
Measurement uncertainty					+2.2 dB / -3.6 dB					

Result measured with the average detector:

Frequency MHz	Meas. Result [dB μ V/m]	Limit [dB μ V/m]	Margin dB	Readings [dB μ V]	Antenna factor [1/m]	Preamp [dB]	Cable loss [dB]	TT pos	EUT angle	Pol.
2499.5	49.1	54.0	4.9	17.6	28.5	0.0	3.0	223°	60°	Hor.
5000.0	49.8	54.0	4.2	37.0	33.1	24.8	4.5	335°	150°	Vert.
10480.7	44.3	54.0	9.7	23.9	37.5	23.7	6.6	266°	60°	Hor.
Measurement uncertainty					+2.2 dB / -3.6 dB					

Transmitter operates at operation mode 18

Result measured with the peak detector:

Frequency MHz	Meas. Result [dB μ V/m]	Limit [dB μ V/m]	Margin dB	Readings [dB μ V]	Antenna factor [1/m]	Preamp [dB]	Cable loss [dB]	TT pos	EUT angle	Pol.
4999.9	53.2	74.0	20.8	40.6	33.1	24.9	4.5	123°	60°	Hor.
Measurement uncertainty					+2.2 dB / -3.6 dB					

Result measured with the average detector:

Frequency MHz	Meas. Result [dB μ V/m]	Limit [dB μ V/m]	Margin dB	Readings [dB μ V]	Antenna factor [1/m]	Preamp [dB]	Cable loss [dB]	TT pos	EUT angle	Pol.
4999.9	49.2	54.0	4.8	36.6	33.1	24.9	4.5	123°	60°	Hor.
Measurement uncertainty					+2.2 dB / -3.6 dB					

Transmitter operates at operation mode 19

Result measured with the peak detector:

Frequency MHz	Meas. Result [dB μ V/m]	Limit [dB μ V/m]	Margin dB	Readings [dB μ V]	Antenna factor [1/m]	Preamp [dB]	Cable loss [dB]	TT pos	EUT angle	Pol.
15547.5	60.4	74.0	13.6	50.8	33.7	27.8	3.7	145°	0°	Vert.
Measurement uncertainty					+2.2 dB / -3.6 dB					

Result measured with the average detector:

Frequency MHz	Meas. Result [dB μ V/m]	Limit [dB μ V/m]	Margin dB	Readings [dB μ V]	Antenna factor [1/m]	Preamp [dB]	Cable loss [dB]	TT pos	EUT angle	Pol.
15547.5	34.5	54.0	19.5	24.9	33.7	27.8	3.7	212°	0°	Vert.
Measurement uncertainty					+2.2 dB / -3.6 dB					

Transmitter operates at operation mode 20

Result measured with the peak detector:

Frequency MHz	Meas. Result [dB μ V/m]	Limit [dB μ V/m]	Margin dB	Readings [dB μ V]	Antenna factor [1/m]	Preamp [dB]	Cable loss [dB]	TT pos	EUT angle	Pol.
15670.7	58.9	74.0	15.1	49.0	33.7	27.6	3.7	207°	0°	Vert.
Measurement uncertainty					+2.2 dB / -3.6 dB					

Result measured with the average detector:

Frequency MHz	Meas. Result [dB μ V/m]	Limit [dB μ V/m]	Margin dB	Readings [dB μ V]	Antenna factor [1/m]	Preamp [dB]	Cable loss [dB]	TT pos	EUT angle	Pol.
15670.7	35.4	54.0	18.6	25.5	33.7	27.6	3.7	213°	0°	Vert.
Measurement uncertainty					+2.2 dB / -3.6 dB					

Transmitter operates at operation mode 21

Result measured with the peak detector:

Frequency MHz	Meas. Result [dB μ V/m]	Limit [dB μ V/m]	Margin dB	Readings [dB μ V]	Antenna factor [1/m]	Preamp [dB]	Cable loss [dB]	TT pos	EUT angle	Pol.
15725.9	57.4	74.0	16.6	47.8	33.7	27.8	3.6	230°	120°	Vert.
Measurement uncertainty					+2.2 dB / -3.6 dB					

Result measured with the average detector:

Frequency MHz	Meas. Result [dB μ V/m]	Limit [dB μ V/m]	Margin dB	Readings [dB μ V]	Antenna factor [1/m]	Preamp [dB]	Cable loss [dB]	TT pos	EUT angle	Pol.
15725.9	34.5	54.0	19.5	24.9	33.7	27.8	3.6	230°	120°	Vert.
Measurement uncertainty					+2.2 dB / -3.6 dB					

Transmitter operates at operation mode 22

Result measured with the peak detector:

Frequency MHz	Meas. Result [dB μ V/m]	Limit [dB μ V/m]	Margin dB	Readings [dB μ V]	Antenna factor [1/m]	Preamp [dB]	Cable loss [dB]	TT pos	EUT angle	Pol.
17230.8	48.2	74.0	25.8	39.1	33.8	28.6	4.0	90°	150°	Vert.
22980.1	45.5	74.0	28.5	41.8	37.2	38.1	4.6	97°	90°	Hor.
Measurement uncertainty					+2.2 dB / -3.6 dB					

Result measured with the average detector:

Frequency MHz	Meas. Result [dB μ V/m]	Limit [dB μ V/m]	Margin dB	Readings [dB μ V]	Antenna factor [1/m]	Preamp [dB]	Cable loss [dB]	TT pos	EUT angle	Pol.
17230.8	35.1	54.0	18.9	26.0	33.8	28.6	4.0	82°	150°	Vert.
22980.1	35.4	54.0	18.6	31.7	37.2	38.1	4.6	125°	90°	Hor.
Measurement uncertainty					+2.2 dB / -3.6 dB					

Transmitter operates at operation mode 23

Result measured with the peak detector:

Frequency MHz	Meas. Result [dB μ V/m]	Limit [dB μ V/m]	Margin dB	Readings [dB μ V]	Antenna factor [1/m]	Preamp [dB]	Cable loss [dB]	TT pos	EUT angle	Pol.
17350.0	48.2	74.0	25.8	38.8	33.9	28.4	3.9	206°	150°	Vert.
Measurement uncertainty					+2.2 dB / -3.6 dB					

Result measured with the average detector:

Frequency MHz	Meas. Result [dB μ V/m]	Limit [dB μ V/m]	Margin dB	Readings [dB μ V]	Antenna factor [1/m]	Preamp [dB]	Cable loss [dB]	TT pos	EUT angle	Pol.
17350.0	35.2	54.0	18.8	25.8	33.9	28.4	3.9	206°	150°	Vert.
Measurement uncertainty					+2.2 dB / -3.6 dB					

Transmitter operates at operation mode 24

Result measured with the peak detector:

Frequency MHz	Meas. Result [dB μ V/m]	Limit [dB μ V/m]	Margin dB	Readings [dB μ V]	Antenna factor [1/m]	Preamp [dB]	Cable loss [dB]	TT pos	EUT angle	Pol.
17468.9	49.8	74.0	24.2	40.1	33.9	28.1	3.9	150°	0°	Vert.
23300.1	46.3	74.0	27.7	42.3	37.2	37.9	4.7	78°	90°	Hor.
Measurement uncertainty					+2.2 dB / -3.6 dB					

Result measured with the average detector:

Frequency MHz	Meas. Result [dB μ V/m]	Limit [dB μ V/m]	Margin dB	Readings [dB μ V]	Antenna factor [1/m]	Preamp [dB]	Cable loss [dB]	TT pos	EUT angle	Pol.
17468.9	36.1	54.0	17.9	26.4	33.9	28.1	3.9	150°	0°	Vert.
23300.1	36.9	54.0	17.1	32.9	37.2	37.9	4.7	126°	90°	Hor.
Measurement uncertainty					+2.2 dB / -3.6 dB					

Transmitter operates at operation mode 25

Result measured with the peak detector:

Frequency MHz	Meas. Result [dB μ V/m]	Limit [dB μ V/m]	Margin dB	Readings [dB μ V]	Antenna factor [1/m]	Preamp [dB]	Cable loss [dB]	TT pos	EUT angle	Pol.
2499.5	59.2	74.0	14.8	27.7	28.5	0.0	3.0	258°	0°	Hor.
4999.9	52.0	74.0	22.0	39.4	33.1	24.9	4.5	307°	30°	Hor.
5360.0	50.6	74.0	23.4	37.2	33.7	24.9	4.6	305°	150°	Hor.
10359.0	57.8	74.0	16.2	37.3	37.6	23.7	6.6	94°	150°	Vert.
Measurement uncertainty					+2.2 dB / -3.6 dB					

Result measured with the average detector:

Frequency MHz	Meas. Result [dB μ V/m]	Limit [dB μ V/m]	Margin dB	Readings [dB μ V]	Antenna factor [1/m]	Preamp [dB]	Cable loss [dB]	TT pos	EUT angle	Pol.
2499.5	48.7	54.0	5.3	17.2	28.5	0.0	3.0	258°	0°	Hor.
4999.9	47.3	54.0	6.7	34.7	33.1	24.9	4.5	255°	30°	Hor.
5360.0	41.7	54.0	12.3	28.3	33.7	24.9	4.6	313°	150°	Hor.
10359.0	44.2	54.0	9.8	23.7	37.6	23.7	6.6	125°	150°	Vert.
Measurement uncertainty					+2.2 dB / -3.6 dB					

Transmitter operates at operation mode 26

Result measured with the peak detector:

Frequency MHz	Meas. Result [dB μ V/m]	Limit [dB μ V/m]	Margin dB	Readings [dB μ V]	Antenna factor [1/m]	Preamp [dB]	Cable loss [dB]	TT pos	EUT angle	Pol.
2499.5	60.5	74.0	13.5	29.0	28.5	0.0	3.0	245°	90°	Hor.
5000.0	53.7	74.0	20.3	40.8	33.1	24.8	4.5	268°	60°	Hor.
5360.0	52.4	74.0	21.6	39.0	33.7	24.9	4.6	135°	150°	Hor.
10402.3	60.8	74.0	13.2	40.1	37.6	23.6	6.7	102°	150°	Vert.
Measurement uncertainty					+2.2 dB / -3.6 dB					

Result measured with the average detector:

Frequency MHz	Meas. Result [dB μ V/m]	Limit [dB μ V/m]	Margin dB	Readings [dB μ V]	Antenna factor [1/m]	Preamp [dB]	Cable loss [dB]	TT pos	EUT angle	Pol.
2499.5	48.3	54.0	5.7	16.8	28.5	0.0	3.0	219°	90°	Hor.
5000.0	48.5	54.0	5.5	35.7	33.1	24.8	4.5	268°	60°	Hor.
5360.0	43.2	54.0	10.8	29.8	33.7	24.9	4.6	135°	150°	Hor.
10402.3	45.0	54.0	9.0	24.3	37.6	23.6	6.7	139°	150°	Vert.
Measurement uncertainty					+2.2 dB / -3.6 dB					

Transmitter operates at operation mode 27

Result measured with the peak detector:

Frequency MHz	Meas. Result [dB μ V/m]	Limit [dB μ V/m]	Margin dB	Readings [dB μ V]	Antenna factor [1/m]	Preamp [dB]	Cable loss [dB]	TT pos	EUT angle	Pol.
2499.5	58.8	74.0	15.2	27.3	28.5	0.0	3.0	269°	90°	Hor.
5000.0	53.8	74.0	20.2	41.0	33.1	24.8	4.5	268°	60°	Hor.
5360.0	51.1	74.0	22.9	37.7	33.7	24.9	4.6	102°	60°	Vert.
10481.5	59.2	74.0	14.8	38.8	37.5	23.7	6.6	126°	150°	Vert.
Measurement uncertainty					+2.2 dB / -3.6 dB					

Result measured with the average detector:

Frequency MHz	Meas. Result [dB μ V/m]	Limit [dB μ V/m]	Margin dB	Readings [dB μ V]	Antenna factor [1/m]	Preamp [dB]	Cable loss [dB]	TT pos	EUT angle	Pol.
2499.5	48.8	54.0	5.2	17.3	28.5	0.0	3.0	258°	90°	Hor.
5000.0	48.6	54.0	5.4	35.8	33.1	24.8	4.5	268°	60°	Hor.
5360.0	40.8	54.0	13.2	27.4	33.7	24.9	4.6	139°	60°	Vert.
10481.5	44.8	54.0	9.2	24.4	37.5	23.7	6.6	135°	150°	Vert.
Measurement uncertainty					+2.2 dB / -3.6 dB					

Transmitter operates at operation mode 28

Result measured with the peak detector:

Frequency MHz	Meas. Result [dB μ V/m]	Limit [dB μ V/m]	Margin dB	Readings [dB μ V]	Antenna factor [1/m]	Preamp [dB]	Cable loss [dB]	TT pos	EUT angle	Pol.
2499.5	59.2	74.0	14.8	27.7	28.5	0.0	3.0	336°	120°	Hor.
5000.0	54.5	74.0	19.5	41.7	33.1	24.8	4.5	257°	60°	Vert.
5120.0	48.9	74.0	25.1	35.6	33.5	24.7	4.5	245°	60°	Vert.
5360.0	51.1	74.0	22.9	37.6	33.7	24.9	4.6	252°	150°	Vert.
Measurement uncertainty					+2.2 dB / -3.6 dB					

Result measured with the average detector:

Frequency MHz	Meas. Result [dB μ V/m]	Limit [dB μ V/m]	Margin dB	Readings [dB μ V]	Antenna factor [1/m]	Preamp [dB]	Cable loss [dB]	TT pos	EUT angle	Pol.
2499.5	47.7	54.0	6.3	16.2	28.5	0.0	3.0	219°	120°	Hor.
5000.0	49.0	54.0	5.0	36.2	33.1	24.8	4.5	257°	60°	Vert.
5120.0	38.9	54.0	15.1	25.6	33.5	24.7	4.5	245°	60°	Vert.
5360.0	40.8	54.0	13.2	27.4	33.7	24.9	4.6	290°	150°	Vert.
Measurement uncertainty					+2.2 dB / -3.6 dB					

Transmitter operates at operation mode 29

Result measured with the peak detector:

Frequency MHz	Meas. Result [dB μ V/m]	Limit [dB μ V/m]	Margin dB	Readings [dB μ V]	Antenna factor [1/m]	Preamp [dB]	Cable loss [dB]	TT pos	EUT angle	Pol.
2499.5	59.3	74.0	14.7	27.8	28.5	0.0	3.0	224°	120°	Hor.
5000.0	54.9	74.0	19.1	42.1	33.1	24.8	4.5	346°	90°	Vert.
5120.0	49.5	74.0	24.5	36.2	33.5	24.7	4.5	94°	90°	Vert.
5360.0	50.9	74.0	23.1	37.5	33.7	24.9	4.6	138°	150°	Vert.
Measurement uncertainty					+2.2 dB / -3.6 dB					

Result measured with the average detector:

Frequency MHz	Meas. Result [dB μ V/m]	Limit [dB μ V/m]	Margin dB	Readings [dB μ V]	Antenna factor [1/m]	Preamp [dB]	Cable loss [dB]	TT pos	EUT angle	Pol.
2499.5	47.6	54.0	6.4	16.1	28.5	0.0	3.0	235°	120°	Hor.
5000.0	50.0	54.0	4.0	37.2	33.1	24.8	4.5	346°	90°	Vert.
5120.0	40.0	54.0	14.0	26.7	33.5	24.7	4.5	136°	90°	Vert.
5360.0	42.4	54.0	11.6	29.0	33.7	24.9	4.6	138°	150°	Vert.
Measurement uncertainty					+2.2 dB / -3.6 dB					

Transmitter operates at operation mode 30

Result measured with the peak detector:

Frequency MHz	Meas. Result [dB μ V/m]	Limit [dB μ V/m]	Margin dB	Readings [dB μ V]	Antenna factor [1/m]	Preamp [dB]	Cable loss [dB]	TT pos	EUT angle	Pol.
2499.5	59.3	74.0	14.7	27.8	28.5	0.0	3.0	225°	120°	Hor.
5000.0	55.0	74.0	19.0	42.2	33.1	24.8	4.5	346°	90°	Hor.
5120.0	50.1	74.0	23.9	36.8	33.5	24.7	4.5	106°	120°	Vert.
5360.0	52.4	74.0	21.6	39.0	33.7	24.9	4.6	93°	120°	Vert.
Measurement uncertainty					+2.2 dB / -3.6 dB					

Result measured with the average detector:

Frequency MHz	Meas. Result [dB μ V/m]	Limit [dB μ V/m]	Margin dB	Readings [dB μ V]	Antenna factor [1/m]	Preamp [dB]	Cable loss [dB]	TT pos	EUT angle	Pol.
2499.5	47.5	54.0	6.5	16.0	28.5	0.0	3.0	236°	120°	Hor.
5000.0	50.0	54.0	4.0	37.2	33.1	24.8	4.5	346°	90°	Hor.
5120.0	41.2	54.0	12.8	27.9	33.5	24.7	4.5	93°	120°	Vert.
5360.0	44.3	54.0	9.7	30.9	33.7	24.9	4.6	93°	120°	Vert.
Measurement uncertainty					+2.2 dB / -3.6 dB					

Transmitter operates at operation mode 31

Result measured with the peak detector:

Frequency MHz	Meas. Result [dB μ V/m]	Limit [dB μ V/m]	Margin dB	Readings [dB μ V]	Antenna factor [1/m]	Preamp [dB]	Cable loss [dB]	TT pos	EUT angle	Pol.
4999.8	52.2	74.0	21.8	39.6	33.1	24.9	4.5	249°	60°	Vert.
Measurement uncertainty					+2.2 dB / -3.6 dB					

Result measured with the average detector:

Frequency MHz	Meas. Result [dB μ V/m]	Limit [dB μ V/m]	Margin dB	Readings [dB μ V]	Antenna factor [1/m]	Preamp [dB]	Cable loss [dB]	TT pos	EUT angle	Pol.
4999.8	47.7	54.0	6.3	35.1	33.1	24.9	4.5	116°	60°	Vert.
Measurement uncertainty					+2.2 dB / -3.6 dB					

Transmitter operates at operation mode 32

Result measured with the peak detector:

Frequency MHz	Meas. Result [dB μ V/m]	Limit [dB μ V/m]	Margin dB	Readings [dB μ V]	Antenna factor [1/m]	Preamp [dB]	Cable loss [dB]	TT pos	EUT angle	Pol.
5000.0	53.4	74.0	20.6	40.6	33.1	24.8	4.5	323°	150°	Vert.
Measurement uncertainty					+2.2 dB / -3.6 dB					

Result measured with the average detector:

Frequency MHz	Meas. Result [dB μ V/m]	Limit [dB μ V/m]	Margin dB	Readings [dB μ V]	Antenna factor [1/m]	Preamp [dB]	Cable loss [dB]	TT pos	EUT angle	Pol.
5000.0	48.5	54.0	5.5	35.7	33.1	24.8	4.5	332°	150°	Vert.
Measurement uncertainty					+2.2 dB / -3.6 dB					

5.6.5.4 Final radiated emission measurement at the band-edges (1 GHz to 25 GHz)

Transmitter operates at operation mode 13

Result measured with the peak detector:

Frequency MHz	Meas. Result [dB μ V/m]	Limit [dB μ V/m]	Margin dB	Readings [dB μ V]	Antenna factor [1/m]	Preamp [dB]	Cable loss [dB]	TT pos	EUT angle	Pol.
5147.1	53.5	74.0	20.5	40.1	33.6	24.8	4.5	272°	60°	Hor.
Measurement uncertainty					+2.2 dB / -3.6 dB					

Result measured with the average detector:

Frequency MHz	Meas. Result [dB μ V/m]	Limit [dB μ V/m]	Margin dB	Readings [dB μ V]	Antenna factor [1/m]	Preamp [dB]	Cable loss [dB]	TT pos	EUT angle	Pol.
5147.1	35.1	54.0	18.9	21.7	33.6	24.8	4.5	263°	60°	Hor.
Measurement uncertainty					+2.2 dB / -3.6 dB					

Transmitter operates at operation mode 25

Result measured with the peak detector:

Frequency MHz	Meas. Result [dB μ V/m]	Limit [dB μ V/m]	Margin dB	Readings [dB μ V]	Antenna factor [1/m]	Preamp [dB]	Cable loss [dB]	TT pos	EUT angle	Pol.
5136.3	48.4	74.0	25.6	34.9	33.6	24.6	4.5	235°	0°	Vert.
Measurement uncertainty					+2.2 dB / -3.6 dB					

Result measured with the average detector:

Frequency MHz	Meas. Result [dB μ V/m]	Limit [dB μ V/m]	Margin dB	Readings [dB μ V]	Antenna factor [1/m]	Preamp [dB]	Cable loss [dB]	TT pos	EUT angle	Pol.
5136.3	33.9	54.0	20.1	20.4	33.6	24.6	4.5	314°	0°	Hor.
Measurement uncertainty					+2.2 dB / -3.6 dB					

Transmitter operates at operation mode 57

Transmitter operates at operation mode 31

Result measured with the peak detector:

Frequency MHz	Meas. Result [dB μ V/m]	Limit [dB μ V/m]	Margin dB	Readings [dB μ V]	Antenna factor [1/m]	Preamp [dB]	Cable loss [dB]	TT pos	EUT angle	Pol.
5149.4	57.5	74.0	16.5	44.1	33.6	24.8	4.5	251°	60°	Hor.
Measurement uncertainty					+2.2 dB / -3.6 dB					

Result measured with the average detector:

Frequency MHz	Meas. Result [dB μ V/m]	Limit [dB μ V/m]	Margin dB	Readings [dB μ V]	Antenna factor [1/m]	Preamp [dB]	Cable loss [dB]	TT pos	EUT angle	Pol.
5149.4	36.8	54.0	17.2	23.4	33.6	24.8	4.5	264°	60°	Hor.
Measurement uncertainty					+2.2 dB / -3.6 dB					

Transmitter operates at operation mode 33

Result measured with the peak detector:

Frequency MHz	Meas. Result [dB μ V/m]	Limit [dB μ V/m]	Margin dB	Readings [dB μ V]	Antenna factor [1/m]	Preamp [dB]	Cable loss [dB]	TT pos	EUT angle	Pol.
5723.9	54.7	74.0	19.3	41.1	33.8	25.0	4.8	66°	30°	Hor.
Measurement uncertainty					+2.2 dB / -3.6 dB					

Result measured with the average detector:

Frequency MHz	Meas. Result [dB μ V/m]	Limit [dB μ V/m]	Margin dB	Readings [dB μ V]	Antenna factor [1/m]	Preamp [dB]	Cable loss [dB]	TT pos	EUT angle	Pol.
5723.9	35.9	54.0	18.1	22.3	33.8	25.0	4.8	45°	30°	Hor.
Measurement uncertainty					+2.2 dB / -3.6 dB					

Transmitter operates at operation mode 38

Result measured with the peak detector:

Frequency MHz	Meas. Result [dB μ V/m]	Limit [dB μ V/m]	Margin dB	Readings [dB μ V]	Antenna factor [1/m]	Preamp [dB]	Cable loss [dB]	TT pos	EUT angle	Pol.
5851.0	49.9	74.0	24.1	38.6	33.9	24.7	2.1	103°	120°	Vert.
Measurement uncertainty					+2.2 dB / -3.6 dB					

Result measured with the average detector:

Frequency MHz	Meas. Result [dB μ V/m]	Limit [dB μ V/m]	Margin dB	Readings [dB μ V]	Antenna factor [1/m]	Preamp [dB]	Cable loss [dB]	TT pos	EUT angle	Pol.
5851.0	34.8	54.0	19.2	23.5	33.9	24.7	2.1	103°	120°	Vert.
Measurement uncertainty					+2.2 dB / -3.6 dB					

Transmitter operates at operation mode 39

Result measured with the peak detector:

Frequency MHz	Meas. Result [dB μ V/m]	Limit [dB μ V/m]	Margin dB	Readings [dB μ V]	Antenna factor [1/m]	Preamp [dB]	Cable loss [dB]	TT pos	EUT angle	Pol.
5149.5	56.9	74.0	17.1	43.5	33.6	24.8	4.5	243°	0°	Vert.
Measurement uncertainty					+2.2 dB / -3.6 dB					

Result measured with the average detector:

Frequency MHz	Meas. Result [dB μ V/m]	Limit [dB μ V/m]	Margin dB	Readings [dB μ V]	Antenna factor [1/m]	Preamp [dB]	Cable loss [dB]	TT pos	EUT angle	Pol.
5149.5	37.0	54.0	17.0	23.6	33.6	24.8	4.5	235°	0°	Hor.
Measurement uncertainty					+2.2 dB / -3.6 dB					

Transmitter operates at operation mode 41

Result measured with the peak detector:

Frequency MHz	Meas. Result [dB μ V/m]	Limit [dB μ V/m]	Margin dB	Readings [dB μ V]	Antenna factor [1/m]	Preamp [dB]	Cable loss [dB]	TT pos	EUT angle	Pol.
5724.5	60.7	74.0	13.3	47.1	33.8	25.0	4.8	100°	120°	Hor.
Measurement uncertainty					+2.2 dB / -3.6 dB					

Result measured with the average detector:

Frequency MHz	Meas. Result [dB μ V/m]	Limit [dB μ V/m]	Margin dB	Readings [dB μ V]	Antenna factor [1/m]	Preamp [dB]	Cable loss [dB]	TT pos	EUT angle	Pol.
5724.5	44.1	54.0	9.9	30.5	33.8	25.0	4.8	100°	120°	Hor.
Measurement uncertainty					+2.2 dB / -3.6 dB					

Transmitter operates at operation mode 42

Result measured with the peak detector:

Frequency MHz	Meas. Result [dB μ V/m]	Limit [dB μ V/m]	Margin dB	Readings [dB μ V]	Antenna factor [1/m]	Preamp [dB]	Cable loss [dB]	TT pos	EUT angle	Pol.
5858.0	46.8	74.0	27.2	32.7	33.9	24.7	4.9	312°	30°	Hor.
Measurement uncertainty					+2.2 dB / -3.6 dB					

Result measured with the average detector:

Frequency MHz	Meas. Result [dB μ V/m]	Limit [dB μ V/m]	Margin dB	Readings [dB μ V]	Antenna factor [1/m]	Preamp [dB]	Cable loss [dB]	TT pos	EUT angle	Pol.
5858.0	33.7	54.0	20.3	19.6	33.9	24.7	4.9	207°	30°	Hor.
Measurement uncertainty					+2.2 dB / -3.6 dB					

TEST EQUIPMENT USED FOR THE TEST:

29, 31 – 52, 72

5.7 Conducted emissions on power supply lines (150 kHz to 30 MHz)

5.7.1 Method of measurement

This test will be carried out in a shielded chamber. Tabletop devices will set up on a non-conducting support with a size of 1 m by 1.5 m and a height of 80 cm above the ground plane. Floor-standing devices will be placed directly on the ground plane. The setup of the Equipment under test will be in accordance to ANSI C63.4-2009 [1].

The frequency range 150 kHz to 30 MHz will be measured with an EMI Receiver set to MAX Hold mode with peak and average detector and a resolution bandwidth of 9 kHz. A scan will be carried out on the phase (or plus pole in case of DC powered devices) of the AC mains network. If levels detected 10 dB below the appropriate limit, this emission will be measured with the average and quasi-peak detector on all lines.

Frequency range	Resolution bandwidth
150 kHz to 30 MHz	9 kHz

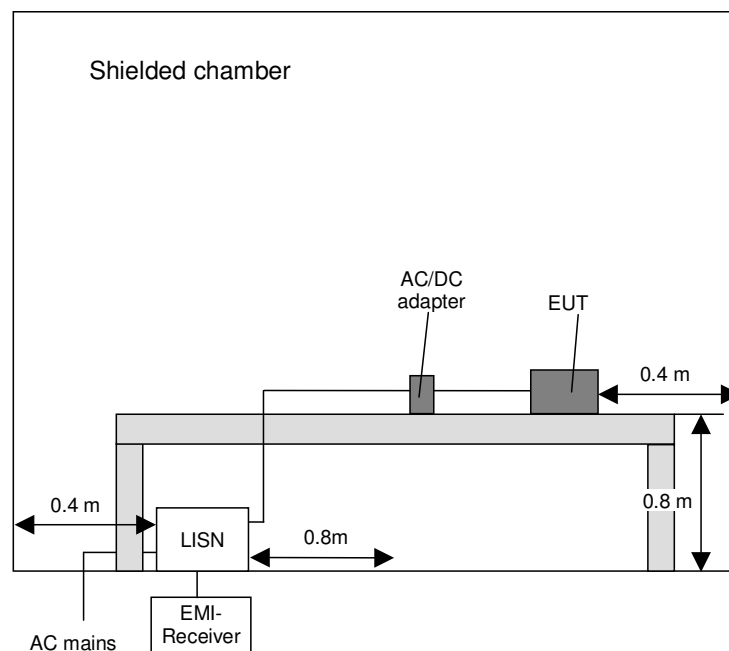

5.7.2 Test results (conducted emissions on power supply lines)

Ambient temperature	20 °C	Relative humidity	52 %
---------------------	-------	-------------------	------

Position of EUT: For the test the EUT was powered by an typical AC/DC power supply. The EUT was set into test-mode with continuous transmission on channel 6 with MCS8 modulation on both transmit chains. This mode was found to be the worst case. The laptop PC with the inserted EUT and the AC/DC power supply were set-up on a non-conducting table of a height of 0.8 m.

Cable guide: For detail information of test set-up and the cable guide refer to the pictures in annex A of this test report.

Test record: All results are shown in the following.

Supply voltage: Measurement performed with US 120V/60Hz. For the test a power supply type “MINI-PS-100-240AC/24DC/1.3” from PHOENIX CONTACT GmbH & Co. KG was used.

The curves in the diagram only represent for each frequency point the maximum measured value of all preliminary measurements which were made for each power supply line. The top measured curve represents the peak measurement and the bottom measured curve the average measurement. The quasi-peak measured points are marked by “◆” and the average measured points by “▼”.

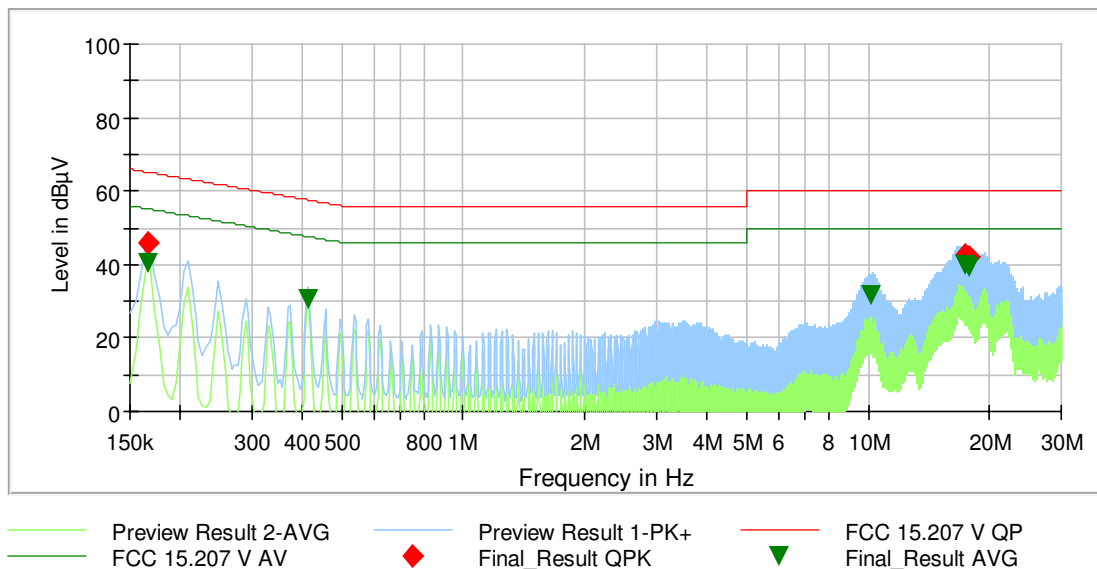

Final Result

Frequency (MHz)	QuasiPeak (dB μ V)	Average (dB μ V)	Limit (dB μ V)	Margin (dB)	Meas. Time (ms)	Bandwidth (kHz)	Line	PE	Corr. (dB)
0.165300	46.07	---	65.19	19.12	5000.0	9.000	N	GND	9.8
0.165300	---	40.58	55.19	14.61	5000.0	9.000	L1	FLO	9.8
0.414600	---	30.63	47.56	16.93	5000.0	9.000	L1	GND	9.9
10.191300	---	31.75	50.00	18.25	5000.0	9.000	N	FLO	10.6
17.277900	42.71	---	60.00	17.29	5000.0	9.000	L1	GND	10.8
17.440800	---	39.72	50.00	10.28	5000.0	9.000	L1	FLO	10.9
17.813400	---	39.31	50.00	10.69	5000.0	9.000	L1	FLO	10.9
17.815200	41.84	---	60.00	18.16	5000.0	9.000	L1	FLO	10.9

TEST EQUIPMENT USED FOR THE TEST:

1 - 5

6 Test Equipment

No.	Test equipment	Type	Manufacturer	Serial No.	PM. No.	Cal. Date	Cal. Due
1	Shielded chamber M47	-	Albatross Projects	B83117-C6439-T262 -	480662	Weekly verification (system cal.)	
2	EMI Receiver	ESIB 26	Rohde & Schwarz	1088.7490	481182	15.02.2016	15.02.2018
3	LISN	NSLK8128	Schwarzbeck	8128155	480058	16.02.2016	16.02.2018
4	Transient Filter Limiter	CFL 9206A	Teseq GmbH	38268	481982	Weekly verification (system cal.)	
5	EMI Software	EMC32	Rohde & Schwarz	100061	481022	-	-
6	RF-Switch	87104D	Agilent Technologies	ATO-66369 MY52310550	482395	Annual verification (system cal.)	
7	Attenuator / Switch Driver	11713B	Agilent Technologies	-	482148		
8	HF-Cable	Sucoflex 104	Huber+Suhner	517406	482391	Annual verification (system cal.)	
9	HF-Cable	Sucoflex 104	Huber+Suhner	517402	482392	Annual verification (system cal.)	
10	HF-Cable	Sucoflex 104	Huber+Suhner	517407	482394	Annual verification (system cal.)	
11	High-pass filter	H26G40G1	Microwave Circuits, Inc.	33471	480593	Annual verification (system cal.)	
29	Fully anechoic chamber M20	-	Albatross Projects	B83107-E2439-T232	480303	Weekly verification (system cal.)	
30	Spectrum analyser	FSU	Rohde & Schwarz	200125	480956	17.02.2016	17.02.2017
31	Measuring receiver	ESI 40	Rohde & Schwarz	100064	480355	16.04.2016	16.04.2017
32	Controller	MCU	Maturo	MCU/043/971107	480832	-	-
33	Turntable	DS420HE	Deisel	420/620/80	480315	-	-
34	Antenna support	AS615P	Deisel	615/310	480187	-	-
36	Antenna	3115 A	EMCO	9609-4918	480183	10.11.2014	10.11.2017
37	Standard Gain Horn 11.9 GHz – 18 GHz	18240-20	Flann Microwave	483	480294	Six month verification (system cal.)	
39	Standard Gain Horn 17.9 GHz – 26.7 GHz	20240-20	Flann Microwave	411	480297	Six month verification (system cal.)	
40	Standard Gain Horn Antenne 26.4 – 40.1 GHz	22240-20	Flann Microwave	469	480299	Six month verification (system cal.)	
41	RF-cable No. 3	Sucoflex 106B	Huber&Suhner	0563/6B / Kabel 3	480670	Weekly verification (system cal.)	
42	RF-cable No. 40	Sucoflex 106B	Huber&Suhner	0708/6B / Kabel 40	481330	Weekly verification (system cal.)	
43	Loop antenna	HFH2-Z2	Rohde & Schwarz	832609/014	480059	29.02.2016	29.02.2018
44	Antenna	CBL6112 B	Chase	2688	480328	14.04.2014	14.04.2017
46	RF-cable 2 m	KPS-1533- 800-KPS	Insulated Wire	-	480302	Six month verification (system cal.)	

47	RF-cable No. 38	Sucoflex 106B	Huber&Suhner	0709/6B / Kabel 38	481328	Weekly verification (system cal.)	
49	Preamplifier	JS3-00101200-23-5A	Miteq	681851	480337	18.02.2016	18.02.2018
50	Preamplifier	JS3-12001800-16-5A	Miteq	571667	480343	18.02.2016	18.02.2018
51	Preamplifier	JS3-18002600-20-5A	Miteq	658697	480342	17.02.2016	17.02.2018
52	Preamplifier	JS4-26004000-25-5A	Miteq	563593	480344	13.04.2016	13.04.2018
60	Power Meter	NRVD	Rohde & Schwarz	833697/030	480589	18.02.2016	18.02.2018
61	Thermal Power Sensor	NRV-Z51	Rohde & Schwarz	825948/003	480248	09.03.2016	03.2018
72	4 GHz High Pass Filter	WHKX4.0/18 G-8SS	Wainwright Instruments	1	480587	Weekly verification (system cal.)	

7 Report History

Report Number	Date	Comment
F161629E2	10.02.2017	Initial Test Report
F161629E2 2 nd Version	13.04.2017	Adding EIRP power to results in chapter 5.2.2, Update versions of the cited standards, Change of caption 161629_06 in Annex A
F161629E2 3rd Version	20.04.2017	Removing the results for the U-NII 2A & 2C bands

8 List of Annexes

ANNEX A TEST SETUP PHOTOS

9 pages

161629_01.jpg	Test setup – antenna-port conducted emissions
161629_10.jpg	Test setup – frequency stability (only 15.407)
161629_02.jpg	Test setup fully anechoic chamber
161629_03.jpg	Test setup fully anechoic chamber
161629_04.jpg	Test setup fully anechoic chamber
161629_05.jpg	Test setup fully anechoic chamber
161629_06.jpg	Test setup open area test site
161629_07.jpg	Test setup fully anechoic chamber
161629_08.jpg	Test setup fully anechoic chamber
161629_09.jpg	Test setup power line conducted emissions

