

3.4.6 Admin

The Admin PIN is required to access the Admin menu.

Registration Mode	Local Beltpack NFC	Registers a Beltpack at an already registered Beltpack via NFC: • NFC (local BP) active as long as you exit
	Over The Air (OTA)	Registers a Beltpack at an already registered Antenna via DECT: On , Off (all Antennas)
	Antenna NFC	Allows registering a Beltpack at an already registered Antenna via NFC: On , Off (all Antennas NFC)
	Timeout	After elapsing this time, the registration mode is disabled: Off , 1 ... 2 ... 60 min. (for OTA, System wide NFC, Charger)
OTA Pin	Defines the legitimation during OTA registration	
	Disable PIN	No PIN entry is required for OTA registration.
	Set new Pin	Insert a new 4-digit PIN that is required for the OTA registration.
	Set to Admin Pin	Defines to use the Admin PIN for OTA registration.
Admin Pin	Defines the legitimation to open the Admin menu in the Beltpack or to log into the web interface of the Antenna.	
	Disable PIN	No PIN entry is required for administration.
	Set new PIN	Insert a new 4-digit PIN that is required for administration purposes.
Time Source	Selects the synchronization source of the Beltpacks time setting: <i>PTP</i> , NTP, Internal	
System Time	Allows entering the system time if the time source is set to Internal .	
System Date	Allows entering the system date if the time source is set to Internal .	
Time Format	Define the time format: 12h, <u>24h</u>	
Date Format	Defines the date format: (dd/mm/yyyy, mm/dd/yyyy, <u>yyy/mm/dd</u>)	

3.4.7 Service

Test	Walk Test	<p>Analyzes the signal quality to the visible Antennas. Following values are shown:</p> <p>DECT</p> <ul style="list-style-type: none"> • Antenna ID • Antenna RPN • current Signal Strength • current Signal Quality <p>New in 3.1</p> <p>2.4GHz</p> <ul style="list-style-type: none"> • Antenna ID • available channels • Bars to show interference level of carrier frequencies • Radio error rate • audio error rate • retransmitted load
	Walk Test Pro	<p>Lists all Antennas that are visible at the current position. Following values are displayed:</p> <ul style="list-style-type: none"> • Antenna ID • Antenna RPN • Signal strength • Busy: available Antenna capacity (ok, full) • Errors downlink • Errors uplink
Reset	Profile Defaults	<p>Resets the profile to default values. All individual changes will be reset. All registration data stays in memory.</p>
	Factory Reset	<p>Resets the Beltpack to factory default settings. All data (Net lists, Profiles, Registrations) will be lost! A new registration is required.</p>
Information	Radio	<p>Displays a table with radio information. Following values are displayed:</p> <ul style="list-style-type: none"> • Visible Antennas • Current Radio Level • Radio Quality • Antenna Name • Antenna Number
	Beltpack	<p>Displays a table with Beltpack information. Following values are displayed:</p> <ul style="list-style-type: none"> • Package Version: x.x.x • Firmware Version: Vxx.xx.xx • Main Version: xxx • Display Version: xxx • Serial number: (13 digits)
	Battery	<p>Displays a table with Battery information. Following values are displayed:</p> <ul style="list-style-type: none"> • Charge Status: xx %, xxxx mAh • Charge Mode: (not charging, xxxx mA • Temperature: (too cold!, cold, normal, warm, too hot!) • Battery Health: xxx % of max. capacity • Capacity Max.: xxxx mAh • Hardware: xx.xx • Serial Number: (13 digits)
Area	Protected menu – for Riedel service purpose only	

3.5 Features in Detail

3.5.1 Headset Type

Open the Beltpack Menu by pressing and holding (>3 sec.) the Menu key and select '**Audio > Headset Type**'. Select the microphone type of the headset:

Auto Detect	The Beltpack automatically detects the headset type.
Dynamic Detect	The Beltpack is fixed to a headset type but turns on audio only if a headset is detected.
Electret Detect	
Dynamic	The Beltpack is fixed to a headset type and audio is enabled.
Electret	

	For Headset MAX D2, the "Auto Detect" function is only available for headset revisions equal or higher than 10.01.
---	--

3.5.2 Speaker

In the menu '**Audio > Speaker**' is defined, if the audio signal is routed to the internal speaker or to an attached headset.

The following table shows the usage of the internal and headset microphone:

	Speaker Mode: On	Speaker Mode: Off
Headset connected	Beltpack microphone	Headset microphone
no Headset connected	Beltpack microphone	no microphone active

	In the speaker mode the echo cancellation is always active.
---	---

3.5.3 Brightness Mode

The menu '**Brightness > Brightness-Mode**' allows switching between different predefined and one user specified display settings. Under '**Brightness > Custom Settings**' the single parameters can be modified.

The predefined modes have following values:

Element	Description	Off ^{*1}	Low	Medium	High
Display	normal display brightness	0%	20%	60%	100%
Display Dim	dimmed display brightness	0%	10%	20%	50%
Display Dim Timer	inactivity timer to dim the display	off	5 sec.	20 sec.	Off
Display Off Timer	inactivity timer to turn off the display	off	60 sec.	Off	Off
Keys	normal key brightness	0%	20%	60%	100%
Keys Dim	dimmed key brightness	0%	20%	20%	60%
Keys Dim Timer	inactivity timer to dim the keys	off	20 sec.	20 sec.	Off
Keys Off Timer	inactivity timer to turn off the keys	off	240 sec.	Off	Off
Call LED Dim	dimmed Call LED brightness	0%	20%	40%	100%
Status LED Dim	dimmed Status LED brightness	0%	20%	60%	100%

^{*1} Note that even if the display brightness is set to 0%, the display automatically turns on with 10% brightness when the Beltpack main menu, volume menu or quick menu is entered. It turns off immediately when the menu is left again.

3.5.4 Profiles

A Profile is assigned to every Beltpack when it is registered. The profile contains default settings for the whole Beltpack-Config and user rights indicating which settings of the Beltpack-Config the Beltpacks user is allowed to see and/or to change.

Using the Admin or Registration PIN, a profile can be chosen in the Antennas Web Interface or in the Beltpack-Menu that should be assigned to all newly registered Beltpacks. The Beltpack stays associated to its profile as long as it is registered.

Changes to a profile in the web interface are immediately applied to all Beltpacks using the edited profile, regardless of the previous setting on the Beltpack. Note that only the changed profile settings (highlighted in blue) are applied to all Beltpacks using this profile, while all other settings on the Beltpacks remain unaffected. Some settings are grouped (e.g. Keys, Always-On, Rotaries functions, etc.), meaning they can only be edited together. For example, changing a single key in the Profile Configuration will re-apply the settings for all keys on all Beltpacks using this profile since all keys are in one group.

The profile of a Beltpack can be changed by the Beltpack-User in the Beltpack-Menu ("Change Profile"; if he has the right), by the Admin using the Web Interface or by (re-)registering the Beltpack while a different profile is selected to be used on all newly registered Beltpacks. A profile change means that a complete reset to the new profile defaults regarding the whole Beltpack-Config.

When a user chooses to load the same profile that the Beltpack already has, the Beltpack-Config is reset back to profile defaults. Should a Beltpack be (re-)registered using the same profile that it already has, nothing is changed (e.g. no changes in the Beltpack-Config).

3.5.5 Notification

In the menu 'General Settings > Notification' is defined, how different events are signalized. It is possible to combine multiple signalization types.

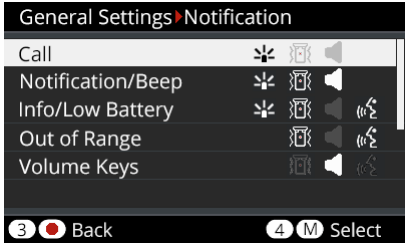





Figure 175: Notification

Events	Signalizations
Call	 orange flashing Call LED
Notification/Beep	 Vibration
Info/Low Battery	 Signal sound (beep)
Out of Range	 Voice announcement
Volume Keys	

3.5.6 Silent Mode

In the menu 'General Settings > Silent Mode', the speaker and vibration can be disabled.

3.5.7 Display Mode

The menu 'General Settings > Display-Mode' allows selecting between the standard view, a 'Flip' and an 'Alternative' view. The display modes can be combined.

The **Flip** mode flips the single rows in the display horizontally.
The **Alternative** mode displays the keys 5 and 6 in the middle.

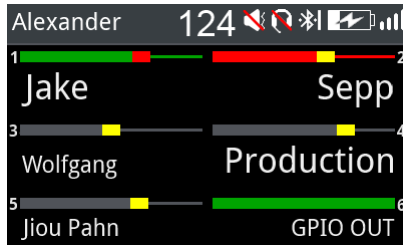
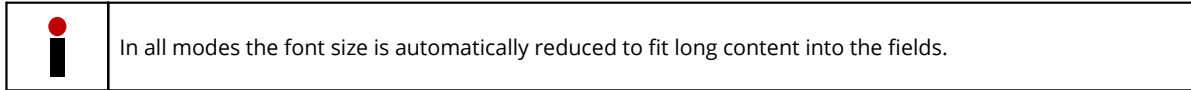

Figure 176: Standard



Figure 177: Standard Flip

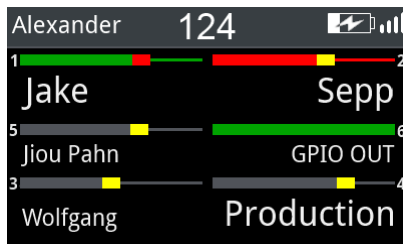

Figure 178: Alternative



Figure 179: Alternative Flip

3.5.8 Lock Keys

The menu 'General Settings > Lock-Keys' allows locking the keys to prevent accidental key actions.

To unlock the keys:

1. If any key is pressed, the display shows 'Keys/rotaries locked. To start the unlock sequence, press the Menu key.'.
2. Once the menu key is pressed, the display shows "Press Key 4 to unlock.".
3. If key 4 is pressed during the timeout, the keys are unlocked. Otherwise the keys remain locked and the display returns to the Main-View.

3.5.9 Bluetooth

New in 3.1 This menu is not available for 2.4GHz-Belpacks.

The Belpack provides a Bluetooth 4.1 wireless connection, which is available even when no Antenna connection is available or the Belpack is not registered.

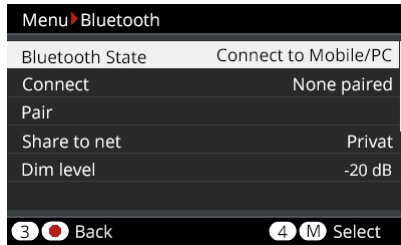

Figure 180: Bluetooth

The menu [Bluetooth State](#) allows defining the device to be paired (Headset or Mobile/PC). After that the menu [Pair / Discoverable](#) allows pairing the desired device.

If the Belpack is not connected to any device, the command **Connect** is displayed and allows establishing the connection to the paired device. If a connection is established, the command **Disconnect** is displayed.

After losing the Bluetooth connection:

	Bluetooth State: Mobile/PC	Bluetooth State: Headset
Connection loss (out of range)	The last connection is <i>not</i> reestablished.	The last connection is reestablished.
Reboot of the Bluetooth device	The last connection is <i>not</i> reestablished.	
Reboot of the Belpack	The last connection is reestablished.	

The Mobile/PC is able to force re-establishment via button press. During Music or Telephone call, the title or Name or number is visible in Status line.

3.5.9.1 Bluetooth State

In the menu 'Bluetooth > Bluetooth State' is selected, if the Beltpack should be connected to a Mobile/PC or to a headset.

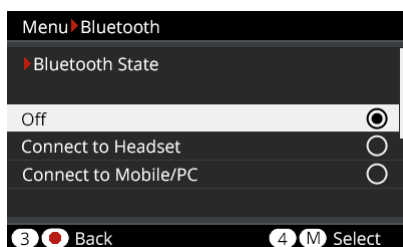



Figure 181: Bluetooth – Bluetooth State

Off	The Bluetooth functionality of the Beltpack is switched off.
Connect to Headset	The headset mode allows connecting a wireless Bluetooth headset to the Beltpack. In this mode the Bluetooth headset replaces the Beltpack's wired headset.
Connect to Mobile/PC	<p>The Mobile/PC mode allows connecting a mobile device (mobile phone, tablet) or PC to the Beltpack. In this mode the Beltpack (including the wired headset) acts like a Bluetooth headset. The user is able to pick up a telephone call or skip forward to the next music track via the Beltpack user interface. A telephone call can be connected to one or more channels of the Beltpack (Public) or is only hearable on the connected Beltpack (Local). Music can only be heard at the local Beltpack.</p> <ul style="list-style-type: none"> • Telephone call audio quality (bidirectional): Standard (20 Hz ... 4 kHz) • Music audio quality (unidirectional): HQ (20 Hz ... 20 kHz)

	<p>The Line-Input is disabled in following conditions:</p> <ul style="list-style-type: none"> • "Connect to Headset" mode: If there is a connection to a headset established. • "Connect to Mobile/PC" mode: While playing music. (When the music playback is stopped, the Line-Input is enabled again. The Line-Input remains active even during a telephone call.)
---	--

3.5.9.2 Pair

In the menu 'Bluetooth > Pair' the pairing process between the Beltpack and a Bluetooth device can be started. After selecting this menu the Beltpack is visible as an audio device called "Bolero" for other Bluetooth devices. Discovered devices are listed in the display.

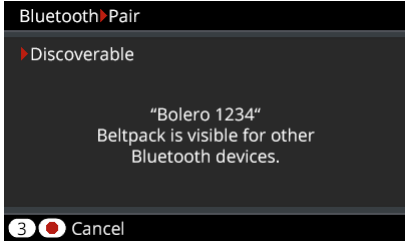

Figure 182: Bluetooth – Pair

Start the pairing process on the desired device. If a Mobile/PC is paired, confirm the generated PIN on this device. Confirm the PIN also on the Beltpack by pressing Key-4.

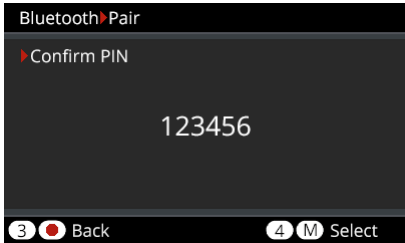



Figure 183: Bluetooth – Pair – Confirm

	Pairing a new device will overwrite the previous settings.
---	--

3.5.9.3 Share to Net

The telephone signal from the mobile phone can be either heard/talked-to locally or be relayed to a public/intercom channel. Therefore the user is able to share the audio signal from the Beltpack connected mobile device via an activated intercom conference (**Public**) or listen to the audio signal at the Beltpack (**Local**) only. The audio signal is mixed to all active keys (channels).

The **Public** mode is indicated by a yellow status bar.

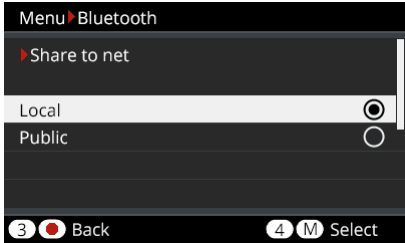

Figure 184: Share to net

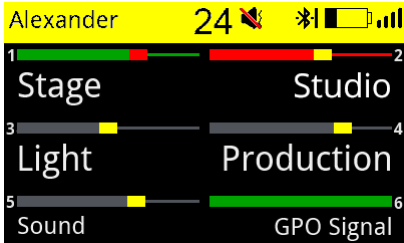



Figure 185: Public Mode enabled

	In Public mode the Dim-Level function for the Beltpack device is disabled because the audio signal is part of the conference.
---	---

3.5.10 Add Beltpacks

Before a Beltpack can connect to a Bolero-Net, it has to be registered to it. Registration means, that the Bolero-Net knows the Beltpack, the Beltpack knows the Bolero-Net and an encryption key is generated to be used by both sides.

There are different ways to register a Beltpack to a Bolero Net:

Antenna OTA	Allows registering a Beltpack at an already registered Antenna via radio. (O ver T he A ir)
Antenna NFC	Allows registering a Beltpack at an already registered Antenna via NFC (N ear F ield C ommunication).
Beltpack NFC	Allows registering a Beltpack at an already registered Beltpack via NFC.

	<p>If the function Allow multi-registration is activated, up to 10 Nets can be registered in a Beltpack. Otherwise the Beltpack can be registered in a single Net. (⇒ 'Beltpack > Main Menu: Registration' and 'Antenna > Web-Interface > Beltpacks > Edit: Registration')</p>
---	---

3.5.10.1 Antenna OTA

This registration mode allows registering a Beltpack at an already registered Antenna over the air. Following steps are necessary to register a Beltpack via Antenna-OTA to a Bolero Net:

- At first the **'Registration Method (OTA)'** must be activated. This can be done in two ways:
 - a) Via the Antennas web interface
(⇒ ['Bolero Antenna > Features in Detail > Add Antennas'](#)).
 - b) Via another Beltpack that is already registered in the Net:
Menu **'Admin > Registration Mode > Over The Air > On'**.

	<ul style="list-style-type: none"> • This setting is system wide and stays active until disabled or the registration timeout runs out. • The registration timeout is restarted each time a Beltpack is registered.
---	--

- Then start the registration process in the Beltpack that should be connected to the Net:
 - a) If the Beltpack is not registered to any Net, press and hold the **'Reply'** key for one second. The Beltpack starts automatically searching for available Nets.
 - b) If the Beltpack is already connected to another Net, push the Beltpack's Menu key for >3 seconds (long key press), navigate to the menu **'Registration'** and select **'Register to net'**.

The Beltpack begins to search for available Nets and displays them one at a time.



Figure 186: Net searching

- The Beltpack will continue to search until a Net is found or **'Back'** is pressed.
- If **'Back'** is pressed, the Beltpack will stop searching and return to the **Registration** menu.
- If **'Next'** is pressed, the current Net is blocked and the Beltpack will continue searching for other Nets. The blocking list is cleared by reentering the **Registration** menu.
- If **'Select'** is pressed, the user will be asked for the **OTA Registration PIN** that was defined via the Antennas Web-Interface or via the Beltpack where the registration mode was enabled (by default the **Admin PIN** is used).
- After registration, the Beltpacks are immediately connected to the Bolero net.

3.5.10.2 Antenna NFC

This registration mode allows registering a Beltpack at an already registered Antenna via NFC. Following steps are necessary to register a Beltpack via Antenna-NFC contact point (📶) to a Bolero Net:

- At first the **'Registration Method (NFC)'** must be activated. This can be done in two ways:
 - a) Via the Antennas web interface
(⇒ [Bolero Antenna > Features in Detail > Add Antennas](#)).
 - b) Via another Beltpack that is already registered in the Net:
Menu **'Admin > Registration Mode > Antenna NFC > On'**.

	<ul style="list-style-type: none"> • This setting is system wide and stays active until disabled or the registration timeout runs out (timeout is the same as for OTA registration). • All Antenna-NFCs are switched to registration mode. • The Beltpack-NFCs of connected Beltpacks are NOT switched to registration mode.
---	---

- The Beltpacks to be registered have to be turned on; no other special setting or user intervention is required.
- Just hold the NFC contact point of the Beltpacks close to the NFC contact point of any Antenna. The Beltpacks will be registered to the same net that the Antenna belongs to.
- After registration, the Beltpacks will immediately connect to the Bolero net.

3.5.10.3 Beltpack NFC

This registration mode allows registering a Beltpack at an already registered Beltpack via NFC. Following steps are necessary to register a Beltpack via Beltpack-NFC contact point (📶) to a Bolero Net:

At first the Registration Method **'Local Beltpack NFC'** must be activated at the already registered Beltpack:

- Push the Menu key of the registered Beltpack for >3 seconds (long key press).
- Navigate to the **'Admin'** menu.
- Enter the **'Admin PIN'** of the net.
- Select **'Registration Mode' > 'Local Beltpack NFC'**.

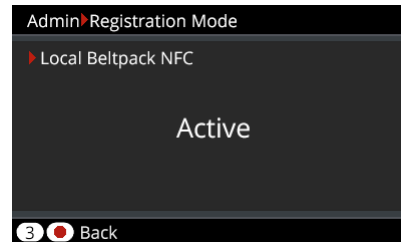
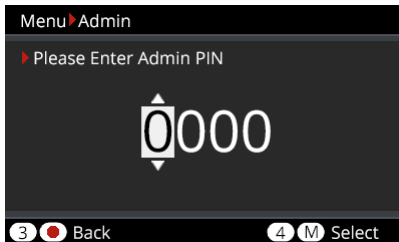



Figure 187: Registration Mode 'Local Beltpack NFC'

- The Beltpacks to be registered have to be turned on; no other special setting or user intervention is required.
- Just hold the NFC contact point of other Beltpacks close to the NFC contact point of the registered Beltpack with active local NFC. These Beltpacks will be registered to the same net that the registered Beltpack belongs to.
- After registration, the Beltpacks will immediately connect to the Bolero net.

	<p>The Beltpack remains in active NFC registration mode until the user exits the "Local Beltpack NFC" menu. (There is no timeout.)</p>
---	--

3.5.11 Remove Beltpacks

To de-register a Beltpack from a Net, choose the Menu 'Registration > Delete pre-registered Net'.

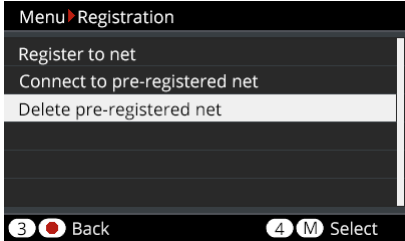

Figure 188: De-Registration

Select the Net to be removed from the list and confirm the de-registration by pressing Key-4. If the Beltpack is connected to this Net, it will be immediately disconnected.

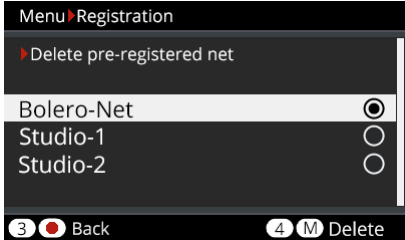



Figure 189: Delete pre-registered net

	<p>The De-Registration is also possible via the Antennas web interface. (⇒ 'Bolero Antenna > Features in Detail > Remove Devices > Beltpacks')</p>
---	--

3.5.12 Walk Test

The Walk Test (Pro) allows the analysis of the link quality to the visible Antennas while traversing the operating range of a Beltpack.

This feature is started in the Beltpack Menu 'Service > Test > Walk Test (Pro)'.

While the Walk Test (Pro) is being performed, the display continuously shows measurement results. Even if the main view of the display is not visible, the keys (1-6) retain their original functionality. This means that calls can be made or stopped and volume changes can be made while the Walk Test data is displayed at the same time. The Reply key is an exception, as it is used to end the range test and therefore does not have the same functionality as in the main view.

If the [Beltpack Monitoring](#) feature is enabled, the Beltpack user can forcefully generate a special measurement (including a marker) by pressing the menu key. The gathered data (including the markers) is presented in the Beltpack information view in the Web Interface (⇒ [Info \(Beltpacks\) > Radio Monitoring](#)).

Walk Test

Depending on whether it is a DECT or 2.4GHz-Beltpack, different readings can be seen:

- For DECT Beltpacks, the walk test displays the current signal strength and signal quality of the Antenna to which the beltpack is connected.
- **New in 3.1**
For 2.4GHz-Beltpacks, the Walk Test displays the interference level of all carrier frequencies in green, yellow, orange and red. In addition, the currently used carrier frequencies are displayed with a stripe. Furthermore, the radio and audio error rate for the receive and transmit direction, as well as the number of retransmitted packets are displayed.

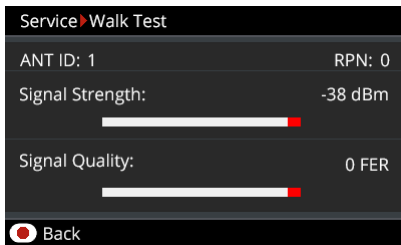

Figure 190: Walk Test (DECT Beltpacks)

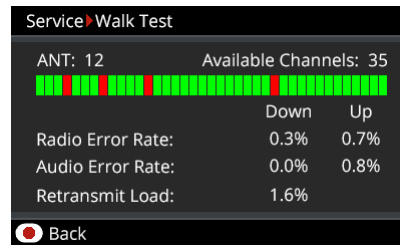

Figure 191: Walk Test (2.4GHz-Beltpacks)

DECT-Antennas	
ANT ID	Antenna ID number.
RPN	Unique number for the Antenna in the network space. The Antenna with RPN 0 is always the Master.
Signal Strength	Current signal strength.
Signal Quality	Current signal quality.
FER	Current number of errors.

2.4GHz-Antennas	
ANT	Antenna ID number.
Available Channels	Number of available channels.
Interference Level	Shows all carrier frequencies in green, yellow, orange and red.
Radio /Audio Error Rate	Radio and Audio error rate for the receive and transmit direction.
Retransmit Load	Number of retransmitted packets.

Walk Test Pro

The Walk Test Pro displays the signal levels of all Antennas that are within sight of the Beltpack. The Antenna to which the Beltpack is connected is highlighted.
 There are no differences between the DECT and 2.4GHz-Beltpacks in the Walk Test Pro.

Service ▶ Walk Test Pro					
ANT	RPN	Signal	Busy	Err ↓	Err ↑
1	0	-38	ok	0	0
2	1	-56	ok	1	2

◀ Back Available: 10 Channels / 101 Slots

Figure 192: Walk Test Pro (DECT & 2.4GHz-Beltpacks)

ANT	Antenna ID number.
RPN	Unique number for the Antenna in the network space. The Antenna with RPN 0 is always the Master.
Signal	Average number of receive signal strength. The value may vary due to fading.
Busy	Shows if the Antenna is full occupied by Beltpacks.
Error (downlink)	Average number of detected errors in the link from the Antenna to the Beltpack (e.g. sync error or CRC).
Error (uplink)	Average number of detected errors in the link from Beltpack to Antenna.
Phase	Phase difference from the Antenna, the Beltpack is connected to, and a secondary Antenna. This number has to be below ±2. If it is outside this range, the clock in the network is not in sync. In this case, handover will not be possible as the Beltpack cannot see other Antennas anymore. The Beltpack clock is always synchronized to the clock of the connected Antenna.
	If an Antenna with an 'Advanced Monitoring' license is present in Bolero-Net, the number of available channels and frequencies is displayed in the bottom line.

3.5.13 Reset

The Beltpack-Menu 'Service > Reset' offers two different ways to reset the Beltpack to factory default settings.

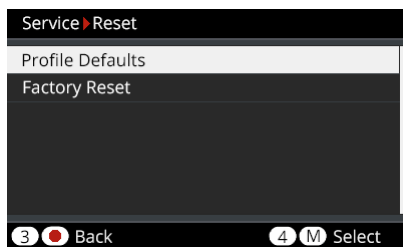

Figure 193: Beltpack menu – Reset

Profile Defaults

This resets the Beltpacks' Profile data the current default settings of the net.
All registration data stays in memory.

Factory Reset

This resets all data and settings to factory default.
All Net lists and registrations data will be deleted.

3.5.14 Opening the USB rubber cover

The USB rubber cover yields protection against ingressing dirt and water inside the Beltpack.
The rubber cover can be removed as follows:

- Turn the Beltpack's rear side upwards.
- Push your fingernail gently in the slit on the top of the rubber cover...
- and pull the rubber cover out of the Beltpack's connectors.
- Take care to seal the Beltpack when the connectors are not in use.



Figure 194: Insert fingernail



Figure 195: Pull rubber cover

3.5.15 Battery

Light and powerful custom lithium rechargeable battery packs are used to operate the Beltpacks. A good battery usually lasts about 500 full charging cycles. If the Beltpack is charged 50% every day, the battery will last for about 3 years.

Batteries can be charged in following ways:

- Beltpack (with battery) in the Bolero-Charger
- Battery (separate, without Beltpack) in the Bolero-Charger
- Beltpack (with battery) via USB device (USB plug power supply, PC/Laptop, etc.)

The charging characteristic depends on the ambient temperature and the Charger:

Temperature		Display	Bolero-Charger	USB device
<0°C	<32°F	too cold !		no charging
0°...10°C	32°...50°F	cold	gentle charging 1.00 A / 4.06 V	gentle charging 0.50 A / 4.06V
10°...45°C	50°...113°F	normal	normal charging 1.50 A / 4.20 V	normal charging 0.50 A / 4.20 V
45°...60°C	113°...140°F	warm	gentle charging 1.50 A / 4.06 V	gentle charging 0.50 A / 4.06V
>60°C	>140°F	too hot !		no charging

3.5.15.1 Charging via USB in the Beltpack

- Connect the Beltpack with an USB power supply or an USB connector that has a minimum current supply of 500mA.

During charging the Beltpack is still operable. The main screen shows in the top right the charge icon:

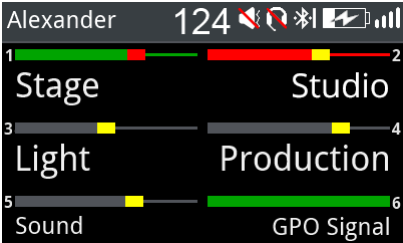

Figure 196: USB Charging view

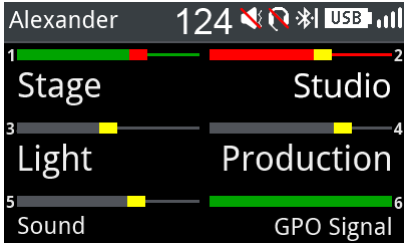

Figure 197: Fully Charged view (USB still connected)

Some USB chargers may not be compatible with Bolero Beltpacks. For example some USB chargers may charge the Beltpack with only 100mA, even though the charger is capable of providing 1A or more. The Beltpack shows an **ERR** in the battery symbol.

More information is displayed in the Beltpack Menu 'Service > Information > Battery':

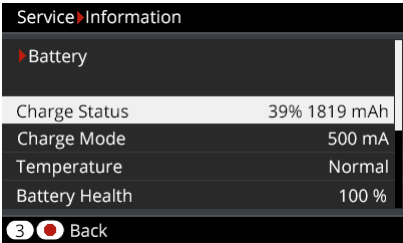

Figure 198: Charging information in the Beltpack menu





3.5.15.2 Charging in the Charger

- Plug the Beltpack or just the battery itself in an empty position in the Charger.



The radio is switched off when the Beltpack is plugged into the Charger.

- The charging procedure will start automatically.
- The corresponding slot LED indicates the charging state:

	red blinking	below 20%
	orange blinking	20 ... 90%
	green blinking	above 90%
	permanent green	100%
	green, orange flashing	100%, battery life <60%



- The Beltpack's display shows the charging state.

Bolero-Bpk 1 	
Charge Status	23 %
Time to Full	2 h 19 min
Temperature	Normal
Battery Health	100 %

For further information refer chapter [Bolero Charger](#).

3.5.15.3 Replacing the Battery

The Beltpack battery can be replaced by following these steps:

- Pull the battery release button upwards...
- and push the battery at the belt clip to the bottom side of the Beltpack.
- Lift the battery upwards.
- Insert the battery in the opposite order.



Figure 199: Pull release button



Figure 200: Push battery



Figure 201: Lift battery

3.5.15.4 Removing the Belt Clip

The belt clip can be removed by following these steps:

- Pull the lock clip upwards...
- and push the belt clip to the top side of the battery.
- Insert the belt clip in the opposite order.



Figure 202: Pull lock clip



Figure 203: Push belt clip

3.5.16 Firmware Update

It is possible to update the firmware of up to five Beltpacks in one Bolero-Charger. As long as a USB flash drive with valid firmware package is connected to the Charger, the Charger functions as an update station. The Beltpacks are charged simultaneously while updating.

A step-by-step guide for the update can be found in chapter '[Bolero Charger > Firmware Update](#)'.

3.6 Bolero Beltpack Cover

The Beltpacks can be individualized by colored covers, which will be clipped over the display.

Color	Product code
black	BL-BPK-COVER-BLACK
blue	BL-BPK-COVER-BLUE
gray	BL-BPK-COVER-GRAY
green	BL-BPK-COVER-GREEN
red	BL-BPK-COVER-RED
violet	BL-BPK-COVER-VIOLET
white	BL-BPK-COVER-WHITE
yellow	BL-BPK-COVER-YELLOW

3.7 Technical Drawing

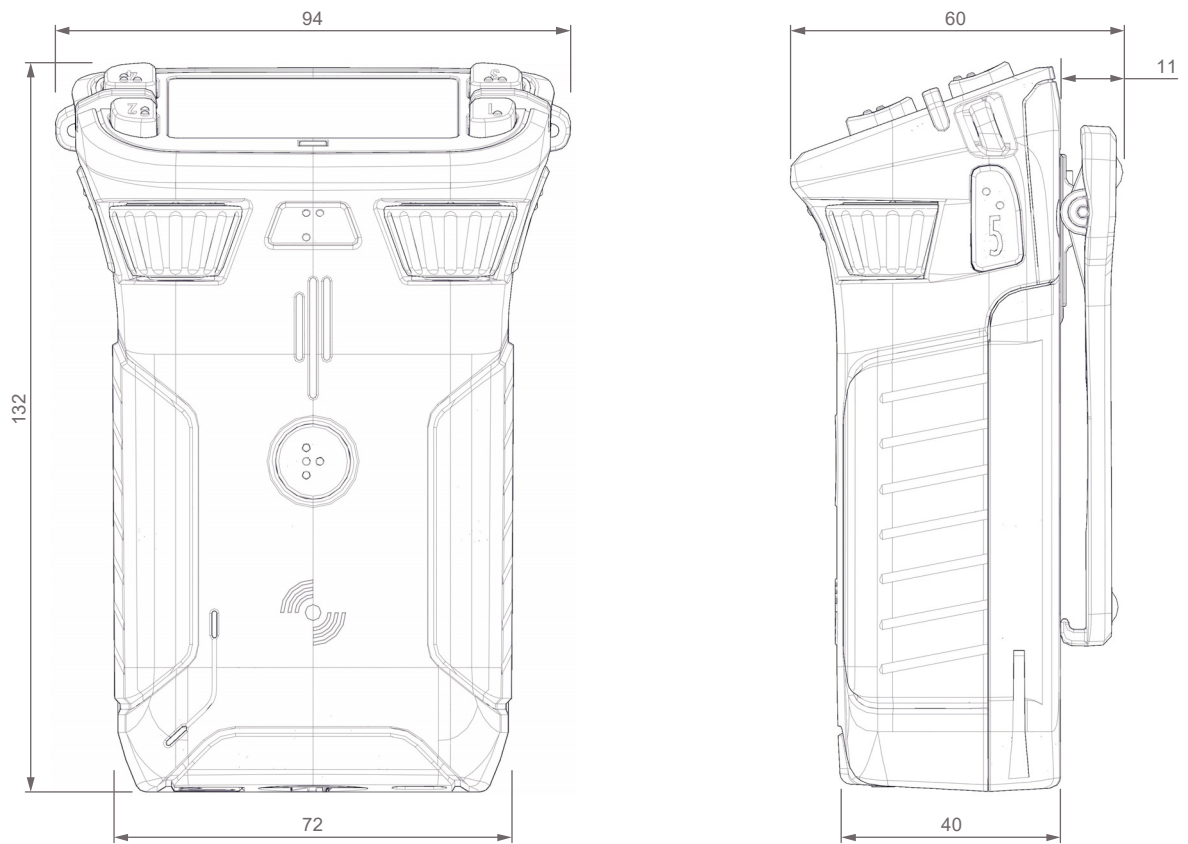

figure 204: Beltpack (front, right), dimensions in millimeter

3.8 Technical Specifications

Beltpack Product Code	DECT	BL-BPK-1006-19
	2.4GHz	BL-BPK-1006-24
Multi-path delay spread protection	Yes, ADR (Advanced DECT Receiver)	
Audio Bandwidth	200 Hz ... 7 kHz (-3dB)	
Mode of Operation	Full-duplex on all routes	
Encryption	AES256 Bit encryption	
Line Input	3.5 mm jack, 40 Hz ... 20 kHz, max. +12 dBu input level (local audio mix only)	
Talk Controls	4x push buttons + 1x reply key + 2x walkie-talkie keys (PTT, Latching & Auto mode)	
Volume / Level Controls	2x rotary encoders + menu navigation	
Display	High contrast sunlight readable full color LCD	
Audio prompts	Out of range, Bluetooth connected / disconnected, battery low, volume change, Beltpack registered / deregistered / not connected	
Number of Full-Duplex Audio Paths	6 with individual level control	
Handheld Operation	Walkie-talkie mode	
Vibrate Module	Programmable vibrate indicates incoming calls, low battery, out of range and other notifications.	
Internal Loudspeaker	Freq. <500Hz ... >7kHz 80dB/SPL/0.5W/1m, @ <5% THD	
Remote Health Monitoring	Battery charge status, via web browser	
Battery	Lithium Ion external removable battery pack with user removable clip	
USB Charging	USB Type-C connector for Beltpack charging.	
Operation Time	~17 hours typical	
Headset Connector	4-pin male XLR, user replaceable	
Microphone Type	Electret (~5V bias voltage) or dynamic, user selectable or automatic	
Side-tone and microphone gain	Individually adjustable for each Beltpack & via remote control	
Bluetooth	V4.1 (HFP - hands free profile, HSP - headset profile, A2DP - streaming profile) New in 3.1 Bluetooth is not supported for 2.4GHz-Beltpacks.	
Bluetooth phone call mix into intercom	Yes	
Lanyard anchor points	Yes	
Dimensions	Width	86 mm / 3.4"
	Height	130 mm / 5.1"
	Depth	48 mm / 1.9"
Weight	420 g (incl. battery and clip)	
Environmental	IP-65 environmental sealing; protected against dust ingress and water spray from all angles (with XLR connector plugged in)	
Operating Environment	Temperature	-10° ... +40°C (device operating up to 55°C)
	Humidity	0 % ... 90 % rel. (non-condensing), Ta=40°C
Storage Temperature	-20° ... +50°C (long term) / -20° ... +60°C (short term)	

4 Bolero S-Beltpack

The Bolero Wireless S-Beltpack is a very light and compact, digital station with six individually configurable keys for intercom, IFB or GPO triggering use. Two of the keys are able to allow volume-control for each key. Pushing the Talk key toggles talk on/off with momentary or latching operation as well as an Auto mode that combines both functions in one. Activation is indicated by an LED. A vibration motor is able to indicate an incoming call or warnings. With the new "Touch&Go" Beltpack registration a quick and user-friendly registration is implemented. Just touch the Beltpack to the Antenna and GO. The Bolero Wireless S-Beltpack has a 6-pin Hirose HR10 socket for headset and a USB port for firmware updates. A fully charged Bolero-S-Beltpack allows more than 7 hours of operation. The rugged housing houses the internal Antennas.

4.1 Operating Elements



Figure 205: S-Beltpack – Operating Elements (front/top, rear/bottom)

A	Key 2 (channel 2, top)
B	Lanyard or safety cord mounting holes
C	NFC contact point
D	Headset connector (Hirose)
E	Key 1 (channel 1, top)
F	Key 3 (channel 3, side)
G	Key 5 (volume down, side)
H	Charging contacts
I	Beltclip (optional)
J	Screw head mount and bottle opener
K	Power button
L	USB Type-C (underneath a rubber cover)
M	Key 6 (volume up, side)
N	Key 4 (channel 4, side)

Hirose (male)

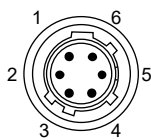

Pin	Description	Pin	Description
1	Microphone + (+5 VDC)	4	Microphone - (shield)
2	PTT (GND)	5	PTT (signal)
3	Earphones +	6	Earphones -

Figure 206: Hirose male

The headset connector is a 6-pole male Hirose connector and supports mono headsets with electret or dynamic microphones, depending on the menu setting.

The microphone power (+5 VDC) will be switched on if the menu setting 'Audio > Headset Type' is set to **Electret**, **Electret detect** or **Auto** and an electret microphone is attached.

USB Type-C

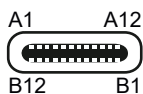

Pin	Description	Pin	Description
1	GND	7	Dn1
2	SSTXp1	8	SBU1
3	SSTXn1	9	VBUS
4	VBUS	10	SSRXn2
5	CC1	11	SSRXp2
6	Dp1	12	GND

Figure 207: USB Type-C

The USB connector is used to charge the Beltpack.

Charging is only possible with >500 mA USB ports. 100 mA are not supported. The charge current is limited to 500 mA by the Beltpack.

4.2 Status LEDs



Figure 208: S-Beltpack – Status LEDs (top)

1	Status	off	Beltpack is turned off
		green	<ul style="list-style-type: none"> Beltpack ready (System ok) Beltpack off, USB charging, battery full
		green blinking	USB charging, battery level >90%
		red	<ul style="list-style-type: none"> Booting Beltpack not registered/not connected Low battery level (<15%) Outside the Antenna coverage area
		red blinking	Critical battery level (<8%)
		red fast blinking	Critical error (no function)
		orange	Mic unmuted, Sidetone on
		orange blinking	USB charging, battery level <90%
		orange fast blinking	Locate function active
		orange-red blinking	<ul style="list-style-type: none"> Beltpack not registered, USB charging, battery level <90% Beltpack registered, Mic unmuted, Sidetone on, critical battery level (<8%)
		green-red blinking	Beltpack not registered, USB charging, battery level >90%
2	Call	off	No active call
		green	Incoming call
		green blinking	Volume changing
		red blinking	Beltpack not registered/connected
		orange	Outgoing call
		orange blinking	Incoming indication (beep)

4.3 Key Functions

While the green status LED indicates ready for operation, users may talk individually or at the same time to all channels.

Pushing one of the four keys allows talking in the respective channel.

The respective Call LED is indicating if one channel is active at least.

The keys 1 to 4 are latching. Push again the key to deactivate the respective channel.

The keys 5 and 6 (-/+) allow adjusting the master volume of the channels.



The key mode (Latching / PTT) is set in Director if the system is set to **Integrated/Artist** mode. For a new configuration in Director, all 6 keys are in PTT mode by default.

4.4 Battery

Light and powerful custom lithium rechargeable battery packs are used to operate the S-Beltpacks. Bolero S-Beltpacks have half of the capacity of standard Bolero Beltpacks.

Batteries can be charged in following ways:

- S-Beltpack in the Bolero-Charger
- S-Beltpack via USB device (USB plug power supply, PC/Laptop, etc.)

The charging characteristic depends on the ambient temperature and the Charger:

Temperature		Display	Bolero-Charger	USB device
<0°C	<32°F	too cold !	no charging	
0°...10°C	32°...50°F	cold	gentle charging 1.00 A / 4.06 V	gentle charging 0.50 A / 4.06V
10°...45°C	50°...113°F	normal	normal charging 1.50 A / 4.20 V	normal charging 0.50 A / 4.20 V
45°...60°C	113°...140°F	warm	gentle charging 1.50 A / 4.06 V	gentle charging 0.50 A / 4.06V
>60°C	>140°F	too hot !	no charging	

4.4.1 Charging via USB

- Connect the S-Beltpack with an USB power supply or an USB connector that has a minimum current supply of 500mA.

During charging the S-Beltpack is still operable. The status LED shows the charging information.

S-Beltpack connected:

	orange blinking	below 90%
	green blinking	above 90%

S-Beltpack not connected:

	orange/red blinking	below 90%
	green/red blinking	above 90%

Some USB chargers may not be compatible with Bolero S-Beltpacks. For example some USB chargers may charge the S-Beltpack with only 100mA, even though the charger is capable of providing 1A or more.

4.4.2 Charging in the Charger

- Plug the S-Beltpack in an empty position in the Charger.

	The radio is switched off when the S-Beltpack is plugged into the Charger.
---	--

- The charging procedure will start automatically.

The corresponding slot LED indicates the charging state:

	red blinking	below 20%
	orange blinking	20 ... 90%
	green blinking	above 90%
	permanent green	100%
	green, orange flashing	100%, battery life <60%

For further information refer chapter [Bolero Charger](#).

4.5 External PTT

Two buttons (External Keys) via the headset socket are supported. These External Keys are used to "remote control" other keys on the Beltpack. In addition to the existing key modes (Momentary, Latching, Auto), two new modes can be configured for the external keys:

- On only
- Off only





The configuration for these External Keys can be found in the **Rotaries** tab in the 'Beltpack Configuration' and 'Profile Configuration' views.

Note that the Beltpack hardware has to support the headsets with External Keys (currently the standard Bolero Beltpack BL-BPK-1006-19 does not support this feature, only the Bolero S Rev. 12.00 (or higher) Beltpack can be used with External Keys at the moment).

4.6 Firmware Update

It is possible to update the firmware of up to five S-Belt packs in one Bolero-Charger. As long as a USB flash drive with valid firmware package is connected to the Charger, the Charger functions as an update station.

New in 3.1 Since S-Belt packs do not have a display, the update information is indicated via the key LEDs 1+2:

	green (on for 15 seconds, then off)	S-Belt pack runs with the current firmware
	orange alternately blinking	Firmware update in progress
	orange	Update in progress during reboot
	green	Update successfully completed
	red flashing 2x	Update error

The S-Belt packs are charged simultaneously while updating.

The charging status is displayed via the respective slot LED. (⇒ [Charging in the Charger](#)).

A step-by-step guide for the update can be found in chapter '[Bolero Charger > Firmware Update](#)'.

4.7 Technical Drawing

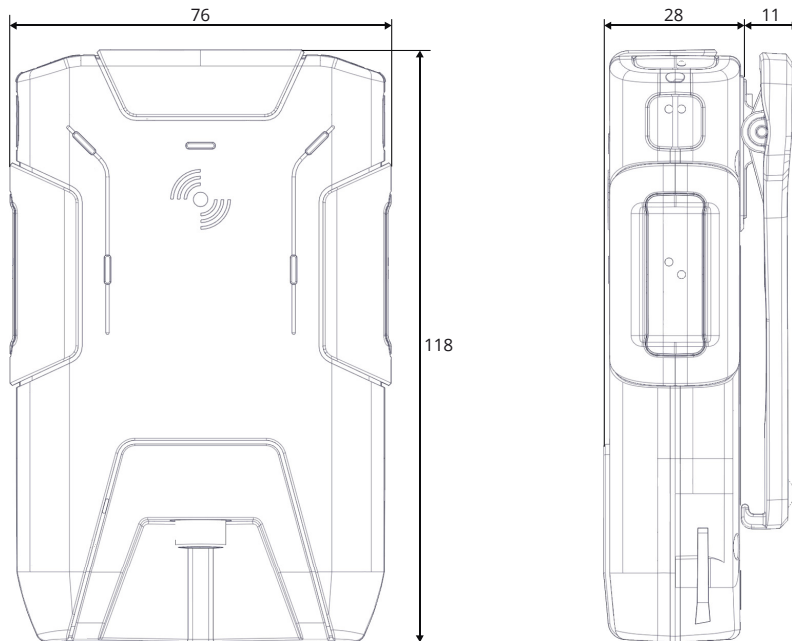

figure 209: S-Belt pack (front, right), dimensions in millimeter



4.8 Technical Specifications

Beltpack Product Code	BL-BPK-1004-19, BL-BPK-1004-24	
Multi-path delay spread protection	Yes, ADR (Advanced DECT Receiver)	
Audio Bandwidth	200 Hz ... 7 kHz (-3dB)	
Mode of Operation	Full-duplex on all routes	
Encryption	AES256 Bit encryption	
Line Input	No	
Talk Controls	4x push buttons (momentary, latching & auto mode) + 2 volume keys	
Volume / Level Controls	Volume keys programmable	
Display	No	
Audio prompts	Out of range, Battery full, Battery good, Battery low, Beltpack registered	
Number of Full-Duplex Audio Paths	4 with individual level control	
Vibrate Module	Vibrate indicates incoming call or silent call is active	
Remote Health Monitoring	Remote via Antenna and computer (Battery remaining time)	
Battery	Lithium Ion internal battery	
USB Charging	USB Type-C connector for Beltpack charging.	
Operation Time	~7 hours typical	
Headset Connector	6-pin male Hirose HR10	
Microphone Type	Electret (-5V bias voltage) or dynamic, user selectable or automatic	
Side-tone and microphone gain	Individually adjustable for each Beltpack & via remote control	
Bluetooth	No	
Beltclip	Yes, user removable clip (optional)	
Lanyard anchor points	Yes	
Environmental	IP-65 environmental sealing; protected against dust ingress and water spray from all angles	
Storage Temperature	-20° ... +50 °C long term; -20° ... +60 °C short term	
Environment Temperature	-10° ... +40°C (device operating up to 55°C)	
Humidity	0 % ... 90 % rel. (non-condensing), Ta=40°C	
Dimensions	Width	76 mm / 3.0"
	Height	118 mm / 4.6"
	Depth	28 mm / 1.1"
Weight	165 g / 5.82 oz (without clip)	

5 Bolero Antenna

When used with Artist, Bolero active Antennas run over a standard AES67 IP network. Up to 100 Antennas and 250 Beltpacks are able to connect to a system. The intelligent and highly efficient use of bandwidth results in 10 Beltpacks per Antenna. The decentralized Antennas allow the use of existing standard structured cabling and provide a wide area between the Antennas connected to AES67 capable switches and the Artist frames equipped with AES67 client cards. This provides a fully integrated point-to-point roaming intercom ecosystem. The more decentralized Antennas added, the more robust the network becomes. The Antenna is powered via Power-over-Ethernet (PoE+), simplifying installations by eliminating local power supplies or alternatively via a separate DC supply.

When used in Standalone/Link application, Antennas can be used individually, in a ring structure, or daisy-chained as the situation demands. Also, up to 100 Antennas and 128 audio channels (Beltpacks and NSA-002A) can be integrated into a single system. These Antennas can be placed up to 300 meters apart and up to five can be powered via the CAT5 network using a new external PSU. The system is quickly and easily configured over the IP connection using a web browser. Finally, a throw-down box can be used to interface the standalone Bolero with other intercom systems via 4-wire.

	<p>The radio operation is disabled by default for Antennas configured for countries outside Europe and may only be activated in the respective countries. This is done in the web interface of the respective Antenna: Antennas > Edit () > Antenna RF (). (⇒ Edit (Antennas))</p>
---	--

New in 3.1

The Bolero product portfolio has been expanded by a 2.4GHz type Antenna and Beltpack that operate exclusively in the 2.4 GHz range.

Each 2.4GHz-Antenna supports up to eight 2.4GHz-Beltpacks. The different Antenna types (2.4GHz and DECT) can be added to the same Network Space. 2.4GHz-Antennas can be configured and used in the same way as DECT-Antennas. The different Antennas can even be used in the same Standalone/Link ring topology. The 2.4GHz-Antennas have the same (remote) power capabilities as the DECT-Antennas. The Beltpacks also work the same, but 2.4GHz-Beltpacks will only connect to 2.4GHz-Antennas and DECT-Beltpacks will only connect to DECT-Antennas. Talking from a 2.4GHz-Beltpack to a DECT-Beltpack or vice versa works as long as they are both in the same Network Space or connected to the same Artist net.

5.1 Operating Elements

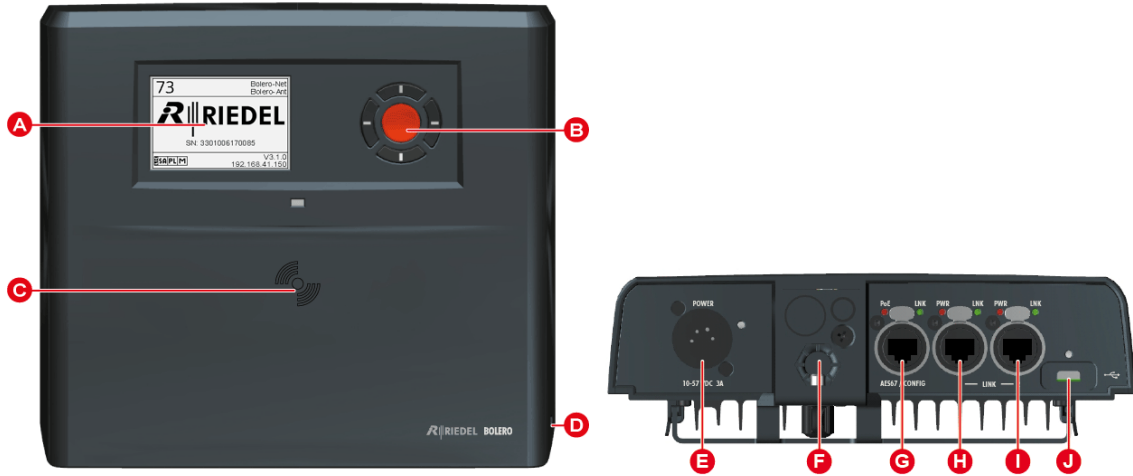

Figure 210: Antenna Operating Elements (front, bottom)

A	E-ink display
B	Navigation buttons (cursor and menu button)
C	NFC contact point
D	Kensington Security Slot
E	DC power supply connector (XLR-4)
F	Mounting element (spigot, 3/8" & 5/8" microphone stand mounting)
G	AES67/Config connector (RJ45 , 1Gbit)
H	LINK connector 1 (RJ45)
I	LINK connector 2 (RJ45)
J	USB connector (USB Type-C)

XLR-4 (male)

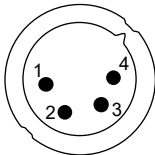

Figure 211: XLR-4 male

Pin	Description
1	-PWR
2	Chassis
3	Data
4	+PWR (10...57 VDC / 3 A)

The length of the DC power cable should not exceed 1.5 meters.

RJ45

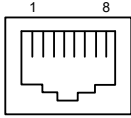

Figure 212: RJ45

Pin	AES67/Config	LINK 1+2
1	D1+ / PoE+ (p)	D1+
2	D1- / PoE+ (p)	D1-
3	D2+ / PoE+ (n)	D2+
4	D3+ / PoE+ (p)	D3+
5	D3- / PoE+ (p)	D3-
6	D2- / PoE+ (n)	D2-
7	D4+ / PoE+ (n)	D4+
8	D4- / PoE+ (n)	D4-

1Gbit Ethernet connection is necessary to operate the Bolero net.

Standalone/AES67 Mode & Integrated/Artist Mode

- The AES67/Config port is connected to the IP net (which also hosts the Artist card in **Integrated Artist mode**).
- The other two ports are not used. If they are connected anyway, an error will be issued and radio transmission will be disabled.



Cable requirements: Cat-5e / Cat-6 or better (according to ISO/IEC 11801), S/FTP or better, up to 100 m. Make sure ISO/IEC specification applies for the used length of the cable (in particular attenuation).

Standalone/Link Mode

- The AES67/Config port is primarily used as config port, i.e. to provide a connection to the Web-UI.
- One can also directly attach up to two IO Devices (NSA-002A) to this port in a daisy chain as well.
- Link-1 and Link-2 are used to interconnect the Antennas in a daisy chain ("open") or ring ("closed") topology.
 - A closed topology provides redundancy:
 - either **one** cable in the ring can be detached without interrupting audio transmission.
 - In an open topology there's no more redundancy:
 - if a cable is detached, the affected nodes cannot be reached any more.
- Link-1 on the local device must always be connected to Link-2 on the remote device (and vice versa).
- CAT cables with a maximum length of 300 meters are supported.
- With an External Power Supply (EPS), you can power up to 5 Antennas: 2 Antennas over each Link-1 and Link-2 and the center Antenna with the EPS attached.
- It is not possible to use routers, switches or other standard IP devices.



Cable requirements: Cat-5e / Cat-6 or better (according to ISO/IEC 11801), S/FTP or better, up to 300 m. Make sure ISO/IEC specification applies for the used length of the cable (in particular attenuation).
The cable resistance between two Antennas shall below 17 Ohm.

USB Type-C

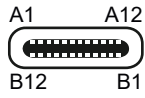

Figure 213: USB Type-C

Pin	Description	Pin	Description
1	GND	7	Dn1
2	SSTXp1	8	SBU1
3	SSTXn1	9	VBUS
4	VBUS	10	SSRXn2
5	CC1	11	SSRXp2
6	Dp1	12	GND

5.2 Status LEDs



Figure 214: Antenna - Status LEDs (front, bottom)

1 Status	off	Not powered
	green	Antenna in operation (radio enabled)
	orange	Antenna in operation (radio disabled)
	orange blinking	Antenna is powering up
	red blinking	Antenna is powering down / firmware not running
2 Power	off	No XLR input power
	green	XLR input power ok
3 AES67-PoE	off	No PoE+ input power
	green	PoE+ input power ok
4 AES67-LNK	off	no Ethernet connection present
	green	Ethernet link ok
5, 7 LINK-PWR	off	No remote power (neither outgoing nor incoming).
	orange	Remote power is provided to power other Antennas (outgoing power).
	green	The Antenna uses remote power as main power-supply (incoming power).
6, 8 LINK-LNK	off	No LINK connection present
	green blinking	LINK connection ok
	orange	Authentication denied: This occurs when protocol versions of the connected Antennas do not match. It is required to run the same firmware version on all devices.
	orange blinking	Linkup is pending: Another network space is connected to the Antenna. You can choose to join the local and remote nets.
	red	LINK connection failure: A link has been connected to the same link on another Antenna. (E.g. local Link 1 → remote Link 1). Notice that Link 1 must always be connected to Link 2 (and vice versa) on the remote node.
9 USB	red blinking	The connected Antennas do not run the same firmware version.
	off	No USB input power
	green	USB input power ok
	red	USB input power out of range

5.3 Basic Operation

5.3.1 Startup

The Antenna starts automatically after it is attached to power. The Antenna can be powered either by a separate power supply (EPS-1001) or by a switch with PoE+ functionality. In Standalone/Link mode, the power supply can also be provided by the high-performance power supply unit (EPS-1005).

The Antenna displays relevant information both after startup in the Main-View and when the device is switched off:

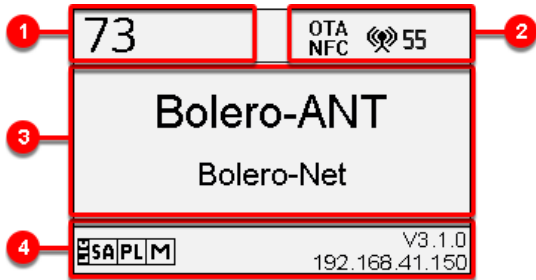

Figure 215: Main-View

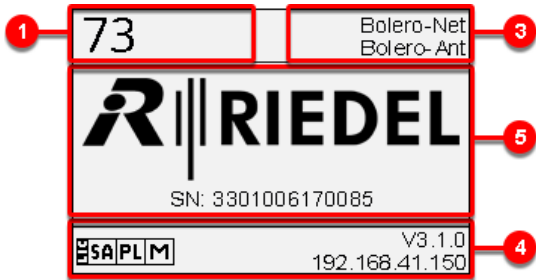







Figure 216: unpowered

1	unique ID of the Antenna	73
2	Registration mode enabled	OTA NFC
	Connection to the Net via AES67 connector	55
	Connection to the Net via LINK connectors (daisy-chain <u>without</u> redundancy)	55
	Connection to the Net via LINK connectors (ring <u>with</u> redundancy)	55
	Warning symbol (optional)	⚠
3	Name of the Antenna	Bolero-ANT
	Name of the Net	Bolero-Net
4	Installed License (Standalone, Extended Partyline, Monitoring))	SAPLM
	Firmware version of the Antenna	V3.0.0
	IP address of the Antenna	192.168.41.150
5	Riedel logo with serial number of the Antenna	RIEDEL SN: 3301006170085

5.3.2 Key Functions

The five buttons right beside the display allows displaying system information or editing basic settings. Press any key to enter the Main Menu. The general key functions are as follows:

	<ul style="list-style-type: none">• Select the previous menu item• Increase values
	<ul style="list-style-type: none">• Select the next menu item• Decrease values
	<ul style="list-style-type: none">• Back to parent menu item• Move selection to the left
	<ul style="list-style-type: none">• Move selection to the right
	<ul style="list-style-type: none">• Enter selected menu item

5.4 Main Menu

The Main-Menu is opened by pressing any key.

Information are displayed and basic settings can be modified:

System Mode *1	Selection of the System mode of the Net. (Standalone/AES67, Standalone/Link, Integrated/Artist)		
IP Settings	Mode	Allows setting the mode of IP address : Static, DHCP, Auto IP	
	IP	Allows setting the IP4.0 address. If the Mode is set to Static .	
	Netmask	Allows setting the IP4.0 netmask.	
	Gateway	Allows setting the IP4.0 gateway.	
Registration *1	Configuration and activation of the registration mode for Beltpacks.		
	OTA	If enabled, Beltpacks are allowed to register via radio to this Net.	
	NFC	If enabled, Beltpacks are allowed to register via Antenna NFC to this Net.	
	Admin PIN (OTA)	If activated (On), the <i>Amin PIN</i> must be entered for registration in the Beltpack.	
	Timeout	Setting of the time in minutes after which the registration is deactivated. When disabled (Off), the Antenna remains in registration mode until it is exited.	
Display	Upside/Down	In the activated upside/down mode (On), the display is mirrored horizontally.	
Information	Antenna Info	Displays Antenna information:	
		Name	Name of the Antenna.
		User ID	User-ID of the Antenna.
		Net	Name of the Net.
		Master	Indicates whether the Antenna is Sync-Master. (Yes, No)
		Antenna RF	Indicates whether the radio signal of the Antenna is Enabled or Disabled .
		Area	Display of the region. (Europe, US/Canada, South America, Brazil, Japan, etc.)
		RF Strength	Display of radio power (Normal, Low, Ultralow).
		Local BPs	Number of Beltpacks connected to the Antenna.
		Eth Speed	Speed of the Ethernet interface.
	Net Info	Displays Net information:	
		Name	Name of the Net.
		Sys-Mode	System mode of the Net. (Standalone/AES67, Standalone/Link, Integrated/Artist)
		Antennas	Number of Antennas that are existing in the Net.
		Master	Name of the Antenna that is Sync-Master.
		RF Strength	Display of radio power (Normal, Low, Ultralow).
		Conn. BPs	Number of Beltpacks connected to the Net.
	Reg. BPs	Number of Beltpacks registered in the Net.	
	System Info	Displays System information:	
		Type	Type of the Antenna.
		Serial	Serial number of the Antenna.
		MAC	MAC-Address of the Antenna.
		Package	Package version of the Antenna.
		Main PCBA	Hardware revision of the mainboard.
		Radio PCBA	Hardware revision of the radio module.
		Display PCBA	Hardware revision of the display.
	Power PCBA	Hardware revision of the power supply.	

Leave Net *1	De-registration of the Antenna from the current Net.
Factory Reset *2	<ul style="list-style-type: none"> Resets the Antenna to factory default settings. All Data will be deleted!

*1 Admin PIN necessary

*2 Factory Reset PIN necessary (please consult Riedel Service)

5.5 Technical Drawing

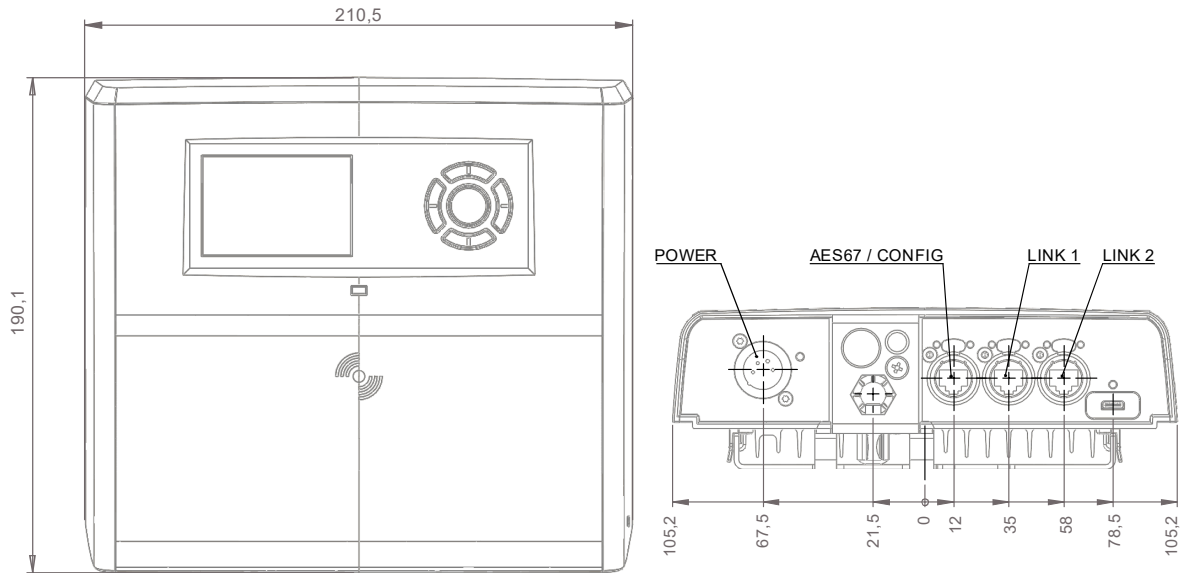

figure 217: Antenna (front, bottom), dimensions in millimeter

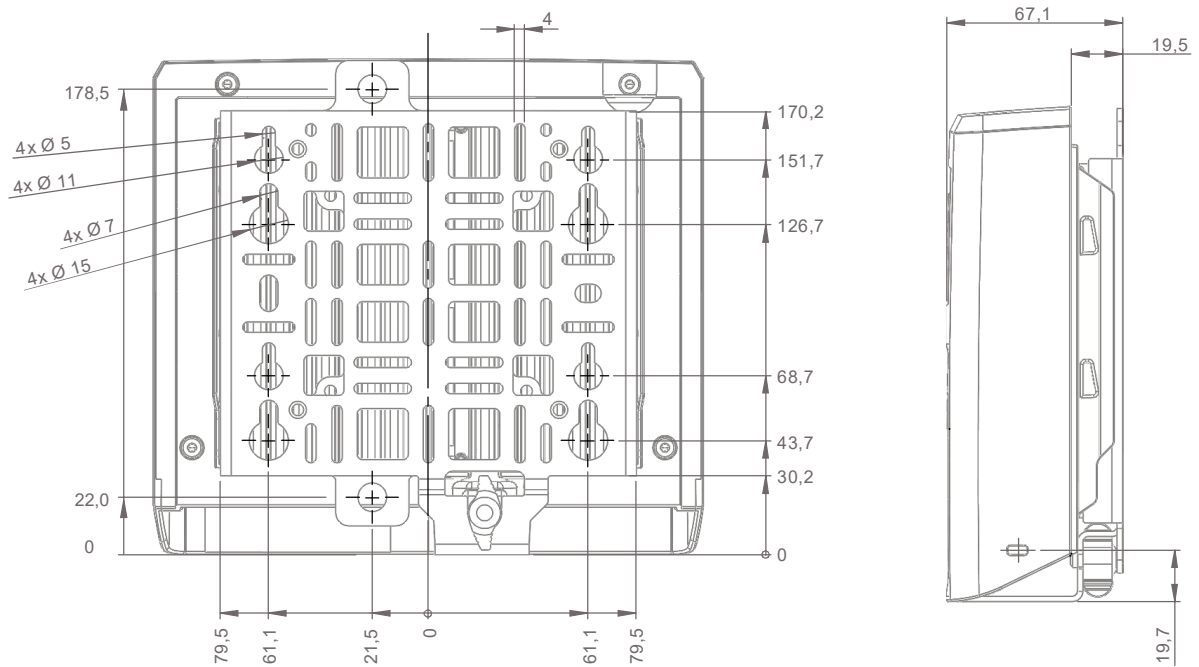

figure 218: Antenna (rear, right), dimensions in millimeter

5.6 Technical Specifications

Antenna Product Code	DECT	BL-ANT-1010-19	
	2.4GHz	BL-ANT-1008-24	
No of Beltpacks per Antenna	DECT	10	
	2.4GHz	8	
BL-ANT-1010-19: RF Frequency Range / average Power per channel	1.880 ... 1.930 GHz (region dependent, not changeable by the user)	EU	1880-1900 MHz / 10 mW
		US & CA	1920-1930 MHz / 4 mW
		JP	1894-1906 MHz / 4 mW
		BR	1910-1920 MHz / 10 mW
		LA	1910-1930 MHz / 10 mW
		MC	1880-1900 MHz / 4 mW
		TH	1900-1906 MHz / 10 mW
		MA & PH	1880-1890 MHz / 10 mW
BL-ANT-1008-24: RF Frequency Range / average Power	2.403 ... 2.479 GHz	Global	2403-2479 MHz / 4 mW
RF	Antenna Coverage	Indoor (structure dependent): max. ~200 m	
		Outdoor (free line of sight): max. ~300 ... 500 m (environment dependent)	
	Beltpack to Antenna range	Indoor (structure dependent): max. ~200 m	
		Outdoor (free line of sight): max. ~150 ... 250 m (environment dependent)	
Programmable RF Transmission power	Yes (country dependent) Maximum: 24 dBm / 250 mW, average: 10 dBm / 10 mW		
Beltpack Registration	1 touch NFC registration (Beltpack to Antenna, and Beltpack to Beltpack), OTA registration (Over The Air with PIN)		
Network Connection	AES67-IP or proprietary CAT5 for long range (300 m) non IP mode (Daisy chained and closed ring)		
	Network monitoring on Antenna	display IP, daisy chain, closed ring	
	Support of Layer 3 networks	yes	
	TTL Settings	Adjustable multicast TTL (1 to 255, default 16)	
USB Type-C Connection	Service use only		
Display Type	High contrast E-ink display		
Power Supply	PoE+ (802.3at, type 2, class 4, 15 ... 30 W) or 10 ... 57 VDC, 3 A (Bolero-Power-Supply 'BL-EPS-1001-00' or 'BL-EPS-1005-00')		
Power Consumption	15 W, 51 BTU/hr		
Mounting points	Mic stand threaded socket 5/8" & 3/8" inside, spigot adapter with wing screw lock, Kensington lock hole, screw hole for a safety wire mounting		
Dimensions	Width	210 mm / 8.3"	
	Height	190 mm / 7.5"	
	Depth	66 mm / 2.6"	
Weight	1320 g		
Environmental	IP-53 protected against limited dust ingress and water falling as a spray at an angle of up to 60° from vertical		
Operating Environment	Temperature	-10° ... +45°C	
	Humidity	0 % ... 90 % rel. (non-condensing), Ta=40°C	
Storage Temperature	-20° ... +70°C		

6 Bolero Charger

The Bolero 5-bay battery Charger has the ability to quickly and safely charge up to 5 Bolero batteries simultaneously. Light and powerful high-performance lithium rechargeable battery packs are used for the Beltpack. Battery packs are able to charge inside the Beltpack as well as separately in the 5-bay Charger.

Via the additional USB Type A and USB Type C connectors on the front side, two additional Bolero Beltpacks or any other USB devices can be charged.

Charging starts automatically after inserting the battery into a charging slot. An empty battery is charged in about 180 minutes. If a Beltpack is in the charging station, the Beltpack automatically shuts down the radio. If a Beltpack is charged via USB connector, the radio is not shut down.

It is possible to update the firmware of up to five (S-)Beltpacks in one Bolero-Charger. As long as a USB flash drive with valid firmware package is connected to the Charger, the Charger functions as an update station. The (S-)Beltpacks are charged simultaneously while updating.

6.1 Operating Elements

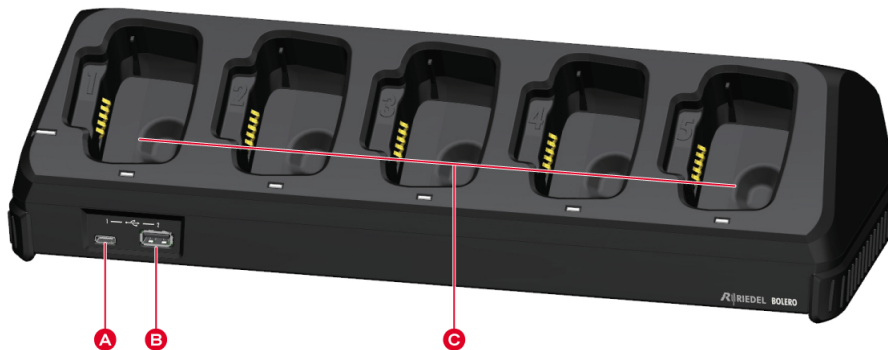

Figure 219: Charger – Operating Elements (top)

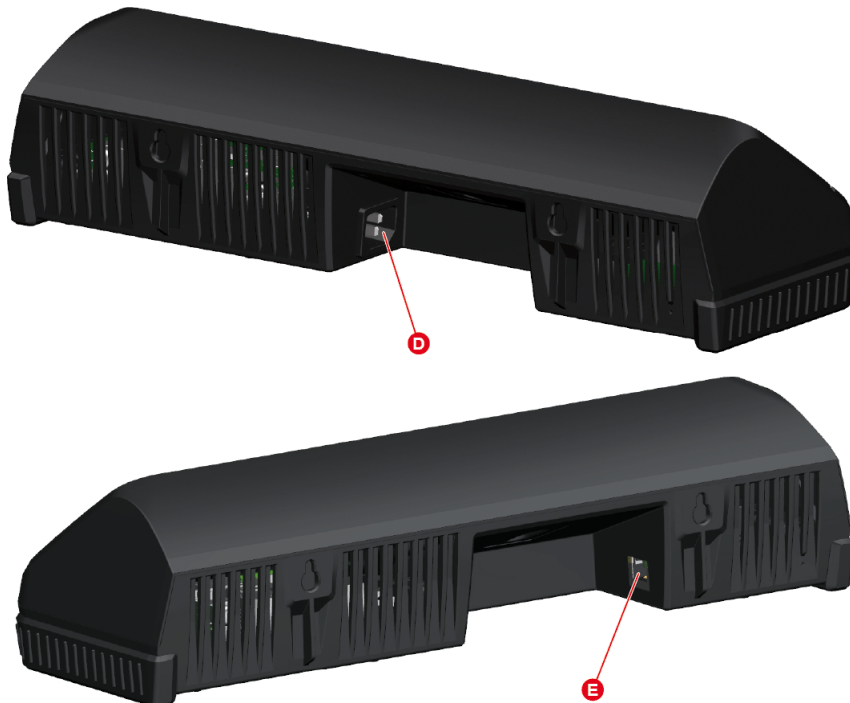

Figure 220: Charger – Operating Elements (rear)

A	USB connector (USB Type-C)
B	USB connector (USB Type-A)
C	5× charging slots for Batteries or Beltpacks
D	IEC mains connector
E	Network connector (RJ45 , future use)

USB Type-C

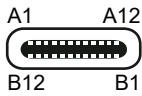

Figure 221: USB Type-C

Pin	Description	Pin	Description
1	GND	7	Dn1
2	SSTXp1	8	SBU1
3	SSTXn1	9	VBUS
4	VBUS	10	SSRXn2
5	CC1	11	SSRXp2
6	Dp1	12	GND

The USB connector is used to update the firmware and to charge an additional Bolero Beltpack or any other USB device. The maximum output current is 1.5 A.

USB Type-A

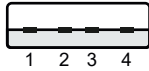

Figure 222: USB Type-A

Pin	Description
1	VBUS
2	D-
3	D+
4	GND

The USB connector is used to update the firmware and to charge an additional Bolero Beltpack or any other USB device. The maximum output current is 1.5 A.

RJ45

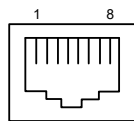

Figure 223: RJ45

Pin	Description
1	D1+
2	D1-
3	D2+
4	D3+
5	D3-
6	D2-
7	D4+
8	D4-

The RJ45 port supports links up to 100 Mbps and is reserved for future use.