

Annex D

Appendix to Test Report No.: 1-1776/21-04-05



Testing Laboratory

CTC advanced GmbH

Untertürkheimer Straße 6 – 10

66117 Saarbrücken/Germany

Phone: + 49 681 5 98 - 0

Fax: + 49 681 5 98 - 9075

Internet: <http://www.ctcadvanced.com>

e-mail: mail@ctcadvanced.com

Accredited Test Laboratory:

The testing laboratory (area of testing) is accredited according to DIN EN ISO/IEC 17025 (2005) by the Deutsche Akkreditierungsstelle GmbH (DAkks)

The accreditation is valid for the scope of testing procedures as stated in the accreditation certificate with the registration number: D-PL-12076-01-01

Appendix with Calibration data, Phantom certificate and system check information

1 Table of contents

1	Table of contents.....	2
2	Calibration report “Probe EX3DV4”	3
3	Calibration report “Probe EX3DV4”	14
4	Calibration report “13 MHz System validation dipole”	23
5	Calibration report “2450 MHz System validation dipole”	29
6	Calibration certificate of Data Acquisition Unit (DAE)	37
7	Calibration certificate of Data Acquisition Unit (DAE)	38
8	Certificate of “SAM Twin Phantom V4.0 and V5.0”	39
9	Application Note System Performance Check	40
9.1	Purpose of system performance check	40
9.2	System Performance check procedure.....	40
9.3	Uncertainty Budget	41
9.4	Power set-up for validation	45
9.5	Laboratory reflection	46
9.6	Additional system checks	46

2 Calibration report "Probe EX3DV4"

Calibration Laboratory of
Schmid & Partner
Engineering AG
Zeughausstrasse 43, 8004 Zurich, Switzerland



S Schweizerischer Kalibrierdienst
C Service suisse d'étalonnage
S Servizio svizzero di taratura
S Swiss Calibration Service

Accredited by the Swiss Accreditation Service (SAS)
The Swiss Accreditation Service is one of the signatories to the EA
Multilateral Agreement for the recognition of calibration certificates

Accreditation No.: SCS 0108

Client **CTC advanced GmbH**

Certificate No: **EX3-3944_May22**

CALIBRATION CERTIFICATE

Object: **EX3DV4 - SN:3944**

Calibration procedure(s): **QA CAL-01.v9, QA CAL-12.v9, QA CAL-14.v6, QA CAL-23.v5,
QA CAL-25.v7
Calibration procedure for dosimetric E-field probes**



Calibration date: **May 17, 2022**

This calibration certificate documents the traceability to national standards, which realize the physical units of measurements (SI).
The measurements and the uncertainties with confidence probability are given on the following pages and are part of the certificate.

All calibrations have been conducted in the closed laboratory facility: environment temperature $(22 \pm 3)^\circ\text{C}$ and humidity $< 70\%$.

Calibration Equipment used (M&TE critical for calibration)

Primary Standards	ID	Cal Date (Certificate No.)	Scheduled Calibration
Power meter NRP	SN: 104778	04-Apr-22 (No. 217-03525/03524)	Apr-23
Power sensor NRP-Z91	SN: 103244	04-Apr-22 (No. 217-03524)	Apr-23
Power sensor NRP-Z91	SN: 103245	04-Apr-22 (No. 217-03525)	Apr-23
Reference 20 dB Attenuator	SN: CC2552 (20x)	04-Apr-22 (No. 217-03527)	Apr-23
DAE4	SN: 660	13-Oct-21 (No. DAE4-660_Oct21)	Oct-22
Reference Probe ES3DV2	SN: 3013	27-Dec-21 (No. ES3-3013_Dec21)	Dec-22
Secondary Standards	ID	Check Date (in house)	Scheduled Check
Power meter E4419B	SN: GB41293874	05-Apr-16 (in house check Jun-20)	in house check: Jun-22
Power sensor E4412A	SN: MY41498087	05-Apr-16 (in house check Jun-20)	in house check: Jun-22
Power sensor E4412A	SN: 000110210	05-Apr-16 (in house check Jun-20)	in house check: Jun-22
RF generator HP 8648C	SN: US3642U01700	04-Aug-99 (in house check Jun-20)	in house check: Jun-22
Network Analyzer E8358A	SN: US41060477	31-Mar-14 (in house check Oct-20)	in house check: Oct-22

	Name	Function	Signature
Calibrated by:	Leif Klyzner	Laboratory Technician	
Approved by:	Sven Kühn	Technical Manager	

Issued: May 18, 2022

This calibration certificate shall not be reproduced except in full without written approval of the laboratory.

Calibration Laboratory of
Schmid & Partner
Engineering AG
Zeughausstrasse 43, 8004 Zurich, Switzerland



S Schweizerischer Kalibrierdienst
C Service suisse d'étalonnage
S Servizio svizzero di taratura
S Swiss Calibration Service

Accredited by the Swiss Accreditation Service (SAS)
The Swiss Accreditation Service is one of the signatories to the EA
Multilateral Agreement for the recognition of calibration certificates

Accreditation No.: SCS 0108

Glossary:

TSL	tissue simulating liquid
NORM _{x,y,z}	sensitivity in free space
ConvF	sensitivity in TSL / NORM _{x,y,z}
DCP	diode compression point
CF	crest factor (1/duty_cycle) of the RF signal
A, B, C, D	modulation dependent linearization parameters
Polarization φ	φ rotation around probe axis
Polarization β	β rotation around an axis that is in the plane normal to probe axis (at measurement center), i.e., $\beta = 0$ is normal to probe axis
Connector Angle	information used in DASY system to align probe sensor X to the robot coordinate system

Calibration is Performed According to the Following Standards:

- a) IEC/IEEE 62209-1528, "Measurement Procedure For The Assessment Of Specific Absorption Rate Of Human Exposure To Radio Frequency Fields From Hand-Held And Body-Worn Wireless Communication Devices - Part 1528. Human Models, Instrumentation And Procedures (Frequency Range of 4 MHz to 10 GHz)", October 2020.
- b) KDB 865664, "SAR Measurement Requirements for 100 MHz to 6 GHz"

Methods Applied and Interpretation of Parameters:

- NORM_{x,y,z}: Assessed for E-field polarization $\beta = 0$ ($f \leq 900$ MHz in TEM-cell; $f > 1800$ MHz: R22 waveguide). NORM_{x,y,z} are only intermediate values, i.e., the uncertainties of NORM_{x,y,z} does not affect the E²-field uncertainty inside TSL (see below ConvF).
- NORM(f)_{x,y,z} = NORM_{x,y,z} * frequency_response (see Frequency Response Chart). This linearization is implemented in DASY4 software versions later than 4.2. The uncertainty of the frequency response is included in the stated uncertainty of ConvF.
- DCP_{x,y,z}: DCP are numerical linearization parameters assessed based on the data of power sweep with CW signal (no uncertainty required). DCP does not depend on frequency nor media.
- PAR: PAR is the Peak to Average Ratio that is not calibrated but determined based on the signal characteristics
- A_{x,y,z}; B_{x,y,z}; C_{x,y,z}; D_{x,y,z}; VR_{x,y,z}: A, B, C, D are numerical linearization parameters assessed based on the data of power sweep for specific modulation signal. The parameters do not depend on frequency nor media. VR is the maximum calibration range expressed in RMS voltage across the diode.
- ConvF and Boundary Effect Parameters: Assessed in flat phantom using E-field (or Temperature Transfer Standard for $f \leq 800$ MHz) and inside waveguide using analytical field distributions based on power measurements for $f > 800$ MHz. The same setups are used for assessment of the parameters applied for boundary compensation (alpha, depth) of which typical uncertainty values are given. These parameters are used in DASY4 software to improve probe accuracy close to the boundary. The sensitivity in TSL corresponds to NORM_{x,y,z} * ConvF whereby the uncertainty corresponds to that given for ConvF. A frequency dependent ConvF is used in DASY version 4.4 and higher which allows extending the validity from ± 50 MHz to ± 100 MHz.
- Spherical isotropy (3D deviation from isotropy): in a field of low gradients realized using a flat phantom exposed by a patch antenna.
- Sensor Offset: The sensor offset corresponds to the offset of virtual measurement center from the probe tip (on probe axis). No tolerance required.
- Connector Angle: The angle is assessed using the information gained by determining the NORM_x (no uncertainty required).

EX3DV4 – SN:3944

May 17, 2022

DASY/EASY - Parameters of Probe: EX3DV4 - SN:3944

Basic Calibration Parameters

	Sensor X	Sensor Y	Sensor Z	Unc (k=2)
Norm ($\mu\text{V}/(\text{V}/\text{m})^2$) ^A	0.54	0.61	0.41	$\pm 10.1\%$
DCP (mV) ^B	99.5	100.2	104.4	

Calibration Results for Modulation Response

UID	Communication System Name		A dB	B dB μV	C	D dB	VR mV	Max dev.	Max Unc ^C (k=2)
0	CW	X	0.00	0.00	1.00	0.00	171.0	$\pm 2.5\%$	$\pm 4.7\%$
		Y	0.00	0.00	1.00		158.2		
		Z	0.00	0.00	1.00		169.1		
10352-AAA	Pulse Waveform (200Hz, 10%)	X	20.00	92.44	21.72	10.00	60.0	$\pm 2.9\%$	$\pm 9.6\%$
		Y	20.00	91.36	21.63		60.0		
		Z	8.67	79.45	16.56		60.0		
10353-AAA	Pulse Waveform (200Hz, 20%)	X	20.00	93.82	21.24	6.99	80.0	$\pm 1.6\%$	$\pm 9.6\%$
		Y	20.00	91.65	20.86		80.0		
		Z	20.00	89.00	18.10		80.0		
10354-AAA	Pulse Waveform (200Hz, 40%)	X	20.00	97.45	21.53	3.98	95.0	$\pm 1.2\%$	$\pm 9.6\%$
		Y	20.00	94.60	21.08		95.0		
		Z	20.00	90.36	17.20		95.0		
10355-AAA	Pulse Waveform (200Hz, 60%)	X	20.00	102.33	22.37	2.22	120.0	$\pm 1.1\%$	$\pm 9.6\%$
		Y	20.00	100.05	22.42		120.0		
		Z	20.00	91.19	16.30		120.0		
10387-AAA	QPSK Waveform, 1 MHz	X	1.69	66.21	15.14	1.00	150.0	$\pm 2.6\%$	$\pm 9.6\%$
		Y	1.78	66.15	15.40		150.0		
		Z	1.50	65.37	14.23		150.0		
10388-AAA	QPSK Waveform, 10 MHz	X	2.27	68.33	15.87	0.00	150.0	$\pm 0.9\%$	$\pm 9.6\%$
		Y	2.39	68.80	16.16		150.0		
		Z	2.00	66.74	15.01		150.0		
10396-AAA	64-QAM Waveform, 100 kHz	X	3.08	70.78	18.84	3.01	150.0	$\pm 0.9\%$	$\pm 9.6\%$
		Y	3.53	72.86	19.83		150.0		
		Z	2.33	67.25	17.21		150.0		
10399-AAA	64-QAM Waveform, 40 MHz	X	3.53	67.27	15.86	0.00	150.0	$\pm 1.8\%$	$\pm 9.6\%$
		Y	3.59	67.38	15.95		150.0		
		Z	3.34	66.52	15.39		150.0		
10414-AAA	WLAN CCDF, 64-QAM, 40MHz	X	4.91	65.72	15.59	0.00	150.0	$\pm 3.5\%$	$\pm 9.6\%$
		Y	4.98	65.69	15.59		150.0		
		Z	4.68	65.30	15.29		150.0		

Note: For details on UID parameters see Appendix

The reported uncertainty of measurement is stated as the standard uncertainty of measurement multiplied by the coverage factor k=2, which for a normal distribution corresponds to a coverage probability of approximately 95%.

^A The uncertainties of Norm X, Y, Z do not affect the E²-field uncertainty inside TSI, (see Pages 5, 6 and 7).

^B Numerical linearization parameter: uncertainty not required.

^C Uncertainty is determined using the max. deviation from linear response applying rectangular distribution and is expressed for the square of the field value.

EX3DV4- SN:3944

May 17, 2022

DASY/EASY - Parameters of Probe: EX3DV4 - SN:3944**Sensor Model Parameters**

	C1 fF	C2 fF	α V ⁻¹	T1 ms.V ⁻²	T2 ms.V ⁻¹	T3 ms	T4 V ⁻²	T5 V ⁻¹	T6
X	49.3	368.59	35.63	14.80	0.41	5.08	0.85	0.39	1.01
Y	56.2	418.58	35.44	28.75	0.28	5.10	1.51	0.33	1.01
Z	39.8	294.52	34.94	7.83	0.43	5.03	0.50	0.26	1.01

Other Probe Parameters

Sensor Arrangement	Triangular
Connector Angle (°)	178.3
Mechanical Surface Detection Mode	enabled
Optical Surface Detection Mode	disabled
Probe Overall Length	337 mm
Probe Body Diameter	10 mm
Tip Length	9 mm
Tip Diameter	2.5 mm
Probe Tip to Sensor X Calibration Point	1 mm
Probe Tip to Sensor Y Calibration Point	1 mm
Probe Tip to Sensor Z Calibration Point	1 mm
Recommended Measurement Distance from Surface	1.4 mm

Note: Measurement distance from surface can be increased to 3-4 mm for an Area Scan job.

EX3DV4-- SN:3944

May 17, 2022

DASY/EASY - Parameters of Probe: EX3DV4 - SN:3944

Calibration Parameter Determined in Head Tissue Simulating Media

f (MHz) ^c	Relative Permittivity ^f	Conductivity (S/m) ^f	ConvF X	ConvF Y	ConvF Z	Alpha ^g	Depth ^g (mm)	Unc (k=2)
13	55.0	0.75	18.39	18.39	18.39	0.00	1.00	± 13.3 %
750	41.9	0.89	10.53	10.53	10.53	0.49	0.80	± 12.0 %
850	41.5	0.92	10.17	10.17	10.17	0.33	1.02	± 12.0 %
900	41.5	0.97	10.01	10.01	10.01	0.31	1.03	± 12.0 %
1750	40.1	1.37	8.58	8.58	8.58	0.29	0.86	± 12.0 %
1900	40.0	1.40	8.42	8.42	8.42	0.34	0.86	± 12.0 %
2450	39.2	1.80	7.97	7.97	7.97	0.33	0.90	± 12.0 %
2600	39.0	1.96	7.75	7.75	7.75	0.33	0.90	± 12.0 %
3500	37.9	2.91	6.96	6.96	6.96	0.35	1.30	± 14.0 %
3700	37.7	3.12	6.91	6.91	6.91	0.35	1.30	± 14.0 %
5200	36.0	4.66	5.22	5.22	5.22	0.40	1.80	± 14.0 %
5300	35.9	4.76	5.12	5.12	5.12	0.40	1.80	± 14.0 %
5500	35.6	4.96	4.99	4.99	4.99	0.40	1.80	± 14.0 %
5600	35.5	5.07	4.94	4.94	4.94	0.40	1.80	± 14.0 %
5800	35.3	5.27	4.81	4.81	4.81	0.40	1.80	± 14.0 %

^c Frequency validity above 300 MHz of ± 100 MHz only applies for DASY v4.4 and higher (see Page 2), else it is restricted to ± 50 MHz. The uncertainty is the RSS of the ConvF uncertainty at calibration frequency and the uncertainty for the indicated frequency band. Frequency validity below 300 MHz is ± 10, 25, 40, 50 and 70 MHz for ConvF assessments at 30, 64, 128, 150 and 220 MHz respectively. Validity of ConvF assessed at 8 MHz is 4-9 MHz, and ConvF assessed at 13 MHz is 9-19 MHz. Above 5 GHz frequency validity can be extended to ± 110 MHz.

^f At frequencies up to 6 GHz, the validity of tissue parameters (ϵ and σ) can be relaxed to ± 10% if liquid compensation formula is applied to measured SAR values. The uncertainty is the RSS of the ConvF uncertainty for indicated target tissue parameters.

^g Alpha/Depth are determined during calibration. SPEAG warrants that the remaining deviation due to the boundary effect after compensation is always less than ± 1% for frequencies below 3 GHz and below ± 2% for frequencies between 3-6 GHz at any distance larger than half the probe tip diameter from the boundary.

EX3DV4– SN 3944

May 17, 2022

DASY/EASY - Parameters of Probe: EX3DV4 - SN:3944

Calibration Parameter Determined in Body Tissue Simulating Media

f (MHz) ^c	Relative Permittivity ^f	Conductivity (S/m) ^f	ConvF X	ConvF Y	ConvF Z	Alpha ^g	Depth ^g (mm)	Unc (k=2)
750	55.5	0.96	10.61	10.61	10.61	0.44	0.84	± 12.0 %
850	55.2	0.99	10.26	10.26	10.26	0.41	0.80	± 12.0 %
900	55.0	1.05	10.11	10.11	10.11	0.37	0.89	± 12.0 %
1750	53.4	1.49	8.47	8.47	8.47	0.37	0.86	± 12.0 %
1900	53.3	1.52	8.23	8.23	8.23	0.38	0.86	± 12.0 %
2450	52.7	1.95	8.22	8.22	8.22	0.20	0.90	± 12.0 %
2600	52.5	2.16	7.96	7.96	7.96	0.16	0.90	± 12.0 %
3500	51.3	3.31	6.42	6.42	6.42	0.40	1.70	± 14.0 %
3700	51.0	3.55	6.33	6.33	6.33	0.40	1.70	± 14.0 %
5200	49.0	5.30	4.64	4.64	4.64	0.50	1.90	± 14.0 %
5300	48.9	5.42	4.50	4.50	4.50	0.50	1.90	± 14.0 %
5500	48.6	5.65	4.10	4.10	4.10	0.50	1.90	± 14.0 %
5600	48.5	5.77	3.98	3.98	3.98	0.50	1.90	± 14.0 %
5800	48.2	6.00	4.12	4.12	4.12	0.50	1.90	± 14.0 %

^c Frequency validity above 300 MHz of ± 100 MHz only applies for DASY v4.4 and higher (see Page 2), else it is restricted to ± 50 MHz. The uncertainty is the RSS of the ConvF uncertainty at calibration frequency and the uncertainty for the indicated frequency band. Frequency validity below 300 MHz is ± 10, 25, 40, 50 and 70 MHz for ConvF assessments at 30, 64, 128, 150 and 220 MHz respectively. Validity of ConvF assessed at 5 MHz is 4–9 MHz, and ConvF assessed at 13 MHz is 9–19 MHz. Above 5 GHz frequency validity can be extended to ± 110 MHz.

^f At frequencies up to 6 GHz, the validity of tissue parameters (ϵ' and σ) can be relaxed to ± 10% if liquid compensation formula is applied to measured SAR values. The uncertainty is the RSS of the ConvF uncertainty for indicated target tissue parameters.

^g Alpha/Depth are determined during calibration. SPEAG warrants that the remaining deviation due to the boundary effect after compensation is always less than ± 1% for frequencies below 3 GHz and below ± 2% for frequencies between 3–6 GHz at any distance larger than half the probe tip diameter from the boundary.

EX3DV4- SN:3944

May 17, 2022

DASY/EASY - Parameters of Probe: EX3DV4 - SN:3944

Calibration Parameter Determined in Head Tissue Simulating Media

f (MHz) ^c	Relative Permittivity ^d	Conductivity (S/m) ^e	ConvF X	ConvF Y	ConvF Z	Alpha ^g	Depth ^h (mm)	Unc (k=2)
6500	34.5	6.07	5.50	5.50	5.50	0.20	2.50	± 18.6 %

^c Frequency validity at 6.5 GHz is -800/+700 MHz, and ± 700 MHz at or above 7 GHz. The uncertainty is the RSS of the ConvF uncertainty at calibration frequency and the uncertainty for the indicated frequency band.

^d At frequencies 6-10 GHz, the validity of tissue parameters (ϵ and σ) can be relaxed to ± 10% if liquid compensation formula is applied to measured SAR values. The uncertainty is the RSS of the ConvF uncertainty for indicated target tissue parameters.

^g Alpha/Depth are determined during calibration. SPEAG warrants that the remaining deviation due to the boundary effect after compensation is always less than ± 1% for frequencies below 3 GHz; below ± 2% for frequencies between 3-6 GHz; and below ± 4% for frequencies between 6-10 GHz at any distance larger than half the probe tip diameter from the boundary.

EX3DV4- SN 3944

May 17, 2022

Frequency Response of E-Field (TEM-Cell: ifi110 EXX, Waveguide: R22)

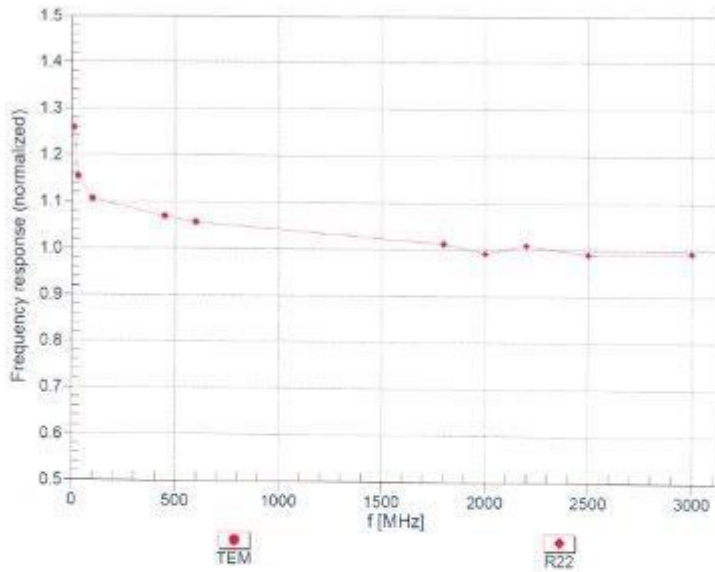

Uncertainty of Frequency Response of E-field: $\pm 6.3\%$ ($k=2$)

EX3DV4- SN:3944

May 17, 2022

Receiving Pattern (ϕ), $\theta = 0^\circ$

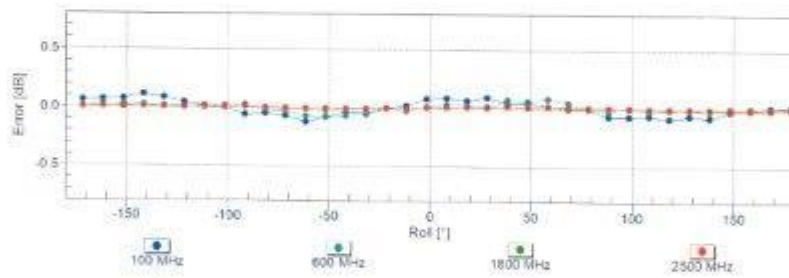
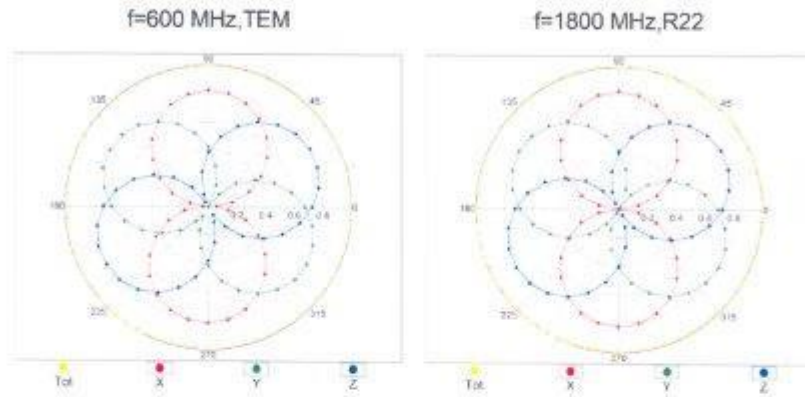

Uncertainty of Axial Isotropy Assessment: $\pm 0.5\%$ ($k=2$)

EX3DV4- SN:3944

May 17, 2022

Dynamic Range $f(SAR_{head})$ (TEM cell, $f_{eval} = 1900$ MHz)

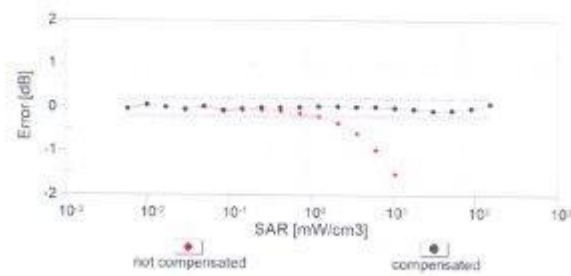
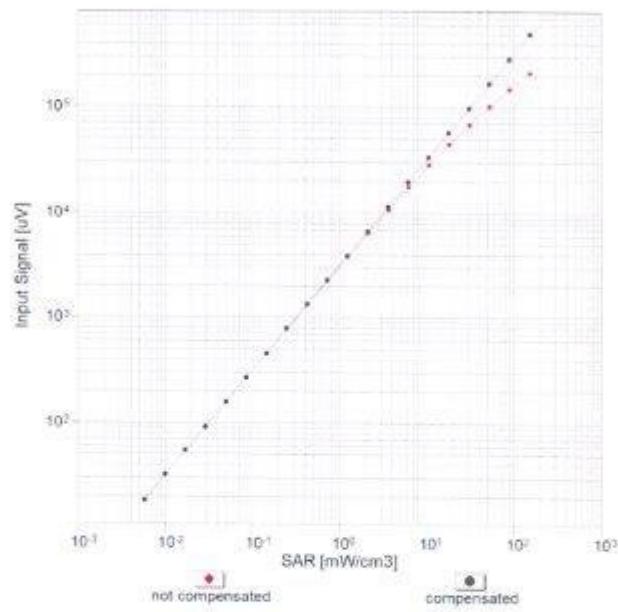

Uncertainty of Linearity Assessment: $\pm 0.6\%$ ($k=2$)

EX3DV4- SN:3944

May 17, 2022

Conversion Factor Assessment

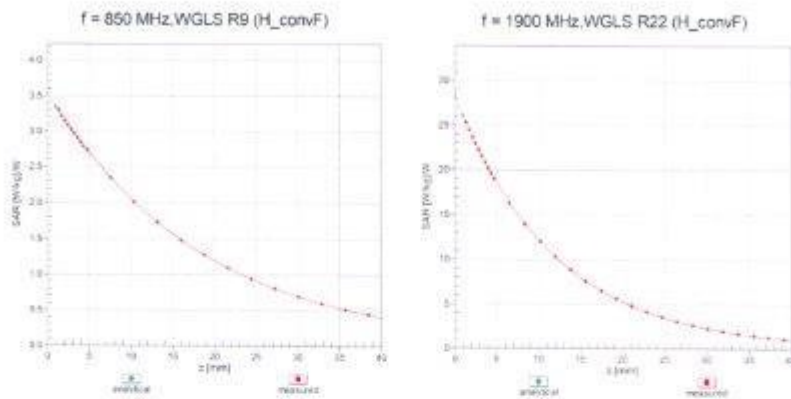

Deviation from Isotropy in Liquid Error (ϕ , θ), f = 900 MHz

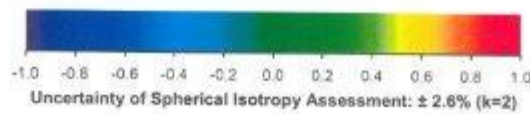
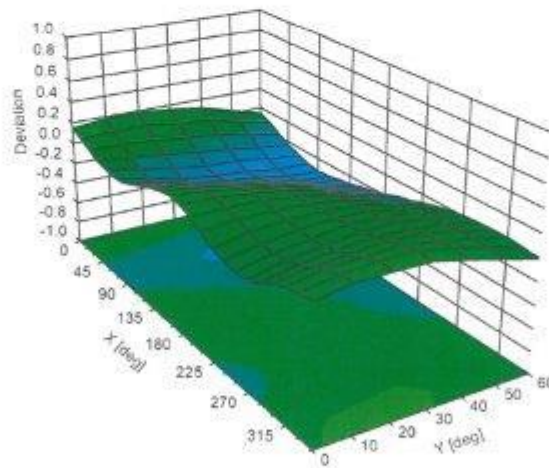

3 Calibration report "Probe EX3DV4"

Calibration Laboratory of
Schmid & Partner
Engineering AG
Zeughausstrasse 43, 8004 Zurich, Switzerland



S Schweizerischer Kalibrierdienst
C Service suisse d'étalonnage
S Servizio svizzero di taratura
S Swiss Calibration Service

Accredited by the Swiss Accreditation Service (SAS)
The Swiss Accreditation Service is one of the signatories to the EA
Multilateral Agreement for the recognition of calibration certificates

Accreditation No.: SCS 0108

Client **CTC advanced GmbH**

Certificate No **EX-7566_Aug22**

CALIBRATION CERTIFICATE

Object: **EX3DV4 - SN:7566**

Calibration procedure(s): **QA CAL-01.v9, QA CAL-12.v9, QA CAL-14.v6, QA CAL-23.v5,
QA CAL-25.v7
Calibration procedure for dosimetric E-field probes**

Calibration date: **August 23, 2022**

This calibration certificate documents the traceability to national standards, which realize the physical units of measurements [SI].
The measurements and the uncertainties with confidence probability are given on the following pages and are part of the certificate.

All calibrations have been conducted in the closed laboratory facility: environment temperature (22 ± 3) °C and humidity < 70%.

Calibration Equipment used (M&TE critical for calibration)

Primary Standards	ID	Cal Date (Certificate No.)	Scheduled Calibration
Power meter NRP	SN: 104778	04-Apr-22 (No. 217-03525/03524)	Apr-23
Power sensor NRP_Z91	SN: 103244	04-Apr-22 (No. 217-03524)	Apr-23
OCP DAK-3.5 (weighted)	SN: 1249	20-Oct-21 (OCP-DAK3.5-1249_Oct21)	Oct-22
OCP DAK-12	SN: 1016	20-Oct-21 (OCP-DAK12-1016_Oct21)	Oct-22
Reference 20 dB Attenuator	SN: CC2552 (20x)	04-Apr-22 (No. 217-03527)	Apr-23
DAE4	SN: 660	13-Oct-21 (No. DAE4-660_Oct21)	Oct-22
Reference Probe ES3DV2	SN: 3013	27-Dec-21 (No. ES3-3013_Dec21)	Dec-22

Secondary Standards	ID	Check Date (in house)	Scheduled Check
Power meter E4419B	SN: GB41293874	06-Apr-16 (in house check Jun-22)	In house check: Jun-24
Power sensor E4412A	SN: MY41498087	06-Apr-16 (in house check Jun-22)	In house check: Jun-24
Power sensor E4412A	SN: 000110210	06-Apr-16 (in house check Jun-22)	In house check: Jun-24
RF generator HP 8648C	SN: US3642U01700	04-Aug-99 (in house check Jun-22)	In house check: Jun-24
Network Analyzer E8358A	SN: US41080477	31-Mar-14 (in house check Oct-20)	In house check: Oct-22

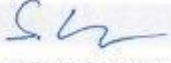
	Name	Function	Signature
Calibrated by	Jeton Kasrall	Laboratory Technician	
Approved by	Sven Kühn	Technical Manager	

Issued: August 24, 2022

This calibration certificate shall not be reproduced except in full without written approval of the laboratory.

Calibration Laboratory of
Schmid & Partner
Engineering AG
Zeughausstrasse 43, 8004 Zurich, Switzerland



S Schweizerischer Kalibrierdienst
C Service suisse d'étalonnage
S Servizio svizzero di taratura
S Swiss Calibration Service

Accredited by the Swiss Accreditation Service (SAS)
The Swiss Accreditation Service is one of the signatories to the EA
Multilateral Agreement for the recognition of calibration certificates

Accreditation No.: SCS 0108

Glossary

TSL	tissue simulating liquid
NORM _{x,y,z}	sensitivity in free space
ConvF	sensitivity in TSL / NORM _{x,y,z}
DCP	diode compression point
CF	crest factor (1/duty_cycle) of the RF signal
A, B, C, D	modulation dependent linearization parameters
Polarization ψ	ψ rotation around probe axis
Polarization θ	θ rotation around an axis that is in the plane normal to probe axis (at measurement center), i.e., $\theta = 0$ is normal to probe axis
Connector Angle	information used in DASY system to align probe sensor X to the robot coordinate system

Calibration is Performed According to the Following Standards:

- IEC/IEEE 62209-1528, "Measurement Procedure For The Assessment Of Specific Absorption Rate Of Human Exposure To Radio Frequency Fields From Hand-Held And Body-Worn Wireless Communication Devices – Part 1528: Human Models, Instrumentation And Procedures (Frequency Range of 4 MHz to 10 GHz)", October 2020.
- KDB 865684, "SAR Measurement Requirements for 100 MHz to 6 GHz"

Methods Applied and Interpretation of Parameters:

- NORM_{x,y,z}**: Assessed for E-field polarization $\theta = 0$ ($f \leq 900$ MHz in TEM-cell; $f > 1800$ MHz: R22 waveguide). NORM_{x,y,z} are only intermediate values, i.e., the uncertainties of NORM_{x,y,z} does not affect the E²-field uncertainty inside TSL (see below ConvF).
- NORM(*f*)_{x,y,z} = NORM_{x,y,z} * frequency_response** (see Frequency Response Chart). This linearization is implemented in DASY4 software versions later than 4.2. The uncertainty of the frequency response is included in the stated uncertainty of ConvF.
- DCP_{x,y,z}**: DCP are numerical linearization parameters assessed based on the data of power sweep with CW signal. DCP does not depend on frequency nor media.
- PAR**: PAR is the Peak to Average Ratio that is not calibrated but determined based on the signal characteristics.
- A_{x,y,z}; B_{x,y,z}; C_{x,y,z}; D_{x,y,z}; VR_{x,y,z}**: A, B, C, D are numerical linearization parameters assessed based on the data of power sweep for specific modulation signal. The parameters do not depend on frequency nor media. VR is the maximum calibration range expressed in RMS voltage across the diode.
- ConvF and Boundary Effect Parameters**: Assessed in flat phantom using E-field (or Temperature Transfer Standard for $f \leq 800$ MHz) and inside waveguide using analytical field distributions based on power measurements for $f > 800$ MHz. The same setups are used for assessment of the parameters applied for boundary compensation (alpha, depth) of which typical uncertainty values are given. These parameters are used in DASY4 software to improve probe accuracy close to the boundary. The sensitivity in TSL corresponds to NORM_{x,y,z} * ConvF whereby the uncertainty corresponds to that given for ConvF. A frequency dependent ConvF is used in DASY version 4.4 and higher which allows extending the validity from ± 50 MHz to ± 100 MHz.
- Spherical isotropy (3D deviation from isotropy)**: in a field of low gradients realized using a flat phantom exposed by a patch antenna.
- Sensor Offset**: The sensor offset corresponds to the offset of virtual measurement center from the probe tip (on probe axis). No tolerance required.
- Connector Angle**: The angle is assessed using the information gained by determining the NORM_x (no uncertainty required).

EX3DV4 - SN:7566

August 23, 2022

Parameters of Probe: EX3DV4 - SN:7566

Basic Calibration Parameters

	Sensor X	Sensor Y	Sensor Z	Unc (k = 2)
Norm ($\mu\text{V}/(\text{V}/\text{m})^2$) ^A	0.86	0.47	0.51	$\pm 10.1\%$
DCP (mV) ^B	99.1	99.2	100.2	$\pm 4.7\%$

Calibration Results for Modulation Response

UID	Communication System Name		A dB	B dB $\cdot\sqrt{\mu\text{V}}$	C	D dB	VR mV	Max dev.	Max Unc ^E k = 2
0	CW	X	0.00	0.00	1.00	0.00	147.8	$\pm 2.5\%$	$\pm 4.7\%$
		Y	0.00	0.00	1.00		157.1		
		Z	0.00	0.00	1.00		150.2		
10352	Pulse Waveform (200Hz, 10%)	X	20.00	88.48	19.42	10.00	60.0	$\pm 3.1\%$	$\pm 9.6\%$
		Y	20.00	89.82	19.75		60.0		
		Z	14.30	83.19	17.00		60.0		
10353	Pulse Waveform (200Hz, 20%)	X	20.00	88.45	18.63	6.99	80.0	$\pm 1.9\%$	$\pm 9.6\%$
		Y	20.00	91.70	19.43		80.0		
		Z	20.00	86.61	17.04		80.0		
10354	Pulse Waveform (200Hz, 40%)	X	20.00	89.91	18.27	3.98	95.0	$\pm 1.4\%$	$\pm 9.6\%$
		Y	20.00	95.14	19.49		95.0		
		Z	20.00	87.64	16.39		95.0		
10355	Pulse Waveform (200Hz, 60%)	X	20.00	92.63	18.45	2.22	120.0	$\pm 1.1\%$	$\pm 9.6\%$
		Y	20.00	92.18	16.62		120.0		
		Z	20.00	88.70	15.82		120.0		
10387	QPSK Waveform, 1 MHz	X	1.74	66.49	15.26	1.00	150.0	$\pm 2.8\%$	$\pm 9.6\%$
		Y	1.44	65.35	14.09		150.0		
		Z	1.68	66.16	14.94		150.0		
10388	QPSK Waveform, 10 MHz	X	2.34	68.67	16.02	0.00	150.0	$\pm 0.9\%$	$\pm 9.6\%$
		Y	2.12	67.89	15.50		150.0		
		Z	2.26	68.19	15.72		150.0		
10396	64-QAM Waveform, 100 kHz	X	3.09	71.40	18.33	3.01	150.0	$\pm 1.1\%$	$\pm 9.6\%$
		Y	2.23	66.69	17.05		150.0		
		Z	2.84	70.23	18.81		150.0		
10399	64-QAM Waveform, 40 MHz	X	3.59	67.47	15.95	0.00	150.0	$\pm 2.2\%$	$\pm 9.6\%$
		Y	3.45	67.14	15.72		150.0		
		Z	3.54	67.27	15.82		150.0		
10414	WLAN CCDF, 64-QAM, 40 MHz	X	4.98	65.95	15.71	0.00	150.0	$\pm 4.1\%$	$\pm 9.6\%$
		Y	4.80	65.81	15.61		150.0		
		Z	4.92	65.82	15.83		150.0		

Note: For details on UID parameters see Appendix :

The reported uncertainty of measurement is stated as the standard uncertainty of measurement multiplied by the coverage factor $k=2$, which for a normal distribution corresponds to a coverage probability of approximately 95%.

^A The uncertainties of Norm X,Y,Z do not affect the E²-field uncertainty inside TSL (see Page 5).

^B Linearization parameter uncertainty for maximum specified field strength.

^E Uncertainty is determined using the max. deviation from linear response applying rectangular distribution and is expressed for the square of the field value.

EX3DV4 - SN:7566

August 23, 2022

Parameters of Probe: EX3DV4 - SN:7566

Sensor Model Parameters

	C1 IF	C2 IF	α V^{-1}	T1 ms V^{-2}	T2 ms V^{-1}	T3 ms	T4 V^{-2}	T5 V^{-1}	T6
x	49.4	368.60	35.70	27.71	0.00	5.09	0.94	0.31	1.01
y	39.4	297.86	36.31	10.22	0.17	5.10	0.00	0.35	1.01
z	47.2	354.25	35.67	18.59	0.00	5.06	0.73	0.30	1.01

Other Probe Parameters

Sensor Arrangement	Triangular
Connector Angle	-68.1°
Mechanical Surface Detection Mode	enabled
Optical Surface Detection Mode	disabled
Probe Overall Length	337 mm
Probe Body Diameter	10 mm
Tip Length	9 mm
Tip Diameter	2.5 mm
Probe Tip to Sensor X Calibration Point	1 mm
Probe Tip to Sensor Y Calibration Point	1 mm
Probe Tip to Sensor Z Calibration Point	1 mm
Recommended Measurement Distance from Surface	1.4 mm

Note: Measurement distance from surface can be increased to 3-4 mm for an Area Scan job.

EX3DV4 - SN:7566

August 23, 2022

Parameters of Probe: EX3DV4 - SN:7566**Calibration Parameter Determined in Head Tissue Simulating Media**

f (MHz) ^C	Relative Permittivity ^F	Conductivity ^F (S/m)	ConvF X	ConvF Y	ConvF Z	Alpha ^G	Depth ^G (mm)	Unc (k = 2)
750	41.9	0.89	10.30	10.30	10.30	0.47	0.80	±12.0%
850	41.5	0.92	10.02	10.02	10.02	0.42	0.89	±12.0%
900	41.5	0.97	9.89	9.89	9.89	0.49	0.80	±12.0%
1750	40.1	1.37	8.65	8.65	8.65	0.25	0.86	±12.0%
1900	40.0	1.40	8.29	8.29	8.29	0.25	0.86	±12.0%
2450	39.2	1.80	7.75	7.75	7.75	0.11	0.90	±12.0%
2600	39.0	1.96	7.54	7.54	7.54	0.24	0.90	±12.0%
3500	37.9	2.91	6.96	6.96	6.96	0.30	1.35	±14.0%
3700	37.7	3.12	6.77	6.77	6.77	0.30	1.35	±14.0%
5200	36.0	4.66	5.46	5.46	5.46	0.40	1.80	±14.0%
5300	35.9	4.76	5.35	5.35	5.35	0.40	1.80	±14.0%
5500	35.6	4.96	4.92	4.92	4.92	0.40	1.80	±14.0%
5600	35.5	5.07	4.77	4.77	4.77	0.40	1.80	±14.0%
5800	35.3	5.27	4.84	4.84	4.84	0.40	1.80	±14.0%

^C Frequency validity above 300MHz of ±100MHz only applies for DASy v4.4 and higher (see Page 2), else it is restricted to ±50 MHz. The uncertainty is the RSS of the ConvF uncertainty at calibration frequency and the uncertainty for the indicated frequency band. Frequency validity below 300 MHz is ±10, 25, 40, 50 and 70 MHz for ConvF assessments at 30, 64, 128, 150 and 200 MHz respectively. Validity of ConvF assessed at 6 MHz is 4–8 MHz, and ConvF assessed at 13 MHz is 9–19 MHz. Above 5 GHz frequency validity can be extended to ±110 MHz.

^F At frequencies below 3 GHz, the validity of tissue parameters (ϵ' and σ) can be relaxed to ±10% if liquid compensation formula is applied to measured SAR values. At frequencies above 3 GHz, the validity of tissue parameters (ϵ' and σ) is restricted to ±5%. The uncertainty is the RSS of the ConvF uncertainty for indicated target tissue parameters.

^G Alpha/Depth are determined during calibration. SPEAG warrants that the remaining deviation due to the boundary effect after compensation is always less than ±1% for frequencies below 3 GHz and below ±2% for frequencies between 3–6 GHz at any distance larger than half the probe tip diameter from the boundary.

EX3DV4 - SN:7566

August 23, 2022

Frequency Response of E-Field (TEM-Cell:if110 EXX, Waveguide:R22)

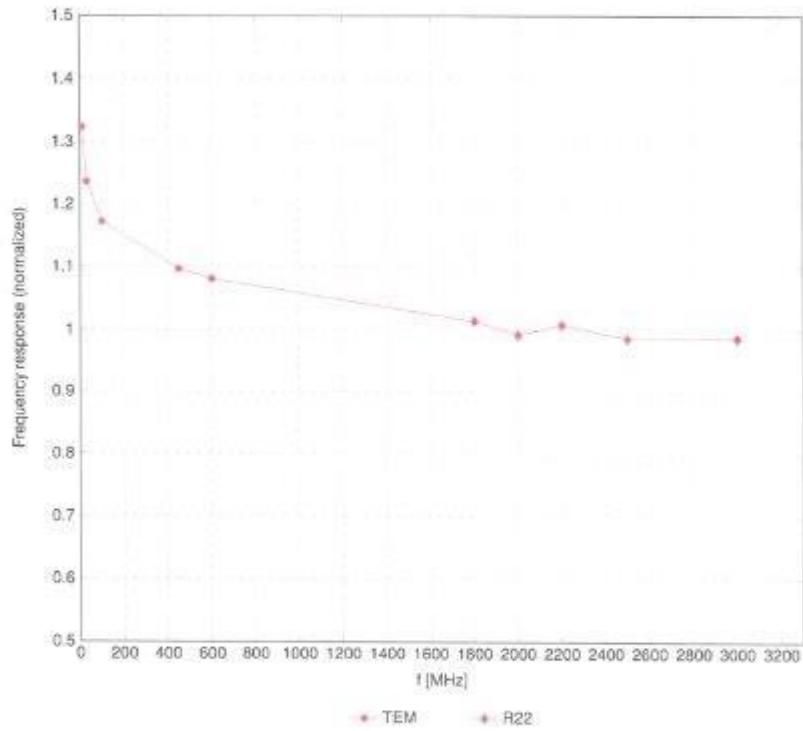

Uncertainty of Frequency Response of E-field: $\pm 6.3\%$ (k=2)

EX3DV4 - SN:7566

August 23, 2022

Receiving Pattern (ϕ), $\theta = 0^\circ$

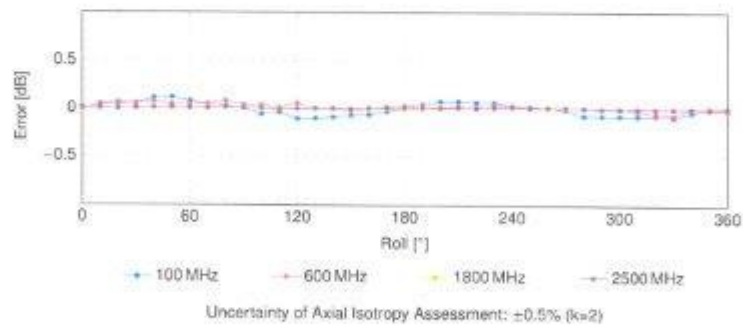
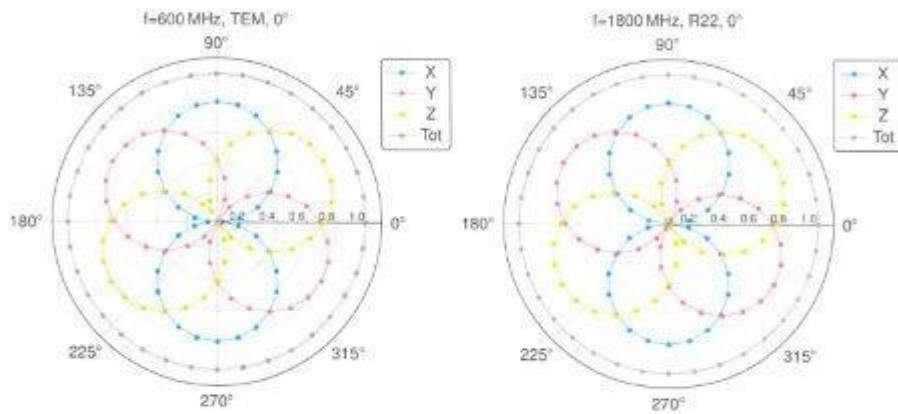

EX3DV4 - SN:7566

August 23, 2022

Dynamic Range f(SAR_{head})

(TEM cell, f_{eval} = 1900 MHz)

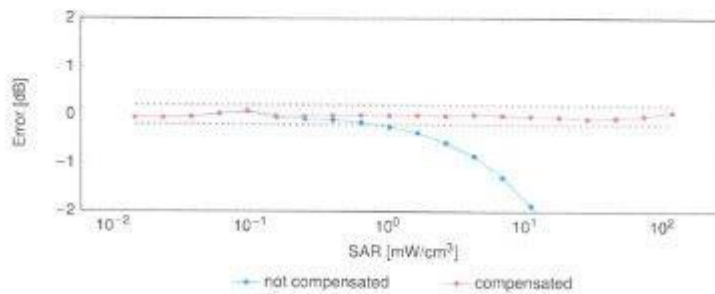
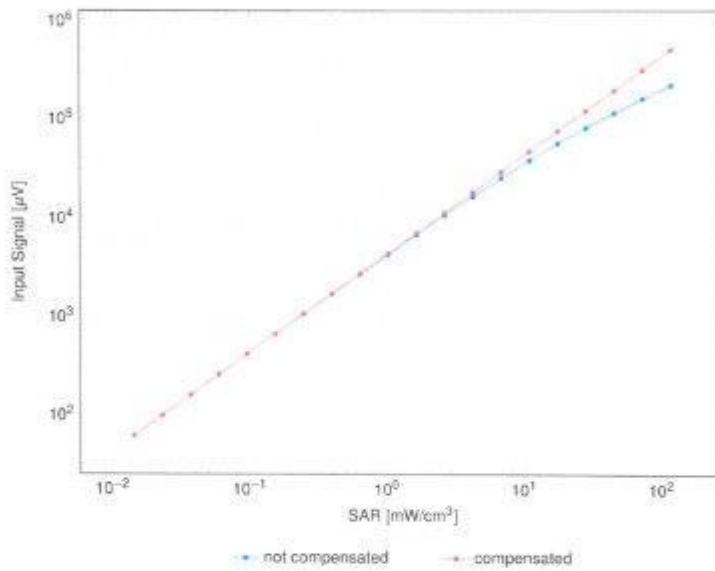

Uncertainty of Linearity Assessment: ±0.6% (k=2)

EX3DV4 - SN:7566

August 23, 2022

Conversion Factor Assessment

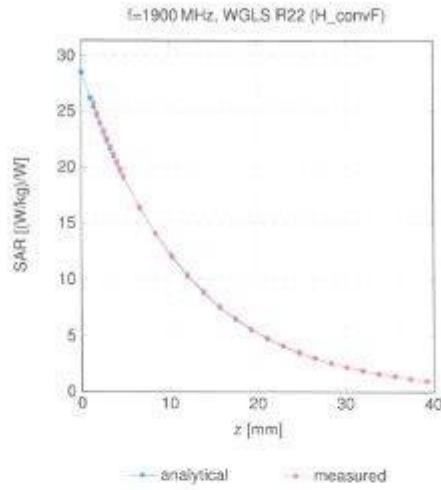

Deviation from Isotropy in Liquid

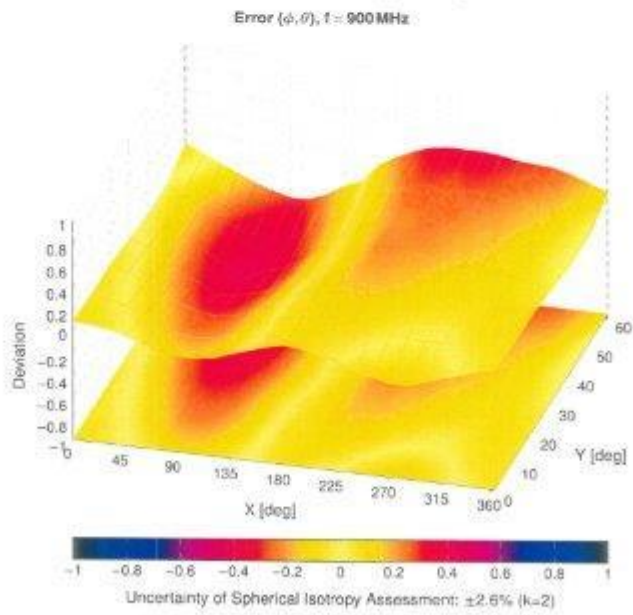

4 Calibration report “13 MHz System validation dipole”

**Calibration Laboratory of
Schmid & Partner
Engineering AG**
Zeughausstrasse 43, 8004 Zurich, Switzerland



S Schweizerischer Kalibrierdienst
C Service suisse d'étalonnage
S Servizio svizzero di taratura
S Swiss Calibration Service

Accredited by the Swiss Accreditation Service (SAS)
The Swiss Accreditation Service is one of the signatories to the EA
Multilateral Agreement for the recognition of calibration certificates

Accreditation No.: **SCS 0108**

Client **CTC advanced GmbH**

Certificate No: **CLA13-1026_Sep22**

CALIBRATION CERTIFICATE

Object **CLA13 - SN: 1026**

Calibration procedure(s) **QA CAL-15.v9
Calibration Procedure for SAR Validation Sources below 700 MHz**

Calibration date: **September 27, 2022**



This calibration certificate documents the traceability to national standards, which realize the physical units of measurements (SI).
The measurements and the uncertainties with confidence probability are given on the following pages and are part of the certificate.

All calibrations have been conducted in the closed laboratory facility: environment temperature (22 ± 3)°C and humidity < 70%.

Calibration Equipment used (M&TE critical for calibration)

Primary Standards	ID #	Cal Date (Certificate No.)	Scheduled Calibration
Power meter NRP	SN: 104778	04-Apr-22 (No. 217-03525/03524)	Apr-23
Power sensor NRP-Z91	SN: 103244	04-Apr-22 (No. 217-03524)	Apr-23
Power sensor NRP-Z91	SN: 103245	04-Apr-22 (No. 217-03525)	Apr-23
Reference 20 dB Attenuator	SN: CC2552 (20x)	04-Apr-22 (No. 217-03527)	Apr-23
Type-N mismatch combination	SN: 310982 / 06327	04-Apr-22 (No. 217-03528)	Apr-23
Reference Probe EX3DV4	SN: 3877	31-Dec-21 (No. EX3-3877_Dec21)	Dec-22
DAE4	SN: 654	26-Jan-22 (No. DAE4-654_Jan22)	Jan-23

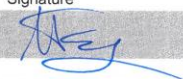
Secondary Standards	ID #	Check Date (in house)	Scheduled Check
Power meter E4419B	SN: GB41293874	06-Apr-16 (in house check Jun-22)	In house check: Jun-24
Power sensor E4412A	SN: MY41498087	06-Apr-16 (in house check Jun-22)	In house check: Jun-24
Power sensor E4412A	SN: 000110210	06-Apr-16 (in house check Jun-22)	In house check: Jun-24
RF generator HP 8648C	SN: US3642U01700	04-Aug-99 (in house check Jun-22)	In house check: Jun-24
Network Analyzer Agilent E8358A	SN: US41080477	31-Mar-14 (in house check Oct-20)	In house check: Oct-22

	Name	Function	Signature
Calibrated by:	Aldonia Georgiadou	Laboratory Technician	
Approved by:	Sven Kühn	Technical Manager	

Issued: October 3, 2022

This calibration certificate shall not be reproduced except in full without written approval of the laboratory.

Calibration Laboratory of
Schmid & Partner
Engineering AG
Zeughausstrasse 43, 8004 Zurich, Switzerland



S Schweizerischer Kalibrierdienst
C Service suisse d'étalonnage
S Servizio svizzero di taratura
S Swiss Calibration Service

Accredited by the Swiss Accreditation Service (SAS)

The Swiss Accreditation Service is one of the signatories to the EA
Multilateral Agreement for the recognition of calibration certificates

Accreditation No.: **SCS 0108**

Glossary:

TSL tissue simulating liquid
ConvF sensitivity in TSL / NORM x,y,z
N/A not applicable or not measured

Calibration is Performed According to the Following Standards:

- a) IEEE Std 1528-2013, "IEEE Recommended Practice for Determining the Peak Spatial-Averaged Specific Absorption Rate (SAR) in the Human Head from Wireless Communications Devices: Measurement Techniques", June 2013
- b) IEC 62209-1, "Measurement procedure for the assessment of Specific Absorption Rate (SAR) from hand-held and body-mounted devices used next to the ear (frequency range of 300 MHz to 6 GHz)", July 2016
- c) IEC 62209-2, "Procedure to determine the Specific Absorption Rate (SAR) for wireless communication devices used in close proximity to the human body (frequency range of 30 MHz to 6 GHz)", March 2010
- d) KDB 865664, "SAR Measurement Requirements for 100 MHz to 6 GHz"

Additional Documentation:

- e) DASY4/5 System Handbook

Methods Applied and Interpretation of Parameters:

- *Measurement Conditions:* Further details are available from the Validation Report at the end of the certificate. All figures stated in the certificate are valid at the frequency indicated.
- *Antenna Parameters with TSL:* The source is mounted in a touch configuration below the center marking of the flat phantom.
- *Return Loss:* This parameter is measured with the source positioned under the liquid filled phantom (as described in the measurement condition clause). The Return Loss ensures low reflected power. No uncertainty required.
- *SAR measured:* SAR measured at the stated antenna input power.
- *SAR normalized:* SAR as measured, normalized to an input power of 1 W at the antenna connector.
- *SAR for nominal TSL parameters:* The measured TSL parameters are used to calculate the nominal SAR result.

The reported uncertainty of measurement is stated as the standard uncertainty of measurement multiplied by the coverage factor $k=2$, which for a normal distribution corresponds to a coverage probability of approximately 95%.

Measurement Conditions

DASY system configuration, as far as not given on page 1.

DASY Version	DASY5	V52.10.4
Extrapolation	Advanced Extrapolation	
Phantom	ELI4 Flat Phantom	Shell thickness: 2 ± 0.2 mm
EUT Positioning	Touch Position	
Zoom Scan Resolution	$dx, dy = 4.0$ mm, $dz = 1.4$ mm	Graded Ratio = 1.4 (Z direction)
Frequency	13 MHz ± 1 MHz	

Head TSL parameters

The following parameters and calculations were applied.

	Temperature	Permittivity	Conductivity
Nominal Head TSL parameters	22.0 °C	55.0	0.75 mho/m
Measured Head TSL parameters	(22.0 ± 0.2) °C	53.4 ± 6 %	0.72 mho/m ± 6 %
Head TSL temperature change during test	< 0.5 °C	----	----

SAR result with Head TSL

SAR averaged over 1 cm³ (1 g) of Head TSL	Condition	
SAR measured	1 W input power	0.519 W/kg
SAR for nominal Head TSL parameters	normalized to 1W	0.533 W/kg ± 18.4 % (k=2)

SAR averaged over 10 cm³ (10 g) of Head TSL	condition	
SAR measured	1 W input power	0.327 W/kg
SAR for nominal Head TSL parameters	normalized to 1W	0.335 W/kg ± 18.0 % (k=2)

Appendix (Additional assessments outside the scope of SCS 0108)

Antenna Parameters with Head TSL

Impedance, transformed to feed point	52.2 Ω + 0.2 j Ω
Return Loss	- 33.4 dB

Additional EUT Data

Manufactured by	SPEAG
-----------------	-------

DASY5 Validation Report for Head TSL

Date: 27.09.2022

Test Laboratory: SPEAG, Zurich, Switzerland

DUT: CLA13; Type: CLA13; Serial: CLA13 - SN: 1026

Communication System: UID 0 - CW; Frequency: 13 MHz

Medium parameters used: $f = 13$ MHz; $\sigma = 0.72$ S/m; $\epsilon_r = 53.4$; $\rho = 1000$ kg/m³

Phantom section: Flat Section

Measurement Standard: DASY5 (IEEE/IEC/ANSI C63.19-2007)

DASY52 Configuration:

- Probe: EX3DV4 - SN3877; ConvF(15.33, 15.33, 15.33) @ 13 MHz; Calibrated: 31.12.2021
- Sensor-Surface: 1.4mm (Mechanical Surface Detection)
- Electronics: DAE4 Sn654; Calibrated: 26.01.2022
- Phantom: ELI v4.0; Type: QDOVA001BB; Serial: TP:1003
- DASY52 52.10.4(1535); SEMCAD X 14.6.14(7501)

CLA Calibration for HSL-LF Tissue/CLA-13, touch configuration, Pin=1W/Zoom Scan,

dist=1.4mm (8x10x8)/Cube 0: Measurement grid: dx=4mm, dy=4mm, dz=1.4mm

Reference Value = 28.23 V/m; Power Drift = -0.09 dB

Peak SAR (extrapolated) = 1.04 W/kg

SAR(1 g) = 0.519 W/kg; SAR(10 g) = 0.327 W/kg

Smallest distance from peaks to all points 3 dB below = 17.6 mm

Ratio of SAR at M2 to SAR at M1 = 78.9%

Maximum value of SAR (measured) = 0.763 W/kg

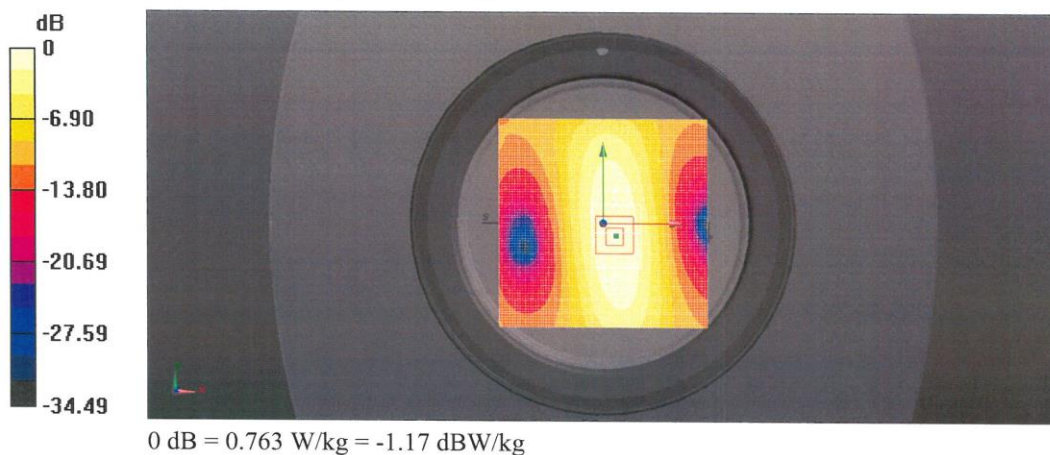

Impedance Measurement Plot for Head TSL

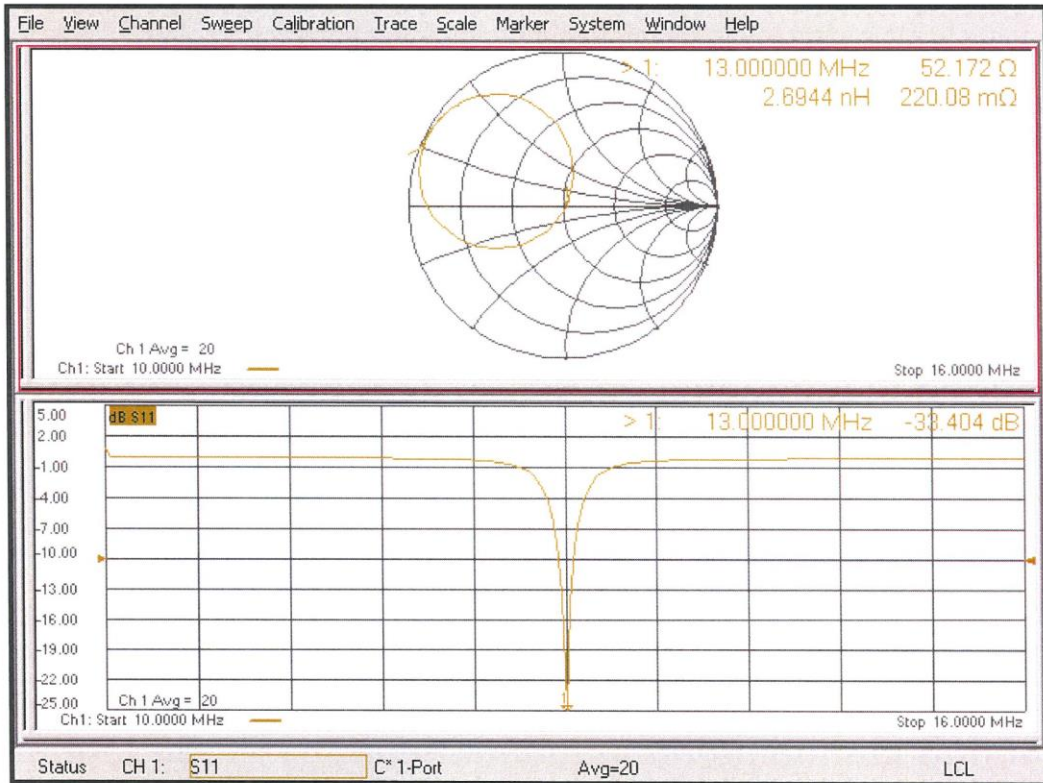

5 Calibration report “2450 MHz System validation dipole”

**Calibration Laboratory of
Schmid & Partner
Engineering AG**
Zeughausstrasse 43, 8004 Zurich, Switzerland



S Schweizerischer Kalibrierdienst
S Service suisse d'étalonnage
C Servizio svizzero di taratura
S Swiss Calibration Service

Accredited by the Swiss Accreditation Service (SAS)
The Swiss Accreditation Service is one of the signatories to the EA
Multilateral Agreement for the recognition of calibration certificates

Accreditation No.: **SCS 0108**

Client **CTC advanced GmbH**

Certificate No: **D2450V2-710_May22**

CALIBRATION CERTIFICATE

Object: **D2450V2 - SN:710**

Calibration procedure(s): **QA CAL-05.v11
Calibration Procedure for SAR Validation Sources between 0.7-3 GHz**



Calibration date: **May 11, 2022**

This calibration certificate documents the traceability to national standards, which realize the physical units of measurements (SI).
The measurements and the uncertainties with confidence probability are given on the following pages and are part of the certificate.

All calibrations have been conducted in the closed laboratory facility: environment temperature (22 ± 3)°C and humidity < 70%.

Calibration Equipment used (M&TE critical for calibration)

Primary Standards	ID #	Cal Date (Certificate No.)	Scheduled Calibration
Power meter NRP	SN: 104778	04-Apr-22 (No. 217-03525/03524)	Apr-23
Power sensor NRP-Z91	SN: 103244	04-Apr-22 (No. 217-03524)	Apr-23
Power sensor NRP-Z91	SN: 103245	04-Apr-22 (No. 217-03525)	Apr-23
Reference 20 dB Attenuator	SN: B49394 (20k)	04-Apr-22 (No. 217-03527)	Apr-23
Type-N mismatch combination	SN: 310982 / 06327	04-Apr-22 (No. 217-03528)	Apr-23
Reference Probe EX3DV4	SN: 7349	31-Dec-21 (No. EX3-7349_Dec21)	Dec-22
DAE4	SN: 601	02-May-22 (No. DAE4-601_May22)	May-23
Secondary Standards	ID #	Check Date (in house)	Scheduled Check
Power meter E4419B	SN: GB39512475	30-Oct-14 (in house check Oct-20)	In house check: Oct-22
Power sensor HP 8481A	SN: US37292783	07-Oct-15 (in house check Oct-20)	In house check: Oct-22
Power sensor HP 8481A	SN: MY41093315	07-Oct-15 (in house check Oct-20)	In house check: Oct-22
RF generator R&S SMT-05	SN: 100972	15-Jun-15 (in house check Oct-20)	In house check: Oct-22
Network Analyzer Agilent E8358A	SN: US41090477	31-Mar-14 (in house check Oct-20)	In house check: Oct-22

	Name	Function	Signature
Calibrated by:	Aldonis Georgiadou	Laboratory Technician	
Approved by:	Sven Kuhn	Technical Manager	

Issued: May 12, 2022

This calibration certificate shall not be reproduced except in full without written approval of the laboratory.

**Calibration Laboratory of
Schmid & Partner
Engineering AG**
Zeughausstrasse 43, 8004 Zurich, Switzerland



S Schweizerischer Kalibrierdienst
C Service suisse d'étalonnage
S Servizio svizzero di taratura
S Swiss Calibration Service

Accredited by the Swiss Accreditation Service (SAS)

The Swiss Accreditation Service is one of the signatories to the EA Multilateral Agreement for the recognition of calibration certificates

Accreditation No.: **SCS 0108**

Glossary:

TSL	tissue simulating liquid
ConvF	sensitivity in TSL / NORM x,y,z
N/A	not applicable or not measured

Calibration is Performed According to the Following Standards:

- IEC/IEEE 62209-1528, "Measurement Procedure For The Assessment Of Specific Absorption Rate Of Human Exposure To Radio Frequency Fields From Hand-Held And Body-Worn Wireless Communication Devices - Part 1528: Human Models, Instrumentation And Procedures (Frequency Range of 4 MHz to 10 GHz)", October 2020.
- KDB 865664, "SAR Measurement Requirements for 100 MHz to 6 GHz"

Additional Documentation:

- DASY System Handbook

Methods Applied and Interpretation of Parameters:

- Measurement Conditions:* Further details are available from the Validation Report at the end of the certificate. All figures stated in the certificate are valid at the frequency indicated.
- Antenna Parameters with TSL:* The source is mounted in a touch configuration below the center marking of the flat phantom.
- Return Loss:* This parameter is measured with the source positioned under the liquid filled phantom (as described in the measurement condition clause). The Return Loss ensures low reflected power. No uncertainty required.
- SAR measured:* SAR measured at the stated antenna input power.
- SAR normalized:* SAR as measured, normalized to an input power of 1 W at the antenna connector.
- SAR for nominal TSL parameters:* The measured TSL parameters are used to calculate the nominal SAR result.

The reported uncertainty of measurement is stated as the standard uncertainty of measurement multiplied by the coverage factor $k=2$, which for a normal distribution corresponds to a coverage probability of approximately 95%.

Measurement Conditions

DASY system configuration, as far as not given on page 1:

DASY Version	DASY52	V52.10.4
Extrapolation	Advanced Extrapolation	
Phantom	Modular Flat Phantom	
Distance Dipole Center - TSL	10 mm	with Spacer
Zoom Scan Resolution	dx, dy, dz = 5 mm	
Frequency	2450 MHz \pm 1 MHz	

Head TSL parameters

The following parameters and calculations were applied.

	Temperature	Permittivity	Conductivity
Nominal Head TSL parameters	22.0 °C	39.2	1.80 mho/m
Measured Head TSL parameters	(22.0 \pm 0.2) °C	38.2 \pm 6 %	1.85 mho/m \pm 6 %
Head TSL temperature change during test	< 0.5 °C	---	---

SAR result with Head TSL

SAR averaged over 1 cm ³ (1 g) of Head TSL	Condition	
SAR measured	250 mW input power	13.2 W/kg
SAR for nominal Head TSL parameters	normalized to 1W	51.8 W/kg \pm 17.0 % (k=2)
SAR averaged over 10 cm ³ (10 g) of Head TSL	condition	
SAR measured	250 mW input power	6.09 W/kg
SAR for nominal Head TSL parameters	normalized to 1W	24.1 W/kg \pm 16.5 % (k=2)

Body TSL parameters

The following parameters and calculations were applied.

	Temperature	Permittivity	Conductivity
Nominal Body TSL parameters	22.0 °C	52.7	1.95 mho/m
Measured Body TSL parameters	(22.0 \pm 0.2) °C	51.5 \pm 6 %	2.02 mho/m \pm 6 %
Body TSL temperature change during test	< 0.5 °C	---	---

SAR result with Body TSL

SAR averaged over 1 cm ³ (1 g) of Body TSL	Condition	
SAR measured	250 mW input power	12.7 W/kg
SAR for nominal Body TSL parameters	normalized to 1W	49.6 W/kg \pm 17.0 % (k=2)
SAR averaged over 10 cm ³ (10 g) of Body TSL	condition	
SAR measured	250 mW input power	5.95 W/kg
SAR for nominal Body TSL parameters	normalized to 1W	23.5 W/kg \pm 16.5 % (k=2)

Appendix (Additional assessments outside the scope of SCS 0108)**Antenna Parameters with Head TSL**

Impedance, transformed to feed point	$52.8 \Omega + 3.7 j\Omega$
Return Loss	- 26,9 dB

Antenna Parameters with Body TSL

Impedance, transformed to feed point	$49.3 \Omega + 4.3 j\Omega$
Return Loss	- 27,1 dB

General Antenna Parameters and Design

Electrical Delay (one direction)	1.159 ns
----------------------------------	----------

After long term use with 100W radiated power, only a slight warming of the dipole near the feedpoint can be measured.

The dipole is made of standard semirigid coaxial cable. The center conductor of the feeding line is directly connected to the second arm of the dipole. The antenna is therefore short-circuited for DC-signals. On some of the dipoles, small end caps are added to the dipole arms in order to improve matching when loaded according to the position as explained in the "Measurement Conditions" paragraph. The SAR data are not affected by this change. The overall dipole length is still according to the Standard.

No excessive force must be applied to the dipole arms, because they might bend or the soldered connections near the feedpoint may be damaged.

Additional EUT Data

Manufactured by	SPEAG
-----------------	-------

DASY5 Validation Report for Head TSL

Date: 11.05.2022

Test Laboratory: SPEAG, Zurich, Switzerland

DUT: Dipole 2450 MHz; Type: D2450V2; Serial: D2450V2 - SN:710

Communication System: UID 0 - CW; Frequency: 2450 MHz
 Medium parameters used: $f = 2450$ MHz; $\sigma = 1.85$ S/m; $\epsilon_r = 38.2$; $\rho = 1000$ kg/m³
 Phantom section: Flat Section
 Measurement Standard: DASY5 (IEEE/IEC/ANSI C63.19-2011)

DASY52 Configuration:

- Probe: EX3DV4 - SN7349; ConvF(7.96, 7.96, 7.96) @ 2450 MHz; Calibrated: 31.12.2021
- Sensor-Surface: 1.4mm (Mechanical Surface Detection)
- Electronics: DAE4 Sn601; Calibrated: 02.05.2022
- Phantom: Flat Phantom 5.0 (front); Type: QD 000 P50 AA; Serial: 1001
- DASY52 52.10.4(1535); SEMCAD X 14.6.14(7501)

Dipole Calibration for Head Tissue/Pin=250 mW, d=10mm/Zoom Scan (7x7x7)/Cube 0:

Measurement grid: dx=5mm, dy=5mm, dz=5mm
 Reference Value = 116.1 V/m; Power Drift = 0.02 dB
 Peak SAR (extrapolated) = 26.3 W/kg
SAR(1 g) = 13.2 W/kg; SAR(10 g) = 6.09 W/kg
 Smallest distance from peaks to all points 3 dB below = 9 mm
 Ratio of SAR at M2 to SAR at M1 = 50%
 Maximum value of SAR (measured) = 21.8 W/kg

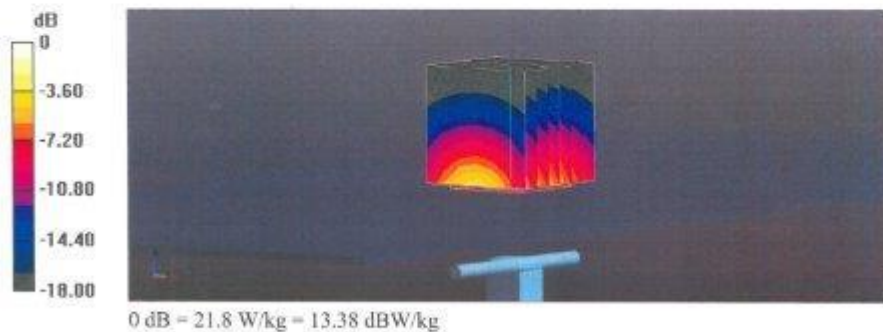

Impedance Measurement Plot for Head TSL

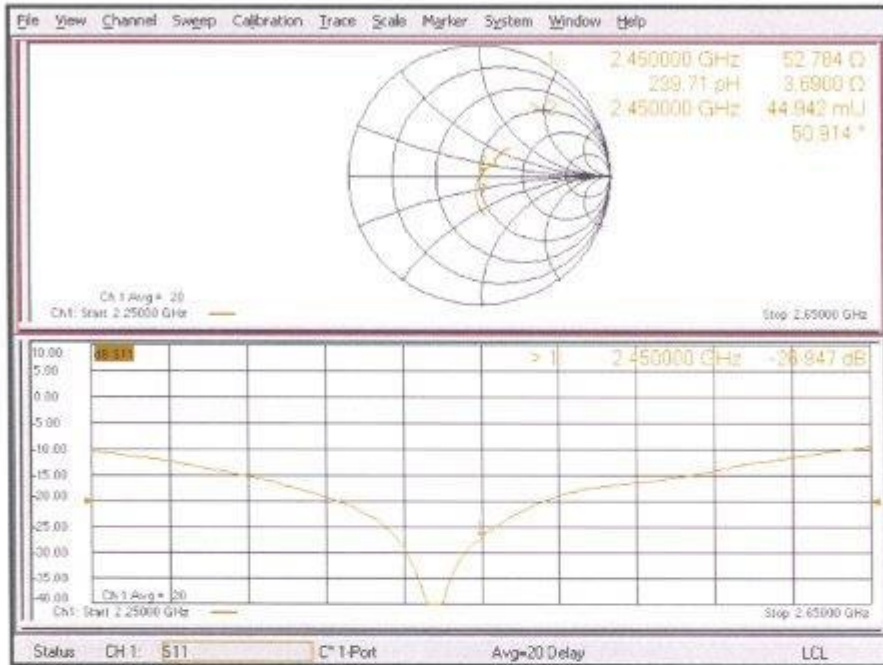

DASY5 Validation Report for Body TSL

Date: 11.05.2022

Test Laboratory: SPEAG, Zurich, Switzerland

DUT: Dipole 2450 MHz; Type: D2450V2; Serial: D2450V2 - SN:710

Communication System: UID 0 - CW; Frequency: 2450 MHz
 Medium parameters used: $f = 2450$ MHz; $\sigma = 2.02$ S/m; $\epsilon_r = 51.5$; $\rho = 1000$ kg/m³
 Phantom section: Flat Section
 Measurement Standard: DASY5 (IEEE/IEC/ANSI C63.19-2011)

DASY52 Configuration:

- Probe: EX3DV4 - SN7349; ConvF(8.12, 8.12, 8.12) @ 2450 MHz; Calibrated: 31.12.2021
- Sensor-Surface: 1.4mm (Mechanical Surface Detection)
- Electronics: DAE4 Sn601; Calibrated: 02.05.2022
- Phantom: Flat Phantom 5.0 (back); Type: QD 000 P50 AA; Serial: 1002
- DASY52 52.10.4(1535); SEMCAD X 14.6.14(7501)

Dipole Calibration for Body Tissue/Pin=250 mW, d=10mm/Zoom Scan (7x7x7)/Cube 0:

Measurement grid: dx=5mm, dy=5mm, dz=5mm
 Reference Value = 105.8 V/m; Power Drift = -0.06 dB
 Peak SAR (extrapolated) = 24.0 W/kg
SAR(1 g) = 12.7 W/kg; SAR(10 g) = 5.95 W/kg
 Smallest distance from peaks to all points 3 dB below = 8.9 mm
 Ratio of SAR at M2 to SAR at M1 = 54.1%
 Maximum value of SAR (measured) = 20.0 W/kg

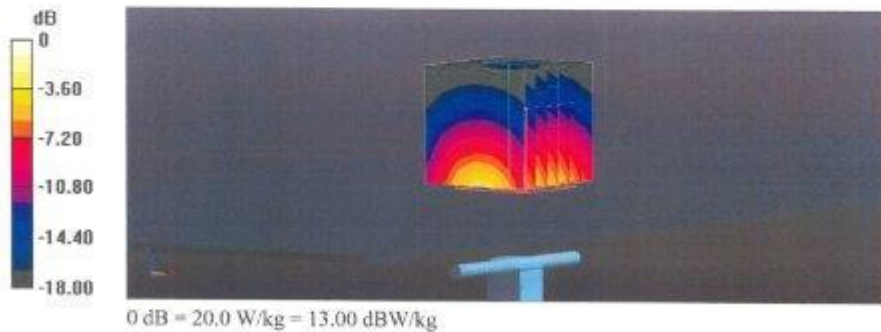

Impedance Measurement Plot for Body TSL

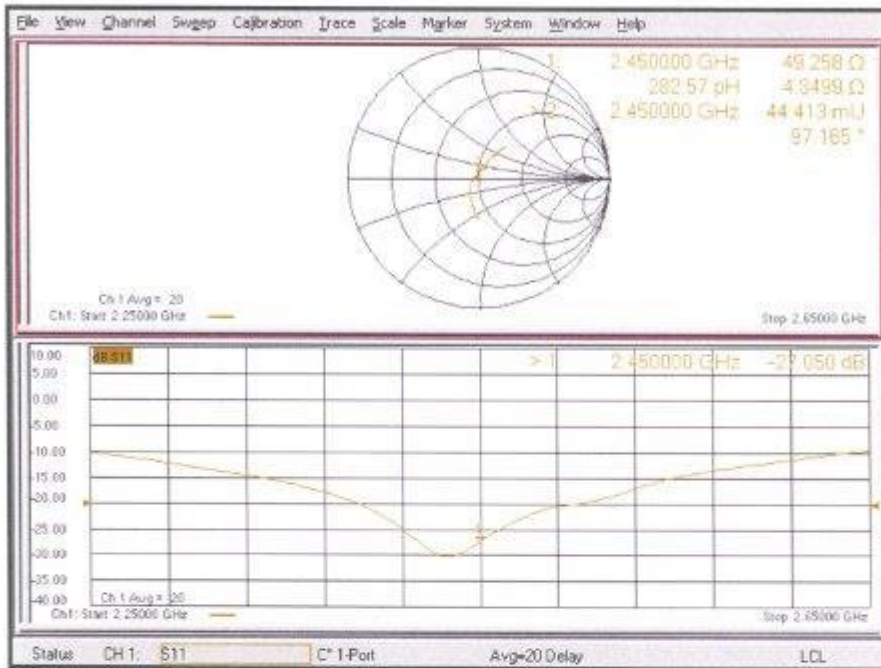

6 Calibration certificate of Data Acquisition Unit (DAE)

Calibration Laboratory of
Schmid & Partner
Engineering AG
Zeughausstrasse 43, 8004 Zurich, Switzerland



S Schweizerischer Kalibrierdienst
C Service suisse d'étalonnage
S Servizio svizzero di taratura
S Swiss Calibration Service

Accredited by the Swiss Accreditation Service (SAS)
The Swiss Accreditation Service is one of the signatories to the EA
Multilateral Agreement for the recognition of calibration certificates

Accreditation No.: SCS 0108

Client: CTC advanced GmbH

Certificate No: DAE4-1387_Aug22

CALIBRATION CERTIFICATE

Object: DAE4 - SD 000 D04 BM - SN: 1387

Calibration procedure(s): QA CAL-06.v30
Calibration procedure for the data acquisition electronics (DAE)

Calibration date: August 17, 2022

This calibration certificate documents the traceability to national standards, which realize the physical units of measurements (SI).
The measurements and the uncertainties with confidence probability are given on the following pages and are part of the certificate.

All calibrations have been conducted in the closed laboratory facility: environment temperature (22 ± 3)°C and humidity < 70%.

Calibration Equipment used (M&TE critical for calibration)

Primary Standards	ID #	Cal Date (Certificate No.)	Scheduled Calibration
Kethley Multimeter Type 2001	SN: 0610278	31-Aug-21 (No.31366)	Aug-22
Secondary Standards	ID #	Check Date (in house)	Scheduled Check
Auto DAE Calibration Unit	SE UWS 053 AA 1001	24-Jan-22 (in house check)	in house check: Jan-23
Calibrator Box V2.1	SE UMS 005 AA 1002	24-Jan-22 (in house check)	in house check: Jan-23

Calibrated by:	Name Dominique Steffen	Function Laboratory Technician	Signature 
Approved by:	Sven Kühn	Technical Manager	

Issued: August 17, 2022

This calibration certificate shall not be reproduced except in full without written approval of the laboratory.

7 Calibration certificate of Data Acquisition Unit (DAE)

**Calibration Laboratory of
Schmid & Partner
Engineering AG**
Zeughausstrasse 43, 8004 Zurich, Switzerland



S Schweizerischer Kalibrierdienst
S Service suisse d'étalonnage
C Servizio svizzero di taratura
S Swiss Calibration Service

Accredited by the Swiss Accreditation Service (SAS)
The Swiss Accreditation Service is one of the signatories to the EA
Multilateral Agreement for the recognition of calibration certificates

Accreditation No.: SCS 0108

Client **CTC advanced GmbH**

Certificate No: DAE3-477_May22

CALIBRATION CERTIFICATE

Object: DAE3 - SD 000 D03 AA - SN: 477

Calibration procedure(s): QA CAL-06.v30
Calibration procedure for the data acquisition electronics (DAE)

Calibration date: May 16, 2022

This calibration certificate documents the traceability to national standards, which realize the physical units of measurements (SI).
The measurements and the uncertainties with confidence probability are given on the following pages and are part of the certificate

All calibrations have been conducted in the closed laboratory facility: environment temperature (22 ± 3)°C and humidity < 70%.

Calibration Equipment used (M&TE critical for calibration)

Primary Standards	ID #	Cal Date (Certificate No.)	Scheduled Calibration
Keithley Multimeter Type 2001	SN: 0810278	31-Aug-21 (No:31368)	Aug-22
Secondary Standards	ID #	Check Date (in house)	Scheduled Check
Auto DAE Calibration Unit	SE UWS 053 AA 1001	24-Jan-22 (in house check)	In house check: Jan-23
Calibrator Box V2.1	SE UMS 006 AA 1002	24-Jan-22 (in house check)	In house check: Jan-23

Calibrated by:	Name Adrian Gehring	Function Laboratory Technician	Signature 
Approved by:	Sven Kühn	Technical Manager	

Issued: May 16, 2022

This calibration certificate shall not be reproduced except in full without written approval of the laboratory.

8 Certificate of “SAM Twin Phantom V4.0 and V5.0”

Schmid & Partner Engineering AG

s p e a g

Zeughausstrasse 43, 8004 Zurich, Switzerland
Phone +41 44 245 9700, Fax +41 44 245 9779
info@speag.com, http://www.speag.com

Certificate of Conformity / First Article Inspection

Item	SAM Twin Phantom V4.0 and V5.0
Type No	QD 000 P40 C
Series No	TP-1150 and higher
Manufacturer	Untersee Composites Knebelstrasse 8, CH-8268 Mannenbach, Switzerland

Tests

Complete tests were made on the pre-series QD 000 P40 A, # TP-1001, on the series first article QD 000 P40 B # TP-1006. Certain parameters are retested on series items.

Test	Requirement	Details	Units tested
Dimensions	Compliant with the geometry according to the CAD model.	IT'IS CAD File *	First article, Samples
Material thickness of shell	2mm +/- 0.2mm in flat section, other locations: +/- 0.2mm with respect to CAD file	in flat section, in the cheek area	First article, Samples, TP-1314 ff.
Material thickness at ERP	6mm +/- 0.2mm at ERP		First article, All items
Material parameters	rel. permittivity 2 – 5, loss tangent ≤ 0.05, at f ≤ 6 GHz	rel. permittivity 3.5 +/- 0.5 loss tangent ≤ 0.05	Material samples
Material resistivity	Compatibility with tissue simulating liquids .	Compatible with SPEAG liquids. **	Phantoms, Material sample
Sagging	Sagging of the flat section in tolerance when filled with tissue simulating liquid.	< 1% for filling height up to 155 mm	Prototypes, Sample testing

* The IT'IS CAD file is derived from [2] and is also within the tolerance requirements of the shapes of the other documents.

** Note: Compatibility restrictions apply certain liquid components mentioned in the standard, containing e.g. DGBE, DGMHE or Triton X-100. Observe technical note on material compatibility.

Standards

- [1] OET Bulletin 65, Supplement C, "Evaluating Compliance with FCC Guidelines for Human Exposure to Radiofrequency Electromagnetic Fields", Edition 01-01
- [2] IEEE 1528-2003, "Recommended Practice for Determining the Peak Spatial-Average Specific Absorption Rate (SAR) in the Human Head from Wireless Communications Devices: Measurement Techniques, December 2003
- [3] IEC 62209-1 ed1.0, "Human exposure to radio frequency fields from hand-held and body-mounted wireless communication devices - Human models, instrumentation, and procedures - Part 1: Procedure to determine the specific absorption rate (SAR) for hand-held devices used in close proximity to the ear (frequency range of 300 MHz to 3 GHz)", 2005-02-18
- [4] IEC 62209-2 ed1.0, "Human exposure to radio frequency fields from hand-held and body-mounted wireless communication devices - Human models, instrumentation, and procedures - Part 2: Procedure to determine the specific absorption rate (SAR) for wireless communication devices used in close proximity to the human body (frequency range of 30 MHz to 6 GHz)", 2010-03-30

Conformity

Based on the sample tests above, we certify that this item is in compliance with the uncertainty requirements of **hand-held** SAR measurements and system performance checks as specified in [1 – 4] and further standards.

Date 25.07.2011

Signature / Stamp

s p e a g
Schmid & Partner Engineering AG
Zeughausstrasse 43, 8004 Zurich, Switzerland
Phone +41 44 245 9700, Fax +41 44 245 9779
info@speag.com, http://www.speag.com

9 Application Note System Performance Check

9.1 Purpose of system performance check

The system performance check verifies that the system operates within its specifications. System and operator errors can be detected and corrected. It is recommended that the system performance check is performed prior to any usage of the system in order to guarantee reproducible results.

The measurement of the Specific Absorption Rate (SAR) is a complicated task and the result depends on the proper functioning of many components and the correct settings of many parameters. Faulty results due to drift, failures or incorrect parameters might not be recognized, since they often look similar in distribution to the correct ones. The Dosimetric Assessment System DASY incorporates a system performance check procedure to test the proper functioning of the system. The system performance check uses normal SAR measurements in a simplified setup (the flat section of the SAM Twin Phantom) with a well characterized source (a matched dipole at a specified distance). This setup was selected to give a high sensitivity to all parameters that might fail or vary over time (e.g., probe, liquid parameters, and software settings) and a low sensitivity to external effects inherent in the system (e.g., positioning uncertainty of the device holder). The system performance check does not replace the calibration of the components. The accuracy of the system performance check is not sufficient for calibration purposes. It is possible to calculate the field quite accurately in this simple setup; however, due to the open field situation some factors (e.g., laboratory reflections) cannot be accounted for. Calibrations in the flat phantom are possible with transfer calibration methods, using either temperature probes or calibrated E-field probes. The system performance check also does not test the system performance for arbitrary field situations encountered during real measurements of mobile phones. These checks are performed at SPEAG by testing the components under various conditions (e.g., spherical isotropy measurements in liquid, linearity measurements, temperature variations, etc.), the results of which are used for an error estimation of the system. The system performance check will indicate situations where the system uncertainty is exceeded due to drift or failure.

9.2 System Performance check procedure

Preparation

The conductivity should be measured before the validation and the measured liquid parameters must be entered in the software. If the measured values differ from targeted values in the dipole document, the liquid composition should be adjusted. If the validation is performed with slightly different (measured) liquid parameters, the expected SAR will also be different. See the application note about SAR sensitivities for an estimate of possible SAR deviations. Note that the liquid parameters are temperature dependent with approximately – 0.5% decrease in permittivity and + 1% increase in conductivity for a temperature decrease of 1° C. The dipole must be placed beneath the flat phantom section of the Generic Twin Phantom with the correct distance holder in place. The distance holder should touch the phantom surface with a light pressure at the reference marking (little hole) and be oriented parallel to the long side of the phantom. Accurate positioning is not necessary, since the system will search for the peak SAR location, except that the dipole arms should be parallel to the surface. The device holder for mobile phones can be left in place but should be rotated away from the dipole. The forward power into the dipole at the dipole SMA connector should be determined as accurately as possible. The actual dipole input power level can be between 20mW and several watts. The result can later be normalized to any power level. It is strongly recommended to note the actually used power level in the „comment“-window of the measurement file; otherwise you loose this crucial information for later reference.

System Performance Check

The DASY installation includes predefined files with recommended procedures for measurements and validation. They are read-only document files and destined as fully defined but unmeasured masks, so you must save the finished validation under a different name. The validation document requires the Generic Twin Phantom, so this phantom must be properly installed in your system. (You can create your own measurement procedures by opening a new document or editing an existing document file). Before you start the validation, you just have to tell the system with which components (probe, medium, and device) you are performing the validation; the system will take care of all parameters. After the validation, which will take about 20 minutes, the results of each task are displayed in the document window. Selecting all measured tasks and opening the predefined "validation" graphic format displays all necessary information for validation. A description of the different measurement tasks in the predefined document is given below, together with the information that can be deduced from their results:

- The „reference“ and „drift“ measurements are located at the beginning and end of the batch process. They measure the field drift at one single point in the liquid over the complete procedure. The indicated drift is mainly the variation of the amplifier output power. If it is too high (above ± 0.1 dB) the validation should be repeated; some amplifiers have very high drift during warm-up. A stable amplifier gives drift results in the DASY system below ± 0.02 dB.
- The „area scan“ measures the SAR above the dipole on a parallel plane to the surface. It is used to locate the approximate location of the peak SAR with 2D spline interpolation. The proposed scan uses large grid spacing for faster measurement; due to the symmetric field the peak detection is reliable. If a finer graphic is desired, the grid spacing can be reduced. Grid spacing and orientation have no influence on the SAR result.
- The zoom scan job measures the field in a volume around the peak SAR value assessed in the previous „area“ scan (for more information see the application note on SAR evaluation).

If the validation measurements give reasonable results, the peak 1g and 10g spatial SAR values averaged between the two cubes and normalized to 1W dipole input power give the reference data for comparisons. The next section analyzes the expected uncertainties of these values. Section 6 describes some additional checks for further information or troubleshooting.

9.3 Uncertainty Budget

Please note that in the following Tables, the tolerance of the following uncertainty components depends on the actual equipment and setup at the user location and need to be either assessed or verified on-site by the end user of the DASY system:

- RF ambient conditions
- Dipole Axis to Liquid Distance
- Input power and SAR drift measurement
- Liquid permittivity - measurement uncertainty
- Liquid conductivity - measurement uncertainty

Note: All errors are given in percent of SAR, so 0.1 dB corresponds to 2.3%. The field error would be half of that. The liquid parameter assessment give the targeted values from the dipole document. All errors are given in percent of SAR, so 0.1dB corresponds to 2.3%. The field error would be half of that.

System validation DASY 5/8 and cDASY6

In the tables below, the system validation uncertainty with respect to the analytically assessed SAR value of a dipole source as given in the IEC/IEEE 62209-1528 standard is given. This uncertainty is smaller than the expected uncertainty for mobile phone measurements due to the simplified setup and the symmetric field distribution.

DASY 5 - Uncertainty Budget for System Validation for the 0.3 - 6 GHz range								
Source of uncertainty	Uncertainty Value	Probability Distribution	Divisor	c_i	c_i	Standard Uncertainty		v_i^2 or v_{eff}
				(1g)	(10g)	± %, (1g)	± %, (10g)	
Measurement System								
Probe calibration	± 6.6 %	Normal	1	1	1	± 6.6 %	± 6.6 %	∞
Axial isotropy	± 4.7 %	Rectangular	√ 3	1	1	± 2.7 %	± 2.7 %	∞
Hemispherical isotropy	± 9.6 %	Rectangular	√ 3	0	0	± 0.0 %	± 0.0 %	∞
Boundary effects	± 1.0 %	Rectangular	√ 3	1	1	± 0.6 %	± 0.6 %	∞
Probe linearity	± 4.7 %	Rectangular	√ 3	1	1	± 2.7 %	± 2.7 %	∞
System detection limits	± 1.0 %	Rectangular	√ 3	1	1	± 0.6 %	± 0.6 %	∞
Readout electronics	± 0.3 %	Normal	1	1	1	± 0.3 %	± 0.3 %	∞
Response time	± 0.0 %	Rectangular	√ 3	1	1	± 0.0 %	± 0.0 %	∞
Integration time	± 0.0 %	Rectangular	√ 3	1	1	± 0.0 %	± 0.0 %	∞
RF ambient conditions	± 1.0 %	Rectangular	√ 3	1	1	± 0.6 %	± 0.6 %	∞
Probe positioner	± 0.8 %	Rectangular	√ 3	1	1	± 0.5 %	± 0.5 %	∞
Probe positioning	± 6.7 %	Rectangular	√ 3	1	1	± 3.9 %	± 3.9 %	∞
Max. SAR evaluation	± 2.0 %	Rectangular	√ 3	1	1	± 1.2 %	± 1.2 %	∞
Dipole Related								
Dev. of exp. dipole	± 5.5 %	Rectangular	√ 3	1	1	± 3.2 %	± 3.2 %	∞
Dipole Axis to Liquid Dist.	± 2.0 %	Rectangular	√ 3	1	1	± 1.2 %	± 1.2 %	∞
Input power & SAR drift	± 3.4 %	Rectangular	√ 3	1	1	± 2.0 %	± 2.0 %	∞
Phantom and Set-up								
Phantom uncertainty	± 4.0 %	Rectangular	√ 3	1	1	± 2.3 %	± 2.3 %	∞
SAR correction	± 1.9 %	Rectangular	√ 3	1	0.84	± 1.1 %	± 0.9 %	∞
Liquid conductivity (meas.)	± 5.0 %	Normal	1	0.78	0.71	± 3.9 %	± 3.6 %	∞
Liquid permittivity (meas.)	± 5.0 %	Normal	1	0.26	0.26	± 1.3 %	± 1.3 %	∞
Temp. unc. - Conductivity	± 1.7 %	Rectangular	√ 3	0.78	0.71	± 0.8 %	± 0.7 %	∞
Temp. unc. - Permittivity	± 0.3 %	Rectangular	√ 3	0.23	0.26	± 0.0 %	± 0.0 %	∞
Combined Uncertainty						± 10.7 %	± 10.6 %	330
Expanded Std. Uncertainty						± 21.4 %	± 21.1 %	

Table 1: Measurement uncertainties of the System Validation with DASY5 (0.3-6GHz).

The RF ambient noise uncertainty has been reduced to ±1.0, considering input power levels are ≥ 250mW.

cDASY 6 - Uncertainty Budget for System Validation for the 0.3 - 6 GHz range								
Source of uncertainty	Uncertainty Value	Probability Distribution	Divisor	c _i	c _i	Standard Uncertainty		v _i ² or
				(1g)	(10g)	± %, (1g)	± %, (10g)	v _{eff}
Measurement System								
Probe calibration	± 6.6 %	Normal	1	1	1	± 6.6 %	± 6.6 %	∞
Axial isotropy	± 4.7 %	Rectangular	√ 3	1	1	± 2.7 %	± 2.7 %	∞
Hemispherical isotropy	± 9.6 %	Rectangular	√ 3	0	0	± 0.0 %	± 0.0 %	∞
Boundary effects	± 1.0 %	Rectangular	√ 3	1	1	± 0.6 %	± 0.6 %	∞
Probe linearity	± 4.7 %	Rectangular	√ 3	1	1	± 2.7 %	± 2.7 %	∞
System detection limits	± 1.0 %	Rectangular	√ 3	1	1	± 0.6 %	± 0.6 %	∞
Modulation Response	± 0.0 %	Rectangular	√ 3	1	1	± 0.0 %	± 0.0 %	∞
Readout electronics	± 0.3 %	Normal	1	1	1	± 0.3 %	± 0.3 %	∞
Response time	± 0.0 %	Rectangular	√ 3	1	1	± 0.0 %	± 0.0 %	∞
Integration time	± 0.0 %	Rectangular	√ 3	1	1	± 0.0 %	± 0.0 %	∞
RF Ambient Noise	± 1.0 %	Rectangular	√ 3	1	1	± 0.6 %	± 0.6 %	∞
RF Ambient Reflections	± 1.0 %	Rectangular	√ 3	1	1	± 0.6 %	± 0.6 %	∞
Probe positioner	± 0.04 %	Rectangular	√ 3	1	1	± 0.0 %	± 0.0 %	∞
Probe positioning	± 0.8 %	Rectangular	√ 3	1	1	± 0.5 %	± 0.5 %	∞
Max. SAR evaluation	± 0.0 %	Rectangular	√ 3	1	1	± 0.0 %	± 0.0 %	∞
Dipole Related								
Dev. of exp. dipole	± 5.5 %	Rectangular	√ 3	1	1	± 3.2 %	± 3.2 %	∞
Dipole Axis to Liquid Dist.	± 2.0 %	Rectangular	√ 3	1	1	± 1.2 %	± 1.2 %	∞
Input power & SAR drift	± 3.4 %	Rectangular	√ 3	1	1	± 2.0 %	± 2.0 %	∞
Phantom and Set-up								
Phantom uncertainty	± 4.0 %	Rectangular	√ 3	1	1	± 2.3 %	± 2.3 %	∞
SAR correction	± 1.9 %	Normal	1	1	0.84	± 1.9 %	± 1.6 %	∞
Liquid conductivity (meas.) ^{DAK}	± 2.5 %	Normal	1	0.78	0.71	± 2.0 %	± 1.8 %	∞
Liquid permittivity (meas.) ^{DAK}	± 2.5 %	Normal	1	0.23	0.26	± 0.6 %	± 0.7 %	∞
Temp. unc. - Conductivity ^{BB}	± 3.4 %	Rectangular	√ 3	0.78	0.71	± 1.5 %	± 1.4 %	∞
Temp. unc. - Permittivity ^{BB}	± 0.4 %	Rectangular	√ 3	0.23	0.26	± 0.1 %	± 0.1 %	∞
Combined Uncertainty						± 9.5 %	± 9.4 %	
Expanded Std. Uncertainty						± 19.0 %	± 18.8 %	

Table 2: Uncertainties of a system validation with cDASY6 (0.3-6GHz).

The RF ambient noise uncertainty has been reduced to ±1.0, considering input power levels are ≥ 250mW.

Footnote details:

^{BB} if SPEAG's broad-band liquids (BBL) are used that have low temperature coefficients;

^{DAK} if SPEAG's high precision dielectric probe kit (DAK) is applied.

Uncertainty Budget for System Validation (Frequency band: 300MHz - 6GHz range) with DASY8 System								
Symbol	Error Description	Uncertainty Value	Probability Distribution	Divisor	c _i	c _i	Standard Uncertainty	
					(1g)	(10g)	± %, (1g)	± %, (10g)
Measurement System Errors								
CF	Probe Calibration Repeat.	± 13.1 %	Normal	2	1	1	± 9.3 %	± 9.3 %
CFdrift	Probe Calibration Drift	± 1.7 %	Rectangular	√ 3	1	1	± 1.0 %	± 1.0 %
LIN	Probe linearity	± 4.7 %	Rectangular	√ 3	0	0	± 0.0 %	± 0.0 %
BBS	Broadband Signal	± 0.0 %	Rectangular	√ 3	0	0	± 0.0 %	± 0.0 %
ISO	Probe Isotropy (axial)	± 4.7 %	Rectangular	√ 3	0	0	± 0.0 %	± 0.0 %
DAE	Data Acquisition	± 0.3 %	Normal	1	0	0	± 0.0 %	± 0.0 %
AMB	RF Ambient	± 0.6 %	Normal	1	0	0	± 0.0 %	± 0.0 %
Δ _{sys}	Probe Positioning	± 0.5 %	Normal	1	0.29	0.29	± 0.1 %	± 0.1 %
DAT	Data Processing	± 0.0 %	Normal	1	1	1	± 0.0 %	± 0.0 %
Phantom and Device Errors								
LIQ(σ)	Conductivity (meas.) ^{DAK}	± 2.5 %	Normal	1	0.78	0.71	± 2.0 %	± 1.8 %
LIQ(Tσ)	Conductivity (temp.) ^{BB}	± 3.4 %	Rectangular	√ 3	0.78	0.71	± 1.5 %	± 1.4 %
EPS	Phantom Permittivity	± 14.0 %	Rectangular	√ 3	0	0	± 0.0 %	± 0.0 %
DIS	Distance DUT - TSL	± 1.3 %	Normal	1	2	2	± 2.6 %	± 2.6 %
MOD	DUT Modulationm	± 0.0 %	Rectangular	√ 3	1	1	± 0.0 %	± 0.0 %
TAS	Time-average SAR	± 0.0 %	Rectangular	√ 3	1	1	± 0.0 %	± 0.0 %
VAL	Validation antenna	± 3.2 %	Normal	1	1	1	± 3.2 %	± 3.2 %
P _{in}	Accepted power	± 2.0 %	Normal	1	1	1	± 2.0 %	± 2.0 %
Correction to the SAR results								
C(ε, σ)	Deviation to Target	± 1.9 %	Normal	1	1	0.84	± 1.9 %	± 1.6 %
u(ΔSAR)	Combined Uncertainty						± 10.8 %	± 10.7 %
U	Expanded Uncertainty						± 21.7 %	± 21.5 %

Table 6.2.1: Uncertainty of a system validation with DASY8 system (300MHz - 6 GHz).

The RF ambient noise uncertainty has been reduced to ± 1.0, considering input power levels are ≥ 250mW. All listed error components have *veff* equal to ∞.

Footnote details:

^{BB} if SPEAG's broad-band liquids (BBL) are used that have low temperature coefficients;

^{DAK} if SPEAG's high precision dielectric probe kit (DAK) is applied.

9.4 Power set-up for validation

The uncertainty of the dipole input power is a significant contribution to the absolute uncertainty and the expected deviation in interlaboratory comparisons. The values in Section 2 for a typical and a sophisticated setup are just average values. Refer to the manual of the power meter and the detector head for the evaluation of the uncertainty in your system. The uncertainty also depends on the source matching and the general setup. Below follows the description of a recommended setup and procedures to increase the accuracy of the power reading:

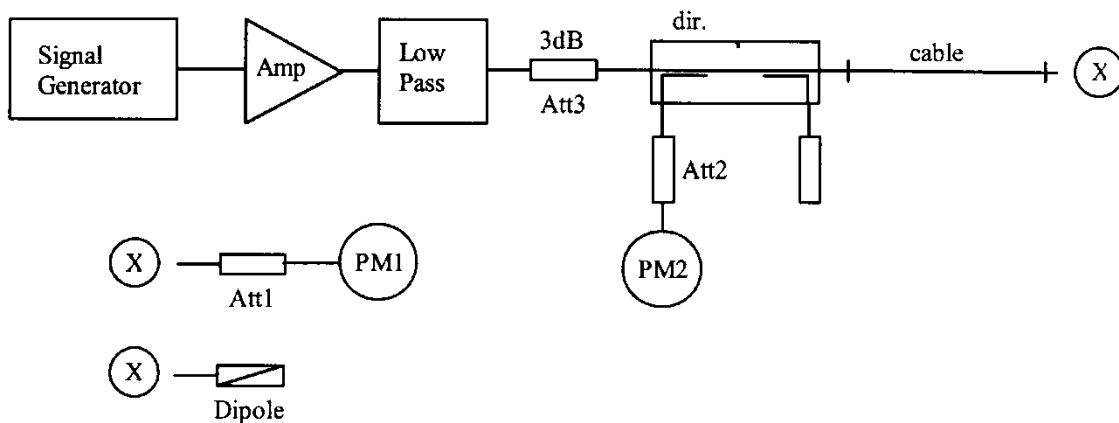

The figure shows the recommended setup. The PM1 (incl. Att1) measures the forward power at the location of the validation dipole connector. The signal generator is adjusted for the desired forward power at the dipole connector and the power meter PM2 is read at that level. After connecting the cable to the dipole, the signal generator is readjusted for the same reading at power meter PM2. If the signal generator does not allow a setting in 0.01dB steps, the remaining difference at PM2 must be noted and considered in the normalization of the validation results. The requirements for the components are:

- The signal generator and amplifier should be stable (after warm-up). The forward power to the dipole should be above 10mW to avoid the influence of measurement noise. If the signal generator can deliver 15dBm or more, an amplifier is not necessary. Some high power amplifiers should not be operated at a level far below their maximum output power level (e.g. a 100W power amplifier operated at 250mW output can be quite noisy). An attenuator between the signal generator and amplifier is recommended to protect the amplifier input.
- The low pass filter after the amplifier reduces the effect of harmonics and noise from the amplifier. For most amplifiers in normal operation the filter is not necessary.
- The attenuator after the amplifier improves the source matching and the accuracy of the power head. (See power meter manual.) It can also be used also to make the amplifier operate at its optimal output level for noise and stability. In a setup without directional coupler, this attenuator should be at least 10dB.
- The directional coupler (recommended ³ 20dB) is used to monitor the forward power and adjust the signal generator output for constant forward power. A medium quality coupler is sufficient because the loads (dipole and power head) are well matched. (If the setup is used for reflective loads, a high quality coupler with respect to directivity and output matching is necessary to avoid additional errors.)
- The power meter PM2 should have a low drift and a resolution of 0.01dBm, but otherwise its accuracy has no impact on the power setting. Calibration is not required.
- The cable between the coupler and dipole must be of high quality, without large attenuation and phase changes when it is moved. Otherwise, the power meter head PM1 should be brought to the location of the dipole for measuring.
- The power meter PM1 and attenuator Att1 must be high quality components. They should be calibrated, preferably together. The attenuator (³10dB) improves the accuracy of the power reading. (Some higher power heads come with a built-in calibrated attenuator.) The exact attenuation of the attenuator at the frequency used must be known; many attenuators are up to 0.2dB off from the specified value.

- Use the same power level for the power setup with power meter PM1 as for the actual measurement to avoid linearity and range switching errors in the power meter PM2. If the validation is performed at various power levels, do the power setting procedure at each level.
- The dipole must be connected directly to the cable at location “X”. If the power meter has a different connector system, use high quality couplers. Preferably, use the couplers at the attenuator Att1 and calibrate the attenuator with the coupler.
- Always remember: We are measuring power, so 1% is equivalent to 0.04dB.

9.5 Laboratory reflection

In near-field situations, the absorption is predominantly caused by induction effects from the magnetic near-field. The absorption from reflected fields in the laboratory is negligible. On the other hand, the magnetic field around the dipole depends on the currents and therefore on the feed point impedance. The feed point impedance of the dipole is mainly determined from the proximity of the absorbing phantom, but reflections in the laboratory can change the impedance slightly. A 1% increase in the real part of the feed point impedance will produce approximately a 1% decrease in the SAR for the same forward power. The possible influence of laboratory reflections should be investigated during installation. The validation setup is suitable for this check, since the validation is sensitive to laboratory reflections. The same tests can be performed with a mobile phone, but most phones are less sensitive to reflections due to the shorter distance to the phantom. The fastest way to check for reflection effects is to position the probe in the phantom above the feed point and start a continuous field measurement in the DASY multi-meter window. Placing absorbers in front of possible reflectors (e.g. on the ground near the dipole or in front of a metallic robot socket) will reveal their influence immediately. A 10dB absorber (e.g. ferrite tiles or flat absorber mats) is probably sufficient, as the influence of the reflections is small anyway. If you place the absorber too near the dipole, the absorber itself will interact with the reactive near-field. Instead of measuring the SAR, it is also possible to monitor the dipole impedance with a network analyzer for reflection effects. The network analyzer must be calibrated at the SMA connector and the electrical delay (two times the forward delay in the dipole document) must be set in the NWA for comparisons with the reflection data in the dipole document. If the absorber has a significant influence on the results, the absorber should be left in place for validation or measurements. The reference data in the dipole document are produced in a low reflection environment.

9.6 Additional system checks

While the validation gives a good check of the DASY system components, it does not include all parameters necessary for real phone measurements (e.g. device modulation or device positioning). For system validation (repeatability) or comparisons between laboratories a reference device can be useful. This can be any mobile phone with a stable output power (preferably a device whose output power can be set through the keyboard). For comparisons, the same device should be sent around, since the SAR variations between samples can be large. Several measurement possibilities in the DASY software allow additional tests of the performance of the DASY system and components. These tests can be useful to localize component failures:

- The validation can be performed at different power levels to check the noise level or the correct compensation of the diode compression in the probe.
- If a pulsed signal with high peak power levels is fed to the dipole, the performance of the diode compression compensation can be tested. The correct crest factor parameter in the DASY software must be set (see manual). The system should give the same SAR output for the same averaged input power.
- The probe isotropy can be checked with a 1D-probe rotation scan above the feed point. The automatic probe alignment procedure must be passed through for accurate probe rotation movements (optional DASY feature with a robot-mounted light beam unit). Otherwise the probe tip might move on a small circle during rotation, producing some additional isotropy errors in gradient fields.