

TEST REPORT

Test Report No.: 1-3010/16-01-10



Testing Laboratory

CTC advanced GmbH

Untertürkheimer Straße 6 – 10
66117 Saarbrücken/Germany
Phone: + 49 681 5 98 - 0
Fax: + 49 681 5 98 - 9075
Internet: <http://www.ctcadvanced.com>
e-mail: mail@ctcadvanced.com

Accredited Test Laboratory:

The testing laboratory (FCC part 15 D) is accredited according to DIN EN ISO/IEC 17025 (2005) by the Deutsche Akkreditierungsstelle GmbH (DAkkS). The accreditation is valid for the scope of testing procedures as stated in the accreditation certificate with the registration number: D-PL-12076-01-01

Applicant

Riedel Communications GmbH & Co. KG

Uellendahler Strasse 353.
42109 Wuppertal, Germany
Phone: +49 202 292 90
Fax: +49 202 292 9999
Contact: Michael Fischer,
Email: michael.fischer@riedel.net
Phone: +43 1 523 66 85 - 49

Manufacturer

Riedel Communications GmbH & Co. KG

Uellendahler Strasse 353.
42109 Wuppertal
Germany

Test Standard/s

FCC Part 15, subpart D: 2016

Isochronous UPCS Device 1920 – 1930 MHz

Industry Canada RSS-213, Issue 3: 2015

2 GHz Licence-exempt Personal Communication Service Devices (LE-PCS)

Test Item

Kind of product:	Wireless Active Antenna
Product name:	BL-ANT-1010-19
FCC ID:	YFJANT101019
IC:	8706A-ANT101019
S/N serial number:	Radiated: 3301002170102, 3301002170096 Conducted: 3301002170256
HW hardware status:	C00
SW software status:	V29
Frequency [MHz]:	1920 -1930
Type of Modulation:	Digital (Gaussian Frequency Shift Keying)
Number of channels:	5 RF Channels, 5x12 = 60 TDMA Duplex Channels
Antenna:	2 antennas
Power Supply:	AC/DC power supply, 12.0 V
Temperature Range:	-20°C to 50°C

Test Report authorised:

Test performed:

2017-04-07 Lenjoint, Marco
Lab Manager
Radio Communications & EMC

2017-04-07 Wolf, Joachim
Business Development Manager

1 Table of contents

1	Table of contents.....	2
2	General information	3
2.1	Notes and disclaimer	3
2.2	Application details	3
3	Test standard/s:.....	3
4	Test Environment	4
5	Test Item.....	4
6	RSP100 Test report Cover Sheet/Performance Test Data.....	5
7	Summary of Measurement Results	6
8	Test Set-up.....	7
8.1	Frequency Measurements	7
8.2	Timing Measurements	7
8.3	Conducted Emission Test	7
8.4	Radiated Emission Test.....	8
8.5	Power Line Conducted Emissions Test.....	10
8.6	Monitoring Tests.....	11
8.7	Radiated Output Power Test	11
9	Detailed Test Results	12
9.1	Power Line Conducted Emissions	12
9.2	Coordination with fixed microwave.....	15
9.3	Digital Modulation Techniques	15
9.4	Labeling Requirements.....	15
9.5	Antenna Requirements	16
9.6	Channel Frequencies	16
9.7	Automatic Discontinuation of Transmission.....	17
9.8	Peak Power Output	18
9.9	Emission Bandwidth B	22
9.10	Power Spectral Density.....	25
9.11	In-Band Unwanted Emissions, Conducted	28
9.12	Out-of-Band Emissions, Conducted	31
9.13	Carrier Frequency Stability.....	35
9.14	Frame Repetition Stability	36
9.15	Frame Period and Jitter.....	36
9.16	Monitoring Threshold, Least Interfered Channel	38
9.17	Threshold Monitoring Bandwidth	40
9.18	Reaction Time and Monitoring Interval	41
9.19	Time and Spectrum Window Access Procedure.....	43
9.20	Acknowledgments and Transmission duration.....	46
9.21	Dual Access Criteria Check.....	47
9.22	Alternative monitoring interval.....	48
9.23	Spurious Emissions (Radiated).....	48
9.24	Receiver Spurious Emissions	51
10	Test equipment and ancillaries used for tests.....	54
11	Observations	56
	Annex D: Document History.....	57
	Annex E: Further Information.....	58
	Annex F: Safety exposure levels	59
	Annex G: Accreditation Certificate.....	60

2 General information

2.1 Notes and disclaimer

The test results of this test report relate exclusively to the test item specified in this test report. CTC advanced GmbH does not assume responsibility for any conclusions and generalisations drawn from the test results with regard to other specimens or samples of the type of the equipment represented by the test item.

The test report may only be reproduced or published in full. Reproduction or publication of extracts from the report requires the prior written approval of CTC advanced GmbH.

The testing service provided by CTC advanced GmbH has been rendered under the current "General Terms and Conditions for CTC advanced GmbH".

CTC advanced GmbH will not be liable for any loss or damage resulting from false, inaccurate, inappropriate or incomplete product information provided by the customer.

Under no circumstances does the CTC advanced GmbH test report include any endorsement or warranty regarding the functionality, quality or performance of any other product or service provided.

Under no circumstances does the CTC advanced GmbH test report include or imply any product or service warranties from CTC advanced GmbH, including, without limitation, any implied warranties of merchantability, fitness for purpose, or non-infringement, all of which are expressly disclaimed by CTC advanced GmbH.

All rights and remedies regarding vendor's products and services for which CTC advanced GmbH has prepared this test report shall be provided by the party offering such products or services and not by CTC advanced GmbH.

In no case this test report can be considered as a Letter of Approval.

This test report is electronically signed and valid without handwriting signature. For verification of the electronical signatures, the public keys can be requested at the testing laboratory.

2.2 Application details

Date of receipt of order:	2016-12-13
Date of receipt of test item:	2017-03-09
Start of test:	2017-03-16
End of test:	2017-04-06
Person(s) present during the test:	/

3 Test standard/s:

Test Standard	Version	Test Standard Description
FCC Part 15, subpart D	2016-06	Isochronous UPCS Device 1920 – 1930 MHz
Industry Canada RSS-213, Issue 3	2015-03	2 GHz Licence-exempt Personal Communication Service Devices (LE-PCS)
ANSI C63.17	2013-08	American National Standard for Methods of Measurement of the Electromagnetic and Operational Compatibility of Unlicensed Personal Communication Services (UPCS) Devices
ANSI C63.4	2014-06	American National Standard for Methods of Measurement of Radio-Noise Emissions from Low-Voltage Electrical and Electronic Equipment in the Range of 9 kHz to 40 GHz

4 Test Environment

Temperature: + 22 °C during room temperature tests
 + 50 °C during high temperature test
 - 20 °C during low temperature test

Relative humidity content: 38 %

Air pressure: not relevant for this kind of testing

Power supply: AC/DC power supply, 12.0 V

5 Test Item

Kind of product	: Wireless Active Antenna
Type identification	: BL-ANT-1010-19
S/N serial number	: Radiated: 3301002170102, 3301002170096 Conducted: 3301002170256
HW hardware status	: C00
SW software status	: V29
Power Supply	: AC/DC power supply, 12.0 V
Temperature Range	: -20°C to 50°C

6 RSP100 Test report Cover Sheet/Performance Test Data

Test Report Number	:	1-3010/16-01-10
Equipment Model Number (HVIN)	:	BL-ANT-1010-19
PMN		BL-ANT-1010-19
Certification Number	:	8706A-ANT101019
Manufacturer	:	Riedel Communications GmbH & Co. KG
Tested to Radio Standards Specification (RSS) No.	:	RSS-213 Issue 2
Open Area Test Site Industry Canada Number	:	IC 3462C-1
Frequency Range (or fixed frequency)	:	1921.536 – 1928.448 MHz
RF Power [W] (max)	:	Conducted: 15.3 dBm, 34.2 mW Rad. EIRP: 22.7 dBm, 186.2 mW
Occupied Bandwidth (99% BW)	:	1.19MHz
Type of Modulation	:	Digital (Gaussian Frequency Shift Keying)
Emission Designator (TRC-43)	:	1M19FXD
Antenna information	:	2 antennas, no ext. connector
Transmitter Spurious (worst case)	:	-45.9 dBm
Receiver Spurious (worst case)	:	-71.0 dBm

ATTESTATION:

DECLARATION OF COMPLIANCE: I declare that the testing was performed or supervised by me; that the test measurements were made in accordance with the above-mentioned Industry Canada standard(s); and that the equipment identified in this application has been subjected to all the applicable test conditions specified in the Industry Canada standards and all of the requirements of the standard have been met.

Signature:

Date: 2017-04-07

Test engineer: Joachim Wolf

CTC advanced GmbH
 Untertürkheimerstr. 6-10
 66117 Saarbrücken
 Germany

7 Summary of Measurement Results

<input checked="" type="checkbox"/>	No deviations from the technical specifications were ascertained
<input type="checkbox"/>	There were deviations from the technical specifications ascertained

CFR 47 Part 15 UPCS

Name of test	FCC CFR 47 Paragraph	IC RSS-213 Paragraph	Verdict
Coordination with fixed microwave	15.307(b)	N/A	Complies
Digital Modulation Techniques	15.319(b)	6.1	Complies
Labeling requirements	15.19(a)(3)	RSS-GEN 5.2	Complies
Antenna requirements	15.317, 15.203	4.1(e)	Complies
Power Line Conducted Emission	15.107(a), 15.207(a)	6.3 RSS_GEN 7.2.2	Complies
Emission Bandwidth	15.323(a)	6.4	Complies
In-band Emission	15.323(d)	6.7.2	Complies
Out-of-band Emissions	15.323(d)	6.7.1	Complies
Peak Transmit Power	15.319(c)(e), 15.31(e)	6.5	Complies
Power Spectral Density	15.319(d)	4.3.2.1	Complies
Automatic discontinuation of transmission	15.319(f)	4.3.4(a)	Complies
Carrier frequency stability	15.323(f)	6.2	Complies
Frame repetition stability	15.323(e)	4.3.4(c)	Complies
Frame period and jitter	15.323(e)	4.3.4(c)	Complies
Monitoring threshold, Least interfered channel	15.323(c)(2);(5); (9)	4.3.4(b)	Complies
Monitoring of intended transmit window and maximum reaction time	15.323(c)(1)	4.3.4	Complies
Threshold monitoring bandwidth	15.323(c)(7)	4.3.4	N/A
Reaction time and monitoring interval	15.323(c)(1);(5); (7)	4.3.4	Complies
Access criteria test interval	15.323(c)(4);(6)	4.3.4	Complies
Access criteria functional test	15.323(c)(4);(6)	4.3.4	Complies
Acknowledgments	15.323(c)(4)	4.3.4	Complies
Transmission duration	15.323(c)(3)	4.3.4	N/A ¹
Dual access criteria	15.323(c)(10)	4.3.4	N/A ¹
Alternative monitoring interval	15.323(c)(10);(11)	4.3.4	N/A ²
Spurious Emissions (Antenna Conducted)	15.323(d)	6.7.1	Complies ³
Spurious Emissions (Radiated)	15.319(g), 15.109(a), 15.209(a)	4.3.3 RSS-GEN 7.2.3	Complies ⁴
Receiver Spurious Emissions	N/A	6.8	Complies

¹ Only applicable for EUT that can initiate a communication link

² The client declares that the tested equipment does not implement this provision

³ The tested equipment has integrated antennas only

⁴ Only requirement FCC 15.109 for unintentional radiators was tested radiated

8 Test Set-up

8.1 Frequency Measurements

Test Set-up 1:

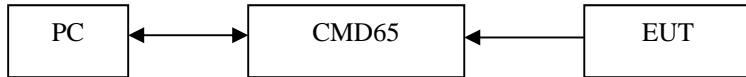

This setup is used for measuring Carrier Frequency Stability at nominal and extreme temperatures.

For long term Frequency Stability, the EUT was in loopback-mode and was controlled with the CMD65, the modulation pattern was set to 01010101....

8.2 Timing Measurements

Test Set-up 2:

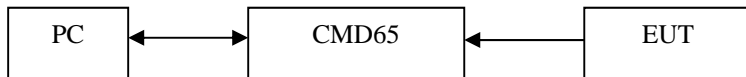

This setup is used for measuring Frame Repetition Stability, Frame Period and Jitter.

8.3 Conducted Emission Test

Test Set-up 3:

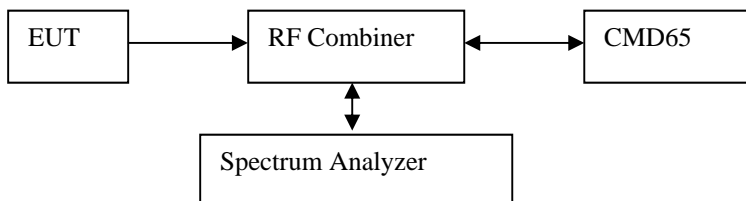

This setup is used for all conducted emission tests.

The EUT was in loopback-mode and was controlled with the CMD65, the modulation pattern was set to Pseudo-Random bit sequence to simulate normal speech.

8.4 Radiated Emission Test

30 MHz – 1GHz:

Test Set-up 4:

- The equipment is set up to simulate normal operation mode as described in the user manual or defined by the manufacturer.
- If the EUT is a tabletop system, a non-conducting table with 0.8 m height is used, which is placed on the ground plane.
- If the EUT is a floor standing device, it is placed on the ground plane with insulation between both.
- Auxiliary equipment and cables are positioned to simulate normal operation conditions as described in ANSI C 63.4.
- The AC power port of the EUT (if available) is connected to a power outlet below the turntable.
- Measurement distance is 10 m or 3 m (see ANSI C 63.4) – see test details.
- EUT is set into operation.

Premeasurement

- The turntable rotates from 0° to 315° using 45° steps.
- The antenna is polarized vertical and horizontal.
- The antenna height changes from 1 m to 3 m.
- At each turntable position, antenna polarization and height the analyzer sweeps three times in peak to find the maximum of all emissions.

Final measurement

- The final measurement is performed for at least six highest peaks according to the requirements of the ANSI C63.4.
- Based on antenna and turntable positions at which the peak values are measured the software maximizes the peaks by changing turntable position $\pm 45^\circ$ and antenna height between 1 and 4 m.
- The final measurement is done with quasi-peak detector (as described in ANSI C 63.4).
- Final levels, frequency, measuring time, bandwidth, antenna height, antenna polarization, turntable angle, correction factor, margin to the limit and limit are recorded. A plot with the graph of the premeasurement with marked maximum final results and the limit is stored.

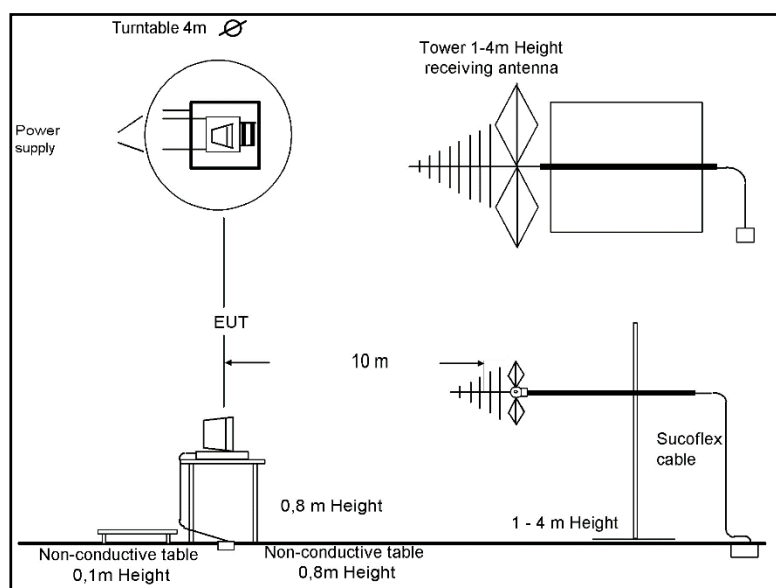

1GHz – 10 GHz:**Test Set-up 5:**

- The Equipment was setup to simulate a typical usage like described in the user manual / or described by manufacturer.
- If the EUT is a tabletop system, a non conducting table with 0,8 m height is used, which is placed on the ground plane.
- If the EUT is a floor standing device, it is placed on the ground plane with insulation between both.
- Auxiliary equipment and cables were positioned to simulate normal operation conditions as described in ANSI C 63.4.
- The AC power port of the EUT (if available) is connected to a power outlet below the turntable.
- The measurement distance is: (see ANSI C 63.4)
 - < 18 GHz = 3 m
 - 18-26 GHz = 1,5 m
 - 26-40 GHz = 0,75 m
- The EUT was set into operation.

Premeasurement

- The turntable rotates continuous from 0° to 360°
- The antenna is polarized vertical and horizontal.
- In accordance to the antenna beam and the size of the EUT the antenna height changes in 30 cm steps, start at 1 meter. If it is not possible to tilt the emissions will be checked with a manually tilted antenna from top side.
- The analyzer scans quickly to find the maximum emissions of the EUT

Final measurement

- The final measurement will be performed with minimum the six highest peaks (depends on emissions and number of measured points below 1 GHz)
- According to the maximum antenna and turntable positions of premeasurement the software maximize the peaks by changing turntable position ($\pm 45^\circ$) and antenna movement between 1 and 4 meter.
- The final measurement will be done with AV (Average / see ANSI C 63.4) detector
- The final levels, frequency, measuring time, bandwidth, antenna height, antenna polarization, turntable angle, correction factor, margin to the limit, and limit will be recorded. Also a plot with the graph of the premeasurement with marked maximum final measurements and the limit will be stored.

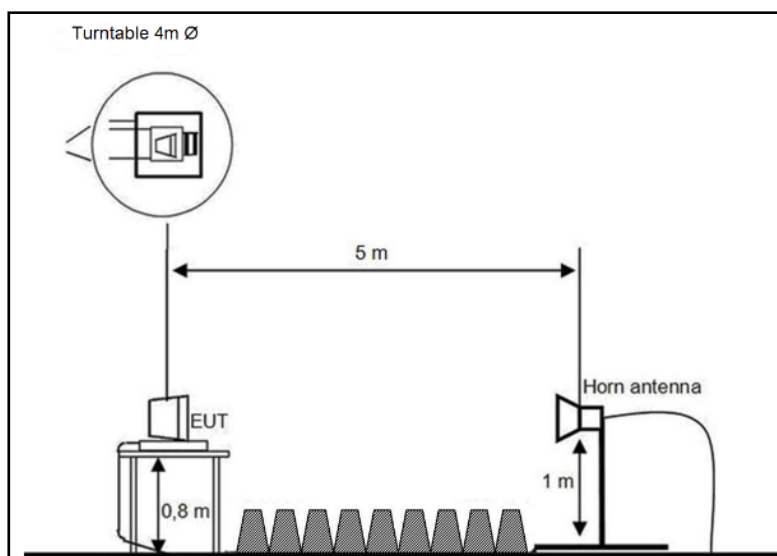

8.5 Power Line Conducted Emissions Test

Test Set-up 6:

According to EMC basic standard **ANSI C 63.4**

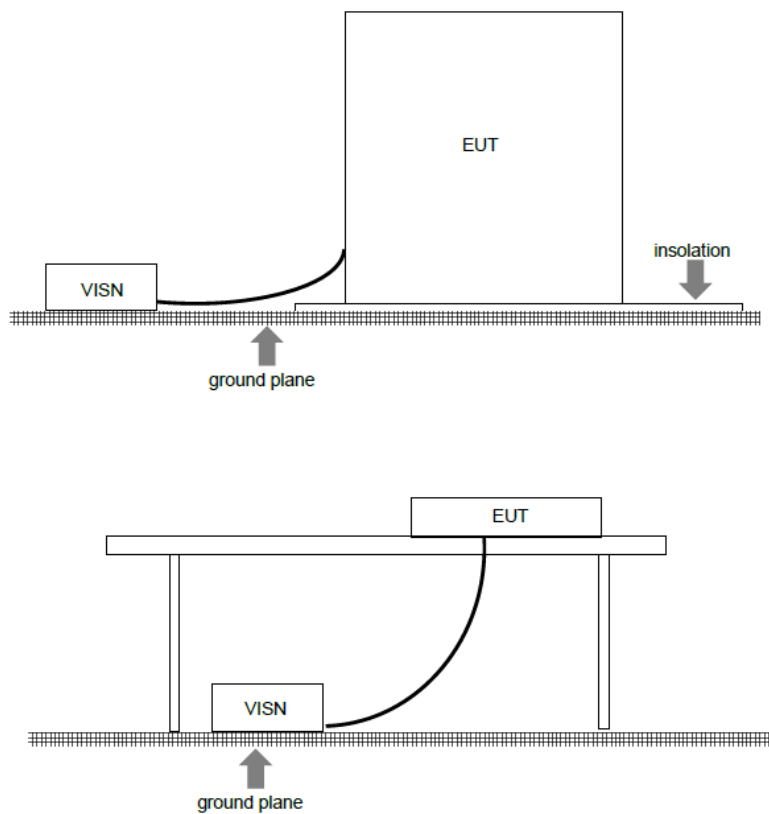

8.6 Monitoring Tests

Test Set-up 6:

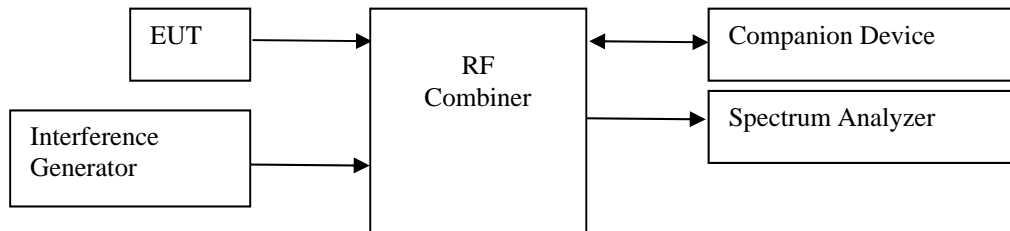

This test setup is used for all Monitoring and Time and Spectrum Access Procedure tests. The path loss from the signal generator to the EUT is measured with a power meter before the testing is started.

A clock signal is used to synchronize the Interference Generator to the start of the DECT frame, this signal always comes from the base station. If the EUT is a DECT Portable Part (i.e. a handset) the clock signal will come from the Companion Device.

8.7 Radiated Output Power Test

Test Set-up 7:

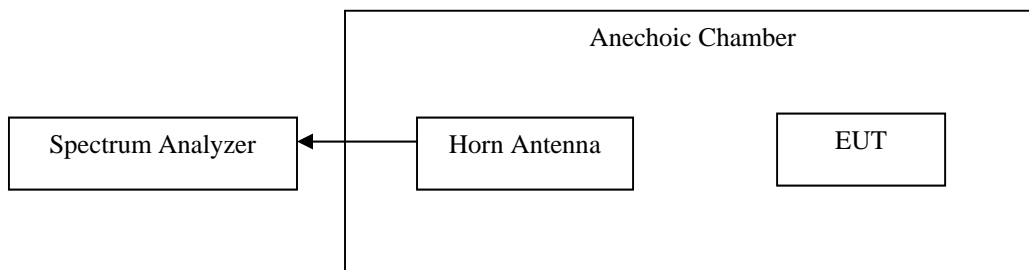

This setup is used for measuring the radiated output power in a fully anechoic chamber with a measurement distance of 1m.

9 Detailed Test Results

9.1 Power Line Conducted Emissions

Measurement Procedure:

ANSI C63.4-2014 using 50 μ H/50 ohms LISN.

Test Result: Pass

Measurement Data: See attached graphs and tables.

Requirement: FCC 15.207 (a)

Phase line

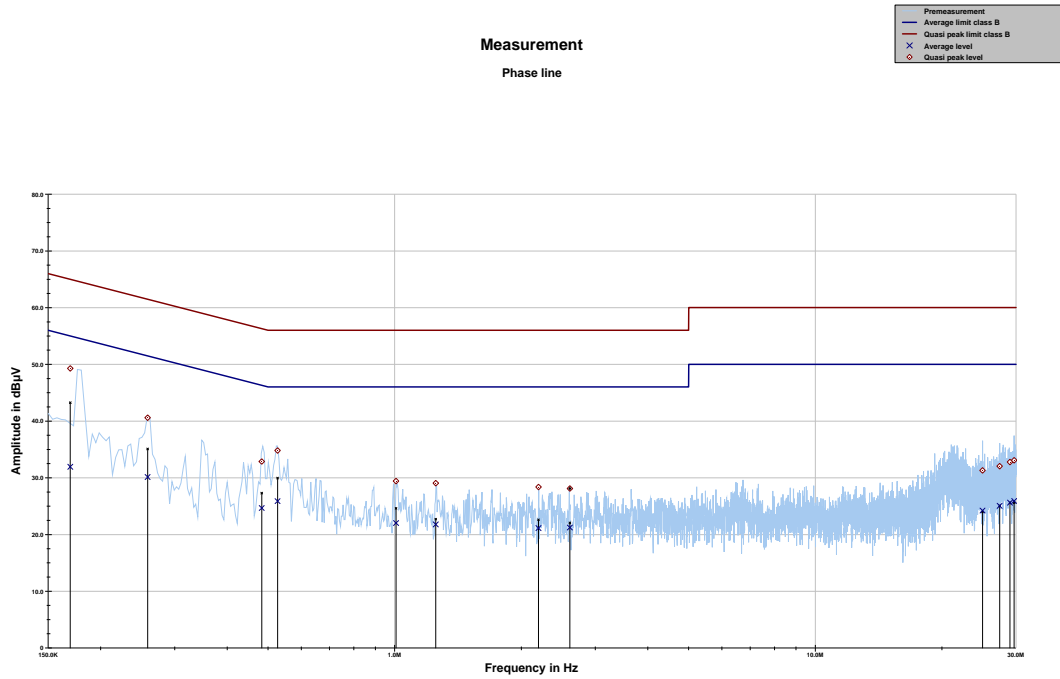

Project ID: 1-3016/16-01-12

Phase line tbl

Project ID: 1-3016/16-01-12

Frequency	Quasi peak level	Margin quasi peak	Limit QP	Average level	Margin average	Limit AV
MHz	dBµV	dB	dBµV	dBµV	dB	dBµV
0.169338	49.28	15.72	64.993	31.93	23.52	55.447
0.258648	40.59	20.89	61.475	30.12	22.78	52.896
0.483051	32.86	23.43	56.286	24.65	21.83	46.484
0.526634	34.80	21.20	56.000	25.87	20.13	46.000
1.007375	29.41	26.59	56.000	22.01	23.99	46.000
1.252306	29.04	26.96	56.000	21.77	24.23	46.000
2.198032	28.36	27.64	56.000	21.13	24.87	46.000
2.609937	28.10	27.90	56.000	21.22	24.78	46.000
24.985250	31.29	28.71	60.000	24.21	25.79	50.000
27.436528	32.03	27.97	60.000	25.04	24.96	50.000
29.031544	32.76	27.24	60.000	25.61	24.39	50.000
29.700581	33.07	26.93	60.000	25.90	24.10	50.000

Project ID - 1-3016/16-01-12

EUT - BL-ANT-1010-19G

SN -

Operating mode - RFID active, RFID antenna terminated

Neutral line

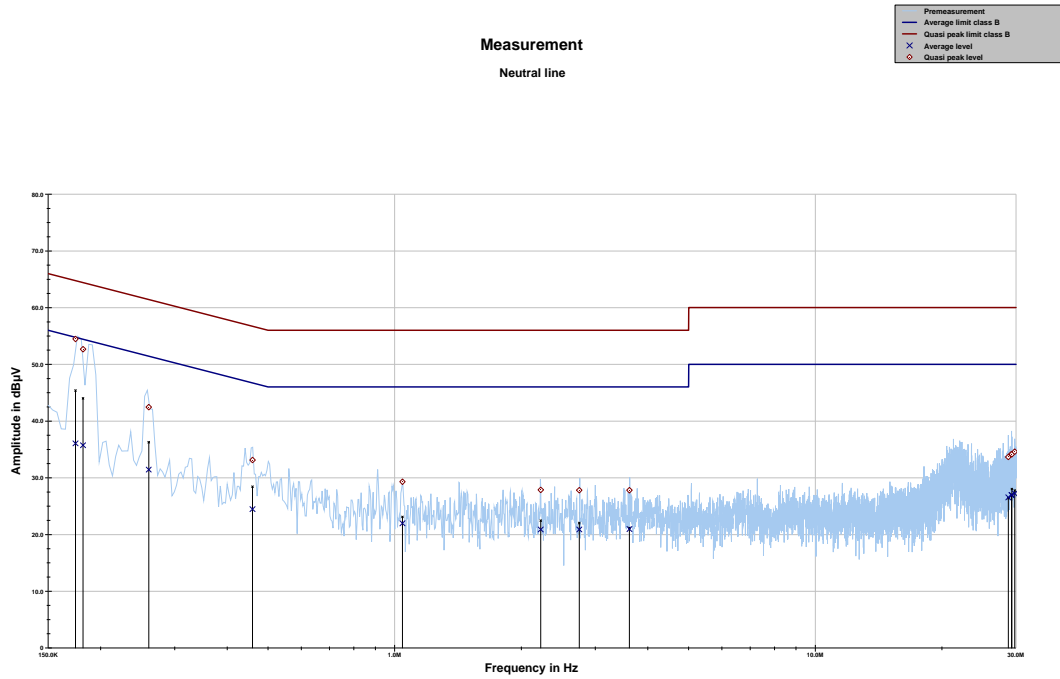

Project ID: 1-3016/16-01-12

Neutral line tbl

Project ID: 1-3016/16-01-12

Frequency	Quasi peak level	Margin quasi peak	Limit QP	Average level	Margin average	Limit AV
MHz	dBµV	dB	dBµV	dBµV	dB	dBµV
0.174258	54.48	10.27	64.755	36.07	19.24	55.307
0.181616	52.66	11.75	64.411	35.73	19.37	55.097
0.260281	42.44	18.98	61.422	31.43	21.42	52.849
0.459201	33.12	23.58	56.707	24.45	22.71	47.166
1.043638	29.30	26.70	56.000	21.97	24.03	46.000
2.225094	27.86	28.14	56.000	20.88	25.12	46.000
2.747898	27.80	28.20	56.000	20.88	25.12	46.000
3.615321	27.81	28.19	56.000	20.94	25.06	46.000
28.764238	33.66	26.34	60.000	26.55	23.45	50.000
29.269870	34.17	25.83	60.000	26.93	23.07	50.000
29.324551	34.15	25.85	60.000	26.97	23.03	50.000
29.790710	34.59	25.41	60.000	27.22	22.78	50.000

Project ID - 1-3016/16-01-12

EUT - BL-ANT-1010-19G

SN -

Operating mode - RFID active, RFID antenna terminated

9.2 Coordination with fixed microwave

The affidavit from UTAM, Inc. is included in the documentation supplied by the applicant:

Yes

No

Requirement: FCC 15.307 (b):

Each application for certification of equipment operating under the provisions of this Subpart must be accompanied by an affidavit from UTAM, Inc. certifying that the applicant is a participating member of UTAM, Inc. In the event a grantee fails to fulfill the obligations attendant to participation in UTAM, Inc., the commission may invoke administrative sanctions as necessary to preclude continued marketing and installation of devices covered by the grant of certification, including but not limited to revoking certification.

9.3 Digital Modulation Techniques

The tested equipment is based on DECT technology, the only difference is that the channel allocation is modified to operate in the 1920-1930 MHz band.

The EUT use Multi Carrier / Time Division Multiple Access / Time division duplex and Digital GFSK modulation.

For further details see the operational description provided by the applicant.

Requirement: FCC 15.319(b)

All transmissions must use only digital modulation techniques.

9.4 Labeling Requirements

See separate documents showing the label design and the placement of the label on the EUT.

Requirement: FCC 15.19

The FCC identifier shall be displayed on the label, and the device(s) shall bear the following statement in a conspicuous location on the device or in the user manual if the device is too small:

This device complies with Part 15 of the FCC rules. Operation is subject to the following two conditions: (1) this device may not cause harmful interference, and (2) this device must accept any interference received, including interference that may cause undesired operation.

The label itself shall be of a permanent type, not a paper label, and shall last the lifetime of the equipment.

9.5 Antenna Requirements

- Does the EUT have detachable antenna(s)? Yes No
- If detachable, is the antenna connector(s) non-standard? Yes No

The tested equipment has only integral antennas. The conducted tests were performed on a sample with a temporary antenna connector.

Requirements: FCC 15.203, 14.204. 15.317

9.6 Channel Frequencies

UPCS CHANNEL	FREQUENCY (MHz)
Upper Band Edge	1930.000
0 (Highest)	1928.448
1	1926.720
2	1924.992
3	1923.264
4 (Lowest)	1921.536
Lower Band Edge	1920.000

Requirement: FCC 15.303(d), (g)

Within 1920-1930 MHz band for isochronous devices.

9.7 Automatic Discontinuation of Transmission

Does the EUT transmit control and Signaling Information?	<input checked="" type="checkbox"/> Yes	<input type="checkbox"/> No
Type of EUT:	<input type="checkbox"/> Initiating device	<input checked="" type="checkbox"/> Responding device

The following tests simulate the reaction of the EUT in case of either absence of information to transmit or operational failure after a connection with the companion device is established.

Number	Test	EUT Reaction	Verdict
1	Power removed from EUT	A	Pass
2	EUT switched Off	N/A	N/A
3	Hook-On by companion device	B	PASS
4	Hook-On by EUT	N/A	N/A
5	Power removed from companion device	B	Pass
6	Companion device switched Off	B	Pass

- A – Connection breakdown, Cease of all transmissions
- B – Connection breakdown, EUT transmits control and signaling information
- C – Connection breakdown, companion device transmits control and signaling information
- N/A – Not applicable (the EUT does not have an on/off switch and can not perform Hook-On)

Requirement: FCC 15.319(f)

The device shall automatically discontinue transmission in case of either absence of information to transmit or operational failure. This provision is not intended to preclude transmission of control and signaling information or use or repetitive code used by certain digital modulation technologies to complete frame or burst intervals.

9.8 Peak Power Output

Measurement Procedure:

ANSI C63.17, clause 6.1.2.

Test Results: Pass

Measurement Data:

Maximum Conducted Output Power

Channel No.	Frequency (MHz)	Maximum Conducted Output Power (dBm)	Maximum Radiated Output Power (dBm)	Maximum Antenna Gain (dBi)
4	1921.536	15.3	22.7	7.4
2	1924.992	15.3	22.7	7.4
0	1928.448	15.0	22.4	7.4

For this test it was also checked that the input voltage variation of 85 and 115% of nominal value did not have any effect on the measured output power, neither radiated nor conducted.

Limit:

Conducted: $100 \mu\text{W} \times \text{SQRT}(B)$ where B is the measured Emission Bandwidth in Hz

FCC 15.319(c)(e): 20.8 dBm (120 mW)

RSS-213, Issue 2: 20.4 dBm (109 mW)

The antenna gain is above 3 dBi, this reduces the limit to 16 dBm.

Requirements: FCC 15.319(f). RSS-213, Issue 2

Peak transmit power shall not exceed 100 microwatts multiplied by the square root of the emission bandwidth in Hertz.

The peak transmit power shall be reduced by the amount in decibels that the maximum directional gain of the antenna exceeds 3 dBi.

Conducted Peak Output Power

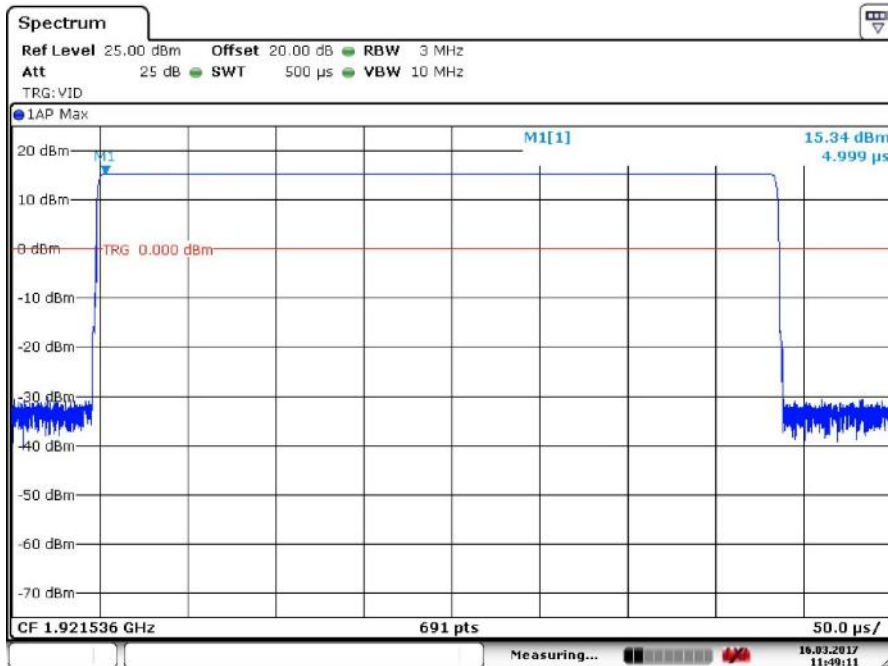

Lower Channel

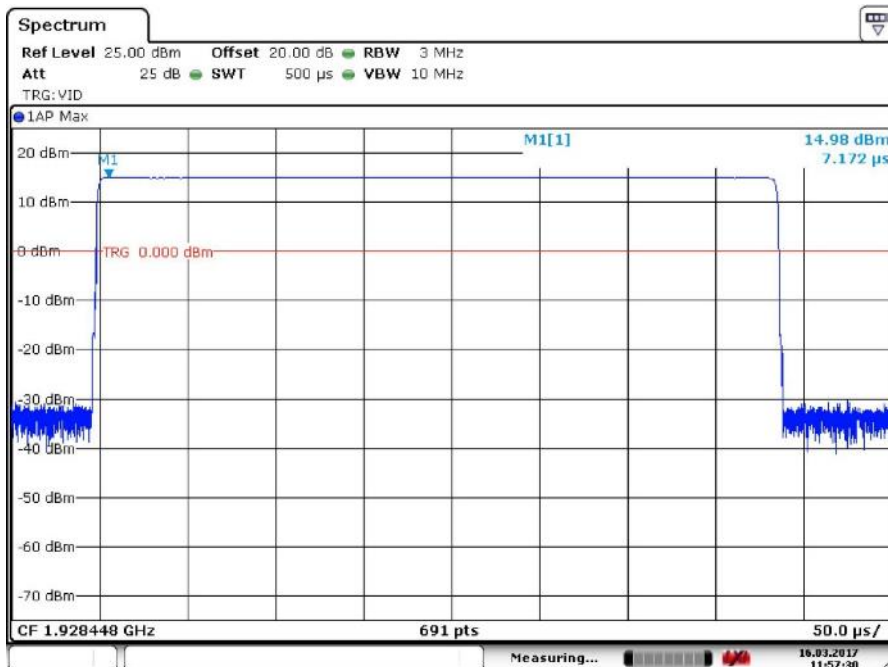

Upper Channel

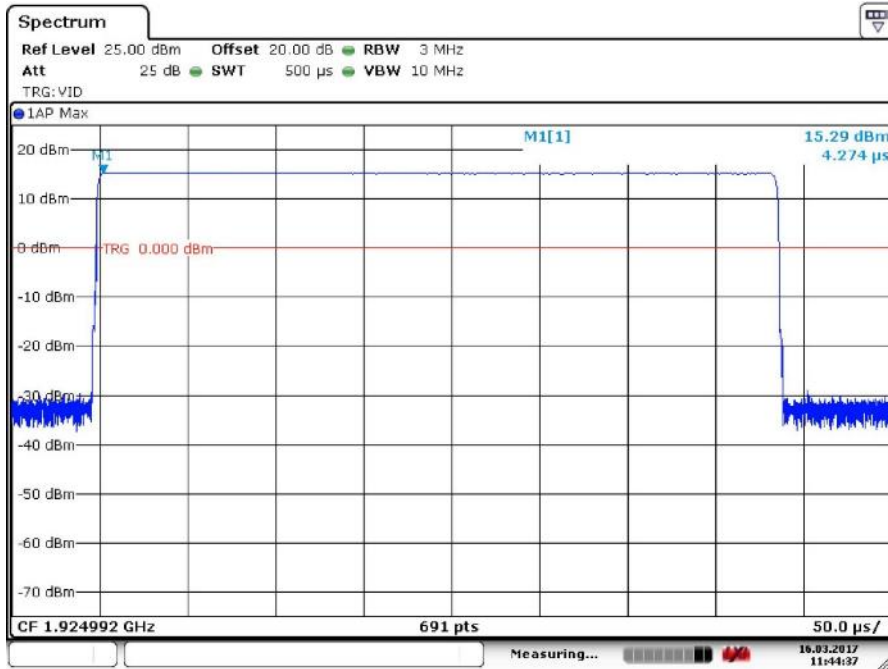

Middle Channel

Antenna Gain Measurement

- Maximum gain = 7.4 dBi

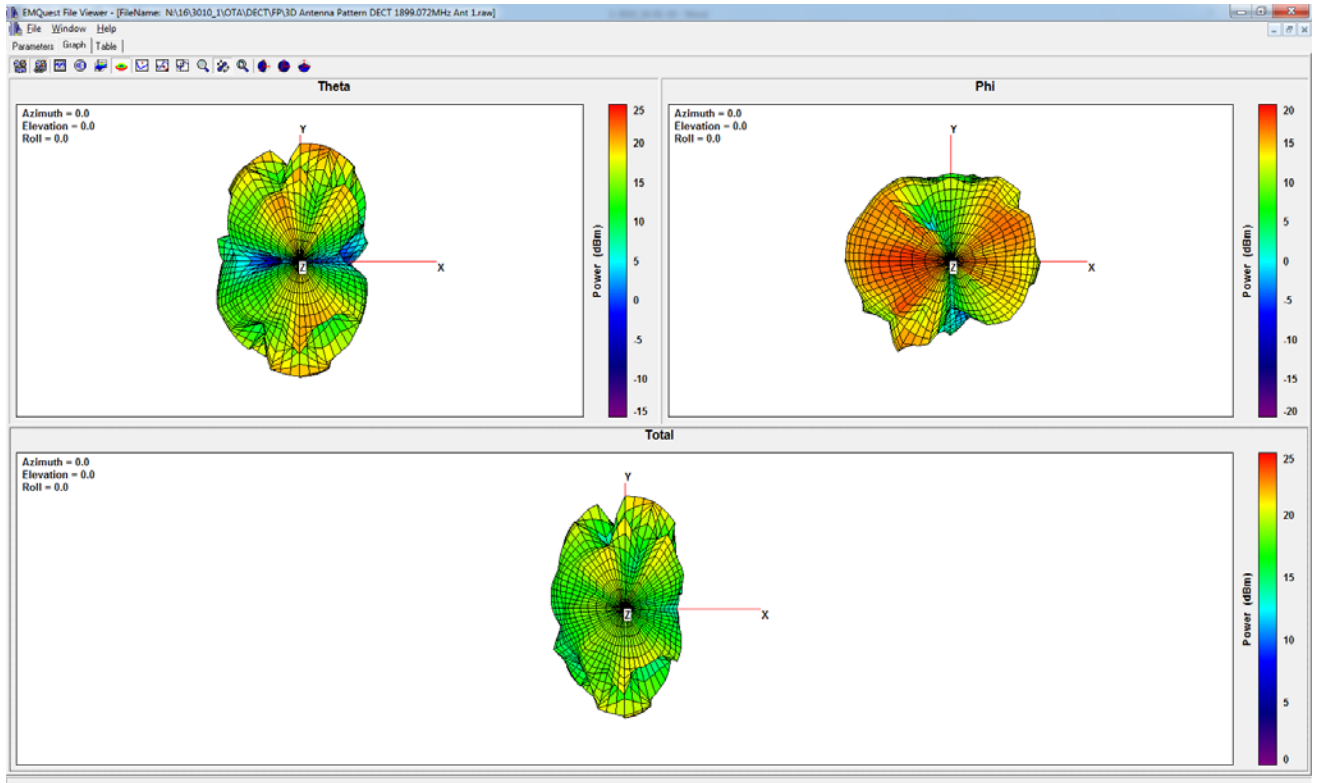

9.9 Emission Bandwidth B

Measurement Procedure:

ANSI C63.17, clause 6.1.3.

Test Results: Pass

Measurement Data:

Channel No.	Frequency (MHz)	26 dB Bandwidth B (kHz)
4	1921.536	1445
0	1928.448	1435

Channel No.	Frequency (MHz)	20 dB Bandwidth B (kHz)
2	1924.992	1189

Channel No.	Frequency (MHz)	6 dB Bandwidth B (kHz)
4	1921.536	N/A
0	1928.448	N/A

Channel No.	Frequency (MHz)	12 dB Bandwidth B (kHz)
4	1921.536	N/A
0	1928.448	N/A

Requirement: FCC 15.323(a)

The 26 dB Bandwidth B shall be larger than 50 kHz and less than 2.5 MHz.

Requirement: RSS-213 Issue 2, clause 6.4

The 20 dB Bandwidth B shall be larger than 50 kHz and less than 2.5 MHz.

No requirement for 6 dB and 12 dB Bandwidth. These values are only used for testing Monitoring Bandwidth if the Simple Compliance test fails (ANSI C63.17, clause 7.4).

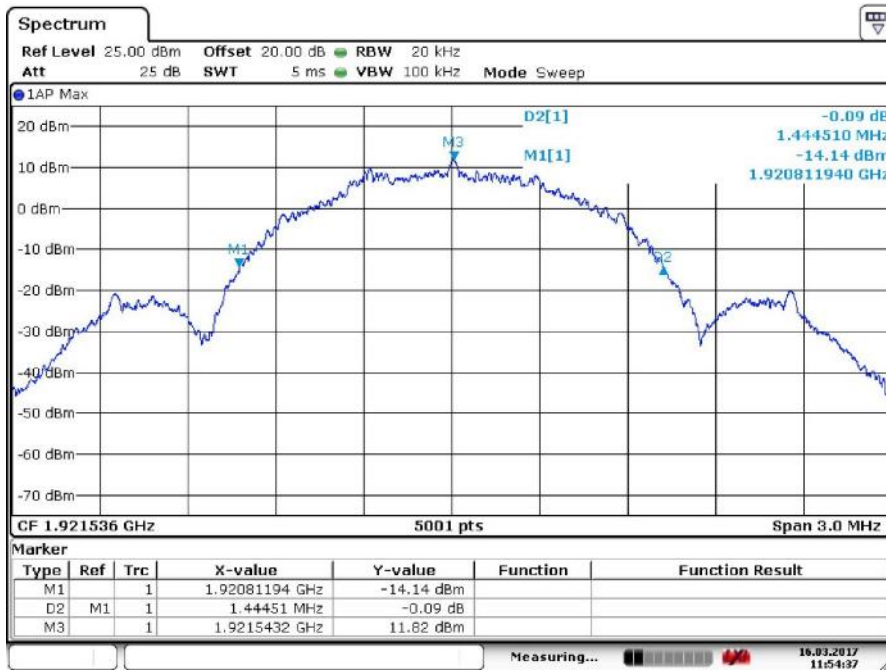

Emission Bandwidth B, Lower Channel

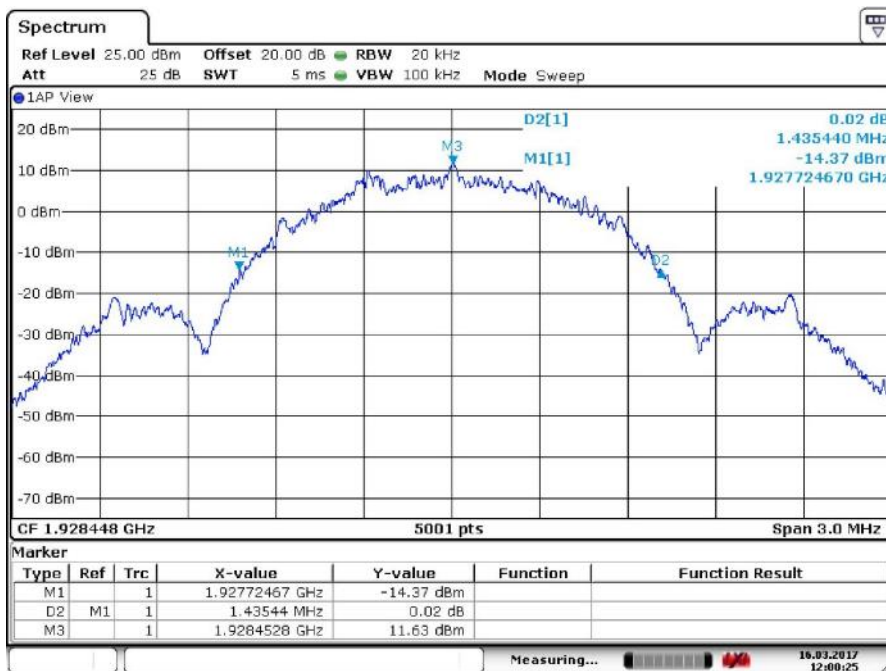

Emission Bandwidth B, Upper Channel

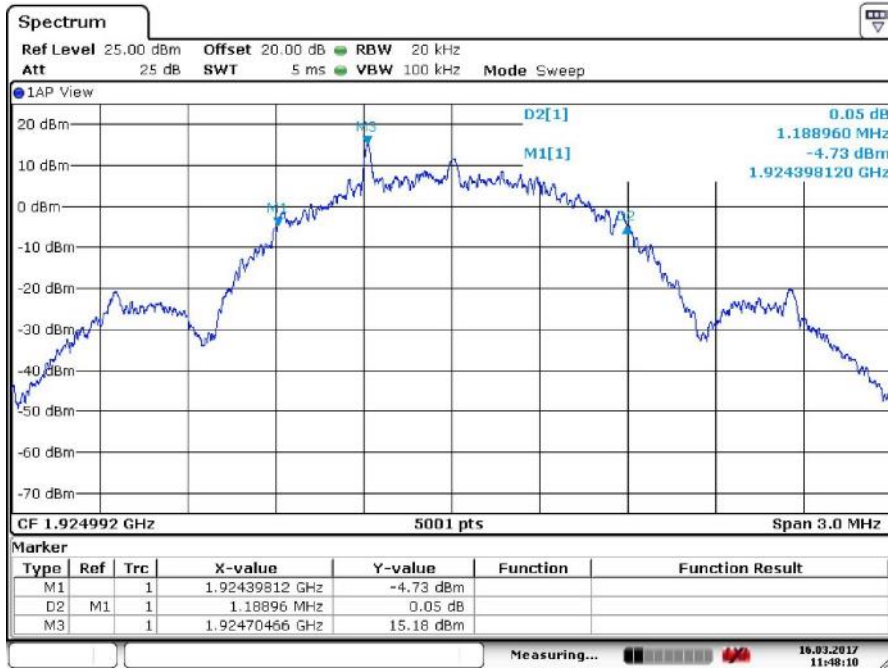

20 dB Bandwidth B, Middle Channel

9.10 Power Spectral Density

Measurement Procedure:

ANSI C63.17, clause 6.1.5.

Test Results: Pass

Measurement Data:

Channel No.	Frequency (MHz)	Power Spectral Density (mW/3kHz)
4	1921.5432	0.50
0	1928.4528	0.54

Averaged over 100 sweeps.

Requirement: FCC 15.319(d)

The Power Spectral Density shall be less than 3 mW (4.77 dBm) when averaged over at least 100 sweeps.

Power Spectral Density

Lower Channel:

Frequency of the maximum level was recorded under chapter 5.9.



Averaged, 100 Sweeps

Pulse power [dBm]	-3.04
Pulse power [mW]	0.50

Power Spectral Density

Upper Channel:

Frequency of the maximum level was recorded under chapter 5.9.

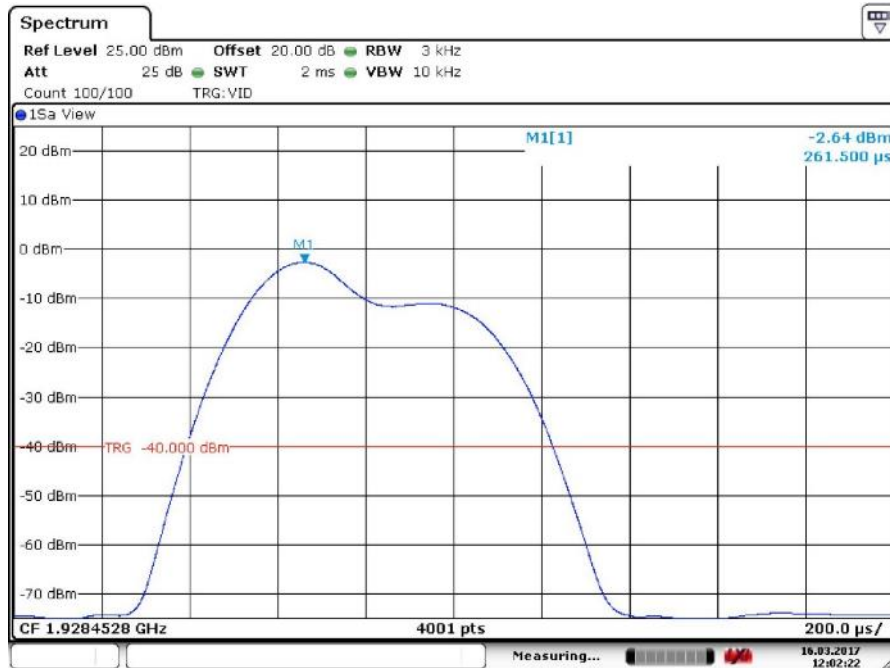

Averaged, 100 Sweeps

Pulse power [dBm]	-2.64
Pulse power [mW]	0.54

9.11 In-Band Unwanted Emissions, Conducted

Measurement Procedure:

ANSI C63.17, clause 6.1.6.1.

Test Results: Pass

Measurement Data:

See plots.

Requirement: FCC 15.323(d)

B < f2 ≤B:	less than or equal to 30 dB below max. permitted peak power level
2B < f2 ≤3B:	less than or equal to 50 dB below max. permitted peak power level
3B < f2 ≤UPCS Band Edge:	less than or equal to 60 dB below max. permitted peak power level

In-Band Unwanted Emissions, Conducted

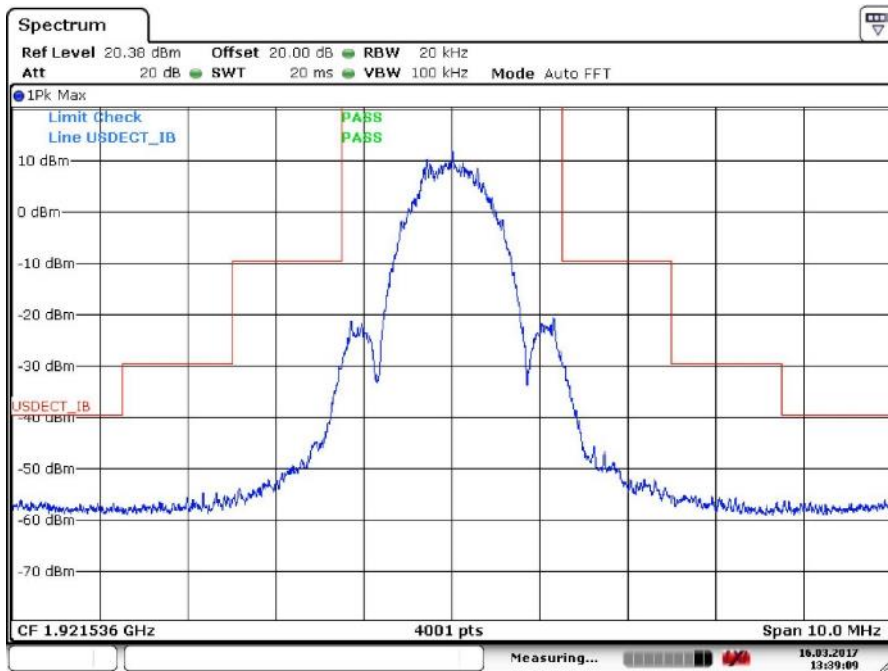

Lower Channel

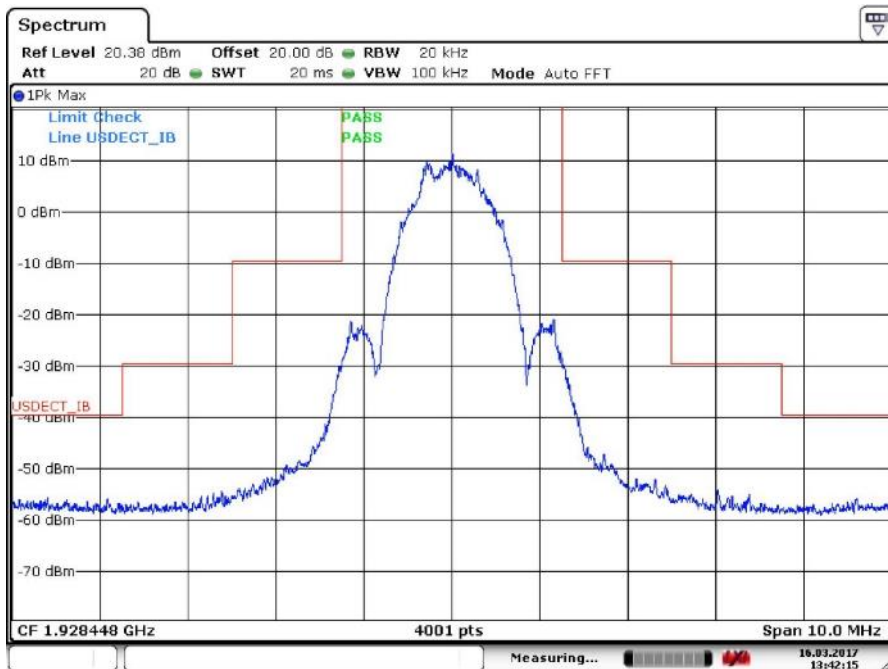

Upper Channel

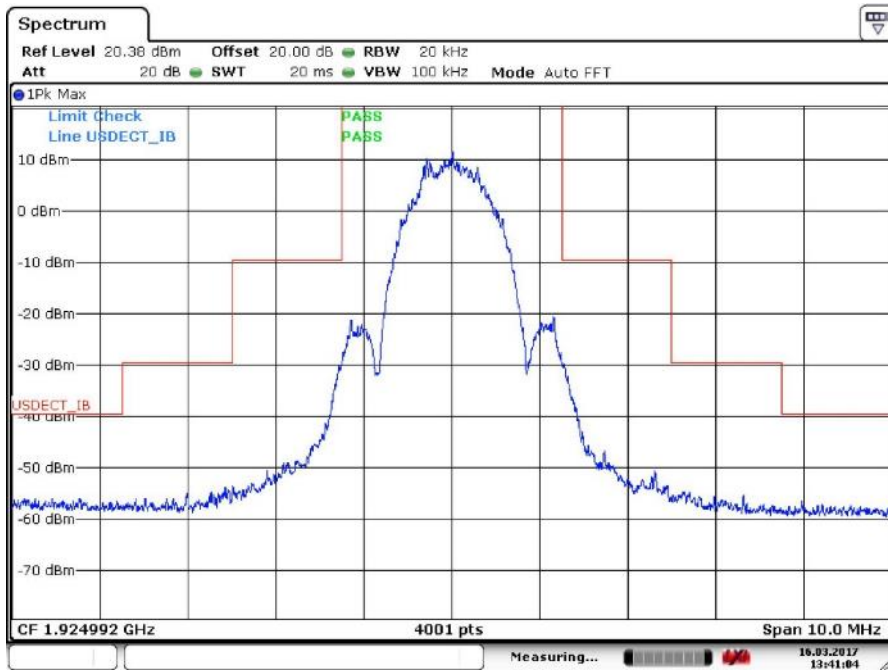

Middle Channel

The BS spurious in-band transmission level is below the indicated limit.

9.12 Out-of-Band Emissions, Conducted

Measurement Procedure:

ANSI C63.17, clause 6.1.6.2.

Test Results: Pass

Measurement Data:

See plots.

Requirement: FCC 15.323(d)

$f \leq 1.25$ MHz outside UPCS band:	≤ -9.5 dBm
1.25 MHz $\leq f \leq 2.5$ MHz outside UPCS band:	≤ -29.5 dBm
$f \geq 2.5$ MHz outside UPCS band:	≤ -39.5 dBm

Out-of-Band Unwanted Emissions, Conducted

Upper and Lower Channel:

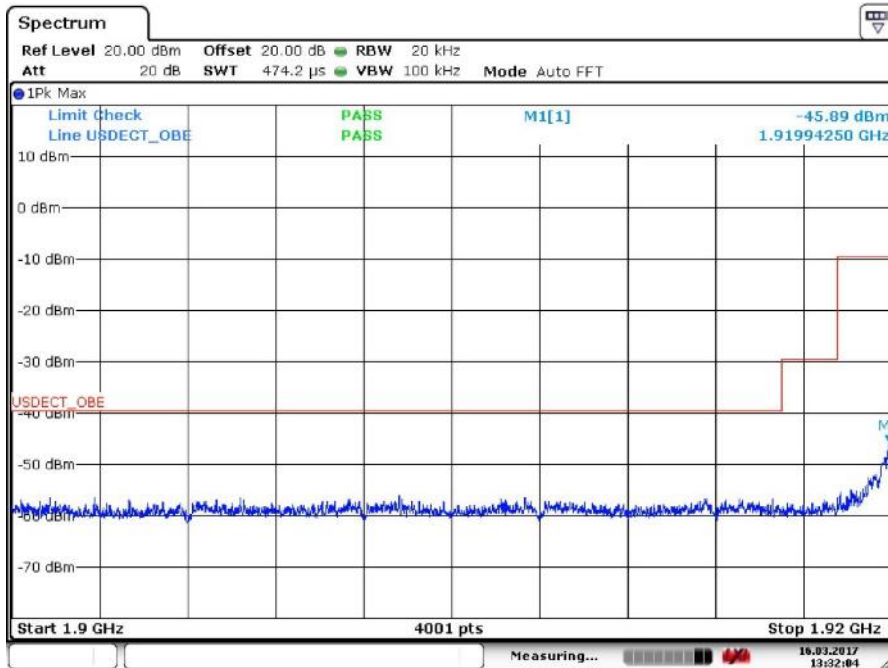
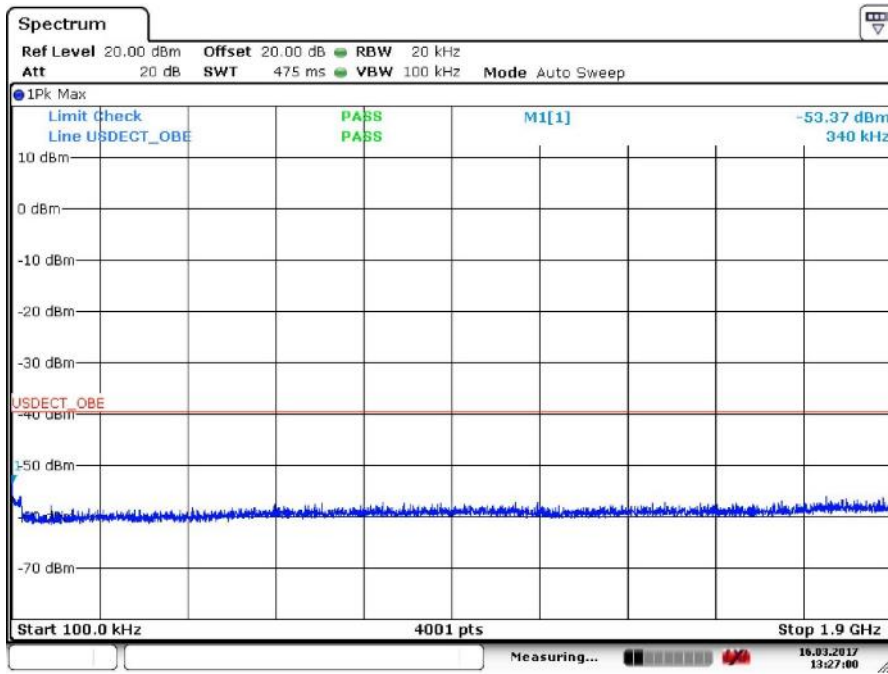

Out-of-Band Unwanted Emissions, Conducted

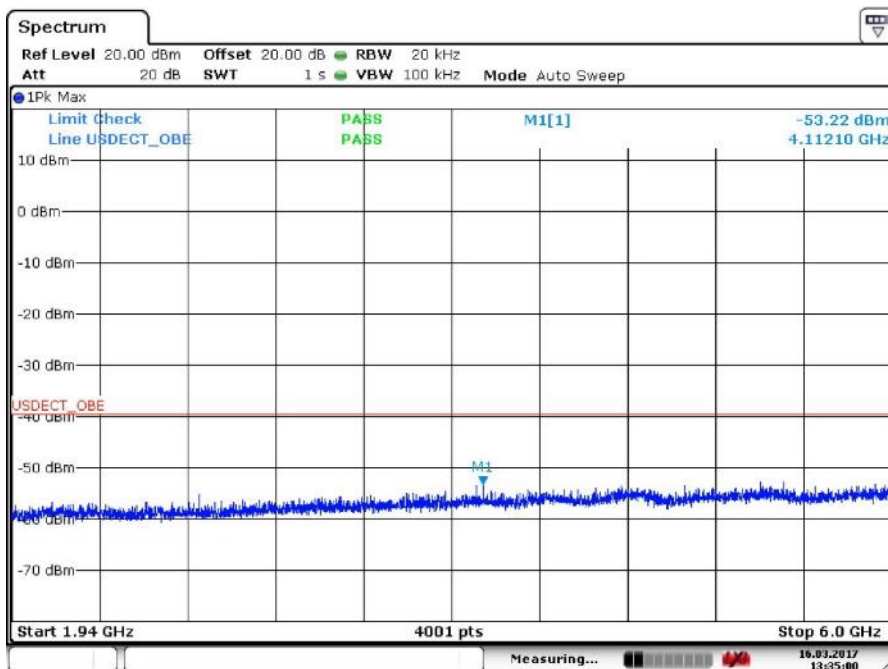
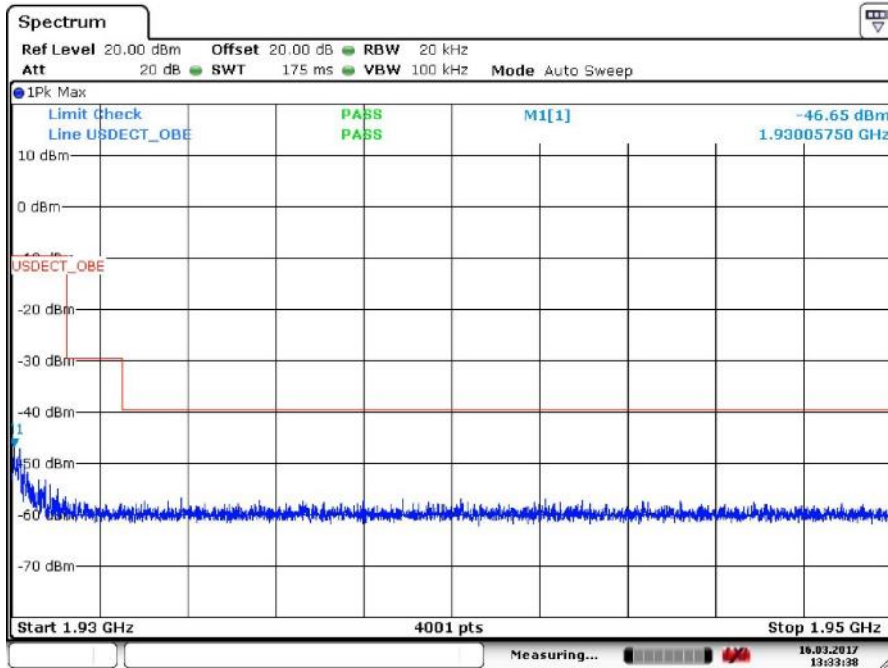

Out-of-Band Unwanted Emissions, Conducted

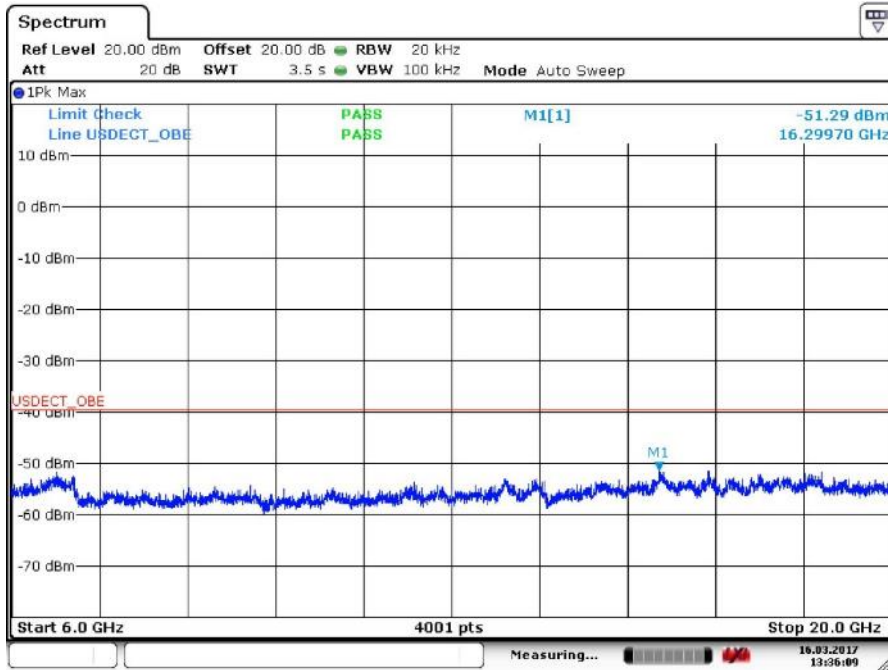

The BS spurious out-of-band transmission level is below the indicated limit.

9.13 Carrier Frequency Stability

Measurement Procedure:

ANSI C63.17, clause 6.2.1.

Test Results: Pass

Measurement Data:

The Frequency Stability is measured with the CMD65. The CMD65 was logged by a computer programmed to get the new readings as fast as possible (about 3 readings per second) over the noted time period or number of readings. The peak-to-peak difference was recorded and the mean value and deviation in ppm was calculated.

The Carrier Frequency Stability over power Supply Voltage and over Temperature is measured also with the CMD65.

Carrier Frequency Stability over Time at Nominal Temperature

Average Mean Carrier Frequency (MHz)	Max. Diff. (kHz)	Min. Diff. (kHz)	Max Dev. (ppm)	Limit (ppm)
1924.993171	3.07	-0.81	0.99	±10

Deviation ppm = ((Max.Diff. – Mean.Diff.) / Mean Carrier Freq.) x 10⁶

Deviation (ppm) is calculated from 3000 readings with the CMD65.

Carrier Frequency Stability over Power Supply at Nominal Temperature

Voltage	Measured Carrier Frequency (MHz)	Difference (kHz)	Deviation (ppm)	Limit (ppm)
115 V AC	1924.995	Ref.	Ref.	±10
98 V AC	1924.995	0.0	0.0	
132 V AC	1924.995	0.0	0.0	

Deviation ppm = ((Mean – Measured frequency) / Mean) x 10⁶

Carrier Frequency Stability over Temperature

Temperature	Measured Carrier Frequency (MHz)	Difference (kHz)	Deviation (ppm)	Limit (ppm)
T = +20°C	1924.995	Ref.	Ref.	±10
T = -20°C	1924.995	0.0	0.0	
T = +50°C	1924.995	0.0	0.0	

Deviation ppm = ((Mean – Measured frequency) / Mean) x 10⁶

9.14 Frame Repetition Stability

Measurement Procedure:

ANSI C63.17, clause 6.2.2.

Test Results: Pass

Measurement Data:

The Frame Repetition Stability is measured with the CMD65. The Frame Repetition Stability is 3 times the standard deviation.

Carrier Frequency (MHz)	Mean (Hz)	Standard Deviation (ppm)	Frame Repetition Stability (ppm)
1924.992	99.99999999988	0.1	0.3

Limit:

Frame Repetition Stability	±10 ppm (TDMA)
-----------------------------------	----------------

Ref. FCC 15.323(e). ANSI C63.17, clause 6.2.2.

9.15 Frame Period and Jitter

Measurement Procedure:

ANSI C63.17, clause 6.2.3.

Test Results: Pass

Measurement Data:

The Frame Repetition Stability is measured with the CMD65

Carrier Frequency (MHz)	Frame Period (ms)	Max Jitter (µs)	3xStandard Deviation of Jitter (µs)
1924.992	10.000	0.007	0.006

Max Jitter = $(1/(\text{Frame Period} + \text{Pk-Pk})/2) - (1/\text{Frame Period})$, when Pk-Pk and Frame Period are in Hz.
 $3x\text{St.Dev. Jitter} = 3x(1/(\text{Frame Period} + \text{St.Dev})) - (1/\text{St.Dev}) \times 10^6$

Limit:

Frame Period	20 or 10 ms
Max Jitter	25 µs
3 times St.Dev. of Jitter	12.5 µs

Ref. FCC 15.323(e). ANSI C63.17, clause 6.2.3.

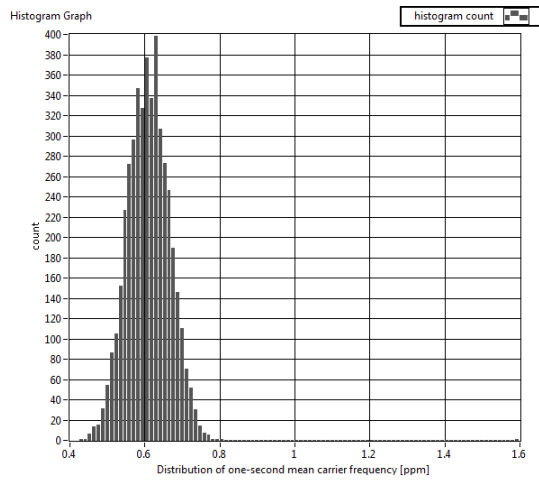

Histogram of Carrier Frequency Stability

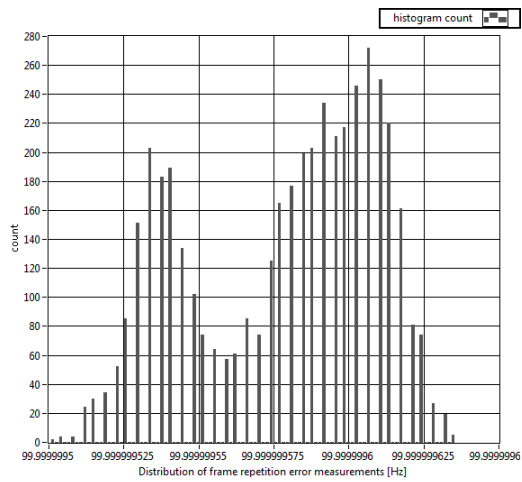

Histogram of Frame Repetition Stability

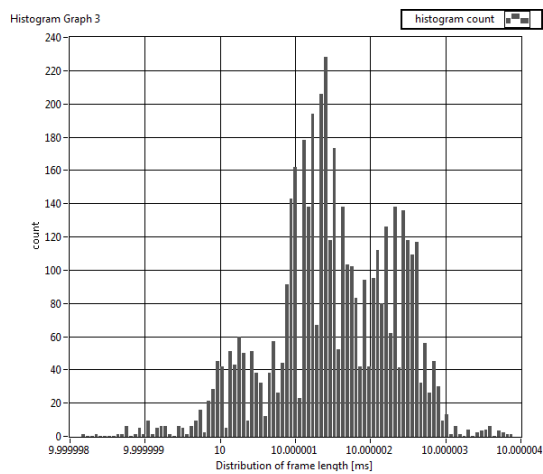

Histogram of Frame Period and Jitter

9.16 Monitoring Threshold, Least Interfered Channel

Measurement Procedure:

ANSI C63.17, clause 7.3.2

Monitoring Threshold limits:

Lower Threshold:

$$T_L = 15 \log B - 184 + 30 - P_{EUT} \text{ (dBm)}$$

B is measured Emission Bandwidth in Hz

P_{EUT} is measured Transmitter Power in dBm

Calculated value:

Lower Threshold	-76.9 dBm
-----------------	-----------

Least Interfered Channel (LIC) Procedure Test, FCC 15.323(b), (c)(2) and (c)(5)

ANSI C63.17 clause 7.3.2 ref.	Observation	Verdict
b) $f_1 T_L + 13 \text{ dB}$, $f_2 T_L + 6 \text{ dB}$	Transmission always on f_2	Pass
c) $f_1 T_L + 6 \text{ dB}$, $f_2 T_L + 13 \text{ dB}$	Transmission always on f_1	Pass
d) $f_1 T_L + 7 \text{ dB}$, $f_2 T_L$	Transmission always on f_2	Pass
e) $f_1 T_L$, f_2 at $T_L + 7 \text{ dB}$	Transmission always on f_1	Pass

Measurement Procedure:

ANSI C63.17, clause 7.3.3

Selected Channel Confirmation, FCC 15.323(c)(1) and (5)

ANSI C63.17 clause 7.3.3	Observation	Verdict
b) Shall not transmit on f_1	EUT transmits on f_2	N/A
d) Shall not transmit on f_2	EUT transmits on f_1	N/A

Comment: This test is only applicable for EUTs that can be an initiating device.

9.17 Threshold Monitoring Bandwidth

This test is only required if a dedicated monitoring receiver is used. If the test is not carried out the manufacturer shall declare and provide evidence that the monitoring is made through the radio receiver used for communication.

Measurement Procedure:

Simple Compliance Test, ANSI C63.17, clause 7.4.1

More Detailed Test, ANSI C63.17, clause 7.4.2

The test is passed if **either** the Simple Compliance Test or the More Detailed Test is passed.

During this test the spectrum analyzer is observed visually to see if the EUT transmits or not.

Test Results:

Test performed	Observation	Verdict
Simple Compliance Test, at $\pm 30\%$ of B	N/A	N/A
More Detailed Test, at -6 dB points	N/A	N/A
More Detailed Test, at -12 dB points	N/A	N/A

The More Detailed Test must be pass at both the -6dB and -12 dB points if the Simple Compliance Test fails.

Comment: The tested EUT uses the same receiver for monitoring and communication, this test is therefore not required.

Limits: FCC 15.323(c)(7):

The monitoring system bandwidth must be equal to or greater than the emission bandwidth of the intended transmission.

9.18 Reaction Time and Monitoring Interval

Measurement Procedure:

ANSI C63.17, clause 7.5

Test Results:

By administrative commands and out-of-operating region interference, the EUT is restricted to operate on carrier frequencies f_1 and f_2 .

Time-synchronized pulsed interference was then applied on f_1 at pulsed levels TL + UM to check that the EUT does not transmit. The level was raised 6 dB for part d) with 35 μ s pulses. Additionally a CW signal was applied on f_2 with a level of TL.

The pulses are synchronized with the EUT timeslots and applied centered within all timeslots.

Pulse Width, ref. to ANSI C63.17 clause 7.5	Observation	Verdict
c) > largest of 50 μ s and $50 \cdot \text{SQRT}(1.25/B)$	Transmission on f_2	Pass
d) > largest of 35 μ s and $35 \cdot \text{SQRT}(1.25/B)$ and with interference level raised 6 dB	Transmission on f_2	Pass

Comment: Since B is larger than 1.25 MHz, the test was performed with pulse lengths of 50 μ s and 35 μ s.

Limits: FCC 15.323(c)(1), (5) and (7)

The maximum reaction time must be less than $50 \cdot \text{SQRT}(1.25/\text{emission bandwidth in MHz})$ microseconds for signals at the applicable threshold level but shall not be required to be less than 50 microseconds.

If a signal is detected that is 6 dB or more above the applicable threshold level, the maximum reaction time shall be $35 \cdot \text{SQRT}(1.25/\text{emission bandwidth in MHz})$ microseconds but shall not be required to be less than 35 microseconds.

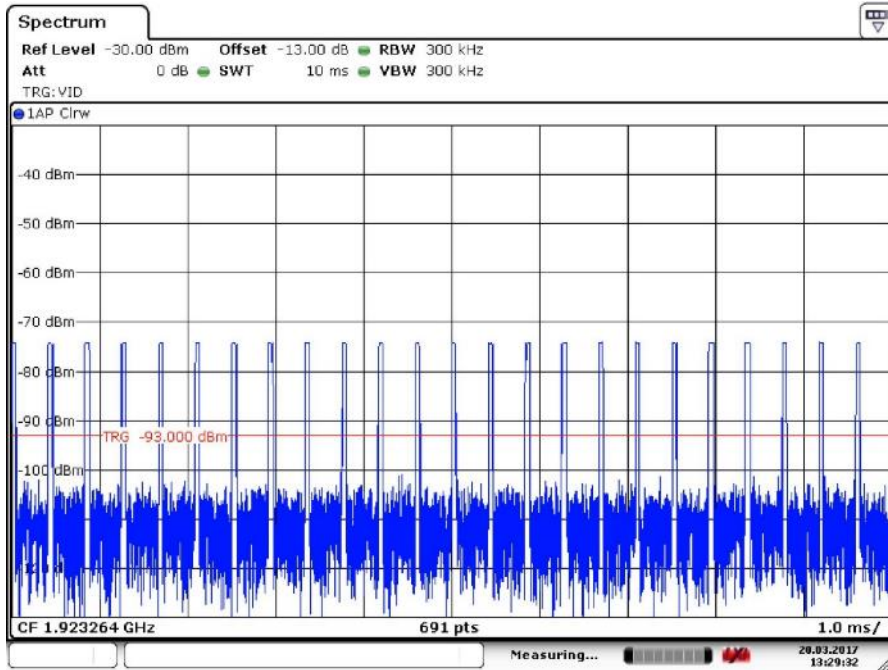

50 µs Pulses

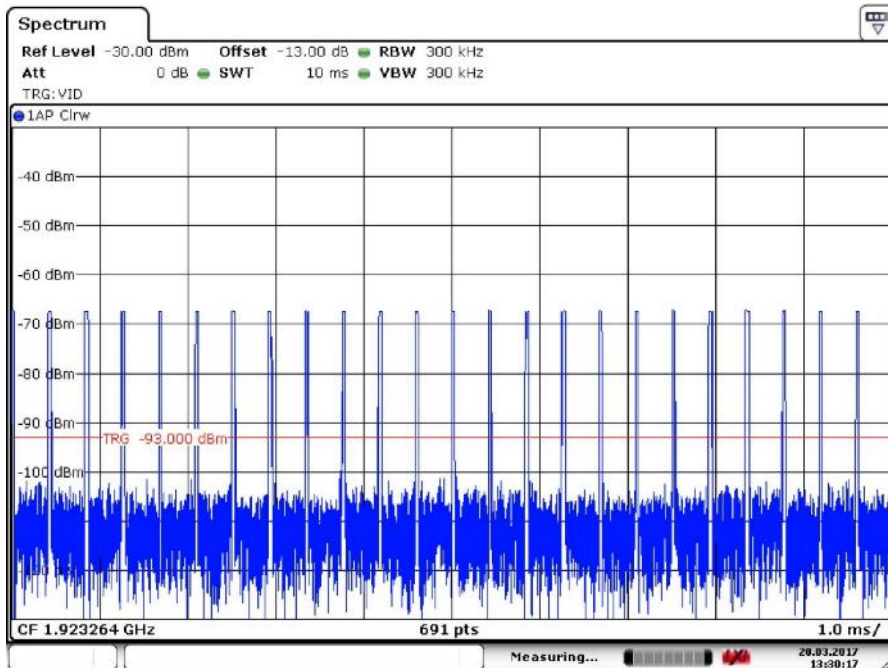

35 µs Pulses

9.19 Time and Spectrum Window Access Procedure

This requirement is only for EUTs which transmit unacknowledged control and signaling information

Measurement Procedure:

Timing for EUTs using control and signaling channel type transmissions: ANSI C63.17, clause 8.1

Test results:

Access Criteria, ref. to ANSI C63.17 clause 8.1.1	Observation	Verdict
b) Check that the EUT transmits on the interference free time slot	EUT transmits on the Interference free time slot	PASS
b) The EUT must terminate or pause in its repetitive transmission of the control and signaling channel on the open channel to repeat the access criteria not less frequently than every 30 s	Transmission stops every 1.3 s	PASS

If FCC 15.323(c)(6) option Random Waiting Interval is NOT implemented

Access Criteria, ref. to ANSI C63.17 clause 8.1.2	Observation	Verdict
b) Check that the EUT changes to interference free time slot when interference is introduced on the time slot in use	EUT changes to Interference free time slot, and stays there	PASS

If FCC 15.323(c)(6) option Random Waiting Interval is implemented

Access Criteria, ref. to ANSI C63.17 clause 8.1.3	Observation	Verdict
b-d) Check that the EUT uses random waiting interval before continuing transmission on an interfered time slot	N/A	N/A

Comment: The tested EUT does not support the Random Waiting Interval option.

Limits:

FCC 15.323(c)(4):

Once access to specific combined time and spectrum windows is obtained an acknowledgement from a system participant must be received by the initiating transmitter within one second or transmission must cease. Periodic acknowledgments must be received at least every 30 seconds or transmission must cease. Channels used exclusively for control and signaling information may transmit continuously for 30 seconds without receiving an acknowledgement, at which the time access criteria must be repeated.

FCC 15.323(c)(6):

If the selected combined time and spectrum windows are unavailable, the device may either monitor and select different windows or seek to use the same windows after waiting an amount of time, randomly chosen from a uniform random distribution between 10 and 150 milliseconds, commencing when the channel becomes available.

Access Criteria Check

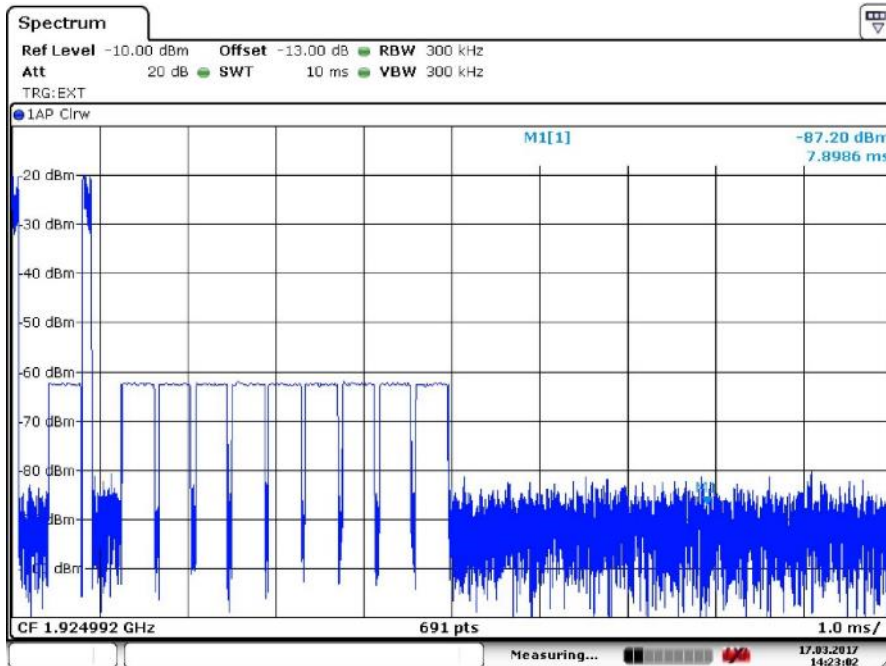

8.1.1b) EUT Transmits on Unblocked Slot

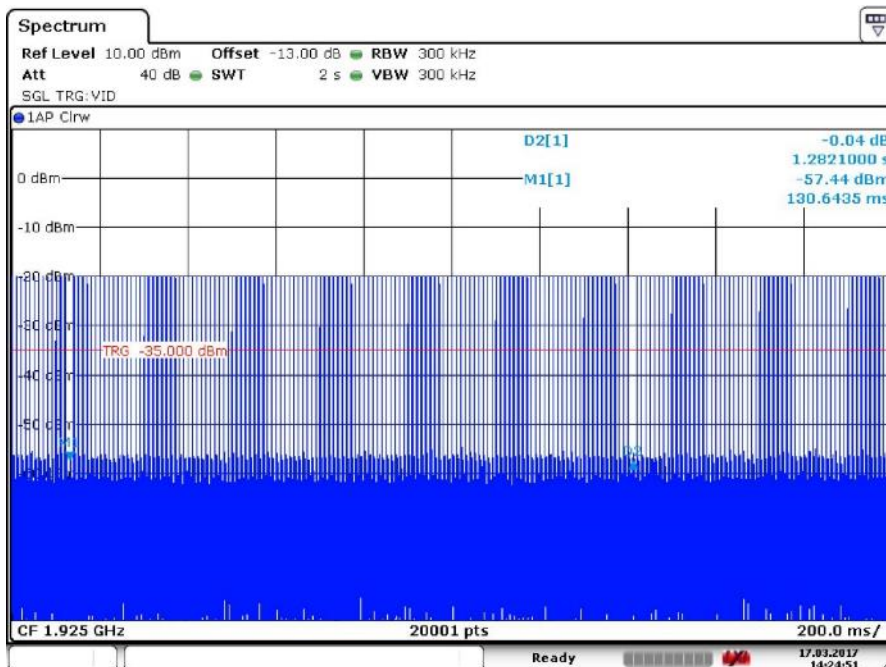

8.1.1b) EUT Terminates Repetitive Transmission

Capture of transmission of base EUT control and signaling transmissions. The base EUT pauses in its transmission of the control and signaling channel to repeat the access criteria every 1.3 s seconds, meeting the requirement that it do so at least as often as every 30 seconds.

Access Criteria Check

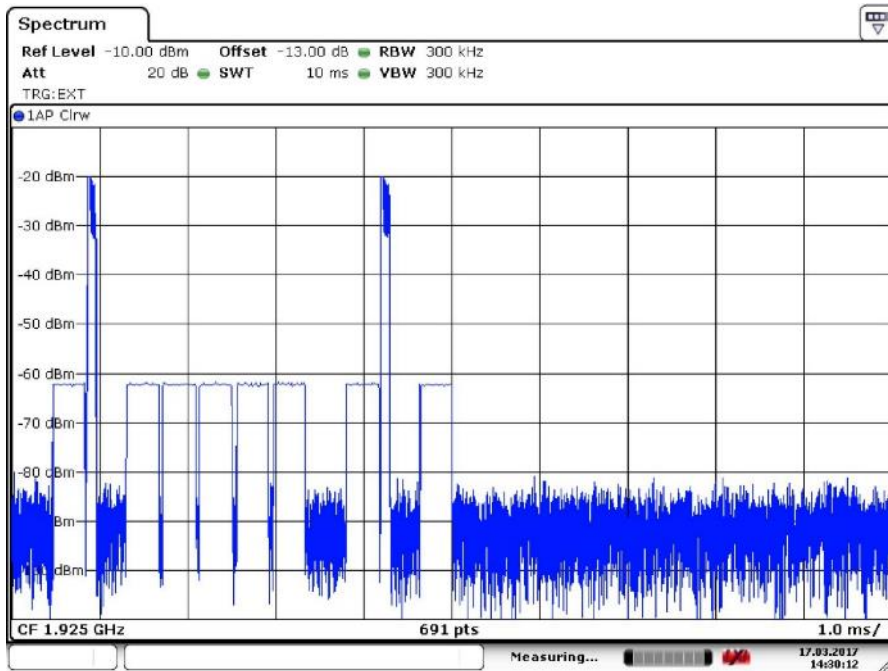

8.1.2) EUT Changes to an Interference Free Timeslot, Before

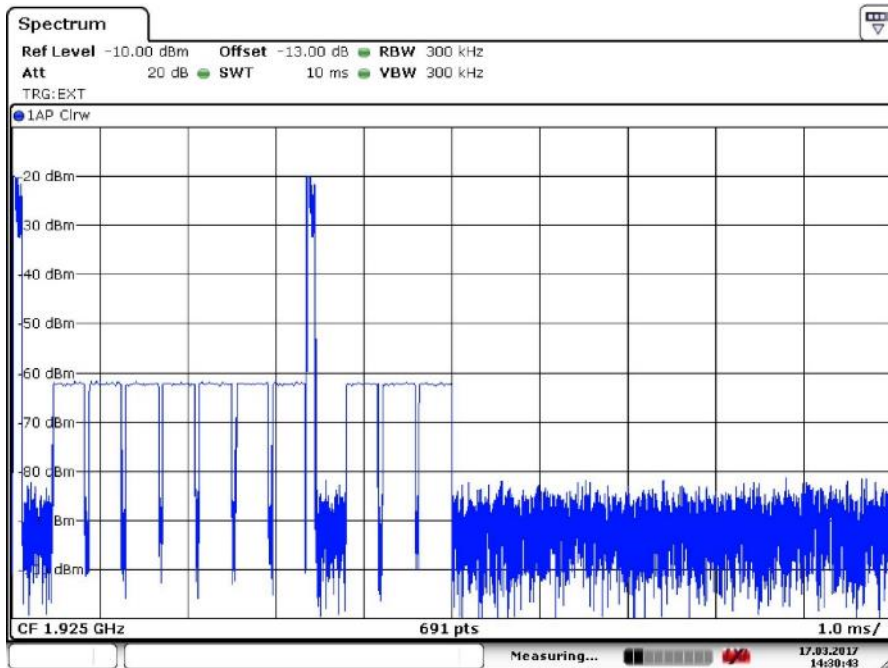

8.1.2) EUT Changes to an Interference Free Timeslot, After

9.20 Acknowledgments and Transmission duration

Measurement Procedure:

Acknowledgments: ANSI C63.17, clause 8.2.1

Transmission Duration: ANSI C63.17, clause 8.2.2

During the test **Initial transmission without acknowledgments** the signal from the EUT to the companion device is blocked by circulators in addition to the tunable attenuator.

The test **Transmission time after loss of acknowledgments** is performed by cutting-off the signal from the companion device by a RF switch the time until the EUT stops transmitting.

The **Transmission Duration** test is performed by monitoring the slot in use and measuring the time until the EUT changes to a different slot.

Test Results:

Acknowledgments

Test ref. to ANSI C63.17 clause 8.2.1	Observation	Verdict
a) Initial transmission without acknowledgments	Only for initiating device	N/A
c) Transmission time after loss of acknowledgments	15 s	Pass

Transmission Duration

Test ref. to ANSI C63.17 clause 8.2.2	Observation	Verdict
b) Transmission duration on same time and frequency window	Only for initiating device that controls which time slot is used	N/A

Comment: /

Limits: FCC 15.323(c)(3) and (4)

Occupation of the same combined time and spectrum windows by a device or group of cooperating devices continuously over a period of time longer than 8 hours is not permitted without repeating the access criteria.

Once access to specific combined time and spectrum windows is obtained an acknowledgment from a system participant must be received by the initiating transmitter within one second or transmission must cease.

Periodic acknowledgments must be received at least every 30 seconds or transmission must cease. Channels used exclusively for control and signaling information may transmit continuously for 30 seconds without receiving an acknowledgement, at which the time access criteria must be repeated.

9.21 Dual Access Criteria Check

Measurement Procedure:

EUTs that do not implement the Upper Threshold: ANSI C62.17, clause 8.3.1

EUTs that implement the Upper Threshold: ANSI C62.17, clause 8.3.2

This test is required for equipment that uses the access criteria in FCC 15.323(c)(10).

Test Results:

EUTs that do NOT implement the Upper Threshold:

Test ref. to ANSI C63.17 clause 8.3.1	Observation	Verdict
b) EUT is restricted to a single carrier f_1 for TDMA systems. The test is pass if the EUT can set up a communication link.	N/A	N/A
c) d) No transmission on interference-free receive time/spectrum window. All transmit slots blocked	N/A	N/A
e) f) No transmission on interference-free transmit time/spectrum window. All transmit slots blocked	N/A	N/A

EUTs that implement the Upper Threshold:

Test ref. to ANSI C63.17 clause 8.3.2	Observation	Verdict
b) EUT is restricted to a single carrier f_1 for TDMA systems. The test is pass if the EUT can set up a communication link.	N/A	N/A
c) d) Transmission on interference-free receive time/spectrum window.	N/A	N/A
e) f) Transmission on interference-free transmit time/spectrum window.	N/A	N/A
g) Transmission not possible on any time/spectrum window.	N/A	N/A

Comment: This test is only applicable for EUTs that can be an initiating device of a duplex connection.

Limits: FCC 15.323(c)(10)

An initiating device may attempt to establish a duplex connection by monitoring both, its intended transmit and receive time and spectrum windows. If both the intended transmit and receive time and spectrum windows meet the access criteria, then the initiating device can initiate a transmission in the intended transmit time and spectrum window. If the power detected by the responding device can be decoded as a duplex connection signal from the initiating device, then the responding device may immediately begin transmitting on the receive time and spectrum window monitored by the initiating device.

9.22 Alternative monitoring interval

Test procedure described in ANSI C63.17, clause 8.4.

This test is required if the EUT implements the provision of FCC 15.323(c)(11).

Test Result:

Not tested. The tested EUT does not implement this provision. See manufacturer's declaration.

9.23 Spurious Emissions (Radiated)

Measurement Procedure:

FCC 15.209, FCC 15.109

Test Result:

Tests for intentional radiators according to FCC 15.209 are not required when Out-of-Band Emission was tested conducted with a pass result.

Measurement Data:

See plots.

Requirement: FCC 15.109(b)

30 – 88 MHz:	90 $\mu\text{V/m}$
88 – 216 MHz:	150 $\mu\text{V/m}$
216 – 960 MHz:	210 $\mu\text{V/m}$
960 – 1000 MHz:	300 $\mu\text{V/m}$

Common Information

EUT: BL-ANT-1010-19G (S/N:3301002170096)
 Serial number:
 Test description: EN 55032 class A
 Operating condition: data transfer
 Operator name: Kraus
 Comment: 230V /50Hz ETH shielded (DECT notched)

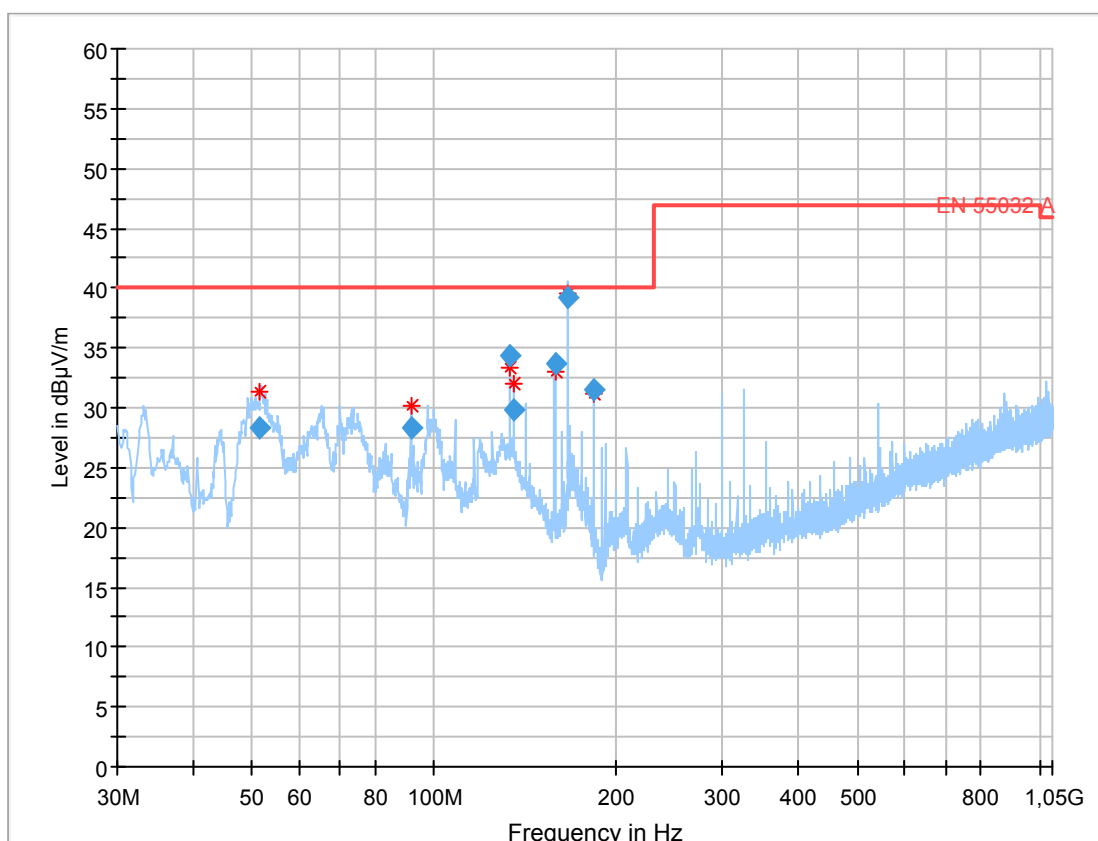

Final Result

Frequency (MHz)	QuasiPeak (dBµV/m)	Limit (dBµV/m)	Margin (dB)	Meas. Time (ms)	Bandwidth (kHz)	Height (cm)	Pol	Azimuth (deg)	Corr. (dB)
51.375300	28.37	40.00	11.63	1000.0	120.000	100.0	V	4.0	13.6
91.666200	28.26	40.00	11.74	1000.0	120.000	103.0	V	290.0	9.8
133.348500	34.41	40.00	5.59	1000.0	120.000	98.0	V	160.0	9.3
135.622800	29.75	40.00	10.25	1000.0	120.000	98.0	V	110.0	9.2
158.334900	33.61	40.00	6.39	1000.0	120.000	98.0	V	-18.0	9.6
166.666800	39.28	40.00	0.72	1000.0	120.000	98.0	V	251.0	10.1
183.333000	31.44	40.00	8.56	1000.0	120.000	98.0	V	200.0	11.1

Common Information

EUT: BL-ANT-1010-19G (S/N:3301002170096)
 Serial number:
 Test description: EN 55032 class A
 Operating condition: data transfer
 Operator name: Kraus
 Comment: 230V /50Hz ETH shielded (DECT notched)

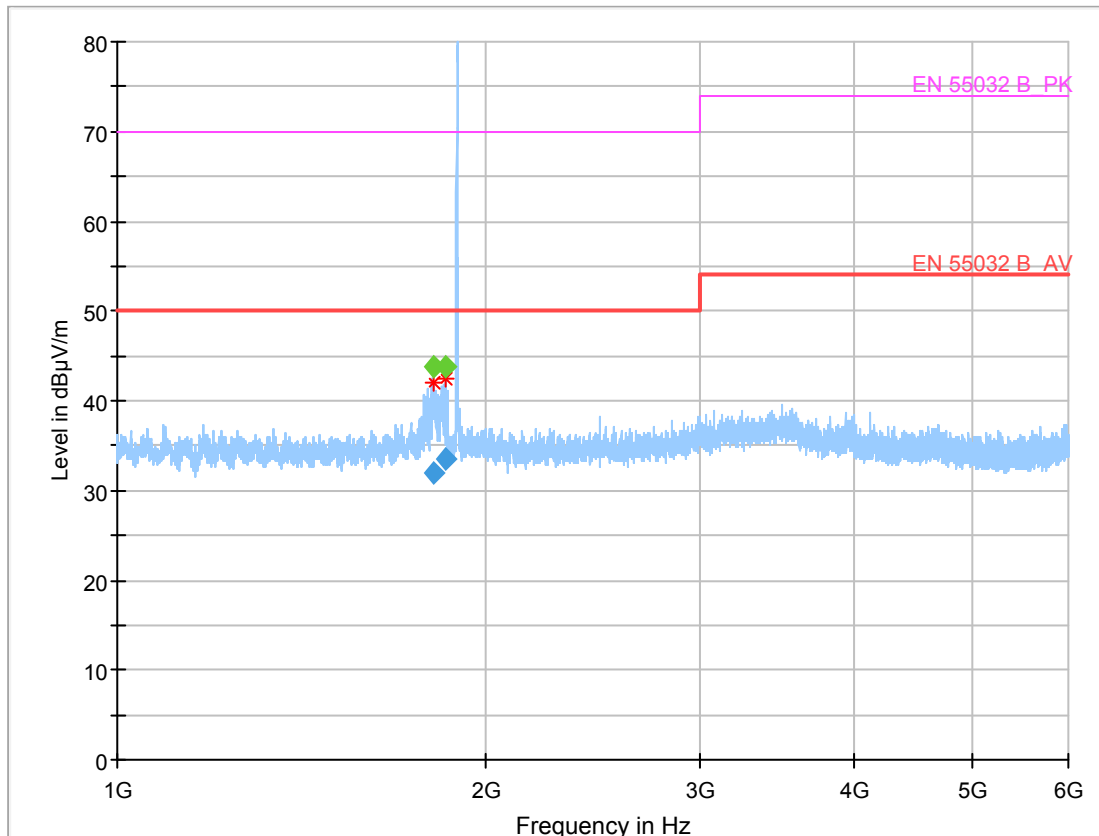

Final Result

Frequency (MHz)	Average (dBµV/m)	MaxPeak (dBµV/m)	Limit (dBµV/m)	Margi n (dB)	Meas. Time (ms)	Bandwidt h (kHz)	Height (cm)	Pol	Azimuth (deg)	Corr. (dB)
1817.923000	---	43.75	70.00	26.25	1000.	1000.000	100.0	V	217.0	-2.8
1817.923000	31.93	---	50.00	18.07	1000.	1000.000	100.0	V	217.0	-2.8
1859.057000	---	43.83	70.00	26.17	1000.	1000.000	100.0	V	329.0	-2.7
1859.057000	33.41	---	50.00	16.59	1000.	1000.000	100.0	V	329.0	-2.7

Peak at 1.924 GHz was caused by the intentional radiation of EUT.

The radiated spurious emission of the unintentional radiator is below the indicated limit.

9.24 Receiver Spurious Emissions

Measurement Procedure:

Industry Canada RSS-213 paragraph 6.8 and RSS-GEN paragraphs 4.8 and 6.

Test results:

Frequency MHz	Carrier No.	Measured Value Conducted dBm	Conducted Limit dBm	Margin dB
30 - 1000	all	-71.6	-57	14.6
> 1000	all	-71.0	-53	18.0

Requirements: RSS-GEN Issue 2, clause 6

The measurement can be performed either radiated or conducted.

When measured conducted: No spurious signals appearing at the antenna terminals shall exceed 2 nW per any 4 kHz spurious frequency in the band 30-1000 MHz, or 5 nW above 1 GHz.

When measured radiated: See table 1 in RSS-GEN Issue2, clause 6.

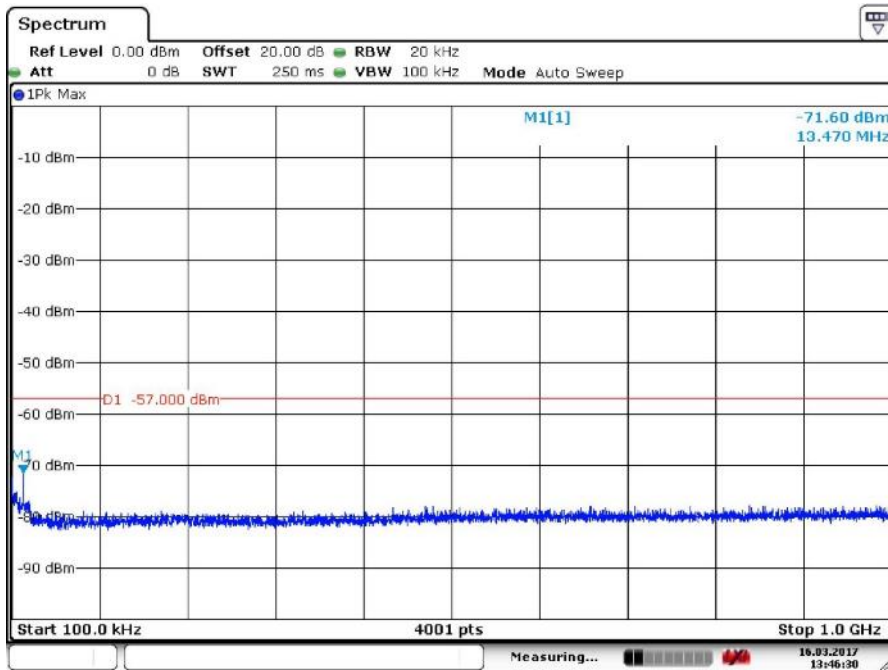

Receiver Spurious Emissions, Conducted, 100 kHz – 1 GHz

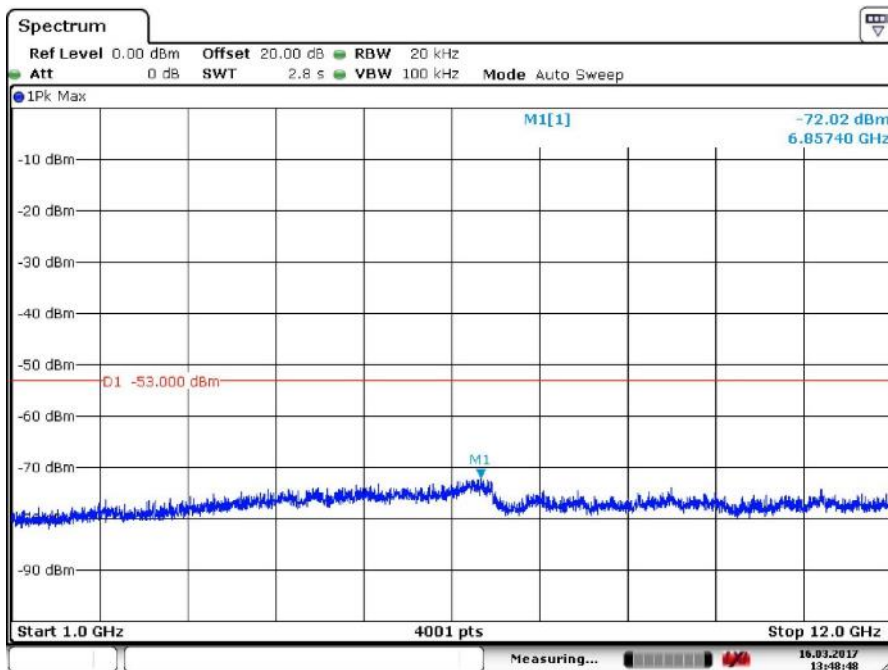

Receiver Spurious Emissions, Conducted, 1 GHz – 12 GHz

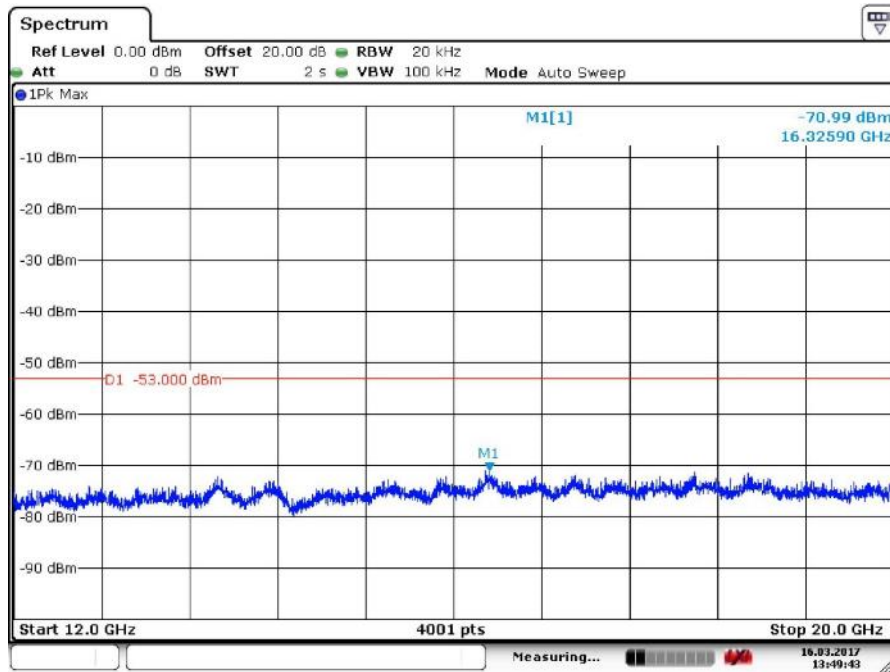

Receiver Spurious Emissions, Conducted, 12 GHz – 20 GHz

10 Test equipment and ancillaries used for tests

To simplify the identification of the test equipment and/or ancillaries which were used, the reporting of the relevant test cases only refer to the test item number as specified in the table below.

No.	Instrument/Ancillary	Manufacturer	Type	Serial-No.	Internal identification
Power Line Conducted Emission					
G-1	EMI Receiver	Agilent	MXE (N9038A)	MY51210197	300004405
G-2	V-ISN	Rohde & Schwarz	ESH 3-Z5	892475/017	300002209
G-2a	V-ISN	Rohde & Schwarz	ESH 2-Z5	892602/024	300000587
G-3	2-Wire ISN	Schaffner	ISN T200	19075	300003422
G-4	4-Wire ISN	Schaffner	ISN T400	22325	300003423
G-5	Shielded wire ISN	Schaffner	ISN ST08	22583	300003433
G-6	Unshielded 8 wire ISN	Teseq	ISN T800	26113	300003833
G-7	Unshielded 8 wire ISN	Teseq	ISN T8-Cat. 6	26374	300003851
G-8	RF Current probe	FCC	F-33-4	46	300003257
G-9	V-ISN	Schaffner	ISN PLC-150	21579	300003318
G-10	V-ISN	Schaffner	ISN PLC-25-30	21584	300003319
G 10a	PLC Filter	TESEQ	Filter PLC	23436	300003598
G 10b	Coupling unit 75 Ohm	Fiedler	AC	----	300003272.0 4
Conducted					
L-1	Spectrum Analyzer	R&S	FSV30	100763	300003950
L-2	Signal Generator	R&S	SMBV100A	257858	300004529
L-3	Oscilloscope	R&S	RTO1044	30084	300004615
L-4	Signaling Unit	R&S	CMD 65	847527/005	300003611
L-5	Combiner	R&S	1025.3400.02	- / -	- / -
L-6	Combiner	Suhner	4901.19A	- / -	- / -
L-7	Combiner	Weinschel	1515	KW438	- / -
L-8	Detector	Hewlett Packard	HP 8473C	03690	- / -
L-9	Attenuator	Narda	4779-50	9101	- / -
L-10	Attenuator	Narda	4779-30	9305	- / -
L-11	Attenuator	Narda	4779-20	9310	- / -
L-12	Control PC	F+W	- / -	FW0712052	300003735

No.	Instrument/Ancillary	Manufacturer	Type	Serial-No.	Internal identification
Radiated emission in chamber F					
F-1	Control Computer	F+W		FW0502032	300003303
F-2	Trilog-Antenna	Schwarzbeck	VULB 9163	9163-295	300003787
F-3a	Amplifier	Veritech Microwave Inc.	0518C-138	- / -	- / -
F-4b	Switch	Netgear	GS108P	26V12A3H50336	300000368
F-5	EMI Test receiver	R&S	ESCI	100083	300003312
F-6	Turntable Interface-Box	EMCO / ETS-LINDGREN	Model 105637	44583	300003747
F-7	Tower/Turntable Controller	EMCO / ETS-LINDGREN	Model 2090	64672	300003746
F-8	Tower	EMCO / ETS-LINDGREN	Model 2175	64762	300003745
Radiated emission in chamber F > 1GHz					
F-29	Horn antenna	Schwarzbeck	BBHA 9120 B	188	300003896
F-30	Amplifier	ProNova	0518C-138	005	F 024
F-31	Amplifier	Miteq	42-00502650-28-5A	1103782	300003379
F-32	Horn antenna	Emco	3115	9709-5289	300000213
F-33	Spectrum Analyzer	R&S	FSU26	200809	300003874
F-34	Loop antenna	EMCO	6502	8905-2342	300000256

11 Observations

No observations exceeding those reported with the single test cases have been made.

Annex D: Document History

Version	Applied Changes	Date of Release

Annex E: Further Information

Glossary

DUT	-	Device under Test
EMC	-	Electromagnetic Compatibility
EUT	-	Equipment under Test
FCC	-	Federal Communication Commission
FCC ID	-	Company Identifier at FCC
HW	-	Hardware
IC	-	Industry Canada
Inv. No.	-	Inventory number
N/A	-	not applicable
S/N	-	Serial Number
SW	-	Software

Annex F: Safety exposure levels

Prediction of MPE limit at a given distance:

Equation from page 18 of OET Bulletin 65, Edition 97-01

$$S = PG / 4\pi R^2$$

where: S = Power density
 P = Power input to the antenna
 G = Antenna gain
 R = Distance to the center of radiation of the antenna

The table below is excerpted from Table 1B of 47 CFR 1.1310 titled "Limits for Maximum Permissible Exposure (MPE), Limits for General Population/Uncontrolled Exposure"

Frequency Range (MHz)	Power Density (mW/cm ²)	Averaging Time (minutes)
300 -1500	f/1500	30
1500 - 100000	1.0	30

where f = Frequency (MHz)

Prediction:

P	Max power input to the antenna:	15.34 dBm
P	Max power input to the antenna:	34.2 mW
R	Distance:	20 cm
G	Maximum antenna gain:	3.00 dBi
G	Maximum antenna gain:	2.0 numeric
S	MPE limit for uncontrolled exposure:	1 mW/cm ²

Calculated Power density:	0.0136 mW/cm²
	0.136 W/m²

This prediction demonstrates the following:

The power density levels at a distance of 20 cm are below the maximum levels allowed by FCC regulations

Annex G: Accreditation Certificate



Deutsche Akkreditierungsstelle GmbH

Bellehene gemäß § 8 Absatz 1 AkkStelleG i.V.m. § 1 Absatz 1 AkkStelleGBV
 Unterzeichnerin der Multilateralen Abkommen
 von EA, ILAC und IAF zur gegenseitigen Anerkennung

Akkreditierung 

Die Deutsche Akkreditierungsstelle GmbH bestätigt hiermit, dass das Prüflaboratorium

CTC advanced GmbH
 Untertürkheimer Straße 6-10, 66117 Saarbrücken

die Kompetenz nach DIN EN ISO/IEC 17025:2005 besitzt, Prüfungen in folgenden Bereichen durchzuführen:

- Funk
- Mobilfunk (GSM / DCS) + OTA
- Elektromagnetische Verträglichkeit (EMV)
- Produktsicherheit
- SAR / EMF
- Umwelt
- Smart Card Technology
- Bluetooth®
- Automotive
- Wi-Fi Services
- Kanadische Anforderungen
- US-Anforderungen
- Akustik
- Near Field Communication (NFC)

Die Akkreditierungsurkunde gilt nur in Verbindung mit dem Bescheid vom 25.11.2016 mit der Akkreditierungsnummer D-PL-12076-01 und ist gültig bis 17.01.2018. Sie besteht aus diesem Deckblatt, der Rückseite des Deckblatts und der folgenden Anlage mit insgesamt 63 Seiten.

Registrierungsnummer der Urkunde: **D-PL-12076-01-01**

Frankfurt, 25.11.2016

 im Auftrag Dipl.-Ing. Jörg Rolf Egnor
 Abteilungsleiter

Siehe Hinweiszettel auf der Rückseite

Front side of the certificate

Deutsche Akkreditierungsstelle GmbH

Standort Berlin
 Spittelmarkt 10
 10117 Berlin

Standort Frankfurt am Main
 Europa-Allee 52
 60327 Frankfurt am Main

Standort Braunschweig
 Bundesallee 100
 38116 Braunschweig

Die auszugsweise Veröffentlichung der Akkreditierungsurkunde bedarf der vorherigen schriftlichen Zustimmung der Deutsche Akkreditierungsstelle GmbH (DAkkS). Ausgenommen davon ist die separate Weiterverbreitung des Deckblattes durch die umseitig genannte Konformitätsbewertungsstelle in unveränderter Form.

Es darf nicht der Anschein erweckt werden, dass sich die Akkreditierung auch auf Bereiche erstreckt, die über den durch die DAkkS bestätigten Akkreditierungsbereich hinausgehen.

Die Akkreditierung erfolgte gemäß des Gesetzes über die Akkreditierungsstelle (AkkStelleG) vom 31. Juli 2009 (BGBl. I S. 2625) sowie der Verordnung (EG) Nr. 765/2008 des Europäischen Parlaments und des Rates vom 9. Juli 2008 über die Vorschriften für die Akkreditierung und Marktüberwachung im Zusammenhang mit der Vermarktung von Produkten (Abt. L 218 vom 9. Juli 2008, S. 30). Die DAkkS ist Unterzeichnerin der Multilateralen Abkommen zur gegenseitigen Anerkennung der European co-operation for Accreditation (EA), des International Accreditation Forum (IAF) und der International Laboratory Accreditation Cooperation (ILAC). Die Unterzeichner dieser Abkommen erkennen ihre Akkreditierungen gegenseitig an.

Der aktuelle Stand der Mitgliedschaft kann folgenden Webseiten entnommen werden:
 EA: www.european-accreditation.org
 ILAC: www.ilac.org
 IAF: www.iaf.nu

Back side of the certificate

Note: The current certificate including annex is published on our website or may be received from CTC advanced GmbH on request