

Appendix 5

Prüfbericht - Nr.:
Test Report No.:

14036325 001

Seite 6 von 16
Page 6 of 16

User manual



Turbo Fire Sun Charger

160108
160109

- D** Montage- und Betriebsanleitung
- GB USA** Assembly and operating instructions
- F** Instructions de montage et d'utilisation
- E** Instrucciones de montaje y de servicio
- I** Istruzioni per il montaggio e l'uso
- NL** Montage- en gebruiksaanwijzing
- P** Instruções de montagem e modo de utilização
- S** Monterings- och bruksanvisning
- FIN** Asennus- ja käyttöohje
- PL** Instrukcja montażu i obsługi
- H** Szerelési és használati utasítás
- SLO** Navodila za montažo in uporabo
- CZ** Návod k montáži a obsluze
- N** Montajse- og bruksanvisning
- DK** Monterings- og driftsvejledning
- GR** Οδηγίες συναρμολόγησης και λειτουργίας
- RC** 安裝和使用說明
- J** 取扱説明書取扱説明書の内容は予
- ROK** 조립과 작동 방법
- Arabic** إرشادات التركيب و الاستخدام
- TR** Montaj ve işletme kılavuzu
- RUS** Инструкция по монтажу и эксплуатации

RC Power
carrera-rc.com
Made in China, Huizhou

Appendix 5

Prüfbericht - Nr.:
Test Report No.:

14036325 001

Seite 7 von 16
Page 7 of 16

1 *Nur ein Modell enthalten. Contains only one model. contient un seul modèle. Contiene sólo un modelo. Contiene un solo modello. Bivai dechitobē model/Contiene sī un aminiatur. Endstær modell. Štábilba veiv yčtēn radi-ohjātsma. Zawiera tylko jedn model. Ciek egy modellt tartalmaz. Vkljate isamo en model/Obsahuj pouze jeden model. Innehodker kun sime model. Innehodker kun en model. Pripadgera juvo ena juortilo. 含一个模型。モデルは1体のみ入っています。포함된 기기는 하나입니다. لا يحتوي إلا على موديل واحد فقط. Sadece tek model dahildir. Boleš ena vsebine vsega izdelka. 1個のモデルのみです。

**1x 3,7 V
600 mAh
2,22Wh!**

2x AAA Battery

2

3

**3,7 V
600 mAh
2,22Wh!**

O.K.

~~NO AAA (LR3/R3P)
or AA (LR6,R6P) BATTERIES!~~

4

**3,7 V
600 mAh
2,22Wh!**

5

2x AAA Battery

6

OFF ON

7

ON OFF

Appendix 5

Prüfbericht - Nr.:
Test Report No.:

14036325 001

Seite 8 von 16
Page 8 of 16

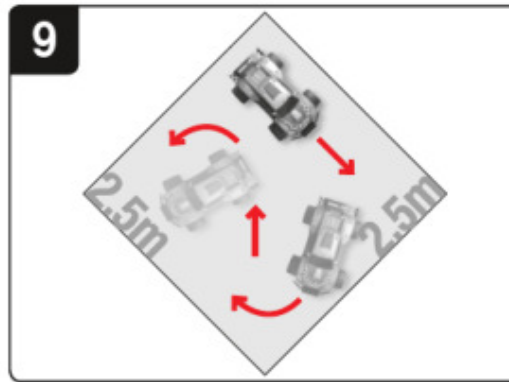

Sicherheitsbestimmungen · Safety instructions · Consignes de sécurité
Disposiciones de seguridad · Norme di sicurezza · Veiligheidsbepalingen
Prescrições de segurança · Säkerhetsbestämmelser · Turvallisuusohjeet
Zasady bezpieczeñstwa · Biztonsági rendelkezések · Varnostna določila
Bezpečnostní předpisy · Sikkerhetsbestemmelser · Sikkerhedsbestemmelser
Διατάξεις ασφαλείας · 安全准则 · 安全規定 · 안전수칙 · أنظمة السلامة
Emniyet kaideleri · Правила техники безопасности

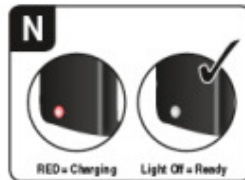
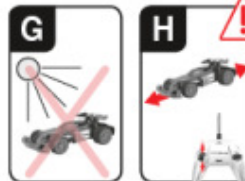
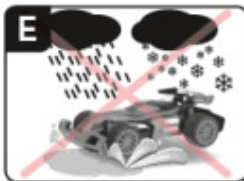
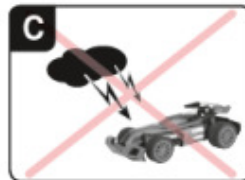

Appendix 5

Prüfbericht - Nr.:
Test Report No.:

14036325 001

Seite 9 von 16
Page 9 of 16

Dear customer

Congratulations on purchasing a Carrera RC model car, manufactured in accordance with the latest technology. As it is our constant endeavour to develop and improve our products, we reserve the right to make modifications, either of a technical nature or with respect to features, materials, and design, at any time, and without prior notice. For this reason, no claims will be accepted for any slight deviations in your product from the data and illustrations contained in these instructions. These operating and assembly instructions are an integral part of the product. Non-observance of these operating instructions and the safety instructions they contain will render the guarantee null and void. These instructions are to be kept for future reference and in the event that the product is passed on to a third party.

Guarantee conditions

A Carrera product is built to high technical standards and is to be treated with care. Please ensure that you observe all the instructions contained in this guide. All components have been subjected to careful inspection (technical modifications and alterations to the model for the purpose of product improvement are reserved).

Should any faults nevertheless occur, guarantee is assumed within the scope of the following conditions:

The guarantee covers demonstrable material or manufacturing defects that existed at the time that the Carrera product was purchased. The guarantee period is 24 months beginning with the date of purchase. The guarantee does not extend to wearing parts (such as Carrera RC rechargeable batteries, antennas, tyres, gearbox components etc.), damage caused by improper treatment or use, or unauthorised intervention. Repair may only be performed by Stadlbauer Marketing + Vertrieb GmbH itself or by a company it has authorised to do so. Within the scope of this guarantee, either the product as a whole or only the defective components will be replaced or equivalent substitution performed, as deemed appropriate by Stadlbauer Marketing + Vertrieb GmbH. The guarantee does not cover transport, packaging or travel costs or any damage for which the buyer is responsible. These costs are to be covered by the buyer. Guarantee claims will only be accepted from the original purchaser of the Carrera product.

Guarantee claims can only be accepted when:

- The card has been filled in properly and sent in together with the defective Carrera product and the purchase receipt/invoice/cash-register receipt.
- No unauthorised alterations have been made by the buyer to the guarantee card.
- The toy has been treated in accordance with the operating instructions and subjected to its intended use.
- The damage/faulty operation is not due to acts of God or normal wear and tear.

Guarantee cards cannot be replaced.

Note for EU countries: Reference is hereby made to the seller's statutory guarantee obligation, to the extent that this guarantee obligation is not restricted by the product guarantee.

Declaration of conformity

Stadlbauer Marketing + Vertrieb GmbH hereby declares that this model including the controller conforms with the fundamental requirements of the following EC directives: EC Directives 2009/48 and 2004/108/EC regarding electromagnetic compatibility and the other relevant regulations of Directive 1999/5/EC (R&TTE). The original declaration of conformity can be requested from carrera-rc.com.

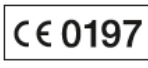

Warning!



WARNING! This toy contains small parts which can be swallowed and is therefore not suitable for children under 3 years of age.

WARNING! danger of pinching during operation! Remove all packaging materials and wire fastenings before handing the toy over to the child. Please retain the packaging and address for information and in the event of any questions.



This symbol, showing refuse bins with a cross through them, denotes that empty batteries, rechargeable batteries, button cells, rechargeable battery packs, equipment batteries, disused electrical equipment, etc. should not be disposed of in domestic refuse, as they are harmful to the environment and health. Please help to preserve environment and health and talk to your children about the correct disposal of used batteries and disused electrical equipment. Batteries and disused electrical equipment should be handed in to the usual collection points where they can be properly recycled. Do not mix dissimilar battery types or employ new and used batteries together. Empty batteries should be removed from the product. Do not attempt to recharge non-rechargeable batteries. Rechargeable batteries are only to be charged by adults. Exhausted batteries are to be removed from the toy. Rechargeable batteries should be removed from the product before charging. Supply terminals are not to be short-circuited. Only use the batteries recommended or equivalent types. If in regular use the charger must be examined for damage to the cord, plug, covers and all other parts. If any signs of damage are found the charger may only be used again after repair work has been completed.

Requirement for FCC Part 15

Warning: Changes or modifications not expressly approved by the party responsible for compliance could void the user's authority to operate the equipment.

Note: This equipment has been tested and found to comply with the limits for a Class B digital device, pursuant to Part 15 of the FCC Rules. These limits are designed to provide reasonable protection against harmful interference in a residential installation. This equipment generates, uses and can radiate radio frequency energy and, if not installed and used in accordance with the instructions, may cause harmful interference to radio communications.

However, there is no guarantee that interference will not occur in a particular installation. If this equipment does cause harmful interference to radio or television reception, which can be determined by turning the equipment off and on, the user is encouraged to try to correct the interference by one or more of the following measures:

- Reorient or relocate the receiving antenna.
- Increase the separation between the equipment and receiver.
- Connect the equipment into an outlet on a circuit different from that to which the receiver is connected.
- Consult the dealer or an experienced radio/TV technician for help.

Safety instructions

A A Carrera RC vehicle is a remote-controlled model car that uses special rechargeable batteries for this purpose. Only original Carrera RC Li-Ion rechargeable batteries may be used. Rechargeable batteries are to be removed from the toy before being charged.

B The Carrera RC vehicle is designed for hobby use only and may only be operated on tracks and in spaces especially intended for this purpose. **WARNING!** Do not use the Carrera RC vehicle in road traffic.

C Do not operate the car beneath overhead high-voltage cables or broadcasting masts or during a storm! Atmospheric disturbances can affect the operation of the vehicle. When there a large temperature differences between your car's garage and the running track, please wait until the vehicle has had time to acclimatise. This will help prevent condensation forming and the possibility of malfunctions resulting.

D Never operate the product on grass surfaces. There is the risk of grass hindering the movement of the axles, which can lead to the motor overheating. Do not use the Carrera RC vehicle for transporting goods, persons or animals.

E Never use the Carrera RC vehicle outdoors during rain or snowfall. The car must not be run through water, puddles and snow, and must always be kept stored in a dry place.

F Never operate the vehicle near rivers, ponds or lakes, to avoid the risk of the Carrera RC car falling into the water. Avoid running on courses which are laid exclusively with sand.

G Do not expose the Carrera RC vehicle to direct sunlight. To avoid the electronics in the car overheating, when temperatures are above 35°C, regular short pauses in operation are essential.

H Never subject the Carrera car to repeated changes of load – that means continuously reversing it.

I Always place the car on the floor by hand. Never throw the car on the floor from a standing position.

K Avoid jumping from jumps or ramps higher than 15 cm (0.49 ft.).

L Handle the tip of the antenna with care. Danger of injury!

M Never use strong solvents for cleaning the car.

N To avoid malfunctions to the control system resulting in uncontrolled operation of the Carrera RC vehicle, check that the controller batteries and the rechargeable batteries in the vehicle have sufficient charge. Supply terminals are not to be short-circuited.

O The Carrera RC vehicle must be inspected before and after operation, each time it is used, to ensure that it has not become disassembled. Any screws or nuts that may have become loosened during operation must be tightened.

Appendix 5

Prüfbericht - Nr.:
Test Report No.:

14036325 001

Seite 10 von 16
Page 10 of 16

Contents of package

- 1**
- 1x Carrera RC Vehicle
 - 1x Controller
 - 1x Battery Charger
 - 1x Rechargeable Battery
 - 1x Antenna
 - 2x 1.5V Micro AAA batteries (non-rechargeable)

Mounting the antenna

- 2**
- Push the antenna cable through the antenna tube and then mount this to the Carrera RC vehicle. Secure the end of the antenna cable with a Carrera RC sticker from the logo sheet.

Charging the rechargeable battery

- 3**
- Place the Carrera RC rechargeable battery in the Carrera RC charging unit supplied. Ensure the polarity is correct. Make sure you only use the Carrera RC charger unit to charge the 3.7V Li-Ion battery supplied.

WARNING! If you try to charge any other rechargeable battery or any primary cells such as AA (LR6, R6P) or AAA (LR3, R3P) batteries with the Carrera RC charger unit, this may cause serious damage.

Connect the charger to a power source.

When the battery is put in place correctly and charging is proceeding normally, the little red LED lamp will be lit constantly. Once the battery is fully charged, the LED will no longer be lit. The battery can now be disconnected and installed in the Carrera RC car. The car is now ready for use. After use, the battery must be allowed to cool down for at least 20 minutes before it can be fully recharged. Failure to observe this pause may damage the battery.

Always recharge the battery immediately after use to prevent its becoming deep discharged. Recharge the battery occasionally (suggested every 2-3 months). Failure to treat the battery as described above can lead to its becoming defective.

Rechargeable batteries are only to be charged by adults.

Installing the rechargeable battery

- 4**
- Using a screwdriver, remove the cover of the battery compartment in the Carrera RC car. Place the Carrera RC battery in the vehicle. Ensure the polarity is correct. Replace the compartment cover using a screwdriver.

Inserting the batteries

- 5**
- Open the battery compartment with a screwdriver and insert the batteries in the remote control. Ensure the polarity is correct. Replace the compartment cover using a screwdriver.

Now you can drive the car

- 6**
- Make sure that nobody in your vicinity is using the same frequency.
- Pull out the antenna of the controller to its full extent.
- 7**
- Switch on the Carrera RC car using the ON/OFF switch.
- 8**
- Adjusting the steering**
If the Carrera RC vehicle is found to pull towards the left or right while moving, use the adjuster control shown in the illustration to adjust the car's track precision.

Let's practise!

- 9**
- Warning!** This vehicle reaches high speeds! Practice on an empty surface at least 2.5 metres (8.2) square. When first starting, be very careful when operating the gas pedal.

- 10**
- Now it's time to practise! Set up a Carrera RC vehicle racing track in a large empty area, using cones, empty cans, or similar objects. The basic technique to adopt when operating a Carrera RC is to drive fast on the straight sections and to slow down in the curves.

- When changing from the first battery to the second battery, you must stop running for at least ten minutes. At the next change, a pause of at least 20 minutes is absolutely essential.
- Avoid constant motor operation.
- If the car switches itself off several times one after another, the battery is dead. Please recharge the battery.
- To switch off after use, follow the steps in the reverse order.
- **After use, remove or disconnect the battery. Always recharge the battery immediately after use to prevent its becoming deep discharged.**
- Always keep the rechargeable battery stored outside the vehicle.
- Clean the Carrera RC car after use.

Controller functions

- 11**
- Full Function**
You can steer the car in any direction using the joysticks:
Joystick on left: forward/backwards
Joystick on right: left/right
- 12**
- The LED on the controller lights as soon as you move one of the two joysticks up or down, left or right.
- 13**
- If you do not touch one of the joysticks, the LED is not lit, irrespective of whether the ON/OFF switch is set to ON or OFF.

Troubleshooting

- Problem**
Car does not move.
- Cause:** Either the switch on the controller or the car is set to OFF.
Solution: Switch on
- Cause:** There is no rechargeable battery in the car or the battery is too weak.
Solution: Insert charged battery
- Cause:** The car has come to a stop at an obstacle.
Solution: The voltage surge protector has switched the car off. Turn the ON/OFF switch on the car to OFF, then back to ON, and place the car on a clear surface.

- Cause:** The battery or rechargeable battery in the transmitter or model is too weak.
Solution: Insert new battery or recharged battery.

- Cause:** When it was last used, the model was not switched off, and the battery is discharged.
Solution: Please recharge the battery.

- Cause:** The vehicle is very warm.
Solution: Switch both car and controller off and allow the car to cool down for about 30 minutes.

- Problem**
Car cannot be controlled.
- Cause:** Vehicle starts moving unintentionally.
Solution: First turn on the transmitter, only then the vehicle.

- Cause:** Transmitter antenna is defective.
Solution: Extend the antenna fully.

For the latest version of these operating instructions and information on replacement and spare parts available, please visit carrera-rc.com in the service area.

Errors and changes excepted
Colours / final design - changes excepted
Technical changes and design-related changes excepted
Pictograms = symbolic photos

Appendix 5

Prüfbericht - Nr.:
Test Report No.:

14036325 001

Seite 11 von 16
Page 11 of 16



Fire Wheeler
Green Dasher
Blue Speeder

#160110
#160111
#160112

- D** Montage- und Betriebsanleitung
- GB USA** Assembly and operating instructions
- F** Instructions de montage et d'utilisation
- E** Instrucciones de montaje y de servicio
- I** Istruzioni per il montaggio e l'uso
- NL** Montage- en gebruiksaanwijzing
- P** Instruções de montagem e modo de utilização
- S** Monterings- och bruksanvisning
- FIN** Asennus- ja käyttöohje
- PL** Instrukcja montażu i obsługi
- H** Szerelési és használati utasítás
- SLO** Navodila za montažo in uporabo
- CZ** Návod k montáži a obsluze
- N** Montajse- og bruksanvisning
- DK** Monterings- og driftsvejledning
- GR** Οδηγίες συναρμολόγησης και λειτουργίας
- RC** 安装和使用说明
- J** 取扱説明書取扱説明書の内容は予
- ROK** 조립과 작동 방법
- Arabic** إرشادات التركيب و الاستخدام
- TR** Montaj ve işletme kılavuzu
- RUS** Инструкция по монтажу и эксплуатации

RC Power
carrera-rc.com
Made in China, Huizhou

Appendix 5

Prüfbericht - Nr.:
Test Report No.:

14036325 001

Seite 12 von 16
Page 12 of 16

1 *Nar eh Modelienhalten - Contains only one model - contient un seul modèle - Contiene sólo un modelo - Contiene as solo modello - Berat slechts één model/Contiene só um a miniatura - Endast en modell - Sisältää vain yhden radio-ohjattavan - Zawiera tylko jeden model - Csak egy modell tartalmaz - Vrijeds rasamo en model/Obsahuj pouze jeden model - Innehåller kun en modell - Innehåller kunin modell - Περιέχει ένα μονο μοντέλο - 含一个模型 - モデルは1体のみ入っています - 오직 한 개만 들어있음 - يحتوي على نموذج واحد فقط - Sadece tek model/dahildir - Бөтөнөөчтөсүз берген тикке кыраапсыз.



1x 3,7 V
600 mA^H
2,22Wh!

2x AAA Battery

2



3



3,7 V
600 mA^H
2,22Wh!

✓ O.K.

~~NO AAA (LR3/R3P)
or AA (LR6,R6P) BATTERIES!~~

4

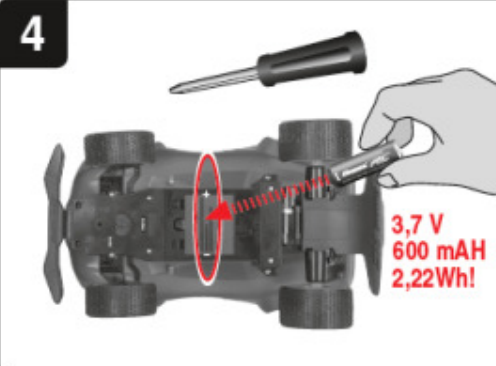

3,7 V
600 mA^H
2,22Wh!

5



2x AAA Battery

6



OFF ON

7



ON OFF



Appendix 5

Prüfbericht - Nr.:
Test Report No.:

14036325 001

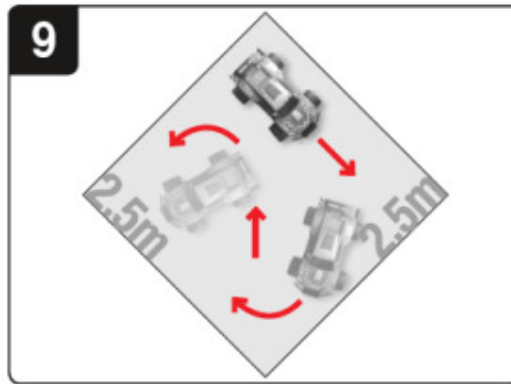
Seite 13 von 16
Page 13 of 16



Sicherheitsbestimmungen · Safety instructions · Consignes de sécurité
Disposiciones de seguridad · Norme di sicurezza · Veiligheidsbepalingen
Prescrições de segurança · S kerhetsbest mmelser · Turvallisuusohjeet
Zasady bezpiecze stwa · Biztons gi rendelkez sek · Varnostna dolo ila
Bezpe nostni p edpisy · Sikkerhetsbestemmelser · Sikkerhedsbestemmelser
Διατάξεις ασφαλείας · 安全准則 · 安全規定 · 안전수칙 · أنظمة السلامة
Emniyet kaideleri · Правила техники безопасности

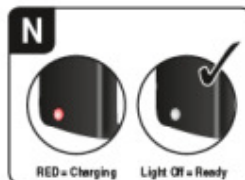
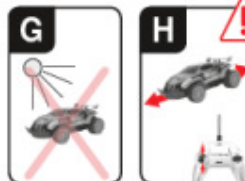
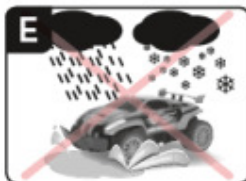

Appendix 5

Prüfbericht - Nr.:
Test Report No.:

14036325 001

Seite 14 von 16
Page 14 of 16

Dear customer

Congratulations on purchasing a Carrera RC model car, manufactured in accordance with the latest technology. As it is our constant endeavour to develop and improve our products, we reserve the right to make modifications, either of a technical nature or with respect to features, materials, and design, at any time, and without prior notice. For this reason, no claims will be accepted for any slight deviations in your product from the data and illustrations contained in these instructions. These operating and assembly instructions are an integral part of the product. Non-observance of these operating instructions and the safety instructions they contain will render the guarantee null and void. These instructions are to be kept for future reference and in the event that the product is passed on to a third party.

Guarantee conditions

A Carrera product is built to high technical standards and is to be treated with care. Please ensure that you observe all the instructions contained in this guide. All components have been subjected to careful inspection (technical modifications and alterations to the model for the purpose of product improvement are reserved).

Should any faults nevertheless occur, guarantee is assumed within the scope of the following conditions:

The guarantee covers demonstrable material or manufacturing defects that existed at the time that the Carrera product was purchased. The guarantee period is 24 months beginning with the date of purchase. The guarantee does not extend to wearing parts (such as Carrera RC rechargeable batteries, antennas, tyres, gearbox components etc.), damage caused by improper treatment or use, or unauthorised intervention. Repair may only be performed by Stadlbauer Marketing + Vertrieb GmbH itself or by a company it has authorised to do so. Within the scope of this guarantee, either the product as a whole or only the defective components will be replaced or equivalent substitution performed, as deemed appropriate by Stadlbauer Marketing + Vertrieb GmbH. The guarantee does not cover transport, packaging or travel costs or any damage for which the buyer is responsible. These costs are to be covered by the buyer. Guarantee claims will only be accepted from the original purchaser of the Carrera product.

Guarantee claims can only be accepted when:

- The card has been filled in properly and sent in together with the defective Carrera product and the purchase receipt/invoice/cash-register receipt.
- No unauthorised alterations have been made by the buyer to the guarantee card.
- The toy has been treated in accordance with the operating instructions and subjected to its intended use.
- The damage/faulty operation is not due to acts of God or normal wear and tear.

Guarantee cards cannot be replaced.

Note for EU countries: Reference is hereby made to the seller's statutory guarantee obligation, to the extent that this guarantee obligation is not restricted by the product guarantee.

Declaration of conformity

Stadlbauer Marketing + Vertrieb GmbH hereby declares that this model including the controller conforms with the fundamental requirements of the following EC directives: EC Directives 2009/48 and 2004/108/EC regarding electromagnetic compatibility and the other relevant regulations of Directive 1999/5/EC (R&TTE). The original declaration of conformity can be requested from carrera-rc.com.



CE 0197

Warning!



WARNING! This toy contains small parts which can be swallowed and is therefore not suitable for children under 3 years of age.

WARNING! danger of pinching during operation! Remove all packaging materials and wire fastenings before handing the toy over to the child. Please retain the packaging and address for information and in the event of any questions.



This symbol, showing refuse bins with a cross through them, denotes that empty batteries, rechargeable batteries, button cells, rechargeable battery packs, equipment batteries, disused electrical equipment, etc. should not be disposed of in domestic refuse, as they are harmful to the environment and health. Please help to preserve environment and health and talk to your children about the correct disposal of used batteries and disused electrical equipment. Batteries and disused electrical equipment should be handed in to the usual collection points where they can be properly recycled. Do not mix dissimilar battery types or employ new and used batteries together. Empty batteries should be removed from the product. Do not attempt to recharge non-rechargeable batteries. Rechargeable batteries are only to be charged by adults. Exhausted batteries are to be removed from the toy. Rechargeable batteries should be removed from the product before charging. Supply terminals are not to be short-circuited. Only use the batteries recommended or equivalent types. If in regular use the charger must be examined for damage to the cord, plug, covers and all other parts. If any signs of damage are found the charger may only be used again after repair work has been completed.

Requirement for FCC Part 15

Warning: Changes or modifications not expressly approved by the party responsible for compliance could void the user's authority to operate the equipment.

Note: This equipment has been tested and found to comply with the limits for a Class B digital device, pursuant to Part 15 of the FCC Rules. These limits are designed to provide reasonable protection against harmful interference in a residential installation. This equipment generates, uses and can radiate radio frequency energy and, if not installed and used in accordance with the instructions, may cause harmful interference to radio communications.

However, there is no guarantee that interference will not occur in a particular installation. If this equipment does cause harmful interference to radio or television reception, which can be determined by turning the equipment off and on, the user is encouraged to try to correct the interference by one or more of the following measures:

- Reorient or relocate the receiving antenna.
- Increase the separation between the equipment and receiver.
- Connect the equipment into an outlet on a circuit different from that to which the receiver is connected.
- Consult the dealer or an experienced radio/TV technician for help.

Safety instructions

- A** A Carrera RC vehicle is a remote-controlled model car that uses special rechargeable batteries for this purpose. Only original Carrera RC Li-Ion rechargeable batteries may be used. Rechargeable batteries are to be removed from the toy before being charged.
- B** The Carrera RC vehicle is designed for hobby use only and may only be operated on tracks and in spaces especially intended for this purpose. **WARNING!** Do not use the Carrera RC vehicle in road traffic.
- C** Do not operate the car beneath overhead high-voltage cables or broadcasting masts or during a storm! Atmospheric disturbances can affect the operation of the vehicle. When there is a large temperature difference between your car's garage and the running track, please wait until the vehicle has had time to acclimatise. This will help prevent condensation forming and the possibility of malfunctions resulting.
- D** Never operate the product on grass surfaces. There is the risk of grass hindering the movement of the axles, which can lead to the motor overheating. Do not use the Carrera RC vehicle for transporting goods, persons or animals.
- E** Never use the Carrera RC vehicle outdoors during rain or snowfall. The car must not be run through water, puddles and snow, and must always be kept stored in a dry place.
- F** Never operate the vehicle near rivers, ponds or lakes, to avoid the risk of the Carrera RC car falling into the water. Avoid running on courses which are laid exclusively with sand.
- G** Do not expose the Carrera RC vehicle to direct sunlight. To avoid the electronics in the car overheating, when temperatures are above 35 °C, regular short pauses in operation are essential.
- H** Never subject the Carrera car to repeated changes of load – that means continuously reversing it.
- I** Always place the car on the floor by hand. Never throw the car on the floor from a standing position.
- K** Avoid jumping from jumps or ramps higher than 15 cm (0.49 ft.).
- L** Handle the tip of the antenna with care. Danger of injury!
- M** Never use strong solvents for cleaning the car.
- N** To avoid malfunctions to the control system resulting in uncontrolled operation of the Carrera RC vehicle, check that the controller batteries and the rechargeable batteries in the vehicle have sufficient charge. Supply terminals are not to be short-circuited.
- O** The Carrera RC vehicle must be inspected before and after operation, each time it is used, to ensure that it has not become disassembled. Any screws or nuts that may have become loosened during operation must be tightened.

Appendix 5

Prüfbericht - Nr.:
Test Report No.:

14036325 001

Seite 15 von 16
Page 15 of 16

Contents of package

- 1** 1x Carrera RC Vehicle
1x Controller
1x Battery Charger
1x Rechargeable Battery
1x Antenna
2x 1.5V Micro AAA batteries
(non-rechargeable)

Mounting the antenna

- 2** Push the antenna cable through the antenna tube and then mount this to the Carrera RC vehicle. Secure the end of the antenna cable with a Carrera RC sticker from the logo sheet.

Charging the rechargeable battery

- 3** Place the Carrera RC rechargeable battery in the Carrera RC charging unit supplied. Ensure the polarity is correct. Make sure you only use the Carrera RC charger unit to charge the 3,7V Li-Ion battery supplied.

WARNING! If you try to charge any other rechargeable battery or any primary cells such as AA (LR6, R6P) or AAA (LR3, R3P) batteries with the Carrera RC charger unit, this may cause serious damage.

Connect the charger to a power source. When the battery is put in place correctly and charging is proceeding normally, the little red LED lamp will be lit constantly. Once the battery is fully charged, the LED will no longer be lit. The battery can now be disconnected and installed in the Carrera RC car. The car is now ready for use. After use, the battery must be allowed to cool down for at least 20 minutes before it can be fully recharged. Failure to observe this pause may damage the battery.

Always recharge the battery immediately after use to prevent its becoming deep discharged. Recharge the battery occasionally (suggested every 2-3 months). Failure to treat the battery as described above can lead to its becoming defective.

Rechargeable batteries are only to be charged by adults.

Installing the rechargeable battery

- 4** Using a screwdriver, remove the cover of the battery compartment in the Carrera RC car. Place the Carrera RC battery in the vehicle. Ensure the polarity is correct. Replace the compartment cover using a screwdriver.

Inserting the batteries

- 5** Open the battery compartment with a screwdriver and insert the batteries in the remote control. Ensure the polarity is correct. Replace the compartment cover using a screwdriver.

Now you can drive the car

- 6** Make sure that nobody in your vicinity is using the same frequency.
Pull out the antenna of the controller to its full extent.
- 7** Switch on the Carrera RC car using the ON/OFF switch.
- 8** **Adjusting the steering**
If the Carrera RC vehicle is found to pull towards the left or right while moving, use the adjuster control shown in the illustration to adjust the car's track precision.

Let's practise!

- 9** **Warning!** This vehicle reaches high speeds! Practise on an empty surface at least 2.5 metres (8.2) square. When first starting, be very careful when operating the gas pedal.

- 10** Now it's time to practise! Set up a Carrera RC vehicle racing track in a large empty area, using cones, empty cans, or similar objects. The basic technique to adopt when operating a Carrera RC is to drive fast on the straight sections and to slow down in the curves.

- When changing from the first battery to the second battery, you must stop running for at least ten minutes. At the next change, a pause of at least 20 minutes is absolutely essential.
- Avoid constant motor operation.
- If the car switches itself off several times one after another, the battery is dead. Please recharge the battery.
- To switch off after use, follow the steps in the reverse order.
- **After use, remove or disconnect the battery. Always recharge the battery immediately after use to prevent its becoming deep discharged.**
- Always keep the rechargeable battery stored outside the vehicle.
- Clean the Carrera RC car after use.

Controller functions

- 11** Full Function
You can steer the car in any direction using the joysticks:
Joystick on left: forward/backwards
Joystick on right: left/right
- 12** The LED on the controller lights as soon as you move one of the two joysticks up or down, left or right.
- 13** If you do not touch one of the joysticks, the LED is not lit, irrespective of whether the ON/OFF switch is set at ON or OFF.

Troubleshooting

- Problem**
Car does not move.
- Cause:** Either the switch on the controller or the car is set to OFF.
Solution: Switch on
- Cause:** There is no rechargeable battery in the car or the battery is too weak.
Solution: Insert charged battery
- Cause:** The car has come to a stop at an obstacle.
Solution: The voltage surge protector has switched the car off. Turn the ON/OFF switch on the car to OFF, then back to ON, and place the car on a clear surface.

- Cause:** The battery or rechargeable battery in the transmitter or model is too weak.
Solution: Insert new battery or recharged battery.

- Cause:** When it was last used, the model was not switched off, and the battery is discharged.
Solution: Please recharge the battery.

- Cause:** The vehicle is very warm.
Solution: Switch both car and controller off and allow the car to cool down for about 30 minutes.

- Problem**
Car cannot be controlled.
- Cause:** Vehicle starts moving unintentionally.
Solution: First turn on the transmitter, only then the vehicle.
- Cause:** Transmitter antenna is defective.
Solution: Extend the antenna fully.

For the latest version of these operating instructions and information on replacement and spare parts available, please visit carrera-rc.com in the service area.

Errors and changes excepted
Colours / final design - changes excepted
Technical changes and design-related changes excepted
Pictograms = symbolic photos

Appendix 5

Prüfbericht - Nr.:
Test Report No.:

14036325 001

Seite 16 von 16
Page 16 of 16



NOTE!

Please note:

This device complies with part 15 of the FCC Rules.

Operation is subject to the following two conditions:

- ❶ This device may not cause harmful interference, and
- ❷ this device must accept any interference received, including interference that may cause undesired operation.

CARRERA-RC.COM

032814.1



NOTE!

Please note:

This device complies with part 15 of the FCC Rules.

Operation is subject to the following two conditions:

- ❶ This device may not cause harmful interference, and
- ❷ this device must accept any interference received, including interference that may cause undesired operation.

CARRERA-RC.COM

032814.1



NOTE!

Please note:

This device complies with part 15 of the FCC Rules.

Operation is subject to the following two conditions:

- ❶ This device may not cause harmful interference, and
- ❷ this device must accept any interference received, including interference that may cause undesired operation.

CARRERA-RC.COM

032814.1



NOTE!

Please note:

This device complies with part 15 of the FCC Rules.

Operation is subject to the following two conditions:

- ❶ This device may not cause harmful interference, and
- ❷ this device must accept any interference received, including interference that may cause undesired operation.

CARRERA-RC.COM

032814.1