

1. 规格表:

Specification
370401530

主要技术指标		Main technical specifications	
频率范围 (MHZ)	2400~2500	Frequency Range (MHZ)	2400~2500
特性阻抗(Ω)	50	Impedance(Ω)	50
增益(dBi)	2 \pm 0.5	Gain(dBi)	2 \pm 0.5
输出电压 驻波比	\leq 1.92	VSWR	\leq 1.92
最大功率	10W	Admitted Power	10W
极化方式	垂直极化	Polarization	Linear, Vertical
连接方式	同轴线	Connector Type	RF Cable
物理性能		Physical Properties	
天线本体材料	黄铜	Antenna Base	黄铜
工作温度	-20 $^{\circ}$ C~+65 $^{\circ}$ C	Operating Temp	-20 $^{\circ}$ C~+65 $^{\circ}$ C
保存温度	-30 $^{\circ}$ C~+75 $^{\circ}$ C	Storage Temp	-30 $^{\circ}$ C~+75 $^{\circ}$ C

2. 成品图：

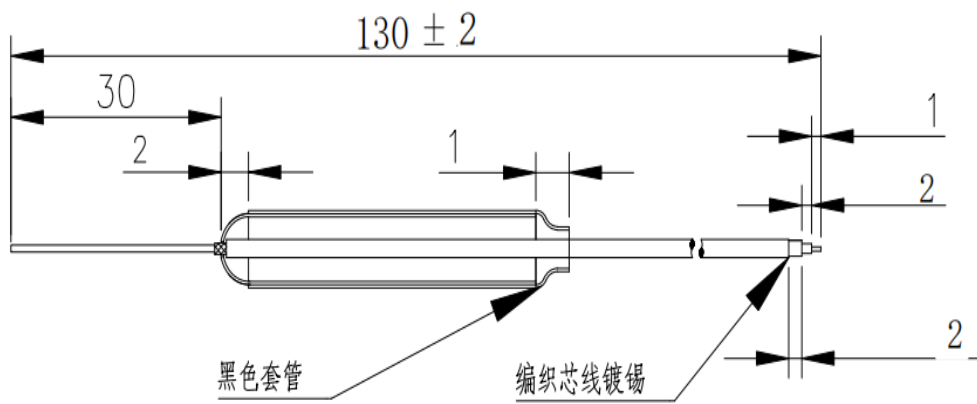

$\Phi 4 \times 23$ 子弹头铜管

600V 24mm

3. 测试报告

3.1: 网络分析仪测试报告

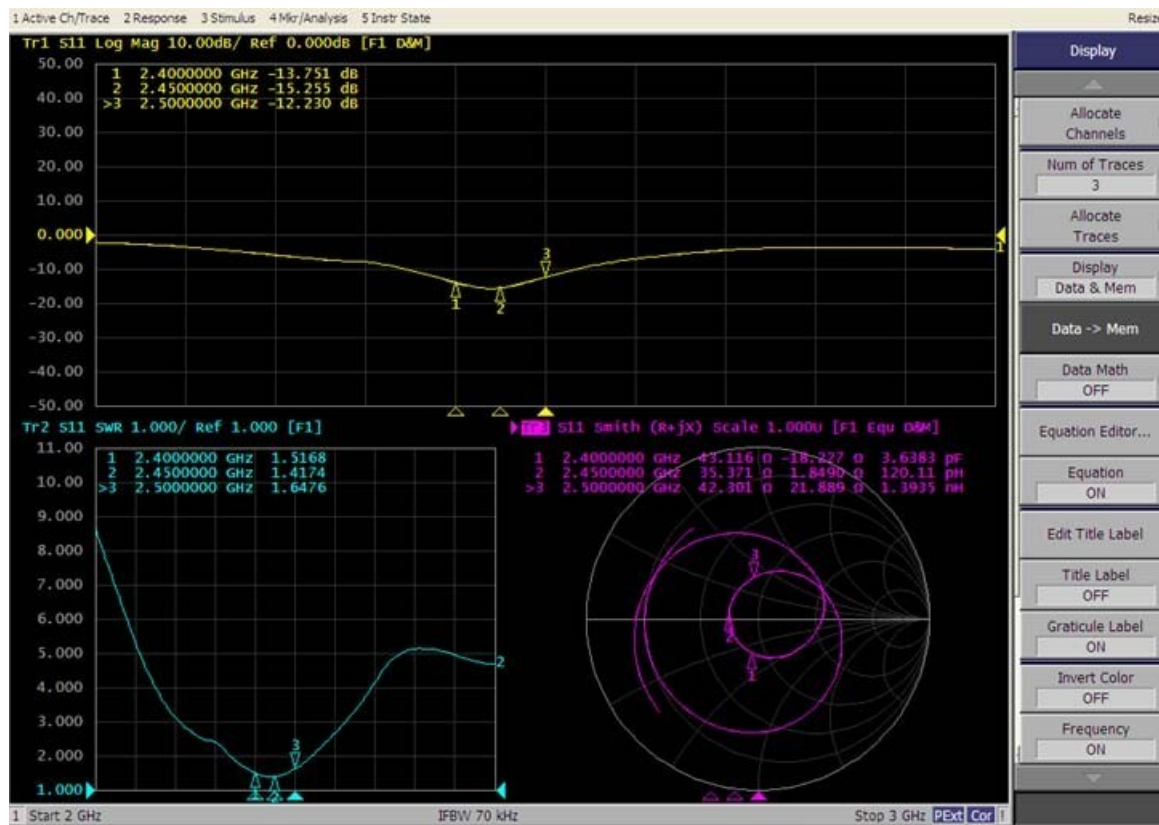

3.2: 暗室 2D、3DRaditation Pattern(整机数据)

2400.000MHz

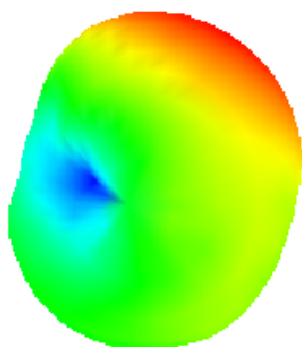

2.4GHz

Gain: 2.12dBi

2400.000MHz H

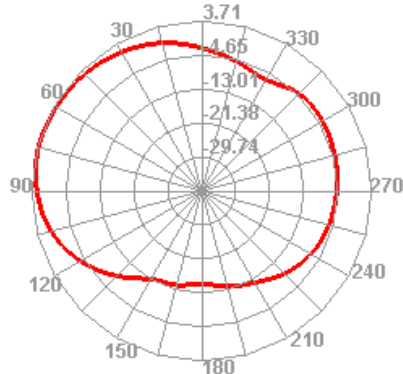

Efficiency:53.12%

2450.000MHz

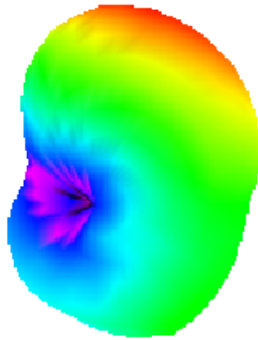

2.45GHz

Gain: 2.31dBi

2450.000MHz H

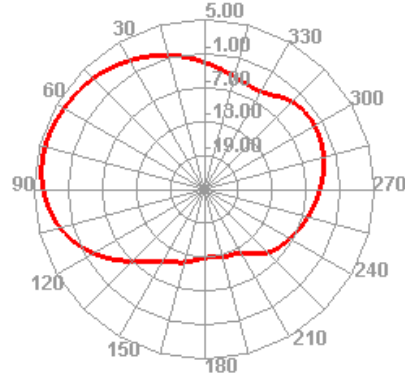

Efficiency: 55.47%

2500.000MHz

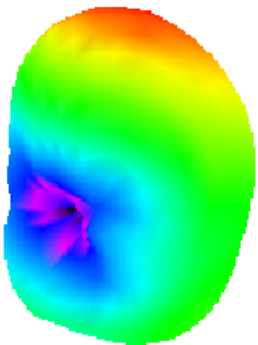

2.5GHz

Gain: 2.25dBi

2500.000MHz H

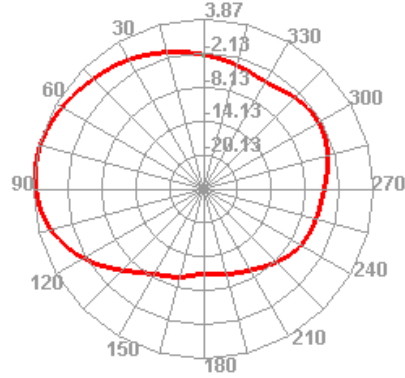

Efficiency: 54.15%