



<b>Prüfbericht-Nr.:</b> <i>Test Report No.:</i>	<b>CN249HS1 001</b>	<b>Auftrags-Nr.:</b> <i>Order No.:</i>	<b>158282436</b>	<b>Seite 1 von 18</b> <i>Page 1 of 18</i>	
<b>Kunden-Referenz-Nr.:</b> <i>Client Reference No.:</i>	<b>N/A</b>	<b>Auftragsdatum:</b> <i>Order date:</i>	<b>12.03.2024</b>		
<b>Auftraggeber:</b> <i>Client:</i>	<b>Carrera Toys GmbH</b> <b>Rennbahn Allee 1, 5412 Puch, Salzburg, Austria</b>				
<b>Prüfgegenstand:</b> <i>Test item:</i>	<b>Short Range Device - 2.4GHz Transceiver</b>				
<b>Bezeichnung / Typ-Nr.:</b> <i>Identification / Type No.:</i>	<b>20061677</b>				
<b>Auftrags-Inhalt:</b> <i>Order content:</i>	<b>FCC and ISED Certification</b>				
<b>Prüfgrundlage:</b> <i>Test specification:</i>	<b>FCC Part 15 Subpart C, ANSI C63.10-2013</b> <b>RSS-210 Issue 10, RSS-Gen Issue 5</b>				
<b>Wareneingangsdatum:</b> <i>Date of receipt:</i>	<b>12.03.2024</b>				
<b>Prüfmuster-Nr.:</b> <i>Test sample No.:</i>	<b>A003658143-011</b>				
<b>Prüfzeitraum:</b> <i>Testing period:</i>	<b>12.03.2024 - 27.03.2024</b>				
<b>Ort der Prüfung:</b> <i>Place of testing:</i>	<b>Hong Kong</b>				
<b>Prüflaboratorium:</b> <i>Testing laboratory:</i>	<b>TÜV Rheinland Hong Kong Ltd.</b>				
<b>Prüfergebnis*:</b> <i>Test result*:</i>	<b>Pass</b>				
<b>geprüft von / tested by:</b>		<b>kontrolliert von / reviewed by:</b>			
					
<b>Datum</b> <i>Date</i>	<b>Name / Stellung</b> <i>Name / Position</i>	<b>Unterschrift</b> <i>Signature</i>	<b>Datum</b> <i>Date</i>	<b>Name / Stellung</b> <i>Name / Position</i>	<b>Unterschrift</b> <i>Signature</i>
09.04.2024	Gigi Tam / Assistant Engineer		09.04.2024	Billy Yip / Laboratory Manager	
<b>Sonstiges / Other:</b>		FCC ID: YFA20061677 IC ID: 12260A-20061677  "Decision Rule" document announced in our website ( <a href="https://www.tuv.com/landingpage/en/qm-gcn/">https://www.tuv.com/landingpage/en/qm-gcn/</a> ) describes the statement of conformity and its rule of enforcement for test results are applicable throughout this test report.			
<b>Zustand des Prüfgegenstandes bei Anlieferung:</b> <i>Condition of the test item at delivery:</i>		<b>Prüfmuster vollständig und unbeschädigt</b> <i>Test item complete and undamaged</i>			
* Legende: P(ass) = entspricht o.g. Prüfgrundlage(n) F(ail) = entspricht nicht o.g. Prüfgrundlage(n) N/A = nicht anwendbar N/T = nicht getestet * Legend: P(ass) = passed a.m. test specification(s) F(ail) = failed a.m. test specification(s) N/A = not applicable N/T = not tested					
<b>Dieser Prüfbericht bezieht sich nur auf das o.g. Prüfmuster und darf ohne Genehmigung der Prüfstelle nicht auszugsweise vervielfältigt werden. Dieser Bericht berechtigt nicht zur Verwendung eines Prüfzeichens.</b> <i>This test report only relates to the above mentioned test sample. Without permission of the test center this test report is not permitted to be duplicated in extracts. This test report does not entitle to carry any test mark.</i>					

1	<p>Alle eingesetzten Prüfmittel waren zum angegebenen Prüfzeitraum gemäß eines festgelegten Kalibrierungsprogramms unseres Prüfhauses kalibriert. Sie entsprechen den in den Prüfprogrammen hinterlegten Anforderungen. Die Rückverfolgbarkeit der eingesetzten Prüfmittel ist durch die Einhaltung der Regelungen unseres Managementsystems gegeben. Detaillierte Informationen bezüglich Prüfkonditionen, Prüfequipment und Messunsicherheiten sind im Prüflabor vorhanden und können auf Wunsch bereitgestellt werden.</p> <p><i>The equipment used during the specified testing period was calibrated according to our test laboratory calibration program. The equipment fulfils the requirements included in the relevant standards. The traceability of the test equipment used is ensured by compliance with the regulations of our management system. Detailed information regarding test conditions, equipment and measurement uncertainty is available in the test laboratory and could be provided on request.</i></p>
2	<p>Wie vertraglich vereinbart, wurde dieses Dokument nur digital unterzeichnet. Der TÜV Rheinland hat nicht überprüft, welche rechtlichen oder sonstigen diesbezüglichen Anforderungen für dieses Dokument gelten. Diese Überprüfung liegt in der Verantwortung des Benutzers dieses Dokuments. Auf Verlangen des Kunden kann der TÜV Rheinland die Gültigkeit der digitalen Signatur durch ein gesondertes Dokument bestätigen. Diese Anfrage ist an unseren Vertrieb zu richten. Eine Umweltgebühr für einen solchen zusätzlichen Service wird erhoben. Informationen zur Verifizierung der Authentizität unserer Dokumente erhalten Sie auf folgender Webseite: <a href="http://go.tuv.com/digital-signature">go.tuv.com/digital-signature</a></p> <p><i>As contractually agreed, this document has been signed digitally only. TÜV Rheinland has not verified and unable to verify which legal or other pertaining requirements are applicable for this document. Such verification is within the responsibility of the user of this document. Upon request by its client, TÜV Rheinland can confirm the validity of the digital signature by a separate document. Such request shall be addressed to our Sales department. An environmental fee for such additional service will be charged. For information on verifying the authenticity of our documents, please visit the following website: <a href="http://go.tuv.com/digital-signature">go.tuv.com/digital-signature</a></i></p>
3	<p>Prüfklausel mit der Note * wurden an qualifizierte Unterauftragnehmer vergeben und sind unter der jeweiligen Prüfklausel des Berichts beschrieben. Abweichungen von Prüfspezifikation(en) oder Kundenanforderungen sind in der jeweiligen Prüfklausel im Bericht aufgeführt.</p> <p><i>Test clauses with remark of * are subcontracted to qualified subcontractors and described under the respective test clause in the report. Deviations of testing specification(s) or customer requirements are listed in specific test clause in the report.</i></p>
4	<p>Die Entscheidungsregel für Konformitätserklärungen basierend auf numerischen Messergebnissen in diesem Prüfbericht basiert auf der "Null-Grenzwert-Regel" und der "Einfachen Akzeptanz" gemäß ILAC G8:2019 und IEC Guide 115:2021, es sei denn, in der auf Seite 1 dieses Berichts genannten angewandten Norm ist etwas anderes festgelegt oder vom Kunden gewünscht. Dies bedeutet, dass die Messunsicherheit nicht berücksichtigt wird und daher auch nicht im Prüfbericht angegeben wird. Zu weiteren Informationen bezüglich des Risikos durch diese Entscheidungsregel siehe ILAC G8:2019.</p> <p><i>The decision rule for statements of conformity, based on numerical measurement results, in this test report is based on the "Zero Guard Band Rule" and "Simple Acceptance" in accordance with ILAC G8:2019 and IEC Guide 115:2021, unless otherwise specified in the applied standard mentioned on Page 1 of this report or requested by the customer. This means that measurement uncertainty is not taken in account and hence also not declared in the test report. For additional information to the resulting risk based of this decision rule please refer to ILAC G8:2019.</i></p>

# Table of Content

	Page
<b>Cover Page</b> .....	1
<b>Table of Content</b> .....	2
<b>Product information</b> .....	5
Manufacturers declarations .....	5
Product function and intended use .....	5
Submitted documents.....	5
Independent Operation Modes .....	5
Related Submittal(s) Grants .....	5
Remark .....	5
<b>Test Set-up and Operation Mode</b> .....	6
Principle of Configuration Selection .....	6
Test Operation and Test Software .....	6
Special Accessories and Auxiliary Equipment .....	6
Countermeasures to achieve EMC Compliance.....	6
<b>Test Methodology</b> .....	7
Radiated Emission .....	7
Field Strength Calculation.....	7
Conducted Emission Calculation .....	7
<b>Test Setup Diagram</b> .....	8
<b>Test Facility</b> .....	10
Test Laboratory Information .....	10
<b>List of Test and Measurement Instruments</b> .....	11
<b>Measurement Uncertainty</b> .....	12
<b>Results FCC Part 15 – Subpart C / RSS-210 Issue 10</b> .....	13
Speed Controller – 2.4GHz Transmitter .....	13
FCC 15.203 – Antenna Requirement 1 .....	Pass..... 13
FCC 15.204 – Antenna Requirement 2 .....	Pass..... 13
RSS-Gen 6.3 – External Control.....	Pass..... 13
RSS-Gen 8.3 – Antenna Requirement .....	Pass..... 13
FCC 15.207 / RSS-Gen 8.8 – Conducted Emission on AC Mains .....	N/A..... 13
FCC 15.215 (c) – 20 dB Bandwidth .....	Pass..... 14
RSS-Gen 6.7 – Occupied Bandwidth.....	N/A..... 14

<b>Appendix 1 – Test protocols .....</b>	<b>7 pages</b>
<b>Appendix 2 – Test setup .....</b>	<b>5 pages</b>
<b>Appendix 3 – EUT External Photos .....</b>	<b>7 pages</b>
<b>Appendix 4 – EUT Internal Photos .....</b>	<b>8 pages</b>
<b>Appendix 5 – RF exposure information.....</b>	<b>3 pages</b>

## Product information

PMN: 20061677	HVIN: 20061677
FVIN: N/A	HMN: N/A

## Manufacturers declarations

	Transmitter
Operating frequency range	2410 - 2472MHz
Type of modulation	GFSK
Number of channels	32
Type of antenna	Fixed Integral wire antenna
Power level	fix
Connection to public utility power line	No
Nominal voltage	1.5 VDC
Rated transmitter power	Maximum 10 mW
Occupied bandwidth	Not available
Channel bandwidth	1MHz
Emission designator	F7DXN
Frequency stability	Not available

## Product function and intended use

The equipment under test (EUT) is a radio control toy transmitter operating at 2.4GHz. It is a wireless speed controller for a toy track car set and is powered by battery only.

FCC ID: YFA20061677 / IC ID: 12260A-20061677

Models	Product description
20061676	Short Range Device - 2.4GHz Transceiver (GO!!! Wireless Upgrade Kit)
20061677	Short Range Device - 2.4GHz Transceiver (GO!!! WIRELESS Speed Controller solo)

## Submitted documents

Nil

## Independent Operation Modes

The basic operation modes are:

- Transmitting mode.

For further information refer to User Manual

## Related Submittal(s) Grants

This is a single application for certification of the transmitter.

## Remark

The test results in this test report are only relevant to the tested sample and does not involve any assessment in the production.

## Test Set-up and Operation Mode

### Principle of Configuration Selection

**Emission:** The equipment under test (EUT) was configured to measure its highest possible radiation level. The test modes were adapted accordingly in reference to the instructions for use.

### Test Operation and Test Software

Test operation should refer to test methodology.

- Test mode samples with maximum RF output power and duty cycle and capable to transmit continuously at the lowest, middle and highest frequency channels is provided by the applicant for the testing.

### Special Accessories and Auxiliary Equipment

The product has been tested together with the following additional accessories:

- None

### Countermeasures to achieve EMC Compliance

- None

## Test Methodology

### Radiated Emission

The radiated emission measurements of the transmitter part were performed according to the procedures in ANSI C63.10-2013.

For measurement below 1GHz - the equipment under test (EUT) was placed at the middle of the 80 cm height turntable. For measurement above 1GHz - the EUT was placed at the middle of the 1.5 m height turntable and RF absorbing material was placed on ground plane between turntable and measuring antenna. During the testing, the EUT was operated standalone and arranged for maximum emissions. The EUT was tested in three orthogonal planes.

The investigation is performed with the EUT rotated 360°, the antenna height scanned between 1m and 4m, and the antenna rotated to repeat the measurements for both the horizontal and vertical antenna polarizations. Repeat the measurement steps until the maximum emissions were obtained.

All radiated tests were performed at an antenna to EUT with 3 meters distance, unless stated otherwise in particular parts of this test report.

### Field Strength Calculation

The field strength at 3 m was established by adding the meter reading of the spectrum analyzer to the factors associated with antenna correction factor, cable loss, preamplifiers and filter attenuation.

The equation is expressed as follow:

$$FS = R + AF + CF + FA - PA$$

Where FS = Field Strength in dBuV/m at 3 meters.  
 R = Reading of Spectrum Analyzer in dBuV.  
 AF = Antenna Factor in dB.  
 CF = Cable Attenuation Factor in dB.  
 FA = Filter Attenuation Factor in dB.  
 PA = Preamplifier Factor in dB.

FA and PA are only be used for the measuring frequency above 1 GHz.

### Conducted Emission Calculation

Receiver reading  $R_r$  (dB $\mu$ V)  
 LISN insertion loss  $L_l$  (dB)  
 Cable loss  $C_i$  (dB)

$$\text{Final result (dB}\mu\text{V)} = R_r + L_l + C_i$$

Sample:

$R_r$	=	40.2 dB $\mu$ V
$L_l$	=	10.2 dB
$C_i$	=	0.3 dB

$$\text{Final result} = 40.2 + 10.2 + 0.3 = 50.7 \text{ dB}\mu\text{V}$$

## Test Setup Diagram

Diagram of Measurement Configuration for Radiation Test

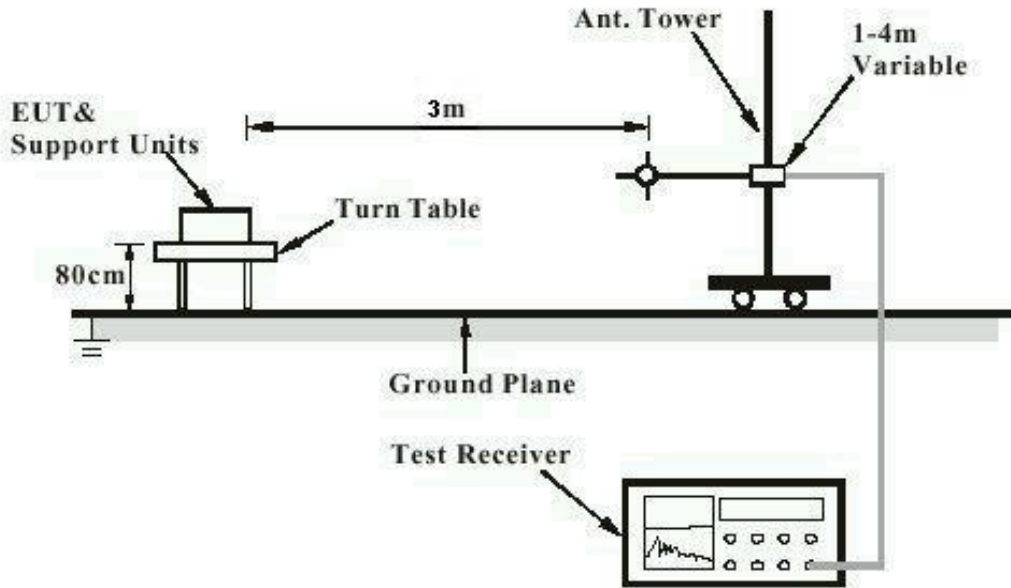

**Note:** Measurements above 1 GHz are done with a table height of 1.5m. In addition, there is RF absorbing material on the floor of the test site for above 1GHz measurement.

Diagram of Measurement Equipment Configuration for Mains Conduction Measurement (if applicable)

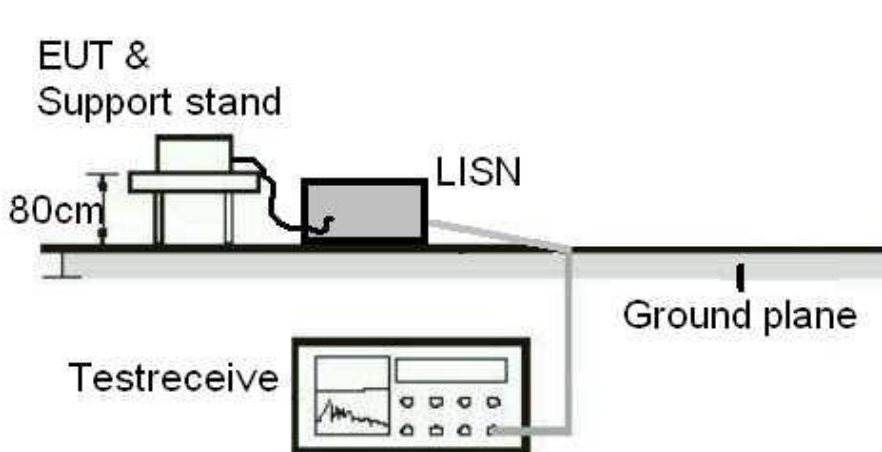



**Diagram of Equipment Configuration for Antenna-port Conducted Measurement (if applicable)**

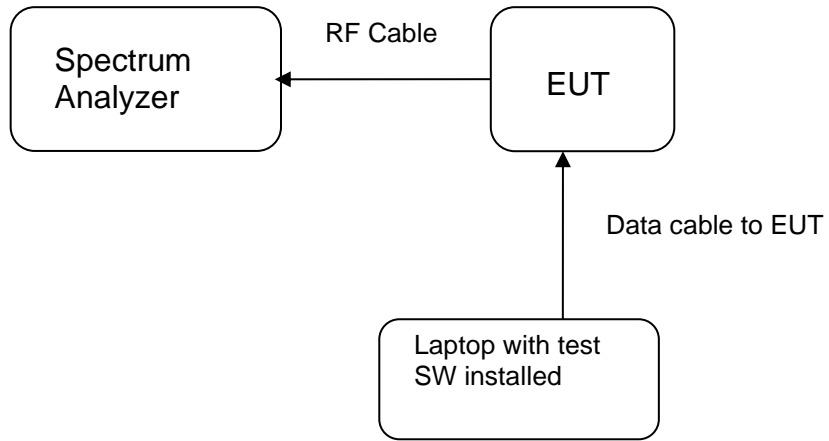

## Test Facility

### Test Laboratory Information

TÜV Rheinland Hong Kong Ltd.

Address: 3-4/F, Fou Wah Industrial Building, 10-16 Pun Shan Street, Tsuen Wan, N.T., Hong Kong

Tel.: +852 2192 1000

Fax: +852 2192 1001

Email [service-gc@tuv.com](mailto:service-gc@tuv.com)

The test facility is recognized or accredited by the following organizations:

#### FCC

Test Firm Registration Number : 371735

#### ISED/IC

Test Site Registration Number : 26152

#### **Hong Kong Productivity Council**

Address: LG 1/F., HKPC Building, 78 Tat Chee Road

Tel.: +852 2788 6396

Fax: +852 2788 5405

Email: [emc@hkpc.org](mailto:emc@hkpc.org)

## List of Test and Measurement Instruments

### Radiated Emission

Equipment	Manufacturer	Type	Cal. Date	Due Date
Multi-functional Anechoic Chamber	Albatross	Nil	04-Jan-24	04-Jan-25
Test Receiver	R & S	ESU40	25-Mar-24	25-Mar-25
Active Loop Antenna	EMCO	6502	3-Nov-22	3-Nov-24
Bi-conical Antenna	R & S	HK116	24-Oct-22	24-Oct-24
Log Periodic Antenna	R & S	HL223	25-Oct-22	25-Oct-24
Standard Gain Horn	ETS-Lindgren	3160-07	25-Nov-22	25-Nov-24
Standard Gain Horn	ETS-Lindgren	3160-08	25-Nov-22	25-Nov-24
Standard Gain Horn	ETS-Lindgren	3160-10	30-Nov-22	30-Nov-24
Double-Ridged Waveguide Horn	EMCO	3116	30-Nov-22	30-Nov-24
Double-Ridged Waveguide Horn	EMCO	3117	21-Nov-22	21-Nov-24
Coaxial cable	Harbour	SF118/11n/11n/12 000.0	3-Aug-22	3-Aug-24
High Frequency Cable	Pasternack	PE3VNA4001-3M	29-Jan-23	29-Jan-25
Microwave amplifier 0.5-26.5GHz, 25dB gain	COM-POWER Corporation	PAM-118A	4-Mar-23	4-Mar-24
Preamplifier 18GHz to 40GHz with cable (EMC656)	A.H. Systems, Inc.	PAM-1840VH	28-Jan-24	28-Jan-25
High Pass Filter (cutoff freq. =1000MHz)	Trilithic	23042	30-Oct-23	30-Oct-25

### Radio Test

Equipment	Manufacturer	Type	Cal. Date	Due Date
Signal and Spectrum Analyzer	R & S	FSV40	13-Jul-23	13-Jul-24

## Measurement Uncertainty

The estimated combined standard uncertainty for power-line conducted emissions measurements is  $\pm 3.36$ dB.

The estimated combined standard uncertainty for radiated emissions measurements is  $\pm 2.70$ dB (9kHz to 30MHz) and  $\pm 4.98$ dB (30MHz to 200MHz) and  $\pm 5.80$ dB (200MHz to 1000MHz) and is  $\pm 4.90$ dB (1GHz to 8.2GHz) and  $\pm 4.90$ dB (8.2GHz to 12.4GHz) and  $\pm 4.98$ dB (12.4GHz to 18GHz)

The estimated combined standard uncertainty for antenna conducted emission is  $\pm 1.94$ dB

The reported expanded uncertainty of measurement is stated as the standard uncertainty of measurement multiplied by the coverage factor of  $k=2$ , which for the level of confidence is approximately 95%.

## Results FCC Part 15 – Subpart C / RSS-210 Issue 10

### Speed Controller – 2.4GHz Transmitter

<b>FCC 15.203 – Antenna Requirement 1</b>		<b>Pass</b>
<b>FCC Requirement:</b>	No antenna other than that furnished by the responsible party shall be used with the device	
<b>Results:</b>	a) Antenna type: b) Manufacturer and model no: c) Peak Gain:	Fixed Integral wire antenna N/A 2.3 dBi
<b>Verdict:</b>	Pass	

<b>FCC 15.204 – Antenna Requirement 2</b>		<b>Pass</b>
<b>FCC Requirement:</b>	An intentional radiator may be operated only with the antenna with which it is authorized. If an antenna is marketed with the intentional radiator, it shall be of a type which is authorized with the intentional radiator.	
<b>Results:</b>	Only one integral antenna can be used.	
<b>Verdict:</b>	Pass	

<b>RSS-Gen 6.3 – External Control</b>		<b>Pass</b>
<b>IC Requirement:</b>	The device shall not have any external controls accessible to the user that enable it to be adjusted, selected or programmed to operate in violation of the limits prescribed in the applicable RSS.	
<b>Results:</b>	The device does not have any transmitter external controls accessible to the user that can be adjusted and operated in violation of the limits of this standard.	
<b>Verdict:</b>	Pass	

<b>RSS-Gen 8.3 – Antenna Requirement</b>		<b>Pass</b>
<b>IC Requirement:</b>	When a measurement at the antenna connector is used to determine RF output power, the effective gain of the device’s antenna shall be stated, based on measurement or on data from the antenna manufacturer.	
<b>Results:</b>	a) Antenna type: b) Manufacturer c) Model no d) Gain with reference to an isotropic radiator:	Fixed Integral wire antenna N/A N/A 2.3 dBi
<b>Verdict:</b>	Pass	

<b>FCC 15.207 / RSS-Gen 8.8 – Conducted Emission on AC Mains</b>		<b>N/A</b>
There is no AC power input or output ports on the EUT.		

<b>FCC 15.215 (c) – 20 dB Bandwidth</b>				<b>Pass</b>
Test Specification : ANSI C63.10 – 2013 Test date : 25.03.2024 Mode of operation : Tx mode Port of testing : Antenna port Supply voltage : 1.5 VDC Temperature : 20°C Humidity : 55%				
<b>Requirement:</b> The intentional radiators must be designed to ensure that the 20dB bandwidth of the emission, is contained within the frequency band designated in the rule section under which the equipment is operated.				
<b>Results:</b> Pre-scan has been conducted to determine the worst-case mode from all possible combinations between available modulations and packet types.  For test protocols refer to Appendix 1.				
Frequency (MHz)	20 dB left (MHz)	Limit (MHz)	20 dB right (MHz)	Limit (MHz)
2410	2409.457	> 2400	2410.630	< 2483.5
2440	2439.443	> 2400	2440.637	< 2483.5
2472	2471.457	> 2400	2472.644	< 2483.5

<b>RSS-Gen 6.7 – Occupied Bandwidth</b>				<b>N/A</b>
<b>FCC/ IC Requirement : N/A</b>				
Test Specification : RSS-Gen Test date : 25.03.2024 Mode of operation : Tx mode Port of testing : Antenna port Supply voltage : 1.5 VDC Temperature : 20°C Humidity : 55%				
<b>Results:</b> Pre-scan has been conducted to determine the worst-case mode from all possible combinations between available modulations and packet types.  For test protocols refer to Appendix 1.				
Frequency (MHz)	Left (MHz)	Right (MHz)	99% bandwidth (MHz)	
2410	2409.522	2410.572	1.049	
2440	2439.515	2440.572	1.056	
2472	2471.522	2472.572	1.049	

<b>FCC 15.249(a) / RSS-210 B.10(a) – Field Strength of Fundamental and Harmonics</b>		<b>Pass</b>
Test Specification : ANSI C63.10 – 2013 Test date : 27.03.2024 Mode of operation : Tx mode Port of testing : Enclosure Frequency range : 9kHz – 25GHz Supply voltage : 1.5 VDC Temperature : 21°C Humidity : 59%		
Requirement: The field strength of emissions from intentional radiators operated within these frequency bands shall comply with the following limit.		
<b>Results:</b> PASS		
Fundamental Frequency 2410MHz		Vertical Polarization
<b>Frequency MHz</b>	<b>Level dBuV/m</b>	<b>Limit / Detector dBuV/m</b>
2410.000	97.1	114.0 / PK
2410.000	80.3	94.0 / AV
Fundamental Frequency 2410MHz		Horizontal Polarization
<b>Frequency MHz</b>	<b>Level dBuV/m</b>	<b>Limit / Detector dBuV/m</b>
2410.000	81.8	114.0 / PK
2410.000	65.1	94.0 / AV
Harmonics 2410MHz		Vertical Polarization
<b>Frequency MHz</b>	<b>Level dBuV/m</b>	<b>Limit / Detector dBuV/m</b>
4820.000	61.3	74.0 / PK
4820.000	42.8	54.0 / AV
7230.000	59.4	74.0 / PK
7230.000	38.6	54.0 / AV
Harmonics 2410MHz		Horizontal Polarization
<b>Frequency MHz</b>	<b>Level dBuV/m</b>	<b>Limit / Detector dBuV/m</b>
4820.000	45.2	74.0 / PK
4820.000	30.3	54.0 / AV
7230.000	51.5	74.0 / PK
7230.000	33.0	54.0 / AV

Fundamental Frequency 2440MHz			Vertical Polarization		
<b>Frequency MHz</b>	<b>Level dBuV/m</b>	<b>Limit / Detector dBuV/m</b>			
2440.000	97.5	114.0 / PK			
2440.000	80.1	94.0 / AV			
Fundamental Frequency 2440MHz			Horizontal Polarization		
<b>Frequency MHz</b>	<b>Level dBuV/m</b>	<b>Limit / Detector dBuV/m</b>			
2440.000	82.6	114.0 / PK			
2440.000	65.8	94.0 / AV			
Harmonics 2440MHz			Vertical Polarization		
<b>Frequency MHz</b>	<b>Level dBuV/m</b>	<b>Limit / Detector dBuV/m</b>			
4880.000	59.8	74.0 / PK			
4880.000	41.3	54.0 / AV			
Harmonics 2440MHz			Horizontal Polarization		
<b>Frequency MHz</b>	<b>Level dBuV/m</b>	<b>Limit / Detector dBuV/m</b>			
4880.000	43.1	74.0 / PK			
4880.000	29.1	54.0 / AV			
Fundamental Frequency 2472MHz			Vertical Polarization		
<b>Frequency MHz</b>	<b>Level dBuV/m</b>	<b>Limit / Detector dBuV/m</b>			
2472.000	97.0	114.0 / PK			
2472.000	80.2	94.0 / AV			
Fundamental Frequency 2472MHz			Horizontal Polarization		
<b>Frequency MHz</b>	<b>Level dBuV/m</b>	<b>Limit / Detector dBuV/m</b>			
2472.000	81.2	114.0 / PK			
2472.000	64.4	94.0 / AV			
Harmonics 2472MHz			Vertical Polarization		
<b>Frequency MHz</b>	<b>Level dBuV/m</b>	<b>Limit / Detector dBuV/m</b>			
4944.000	59.1	74.0 / PK			
4944.000	40.6	54.0 / AV			
7416.000	58.6	74.0 / PK			
7416.000	37.8	54.0 / AV			
Harmonics 2472MHz			Horizontal Polarization		
<b>Frequency MHz</b>	<b>Level dBuV/m</b>	<b>Limit / Detector dBuV/m</b>			
4944.000	42.5	74.0 / PK			
4944.000	28.9	54.0 / AV			
7416.000	49.6	74.0 / PK			
7416.000	31.8	54.0 / AV			



<b>FCC 15.249(d), 15.205 / RSS-210 B.10(b) – Out Of Band Radiated Emission</b>		<b>Pass</b>
Test Specification : ANSI C63.10 – 2013 Test date : 27.03.2024 Mode of operation : Tx mode Port of testing : Enclosure Frequency range : 9kHz – 25GHz Supply voltage : 1.5 VDC Temperature : 21°C Humidity : 59%		
Requirement: Emissions radiated outside of the specified frequency bands, except for harmonics, shall be attenuated by at least 50dB below the level of the fundamental or to the general radiated emission limits in Section 15.209, whichever is the lesser attenuation.		
<b>Results:</b> All three transmit frequency modes comply with the field strength limit of section 15.209. There is no spurious found below 30MHz.		
Tx frequency 2410MHz		Vertical Polarization
<b>Frequency MHz</b>	<b>Level dBuV/m</b>	<b>Limit / Detector dBuV/m</b>
2390.000	44.2	74.0 / PK
2390.000	22.1	54.0 / AV
2400.000	50.7	74.0 / PK
2400.000	22.8	54.0 / AV
Tx frequency 2410MHz		Horizontal Polarization
<b>Frequency MHz</b>	<b>Level dBuV/m</b>	<b>Limit / Detector dBuV/m</b>
2390.000	35.2	74.0 / PK
2390.000	21.7	54.0 / AV
2400.000	37.7	74.0 / PK
2400.000	21.9	54.0 / AV
Tx frequency 2440MHz		Vertical Polarization
<b>Frequency MHz</b>	<b>Level dBuV/m</b>	<b>Limit / Detector dBuV/m</b>
No peak found	---	74.0 / PK
No peak found	---	54.0 / AV
Tx frequency 2440MHz		Horizontal Polarization
<b>Frequency MHz</b>	<b>Level dBuV/m</b>	<b>Limit / Detector dBuV/m</b>
No peak found	---	74.0 / PK
No peak found	---	54.0 / AV

Tx frequency 2472MHz		Vertical Polarization	
Frequency MHz	Level dBuV/m	Limit / Detector dBuV/m	
2483.500	50.7	74.0 / PK	
2483.500	22.4	54.0 / AV	
Tx frequency 2472MHz		Horizontal Polarization	
Frequency MHz	Level dBuV/m	Limit / Detector dBuV/m	
2483.500	35.5	74.0 / PK	
2483.500	21.6	54.0 / AV	

# Appendix 1

## Test Results

## 20dB Bandwidth

### Speed Controller

Tx frequency: 2410MHz

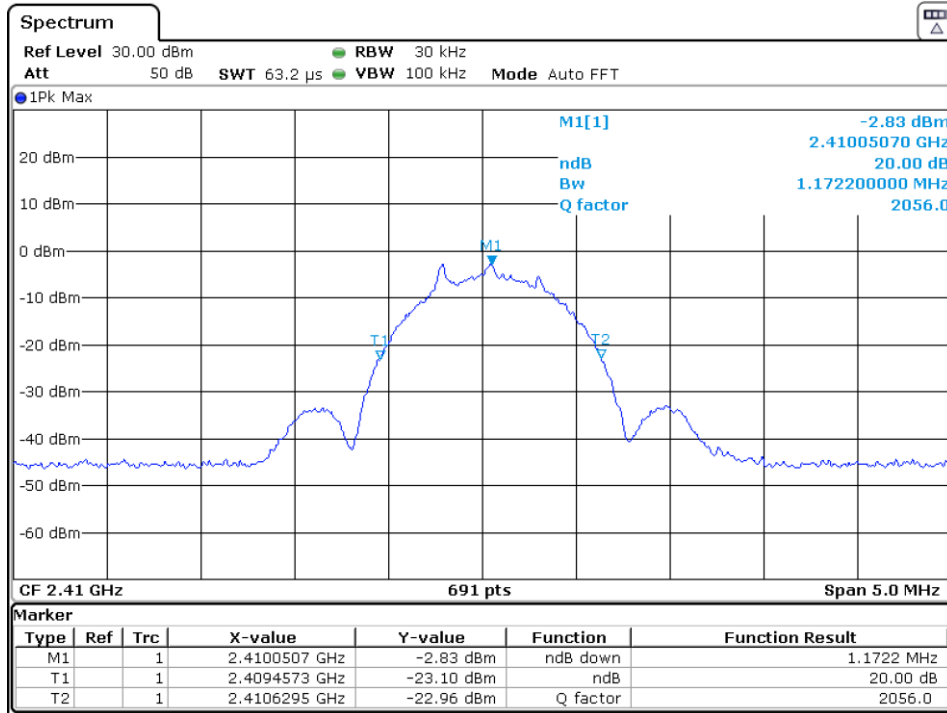

Date: 14.MAR.2024 14:45:10

Tx frequency: 2440MHz

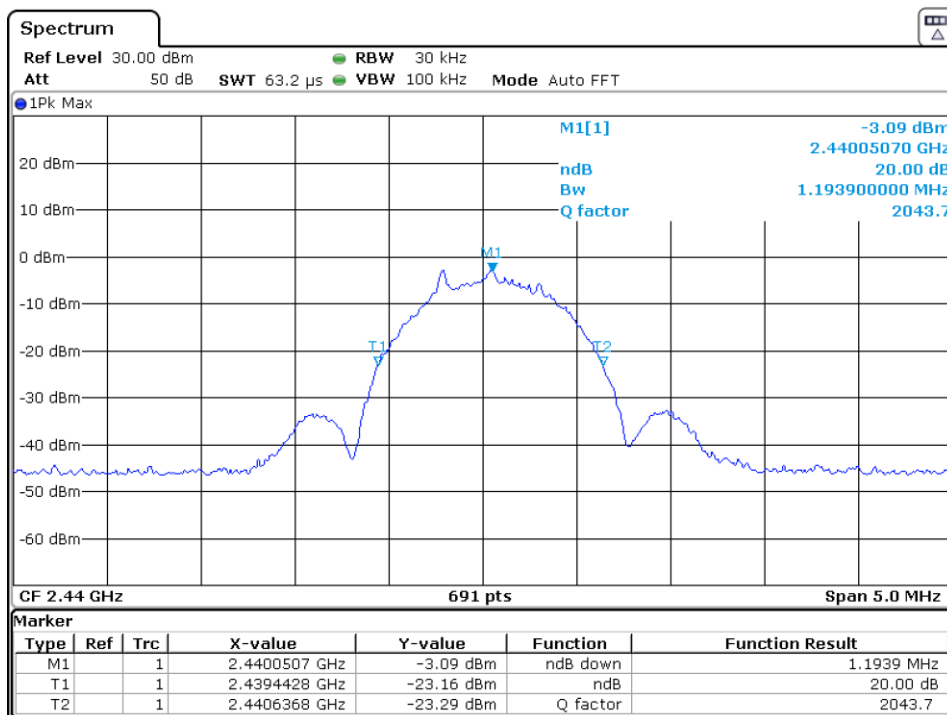

Date: 14.MAR.2024 14:48:13

Tx frequency: 2472MHz

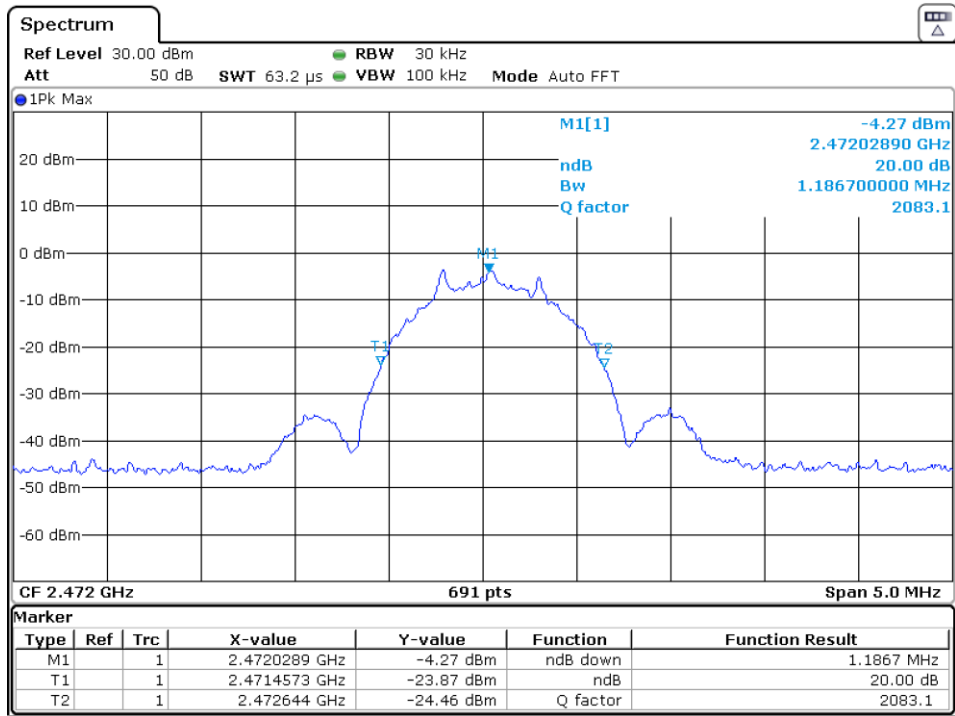

Date: 14.MAR.2024 14:49:38

# 99% Bandwidth

## Speed Controller

Tx frequency: 2410MHz

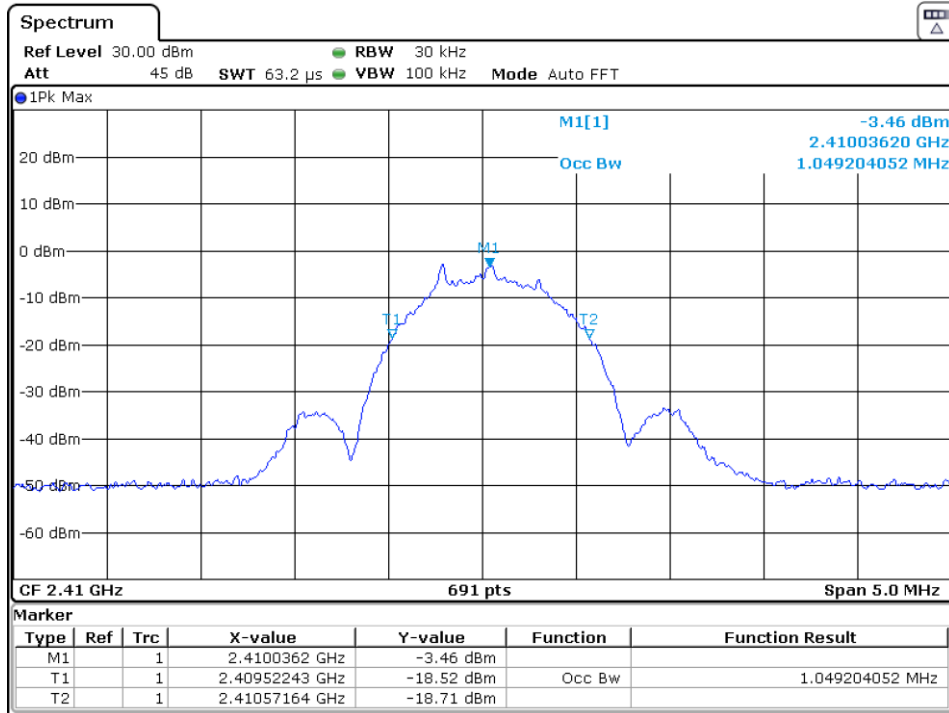

Date: 14.MAR.2024 14:46:45

Tx frequency: 2440MHz

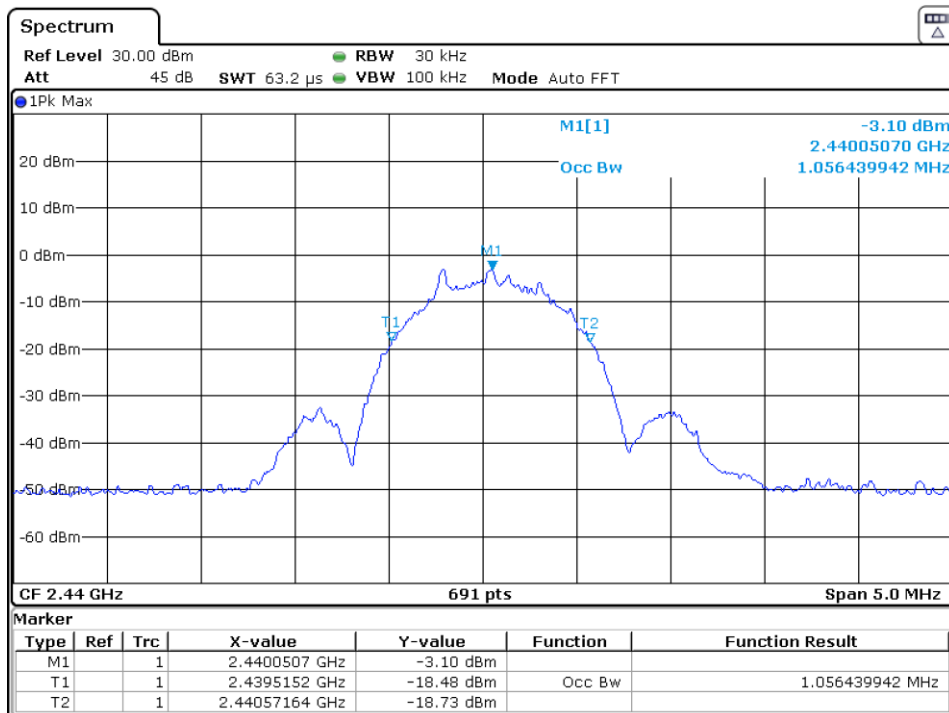

Date: 14.MAR.2024 14:48:39

Tx frequency: 2472MHz

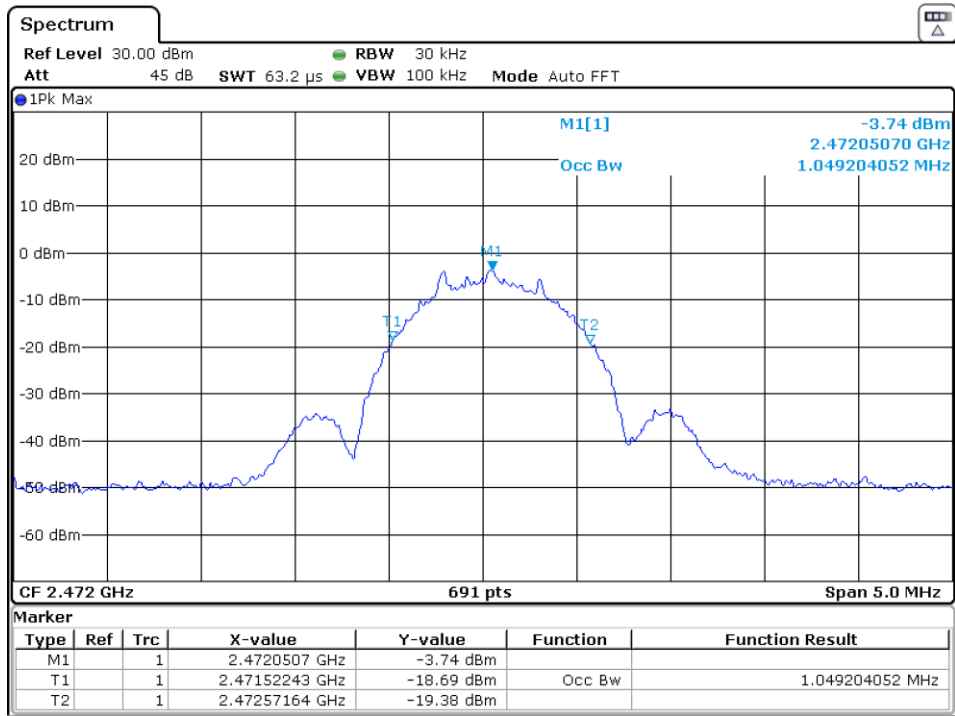

Date: 14.MAR.2024 14:51:01

# Appendix 2

## Test Setup Photos



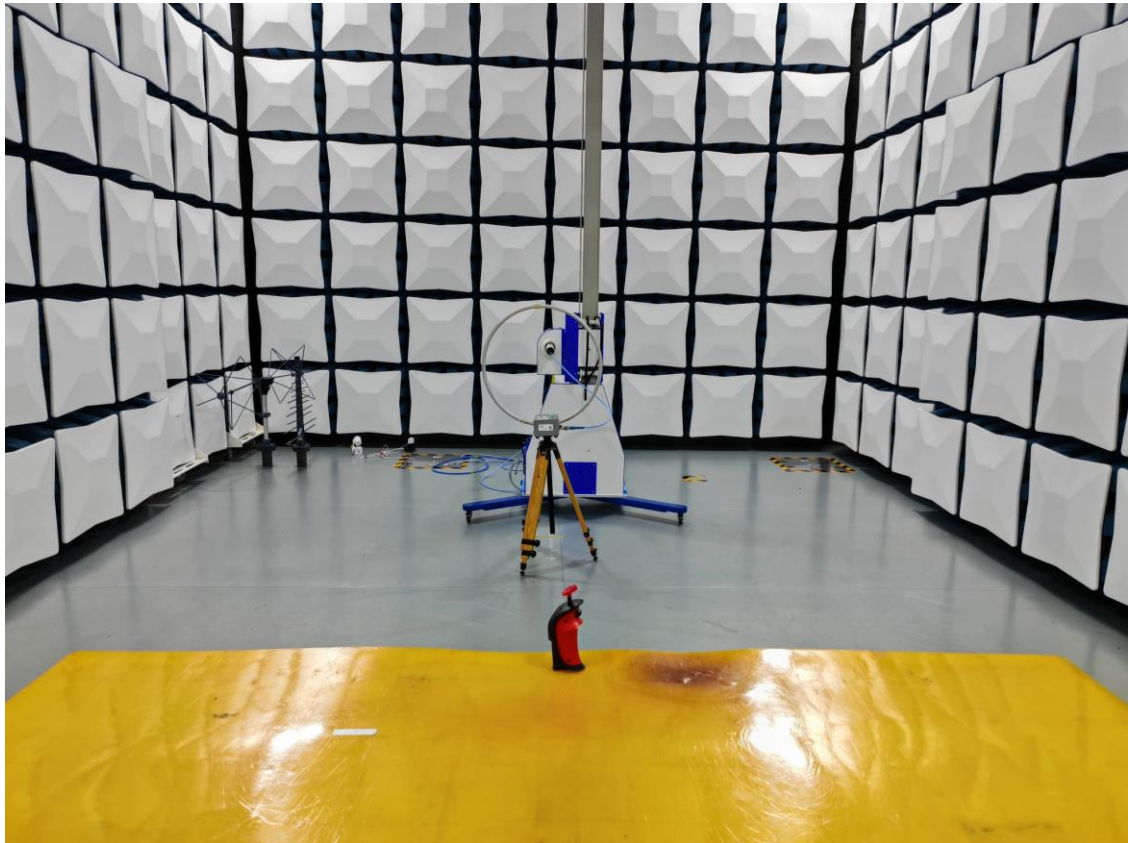

Set-up for Radiated Emission (9k-30MHz)

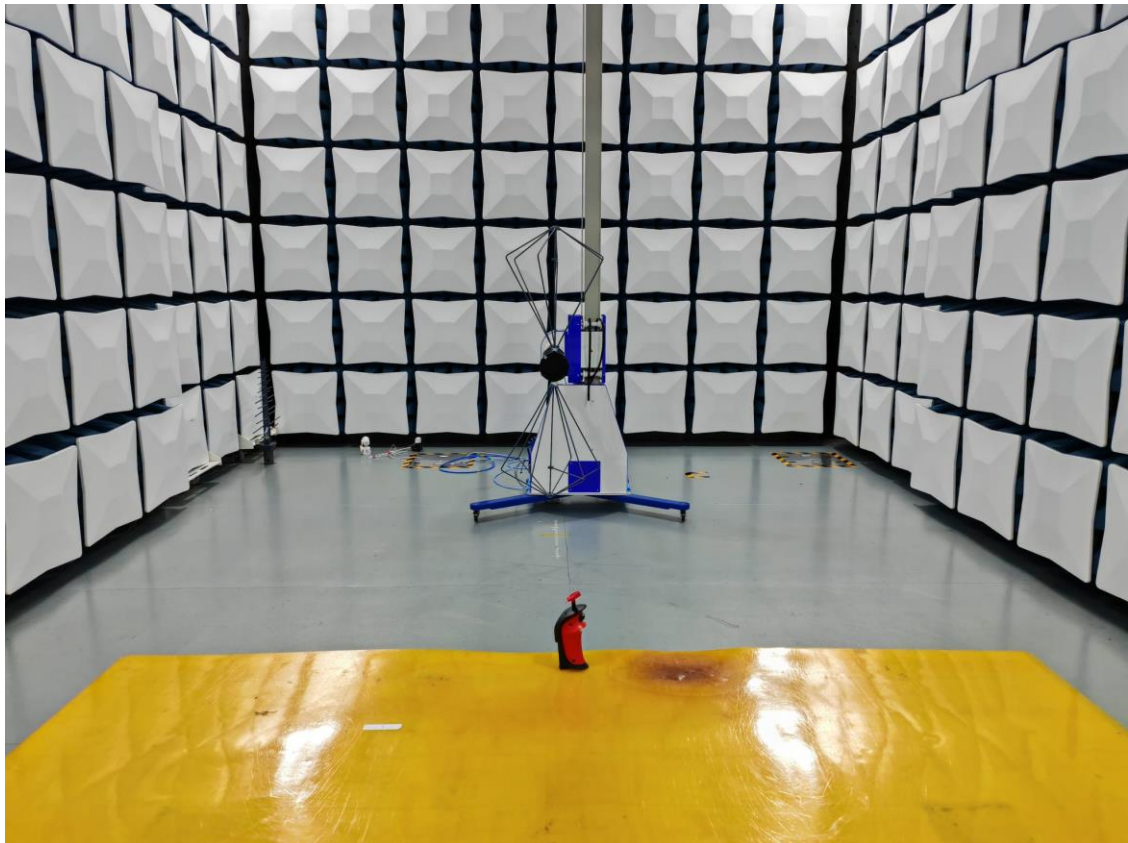

Set-up for Radiated Emission (30-200MHz)



Set-up for Radiated Emission (200-1000MHz)

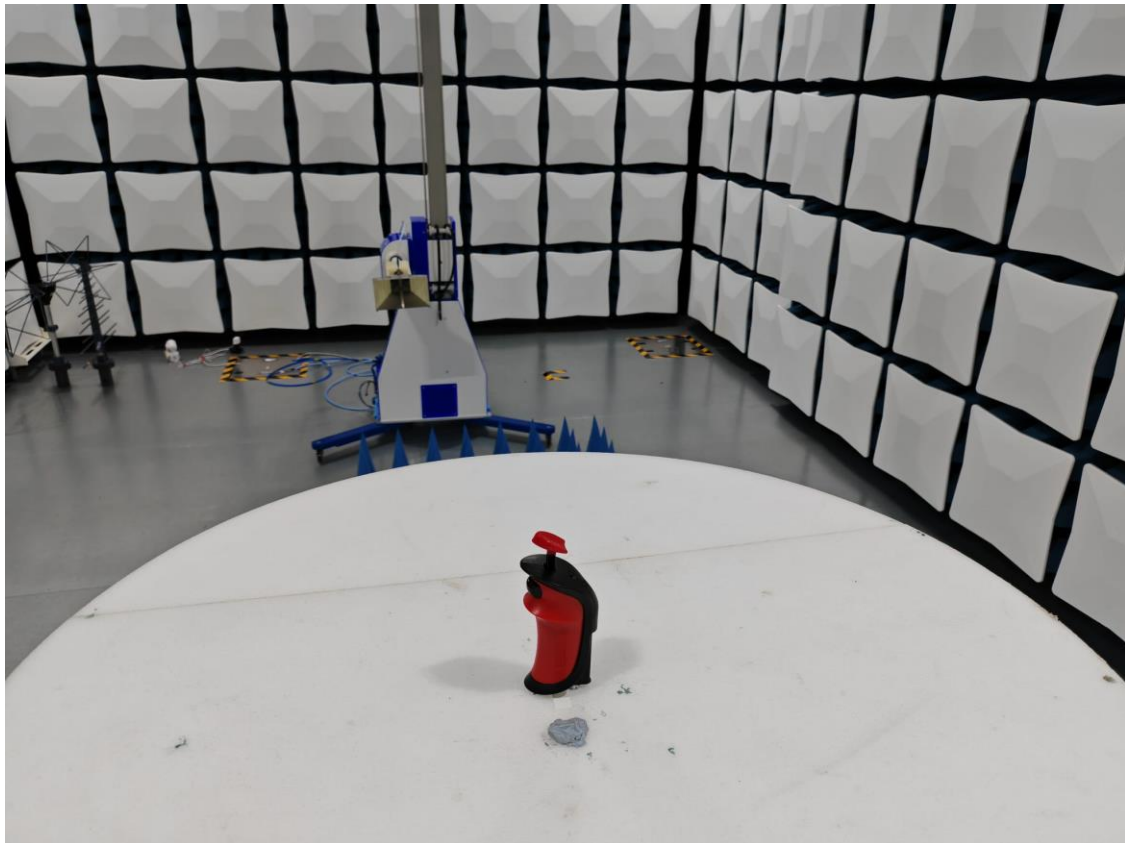

Set-up for Radiated Emission (1GHz above)

# Appendix 3

## EUT External Photos

FCC ID: YFA20061677  
IC ID: 12260A-20061677





External View



External View



External View

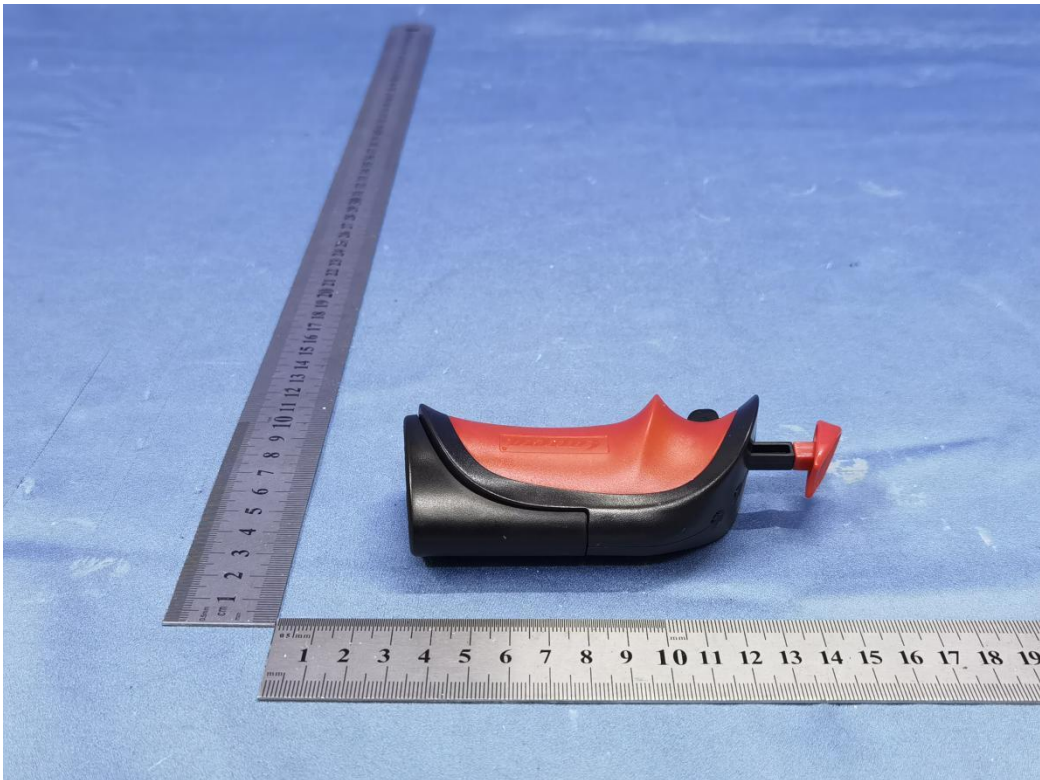

External View



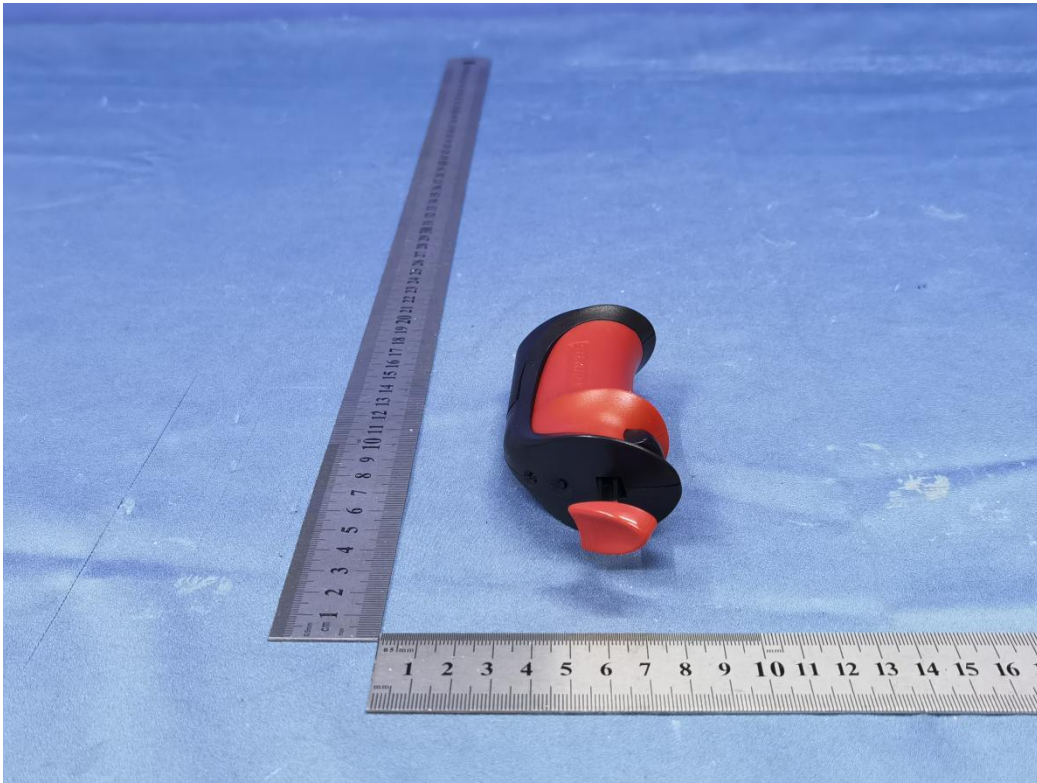

External View



External View



# Appendix 4

## EUT Internal Photos

FCC ID: YFA20061677  
IC ID: 12260A-20061677





Internal View



Internal View

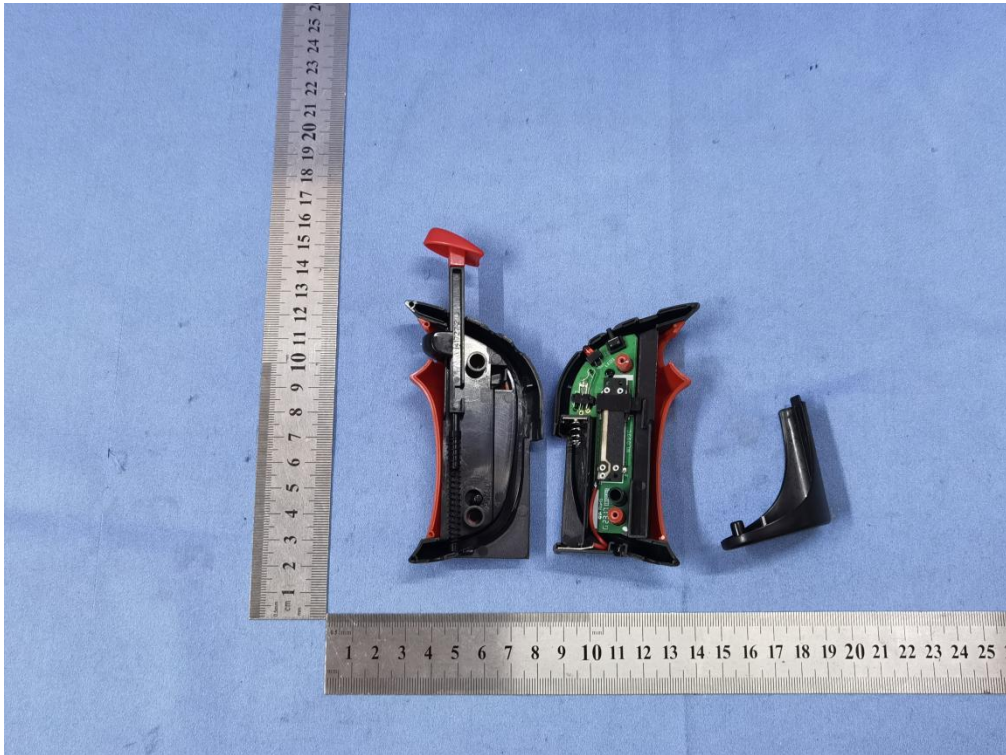

Internal View

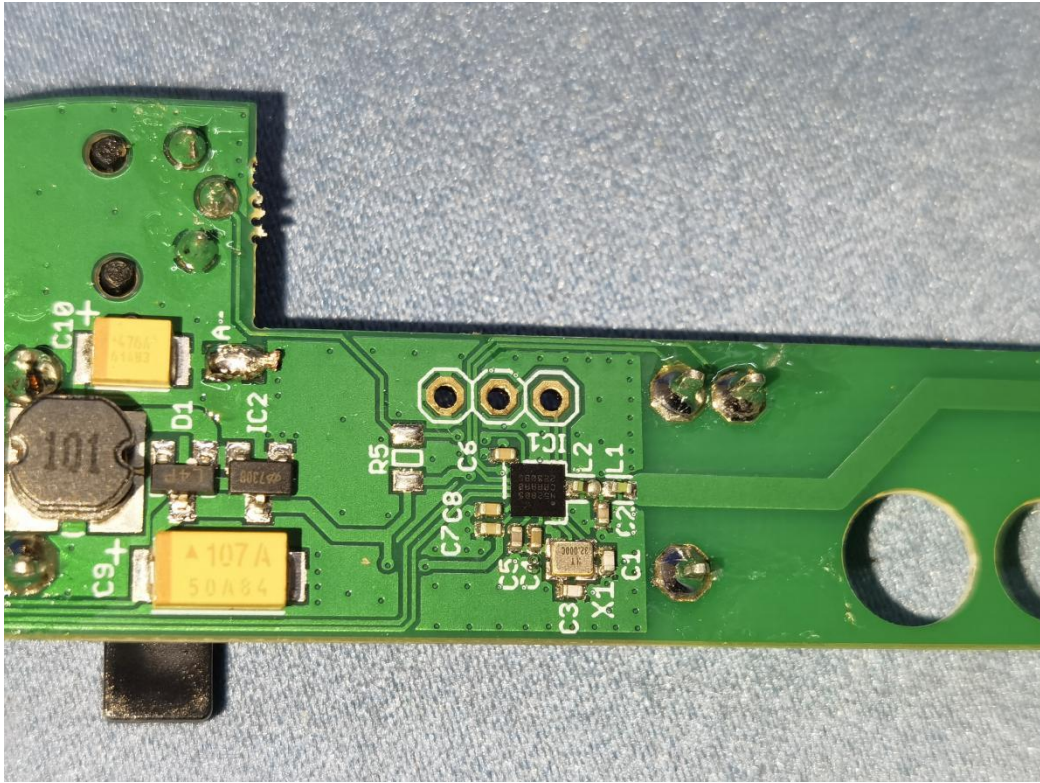

Internal View



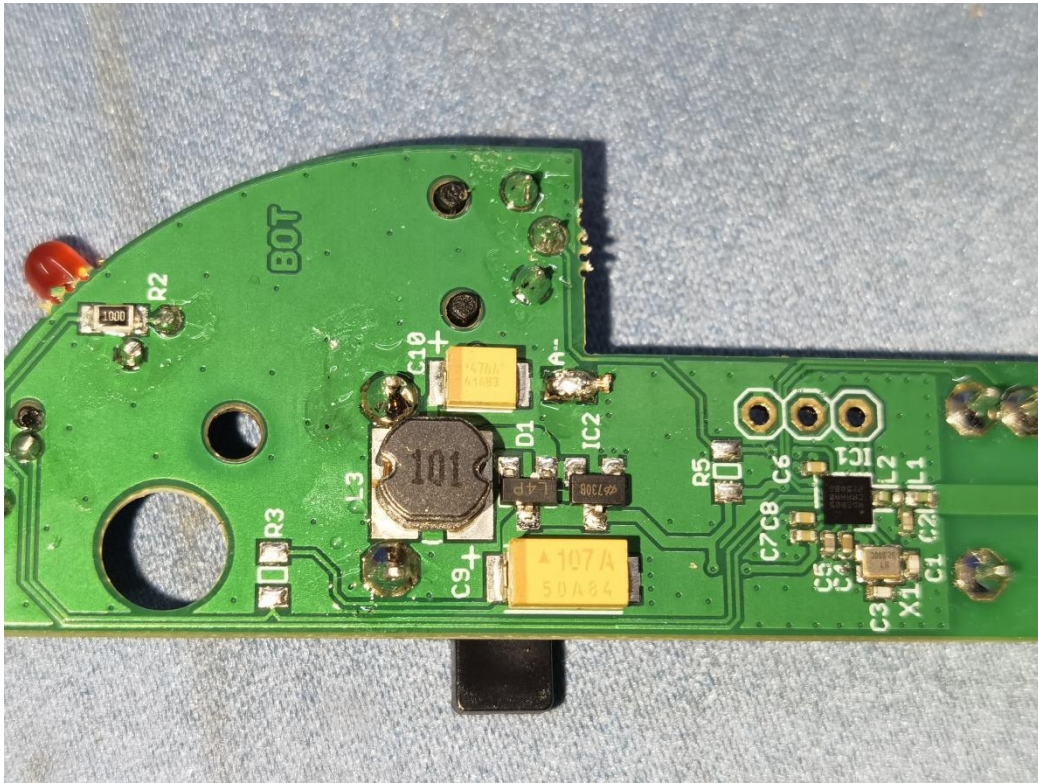

Internal View

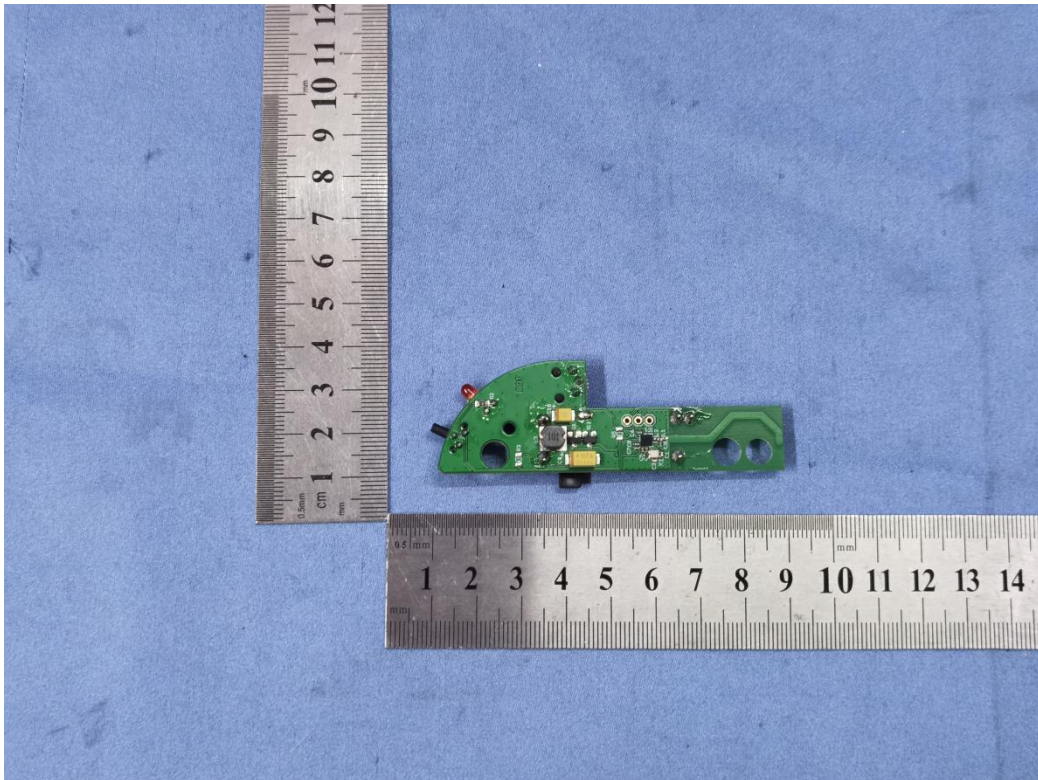

Internal View

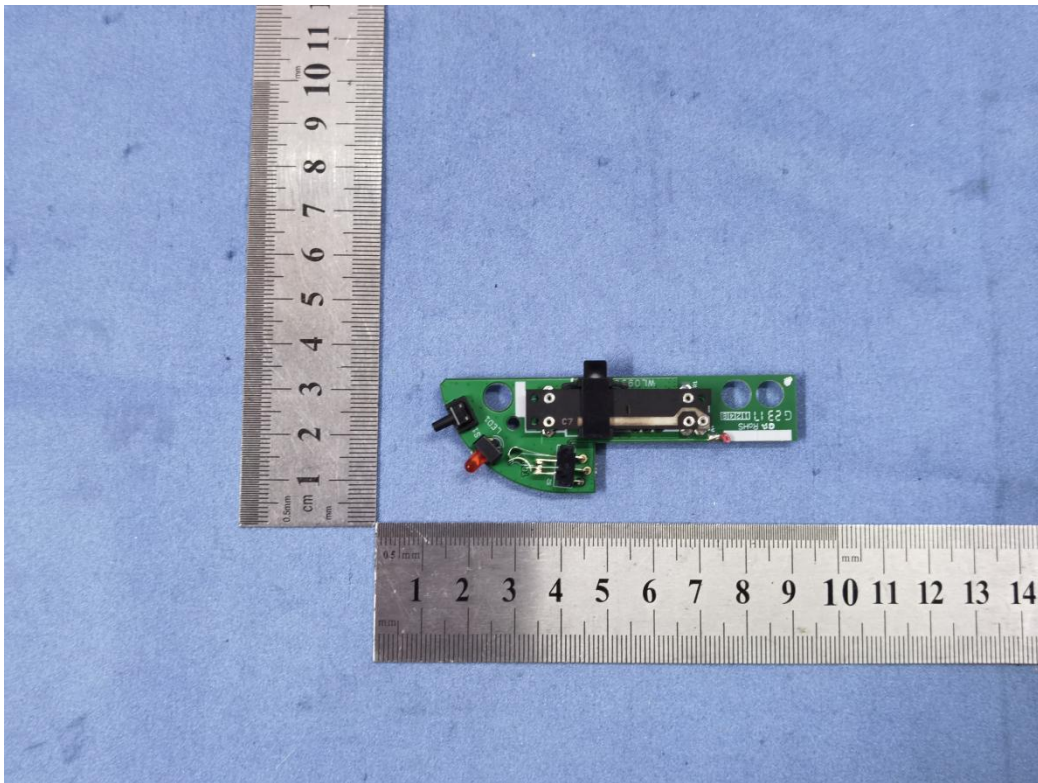

Internal View

# Appendix 5

## RF Exposure Information

FCC ID: YFA20061677  
IC ID: 12260A-20061677

## Maximum transmitter power:

### Speed Controller

Frequency (MHz)	Maximum peak field strength (dB $\mu$ V/m)	Maximum transmitter power (mW)
2410	97.1	0.9382
2440	97.5	1.0287
2472	97.0	0.9168

Note: The maximum peak field strength was taken from table of "Subclause 15.249(a)/RSS-210 B.10(a) – Field Strength of Fundamental and Harmonics".

### For FCC

According to KDB 447498 D01:

The 1-g and 10-g SAR test exclusion thresholds for 100 MHz to 6 GHz at *test separation distances*  $\leq 5$  mm are determined by:

$[(\text{max. power of channel, including tune-up tolerance, mW}) / (\text{min. test separation distance, mm})] \cdot [\sqrt{f(\text{GHz})}]$   
 $\leq 3.0$  for 1-g SAR and  $\leq 7.5$  for 10-g extremity SAR, where

- f(GHz) is the RF channel transmit frequency in GHz
- Power and distance are rounded to the nearest mW and mm before calculation
- The result is rounded to one decimal place for comparison
- 3.0 and 7.5 are referred to as the numeric thresholds in the step 2 below

### Result:

#### Speed Controller

$$(0.9382/5) \cdot \sqrt{2.410} = 0.291 < 3.0$$

$$(1.0287/5) \cdot \sqrt{2.440} = 0.321 < 3.0$$

$$(0.9168/5) \cdot \sqrt{2.472} = 0.288 < 3.0$$

### Conclusion:

No SAR is required.

### For ISED

#### Speed Controller

According to table 1 in RSS-102 Issue 6, below exemption limit is applied

Frequency: 2440 MHz

At separation distance of  $\leq 5$ mm

Exemption limits: 3mW

### Results:

max. power of channel = 1.0287 mW < 3mW

### Conclusion:

The maximum peak output power of the transmitter is less than the SAR evaluation exemption threshold and hence it complies with the RSS-102 RF exposure requirement