

AOPEN Chromebox Commercial 2

Commercial Computing Device

Model: BC5000

User Guide

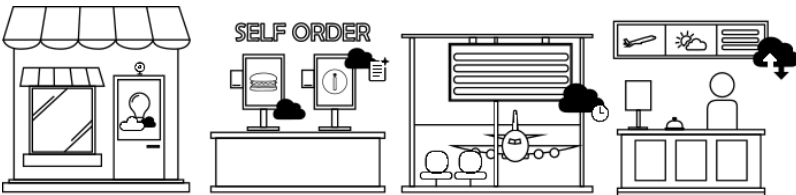
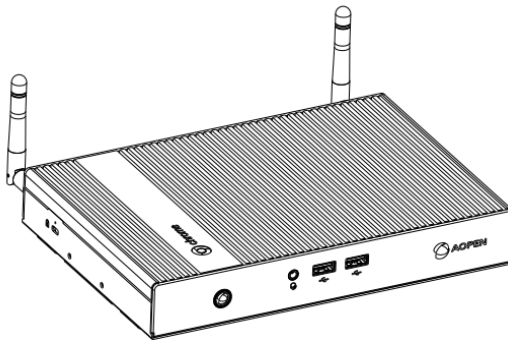

Table of Contents

Disposal Instructions	2
Copyright	6
Disclaimer	6
1. Safety Instructions	7
ENERGY STAR Certification.....	8
Risk of Overheating	9
2. Packing List	10
2-1. Standard Accessories	10
2-2. Optional Accessories	11
3. Product Introduction	12
3-1. Getting started	12
3-2. External View	14
3-3. Dimensions	16
3-4. Knowing your Chromebox Commercial 2.....	17
4. Contact Information	23
5. Chrome care	24



Disposal Instruction (US)

For conservation purposes, please do not throw this electronic device into the municipal trash bin when discarding.

To minimize pollution of our environment, please recycle this product. For more information about the collection and recycling of Waste Electrical and Electronic Equipment (WEEE), you are invited to visit our homepage at www.aopen.com under "Green Products"

廃棄上の指示

より良い地球保護のために、電子機器を廃棄処分にする時は、ゴミ箱に捨てないで下さい。汚染を最小限に抑え、地球環境の最大限の保護のために、製品をリサイクルして下さい。廃電気電子機器 (WEEE) の回収とリサイクルについての情報は、弊社ホームページ www.aopen.com の "Green Products" (環境に優しい製品) をご覧下さい。

廢棄及回收處理

為了保護環境，請勿將本產品當作一般廢棄物處理。為減少環境污染，維護地球資源，本產品報廢時，請回收本產品。

有關收集和回收廢棄電子電氣設備 (WEEE) 的更多信息，請參考我們的網頁 www.aopen.com "綠色產品" 的資訊。

FCC caution

Non-modification Statement:

Changes or modifications not expressly approved by the party responsible for compliance could void the user's authority to operate the equipment.

FCC Radiation Exposure Statement:

This equipment complies with FCC radiation exposure limits set forth for an uncontrolled environment. This equipment should be installed and operated with minimum distance 20cm between the radiator & your body.

This device is restricted to indoor use

This device complies with Industry Canada licence-exempt RSS standard(s).

Operation is subject to the following two conditions:

- (1) This device may not cause interference, and
- (2) This device must accept any interference, including interference that may cause undesired operation of the device.

Le présent appareil est conforme aux CNR d'Industrie Canada applicables aux appareils radio exempts de licence.

L'exploitation est autorisée aux deux conditions suivantes:

- (1) l'appareil ne doit pas produire de brouillage, et
- (2) l'utilisateur de l'appareil doit accepter tout brouillage radioélectrique subi, même si le brouillage est susceptible d'en compromettre le fonctionnement.

This device complies with RSS 210 of Industry Canada. This Class B device meets all the requirements of the Canadian interference-causing equipment regulations.

Cet appareil numérique de la Classe B respecte toutes les exigences du Règlement sur le matériel brouilleur du Canada.

Instruktion til bortskaffelse (Danish)

Af hensyn til vores miljø bedes De ikke bortskaffe denne elektroniske enhed i en almindelig affaldsspand. For at mindske forurening og sikre beskyttelse af miljøet bedes De genbruge produktet. For yderligere information vedrørende indsamling og genbrug af elektronik-affald (Waste Electrical and Electronic Equipment (WEEE)) er De velkommen til at besøge vores website www.aopen.com og læse nærmere under "Green Products".

Verwijderingsinstructie (Dutch)

Om mogelijke schade aan het milieu of de menselijke gezondheid door ongecontroleerde afvalverwijdering te voorkomen, moet u dit elektronisch product scheiden van andere soorten afval en op een verantwoorde manier recyclen. Verwijder dit product dan ook alstublieft niet samen met ander huishoudelijk afval. Voor meer informatie over de verzameling en recycling van elektrisch afval en elektronische apparatuur (WEEE), nodigen we u uit om onze homepage te bezoeken www.aopen.com onder "Green Products".

Instruction de Disposition (French)

Pour une meilleure protection de la terre, ne jetez pas ce dispositif électronique dans la poubelle municipale lors de la disposition. Pour éliminer la pollution et assurer la plus grande protection de l'environnement global, réutilisez s'il vous plaît le produit. Pour plus d'informations sur la gestion des déchets d' Equipements Electriques et Electroniques (DEEE ou WEEE), vous êtes invité à visiter notre site à www.aopen.com sous "Green Products".

Entsorgungsanleitung (German)

Zum besseren Schutze unseres Planeten, schmeissen Sie elektrische Geräte bitte nicht in öffentliche Mülleimer. Zur Verringerung der Verschmutzung und zur Sicherstellung grösstmöglichen Schutzes der Umwelt recyceln Sie bitte das Produkt. Für mehr Informationen zum Sammeln und Recyceln von elektrischen und elektronischen Müll (WEEE) besuchen Sie bitte unsere Homepage unter www.aopen.com unter dem Punkt "Green Products".

Istruzioni per lo smaltimento (Italian)

Per una migliore salvaguardia del nostro pianeta, si prega di non gettare questo dispositivo elettronico nei normali rifiuti al momento dell'eliminazione. Per ridurre al minimo l'inquinamento ed assicurare la massima protezione dell'ambiente, si prega di riciclare il prodotto. Per maggiori informazioni riguardanti la raccolta ed il riciclaggio delle apparecchiature elettriche ed elettroniche residue (WEEE), siete invitati a visitare la nostra homepage www.aopen.com alla voce "Green Products".

Instruksjoner for Resirkulering og Oppsamling (Norwegian)

For å beskytte vår planet, kast ikke dette elektroniske utstyret sammen med vanlig avfall. For å beskytte vår natur og miljø, vennligst resirkuler dette produktet. For mer informasjon om oppsamling og resirkulering i henhold til Waste Electrical and Electronic Equipment (WEEE), se vår hjemmeside på www.aopen.com under "Green Products".

REEE - Programa de Tratamento de Resíduos de Equipamentos Eléctricos e Electrónicos (Portugese)

Para melhor protecção ambiental do nosso planeta terra, não coloque o dispositivo electrónico no receptáculo de lixo municipal. Para minimizar a poluição e garantir protecção máxima do ambiente global, recicle o produto. Para mais informações sobre acerca da recolha e reciclagem de Equipamento Eléctrico e Electrónico (WEEE), convidamos-lhe a visitar nossa página na Internet em www.aopen.com sobre "Green Products".

Instrucciones para depositar los productos electrónicos (Spanish)

Para proteger mejor el medio ambiente, por favor, no deposite los productos electrónicos en los contenedores de basura tradicionales. Para reducir la contaminación y proteger el medio ambiente se recomienda que los recicle. Para más información acerca de dónde depositar y cómo reciclar Equipos Electrónicos y Desperdicios Electrónicos (WEEE), por favor,

visite la página web www.aopen.com entre en la sección Productos Ecológicos ("Green Products").

Kassering (Swedish)

För att bättre värna om vår jord bör denna elektroniska utrustning ej kasseras tillsammans med vanligt avfall. För att minimera mängden föroreningar och så långt som möjligt skydda den globala miljön bör produkten återvinnas. För vidare information om insamling och återvinning av uttjänta elektriska och elektroniska produkter (Waste Electrical and Electronic Equipment, WEEE), besök avsnittet "Green Products" på vår hemsida, www.aopen.com.

Copyright

Copyright of this publication belongs to AOPEN Inc. AOPEN reserves the right to change the content of this publication without obligation to notify any party of such changes or revisions. No part of this publication may be reproduced, transcribed, transmitted, translated into any language, and stored in a retrieval system in any form or by any means electronically, mechanically, optically without the prior written permission of AOPEN Inc.

Disclaimer

AOPEN makes no warranties or representations, either expressed or implied, with respect to the content herein and specifically disclaims any warranties, merchantability of fitness for any particular purpose.

AOPEN and AOPEN logos used herein are registered trademarks of AOPEN Inc. All other brand names and trademarks are owned by their respective owners.

Copyright © 2019 by AOPEN Inc.

All rights reserved.

Chrome, Chromebox and Chromebase are
Registered trademarks of Google Inc.

Federal Communication Commission Interference Statement

This equipment has been tested and found to comply with the limits for a Class B digital device, pursuant to Part 15 of the FCC Rules. These limits are designed to provide reasonable protection against harmful interference in a residential installation. This equipment generates, uses, and can radiate radio frequency energy and, if not installed and used in accordance with the instructions, may cause harmful interference to radio communications. However, there is no guarantee that interference will not occur in a particular installation. If this equipment does cause harmful interference to radio or television reception, which can be determined by turning the equipment off and on, the user is encouraged to try to correct the interference by one or more of the following measures:

- Reorient or relocate the receiving antenna.
- Increase the separation between the equipment and receiver.
- Connect the equipment into an outlet on a circuit different from that to which the receiver is connected.
- Consult the dealer or an experienced radio/TV technician for help.

FCC Caution:

This device complies with Part 15 of the FCC Rules. Operation is subject to the following two conditions: (1) This device may not cause harmful interference, and (2) this device must accept any interference received, including interference that may cause undesired operation.

1. Safety Instructions

1. Please read these safety instructions carefully.
 2. Please keep this User's Manual for reference.
 3. Please disconnect this device from its power source before cleaning. Do not use liquid or sprayed detergent for cleaning. Use a lightly moistened sheet or cloth for cleaning.
 4. Make sure the device is connected to the power source with the correct voltage, frequency and amperage.
 5. All cautions and warnings on the device should be noted and followed.
 6. Do not pour any liquid into any opening of this device; this could cause a fire or electrical shock.
 7. Do not disassemble the device. For safety reasons, the device should only be handled by qualified service personnel.
 8. If one of the following situations arises, get the device checked by qualified service personnel:
 - a. Liquid has penetrated the device.
 - b. The device has been exposed to moisture.
 - c. The device has not worked well or you cannot get it to work according to user's manual.
 - d. The device has been dropped and damaged.
 - e. The device has obvious signs of breakage.
 9. Caution on use of battery: Use the battery recommended by the manufacturer or the same type of battery installed by the manufacturer. If the incorrect battery is used, it may cause an explosion or can present a fire hazard. Recycle or discard used batteries according to the manufacturer's instructions or your local authority.
-  **ATTENTION! Danger d'explosion**
lorsque la batterie est remplacée de
façon incorrecte.
10. Ambient operating temperature for this equipment is: 0~ 40 degrees Celsius. (32~104 degrees Fahrenheit)
 11. Wall Mounting Holder needs to be an UL 1678 approved product.

ENERGY STAR Certification

ENERGY STAR is a U.S. Environmental Protection Agency voluntary program that helps businesses and individuals save money and protect our climate through superior energy efficiency. AOPEN products that have the ENERGY STAR logo complies with the ENERGY STAR standard.



The monitor and computer are automatically set to sleep after 8 and 30 minutes of user inactivity. To restart your device after sleep mode, click the mouse, press any key on the keyboard or touch screen.

Additional information on the potential energy and financial savings of the power management feature can be found on the EPA ENERGY STAR Power Management website at <http://www.energystar.gov/powermanagement>.

Additional information on the ENERGY STAR program and its environmental benefits are available on the EPA ENERGY STAR Web site at <http://www.energystar.gov>.

Risk of Overheating!

- a. Do not install Chromebox Commercial 2 in an enclosed space.
- b. Be sure the heat sink that is on the top and both side of the Chromebox Commercial 2 has at least 5cm of clear space for heat dissipation.
- c. Do not place any objects on the top side of the Chromebox Commercial 2.
- d. Do not use Chromebox Commercial 2 when the ambient temperature is higher than 40°C.

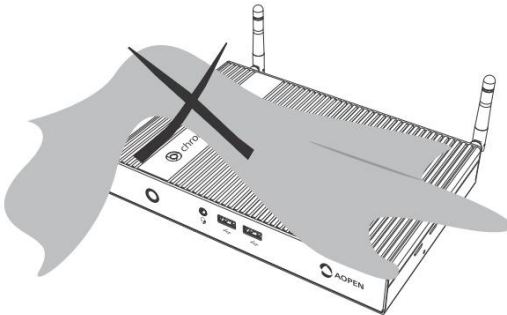
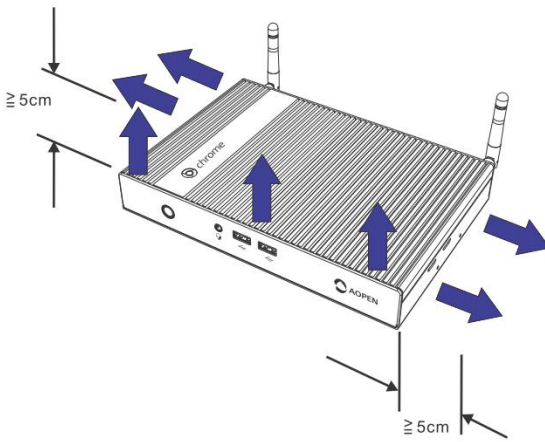

2. Packing List

2-1. Standard Accessories

- 1. Chromebox Commercial 2 x 1
- 2. Power adaptor x 1
- 3. Power cord x 1
- 4. Dual Band Antenna x2
- 5. DC-in jack holder x 1
- 6. HDMI cable holder x 2
- 7. Wall mount holder
- 8. User Manual x 1
- 9. Warranty Card x 1

1.

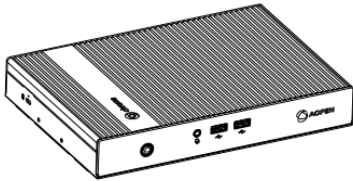

2.



3.



4.

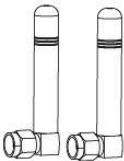

5.

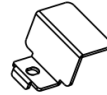

6.



7.

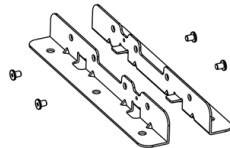

8.



9.

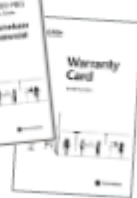

Note:

Please note that the images are for visual representation purposes only and may differ from the actual product

2-2. Optional Accessories

- a. RJ50 to RS232 adaptor



- b. VESA bracket support standard VESA hole 100x 100mm & 75mm x 75mm.

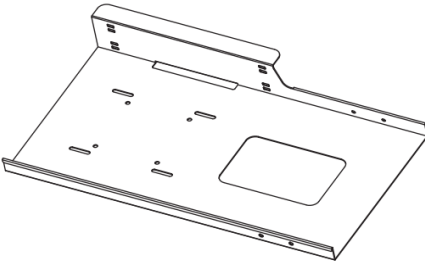

3. Product Introduction

3-1 Getting started

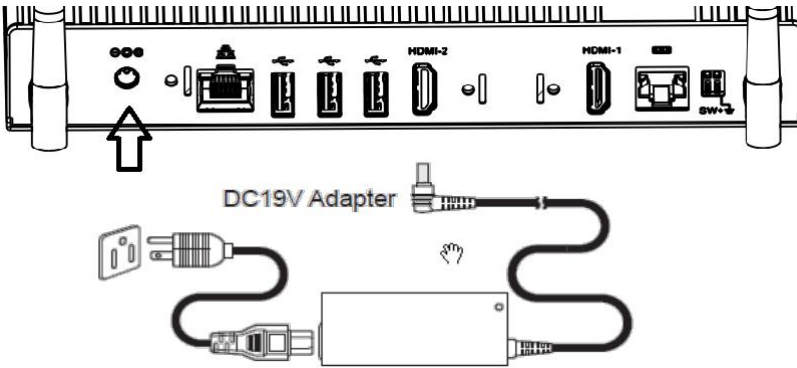

- Connect the AC power cord to your power adapter
- Connect the DC plug into your Chromebox Commercial 2 DC input port.
- Plug the AC power cord into a 100 V~240 V power source.

Caution:

When you install devices or cables, please ensure that DC plug is removed prior to plugging in powered devices.

IMPORTANT!

- Only use the recommended adapter and cable that came with your Chromebox Commercial 2.
- We strongly recommend that you use a grounded wall socket while using your Chromebox Commercial 2.
- The socket outlet must be easily accessible and near your Chromebox Commercial 2.
- To remove your Chromebox Commercial 2 from its main power supply, unplug your AC plug from the AC power socket first.

NOTE:

Power adapter information:

- Input voltage: 100-240 Vac
- Input frequency: 50-60 Hz
- Rating output current: 3.42A / 65W, 4.74A / 90W
- Rating output voltage: 19 V

WARNING!

The power adapter may become hot when in use. Do not cover the adapter and keep it away from your body.

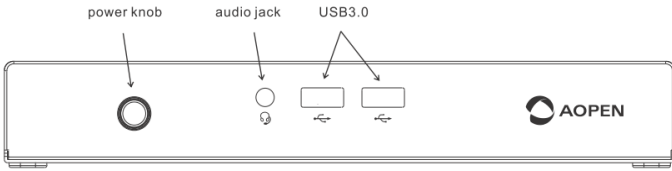
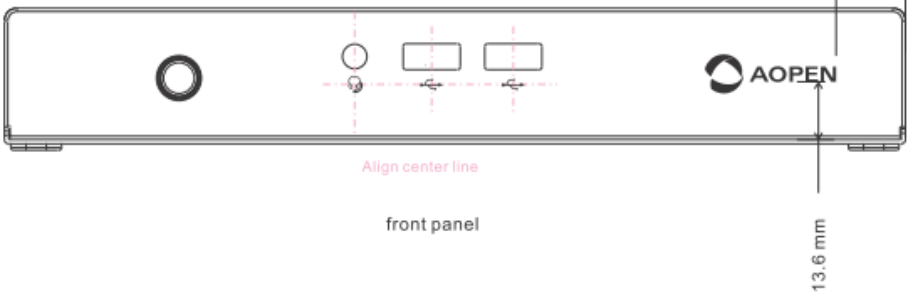

Side View

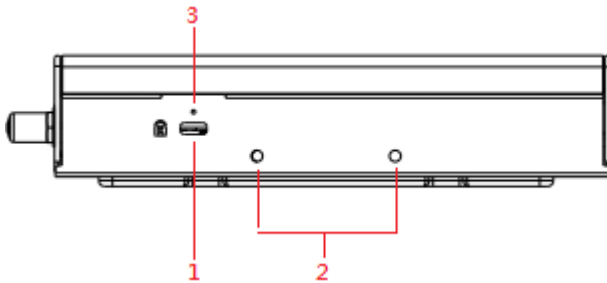

1. Kensington Lock
2. Wall Mounting Kit Screw Hole
3. Recovery Button

Rear View

Celeron CPU

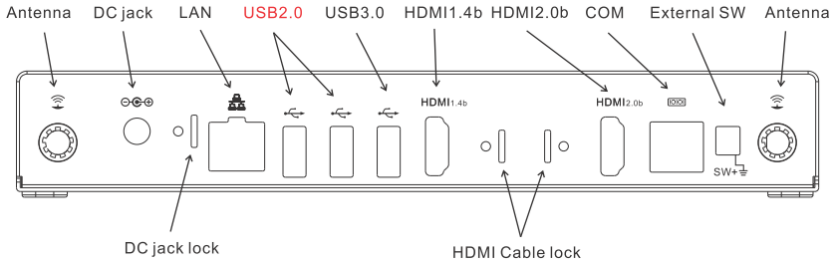

Core I CPU

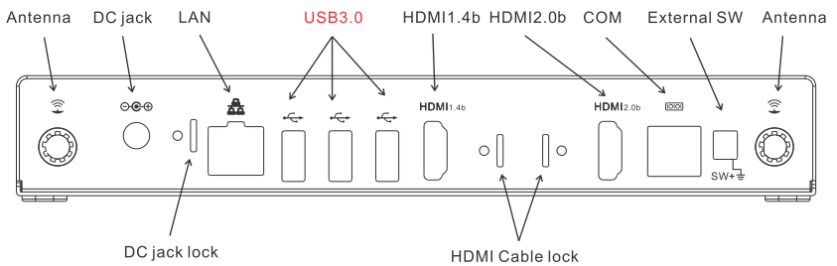

3-3. Dimensions

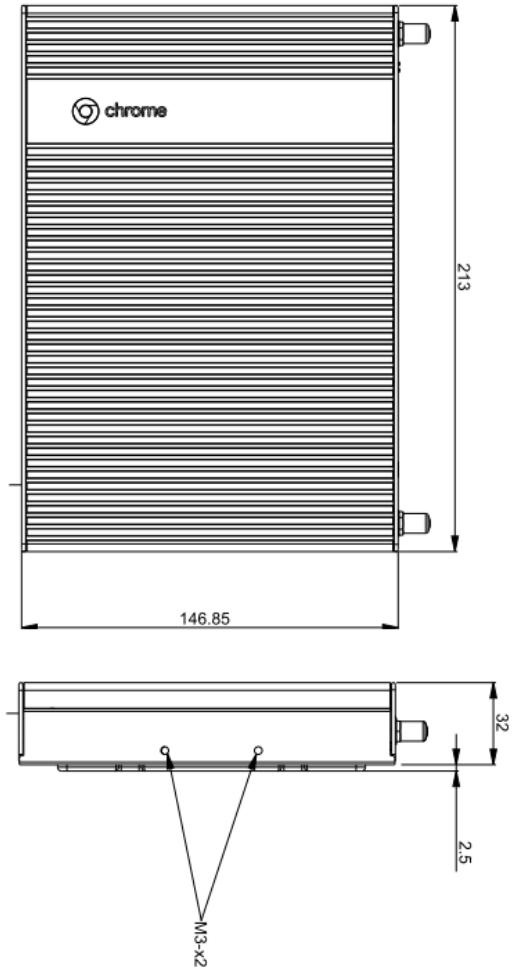

Unit: mm

3-4. Knowing Your Chromebox Commercial 2

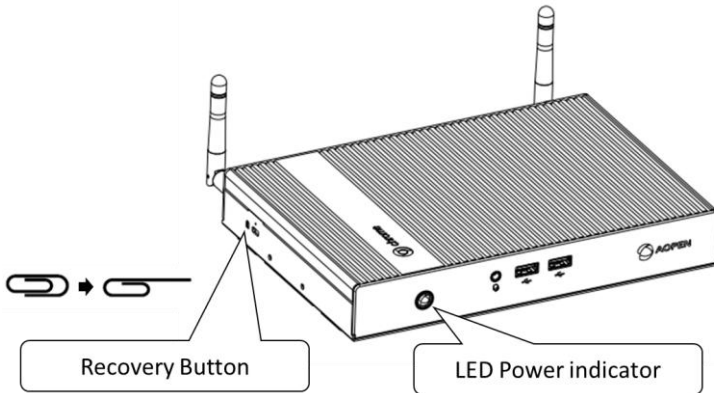

Power Button

The power button allows you to turn the Chromebox Commercial 2 on or off. You can use the power button to put your Chromebox Commercial 2 to sleep mode or hold the clip in the power button for four (4) seconds to force shutdown the device. To power on, press the power button for 0.6 to 1 seconds.

IMPORTANT!

Forcing the system to restart may result in data loss. We strongly recommend that you back up your data regularly.

Recovery button

If you need to invoke the Chromebox Commercial 2 into Recovery mode, you can insert a paper clip and press the RECOVERY BUTTON and press the Power button. Release the RECOVERY BUTTON after a second.

IMPORTANT!

Performing a recovery on your Chromebox Commercial 2 reinstalls the operating system and restores the original factory settings, removing all associated Google Accounts (including the owner) and clearing all local data from the hard drive. Locally saved files and saved networks are deleted for all accounts. The Google Accounts themselves, and any data synced to the web through your Google Drive, are not affected by a system recovery.

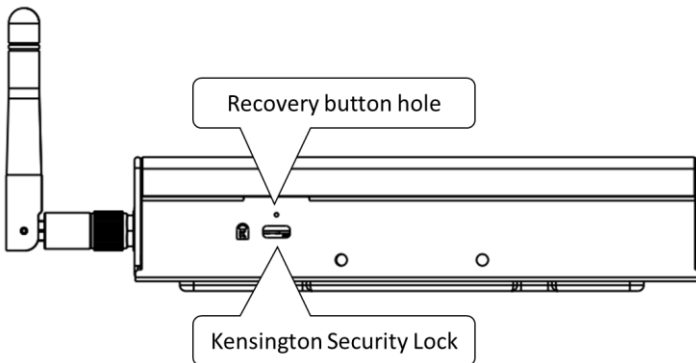

Kensington Security Lock

The Kensington security slot allows you to secure your Chromebox Commercial 2 by using Kensington® security products.

Antenna Assembly

Please set antenna to up orientation, and then tighten the antenna metal ring. Notice do not use the antenna reverse operation.

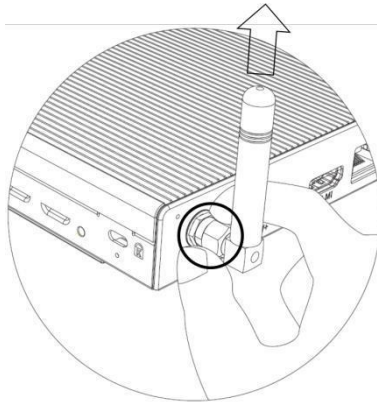

Ethernet Wake on LAN (WOL)

The WOL function on Chrombox Commercial 2 thru Ethernet RJ45 connector is enabled by default for Sleep Mode, when the system is operating on AC mains power. (S5 power off not supported)

If you need to disable the WOL function on the Chromebox Commercial 2, Please follow below procedures:

1. Log in to chrome OS and press **Ctrl + Alt + T** to enter the Chrome OS command mode.
2. Key-in below command to disable WOL. To use this function, turn Verification Off (Developer Mode).

```
crosh > shell
chronos@localhost / $ sudo su
Localhost / # set_wake_on_lan false
```

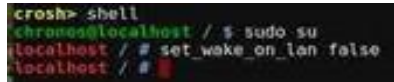

Note : The default WOL function will be restored after reboot.

External Power Switch

The external power switch at rear side of Chromebox Commercial 2 allows you to extend the power switch base your demand, and you can decide your own switch specification and cable length depends on the application, just follow the wire gauge and strip length provided below.

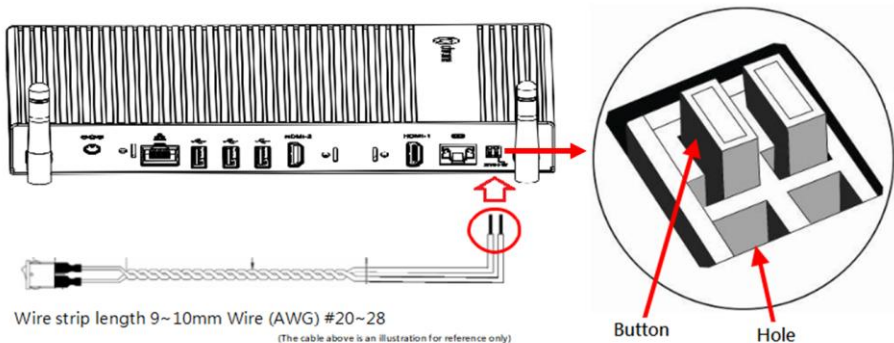

The design of external power switch is a screw-less type spring clamp pluggable terminal block, you can insert a wire by press the button on the terminal, please refer to the procedure below.

Step 1 Please prepare a pin or rod that hard enough for pushing the button on the terminal block

Step 2 Push the button in the end and hold it

Step 3 Insert the wire into the hole and make sure the stripped portion is fully inserted

Step 4 Release the pin or rod then the wire will clamp by the terminal block

Step1

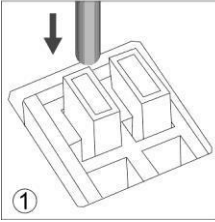

Step2

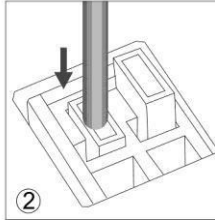

Step3

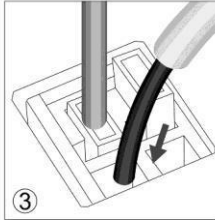

Step4

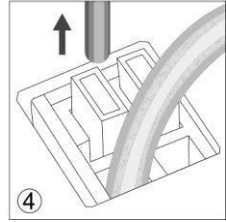

DC-In Jack Holder & HDMI cable holder

The DC-In jack holder & HDMI cable holder allows you to fix the DC-in jack & HDMI cable holder firmly on the Chromebox Commercial 2, for various environment and location where the Chromebox Commercial 2 be used, to prevent the DC-in & HDMI cable falling off and cause any in convenient, data loss or damage to Chromebox Commercial 2 system itself.

Remove the screw that comes with Chromebox Commercial 2 in the DC-In jack screw hole & HDMI holder screw hole first, then follow the below steps for applying the DC-In jack holder & HDMI cable holder on Chromebox Commercial 2 :

Step 1 Insert the DC-In jack & HDMI cable to Chromebox Commercial 2

Step 2 Apply the DC-In jack holder & HDMI cable holder following the directions shows in the instruction diagram

Step 3 Fasten the DC-in jack holder & HDMI cable holder with the screw

Step1

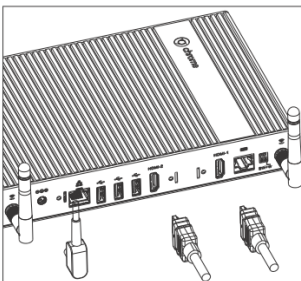

Step2

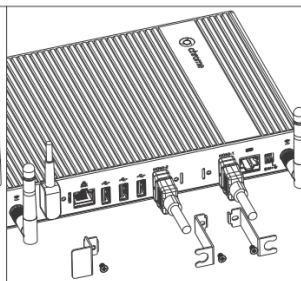

Step3

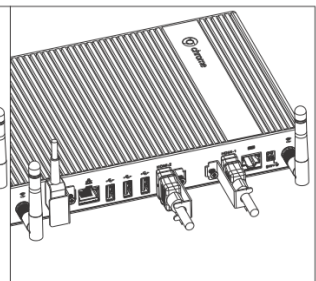

PS. If user would like to use HDMI cable holder needs to find a proper HDMI cable which can be fixed by the holder.

APAR(AC Power Auto Recovery) behavior

AOPEN Chromebox Commercial 2 has RTC battery & will returns to its previous state when plugged in.

- If the device was shut down correctly – then it stays shut down if power is restored.
- If there has been a power failure condition, the device will restart when power is restored.

5. Contact Information

AOPEN America
AOPEN America Inc.
2150 N. First Street, Ste. 300, San Jose, CA 95131, USA
Telephone: (+1) 888-972-6736

AOPEN Australia and New Zealand
AOPEN ANZ
AOPEN Australia & New Zealand
Level 2, 21 Cremorne Street
Cremorne VIC 3121, Australia.
Telephone: (+61) 3 9427 7379

AOPEN EMEA
AOPEN Computer BV
Stadionlaan 151-153
5246 JT Rosmalen
The Netherlands
Telephone: (+31) 73 646 6400

AOPEN Japan
AOPEN Japan Corp.
〒101-0021 東京都千代田区外神田 2-4-4
第1電波ビル3階
日本
Telephone: (+81) 3 5298 1668

AOPEN Inc.
AOPEN Inc.
21F, No.92, Sec. 1, Xintai 5th Rd., Xizhi Dist.,
New Taipei City 22102,
Taiwan (R.O.C.)
Telephone: (+886) 2 7710 1195

AOPEN China
艾尔鹏国际贸易(上海)有限公司
中國上海市宜山路 889 號
齊來大廈 506 室,
Telephone: (+86) 216 225-8622

6. Chrome Care

Please contact your authorized reseller or authorized distributor in the first instance for all warranty queries.

For direct AOPEN Care in regard to AOPEN chrome products please see below:

Australia/ New Zealand

chromecare-au@aopen.com

Americas - including South America, Canada

chromecare-usa@aopen.com

Europe

chromecare-eu@aopen.com

Japan

chromecare-jp@aopen.com

Asia - Africa

chromecare-asia@aopen.com

All other areas:

chromecare-global@aopen.com

Part No.:

Doc. No.: 17-021-502