



# FCC RADIO TEST REPORT

Applicant : AOPEN Inc.  
Address : No. 68 Ruiguang Rd., Neihu District, Taipei City 114,  
Taiwan  
Equipment : AOPEN Chromebox Commercial 2  
Model No. : BC5000  
Trade Name : AOPEN  
FCC ID : YEW-BC5000I7265

**I HEREBY CERTIFY THAT :**

The sample was received on Apr. 15, 2019 and the testing was carried out on Jun. 08, 2019 at CerpPASS Technology Corp. The test result refers exclusively to the test presented test model / sample. Without written approval of CerpPASS Technology Corp., the test report shall not be reproduced except in full.

Approved by:

Mark Liao / Supervisor

Laboratory Accreditation:

CerpPASS Technology Corporation Test Laboratory





CONTENTS

- 1. Summary of Test Procedure and Test Results .....5
  - 1.1. Applicable Standards .....5
- 2. Test Configuration of Equipment under Test .....6
  - 2.1. Feature of Equipment under Test.....6
  - 2.2. Carrier Frequency of Channels .....7
  - 2.3. Test Mode and Test Software .....8
  - 2.4. Description of Test System.....9
  - 2.5. General Information of Test.....10
  - 2.6. Measurement Uncertainty .....11
- 3. Test Equipment and Ancillaries Used for Tests .....12
- 4. Antenna Requirements .....13
  - 4.1. Standard Applicable .....13
  - 4.2. Antenna Construction and Directional Gain.....13
- 5. Test of AC Power Line Conducted Emission.....14
  - 5.1. Test Limit .....14
  - 5.2. Test Procedures .....14
  - 5.3. Typical Test Setup .....15
  - 5.4. Test Result and Data .....16
  - 5.5. Test Photographs .....24
- 6. Test of Spurious Emission (Radiated) .....25
  - 6.1. Test Limit .....25
  - 6.2. Test Procedures .....25
  - 6.3. Typical Test Setup .....26
  - 6.4. Test Result and Data (9kHz ~ 30MHz).....27
  - 6.5. Test Result and Data (30MHz ~ 1GHz).....27
  - 6.6. Test Result and Data (1GHz ~ 40GHz).....35
  - 6.7. Restricted Bands of Operation .....109
  - 6.8. Test Photographs (30MHz ~ 1GHz) .....110
  - 6.9. Test Photographs (1GHz ~ 40GHz) .....111
- 7. On Time, Duty Cycle and Measurement methods .....112
  - 7.1. Test Limit .....112
  - 7.2. Test Procedure .....112
  - 7.3. Test Setup Layout .....112
  - 7.4. Test Result and Data .....112
  - 7.5. Measurement Methods .....112
- 8. 6dB Bandwidth & 99% Occupied Bandwidth .....114
  - 8.1. Test Limit .....114
  - 8.2. Test Procedure .....114
  - 8.3. Test Setup Layout .....114
  - 8.4. Test Result and Data (6dB Bandwidth) .....114
  - 8.5. Test Result and Data (99% Occupied Bandwidth) .....115
- 9. 26dB Bandwidth & 99% Occupied Bandwidth .....124
  - 9.1. Test Limit .....124
  - 9.2. Test Procedure .....124



- 9.3. Test Setup Layout ..... 124
- 9.4. Test Result and Data (26dB Bandwidth) ..... 124
- 9.5. Test Result and Data (99% Occupied Bandwidth) ..... 126
- 10. Average Power..... 151
  - 10.1. Test Limit ..... 151
  - 10.2. Test Procedure ..... 152
  - 10.3. Test Setup Layout ..... 152
  - 10.4. Test Result and Data ..... 153
- 11. Power Spectral Density ..... 155
  - 11.1. Test Limit ..... 155
  - 11.2. Test Procedure ..... 155
  - 11.3. Test Setup Layout ..... 155
  - 11.4. Test Result and Data ..... 156
- 12. Frequency Stability ..... 174
  - 12.1. Test Procedure ..... 174
  - 12.2. Test Setup Layout ..... 174
  - 12.3. Test Result and Data ..... 175
- 13. Radio Frequency Exposure..... 176
  - 13.1. Applicable Standards ..... 176
  - 13.2. EUT Specification ..... 176
  - 13.3. Test Results ..... 176
  - 13.4. Calculation..... 177
  - 13.5. Maximum Permissible Exposure ..... 178



History of this test report

Report No.	Issue Date	Description
TEFE1903256	Jun. 12, 2019	Original



# 1. Summary of Test Procedure and Test Results

## 1.1. Applicable Standards

ANSI C63.4:2014

ANSI C63.10:2013

FCC Rules and Regulations Part 15 Subpart E §15.407

First R&O 14-30

KDB662911

KDB789033

KDB644545

FCC Rule	Description of Test	Result
15.203	Antenna Requirement	PASS
15.207(a)	AC Power Line Conducted Emission	PASS
15.407(b) 15.209	Radiated Spurious Emission	PASS
15.407(a)	26 dB & Occupied Bandwidth	PASS
15.407	6 dB Bandwidth	PASS
15.407 (a) & (a)(3)	Average Power	PASS
15.407(a)	Power Spectral Density	PASS
15.407(g)	Frequency Stability	PASS
15.407(c)	Automatically Discontinue Transmission	PASS
2.1091	Radio Frequency Exposure	PASS

\*The principle of judgment is made according to the laboratory's reporting control and measurement uncertainty standard procedures.

\*This EUT has been also tested and compiled with the requirement of FCC Part 15, Subpart B, recorded in a separate test report(TEFD1901352).



## 2. Test Configuration of Equipment under Test

### 2.1. Feature of Equipment under Test

WLAN Module	Intel / Dual Band Wireless-AC 7265(Stone Peak)
Frequency Range	BT / BLE: 2400-2483.5MHz 802.11b/g/n: 2400-2483.5MHz 802.11a/n/ac: 5150-5250MHz, 5250-5350MHz, 5470-5725MHz, 5725-5850MHz
Modulation Type	BT: GFSK, $\pi/4$ -DQPSK, 8DPSK BLE: GFSK 802.11b: CCK, DQPSK, DBPSK 802.11g/n/a: BPSK, QPSK, 16QAM, 64QAM 802.11ac: BPSK, QPSK, 16QAM, 64QAM, 256QAM
Data Rate	BT: GFSK: 1Mbps, $\pi/4$ -DQPSK: 2Mbps, 8DPSK: 3Mbps BLE: GFSK: 1Mbps WLAN: 802.11b: 1, 2, 5.5, 11Mbps 802.11g: 6, 9, 12, 18, 24, 36, 48, 54Mbps 802.11n: MCS0 – MCS15, HT20/40 802.11a: 6, 9, 12, 18, 24, 36, 48, 54Mbps 802.11ac: MCS0 – MCS9, VHT20/40/80
Antenna Type	Dipole Antenna
Antenna Gain	2400-2483.5MHz: 3.53dBi 5150-5250MHz: 2.52dBi 5250-5350MHz: 2.52dBi 5470-5725MHz: 2.02dBi 5725-5850MHz: 1.59dBi
Data Rate	BT: GFSK: 1Mbps, $\pi/4$ -DQPSK: 2Mbps, 8DPSK: 3Mbps BLE: GFSK: 1Mbps WLAN: 802.11b: 1, 2, 5.5, 11Mbps 802.11g: 6, 9, 12, 18, 24, 36, 48, 54Mbps 802.11n: MCS0 – MCS15, HT20/40 802.11a: 6, 9, 12, 18, 24, 36, 48, 54Mbps 802.11ac: MCS0 – MCS9, VHT20/40/80
Adapter	Chicony \ A11-065N1A INPUT: 100-240V~1.7A 50-60Hz OUTPUT: 19V / 3.42A 65W  Chicony \ A16-090P1A INPUT: 100-240V~1.5A 50-60Hz OUTPUT: 19V / 4.74A 90W

Note:

1. For a more detailed features description, please refer to the manufacturer's specifications or the User's Manual.



## 2.2. Carrier Frequency of Channels

Band: 5150MHz-5250MHz

802.11a, 802.11n HT20, 802.11ac VHT20

Channel	Frequency(MHz)	Channel	Frequency(MHz)
<b>*36</b>	<b>5180</b>	<b>*44</b>	<b>5220</b>
40	5200	<b>*48</b>	<b>5240</b>

802.11n HT40, 802.11ac VHT40

Channel	Frequency(MHz)	Channel	Frequency(MHz)
<b>*38</b>	<b>5190</b>	<b>*46</b>	<b>5230</b>

802.11ac VHT80

Channel	Frequency(MHz)
<b>*42</b>	<b>5210</b>

Band: 5250MHz -5350MHz

802.11a, 802.11n HT 20, 802.11ac VHT20

Channel	Frequency(MHz)	Channel	Frequency(MHz)
<b>*52</b>	<b>5260</b>	<b>*60</b>	<b>5300</b>
56	5280	<b>*64</b>	<b>5320</b>

802.11n HT 40, 802.11ac VHT40

Channel	Frequency(MHz)	Channel	Frequency(MHz)
<b>*54</b>	<b>5270</b>	<b>*62</b>	<b>5310</b>

802.11ac VHT80

Channel	Frequency(MHz)
<b>*58</b>	<b>5290</b>

Band: 5470MHz -5725MHz

802.11a, 802.11n HT 20, 802.11ac VHT20

Channel	Frequency(MHz)	Channel	Frequency(MHz)
<b>*100</b>	<b>5500</b>	<b>*116</b>	<b>5580</b>
104	5520	132	5660
108	5540	136	5680
112	5560	<b>*140</b>	<b>5700</b>

802.11n HT 40, 802.11ac VHT40

Channel	Frequency(MHz)	Channel	Frequency(MHz)
<b>*102</b>	<b>5510</b>	<b>*134</b>	<b>5670</b>
<b>*110</b>	<b>5550</b>		

802.11ac VHT80

Channel	Frequency(MHz)
<b>*106</b>	<b>5530</b>

Band: 5725MHz -5850MHz

802.11a, 802.11n HT20, 802.11ac VHT20

Channel	Frequency(MHz)	Channel	Frequency(MHz)
<b>*149</b>	<b>5745</b>	161	5805
153	5765	<b>*165</b>	<b>5825</b>
<b>*157</b>	<b>5785</b>		

802.11n HT40, 802.11ac VHT40

Channel	Frequency(MHz)	Channel	Frequency(MHz)
<b>*151</b>	<b>5755</b>	<b>*159</b>	<b>5795</b>

802.11ac VHT80

Channel	Frequency(MHz)
<b>*155</b>	<b>5775</b>

Note: Channels remarked \* are selected to perform test.



### 2.3. Test Mode and Test Software

- a. During testing, the interface cables and equipment positions were varied according to ANSI C63.10.
- b. The complete test system included remote workstation and EUT for RF test. The remote workstation included Notebook.

An executive program, "DRTU v.11.1833.0-08103" under WIN 7 was executed to transmit and receive data via WLAN.

- c. The following test modes were performed for the test:

Conducted Emissions from the AC mains power ports	
Test Mode	Operating Description
1	802.11a (6Mbps)
2	802.11ac VHT20 (6.5Mbps)
3	802.11ac VHT40 (13.5Mbps)
4	802.11ac VHT80 (29.3Mbps)
caused "Test Mode 3" generated the worst case, it was reported as the final data.	
Radiation Emissions (30MHz ~ 1GHz)	
Test Mode	Operating Description
1	802.11a (6Mbps)
2	802.11ac VHT20 (6.5Mbps)
3	802.11ac VHT40 (13.5Mbps)
4	802.11ac VHT80 (29.3Mbps)
caused "Test Mode 3" generated the worst case, they were reported as the final data.	
Radiation Emissions (1GHz ~ 40GHz)	
Test Mode	Operating Description
1	802.11a (6Mbps)
2	802.11ac VHT20 (6.5Mbps)
3	802.11ac VHT40 (13.5Mbps)
4	802.11ac VHT80 (29.3Mbps)
caused "Test Mode 1~4" generated the worst case, they were reported as the final data.	





### 2.4. Description of Test System

RF Conducted				
Equipment	Brand	Model	Length/Type	Power cord/Length/Type
Notebook	DELL	Latitude E5470	N/A	Adapter / 1.8m / NS
AP	D-link	DIR-868L	N/A	Adapter / 1.5m / NS
Network cable	N/A	N/A	1.2m / NS	N/A
Network cable	N/A	N/A	1.2m / NS	N/A
Radiated Emissions				
Equipment	Brand	Model	Length/Type	Power cord/Length/Type
Notebook	DELL	Latitude E5470	N/A	Adapter / 1.8m / NS
AP	D-link	DIR-868L	N/A	Adapter / 1.5m / NS
Network cable	N/A	N/A	15m / NS	N/A
Network cable	N/A	N/A	15m / NS	N/A
AC Power Line Conducted Emission				
Equipment	Brand	Model	Length/Type	Power cord/Length/Type
Notebook	DELL	Latitude E5470	N/A	Adapter / 1.8m / NS
AP	D-link	DIR-868L	N/A	Adapter / 1.5m / NS
Network cable	N/A	N/A	15m / NS	N/A
Network cable	N/A	N/A	15m / NS	N/A

**2.5. General Information of Test**

Test Site	<b>Cerpass Technology Corporation Test Laboratory</b> Address: No.10, Ln. 2, Lianfu St., Luzhu Dist., Taoyuan City 33848, Taiwan (R.O.C.) Tel:+886-3-3226-888 Fax:+886-3-3226-881 Address: No.68-1, Shihbachongsi, Shihding Township, New Taipei City 223, Taiwan, R.O.C. Tel: +886-2-2663-8582	
	FCC	TW1079, TW1061, TW1439
	IC	4934E-1, 4934E-2
	VCCI	T-2205 for Telecommunication Test C-4663 for Conducted emission test R-4399, R-4218 for Radiated emission test G-10812, G-10813 for radiated disturbance above 1GHz
Frequency Range Investigated:	Conducted: from 150kHz to 30 MHz Radiation: from 30 MHz to 40,000MHz	
Test Distance:	The test distance of radiated emission from antenna to EUT is 3 M.	

Test Item	Test Site	Tested Date	Environmental Conditions	Tested By
RF Conducted	RFCON01-NK	2019/06/11	22°C / 63%	Nick Guan
Radiated Emissions	3M02-NK	2019/06/06	23°C / 54%	Spree Yeh
RF Conduction	CON01-NK	2019/06/08	24°C / 45%	Leon Huang



## 2.6. Measurement Uncertainty

Measurement Item	Uncertainty
Radiated Spurious Emission(9KHz~30MHz)	±3.405dB
Radiated Spurious Emission(30MHz~1GHz)	±5.326dB
Radiated Spurious Emission(1GHz~40GHz)	±5.011dB
6dB Bandwidth	±4.407%
26dB Bandwidth	±4.459%
Occupied Bandwidth	±4.403%
Peak Output Power(Conducted Power Meter)	±1.31dB
Power Spectral Density	±2.106dB
Duty Cycle	±0.17%
Frequency Stability	±156.543Hz
Temperature	±1.2°C
Humidity	±2.7%



### 3. Test Equipment and Ancillaries Used for Tests

Test Item	Radiated Emissions				
Test Site	Semi Anechoic Room(3M02-NK)				
Instrument	Manufacturer	Model No	Serial No	Calibration Date	Valid Date
Bilog Antenna	Schwarzbeck	VULB9168	275	2018/09/17	2019/09/16
Active Loop Antenna	EMCO	6507	40855	2019/05/24	2020/05/23
Horn Antenna	EMCO	3115	31589	2019/04/01	2020/03/31
Horn Antenna	EMCO	3116	31974	2018/09/07	2019/09/06
EMI Receiver	ROHDE & SCHWARZ	ESCI	101423	2018/06/11	2019/06/10
Spectrum Analyzer	ROHDE & SCHWARZ	FSP 40	100219	2018/07/03	2019/07/02
Preamplifier	EM Electronics corp.	EM330	60660	2019/03/11	2020/03/10
Preamplifier	EMC INSTRUMENTS	EMC051845SE	980333	2018/09/18	2019/09/17
Bluetooth Tester	ROHDE & SCHWARZ	CBT	101133	2019/04/07	2020/04/06
Cable-3in1(30M-1G)	HARBOUR INDUSTRIES	LL142	CCE1316	2018/09/12	2019/09/11
Cable-0.5m(1G-40G)	Rapidtek	40GHZ 50CM	38MS-38MS50314	2019/04/09	2020/04/08
Cable-3m(1G-40G)	Rapidtek	40GHZ 300CM	38MS-38MS300314	2019/04/09	2020/04/08
Cable-8m(1G-40G)	Rapidtek	40GHZ 800CM	38MS-38MS800314	2019/04/10	2020/04/09
E3	AUDIX	v8.2014-8-6	RK-000529	NA	NA

Test Item	RF Conducted				
Test Site	RFCON01-NK				
Instrument	Manufacturer	Model No	Serial No	Calibration Date	Valid Date
Spectrum Analyzer	ROHDE & SCHWARZ	FSP 40	100219	2018/07/03	2019/07/02
Bluetooth Tester	ROHDE & SCHWARZ	CBT	101133	2019/04/07	2020/04/06
Attenuator	KEYSIGHT	8491B	MY39250705	2018/09/04	2019/09/03
TEMP & HUMIDITY CHAMBER	T-MACHINE	TMJ-9712	T-12-040111	2018/08/30	2019/08/29
Power Sensor	Anritsu	MA2411B	1207295	2019/04/11	2020/04/10

Test Item	AC Power Line Conducted Emission				
Test Site	CON01-NK				
Instrument	Manufacturer	Model No	Serial No	Calibration Date	Valid Date
EMI Receiver	ROHDE & SCHWARZ	ESCI	100821	2018/9/12	2019/09/11
Line Impedance Stabilization Network	Schwarzbeck	NSLK 8127	8127-740	2018/6/13	2019/06/12
Pulse Limiter	ROHDE & SCHWARZ	ESH3-Z2	101933	2018/9/4	2019/09/03
E3	AUDIX	v8.2014-8-6	RK-000531	NA	NA



## 4. Antenna Requirements

### 4.1. Standard Applicable

For intentional device, according to FCC 47 CFR Section 15.203, an intentional radiator shall be designed to ensure that no antenna other than that furnished by the responsible party shall be used with the device.

And according to FCC 47 CFR Section 15.407 (a), if transmitting antennas of directional gain greater than 6dBi are used, the power shall be reduced by the amount in dB that the directional gain of the antenna exceeds 6dBi.

### 4.2. Antenna Construction and Directional Gain

Antenna Type	Dipole Antenna
Antenna Gain	2412MHz-2462MHz: ANT A: 3.53 dBi ; ANT B: 3.53 dBi 5180MHz-5240MHz: ANT A: 2.52 dBi ; ANT B: 2.52 dBi 5260MHz-5320MHz: ANT A: 2.52 dBi ; ANT B: 2.52 dBi 5500MHz-5700MHz: ANT A: 2.02 dBi ; ANT B: 2.02 dBi 5745MHz-5825MHz: ANT A:1.59 dBi ; ANT B: 1.59 dBi

2412-2462MHz
For Power directional gain= $G_{ant}= 3.53$ dBi For PSD directional gain = $10 \log[(10^{G1/20} + 10^{G2/20})^2 / N_{ANT}]$ = 6.54 (dBi)
5180MHz-5240MHz
For Power directional gain= $G_{ant}= 2.52$ dBi For PSD directional gain = $10 \log[(10^{G1/20} + 10^{G2/20})^2 / N_{ANT}]$ = 5.53 (dBi)
5260MHz-5320MHz
For Power directional gain= $G_{ant}= 2.52$ dBi For PSD directional gain = $10 \log[(10^{G1/20} + 10^{G2/20})^2 / N_{ANT}]$ = 5.53 (dBi)
5500MHz-5700MHz
For Power directional gain= $G_{ant}= 2.02$ dBi For PSD directional gain = $10 \log[(10^{G1/20} + 10^{G2/20})^2 / N_{ANT}]$ = 5.03 (dBi)
5745MHz-5825MHz
For Power directional gain= $G_{ant}= 1.59$ dBi For PSD directional gain = $10 \log[(10^{G1/20} + 10^{G2/20})^2 / N_{ANT}]$ = 4.60 (dBi)



## 5. Test of AC Power Line Conducted Emission

### 5.1. Test Limit

Conducted Emissions were measured from 150 kHz to 30 MHz with a bandwidth of 9 KHz, according to the methods defined in ANSI C63.4-2014. The EUT was placed on a nonmetallic stand in a shielded room 0.8 meters above the ground plane. The interface cables and equipment positioning were varied within limits of reasonable applications to determine the position produced maximum conducted emissions.

Frequency (MHz)	Quasi Peak (dB $\mu$ V)	Average (dB $\mu$ V)
0.15 – 0.5	66-56*	56-46*
0.5 – 5.0	56	46
5.0 – 30.0	60	50

\*Decreases with the logarithm of the frequency.

### 5.2. Test Procedures

- The EUT was placed 0.4 meter from the conducting wall of the shielding room was kept at least 80 centimeters from any other grounded conducting surface.
- Connect EUT to the power mains through a line impedance stabilization network (LISN).
- All the support units are connecting to the other LISN.
- The LISN provides 50 ohm coupling impedance for the measuring instrument.
- The FCC states that a 50 ohm, 50 micro-Henry LISN should be used.
- Both sides of AC line were checked for maximum conducted interference.
- The frequency range from 150 kHz to 30 MHz was searched.
- Set the test-receiver system to Peak Detect Function and Specified Bandwidth with Maximum Hold Mode.



### 5.3. Typical Test Setup

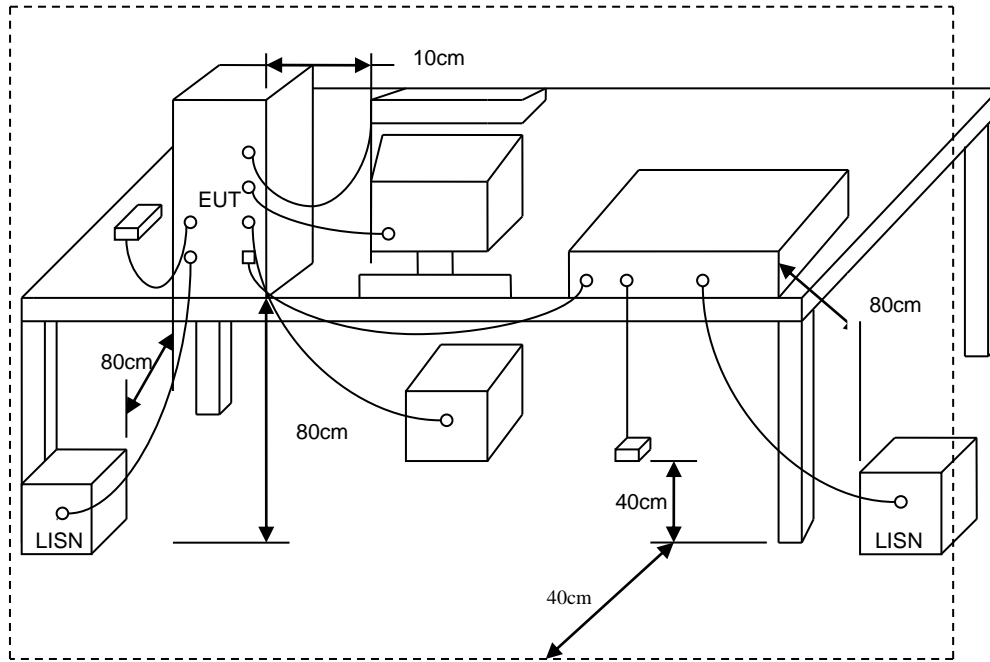



5.4. Test Result and Data

Power	: AC 120V / 60Hz	Pol/Phase	: LINE
Test Mode	: Mode 3, Band1		:

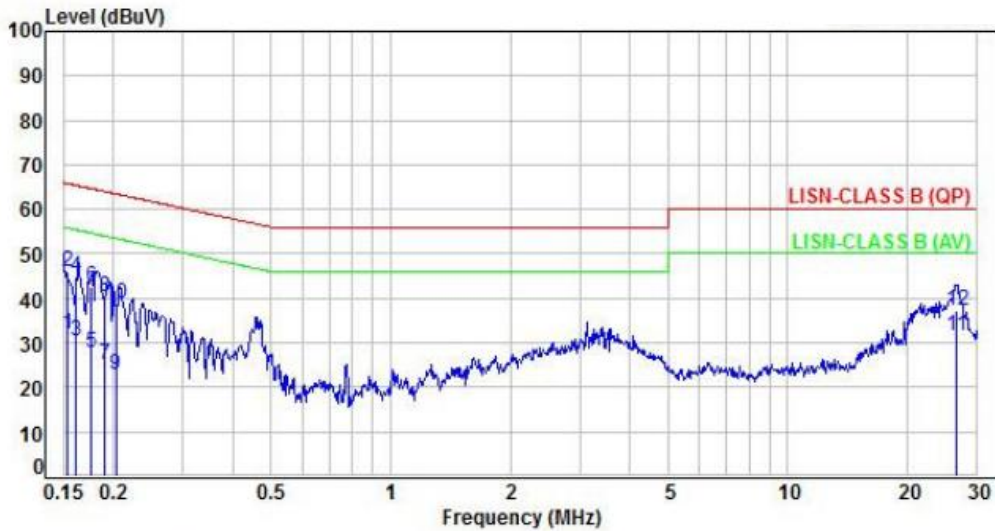

No.	Frequency (MHz)	Factor (dB)	Reading (dBuV)	Level (dBuV)	Limit (dBuV)	Margin (dB)	Detector	P/F
1	0.15	9.92	21.93	31.85	55.81	-23.96	Average	P
2	0.15	9.92	36.08	46.00	65.81	-19.81	QP	P
3	0.16	9.92	20.54	30.46	55.42	-24.96	Average	P
4	0.16	9.92	35.01	44.93	65.42	-20.49	QP	P
5	0.18	9.92	17.80	27.72	54.64	-26.92	Average	P
6	0.18	9.92	32.62	42.54	64.64	-22.10	QP	P
7	0.19	9.92	15.04	24.96	54.03	-29.07	Average	P
8	0.19	9.92	30.56	40.48	64.03	-23.55	QP	P
9	0.20	9.92	12.85	22.77	53.49	-30.72	Average	P
10	0.20	9.92	28.78	38.70	63.49	-24.79	QP	P
11	26.56	10.87	20.77	31.64	50.00	-18.36	Average	P
12	26.56	10.87	26.33	37.20	60.00	-22.80	QP	P

Note: Level=Reading+Factor  
 Margin=Level-Limit  
 Factor=(LISN or ISN or Current Probe)Factor + Cable Loss





Power	: AC 120V / 60Hz	Pol/Phase	: NEUTRAL
Test Mode	: Mode 3, Band1		

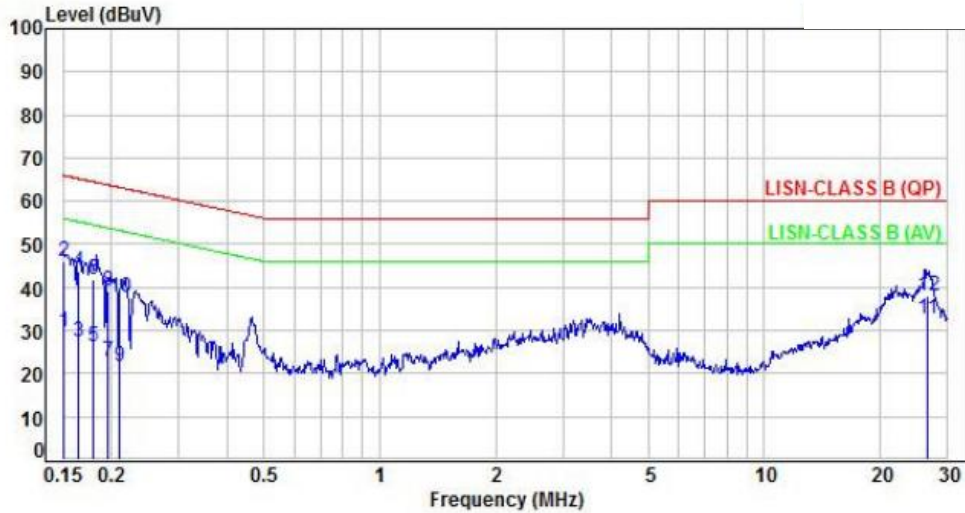

No.	Frequency (MHz)	Factor (dB)	Reading (dBuV)	Level (dBuV)	Limit (dBuV)	Margin (dB)	Detector	P/F
1	0.15	9.95	19.71	29.66	55.96	-26.30	Average	P
2	0.15	9.95	35.92	45.87	65.96	-20.09	QP	P
3	0.16	9.95	17.60	27.55	55.28	-27.73	Average	P
4	0.16	9.95	33.91	43.86	65.28	-21.42	QP	P
5	0.18	9.95	16.16	26.11	54.55	-28.44	Average	P
6	0.18	9.95	31.75	41.70	64.55	-22.85	QP	P
7	0.20	9.95	12.96	22.91	53.74	-30.83	Average	P
8	0.20	9.95	29.24	39.19	63.74	-24.55	QP	P
9	0.21	9.95	11.89	21.84	53.17	-31.33	Average	P
10	0.21	9.95	27.83	37.78	63.17	-25.39	QP	P
11	26.55	10.89	21.66	32.55	50.00	-17.45	Average	P
12	26.55	10.89	27.30	38.19	60.00	-21.81	QP	P

Note: Level=Reading+Factor  
 Margin=Level-Limit  
 Factor=(LISN or ISN or Current Probe)Factor + Cable Loss



Power	: AC 120V / 60Hz	Pol/Phase	: LINE
Test Mode	: Mode 3, Band2		:

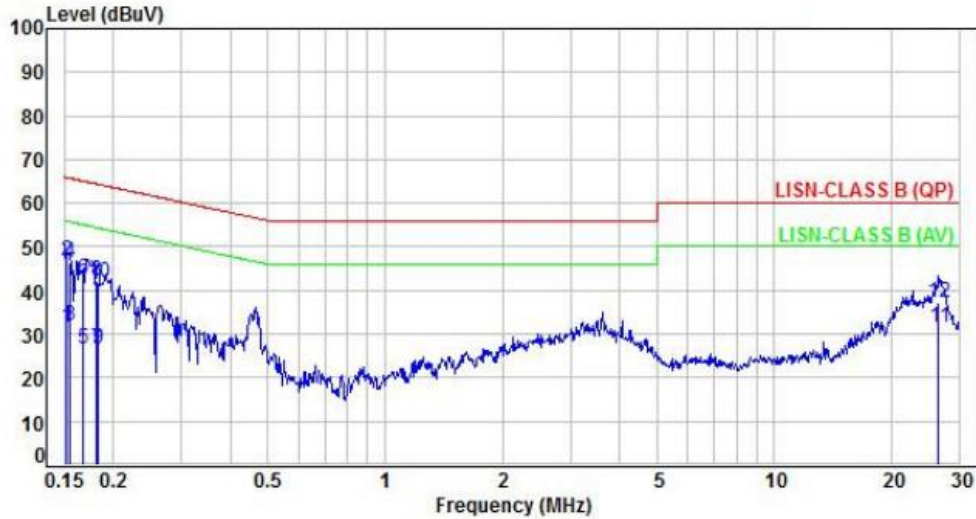

No.	Frequency (MHz)	Factor (dB)	Reading (dBuV)	Level (dBuV)	Limit (dBuV)	Margin (dB)	Detector	P/F
1	0.15	9.92	21.73	31.65	55.88	-24.23	Average	P
2	0.15	9.92	36.76	46.68	65.88	-19.20	QP	P
3	0.15	9.92	22.15	32.07	55.76	-23.69	Average	P
4	0.15	9.92	36.39	46.31	65.76	-19.45	QP	P
5	0.17	9.92	16.60	26.52	55.05	-28.53	Average	P
6	0.17	9.92	32.54	42.46	65.05	-22.59	QP	P
7	0.18	9.92	16.83	26.75	54.41	-27.66	Average	P
8	0.18	9.92	32.13	42.05	64.41	-22.36	QP	P
9	0.18	9.92	16.69	26.61	54.38	-27.77	Average	P
10	0.18	9.92	31.99	41.91	64.38	-22.47	QP	P
11	26.40	10.86	20.77	31.63	50.00	-18.37	Average	P
12	26.40	10.86	26.26	37.12	60.00	-22.88	QP	P

Note: Level=Reading+Factor  
 Margin=Level-Limit  
 Factor=(LISN or ISN or Current Probe)Factor + Cable Loss



Power	: AC 120V / 60Hz	Pol/Phase	: NEUTRAL
Test Mode	: Mode 3, Band2		

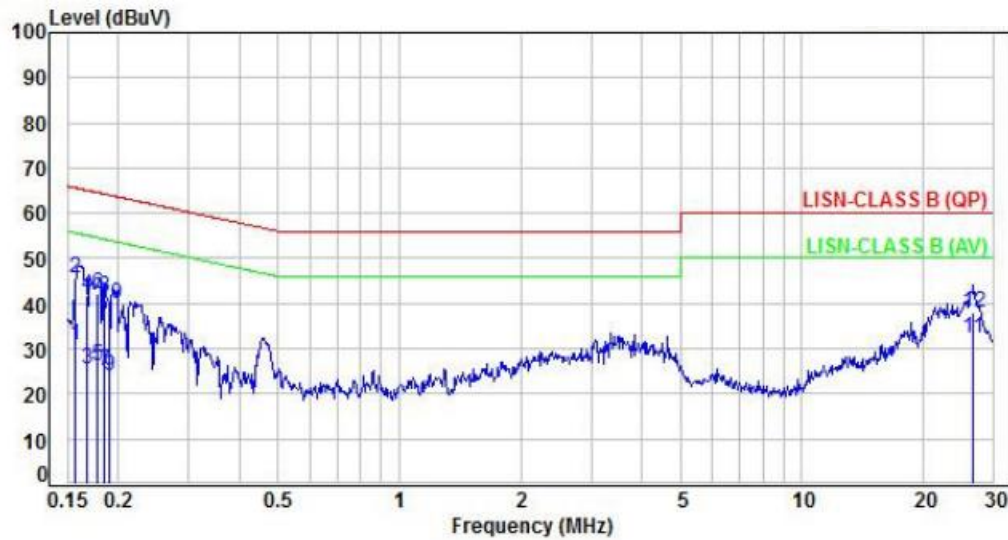

No.	Frequency (MHz)	Factor (dB)	Reading (dBuV)	Level (dBuV)	Limit (dBuV)	Margin (dB)	Detector	P/F
1	0.16	9.95	20.72	30.67	55.68	-25.01	Average	P
2	0.16	9.95	35.55	45.50	65.68	-20.18	QP	P
3	0.17	9.95	15.69	25.64	55.10	-29.46	Average	P
4	0.17	9.95	32.05	42.00	65.10	-23.10	QP	P
5	0.18	9.95	16.38	26.33	54.60	-28.27	Average	P
6	0.18	9.95	32.09	42.04	64.60	-22.56	QP	P
7	0.18	9.95	15.03	24.98	54.30	-29.32	Average	P
8	0.18	9.95	31.30	41.25	64.30	-23.05	QP	P
9	0.19	9.95	13.87	23.82	54.05	-30.23	Average	P
10	0.19	9.95	30.08	40.03	64.05	-24.02	QP	P
11	26.53	10.89	21.60	32.49	50.00	-17.51	Average	P
12	26.53	10.89	26.98	37.87	60.00	-22.13	QP	P

Note: Level=Reading+Factor  
 Margin=Level-Limit  
 Factor=(LISN or ISN or Current Probe)Factor + Cable Loss



Power	: AC 120V / 60Hz	Pol/Phase	: LINE
Test Mode	: Mode 3, Band3		:

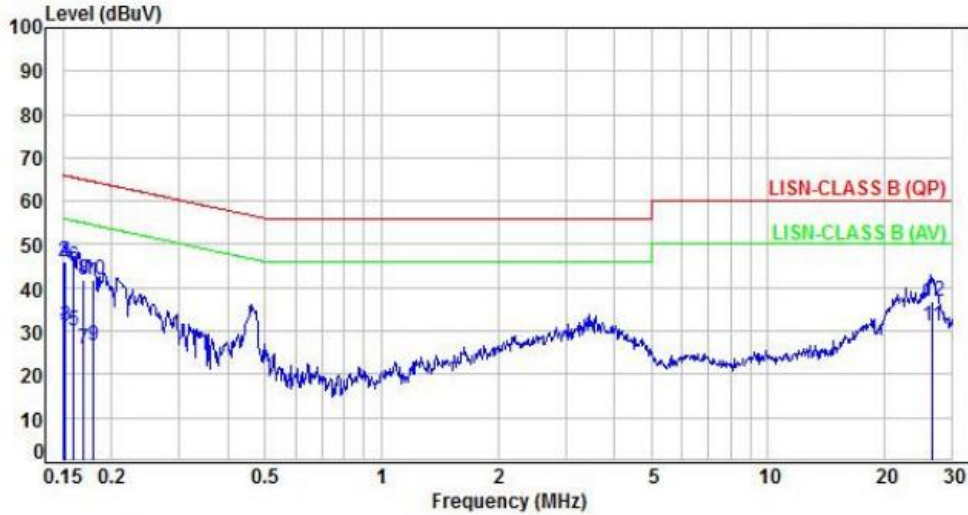

No.	Frequency (MHz)	Factor (dB)	Reading (dBuV)	Level (dBuV)	Limit (dBuV)	Margin (dB)	Detector	P/F
1	0.15	9.92	20.21	30.13	55.96	-25.83	Average	P
2	0.15	9.92	36.13	46.05	65.96	-19.91	QP	P
3	0.15	9.92	21.17	31.09	55.87	-24.78	Average	P
4	0.15	9.92	36.24	46.16	65.87	-19.71	QP	P
5	0.16	9.92	20.24	30.16	55.46	-25.30	Average	P
6	0.16	9.92	34.96	44.88	65.46	-20.58	QP	P
7	0.17	9.92	16.07	25.99	54.97	-28.98	Average	P
8	0.17	9.92	31.89	41.81	64.97	-23.16	QP	P
9	0.18	9.92	16.70	26.62	54.50	-27.88	Average	P
10	0.18	9.92	31.96	41.88	64.50	-22.62	QP	P
11	26.50	10.87	20.35	31.22	50.00	-18.78	Average	P
12	26.50	10.87	25.93	36.80	60.00	-23.20	QP	P

Note: Level=Reading+Factor  
 Margin=Level-Limit  
 Factor=(LISN or ISN or Current Probe)Factor + Cable Loss



Power	: AC 120V / 60Hz	Pol/Phase	: NEUTRAL
Test Mode	: Mode 3, Band3		

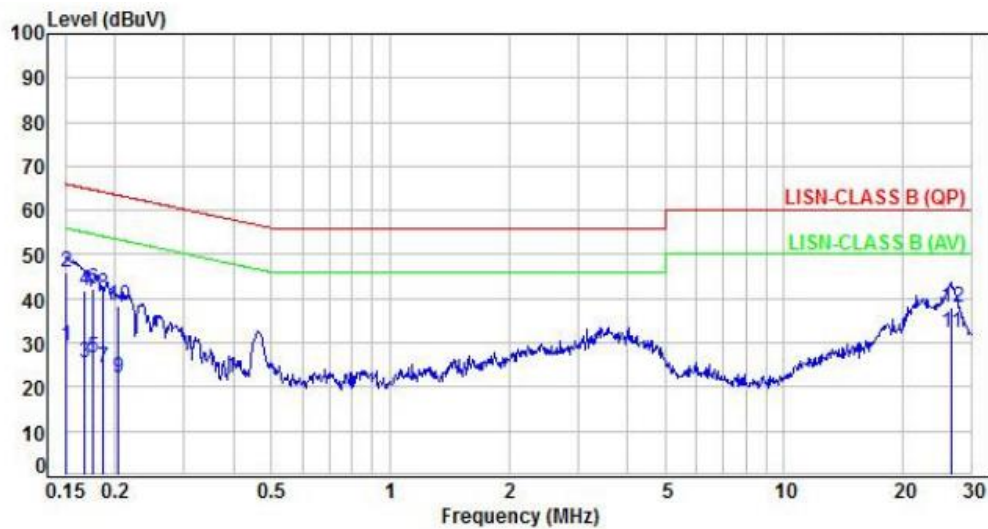

No.	Frequency (MHz)	Factor (dB)	Reading (dBuV)	Level (dBuV)	Limit (dBuV)	Margin (dB)	Detector	P/F
1	0.15	9.95	19.49	29.44	55.98	-26.54	Average	P
2	0.15	9.95	36.24	46.19	65.98	-19.79	QP	P
3	0.17	9.95	15.37	25.32	55.09	-29.77	Average	P
4	0.17	9.95	31.95	41.90	65.09	-23.19	QP	P
5	0.18	9.95	16.64	26.59	54.65	-28.06	Average	P
6	0.18	9.95	32.35	42.30	64.65	-22.35	QP	P
7	0.19	9.95	14.36	24.31	54.17	-29.86	Average	P
8	0.19	9.95	31.06	41.01	64.17	-23.16	QP	P
9	0.20	9.95	12.00	21.95	53.46	-31.51	Average	P
10	0.20	9.95	28.55	38.50	63.46	-24.96	QP	P
11	26.56	10.89	21.53	32.42	50.00	-17.58	Average	P
12	26.56	10.89	27.06	37.95	60.00	-22.05	QP	P

Note: Level=Reading+Factor  
 Margin=Level-Limit  
 Factor=(LISN or ISN or Current Probe)Factor + Cable Loss



Power	: AC 120V / 60Hz	Pol/Phase	: LINE
Test Mode	: Mode 3, Band4		:

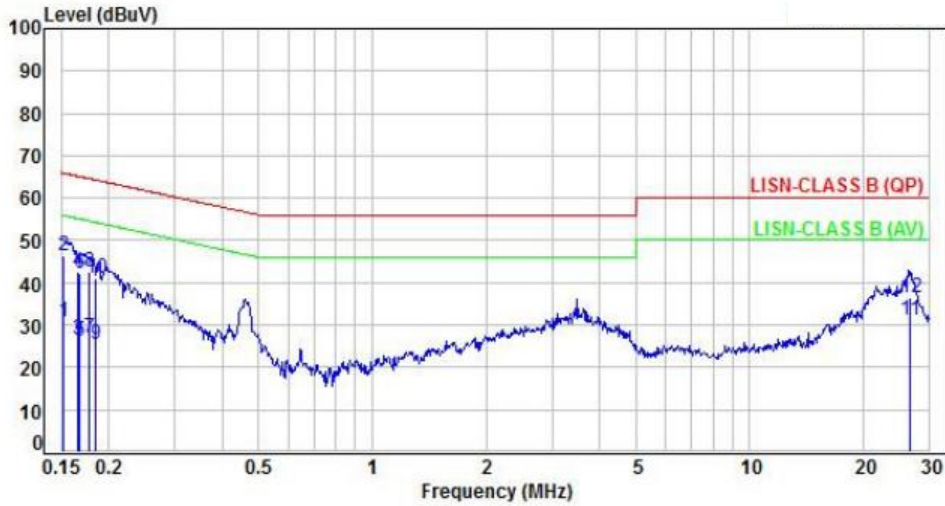

No.	Frequency (MHz)	Factor (dB)	Reading (dBuV)	Level (dBuV)	Limit (dBuV)	Margin (dB)	Detector	P/F
1	0.15	9.92	20.93	30.85	55.91	-25.06	Average	P
2	0.15	9.92	36.30	46.22	65.91	-19.69	QP	P
3	0.17	9.92	16.70	26.62	55.15	-28.53	Average	P
4	0.17	9.92	32.68	42.60	65.15	-22.55	QP	P
5	0.17	9.92	16.15	26.07	55.07	-29.00	Average	P
6	0.17	9.92	32.24	42.16	65.07	-22.91	QP	P
7	0.18	9.92	17.05	26.97	54.57	-27.60	Average	P
8	0.18	9.92	32.59	42.51	64.57	-22.06	QP	P
9	0.18	9.92	15.66	25.58	54.30	-28.72	Average	P
10	0.18	9.92	31.14	41.06	64.30	-23.24	QP	P
11	26.61	10.87	20.26	31.13	50.00	-18.87	Average	P
12	26.61	10.87	25.75	36.62	60.00	-23.38	QP	P

Note: Level=Reading+Factor  
 Margin=Level-Limit  
 Factor=(LISN or ISN or Current Probe)Factor + Cable Loss



Power	: AC 120V / 60Hz	Pol/Phase	: NEUTRAL
Test Mode	: Mode 3, Band4		

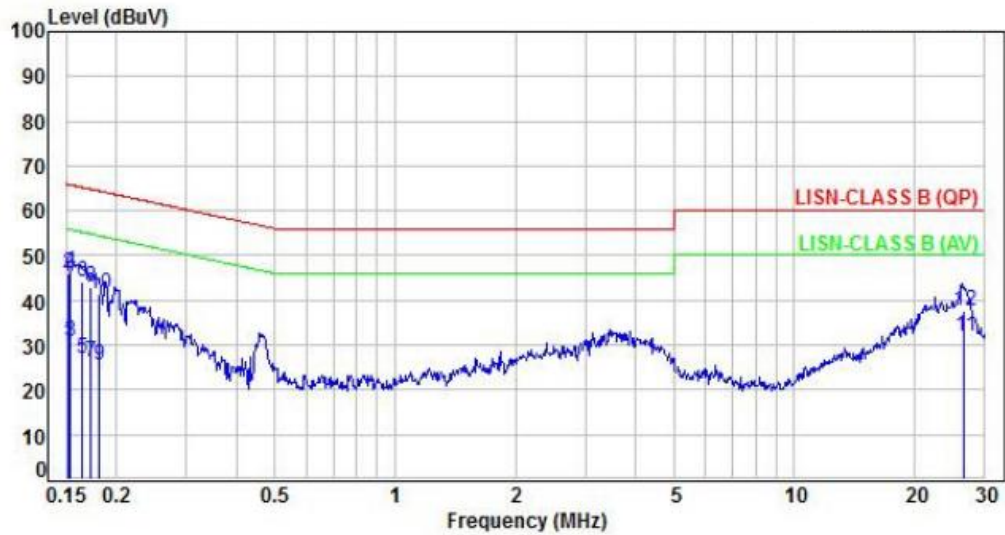

No.	Frequency (MHz)	Factor (dB)	Reading (dBuV)	Level (dBuV)	Limit (dBuV)	Margin (dB)	Detector	P/F
1	0.15	9.95	20.60	30.55	55.88	-25.33	Average	P
2	0.15	9.95	36.11	46.06	65.88	-19.82	QP	P
3	0.15	9.95	20.97	30.92	55.82	-24.90	Average	P
4	0.15	9.95	36.42	46.37	65.82	-19.45	QP	P
5	0.16	9.95	17.22	27.17	55.24	-28.07	Average	P
6	0.16	9.95	34.08	44.03	65.24	-21.21	QP	P
7	0.17	9.95	16.25	26.20	54.82	-28.62	Average	P
8	0.17	9.95	32.90	42.85	64.82	-21.97	QP	P
9	0.18	9.95	15.54	25.49	54.40	-28.91	Average	P
10	0.18	9.95	31.58	41.53	64.40	-22.87	QP	P
11	26.72	10.89	21.18	32.07	50.00	-17.93	Average	P
12	26.72	10.89	26.84	37.73	60.00	-22.27	QP	P

Note: Level=Reading+Factor  
 Margin=Level-Limit  
 Factor=(LISN or ISN or Current Probe)Factor + Cable Loss



## 6. Test of Spurious Emission (Radiated)

### 6.1. Test Limit

Undesirable emission limits. Except as shown in paragraph (b)(7) of this section, the maximum emissions outside of the frequency bands of operation shall be attenuated in accordance with the following limits:

- (1) For transmitters operating in the 5.15-5.25 GHz band: All emissions outside of the 5.15-5.35 GHz band shall not exceed an e.i.r.p. of  $-27$  dBm/MHz.
- (2) For transmitters operating in the 5.25-5.35 GHz band: All emissions outside of the 5.15-5.35 GHz band shall not exceed an e.i.r.p. of  $-27$  dBm/MHz.
- (3) For transmitters operating in the 5.47-5.725 GHz band: All emissions outside of the 5.47-5.725 GHz band shall not exceed an e.i.r.p. of  $-27$  dBm/MHz.
- (4) For transmitters operating in the 5.725-5.85 GHz band:  
All emissions shall be limited to a level of  $-27$  dBm/MHz at 75 MHz or more above or below the band edge increasing linearly to 10 dBm/MHz at 25 MHz above or below the band edge, and from 25MHz above or below the band edge increasing linearly to a level of 15.6 dBm/MHz at 5 MHz above or below the band edge, and from 5 MHz above or below the band edge increasing linearly to a level of 27dBm/MHz at the band edge.
- (5) The emission measurements shall be performed using a minimum resolution bandwidth of 1 MHz. A lower resolution bandwidth may be employed near the band edge, when necessary, provided the measured energy is integrated to show the total power over 1 MHz.
- (6) Unwanted emissions below 1 GHz must comply with the general field strength limits set forth in §15.209. Further, any U-NII devices using an AC power line are required to comply also with the conducted limits set forth in §15.207.
- (7) The provisions of §15.205 apply to intentional radiators operating under this section.
- (8) When measuring the emission limits, the nominal carrier frequency shall be adjusted as close to the upper and lower frequency band edges as the design of the equipment permits.

### 6.2. Test Procedures

- a. The EUT was placed on a rotatable table top 0.8 meter above ground.
- b. The EUT was set 3 meters from the interference receiving antenna which was mounted on the top of a variable height antenna tower.
- c. The table was rotated 360 degrees to determine the position of the highest radiation.
- d. The antenna is a broadband antenna and its height is varied between one meter and four meters above ground to find the maximum value of the field strength both horizontal polarization and vertical polarization of the antenna are set to make the measurement.
- e. For each suspected emission the EUT was arranged to its worst case and then tune the antenna tower (from 1 M to 4 M) and turn table (from 0 degree to 360 degrees) to find the maximum reading.
- f. Set the test-receiver system to Peak or CISPR quasi-peak Detect Function and specified bandwidth with Maximum Hold Mode.
- g. If the emission level of the EUT in peak mode was 3 dB lower than the limit specified, then testing will be stopped and peak values of EUT will be reported, otherwise, the emissions which do not have 3 dB margin will be repeated one by one using the quasi-peak method and reported.
- h. For testing above 1GHz, the emission level of the EUT in peak mode was 20dB lower than average limit (that means the emission level in peak mode also complies with the limit in average mode), then testing will be stopped and peak values of EUT will be reported, otherwise, the emissions will be measured in average mode again and reported.
- i. "Cone of radiation" has been considered to be 3dB bandwidth of the measurement antenna.





### 6.3. Typical Test Setup

Below 30MHz test setup

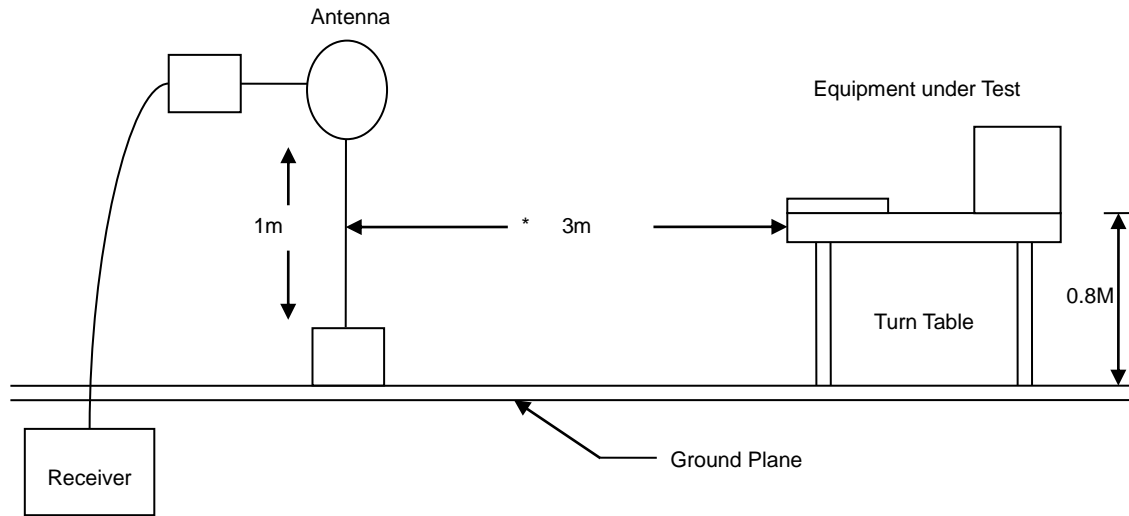

30MHz- 1GHz Test Setup

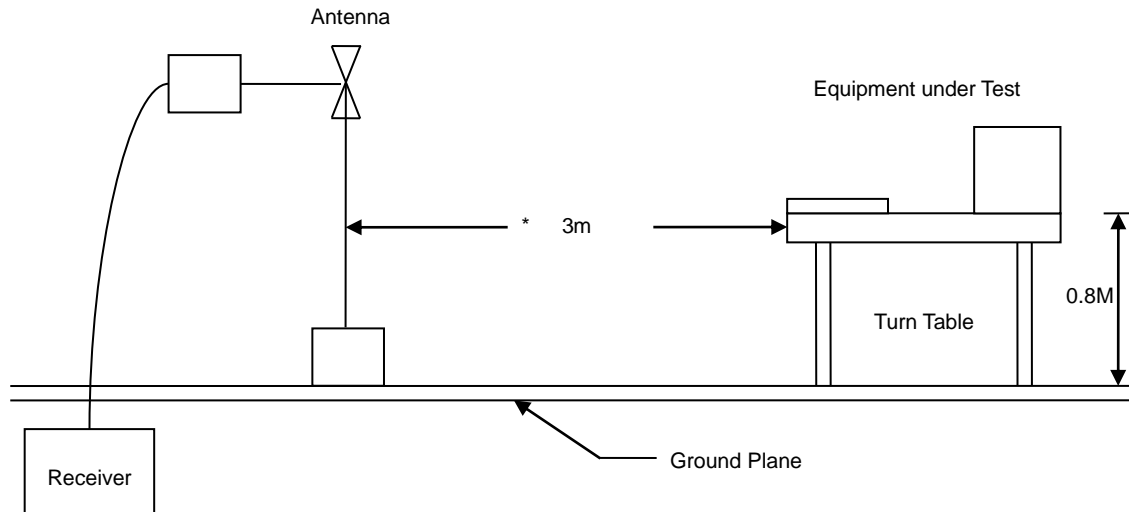

Above 1GHz Test Setup

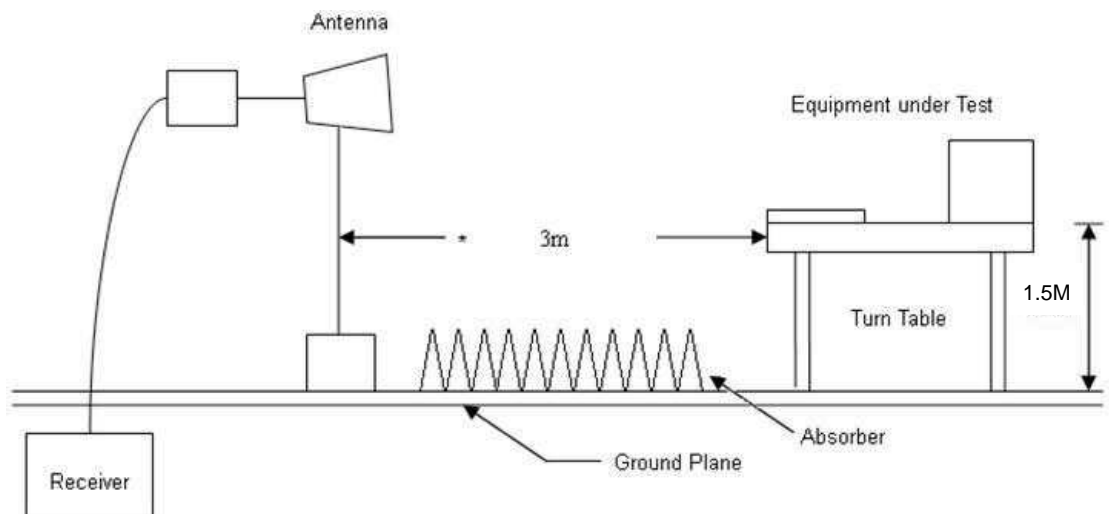



### 6.4. Test Result and Data (9kHz ~ 30MHz)

The 9kHz - 30MHz spurious emission is under limit 20dB more.

### 6.5. Test Result and Data (30MHz ~ 1GHz)

Power	: AC 120V / 60Hz	Pol/Phase	: VERTICAL
Test Mode	: Mode 3, Band 1		:

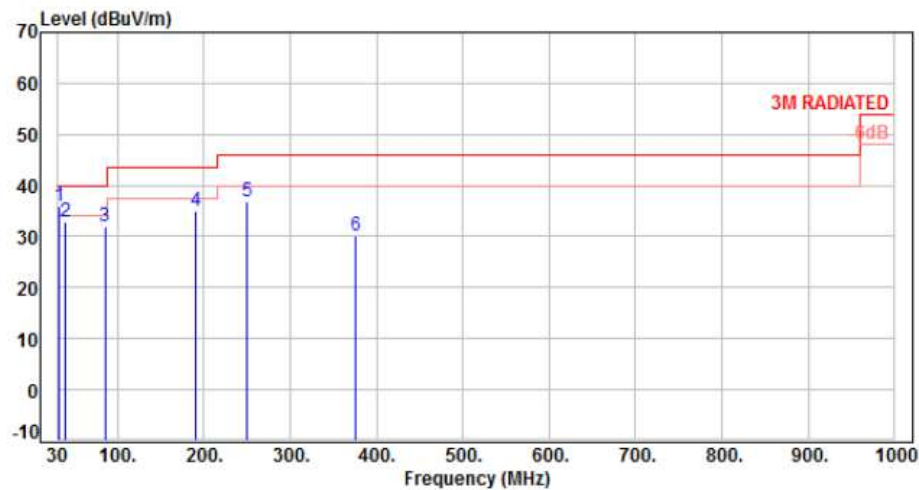

No.	Frequency (MHz)	Factor (dB)	Reading (dBUV)	Level (dBUV/m)	Limit (dBUV/m)	Margin (dB)	Detector	Height (cm)	Azimuth (deg)	P/F
1	31.94	-10.57	46.55	35.98	40.00	-4.02	QP	100	57	P
2	39.70	-9.71	42.48	32.77	40.00	-7.23	Peak	100	183	P
3	85.29	-14.85	46.80	31.95	40.00	-8.05	Peak	400	0	P
4	190.05	-11.97	46.94	34.97	43.50	-8.53	Peak	400	0	P
5	250.19	-10.37	47.32	36.95	46.00	-9.05	Peak	400	0	P
6	375.32	-6.51	36.73	30.22	46.00	-15.78	Peak	400	0	P

Note: Level=Reading+Factor  
Margin=Level-Limit  
Factor=Antenna Factor + cable loss - Amplifier Factor



Power	: AC 120V / 60Hz	Pol/Phase	: HORIZONTAL
Test Mode	: Mode 3, Band 1		:

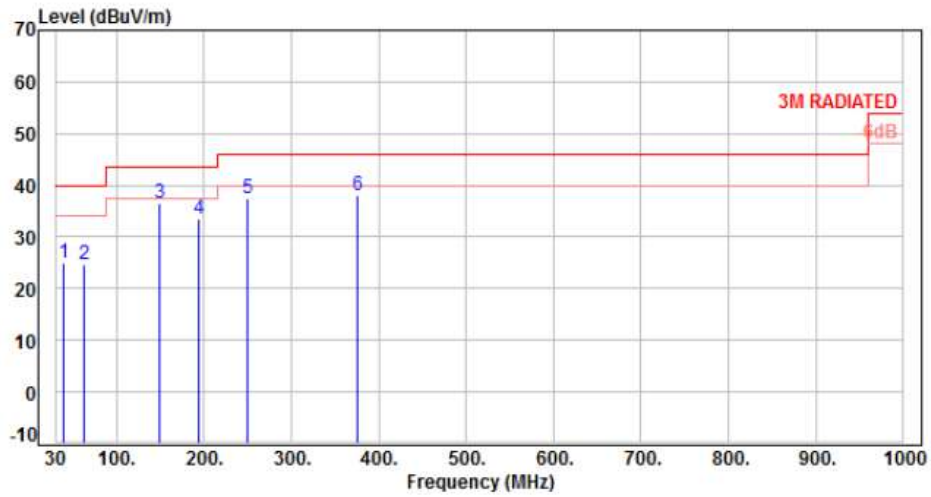

No.	Frequency (MHz)	Factor (dB)	Reading (dBuV)	Level (dBuV/m)	Limit (dBuV/m)	Margin (dB)	Detector	Height (cm)	Azimuth (deg)	P/F
1	38.73	-9.81	34.75	24.94	40.00	-15.06	Peak	100	0	P
2	62.98	-10.64	35.38	24.74	40.00	-15.26	Peak	100	0	P
3	148.34	-9.59	46.06	36.47	43.50	-7.03	Peak	100	0	P
4	194.90	-12.24	45.62	33.38	43.50	-10.12	Peak	100	0	P
5	250.19	-10.37	47.95	37.58	46.00	-8.42	Peak	100	0	P
6	375.32	-6.51	44.69	38.18	46.00	-7.82	Peak	100	0	P

Note: Level=Reading+Factor  
Margin=Level-Limit  
Factor=Antenna Factor + cable loss - Amplifier Factor



Power	: AC 120V / 60Hz	Pol/Phase	: HORIZONTAL
Test Mode	: Mode 3, Band 2		:

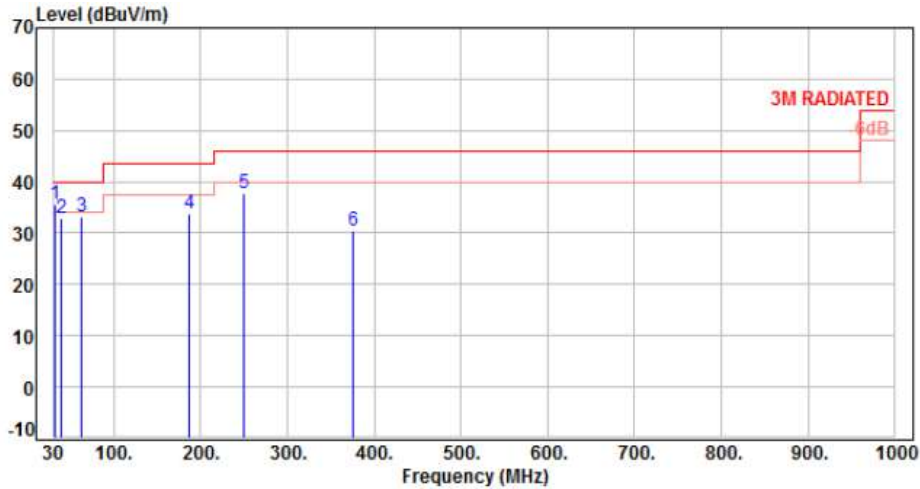

No.	Frequency (MHz)	Factor (dB)	Reading (dBuV)	Level (dBuV/m)	Limit (dBuV/m)	Margin (dB)	Detector	Height (cm)	Azimuth (deg)	P/F
1	31.94	-10.57	46.18	35.61	40.00	-4.39	QP	100	62	P
2	39.70	-9.71	42.45	32.74	40.00	-7.26	Peak	100	174	P
3	62.01	-10.44	43.54	33.10	40.00	-6.90	Peak	400	0	P
4	187.14	-11.69	45.41	33.72	43.50	-9.78	Peak	400	0	P
5	250.19	-10.37	48.08	37.71	46.00	-8.29	Peak	400	0	P
6	375.32	-6.51	37.08	30.57	46.00	-15.43	Peak	400	0	P

Note: Level=Reading+Factor  
 Margin=Level-Limit  
 Factor=Antenna Factor + cable loss - Amplifier Factor



Power	: AC 120V / 60Hz	Pol/Phase	: HORIZONTAL
Test Mode	: Mode 3, Band 2		:

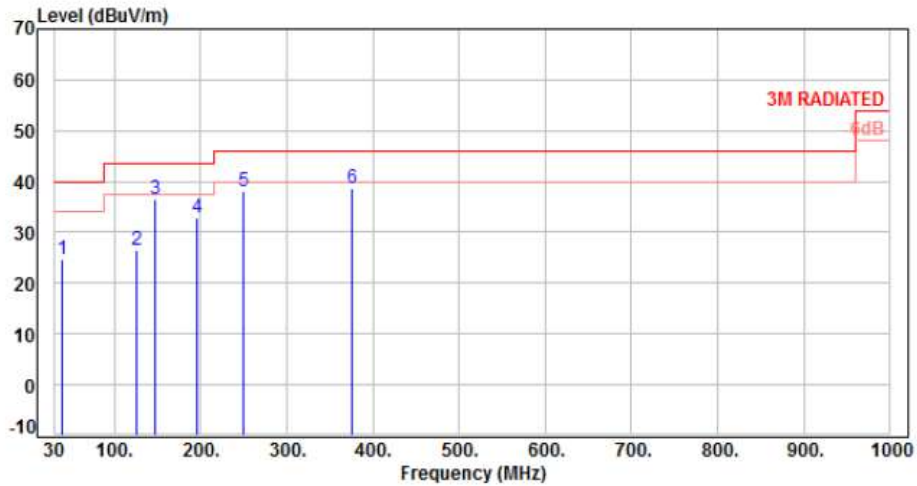

No.	Frequency (MHz)	Factor (dB)	Reading (dBuV)	Level (dBuV/m)	Limit (dBuV/m)	Margin (dB)	Detector	Height (cm)	Azimuth (deg)	P/F
1	38.73	-9.81	34.48	24.67	40.00	-15.33	Peak	100	0	P
2	125.06	-11.34	37.98	26.64	43.50	-16.86	Peak	100	0	P
3	147.37	-9.66	46.21	36.55	43.50	-6.95	Peak	100	0	P
4	195.87	-12.24	45.08	32.84	43.50	-10.66	Peak	100	0	P
5	250.19	-10.37	48.41	38.04	46.00	-7.96	Peak	100	0	P
6	375.32	-6.51	45.06	38.55	46.00	-7.45	Peak	100	0	P

Note: Level=Reading+Factor  
 Margin=Level-Limit  
 Factor=Antenna Factor + cable loss - Amplifier Factor



Power	: AC 120V / 60Hz	Pol/Phase	: VERTICAL
Test Mode	: Mode 3, Band3		:

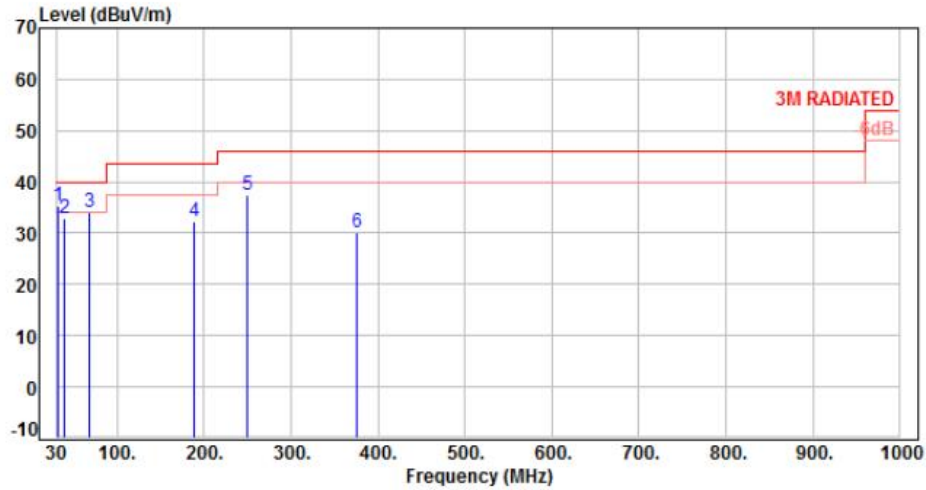

No.	Frequency (MHz)	Factor (dB)	Reading (dBuV)	Level (dBuV/m)	Limit (dBuV/m)	Margin (dB)	Detector	Height (cm)	Azimuth (deg)	P/F
1	31.94	-10.57	45.95	35.38	40.00	-4.62	QP	100	51	P
2	39.70	-9.71	42.68	32.97	40.00	-7.03	QP	100	172	P
3	68.80	-11.42	45.55	34.13	40.00	-5.87	Peak	400	0	P
4	189.08	-11.88	44.26	32.38	43.50	-11.12	Peak	400	0	P
5	250.19	-10.37	47.68	37.31	46.00	-8.69	Peak	400	0	P
6	375.32	-6.51	36.70	30.19	46.00	-15.81	Peak	400	0	P

Note: Level=Reading+Factor  
Margin=Level-Limit  
Factor=Antenna Factor + cable loss - Amplifier Factor



Power	: AC 120V / 60Hz	Pol/Phase	: HORIZONTAL
Test Mode	: Mode 3, Band3		:

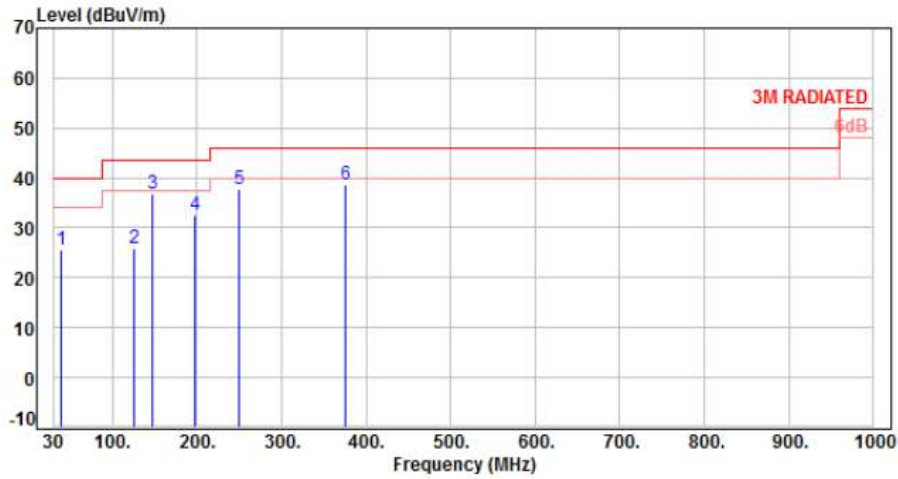

No.	Frequency (MHz)	Factor (dB)	Reading (dBuV)	Level (dBuV/m)	Limit (dBuV/m)	Margin (dB)	Detector	Height (cm)	Azimuth (deg)	P/F
1	38.73	-9.81	35.39	25.58	40.00	-14.42	Peak	100	0	P
2	125.06	-11.34	37.34	26.00	43.50	-17.50	Peak	100	0	P
3	147.37	-9.66	46.37	36.71	43.50	-6.79	Peak	100	0	P
4	196.84	-12.16	44.90	32.74	43.50	-10.76	Peak	100	0	P
5	250.19	-10.37	48.21	37.84	46.00	-8.16	Peak	100	0	P
6	375.32	-6.51	45.21	38.70	46.00	-7.30	Peak	100	0	P

Note: Level=Reading+Factor  
Margin=Level-Limit  
Factor=Antenna Factor + cable loss - Amplifier Factor



Power	: AC 120V / 60Hz	Pol/Phase	: VERTICAL
Test Mode	: Mode 3, Band4		:

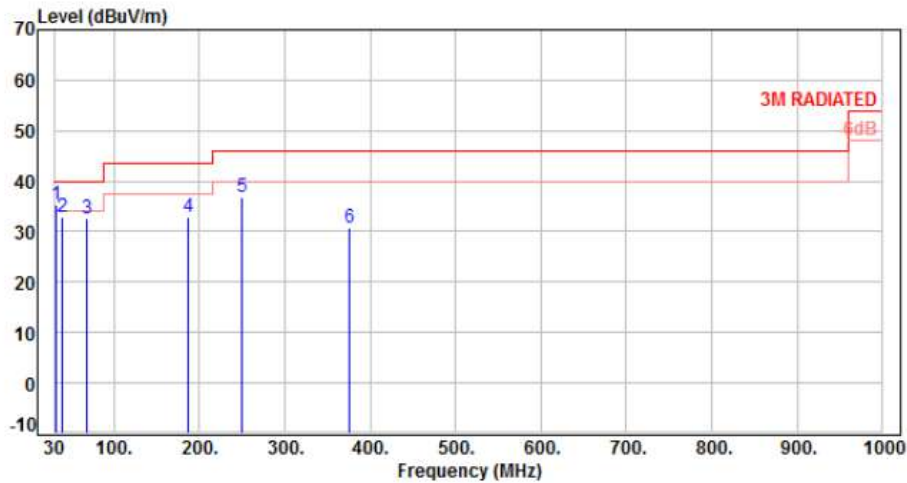

No.	Frequency (MHz)	Factor (dB)	Reading (dBuV)	Level (dBuV/m)	Limit (dBuV/m)	Margin (dB)	Detector	Height (cm)	Azimuth (deg)	P/F
1	31.94	-10.57	45.92	35.35	40.00	-4.65	QP	100	63	P
2	39.70	-9.71	42.48	32.77	40.00	-7.23	QP	100	174	P
3	68.80	-11.42	44.04	32.62	40.00	-7.38	Peak	400	0	P
4	187.14	-11.69	44.46	32.77	43.50	-10.73	Peak	400	0	P
5	250.19	-10.37	47.12	36.75	46.00	-9.25	Peak	400	0	P
6	375.32	-6.51	37.13	30.62	46.00	-15.38	Peak	400	0	P

Note: Level=Reading+Factor  
 Margin=Level-Limit  
 Factor=Antenna Factor + cable loss - Amplifier Factor





Power	: AC 120V / 60Hz	Pol/Phase	: HORIZONTAL
Test Mode	: Mode 3, Band4		:

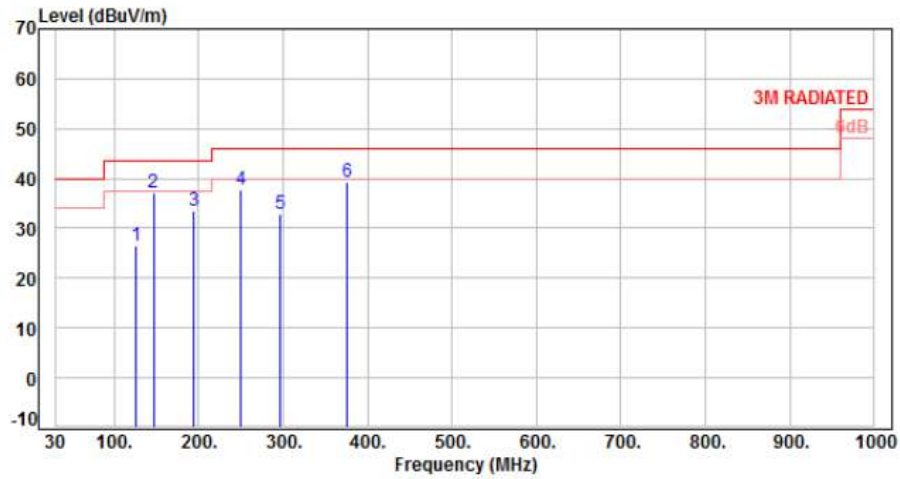

No.	Frequency (MHz)	Factor (dB)	Reading (dBuV)	Level (dBuV/m)	Limit (dBuV/m)	Margin (dB)	Detector	Height (cm)	Azimuth (deg)	P/F
1	125.06	-11.34	37.80	26.46	43.50	-17.04	Peak	100	0	P
2	146.40	-9.70	46.84	37.14	43.50	-6.36	Peak	100	0	P
3	194.90	-12.24	45.67	33.43	43.50	-10.07	Peak	100	0	P
4	250.19	-10.37	48.01	37.64	46.00	-8.36	Peak	100	0	P
5	296.75	-8.76	41.76	33.00	46.00	-13.00	Peak	100	0	P
6	375.32	-6.51	45.69	39.18	46.00	-6.82	Peak	100	0	P

Note: Level=Reading+Factor  
 Margin=Level-Limit  
 Factor=Antenna Factor + cable loss - Amplifier Factor



### 6.6. Test Result and Data (1GHz ~ 40GHz)

Power	: AC 120V / 60Hz	Pol/Phase	: VERTICAL
Test Mode	: Mode 1, Band 1, CH36		:

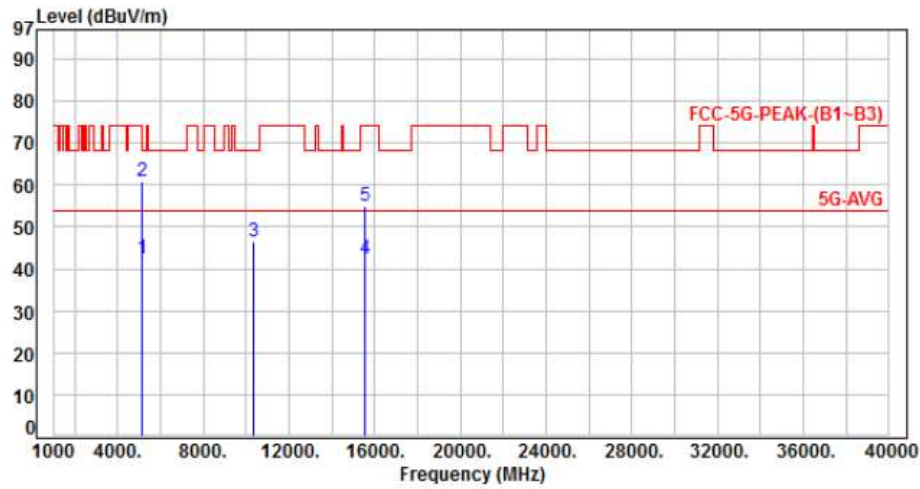

No.	Frequency (MHz)	Factor (dB)	Reading (dBuV)	Level (dBuV/m)	Limit (dBuV/m)	Margin (dB)	Detector	Height (cm)	Azimuth (deg)	P/F
1	5150.00	-5.86	48.40	42.54	54.00	-11.46	Average	347	155	P
2	5150.00	-5.86	66.90	61.04	74.00	-12.96	Peak	347	155	P
3	10360.00	2.36	44.25	46.61	68.20	-21.59	Peak	370	288	P
4	15540.00	8.79	33.70	42.49	54.00	-11.51	Average	388	71	P
5	15540.00	8.79	46.10	54.89	74.00	-19.11	Peak	388	71	P

Note: Level=Reading+Factor  
Margin=Level-Limit  
Factor=Antenna Factor + cable loss - Amplifier Factor



Power	: AC 120V / 60Hz	Pol/Phase	: HORIZONTAL
Test Mode	: Mode 1, Band 1, CH36		:

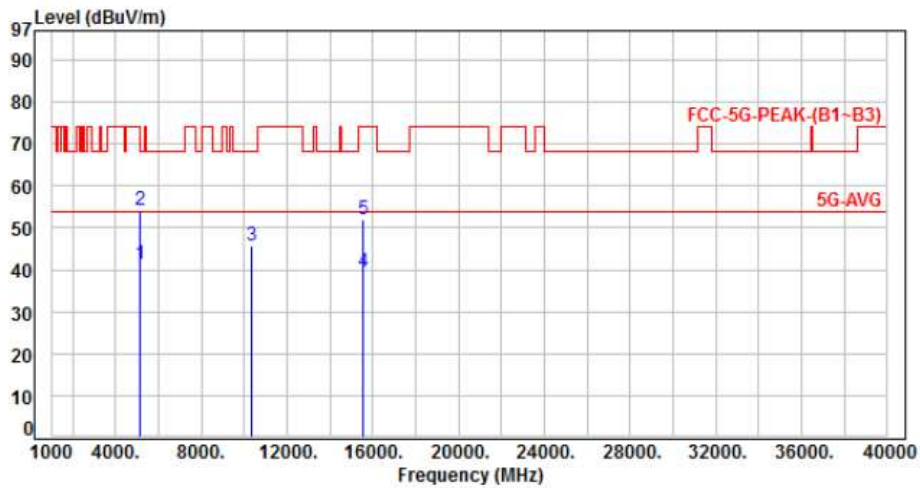

No.	Frequency (MHz)	Factor (dB)	Reading (dBuV)	Level (dBuV/m)	Limit (dBuV/m)	Margin (dB)	Detector	Height (cm)	Azimuth (deg)	P/F
1	5150.00	-5.86	47.21	41.35	54.00	-12.65	Average	392	211	P
2	5150.00	-5.86	60.20	54.34	74.00	-19.66	Peak	392	211	P
3	10360.00	2.36	43.35	45.71	68.20	-22.49	Peak	395	166	P
4	15540.00	8.79	30.50	39.29	54.00	-14.71	Average	400	136	P
5	15540.00	8.79	43.10	51.89	74.00	-22.11	Peak	400	136	P

Note: Level=Reading+Factor  
 Margin=Level-Limit  
 Factor=Antenna Factor + cable loss - Amplifier Factor



Power	: AC 120V / 60Hz	Pol/Phase	: VERTICAL
Test Mode	: Mode 1, Band 1, CH44		:

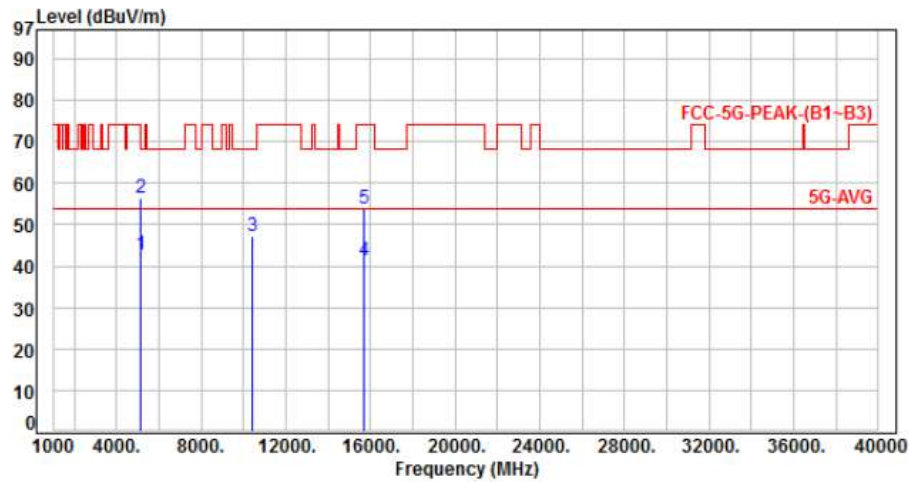

No.	Frequency (MHz)	Factor (dB)	Reading (dBuV)	Level (dBuV/m)	Limit (dBuV/m)	Margin (dB)	Detector	Height (cm)	Azimuth (deg)	P/F
1	5150.00	-5.86	48.80	42.94	54.00	-11.06	Average	355	180	P
2	5150.00	-5.86	62.30	56.44	74.00	-17.56	Peak	355	180	P
3	10440.00	2.49	44.59	47.08	68.20	-21.12	Peak	395	314	P
4	15660.00	8.49	32.79	41.28	54.00	-12.72	Average	378	114	P
5	15660.00	8.49	45.49	53.98	74.00	-20.02	Peak	378	114	P

Note: Level=Reading+Factor  
Margin=Level-Limit  
Factor=Antenna Factor + cable loss - Amplifier Factor



Power	: AC 120V / 60Hz	Pol/Phase	: HORIZONTAL
Test Mode	: Mode 1, Band 1, CH44		:

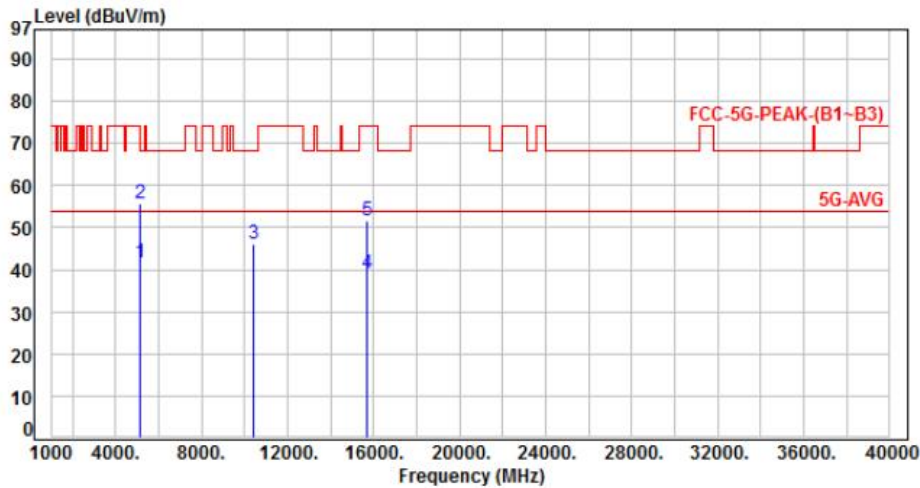

No.	Frequency (MHz)	Factor (dB)	Reading (dBuV)	Level (dBuV/m)	Limit (dBuV/m)	Margin (dB)	Detector	Height (cm)	Azimuth (deg)	P/F
1	5150.00	-5.86	47.63	41.77	54.00	-12.23	Average	385	257	P
2	5150.00	-5.86	61.47	55.61	74.00	-18.39	Peak	385	257	P
3	10440.00	2.49	43.56	46.05	68.20	-22.15	Peak	391	182	P
4	15660.00	8.49	30.59	39.08	54.00	-14.92	Average	378	125	P
5	15660.00	8.49	43.20	51.69	74.00	-22.31	Peak	378	125	P

Note: Level=Reading+Factor  
 Margin=Level-Limit  
 Factor=Antenna Factor + cable loss - Amplifier Factor



Power	: AC 120V / 60Hz	Pol/Phase	: VERTICAL
Test Mode	: Mode 1, Band 1, CH48		:

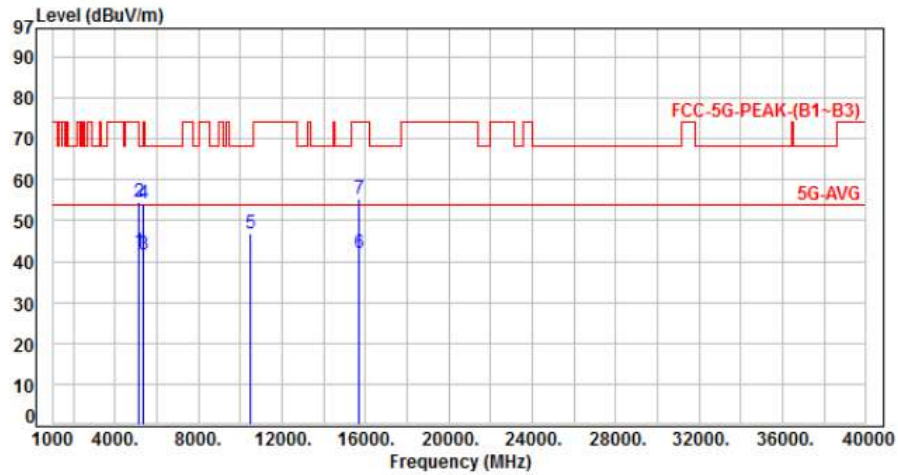

No.	Frequency (MHz)	Factor (dB)	Reading (dBuV)	Level (dBuV/m)	Limit (dBuV/m)	Margin (dB)	Detector	Height (cm)	Azimuth (deg)	P/F
1	5150.00	-5.86	48.30	42.44	54.00	-11.56	Average	392	149	P
2	5150.00	-5.86	60.50	54.64	74.00	-19.36	Peak	392	149	P
3	5350.00	-5.50	47.15	41.65	54.00	-12.35	Average	392	149	P
4	5350.00	-5.50	59.80	54.30	74.00	-19.70	Peak	392	149	P
5	10480.00	2.58	44.11	46.69	68.20	-21.51	Peak	372	162	P
6	15720.00	8.50	33.44	41.94	54.00	-12.06	Average	380	129	P
7	15720.00	8.50	46.69	55.19	74.00	-18.81	Peak	380	129	P

Note: Level=Reading+Factor  
 Margin=Level-Limit  
 Factor=Antenna Factor + cable loss - Amplifier Factor



Power	: AC 120V / 60Hz	Pol/Phase	: HORIZONTAL
Test Mode	: Mode 1, Band 1, CH48		:

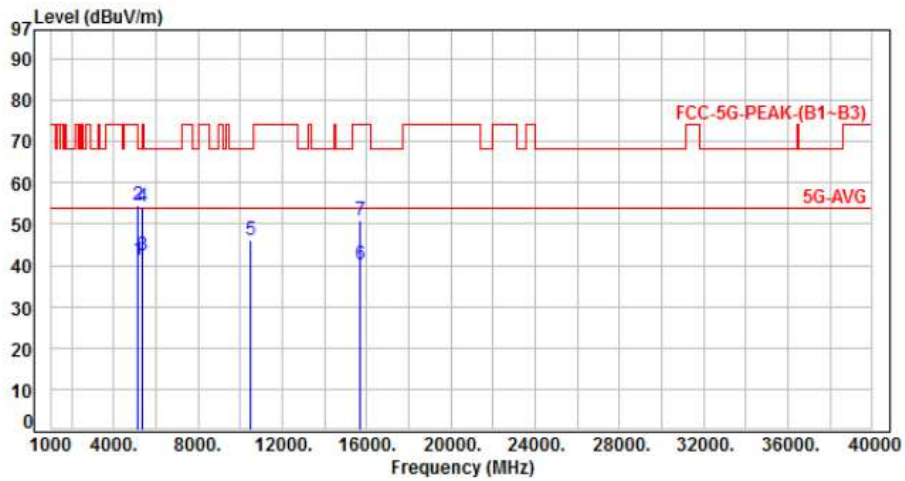

No.	Frequency (MHz)	Factor (dB)	Reading (dBUV)	Level (dBUV/m)	Limit (dBUV/m)	Margin (dB)	Detector	Height (cm)	Azimuth (deg)	P/F
1	5150.00	-5.86	47.21	41.35	54.00	-12.65	Average	383	255	P
2	5150.00	-5.86	60.30	54.44	74.00	-19.56	Peak	383	255	P
3	5350.00	-5.50	47.85	42.35	54.00	-11.65	Average	383	255	P
4	5350.00	-5.50	59.77	54.27	74.00	-19.73	Peak	383	255	P
5	10480.00	2.58	43.52	46.10	68.20	-22.10	Peak	399	171	P
6	15720.00	8.50	31.65	40.15	54.00	-13.85	Average	395	127	P
7	15720.00	8.50	42.24	50.74	74.00	-23.26	Peak	395	127	P

Note: Level=Reading+Factor  
 Margin=Level-Limit  
 Factor=Antenna Factor + cable loss - Amplifier Factor



Power	: AC 120V / 60Hz	Pol/Phase	: VERTICAL
Test Mode	: Mode 2, Band 1, CH36		:

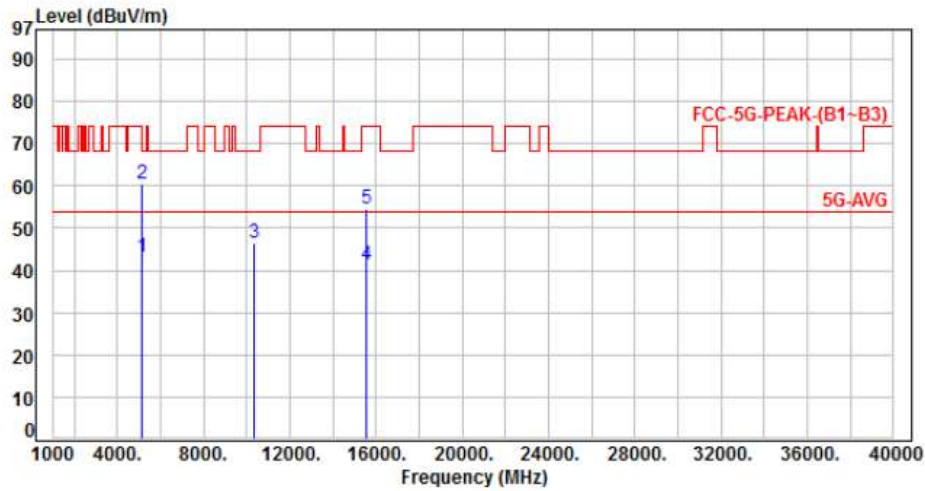

No.	Frequency (MHz)	Factor (dB)	Reading (dBuV)	Level (dBuV/m)	Limit (dBuV/m)	Margin (dB)	Detector	Height (cm)	Azimuth (deg)	P/F
1	5150.00	-5.86	49.10	43.24	54.00	-10.76	Average	371	150	P
2	5150.00	-5.86	66.20	60.34	74.00	-13.66	Peak	371	150	P
3	10360.00	2.36	44.25	46.61	68.20	-21.59	Peak	378	292	P
4	15540.00	8.79	32.67	41.46	54.00	-12.54	Average	391	48	P
5	15540.00	8.79	45.80	54.59	74.00	-19.41	Peak	391	48	P

Note: Level=Reading+Factor  
Margin=Level-Limit  
Factor=Antenna Factor + cable loss - Amplifier Factor





Power	: AC 120V / 60Hz	Pol/Phase	: HORIZONTAL
Test Mode	: Mode 2, Band 1, CH36		:

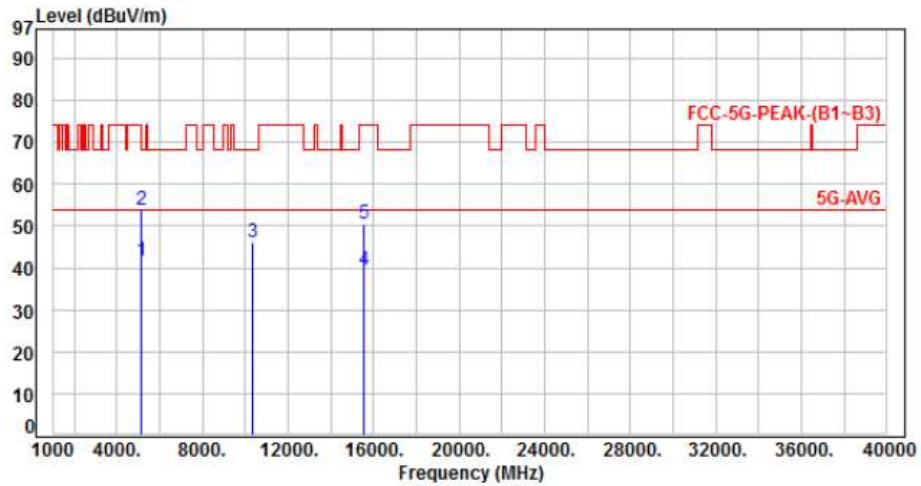

No.	Frequency (MHz)	Factor (dB)	Reading (dBuV)	Level (dBuV/m)	Limit (dBuV/m)	Margin (dB)	Detector	Height (cm)	Azimuth (deg)	P/F
1	5150.00	-5.86	47.42	41.56	54.00	-12.44	Average	400	225	P
2	5150.00	-5.86	59.76	53.90	74.00	-20.10	Peak	400	225	P
3	10360.00	2.36	43.61	45.97	68.20	-22.23	Peak	372	177	P
4	15540.00	8.79	30.74	39.53	54.00	-14.47	Average	386	155	P
5	15540.00	8.79	41.68	50.47	74.00	-23.53	Peak	386	155	P

Note: Level=Reading+Factor  
Margin=Level-Limit  
Factor=Antenna Factor + cable loss - Amplifier Factor



Power	: AC 120V / 60Hz	Pol/Phase	: VERTICAL
Test Mode	: Mode 2, Band 1, CH44		

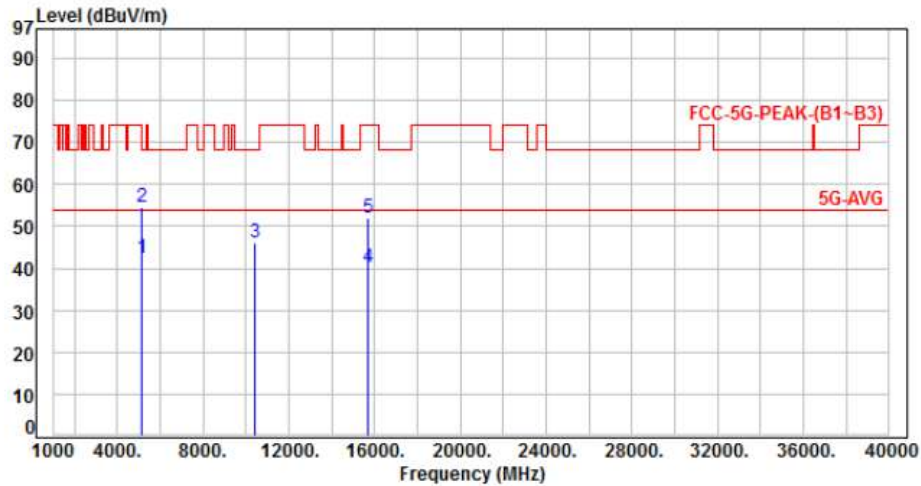

No.	Frequency (MHz)	Factor (dB)	Reading (dBuV)	Level (dBuV/m)	Limit (dBuV/m)	Margin (dB)	Detector	Height (cm)	Azimuth (deg)	P/F
1	5150.00	-5.86	48.45	42.59	54.00	-11.41	Average	370	180	P
2	5150.00	-5.86	60.60	54.74	74.00	-19.26	Peak	370	180	P
3	10440.00	2.49	43.70	46.19	68.20	-22.01	Peak	364	247	P
4	15660.00	8.49	31.55	40.04	54.00	-13.96	Average	391	39	P
5	15660.00	8.49	43.49	51.98	74.00	-22.02	Peak	391	39	P

Note: Level=Reading+Factor  
 Margin=Level-Limit  
 Factor=Antenna Factor + cable loss - Amplifier Factor



Power	: AC 120V / 60Hz	Pol/Phase	: HORIZONTAL
Test Mode	: Mode 2, Band 1, CH44		:

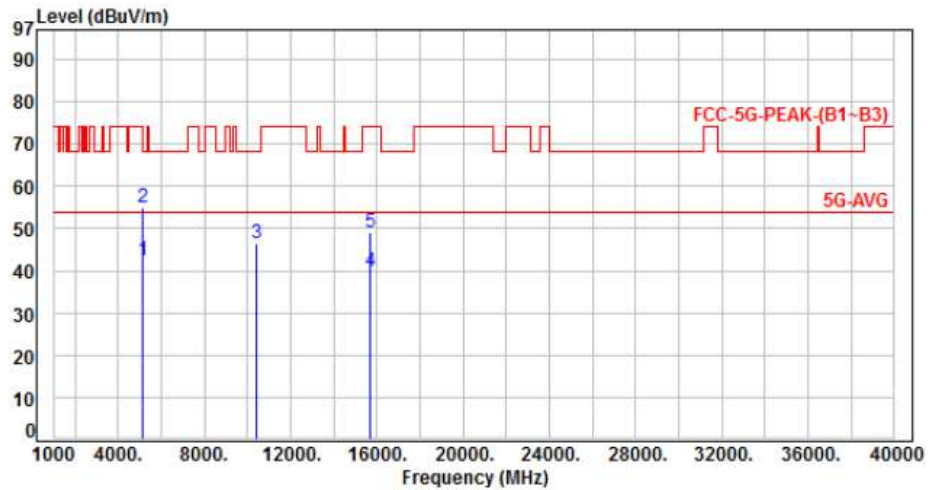

No.	Frequency (MHz)	Factor (dB)	Reading (dBuV)	Level (dBuV/m)	Limit (dBuV/m)	Margin (dB)	Detector	Height (cm)	Azimuth (deg)	P/F
1	5150.00	-5.86	48.26	42.40	54.00	-11.60	Average	387	271	P
2	5150.00	-5.86	60.88	55.02	74.00	-18.98	Peak	387	271	P
3	10440.00	2.49	44.13	46.62	68.20	-21.58	Peak	380	159	P
4	15660.00	8.49	31.29	39.78	54.00	-14.22	Average	369	178	P
5	15660.00	8.49	40.51	49.00	74.00	-25.00	Peak	369	178	P

Note: Level=Reading+Factor  
 Margin=Level-Limit  
 Factor=Antenna Factor + cable loss - Amplifier Factor



Power	: AC 120V / 60Hz	Pol/Phase	: VERTICAL
Test Mode	: Mode 2, Band 1, CH48		:

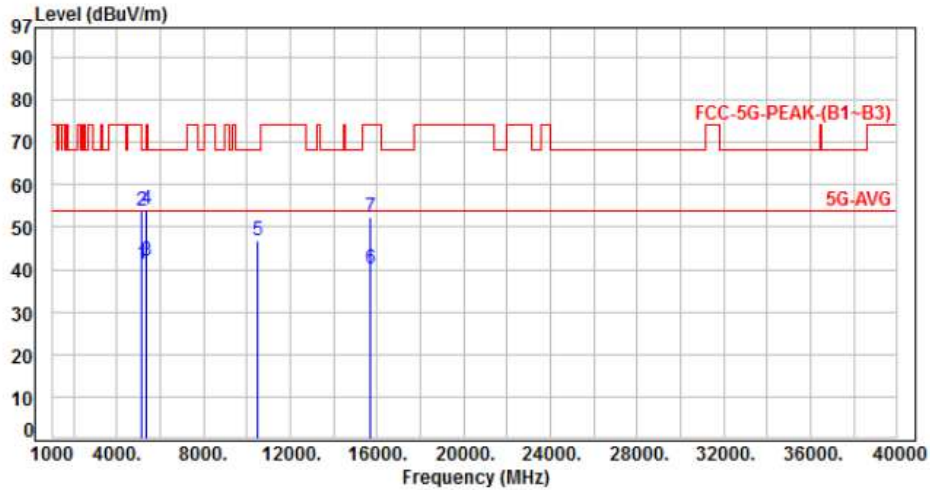

No.	Frequency (MHz)	Factor (dB)	Reading (dBuV)	Level (dBuV/m)	Limit (dBuV/m)	Margin (dB)	Detector	Height (cm)	Azimuth (deg)	P/F
1	5150.00	-5.86	47.21	41.35	54.00	-12.65	Average	287	166	P
2	5150.00	-5.86	59.88	54.02	74.00	-19.98	Peak	287	166	P
3	5350.00	-5.50	47.56	42.06	54.00	-11.94	Average	287	166	P
4	5350.00	-5.50	59.69	54.19	74.00	-19.81	Peak	287	166	P
5	10480.00	2.58	44.26	46.84	68.20	-21.36	Peak	378	245	P
6	15720.00	8.50	31.67	40.17	54.00	-13.83	Average	388	79	P
7	15720.00	8.50	44.04	52.54	74.00	-21.46	Peak	388	79	P

Note: Level=Reading+Factor  
 Margin=Level-Limit  
 Factor=Antenna Factor + cable loss - Amplifier Factor



Power	: AC 120V / 60Hz	Pol/Phase	: HORIZONTAL
Test Mode	: Mode 2, Band 1, CH48		:

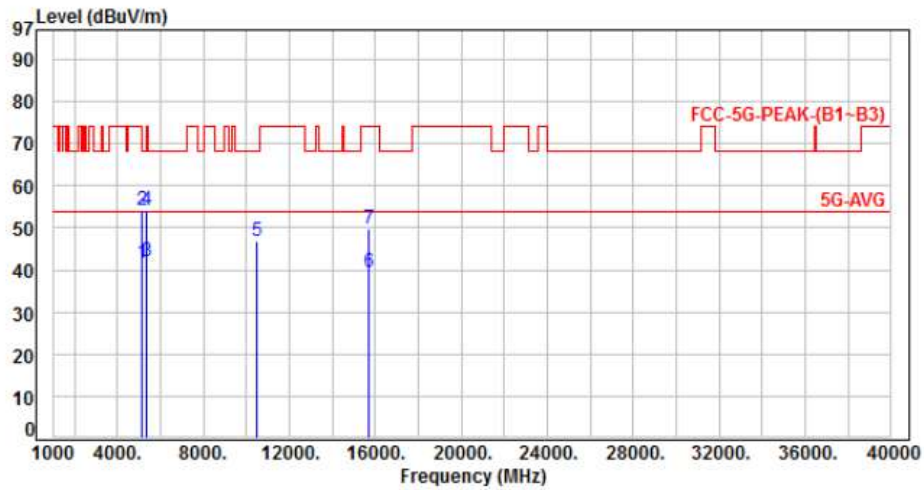

No.	Frequency (MHz)	Factor (dB)	Reading (dBuV)	Level (dBuV/m)	Limit (dBuV/m)	Margin (dB)	Detector	Height (cm)	Azimuth (deg)	P/F
1	5150.00	-5.86	47.36	41.50	54.00	-12.50	Average	385	261	P
2	5150.00	-5.86	60.25	54.39	74.00	-19.61	Peak	385	261	P
3	5350.00	-5.50	47.41	41.91	54.00	-12.09	Average	385	261	P
4	5350.00	-5.50	59.76	54.26	74.00	-19.74	Peak	385	261	P
5	10480.00	2.58	44.13	46.71	68.20	-21.49	Peak	367	158	P
6	15720.00	8.50	31.04	39.54	54.00	-14.46	Average	372	174	P
7	15720.00	8.50	41.44	49.94	74.00	-24.06	Peak	372	174	P

Note: Level=Reading+Factor  
 Margin=Level-Limit  
 Factor=Antenna Factor + cable loss - Amplifier Factor



Power	: AC 120V / 60Hz	Pol/Phase	: VERTICAL
Test Mode	: Mode 3, Band 1, CH38		:

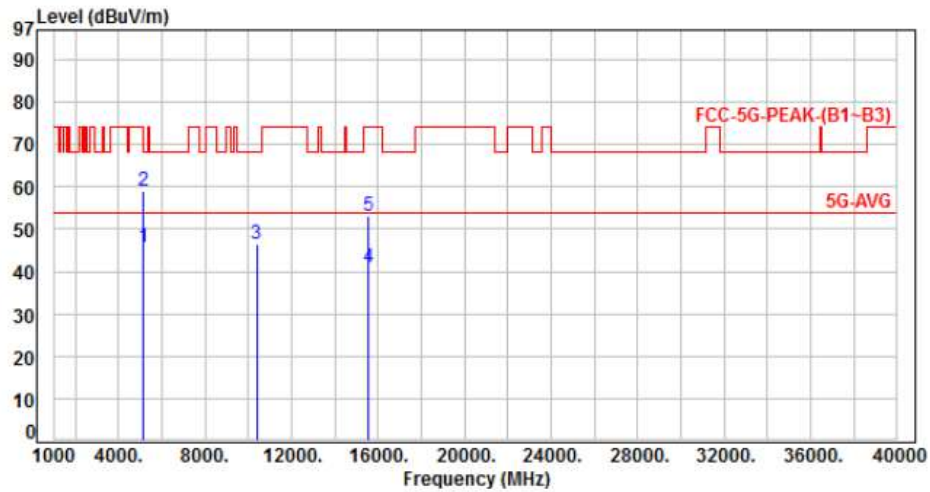

No.	Frequency (MHz)	Factor (dB)	Reading (dBuV)	Level (dBuV/m)	Limit (dBuV/m)	Margin (dB)	Detector	Height (cm)	Azimuth (deg)	P/F
1	5150.00	-5.86	51.76	45.90	54.00	-8.10	Average	100	179	P
2	5150.00	-5.86	64.80	58.94	74.00	-15.06	Peak	100	179	P
3	10380.00	2.37	44.11	46.48	68.20	-21.72	Peak	382	261	P
4	15570.00	8.66	32.34	41.00	54.00	-13.00	Average	100	87	P
5	15570.00	8.66	44.50	53.16	74.00	-20.84	Peak	100	87	P

Note: Level=Reading+Factor  
 Margin=Level-Limit  
 Factor=Antenna Factor + cable loss - Amplifier Factor



Power	: AC 120V / 60Hz	Pol/Phase	: HORIZONTAL
Test Mode	: Mode 3, Band 1, CH38		:

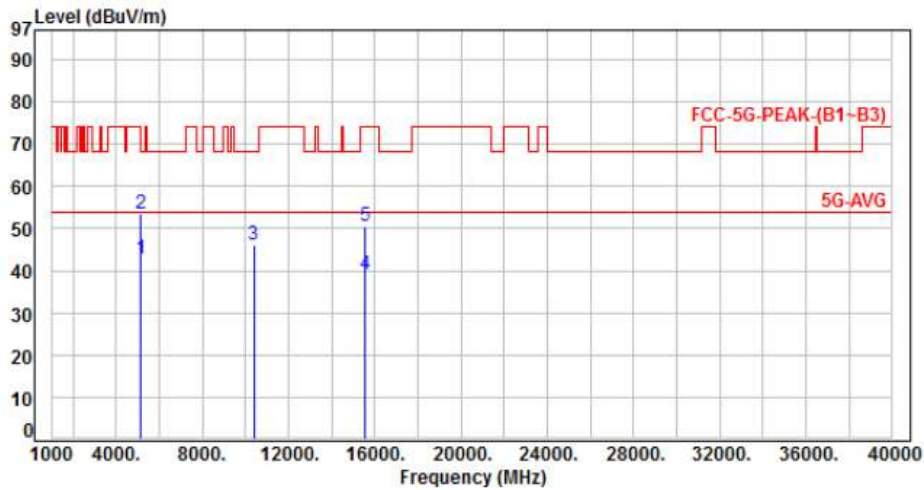

No.	Frequency (MHz)	Factor (dB)	Reading (dBuV)	Level (dBuV/m)	Limit (dBuV/m)	Margin (dB)	Detector	Height (cm)	Azimuth (deg)	P/F
1	5150.00	-5.86	48.70	42.84	54.00	-11.16	Average	400	271	P
2	5150.00	-5.86	59.50	53.64	74.00	-20.36	Peak	400	271	P
3	10380.00	2.37	43.87	46.24	68.20	-21.96	Peak	353	194	P
4	15570.00	8.66	30.55	39.21	54.00	-14.79	Average	100	342	P
5	15570.00	8.66	42.01	50.67	74.00	-23.33	Peak	100	342	P

Note: Level=Reading+Factor  
Margin=Level-Limit  
Factor=Antenna Factor + cable loss - Amplifier Factor



Power	: AC 120V / 60Hz	Pol/Phase	: VERTICAL
Test Mode	: Mode 3, Band 1, CH46		:

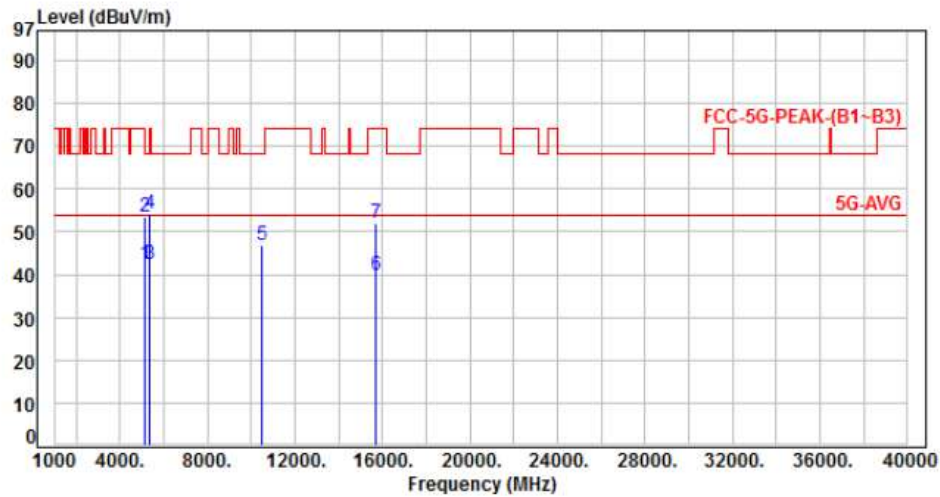

No.	Frequency (MHz)	Factor (dB)	Reading (dBuV)	Level (dBuV/m)	Limit (dBuV/m)	Margin (dB)	Detector	Height (cm)	Azimuth (deg)	P/F
1	5150.00	-5.86	48.20	42.34	54.00	-11.66	Average	347	190	P
2	5150.00	-5.86	59.50	53.64	74.00	-20.36	Peak	347	190	P
3	5350.00	-5.50	47.81	42.31	54.00	-11.69	Average	347	190	P
4	5350.00	-5.50	59.87	54.37	74.00	-19.63	Peak	347	190	P
5	10460.00	2.53	44.17	46.70	68.20	-21.50	Peak	398	266	P
6	15690.00	8.47	31.25	39.72	54.00	-14.28	Average	100	69	P
7	15690.00	8.47	43.67	52.14	74.00	-21.86	Peak	100	69	P

Note: Level=Reading+Factor  
 Margin=Level-Limit  
 Factor=Antenna Factor + cable loss - Amplifier Factor





Power	: AC 120V / 60Hz	Pol/Phase	: HORIZONTAL
Test Mode	: Mode 3, Band 1, CH46		:

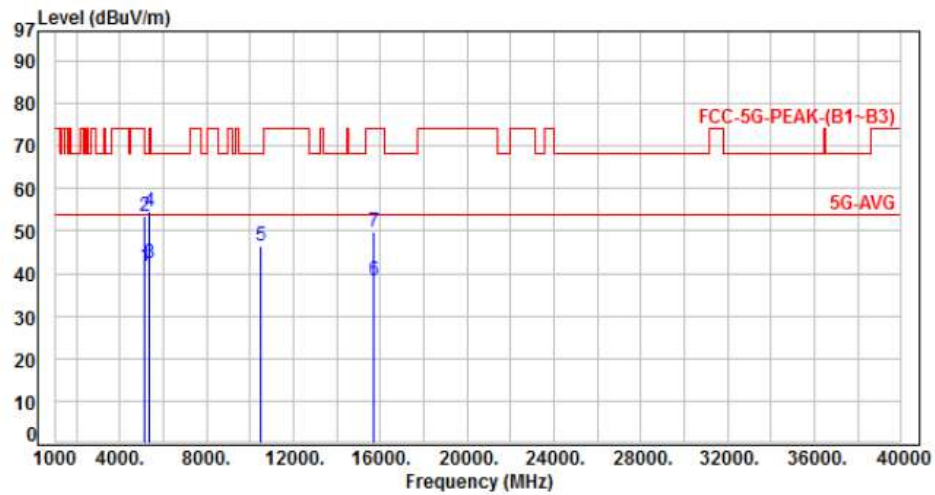

No.	Frequency (MHz)	Factor (dB)	Reading (dBuV)	Level (dBuV/m)	Limit (dBuV/m)	Margin (dB)	Detector	Height (cm)	Azimuth (deg)	P/F
1	5150.00	-5.86	47.53	41.67	54.00	-12.33	Average	355	294	P
2	5150.00	-5.86	59.41	53.55	74.00	-20.45	Peak	355	294	P
3	5350.00	-5.50	47.88	42.38	54.00	-11.62	Average	355	294	P
4	5350.00	-5.50	60.21	54.71	74.00	-19.29	Peak	355	294	P
5	10460.00	2.53	43.88	46.41	68.20	-21.79	Peak	358	211	P
6	15690.00	8.47	29.78	38.25	54.00	-15.75	Average	100	357	P
7	15690.00	8.47	41.36	49.83	74.00	-24.17	Peak	100	357	P

Note: Level=Reading+Factor  
 Margin=Level-Limit  
 Factor=Antenna Factor + cable loss - Amplifier Factor



Power	: AC 120V / 60Hz	Pol/Phase	: VERTICAL
Test Mode	: Mode 4, Band 1, CH42		:

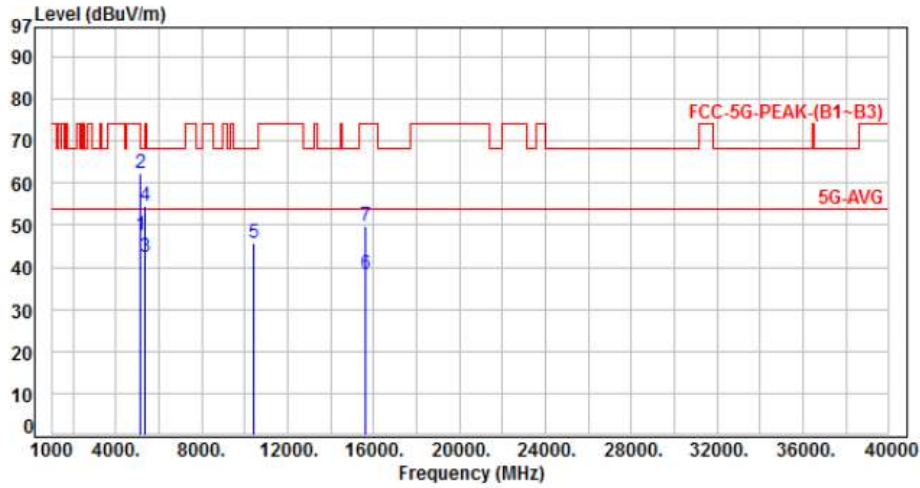

No.	Frequency (MHz)	Factor (dB)	Reading (dBuV)	Level (dBuV/m)	Limit (dBuV/m)	Margin (dB)	Detector	Height (cm)	Azimuth (deg)	P/F
1	5150.00	-5.86	53.30	47.44	54.00	-6.56	Average	117	152	P
2	5150.00	-5.86	68.35	62.49	74.00	-11.51	Peak	117	152	P
3	5350.00	-5.50	47.87	42.37	54.00	-11.63	Average	117	152	P
4	5350.00	-5.50	60.10	54.60	74.00	-19.40	Peak	117	152	P
5	10420.00	2.43	43.47	45.90	68.20	-22.30	Peak	375	186	P
6	15630.00	8.50	29.69	38.19	54.00	-15.81	Average	100	88	P
7	15630.00	8.50	41.32	49.82	74.00	-24.18	Peak	100	88	P

Note: Level=Reading+Factor  
 Margin=Level-Limit  
 Factor=Antenna Factor + cable loss - Amplifier Factor



Power	: AC 120V / 60Hz	Pol/Phase	: HORIZONTAL
Test Mode	: Mode 4, Band 1, CH42		:

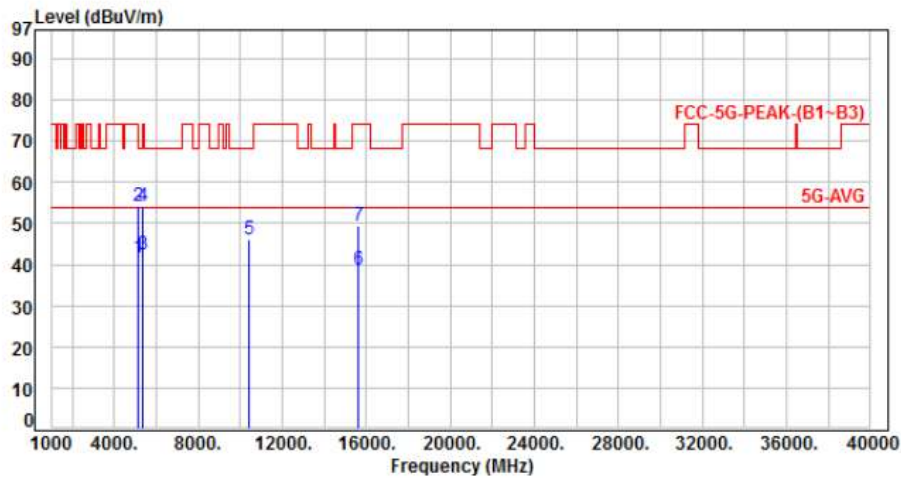

No.	Frequency (MHz)	Factor (dB)	Reading (dBuV)	Level (dBuV/m)	Limit (dBuV/m)	Margin (dB)	Detector	Height (cm)	Azimuth (deg)	P/F
1	5150.00	-5.86	47.55	41.69	54.00	-12.31	Average	394	277	P
2	5150.00	-5.86	60.15	54.29	74.00	-19.71	Peak	394	277	P
3	5350.00	-5.50	47.87	42.37	54.00	-11.63	Average	394	277	P
4	5350.00	-5.50	59.76	54.26	74.00	-19.74	Peak	394	277	P
5	10420.00	2.43	43.67	46.10	68.20	-22.10	Peak	367	254	P
6	15630.00	8.50	30.21	38.71	54.00	-15.29	Average	100	347	P
7	15630.00	8.50	40.85	49.35	74.00	-24.65	Peak	100	347	P

Note: Level=Reading+Factor  
 Margin=Level-Limit  
 Factor=Antenna Factor + cable loss - Amplifier Factor



Power	: AC 120V / 60Hz	Pol/Phase	: VERTICAL
Test Mode	: Mode 1, Band 2, CH52		

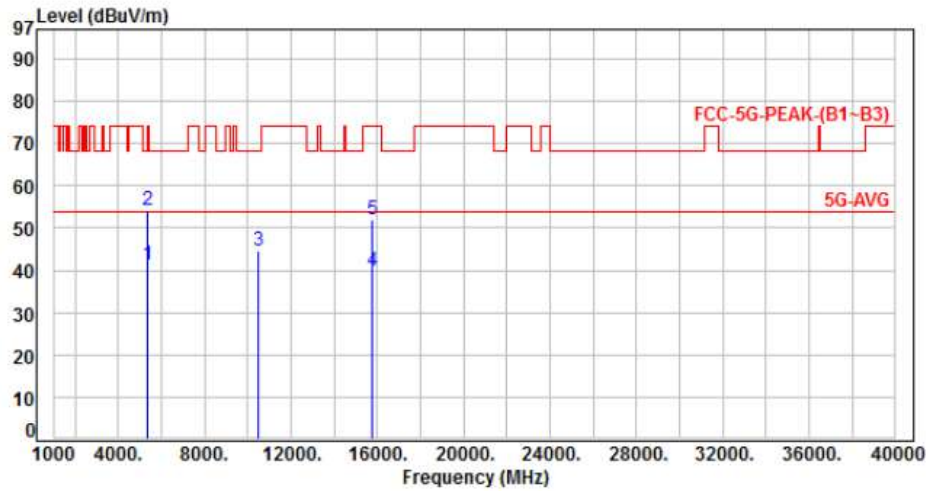

No.	Frequency (MHz)	Factor (dB)	Reading (dBuV)	Level (dBuV/m)	Limit (dBuV/m)	Margin (dB)	Detector	Height (cm)	Azimuth (deg)	P/F
1	5350.00	-5.50	46.88	41.38	54.00	-12.62	Average	100	201	P
2	5350.00	-5.50	59.63	54.13	74.00	-19.87	Peak	100	201	P
3	10520.00	2.66	42.11	44.77	68.20	-23.43	Peak	378	166	P
4	15780.00	8.57	31.22	39.79	54.00	-14.21	Average	376	76	P
5	15780.00	8.57	43.34	51.91	74.00	-22.09	Peak	376	76	P

Note: Level=Reading+Factor  
Margin=Level-Limit  
Factor=Antenna Factor + cable loss - Amplifier Factor



Power	: AC 120V / 60Hz	Pol/Phase	: HORIZONTAL
Test Mode	: Mode 1, Band 2, CH52		:

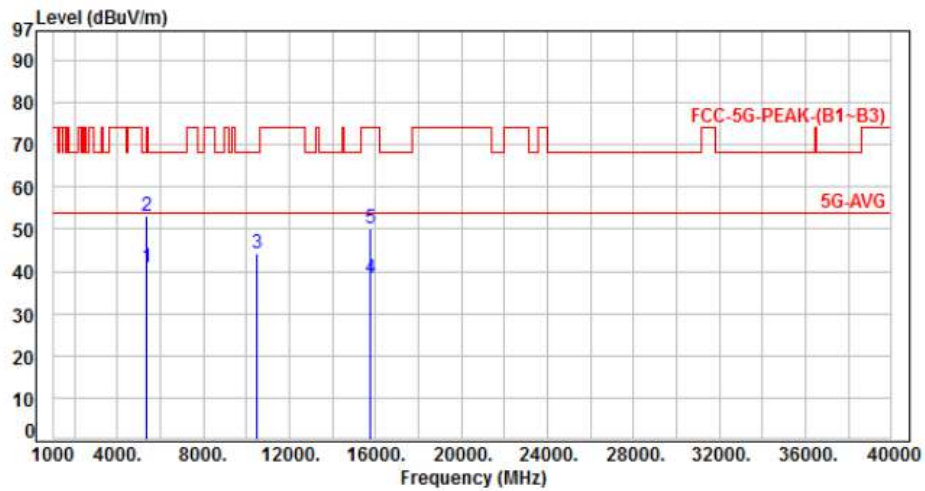

No.	Frequency (MHz)	Factor (dB)	Reading (dBuV)	Level (dBuV/m)	Limit (dBuV/m)	Margin (dB)	Detector	Height (cm)	Azimuth (deg)	P/F
1	5350.00	-5.50	46.49	40.99	54.00	-13.01	Average	355	267	P
2	5350.00	-5.50	58.43	52.93	74.00	-21.07	Peak	355	267	P
3	10520.00	2.66	41.63	44.29	68.20	-23.91	Peak	348	299	P
4	15780.00	8.57	29.75	38.32	54.00	-15.68	Average	383	144	P
5	15780.00	8.57	41.47	50.04	74.00	-23.96	Peak	383	144	P

Note: Level=Reading+Factor  
 Margin=Level-Limit  
 Factor=Antenna Factor + cable loss - Amplifier Factor



Power	: AC 120V / 60Hz	Pol/Phase	: VERTICAL
Test Mode	: Mode 1, Band 2, CH60		:

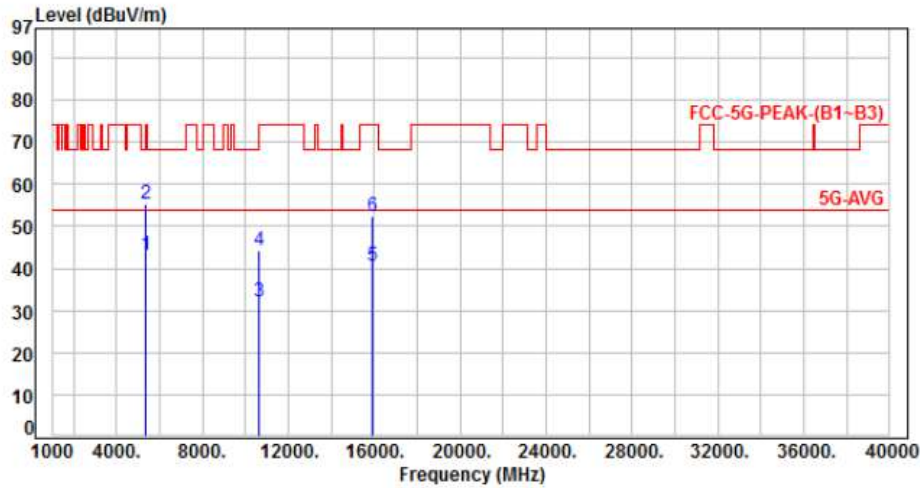

No.	Frequency (MHz)	Factor (dB)	Reading (dBuV)	Level (dBuV/m)	Limit (dBuV/m)	Margin (dB)	Detector	Height (cm)	Azimuth (deg)	P/F
1	5350.00	-5.50	48.80	43.30	54.00	-10.70	Average	113	200	P
2	5350.00	-5.50	60.67	55.17	74.00	-18.83	Peak	113	200	P
3	10600.00	2.80	29.35	32.15	54.00	-21.85	Average	359	107	P
4	10600.00	2.80	41.52	44.32	74.00	-29.68	Peak	359	107	P
5	15900.00	8.85	31.68	40.53	54.00	-13.47	Average	385	83	P
6	15900.00	8.85	43.47	52.32	74.00	-21.68	Peak	385	83	P

Note: Level=Reading+Factor  
 Margin=Level-Limit  
 Factor=Antenna Factor + cable loss - Amplifier Factor



Power	: AC 120V / 60Hz	Pol/Phase	: HORIZONTAL
Test Mode	: Mode 1, Band 2, CH60		:

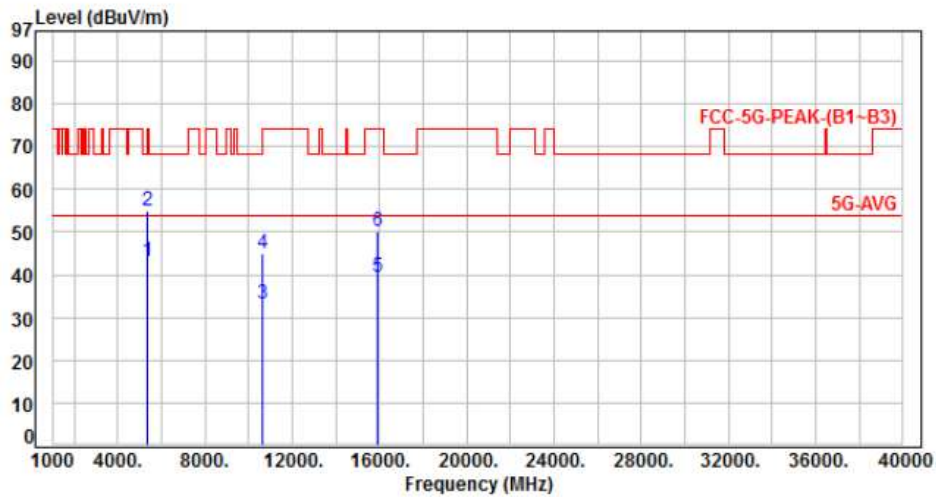

No.	Frequency (MHz)	Factor (dB)	Reading (dBuV)	Level (dBuV/m)	Limit (dBuV/m)	Margin (dB)	Detector	Height (cm)	Azimuth (deg)	P/F
1	5350.00	-5.50	48.63	43.13	54.00	-10.87	Average	378	285	P
2	5350.00	-5.50	60.32	54.82	74.00	-19.18	Peak	378	285	P
3	10600.00	2.80	30.54	33.34	54.00	-20.66	Average	385	177	P
4	10600.00	2.80	42.33	45.13	74.00	-28.87	Peak	385	177	P
5	15900.00	8.85	30.48	39.33	54.00	-14.67	Average	358	155	P
6	15900.00	8.85	41.24	50.09	74.00	-23.91	Peak	358	155	P

Note: Level=Reading+Factor  
 Margin=Level-Limit  
 Factor=Antenna Factor + cable loss - Amplifier Factor



Power	: AC 120V / 60Hz	Pol/Phase	: VERTICAL
Test Mode	: Mode 1, Band 2, CH64		:

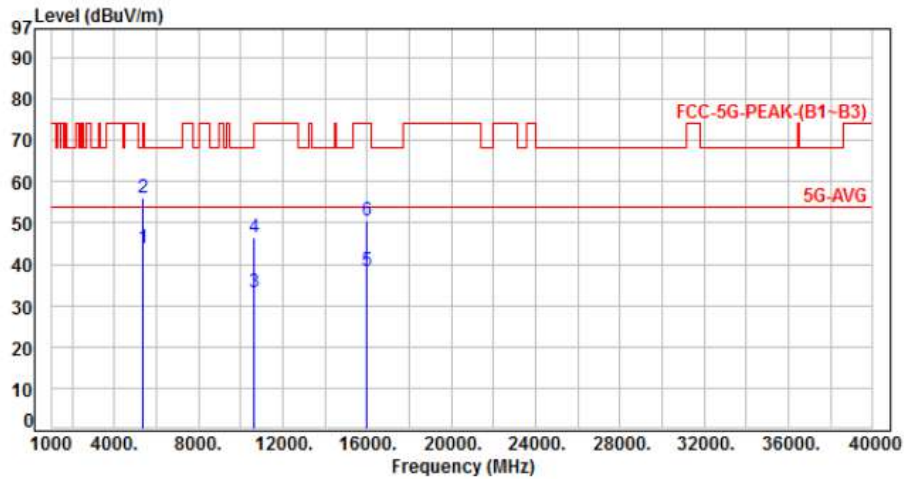

No.	Frequency (MHz)	Factor (dB)	Reading (dBuV)	Level (dBuV/m)	Limit (dBuV/m)	Margin (dB)	Detector	Height (cm)	Azimuth (deg)	P/F
1	5350.00	-5.50	49.52	44.02	54.00	-9.98	Average	100	153	P
2	5350.00	-5.50	61.70	56.20	74.00	-17.80	Peak	100	153	P
3	10640.00	2.87	30.21	33.08	54.00	-20.92	Average	381	144	P
4	10640.00	2.87	43.74	46.61	74.00	-27.39	Peak	381	144	P
5	15960.00	8.82	29.68	38.50	54.00	-15.50	Average	364	300	P
6	15960.00	8.82	41.55	50.37	74.00	-23.63	Peak	364	300	P

Note: Level=Reading+Factor  
 Margin=Level-Limit  
 Factor=Antenna Factor + cable loss - Amplifier Factor





Power	: AC 120V / 60Hz	Pol/Phase	: HORIZONTAL
Test Mode	: Mode 1, Band 2, CH64		:

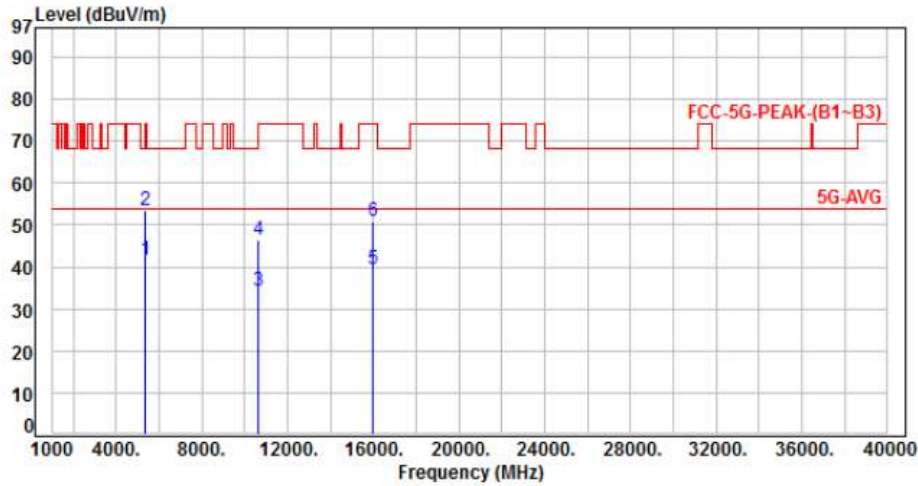

No.	Frequency (MHz)	Factor (dB)	Reading (dBuV)	Level (dBuV/m)	Limit (dBuV/m)	Margin (dB)	Detector	Height (cm)	Azimuth (deg)	P/F
1	5350.00	-5.50	47.25	41.75	54.00	-12.25	Average	300	263	P
2	5350.00	-5.50	59.06	53.56	74.00	-20.44	Peak	300	263	P
3	10640.00	2.87	31.48	34.35	54.00	-19.65	Average	355	166	P
4	10640.00	2.87	43.67	46.54	74.00	-27.46	Peak	355	166	P
5	15960.00	8.82	30.50	39.32	54.00	-14.68	Average	378	141	P
6	15960.00	8.82	42.05	50.87	74.00	-23.13	Peak	378	141	P

Note: Level=Reading+Factor  
 Margin=Level-Limit  
 Factor=Antenna Factor + cable loss - Amplifier Factor



Power	: AC 120V / 60Hz	Pol/Phase	: VERTICAL
Test Mode	: Mode 2, Band 2, CH52		:

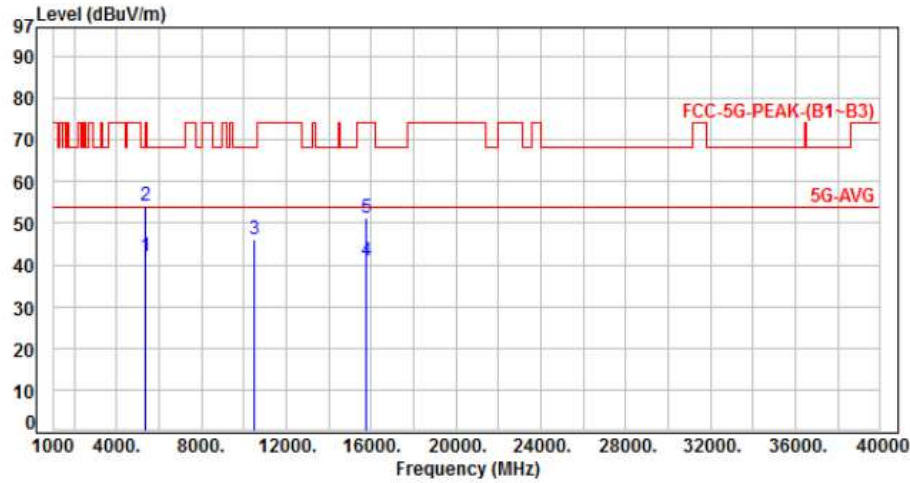

No.	Frequency (MHz)	Factor (dB)	Reading (dBuV)	Level (dBuV/m)	Limit (dBuV/m)	Margin (dB)	Detector	Height (cm)	Azimuth (deg)	P/F
1	5350.00	-5.50	47.55	42.05	54.00	-11.95	Average	100	211	P
2	5350.00	-5.50	59.89	54.39	74.00	-19.61	Peak	100	211	P
3	10520.00	2.66	43.26	45.92	68.20	-22.28	Peak	382	158	P
4	15780.00	8.57	32.46	41.03	54.00	-12.97	Average	388	92	P
5	15780.00	8.57	42.59	51.16	74.00	-22.84	Peak	388	92	P

Note: Level=Reading+Factor  
Margin=Level-Limit  
Factor=Antenna Factor + cable loss - Amplifier Factor



Power	: AC 120V / 60Hz	Pol/Phase	: HORIZONTAL
Test Mode	: Mode 2, Band 2, CH52		:

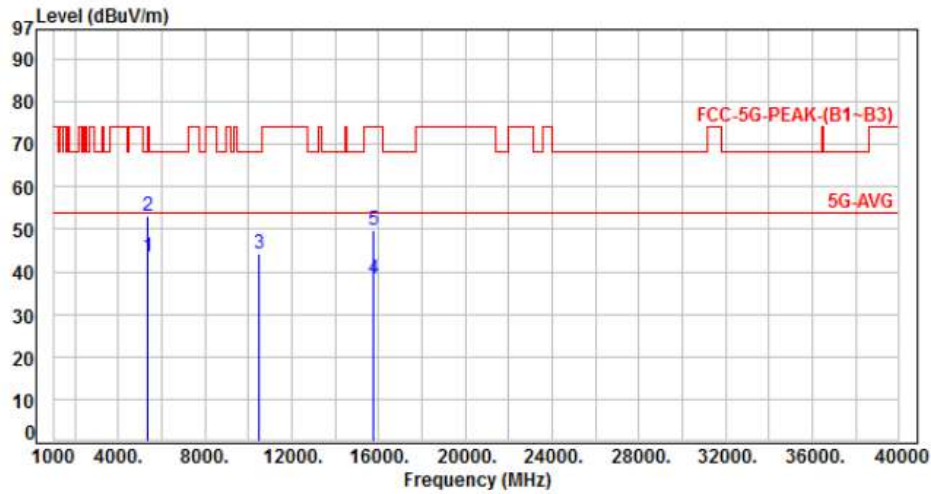

No.	Frequency (MHz)	Factor (dB)	Reading (dBuV)	Level (dBuV/m)	Limit (dBuV/m)	Margin (dB)	Detector	Height (cm)	Azimuth (deg)	P/F
1	5350.00	-5.50	49.03	43.53	54.00	-10.47	Average	366	274	P
2	5350.00	-5.50	58.79	53.29	74.00	-20.71	Peak	366	274	P
3	10520.00	2.66	41.63	44.29	68.20	-23.91	Peak	359	287	P
4	15780.00	8.57	29.89	38.46	54.00	-15.54	Average	373	152	P
5	15780.00	8.57	41.06	49.63	74.00	-24.37	Peak	373	152	P

Note: Level=Reading+Factor  
Margin=Level-Limit  
Factor=Antenna Factor + cable loss - Amplifier Factor



Power	: AC 120V / 60Hz	Pol/Phase	: VERTICAL
Test Mode	: Mode 2, Band 2, CH60		

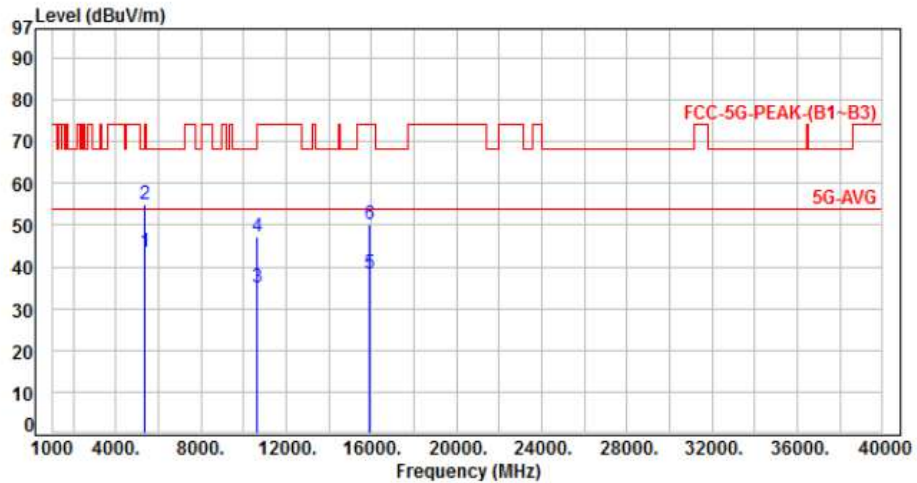

No.	Frequency (MHz)	Factor (dB)	Reading (dBuV)	Level (dBuV/m)	Limit (dBuV/m)	Margin (dB)	Detector	Height (cm)	Azimuth (deg)	P/F
1	5350.00	-5.50	48.93	43.43	54.00	-10.57	Average	100	208	P
2	5350.00	-5.50	60.36	54.86	74.00	-19.14	Peak	100	208	P
3	10600.00	2.80	32.12	34.92	54.00	-19.08	Average	378	166	P
4	10600.00	2.80	44.58	47.38	74.00	-26.62	Peak	378	166	P
5	15900.00	8.85	29.65	38.50	54.00	-15.50	Average	356	116	P
6	15900.00	8.85	41.32	50.17	74.00	-23.83	Peak	356	116	P

Note: Level=Reading+Factor  
 Margin=Level-Limit  
 Factor=Antenna Factor + cable loss - Amplifier Factor



Power	: AC 120V / 60Hz	Pol/Phase	: HORIZONTAL
Test Mode	: Mode 2, Band 2, CH60		:

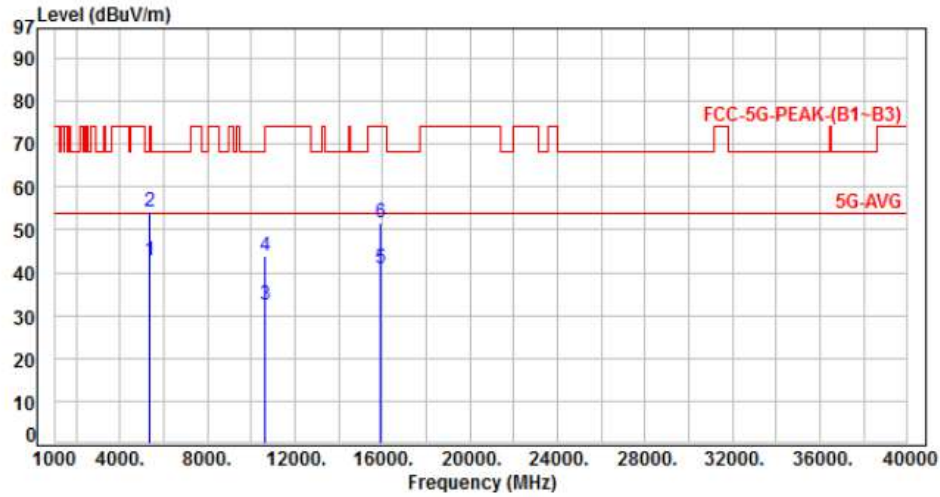

No.	Frequency (MHz)	Factor (dB)	Reading (dBuV)	Level (dBuV/m)	Limit (dBuV/m)	Margin (dB)	Detector	Height (cm)	Azimuth (deg)	P/F
1	5350.00	-5.50	48.33	42.83	54.00	-11.17	Average	384	300	P
2	5350.00	-5.50	59.78	54.28	74.00	-19.72	Peak	384	300	P
3	10600.00	2.80	29.78	32.58	54.00	-21.42	Average	378	201	P
4	10600.00	2.80	41.25	44.05	74.00	-29.95	Peak	378	201	P
5	15900.00	8.85	32.12	40.97	54.00	-13.03	Average	353	102	P
6	15900.00	8.85	42.88	51.73	74.00	-22.27	Peak	353	102	P

Note: Level=Reading+Factor  
 Margin=Level-Limit  
 Factor=Antenna Factor + cable loss - Amplifier Factor



Power	: AC 120V / 60Hz	Pol/Phase	: VERTICAL
Test Mode	: Mode 2, Band 2, CH64		:

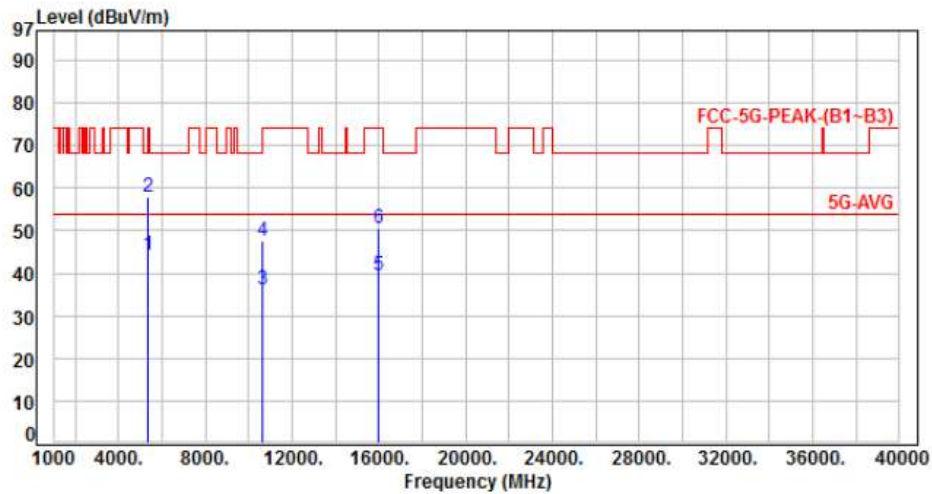

No.	Frequency (MHz)	Factor (dB)	Reading (dBUV)	Level (dBUV/m)	Limit (dBUV/m)	Margin (dB)	Detector	Height (cm)	Azimuth (deg)	P/F
1	5350.00	-5.50	49.69	44.19	54.00	-9.81	Average	100	134	P
2	5350.00	-5.50	63.55	58.05	74.00	-15.95	Peak	100	134	P
3	10640.00	2.87	33.44	36.31	54.00	-17.69	Average	381	102	P
4	10640.00	2.87	44.58	47.45	74.00	-26.55	Peak	381	102	P
5	15960.00	8.82	30.67	39.49	54.00	-14.51	Average	392	155	P
6	15960.00	8.82	41.75	50.57	74.00	-23.43	Peak	392	155	P

Note: Level=Reading+Factor  
 Margin=Level-Limit  
 Factor=Antenna Factor + cable loss - Amplifier Factor



Power	: AC 120V / 60Hz	Pol/Phase	: HORIZONTAL
Test Mode	: Mode 2, Band 2, CH64		:

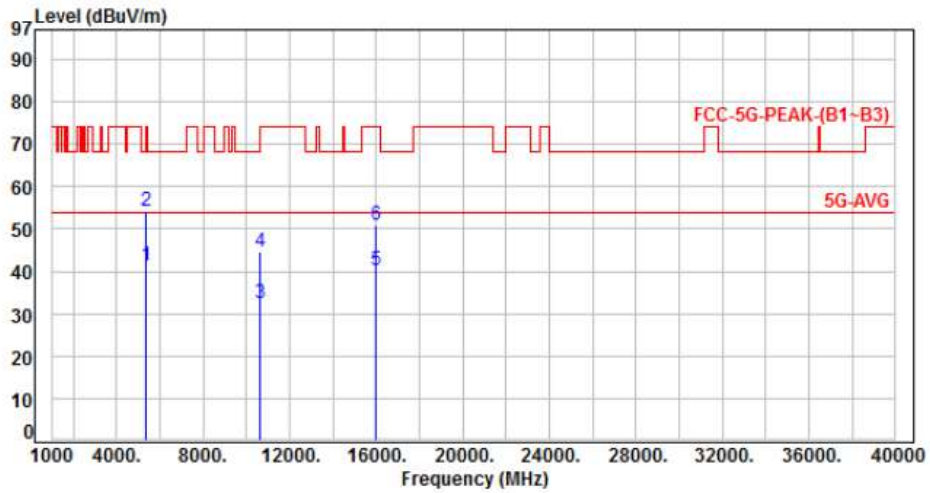

No.	Frequency (MHz)	Factor (dB)	Reading (dBuV)	Level (dBuV/m)	Limit (dBuV/m)	Margin (dB)	Detector	Height (cm)	Azimuth (deg)	P/F
1	5350.00	-5.50	46.77	41.27	54.00	-12.73	Average	171	215	P
2	5350.00	-5.50	59.67	54.17	74.00	-19.83	Peak	171	215	P
3	10640.00	2.87	29.64	32.51	54.00	-21.49	Average	352	166	P
4	10640.00	2.87	41.58	44.45	74.00	-29.55	Peak	352	166	P
5	15960.00	8.82	31.47	40.29	54.00	-13.71	Average	382	201	P
6	15960.00	8.82	42.06	50.88	74.00	-23.12	Peak	382	201	P

Note: Level=Reading+Factor  
Margin=Level-Limit  
Factor=Antenna Factor + cable loss - Amplifier Factor



Power	: AC 120V / 60Hz	Pol/Phase	: VERTICAL
Test Mode	: Mode 3, Band 2, CH54		:

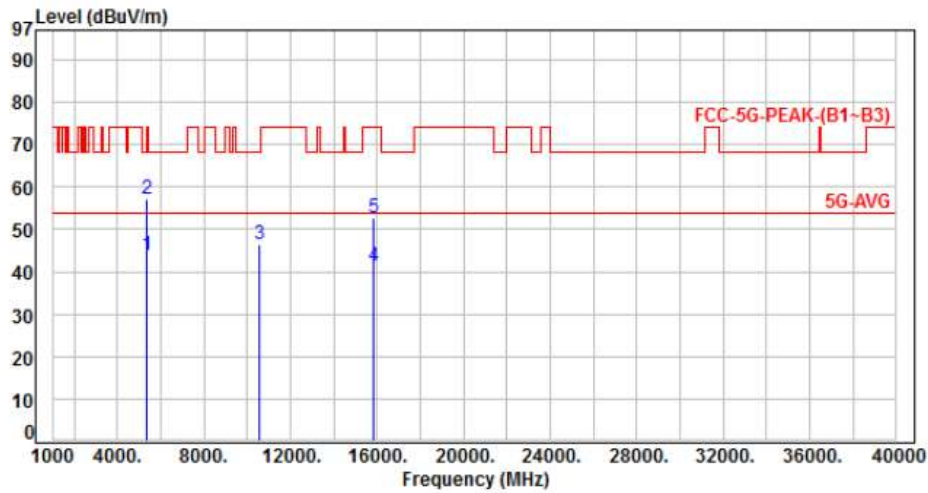

No.	Frequency (MHz)	Factor (dB)	Reading (dBuV)	Level (dBuV/m)	Limit (dBuV/m)	Margin (dB)	Detector	Height (cm)	Azimuth (deg)	P/F
1	5350.00	-5.50	49.21	43.71	54.00	-10.29	Average	100	120	P
2	5350.00	-5.50	62.70	57.20	74.00	-16.80	Peak	100	120	P
3	10540.00	2.70	43.85	46.55	68.20	-21.65	Peak	372	300	P
4	15810.00	8.63	32.60	41.23	54.00	-12.77	Average	377	166	P
5	15810.00	8.63	44.21	52.84	74.00	-21.16	Peak	377	166	P

Note: Level=Reading+Factor  
 Margin=Level-Limit  
 Factor=Antenna Factor + cable loss - Amplifier Factor





Power	: AC 120V / 60Hz	Pol/Phase	: HORIZONTAL
Test Mode	: Mode 3, Band 2, CH54		:

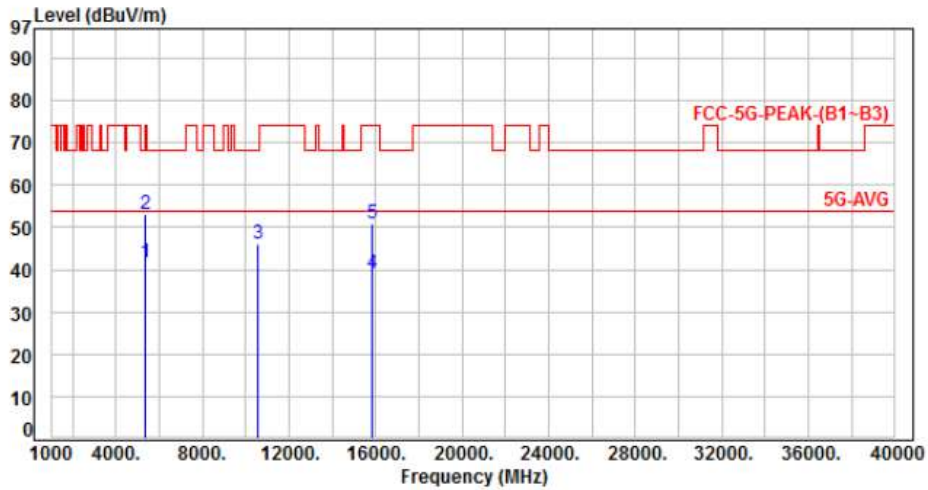

No.	Frequency (MHz)	Factor (dB)	Reading (dBuV)	Level (dBuV/m)	Limit (dBuV/m)	Margin (dB)	Detector	Height (cm)	Azimuth (deg)	P/F
1	5350.00	-5.50	47.21	41.71	54.00	-12.29	Average	133	210	P
2	5350.00	-5.50	58.59	53.09	74.00	-20.91	Peak	133	210	P
3	10540.00	2.70	43.32	46.02	68.20	-22.18	Peak	359	300	P
4	15810.00	8.63	30.63	39.26	54.00	-14.74	Average	374	158	P
5	15810.00	8.63	42.21	50.84	74.00	-23.16	Peak	374	158	P

Note: Level=Reading+Factor  
 Margin=Level-Limit  
 Factor=Antenna Factor + cable loss - Amplifier Factor



Power	: AC 120V / 60Hz	Pol/Phase	: VERTICAL
Test Mode	: Mode 3, Band 2, CH62		:

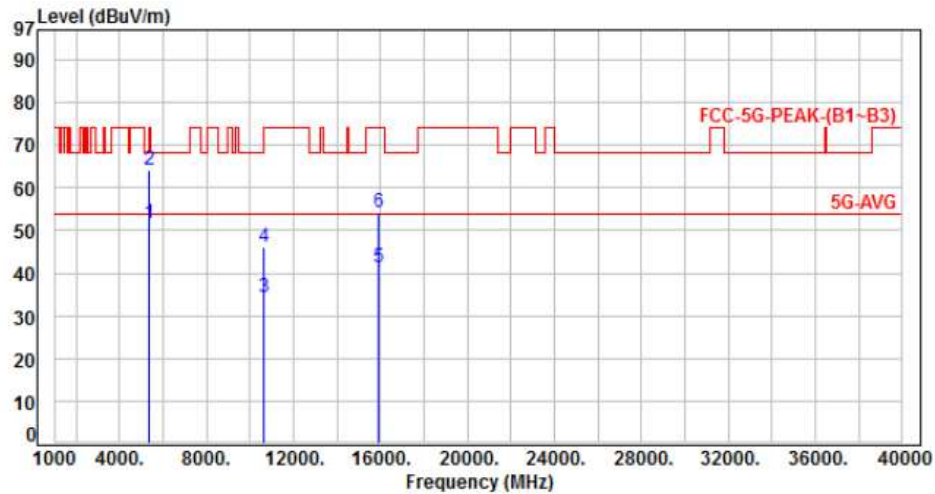

No.	Frequency (MHz)	Factor (dB)	Reading (dBuV)	Level (dBuV/m)	Limit (dBuV/m)	Margin (dB)	Detector	Height (cm)	Azimuth (deg)	P/F
1	5350.00	-5.50	57.21	51.71	54.00	-2.29	Average	100	136	P
2	5350.00	-5.50	69.50	64.00	74.00	-10.00	Peak	100	136	P
3	10620.00	2.83	31.32	34.15	54.00	-19.85	Average	385	306	P
4	10620.00	2.83	43.36	46.19	74.00	-27.81	Peak	385	306	P
5	15930.00	8.83	32.47	41.30	54.00	-12.70	Average	348	170	P
6	15930.00	8.83	45.40	54.23	74.00	-19.77	Peak	348	170	P

Note: Level=Reading+Factor  
 Margin=Level-Limit  
 Factor=Antenna Factor + cable loss - Amplifier Factor



Power	: AC 120V / 60Hz	Pol/Phase	: HORIZONTAL
Test Mode	: Mode 3, Band 2, CH62		:

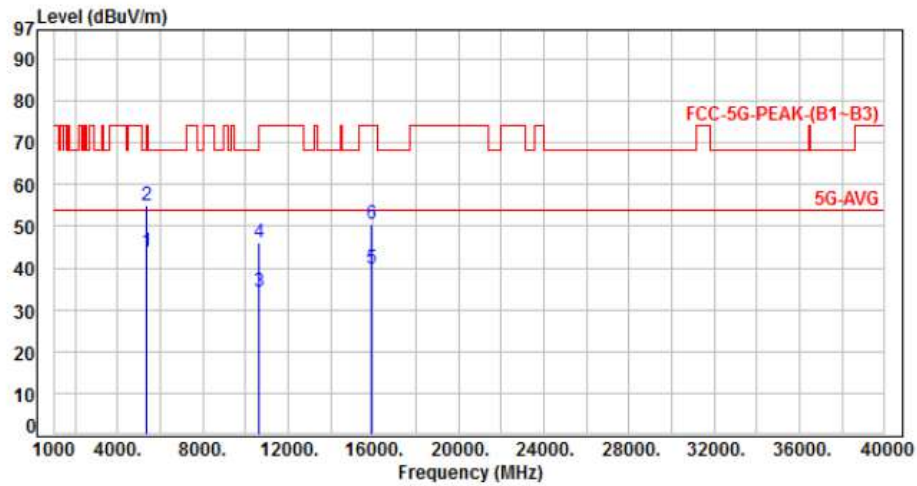

No.	Frequency (MHz)	Factor (dB)	Reading (dBuV)	Level (dBuV/m)	Limit (dBuV/m)	Margin (dB)	Detector	Height (cm)	Azimuth (deg)	P/F
1	5350.00	-5.50	49.42	43.92	54.00	-10.08	Average	132	218	P
2	5350.00	-5.50	60.40	54.90	74.00	-19.10	Peak	132	218	P
3	10620.00	2.83	31.46	34.29	54.00	-19.71	Average	355	156	P
4	10620.00	2.83	43.25	46.08	74.00	-27.92	Peak	355	156	P
5	15930.00	8.83	30.97	39.80	54.00	-14.20	Average	376	146	P
6	15930.00	8.83	41.59	50.42	74.00	-23.58	Peak	376	146	P

Note: Level=Reading+Factor  
Margin=Level-Limit  
Factor=Antenna Factor + cable loss - Amplifier Factor



Power	: AC 120V / 60Hz	Pol/Phase	: VERTICAL
Test Mode	: Mode 4, Band 2, CH58		:

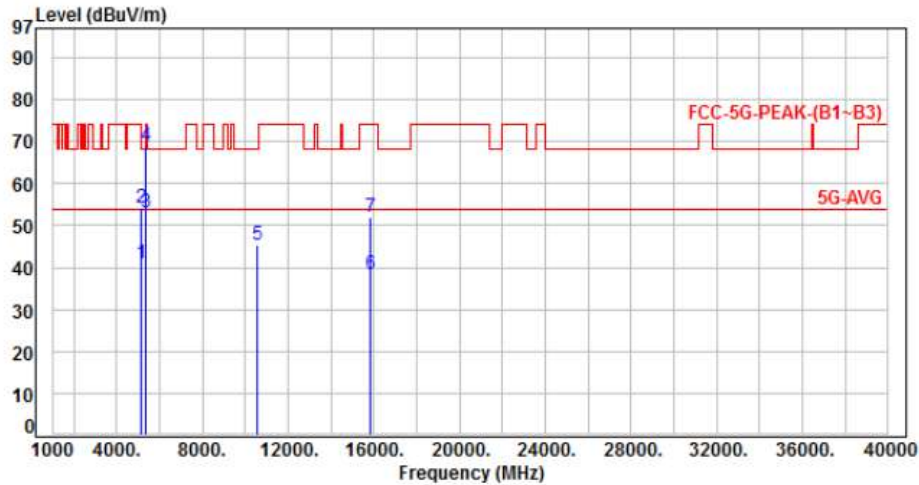

No.	Frequency (MHz)	Factor (dB)	Reading (dBuV)	Level (dBuV/m)	Limit (dBuV/m)	Margin (dB)	Detector	Height (cm)	Azimuth (deg)	P/F
1	5150.00	-5.86	46.95	41.09	54.00	-12.91	Average	110	135	P
2	5150.00	-5.86	59.90	54.04	74.00	-19.96	Peak	110	135	P
3	5350.00	-5.50	58.50	53.00	54.00	-1.00	Average	110	135	P
4	5350.00	-5.50	74.30	68.80	74.00	-5.20	Peak	110	135	P
5	10580.00	2.77	42.66	45.43	68.20	-22.77	Peak	100	74	P
6	15870.00	8.78	29.63	38.41	54.00	-15.59	Average	100	105	P
7	15870.00	8.78	43.06	51.84	74.00	-22.16	Peak	100	105	P

Note: Level=Reading+Factor  
 Margin=Level-Limit  
 Factor=Antenna Factor + cable loss - Amplifier Factor



Power	: AC 120V / 60Hz	Pol/Phase	: HORIZONTAL
Test Mode	: Mode 4, Band 2, CH58		

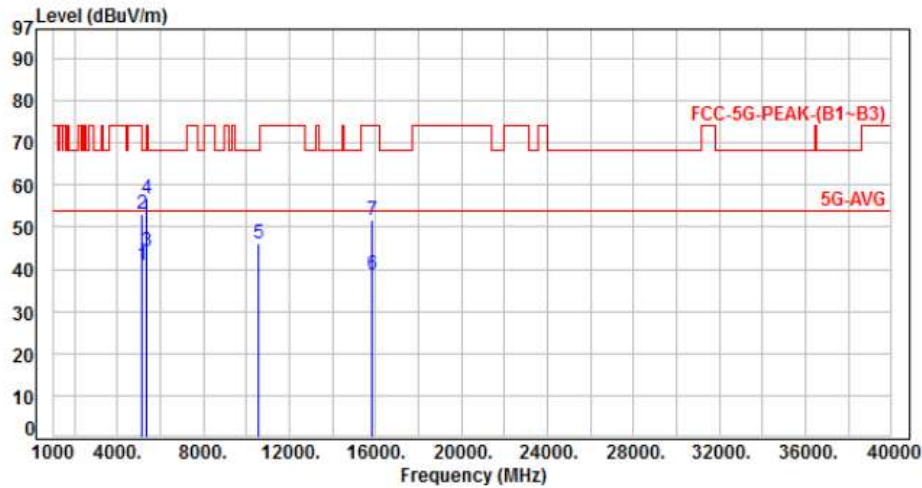

No.	Frequency (MHz)	Factor (dB)	Reading (dBuV)	Level (dBuV/m)	Limit (dBuV/m)	Margin (dB)	Detector	Height (cm)	Azimuth (deg)	P/F
1	5150.00	-5.86	46.70	40.84	54.00	-13.16	Average	100	215	P
2	5150.00	-5.86	58.96	53.10	74.00	-20.90	Peak	100	215	P
3	5350.00	-5.50	49.60	44.10	54.00	-9.90	Average	100	215	P
4	5350.00	-5.50	62.30	56.80	74.00	-17.20	Peak	100	215	P
5	10580.00	2.77	43.21	45.98	68.20	-22.22	Peak	100	342	P
6	15870.00	8.78	29.78	38.56	54.00	-15.44	Average	100	306	P
7	15870.00	8.78	42.88	51.66	74.00	-22.34	Peak	100	306	P

Note: Level=Reading+Factor  
 Margin=Level-Limit  
 Factor=Antenna Factor + cable loss - Amplifier Factor



Power	: AC 120V / 60Hz	Pol/Phase	: VERTICAL
Test Mode	: Mode 1, Band 3, CH100		

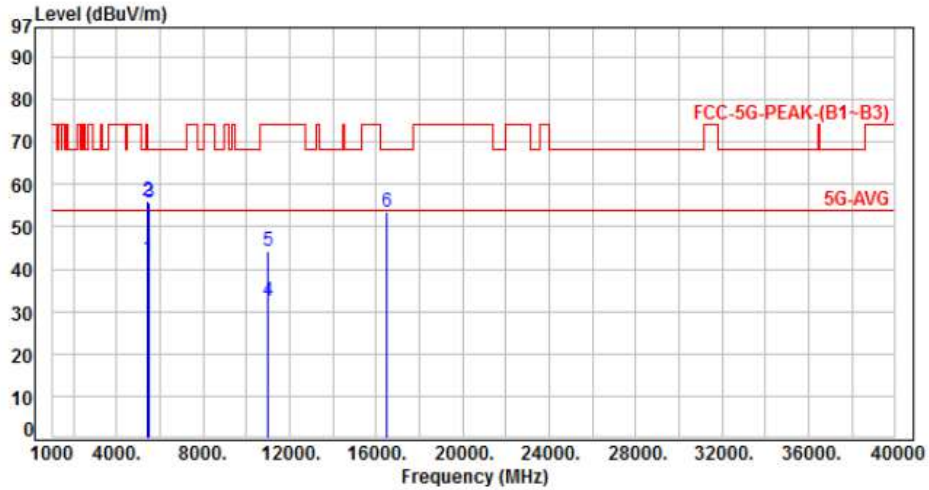

No.	Frequency (MHz)	Factor (dB)	Reading (dBuV)	Level (dBuV/m)	Limit (dBuV/m)	Margin (dB)	Detector	Height (cm)	Azimuth (deg)	P/F
1	5460.00	-5.22	47.80	42.58	54.00	-11.42	Average	100	122	P
2	5460.00	-5.22	61.20	55.98	74.00	-18.02	Peak	100	122	P
3	5470.00	-5.24	60.90	55.66	68.20	-12.54	Peak	100	122	P
4	11000.00	3.28	29.33	32.61	54.00	-21.39	Average	100	84	P
5	11000.00	3.28	41.10	44.38	74.00	-29.62	Peak	100	84	P
6	16500.00	11.00	42.58	53.58	68.20	-14.62	Peak	100	99	P

Note: Level=Reading+Factor  
 Margin=Level-Limit  
 Factor=Antenna Factor + cable loss - Amplifier Factor



Power	: AC 120V / 60Hz	Pol/Phase	: HORIZONTAL
Test Mode	: Mode 1, Band 3, CH100		:

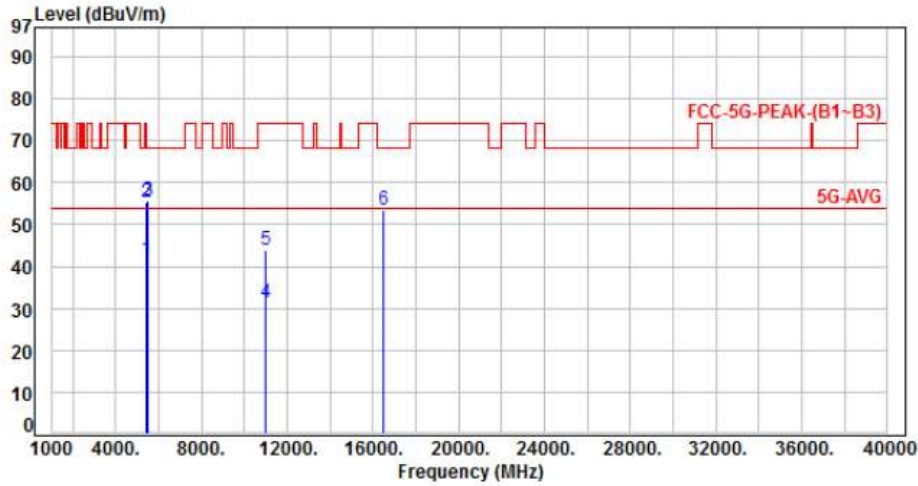

No.	Frequency (MHz)	Factor (dB)	Reading (dBUV)	Level (dBUV/m)	Limit (dBUV/m)	Margin (dB)	Detector	Height (cm)	Azimuth (deg)	P/F
1	5460.00	-5.22	46.75	41.53	54.00	-12.47	Average	100	223	P
2	5460.00	-5.22	60.49	55.27	74.00	-18.73	Peak	100	223	P
3	5470.00	-5.24	60.88	55.64	68.20	-12.56	Peak	100	223	P
4	11000.00	3.28	27.96	31.24	54.00	-22.76	Average	100	348	P
5	11000.00	3.28	40.56	43.84	74.00	-30.16	Peak	100	348	P
6	16500.00	11.00	42.66	53.66	68.20	-14.54	Peak	100	327	P

Note: Level=Reading+Factor  
Margin=Level-Limit  
Factor=Antenna Factor + cable loss - Amplifier Factor



Power	: AC 120V / 60Hz	Pol/Phase	: VERTICAL
Test Mode	: Mode 1, Band 3, CH116		:

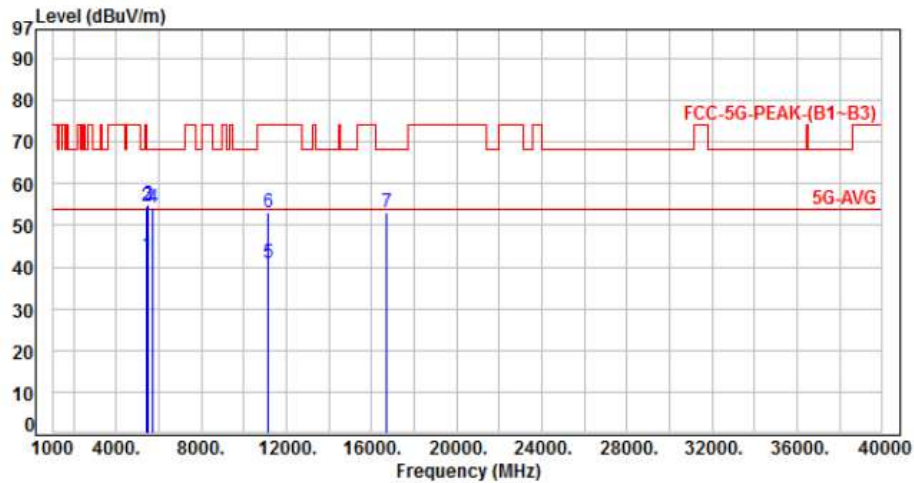

No.	Frequency (MHz)	Factor (dB)	Reading (dBUV)	Level (dBUV/m)	Limit (dBUV/m)	Margin (dB)	Detector	Height (cm)	Azimuth (deg)	P/F
1	5460.00	-5.22	47.85	42.63	54.00	-11.37	Average	104	122	P
2	5460.00	-5.22	59.70	54.48	74.00	-19.52	Peak	104	122	P
3	5470.00	-5.24	60.32	55.08	68.20	-13.12	Peak	104	122	P
4	5725.00	-5.46	59.78	54.32	68.20	-13.88	Peak	104	122	P
5	11160.00	3.46	37.60	41.06	54.00	-12.94	Average	100	165	P
6	11160.00	3.46	49.50	52.96	74.00	-21.04	Peak	100	165	P
7	16740.00	12.17	40.88	53.05	68.20	-15.15	Peak	100	81	P

Note: Level=Reading+Factor  
 Margin=Level-Limit  
 Factor=Antenna Factor + cable loss - Amplifier Factor





Power	: AC 120V / 60Hz	Pol/Phase	: HORIZONTAL
Test Mode	: Mode 1, Band 3, CH116		:

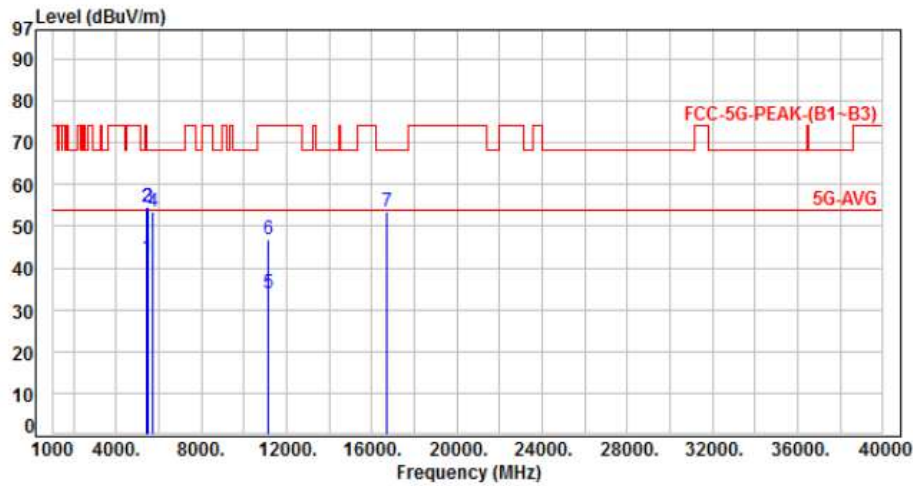

No.	Frequency (MHz)	Factor (dB)	Reading (dBuV)	Level (dBuV/m)	Limit (dBuV/m)	Margin (dB)	Detector	Height (cm)	Azimuth (deg)	P/F
1	5460.00	-5.22	47.58	42.36	54.00	-11.64	Average	100	226	P
2	5460.00	-5.22	59.76	54.54	74.00	-19.46	Peak	100	226	P
3	5470.00	-5.24	59.81	54.57	68.20	-13.63	Peak	100	226	P
4	5725.00	-5.46	59.10	53.64	68.20	-14.56	Peak	100	226	P
5	11160.00	3.46	30.55	34.01	54.00	-19.99	Average	387	171	P
6	11160.00	3.46	43.30	46.76	74.00	-27.24	Peak	387	171	P
7	16740.00	12.17	41.32	53.49	68.20	-14.71	Peak	100	346	P

Note: Level=Reading+Factor  
 Margin=Level-Limit  
 Factor=Antenna Factor + cable loss - Amplifier Factor



Power	: AC 120V / 60Hz	Pol/Phase	: VERTICAL
Test Mode	: Mode 1, Band 3, CH140		:

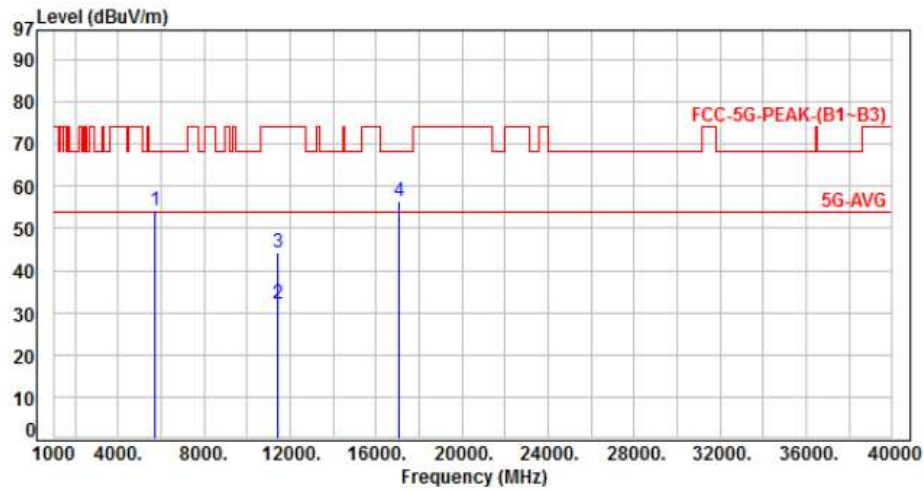

No.	Frequency (MHz)	Factor (dB)	Reading (dBuV)	Level (dBuV/m)	Limit (dBuV/m)	Margin (dB)	Detector	Height (cm)	Azimuth (deg)	P/F
1	5725.00	-5.46	59.70	54.24	68.20	-13.96	Peak	387	210	P
2	11400.00	3.78	28.33	32.11	54.00	-21.89	Average	100	179	P
3	11400.00	3.78	40.60	44.38	74.00	-29.62	Peak	100	179	P
4	17100.00	14.02	42.45	56.47	68.20	-11.73	Peak	100	72	P

Note: Level=Reading+Factor  
Margin=Level-Limit  
Factor=Antenna Factor + cable loss - Amplifier Factor



Power	: AC 120V / 60Hz	Pol/Phase	: HORIZONTAL
Test Mode	: Mode 1, Band 3, CH140		:

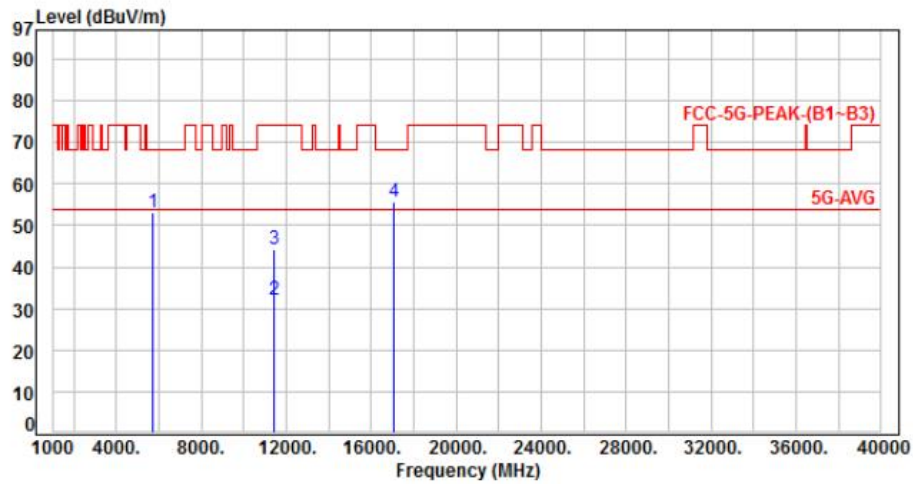

No.	Frequency (MHz)	Factor (dB)	Reading (dBuV)	Level (dBuV/m)	Limit (dBuV/m)	Margin (dB)	Detector	Height (cm)	Azimuth (deg)	P/F
1	5725.00	-5.46	58.60	53.14	68.20	-15.06	Peak	100	226	P
2	11400.00	3.78	28.19	31.97	54.00	-22.03	Average	369	182	P
3	11400.00	3.78	40.47	44.25	74.00	-29.75	Peak	369	182	P
4	17100.00	14.02	41.68	55.70	68.20	-12.50	Peak	100	318	P

Note: Level=Reading+Factor  
Margin=Level-Limit  
Factor=Antenna Factor + cable loss - Amplifier Factor



Power	: AC 120V / 60Hz	Pol/Phase	: VERTICAL
Test Mode	: Mode 2, Band 3, CH100		:

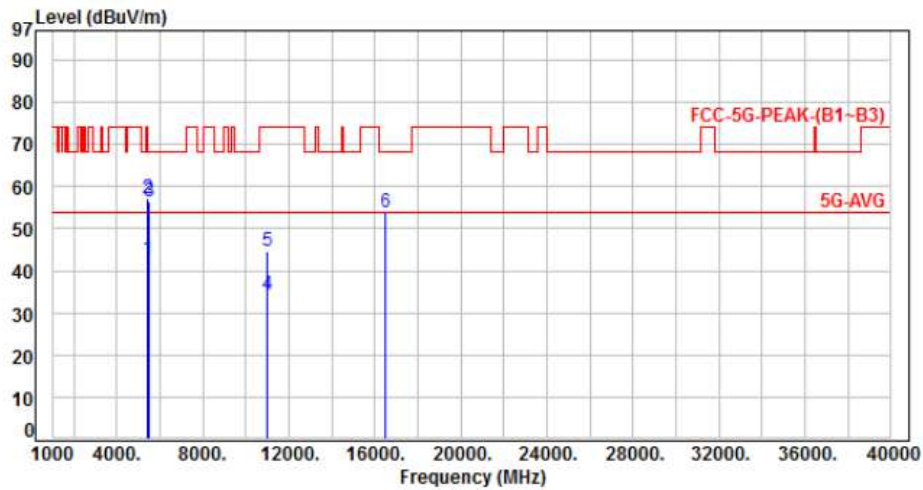

No.	Frequency (MHz)	Factor (dB)	Reading (dBuV)	Level (dBuV/m)	Limit (dBuV/m)	Margin (dB)	Detector	Height (cm)	Azimuth (deg)	P/F
1	5460.00	-5.22	48.10	42.88	54.00	-11.12	Average	100	110	P
2	5460.00	-5.22	62.30	57.08	74.00	-16.92	Peak	100	110	P
3	5470.00	-5.24	61.63	56.39	68.20	-11.81	Peak	100	110	P
4	11000.00	3.28	30.88	34.16	54.00	-19.84	Average	100	86	P
5	11000.00	3.28	41.32	44.60	74.00	-29.40	Peak	100	86	P
6	16500.00	11.00	42.76	53.76	68.20	-14.44	Peak	100	73	P

Note: Level=Reading+Factor  
 Margin=Level-Limit  
 Factor=Antenna Factor + cable loss - Amplifier Factor



Power	: AC 120V / 60Hz	Pol/Phase	: HORIZONTAL
Test Mode	: Mode 2, Band 3, CH100		:

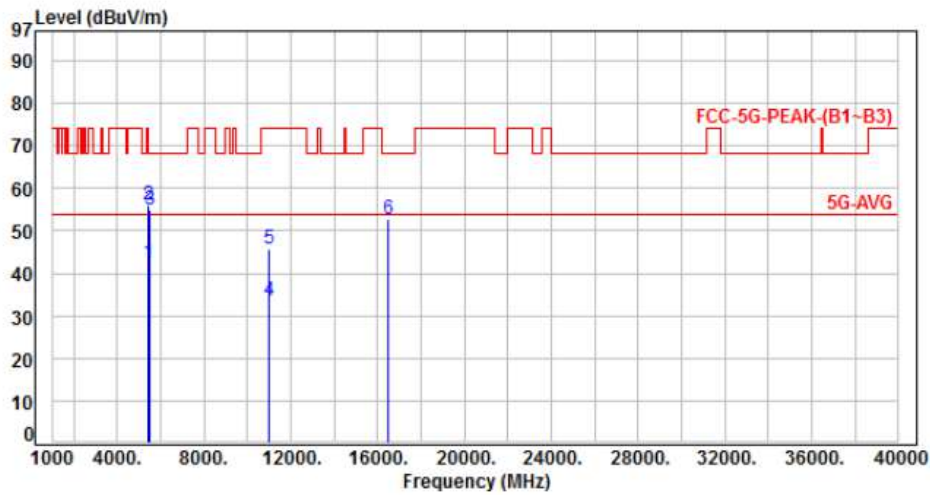

No.	Frequency (MHz)	Factor (dB)	Reading (dBUV)	Level (dBUV/m)	Limit (dBUV/m)	Margin (dB)	Detector	Height (cm)	Azimuth (deg)	P/F
1	5460.00	-5.22	47.80	42.58	54.00	-11.42	Average	100	225	P
2	5460.00	-5.22	61.40	56.18	74.00	-17.82	Peak	100	225	P
3	5470.00	-5.24	60.30	55.06	68.20	-13.14	Peak	100	225	P
4	11000.00	3.28	30.11	33.39	54.00	-20.61	Average	100	308	P
5	11000.00	3.28	42.41	45.69	74.00	-28.31	Peak	100	308	P
6	16500.00	11.00	41.73	52.73	68.20	-15.47	Peak	100	317	P

Note: Level=Reading+Factor  
 Margin=Level-Limit  
 Factor=Antenna Factor + cable loss - Amplifier Factor



Power	: AC 120V / 60Hz	Pol/Phase	: VERTICAL
Test Mode	: Mode 2, Band 3, CH116		

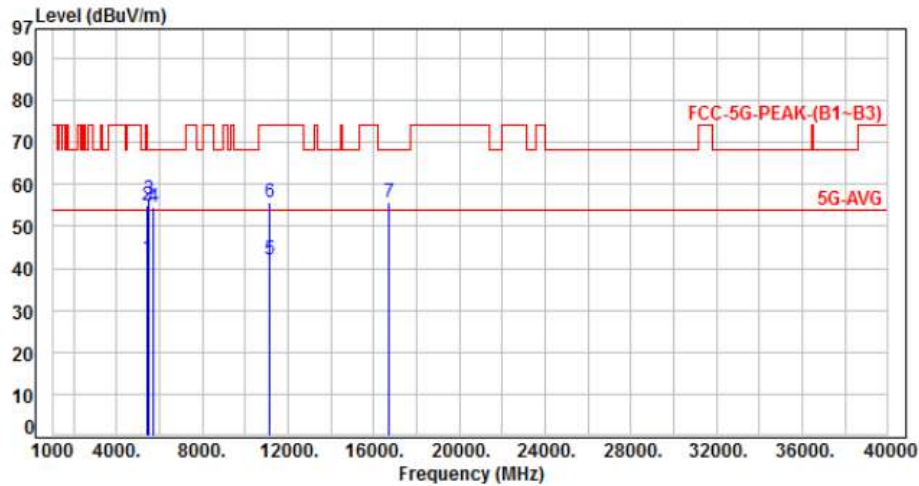

No.	Frequency (MHz)	Factor (dB)	Reading (dBuV)	Level (dBuV/m)	Limit (dBuV/m)	Margin (dB)	Detector	Height (cm)	Azimuth (deg)	P/F
1	5460.00	-5.22	47.52	42.30	54.00	-11.70	Average	100	134	P
2	5460.00	-5.22	60.24	55.02	74.00	-18.98	Peak	100	134	P
3	5470.00	-5.24	61.52	56.28	68.20	-11.92	Peak	100	134	P
4	5725.00	-5.46	59.89	54.43	68.20	-13.77	Peak	100	134	P
5	11160.00	3.46	38.54	42.00	54.00	-12.00	Average	122	164	P
6	11160.00	3.46	52.10	55.56	74.00	-18.44	Peak	122	164	P
7	16740.00	12.17	43.54	55.71	68.20	-12.49	Peak	100	102	P

Note: Level=Reading+Factor  
 Margin=Level-Limit  
 Factor=Antenna Factor + cable loss - Amplifier Factor



Power	: AC 120V / 60Hz	Pol/Phase	: HORIZONTAL
Test Mode	: Mode 2, Band 3, CH116		:

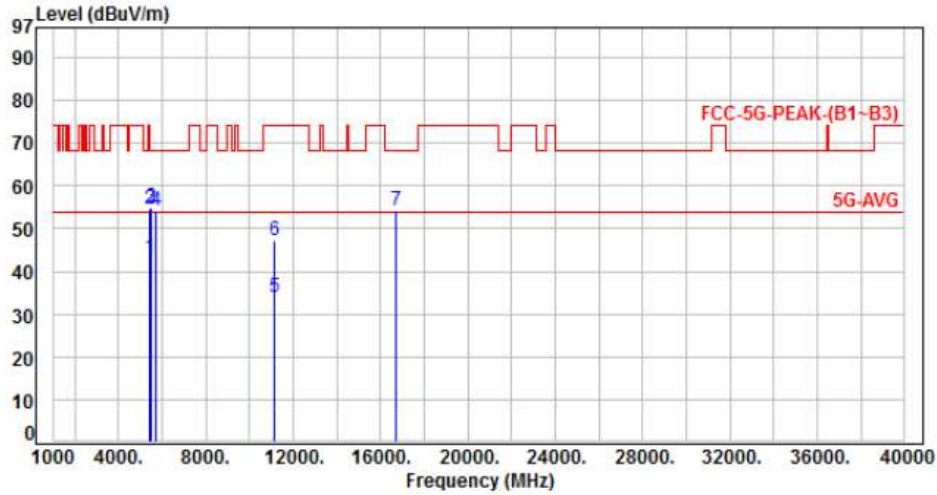

No.	Frequency (MHz)	Factor (dB)	Reading (dBuV)	Level (dBuV/m)	Limit (dBuV/m)	Margin (dB)	Detector	Height (cm)	Azimuth (deg)	P/F
1	5460.00	-5.22	48.23	43.01	54.00	-10.99	Average	100	267	P
2	5460.00	-5.22	59.88	54.66	74.00	-19.34	Peak	100	267	P
3	5470.00	-5.24	60.36	55.12	68.20	-13.08	Peak	100	267	P
4	5725.00	-5.46	59.77	54.31	68.20	-13.89	Peak	100	267	P
5	11160.00	3.46	30.57	34.03	54.00	-19.97	Average	366	182	P
6	11160.00	3.46	43.79	47.25	74.00	-26.75	Peak	366	182	P
7	16740.00	12.17	42.22	54.39	68.20	-13.81	Peak	100	358	P

Note: Level=Reading+Factor  
 Margin=Level-Limit  
 Factor=Antenna Factor + cable loss - Amplifier Factor



Power	: AC 120V / 60Hz	Pol/Phase	: VERTICAL
Test Mode	: Mode 2, Band 3, CH140		:

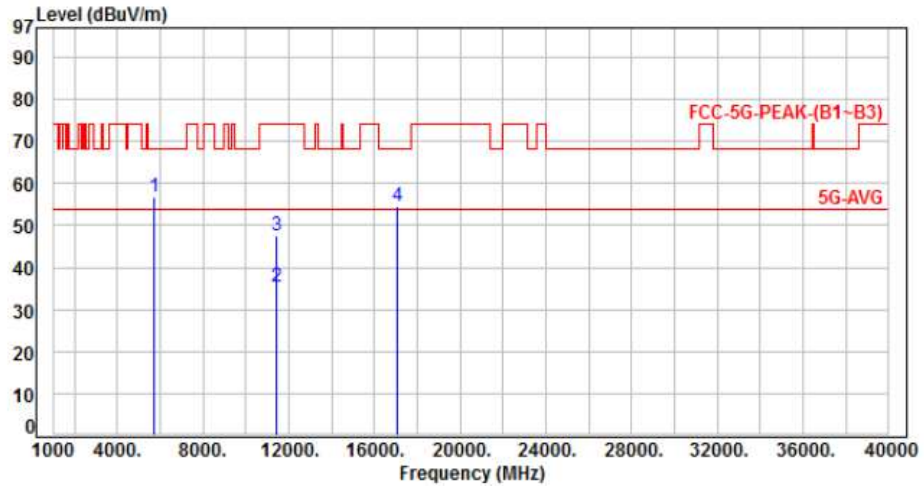

No.	Frequency (MHz)	Factor (dB)	Reading (dBuV)	Level (dBuV/m)	Limit (dBuV/m)	Margin (dB)	Detector	Height (cm)	Azimuth (deg)	P/F
1	5725.00	-5.46	62.30	56.84	68.20	-11.36	Peak	122	150	P
2	11400.00	3.78	31.60	35.38	54.00	-18.62	Average	100	181	P
3	11400.00	3.78	43.70	47.48	74.00	-26.52	Peak	100	181	P
4	17100.00	14.02	40.66	54.68	68.20	-13.52	Peak	100	92	P

Note: Level=Reading+Factor  
Margin=Level-Limit  
Factor=Antenna Factor + cable loss - Amplifier Factor





Power	: AC 120V / 60Hz	Pol/Phase	: HORIZONTAL
Test Mode	: Mode 2, Band 3, CH140		:

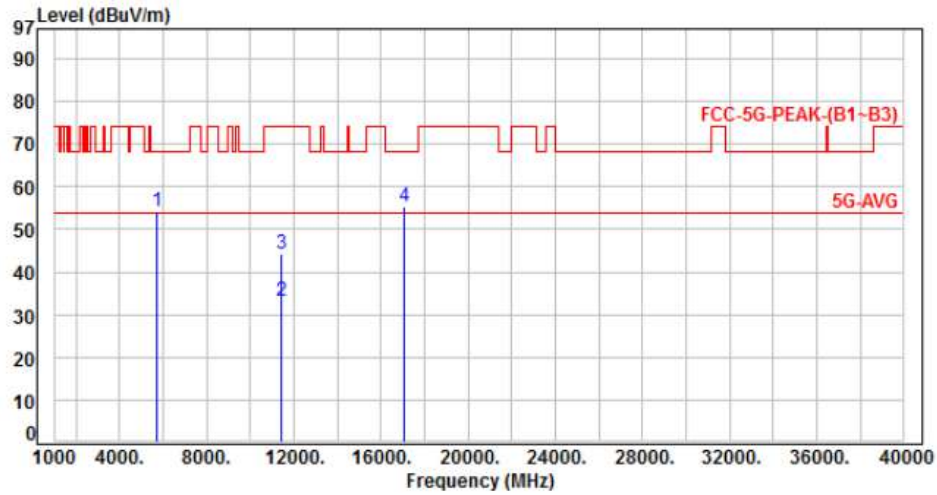

No.	Frequency (MHz)	Factor (dB)	Reading (dBuV)	Level (dBuV/m)	Limit (dBuV/m)	Margin (dB)	Detector	Height (cm)	Azimuth (deg)	P/F
1	5725.00	-5.46	59.67	54.21	68.20	-13.99	Peak	100	233	P
2	11400.00	3.78	29.54	33.32	54.00	-20.68	Average	364	193	P
3	11400.00	3.78	40.60	44.38	74.00	-29.62	Peak	364	193	P
4	17100.00	14.02	41.36	55.38	68.20	-12.82	Peak	100	351	P

Note: Level=Reading+Factor  
Margin=Level-Limit  
Factor=Antenna Factor + cable loss - Amplifier Factor



Power	: AC 120V / 60Hz	Pol/Phase	: VERTICAL
Test Mode	: Mode 3, Band 3, CH102		:

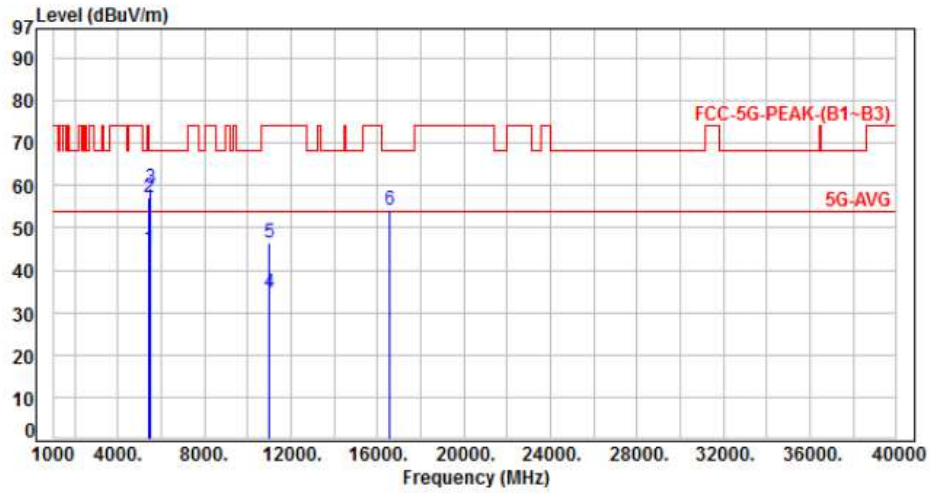

No.	Frequency (MHz)	Factor (dB)	Reading (dBuV)	Level (dBuV/m)	Limit (dBuV/m)	Margin (dB)	Detector	Height (cm)	Azimuth (deg)	P/F
1	5460.00	-5.22	50.10	44.88	54.00	-9.12	Average	100	178	P
2	5460.00	-5.22	62.40	57.18	74.00	-16.82	Peak	100	178	P
3	5470.00	-5.24	64.50	59.26	68.20	-8.94	Peak	100	178	P
4	11020.00	3.31	31.40	34.71	54.00	-19.29	Average	356	50	P
5	11020.00	3.31	43.33	46.64	74.00	-27.36	Peak	356	50	P
6	16530.00	11.15	43.11	54.26	68.20	-13.94	Peak	100	57	P

Note: Level=Reading+Factor  
Margin=Level-Limit  
Factor=Antenna Factor + cable loss - Amplifier Factor



Power	: AC 120V / 60Hz	Pol/Phase	: HORIZONTAL
Test Mode	: Mode 3, Band 3, CH102		:

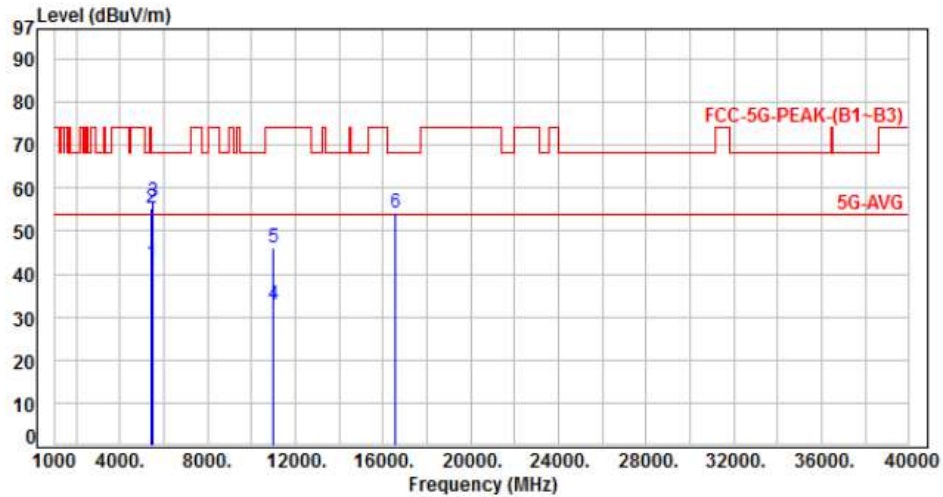

No.	Frequency (MHz)	Factor (dB)	Reading (dBuV)	Level (dBuV/m)	Limit (dBuV/m)	Margin (dB)	Detector	Height (cm)	Azimuth (deg)	P/F
1	5460.00	-5.22	47.80	42.58	54.00	-11.42	Average	363	216	P
2	5460.00	-5.22	60.60	55.38	74.00	-18.62	Peak	363	216	P
3	5470.00	-5.24	62.10	56.86	68.20	-11.34	Peak	363	216	P
4	11020.00	3.31	29.64	32.95	54.00	-21.05	Average	357	144	P
5	11020.00	3.31	42.87	46.18	74.00	-27.82	Peak	357	144	P
6	16530.00	11.15	43.16	54.31	68.20	-13.89	Peak	100	349	P

Note: Level=Reading+Factor  
Margin=Level-Limit  
Factor=Antenna Factor + cable loss - Amplifier Factor



Power	: AC 120V / 60Hz	Pol/Phase	: VERTICAL
Test Mode	: Mode 3, Band 3, CH110		:

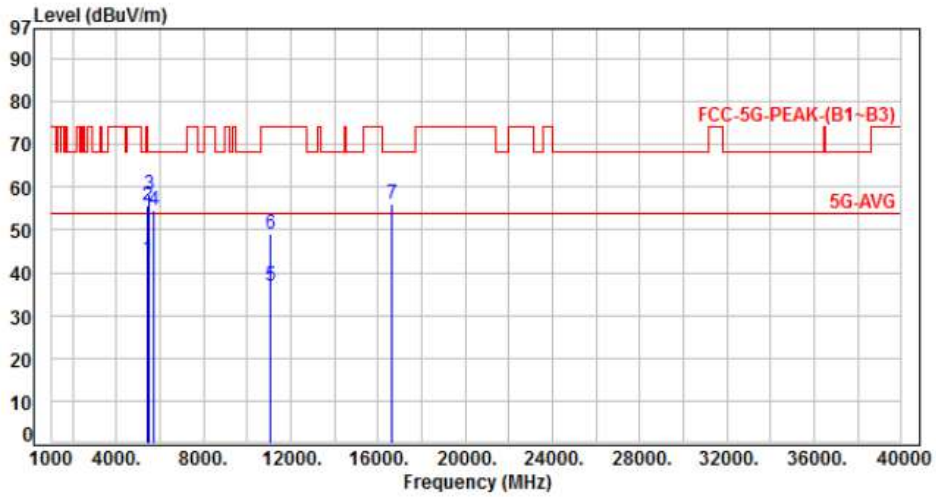

No.	Frequency (MHz)	Factor (dB)	Reading (dBuV)	Level (dBuV/m)	Limit (dBuV/m)	Margin (dB)	Detector	Height (cm)	Azimuth (deg)	P/F
1	5460.00	-5.22	48.50	43.28	54.00	-10.72	Average	105	187	P
2	5460.00	-5.22	60.80	55.58	74.00	-18.42	Peak	105	187	P
3	5470.00	-5.24	63.66	58.42	68.20	-9.78	Peak	105	187	P
4	5725.00	-5.46	59.90	54.44	68.20	-13.76	Peak	105	187	P
5	11100.00	3.43	33.40	36.83	54.00	-17.17	Average	377	159	P
6	11100.00	3.43	45.80	49.23	74.00	-24.77	Peak	377	159	P
7	16650.00	11.68	44.21	55.89	68.20	-12.31	Peak	100	73	P

Note: Level=Reading+Factor  
 Margin=Level-Limit  
 Factor=Antenna Factor + cable loss - Amplifier Factor



Power	: AC 120V / 60Hz	Pol/Phase	: HORIZONTAL
Test Mode	: Mode 3, Band 3, CH110		:

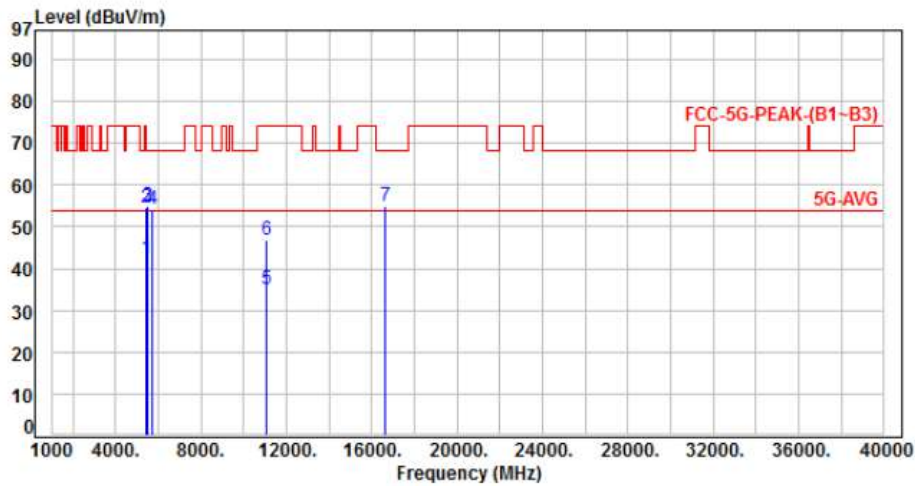

No.	Frequency (MHz)	Factor (dB)	Reading (dBuV)	Level (dBuV/m)	Limit (dBuV/m)	Margin (dB)	Detector	Height (cm)	Azimuth (deg)	P/F
1	5460.00	-5.22	47.80	42.58	54.00	-11.42	Average	100	226	P
2	5460.00	-5.22	59.66	54.44	74.00	-19.56	Peak	100	226	P
3	5470.00	-5.24	60.02	54.78	68.20	-13.42	Peak	100	226	P
4	5725.00	-5.46	59.67	54.21	68.20	-13.99	Peak	100	226	P
5	11100.00	3.43	31.56	34.99	54.00	-19.01	Average	365	111	P
6	11100.00	3.43	43.25	46.68	74.00	-27.32	Peak	365	111	P
7	16650.00	11.68	43.21	54.89	68.20	-13.31	Peak	100	328	P

Note: Level=Reading+Factor  
 Margin=Level-Limit  
 Factor=Antenna Factor + cable loss - Amplifier Factor



Power	: AC 120V / 60Hz	Pol/Phase	: VERTICAL
Test Mode	: Mode 3, Band 3, CH134		:

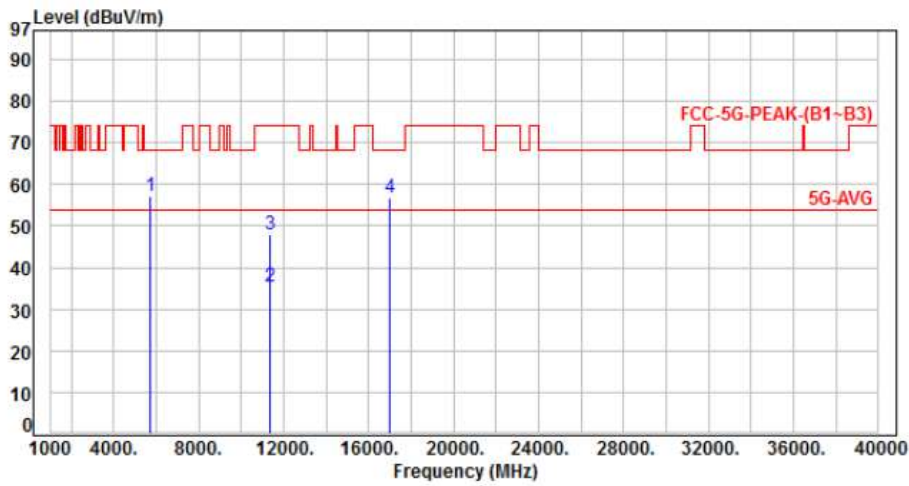

No.	Frequency (MHz)	Factor (dB)	Reading (dBuV)	Level (dBuV/m)	Limit (dBuV/m)	Margin (dB)	Detector	Height (cm)	Azimuth (deg)	P/F
1	5725.00	-5.46	62.60	57.14	68.20	-11.06	Peak	100	201	P
2	11340.00	3.63	31.62	35.25	54.00	-18.75	Average	377	154	P
3	11340.00	3.63	44.18	47.81	74.00	-26.19	Peak	377	154	P
4	17010.00	13.65	42.97	56.62	68.20	-11.58	Peak	100	105	P

Note: Level=Reading+Factor  
Margin=Level-Limit  
Factor=Antenna Factor + cable loss - Amplifier Factor