



FCC RADIO TEST REPORT

Applicant : AOPEN Inc.
Address : No. 68 Ruiguang Rd., Neihu District, Taipei City 114,
Taiwan
Equipment : AOPEN Chromebox Commercial 2
Model No. : BC5000
Trade Name : AOPEN
FCC ID. : YEW-BC5000I7265

I HEREBY CERTIFY THAT :

The sample was received on Apr. 15, 2019 and the testing was carried out on Jun. 08, 2019 at CerpPASS Technology Corp. The test result refers exclusively to the test presented test model / sample. Without written approval of CerpPASS Technology Corp., the test report shall not be reproduced except in full.

Approved by:

Mark Liao / Supervisor

Laboratory Accreditation:

CerpPASS Technology Corporation Test Laboratory





Contents

- 1. **Summary of Test Procedure and Test Results..... 5**
 - 1.1 Applicable Standards 5
- 2. **Test Configuration of Equipment under Test 6**
 - 2.1 Feature of Equipment..... 6
 - 2.2 Carrier Frequency of Channels 7
 - 2.3 Test Mode and Test Software 8
 - 2.4 Description of Test System..... 9
 - 2.5 General Information of Test..... 10
 - 2.6 Measurement Uncertainty 11
- 3. **Test Equipment and Ancillaries Used for Tests 12**
- 4. **Antenna Requirements 13**
 - 4.1 Antenna Construction and Directional Gain 13
- 5. **Test of AC Power Line Conducted Emission 14**
 - 5.1 Test Limit 14
 - 5.2 Test Procedures 14
 - 5.3 Typical Test Setup 15
 - 5.4 Test Result and Data 16
 - 5.5 Test Photographs 18
- 6. **Test of Radiated Spurious Emission 19**
 - 6.1 Test Limit 19
 - 6.2 Test Procedures 19
 - 6.3 Typical Test Setup 20
 - 6.4 Test Result and Data (9KHz ~ 30MHz) 21
 - 6.5 Test Result and Data (30MHz ~ 1GHz)..... 21
 - 6.6 Test Result and Data (1GHz ~ 25GHz) 23
 - 6.7 Restricted Bands of Operation 47
 - 6.8 Test Photographs (30MHz ~ 1GHz) 48
 - 6.9 Test Photographs (1GHz ~ 25GHz) 49
- 7. **Test of Conducted Spurious Emission 50**
 - 7.1 Test Limit 50
 - 7.2 Test Procedure 50
 - 7.3 Test Setup Layout 50
 - 7.4 Test Result and Data 50
- 8. **On Time, Duty Cycle and Measurement methods 67**
 - 8.1 Test Limit 67
 - 8.2 Test Procedure 67
 - 8.3 Test Setup Layout 67
 - 8.4 Test Result and Data 67
- 9. **6dB Bandwidth Measurement Data 69**
 - 9.1 Test Limit 69
 - 9.2 Test Procedures 69
 - 9.3 Test Setup Layout 69



9.4 Test Result and Data 69

10. Maximum Peak and Average Output Power 74

10.1 Test Limit 74

10.2 Test Procedures 74

10.3 Test Setup Layout 74

10.4 Test Result and Data 74

11. Power Spectral Density 76

11.1 Test Limit 76

11.2 Test Procedures 76

11.3 Test Setup Layout 76

11.4 Test Result and Data 76

12. Radio Frequency Exposure 81

12.1 Applicable Standards 81

12.2 EUT Specification 81

12.3 Test Results 82

12.4 Calculation 82

12.5 Maximum Permissible Exposure 83



History of this test report

Report No.	Issue Date	Description
TEF11903256	Jun. 12, 2019	Original



1. Summary of Test Procedure and Test Results

1.1 Applicable Standards

ANSI C63.4:2014

ANSI C63.10:2013

FCC Rules and Regulations Part 15 Subpart C §15.247

KDB558074

KDB662911

KDB447498

FCC Rule	Description of Test	Result
15.203	. Antenna Requirement	PASS
15.207	. AC Power Line Conducted Emission	PASS
15.209 15.205	. Radiated Spurious Emission	PASS
15.247(d)	. Conducted Spurious Emission	PASS
15.247(a)(2)	. 6dB Bandwidth	PASS
15.247(b)	. Maximum Peak and Average Output Power	PASS
15.247(e)	. Power Spectral Density	PASS
2.1091	. Radio Frequency Exposure	PASS

*The principle of judgment is made according to the laboratory's reporting control and measurement uncertainty standard procedures.

*This EUT has been also tested and compiled with the requirement of FCC Part 15, Subpart B, recorded in a separate test report(TEFD1901352).



2. Test Configuration of Equipment under Test

2.1 Feature of Equipment

WLAN Module	Intel / Dual Band Wireless-AC 7265(Stone Peak)
Frequency Range	BT / BLE: 2400-2483.5MHz 802.11b/g/n: 2400-2483.5MHz 802.11a/n/ac: 5150-5250MHz, 5250-5350MHz, 5470-5725MHz, 5725-5850MHz
Modulation Type	BT: GFSK, $\pi/4$ -DQPSK, 8DPSK BLE: GFSK 802.11b: CCK, DQPSK, DBPSK 802.11g/n/a: BPSK, QPSK, 16QAM, 64QAM 802.11ac: BPSK, QPSK, 16QAM, 64QAM, 256QAM
Data Rate	BT: GFSK: 1Mbps, $\pi/4$ -DQPSK: 2Mbps, 8DPSK: 3Mbps BLE: GFSK: 1Mbps WLAN: 802.11b: 1, 2, 5.5, 11Mbps 802.11g: 6, 9, 12, 18, 24, 36, 48, 54Mbps 802.11n: MCS0 – MCS15, HT20/40 802.11a: 6, 9, 12, 18, 24, 36, 48, 54Mbps 802.11ac: MCS0 – MCS9, VHT20/40/80
Antenna Type	Dipole Antenna
Antenna Gain	2400-2483.5MHz: 3.53dBi 5150-5250MHz: 2.52dBi 5250-5350MHz: 2.52dBi 5470-5725MHz: 2.02dBi 5725-5850MHz: 1.59dBi
Data Rate	BT: GFSK: 1Mbps, $\pi/4$ -DQPSK: 2Mbps, 8DPSK: 3Mbps BLE: GFSK: 1Mbps WLAN: 802.11b: 1, 2, 5.5, 11Mbps 802.11g: 6, 9, 12, 18, 24, 36, 48, 54Mbps 802.11n: MCS0 – MCS15, HT20/40 802.11a: 6, 9, 12, 18, 24, 36, 48, 54Mbps 802.11ac: MCS0 – MCS9, VHT20/40/80
Adapter	Chicony \ A11-065N1A INPUT: 100-240V~1.7A 50-60Hz OUTPUT: 19V / 3.42A 65W Chicony \ A16-090P1A INPUT: 100-240V~1.5A 50-60Hz OUTPUT: 19V / 4.74A 90W

Note:

1. For a more detailed features description, please refer to the manufacturer's specifications or the User's Manual.



2.2 Carrier Frequency of Channels

802.11b, 802.11g, 802.11n HT20 (2412MHz~2462MHz)

Channel	Frequency(MHz)	Channel	Frequency(MHz)
*01	2412	07	2442
02	2417	08	2447
03	2422	09	2452
04	2427	10	2457
05	2432	*11	2462
*06	2437	---	---

802.11n HT40 (2422MHz~2452MHz)

Channel	Frequency(MHz)	Channel	Frequency(MHz)
---	---	07	2442
---	---	08	2447
*03	2422	*09	2452
04	2427	---	---
05	2432	---	---
*06	2437	---	---

Note: Channels remarked * are selected to perform test.



2.3 Test Mode and Test Software

- a. During testing, the interface cables and equipment positions were varied according to ANSI C63.10.
- b. The complete test system included Remote workstation and EUT for RF test. The Remote workstation included Notebook.
- c. An executive program, "DRTU Ver 11.1833.0-08103" under WIN 7 was executed to transmit and receive data via WLAN.
- d. The following test modes were performed for the test:

Conducted Emissions from the AC mains power ports	
Test Mode	Operating Description
1	802.11b (1Mbps)
2	802.11g (6Mbps)
3	802.11n HT20 (6.5Mbps)
4	802.11n HT40 (13.5Mbps)
caused "Test Mode 3" generated the worst case, it was reported as the final data.	
Radiation Emissions (30MHz ~ 1GHz)	
Test Mode	Operating Description
1	802.11b (1Mbps)
2	802.11g (6Mbps)
3	802.11n HT20 (6.5Mbps)
4	802.11n HT40 (13.5Mbps)
caused "Test Mode 3" generated the worst case, they were reported as the final data.	
Radiation Emissions (1GHz ~ 25GHz)	
Test Mode	Operating Description
1	802.11b (1Mbps)
2	802.11g (6Mbps)
3	802.11n HT20 (6.5Mbps)
4	802.11n HT40 (13.5Mbps)
caused "Test Mode 1~4" generated the worst case, they were reported as the final data.	



2.4 Description of Test System

RF Conducted				
Equipment	Brand	Model	Length/Type	Power cord/Length/Type
Notebook	DELL	Latitude E5470	N/A	Adapter / 1.8m / NS
AP	D-link	DIR-868L	N/A	Adapter / 1.5m / NS
Network cable	N/A	N/A	1.2m / NS	N/A
Network cable	N/A	N/A	1.2m / NS	N/A
Radiated Emissions				
Equipment	Brand	Model	Length/Type	Power cord/Length/Type
Notebook	DELL	Latitude E5470	N/A	Adapter / 1.8m / NS
AP	D-link	DIR-868L	N/A	Adapter / 1.5m / NS
Network cable	N/A	N/A	15m / NS	N/A
Network cable	N/A	N/A	15m / NS	N/A
AC Power Line Conducted Emission				
Equipment	Brand	Model	Length/Type	Power cord/Length/Type
Notebook	DELL	Latitude E5470	N/A	Adapter / 1.8m / NS
AP	D-link	DIR-868L	N/A	Adapter / 1.5m / NS
Network cable	N/A	N/A	15m / NS	N/A
Network cable	N/A	N/A	15m / NS	N/A



2.5 General Information of Test

Test Site	CerpPASS Technology Corporation Test Laboratory Address: No.10, Ln. 2, Lianfu St., Luzhu Dist., Taoyuan City 33848, Taiwan (R.O.C.) Tel:+886-3-3226-888 Fax:+886-3-3226-881 Address: No.68-1, Shihbachongsi, Shihding Township, New Taipei City 223, Taiwan, R.O.C. Tel: +886-2-2663-8582	
	FCC	TW1079, TW1061, TW1439
	IC	4934E-1, 4934E-2
	VCCI	T-2205 for Telecommunication test C-4663 for Conducted emission test R-4399, R-4218 for Radiated emission test G-10812, G-10813 for radiated disturbance above 1GHz
Frequency Range Investigated:	Conducted: from 150kHz to 30 MHz Radiation: from 30 MHz to 25,000MHz	
Test Distance:	The test distance of radiated emission from antenna to EUT is 3 M.	

Test Item	Test Site	Tested Date	Environmental Conditions	Tested By
RF Conducted	RFCON01-NK	2019/06/05	21°C / 63%	Leon Huang
Radiated Emissions	3M02-NK	2019/06/03	24°C / 47%	Leon Huang
RF Conduction	CON01-NK	2019/06/08	24°C / 45%	Leon Huang



2.6 Measurement Uncertainty

Measurement Item	Uncertainty
Radiated Spurious Emission(9KHz~30MHz)	±3.405dB
Radiated Spurious Emission(30MHz~1GHz)	±5.326dB
Radiated Spurious Emission(1GHz~25GHz)	±5.918dB
Conducted Spurious Emission	±2.156dB
6dB Bandwidth	±4.401%
20dB Bandwidth	±4.40%
Occupied Bandwidth	±4.41%
Peak Output Power(Conducted Power Meter)	±1.31dB
Dwell Time	±0.11%
Power Spectral Density	±2.146dB
Duty Cycle	±0.17%



3. Test Equipment and Ancillaries Used for Tests

Test Item	Radiated Emissions				
Test Site	Semi Anechoic Room(3M02-NK)				
Instrument	Manufacturer	Model No	Serial No	Calibration Date	Valid Date
Bilog Antenna	Schwarzbeck	VULB9168	275	2018/09/17	2019/09/16
Active Loop Antenna	EMCO	6507	40855	2019/05/24	2020/05/23
Horn Antenna	EMCO	3115	31589	2019/04/01	2020/03/31
Horn Anrenna	EMCO	3116	31974	2018/09/07	2019/09/06
EMI Receiver	ROHDE & SCHWARZ	ESCI	101423	2018/06/11	2019/06/10
Spectrum Analyzer	ROHDE & SCHWARZ	FSP 40	100219	2018/07/03	2019/07/02
Preamplifier	EM Electronics corp.	EM330	60660	2019/03/11	2020/03/10
Preamplifier	EMC INSTRUMENTS	EMC051845SE	980333	2018/09/18	2019/09/17
Bluetooth Tester	ROHDE & SCHWARZ	CBT	101133	2019/04/07	2020/04/06
Cable-3in1(30M-1G)	HARBOUR INDUSTRIES	LL142	CCE1316	2018/09/12	2019/09/11
Cable-0.5m(1G-40G)	Rapidtek	40GHZ 50CM	38MS-38MS50314	2019/04/09	2020/04/08
Cable-3m(1G-40G)	Rapidtek	40GHZ 300CM	38MS-38MS300314	2019/04/09	2020/04/08
Cable-8m(1G-40G)	Rapidtek	40GHZ 800CM	38MS-38MS800314	2019/04/10	2020/04/09
E3	AUDIX	v8.2014-8-6	RK-000529	NA	NA

Test Item	RF Conducted				
Test Site	RFCON01-NK				
Instrument	Manufacturer	Model No	Serial No	Calibration Date	Valid Date
Spectrum Analyzer	ROHDE & SCHWARZ	FSP 40	100219	2018/07/03	2019/07/02
Bluetooth Tester	ROHDE & SCHWARZ	CBT	101133	2019/04/07	2020/04/06
Attenuator	KEYSIGHT	8491B	MY39250705	2018/09/04	2019/09/03
TEMP & HUMI CHAMBER	T-MACHINE	TMJ-9712	T-12-040111	2018/08/30	2019/08/29
Power Sensor	Anritsu	MA2411B	1207295	2019/04/11	2020/04/10

Test Item	AC Power Line Conducted Emission				
Test Site	CON01-NK				
Instrument	Manufacturer	Model No	Serial No	Calibration Date	Valid Date
EMI Receiver	ROHDE & SCHWARZ	ESCI	100821	2018/9/12	2019/09/11
Line Impedance Stabilization Network	Schwarzbeck	NSLK 8127	8127-740	2018/6/13	2019/06/12
Pulse Limiter	ROHDE & SCHWARZ	ESH3-Z2	101933	2018/9/4	2019/09/03
E3	AUDIX	v8.2014-8-6	RK-000531	NA	NA



4. Antenna Requirements

4.1 Antenna Construction and Directional Gain

Antenna Type	Dipole Antenna
Antenna Gain	2412MHz-2462MHz: ANT A: 3.53 dBi ; ANT B: 3.53 dBi 5180MHz-5240MHz: ANT A: 2.52 dBi ; ANT B: 2.52 dBi 5260MHz-5320MHz: ANT A: 2.52 dBi ; ANT B: 2.52 dBi 5500MHz-5700MHz: ANT A: 2.02 dBi ; ANT B: 2.02 dBi 5745MHz-5825MHz: ANT A: 1.59 dBi ; ANT B: 1.59 dBi

2412-2462MHz
For Power directional gain= $G_{ant} = 3.53$ dBi For PSD directional gain = $10 \log[(10^{G1/20} + 10^{G2/20})^2 / N_{ANT}]$ = 6.54 (dBi)
5180MHz-5240MHz
For Power directional gain= $G_{ant} = 2.52$ dBi For PSD directional gain = $10 \log[(10^{G1/20} + 10^{G2/20})^2 / N_{ANT}]$ = 5.53 (dBi)
5260MHz-5320MHz
For Power directional gain= $G_{ant} = 2.52$ dBi For PSD directional gain = $10 \log[(10^{G1/20} + 10^{G2/20})^2 / N_{ANT}]$ = 5.53 (dBi)
5500MHz-5700MHz
For Power directional gain= $G_{ant} = 2.02$ dBi For PSD directional gain = $10 \log[(10^{G1/20} + 10^{G2/20})^2 / N_{ANT}]$ = 5.03 (dBi)
5745MHz-5825MHz
For Power directional gain= $G_{ant} = 1.59$ dBi For PSD directional gain = $10 \log[(10^{G1/20} + 10^{G2/20})^2 / N_{ANT}]$ = 4.60 (dBi)



5. Test of AC Power Line Conducted Emission

5.1 Test Limit

Conducted Emissions were measured from 150 kHz to 30 MHz with a bandwidth of 9 KHz, according to the methods defined in ANSI C63.4-2014. The EUT was placed on a nonmetallic stand in a shielded room 0.8 meters above the ground plane. The interface cables and equipment positioning were varied within limits of reasonable applications to determine the position produced maximum conducted emissions.

Frequency (MHz)	Quasi Peak (dB μ V)	Average (dB μ V)
0.15 – 0.5	66-56*	56-46*
0.5 – 5.0	56	46
5.0 – 30.0	60	50

*Decreases with the logarithm of the frequency.

5.2 Test Procedures

- a. The EUT was placed 0.4 meter from the conducting wall of the shielding room was kept at least 80 centimeters from any other grounded conducting surface.
- b. Connect EUT to the power mains through a line impedance stabilization network (LISN).
- c. All the support units are connecting to the other LISN.
- d. The LISN provides 50 ohm coupling impedance for the measuring instrument.
- e. The FCC states that a 50 ohm, 50 micro-Henry LISN should be used.
- f. Both sides of AC line were checked for maximum conducted interference.
- g. The frequency range from 150 kHz to 30 MHz was searched.
- h. Set the test-receiver system to Peak Detect Function and Specified Bandwidth with Maximum Hold Mode.



5.3 Typical Test Setup

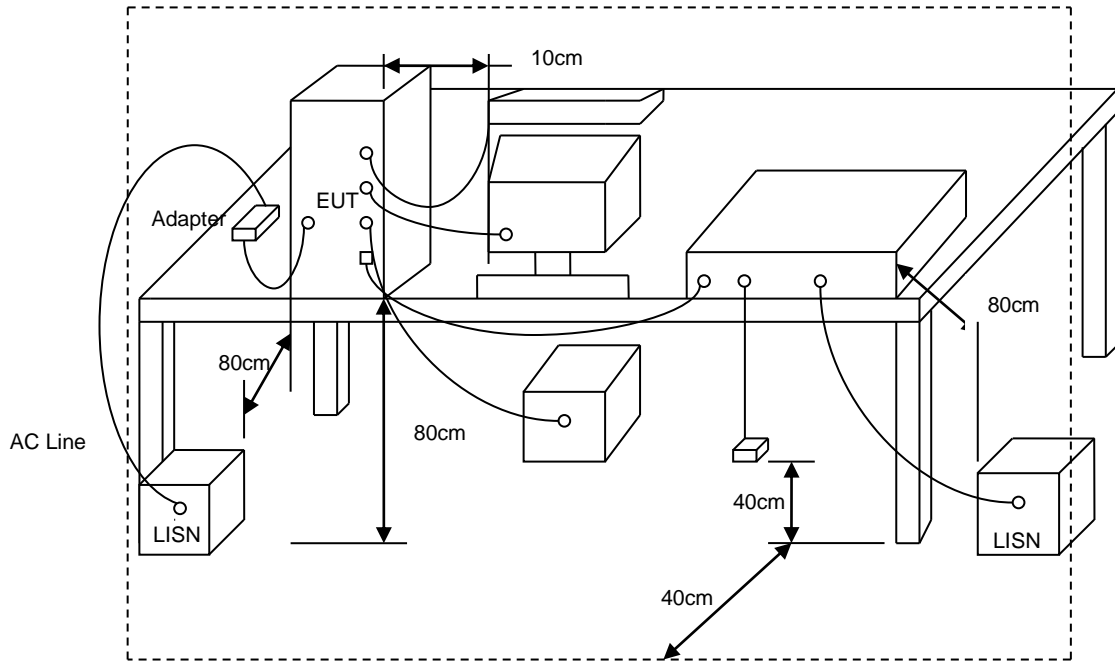



5.4 Test Result and Data

Power	: AC 120V / 60Hz	Pol/Phase	: LINE
Test Mode	: Mode 3		:

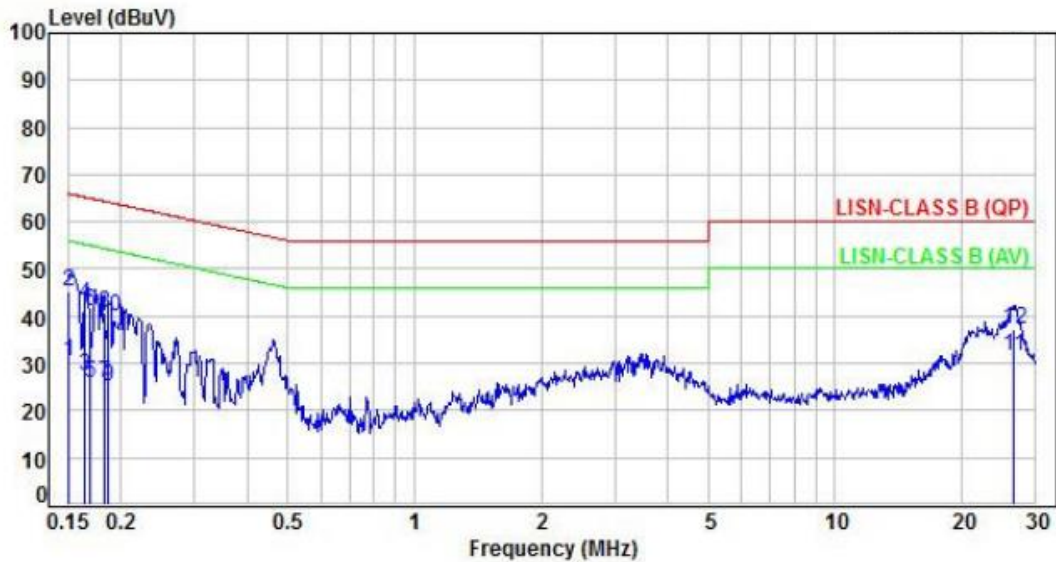

No.	Frequency (MHz)	Factor (dB)	Reading (dBuV)	Level (dBuV)	Limit (dBuV)	Margin (dB)	Detector	P/F
1	0.15	9.92	20.32	30.24	55.96	-25.72	Average	P
2	0.15	9.92	35.28	45.20	65.96	-20.76	QP	P
3	0.17	9.92	17.33	27.25	55.21	-27.96	Average	P
4	0.17	9.92	32.82	42.74	65.21	-22.47	QP	P
5	0.17	9.92	16.03	25.95	54.99	-29.04	Average	P
6	0.17	9.92	31.22	41.14	64.99	-23.85	QP	P
7	0.18	9.92	16.02	25.94	54.38	-28.44	Average	P
8	0.18	9.92	30.78	40.70	64.38	-23.68	QP	P
9	0.19	9.92	15.12	25.04	54.20	-29.16	Average	P
10	0.19	9.92	30.18	40.10	64.20	-24.10	QP	P
11	26.51	10.87	20.65	31.52	50.00	-18.48	Average	P
12	26.51	10.87	26.30	37.17	60.00	-22.83	QP	P

Note: Level=Reading+Factor
 Margin=Level-Limit
 Factor=(LISN or ISN or Current Probe)Factor + Cable Loss



Power	: AC 120V / 60Hz	Pol/Phase	: NEUTRAL
Test Mode	: Mode 3		:

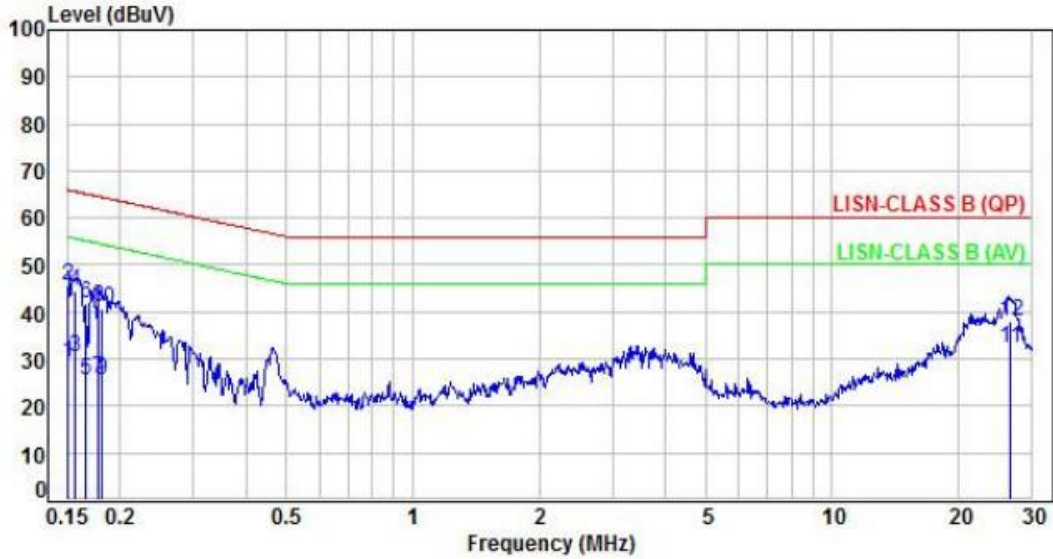

No.	Frequency (MHz)	Factor (dB)	Reading (dBUV)	Level (dBUV)	Limit (dBUV)	Margin (dB)	Detector	P/F
1	0.15	9.95	19.28	29.23	55.98	-26.75	Average	P
2	0.15	9.95	35.64	45.59	65.98	-20.39	QP	P
3	0.16	9.95	20.40	30.35	55.69	-25.34	Average	P
4	0.16	9.95	34.72	44.67	65.69	-21.02	QP	P
5	0.17	9.95	15.68	25.63	55.13	-29.50	Average	P
6	0.17	9.95	31.81	41.76	65.13	-23.37	QP	P
7	0.18	9.95	15.97	25.92	54.58	-28.66	Average	P
8	0.18	9.95	31.26	41.21	64.58	-23.37	QP	P
9	0.18	9.95	15.38	25.33	54.45	-29.12	Average	P
10	0.18	9.95	30.82	40.77	64.45	-23.68	QP	P
11	26.57	10.89	21.51	32.40	50.00	-17.60	Average	P
12	26.57	10.89	27.00	37.89	60.00	-22.11	QP	P

Note: Level=Reading+Factor
 Margin=Level-Limit
 Factor=(LISN or ISN or Current Probe)Factor + Cable Loss



5.5 Test Photographs

Front View



Rear View

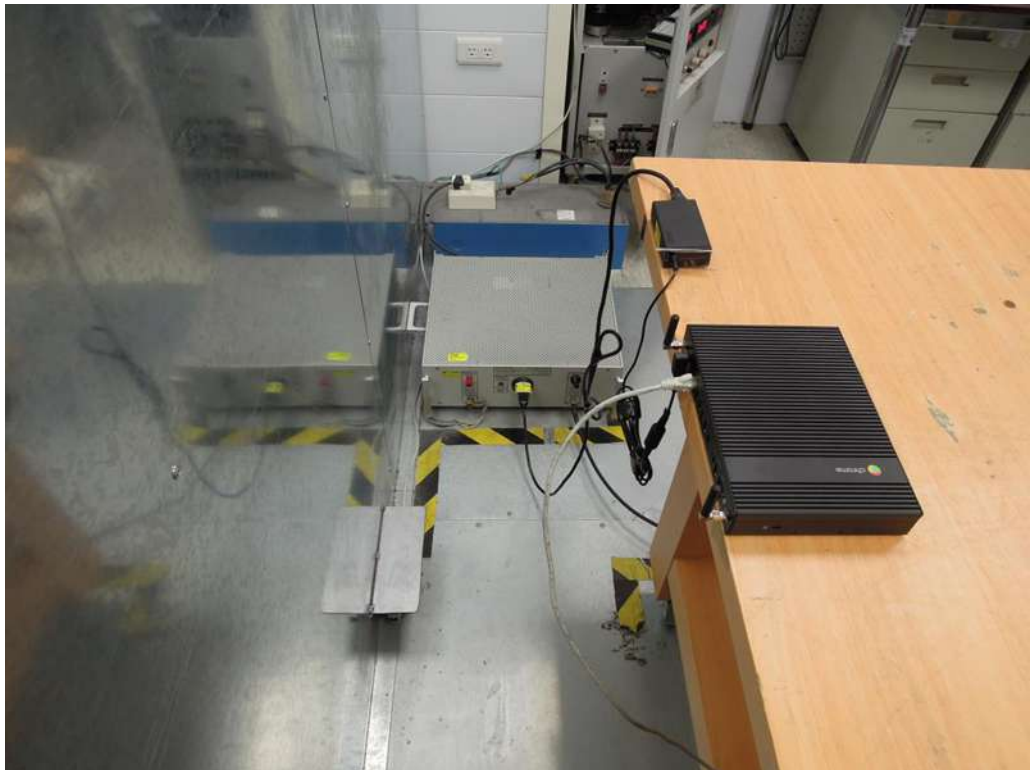



6. Test of Radiated Spurious Emission

6.1 Test Limit

In any 100kHz bandwidth outside the frequency band in which the spread spectrum or digitally modulated intentional radiator is operating, the radio frequency power that is produced by the intentional radiator shall be at least 20dB below that in the 100kHz bandwidth within the band that contains the highest level of the desired power, based on either an RF conducted or a radiated measurement. If the transmitter measurement is based on the maximum conducted output power, the attenuation required under this paragraph shall be 30dB instead of 20dB. In addition, radiated emissions which fall in section 15.205(a) the restricted bands must also comply with the radiated emission limit specified in section 15.209(a).

Frequency (MHz)	Field Strength (microvolt/meter)	Measurement Distance (meters)
0.009 ~ 0.490	2400/F(kHz)	300
0.490 ~ 1.705	24000/F(kHz)	30
1.705 ~ 30.0	30	30
30 ~ 88	100	3
88 ~ 216	150	3
216 ~ 960	200	3
Above 960	500	3

6.2 Test Procedures

- The EUT was placed on a rotatable table top 0.8 meter above ground.
- The EUT was set 3 meters from the interference receiving antenna which was mounted on the top of a variable height antenna tower.
- The table was rotated 360 degrees to determine the position of the highest radiation.
- The antenna is a broadband antenna and its height is varied between one meter and four meters above ground to find the maximum value of the field strength both horizontal polarization and vertical polarization of the antenna are set to make the measurement.
- For each suspected emission the EUT was arranged to its worst case and then tune the antenna tower (from 1 M to 4 M) and turn table (from 0 degree to 360 degrees) to find the maximum reading.
- Set the test-receiver system to Peak or CISPR quasi-peak Detect Function and specified bandwidth with Maximum Hold Mode.
- If the emission level of the EUT in peak mode was 3 dB lower than the limit specified, then testing will be stopped and peak values of EUT will be reported, otherwise, the emissions which do not have 3 dB margin will be repeated one by one using the quasi-peak method and reported.
- For testing above 1GHz, the emission level of the EUT in peak mode was 20dB lower than average limit (that means the emission level in peak mode also complies with the limit in average mode), then testing will be stopped and peak values of EUT will be reported, otherwise, the emissions will be measured in average mode again and reported.
- "Cone of radiation" has been considered to be 3dB bandwidth of the measurement antenna.



6.3 Typical Test Setup

Below 30MHz test setup

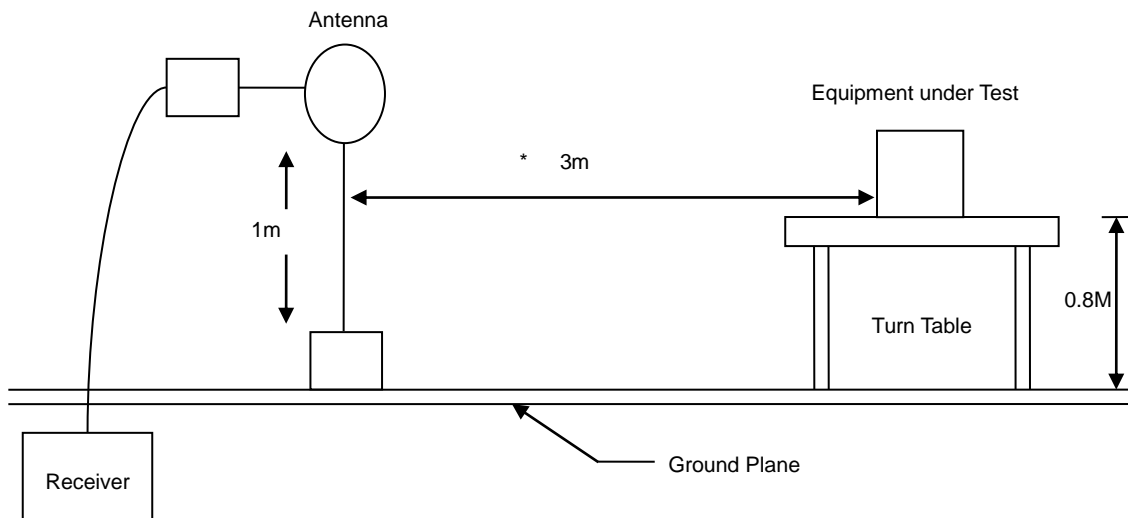

30MHz- 1GHz Test Setup

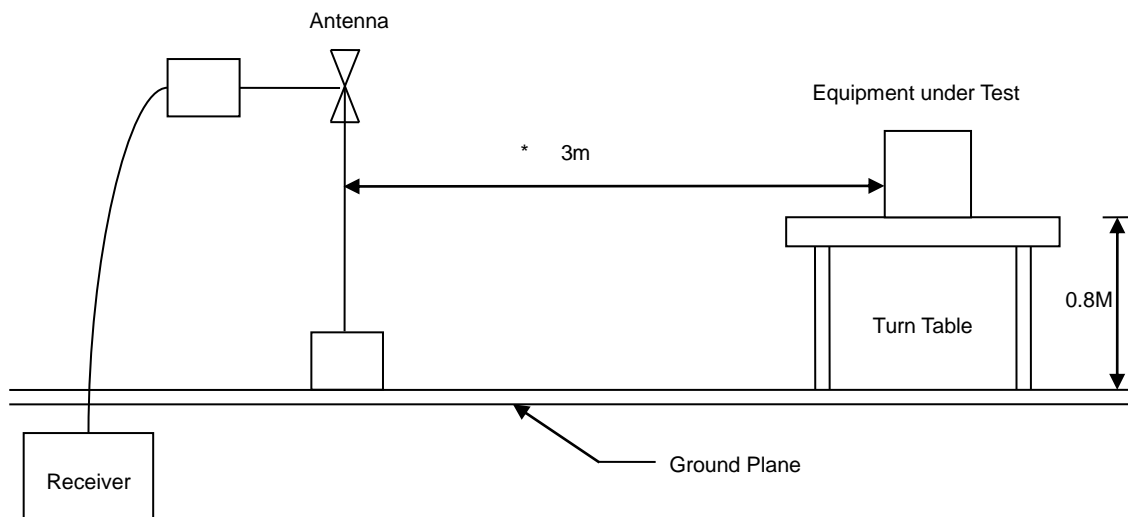

Above 1GHz Test Setup

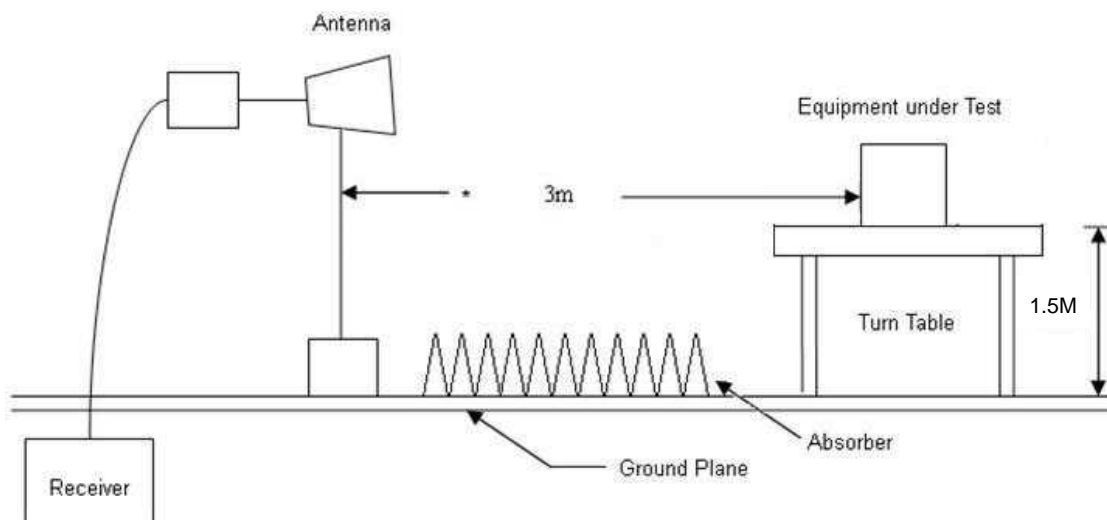



6.4 Test Result and Data (9KHz ~ 30MHz)

The 9kHz - 30MHz spurious emission is under limit 20dB more.

6.5 Test Result and Data (30MHz ~ 1GHz)

Power	: AC 120V / 60Hz	Pol/Phase	: VERTICAL
Test Mode	: Mode 3		:

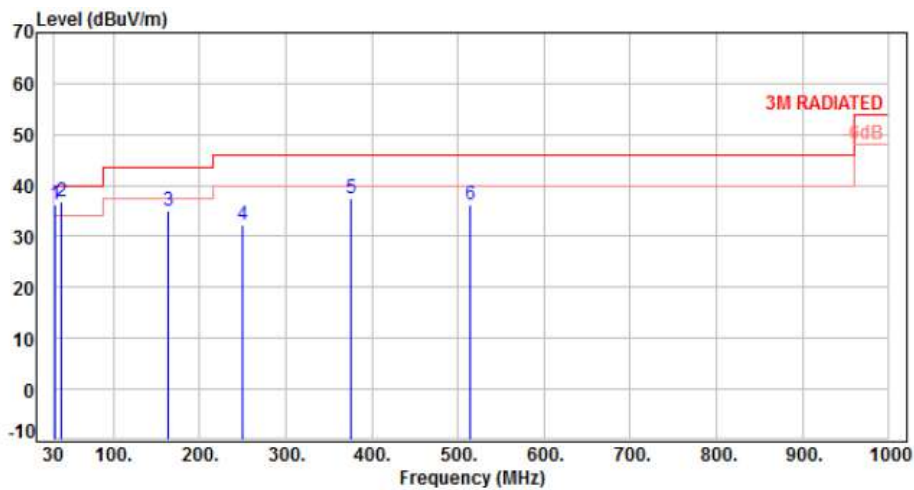

No.	Frequency (MHz)	Factor (dB)	Reading (dBuV)	Level (dBuV/m)	Limit (dBuV/m)	Margin (dB)	Detector	Height (cm)	Azimuth (deg)	P/F
1	31.94	-10.57	46.87	36.30	40.00	-3.70	Peak	400	0	P
2	39.70	-9.71	46.66	36.95	40.00	-3.05	Peak	400	0	P
3	162.89	-9.40	44.49	35.09	43.50	-8.41	Peak	400	0	P
4	250.19	-10.37	42.58	32.21	46.00	-13.79	Peak	400	0	P
5	375.32	-6.51	43.83	37.32	46.00	-8.68	Peak	400	0	P
6	514.03	-3.38	39.52	36.14	46.00	-9.86	Peak	400	0	P

Note: Level=Reading+Factor
Margin=Level-Limit
Factor=Antenna Factor + cable loss - Amplifier Factor



Power	: AC 120V / 60Hz	Pol/Phase	: HORIZONTAL
Test Mode	: Mode 3		:

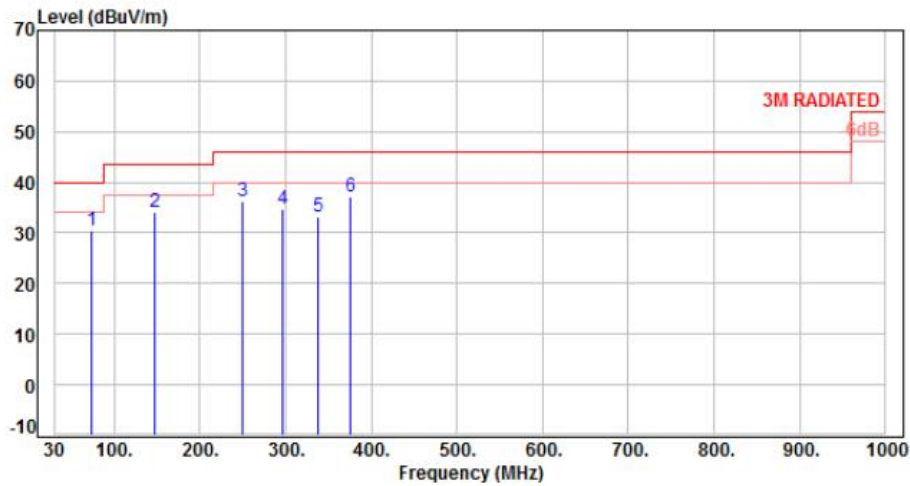

No.	Frequency (MHz)	Factor (dB)	Reading (dBuV)	Level (dBuV/m)	Limit (dBuV/m)	Margin (dB)	Detector	Height (cm)	Azimuth (deg)	P/F
1	73.65	-12.33	42.64	30.31	40.00	-9.69	Peak	100	0	P
2	147.37	-9.66	43.66	34.00	43.50	-9.50	Peak	100	0	P
3	250.19	-10.37	46.58	36.21	46.00	-9.79	Peak	100	0	P
4	296.75	-8.76	43.35	34.59	46.00	-11.41	Peak	100	0	P
5	337.49	-7.53	40.68	33.15	46.00	-12.85	Peak	100	0	P
6	375.32	-6.51	43.55	37.04	46.00	-8.96	Peak	100	0	P

Note: Level=Reading+Factor
 Margin=Level-Limit
 Factor=Antenna Factor + cable loss - Amplifier Factor



6.6 Test Result and Data (1GHz ~ 25GHz)

Power	: AC 120V / 60Hz	Pol/Phase	: VERTICAL
Test Mode	: Mode 1, CH01		:

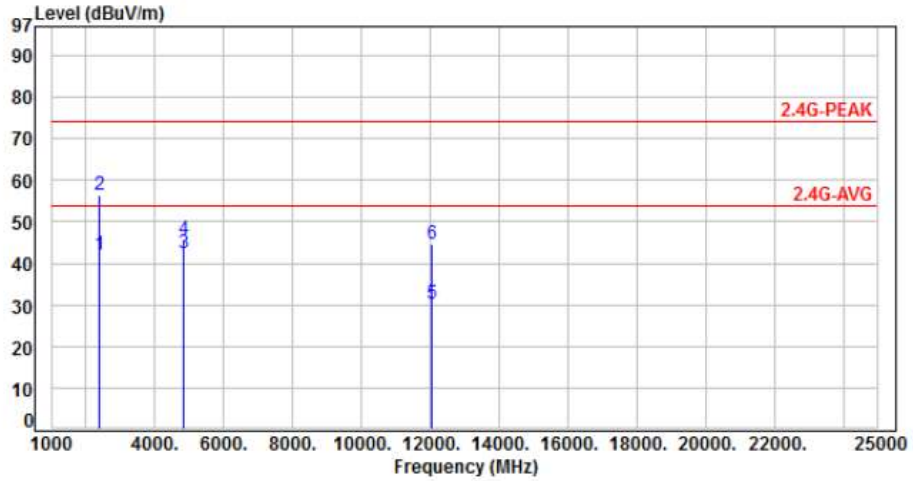

No.	Frequency (MHz)	Factor (dB)	Reading (dBuV)	Level (dBuV/m)	Limit (dBuV/m)	Margin (dB)	Detector	Height (cm)	Azimuth (deg)	P/F
1	2390.00	-14.61	56.73	42.12	54.00	-11.88	Average	100	115	P
2	2390.00	-14.61	70.91	56.30	74.00	-17.70	Peak	100	115	P
3	4824.00	-6.82	49.06	42.24	54.00	-11.76	Average	100	202	P
4	4824.00	-6.82	52.71	45.89	74.00	-28.11	Peak	100	202	P
5	12060.00	4.61	25.52	30.13	54.00	-23.87	Average	100	335	P
6	12060.00	4.61	39.92	44.53	74.00	-29.47	Peak	100	335	P

Note: Level=Reading+Factor
Margin=Level-Limit
Factor=Antenna Factor + cable loss - Amplifier Factor



Power	: AC 120V / 60Hz	Pol/Phase	: HORIZONTAL
Test Mode	: Mode 1, CH01		:

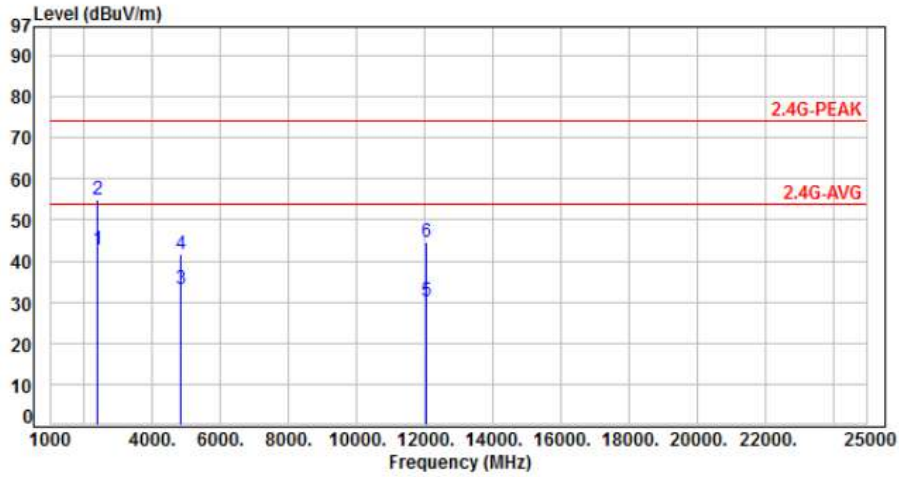

No.	Frequency (MHz)	Factor (dB)	Reading (dBuV)	Level (dBuV/m)	Limit (dBuV/m)	Margin (dB)	Detector	Height (cm)	Azimuth (deg)	P/F
1	2390.00	-14.61	57.42	42.81	54.00	-11.19	Average	100	360	P
2	2390.00	-14.61	69.48	54.87	74.00	-19.13	Peak	100	360	P
3	4824.00	-6.82	40.12	33.30	54.00	-20.70	Average	100	232	P
4	4824.00	-6.82	48.47	41.65	74.00	-32.35	Peak	100	232	P
5	12060.00	4.61	25.59	30.20	54.00	-23.80	Average	100	150	P
6	12060.00	4.61	39.84	44.45	74.00	-29.55	Peak	100	150	P

Note: Level=Reading+Factor
 Margin=Level-Limit
 Factor=Antenna Factor + cable loss - Amplifier Factor



Power	: AC 120V / 60Hz	Pol/Phase	: VERTICAL
Test Mode	: Mode 1, CH06		:

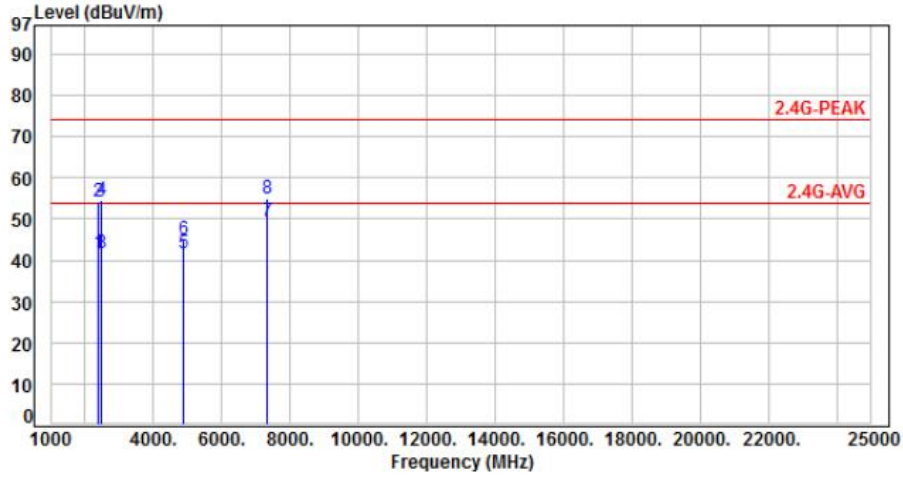

No.	Frequency (MHz)	Factor (dB)	Reading (dBuV)	Level (dBuV/m)	Limit (dBuV/m)	Margin (dB)	Detector	Height (cm)	Azimuth (deg)	P/F
1	2390.00	-14.61	56.35	41.74	54.00	-12.26	Average	100	110	P
2	2390.00	-14.61	68.94	54.33	74.00	-19.67	Peak	100	110	P
3	2483.50	-14.22	55.99	41.77	54.00	-12.23	Average	100	110	P
4	2483.50	-14.22	68.79	54.57	74.00	-19.43	Peak	100	110	P
5	4874.00	-6.63	48.23	41.60	54.00	-12.40	Average	100	122	P
6	4874.00	-6.63	51.78	45.15	74.00	-28.85	Peak	100	122	P
7	7311.00	-1.28	50.59	49.31	54.00	-4.69	Average	265	205	P
8	7311.00	-1.28	56.41	55.13	74.00	-18.87	Peak	265	205	P

Note: Level=Reading+Factor
 Margin=Level-Limit
 Factor=Antenna Factor + cable loss - Amplifier Factor



Power	: AC 120V / 60Hz	Pol/Phase	: HORIZONTAL
Test Mode	: Mode 1, CH06		:

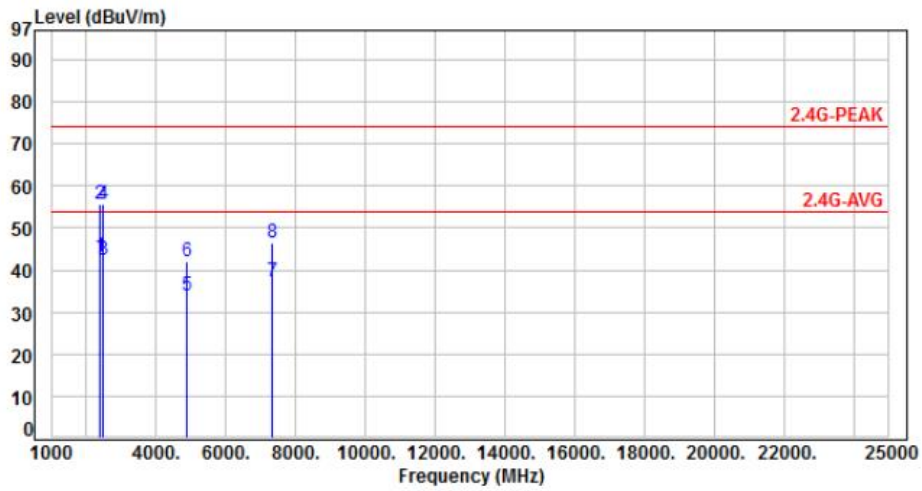

No.	Frequency (MHz)	Factor (dB)	Reading (dBuV)	Level (dBuV/m)	Limit (dBuV/m)	Margin (dB)	Detector	Height (cm)	Azimuth (deg)	P/F
1	2390.00	-14.61	57.71	43.10	54.00	-10.90	Average	100	245	P
2	2390.00	-14.61	70.21	55.60	74.00	-18.40	Peak	100	245	P
3	2483.50	-14.22	56.67	42.45	54.00	-11.55	Average	100	245	P
4	2483.50	-14.22	69.93	55.71	74.00	-18.29	Peak	100	245	P
5	4874.00	-6.63	40.42	33.79	54.00	-20.21	Average	100	250	P
6	4874.00	-6.63	48.83	42.20	74.00	-31.80	Peak	100	250	P
7	7311.00	-1.28	38.62	37.34	54.00	-16.66	Average	270	360	P
8	7311.00	-1.28	47.70	46.42	74.00	-27.58	Peak	270	360	P

Note: Level=Reading+Factor
 Margin=Level-Limit
 Factor=Antenna Factor + cable loss - Amplifier Factor



Power	: AC 120V / 60Hz	Pol/Phase	: VERTICAL
Test Mode	: Mode 1, CH11		:

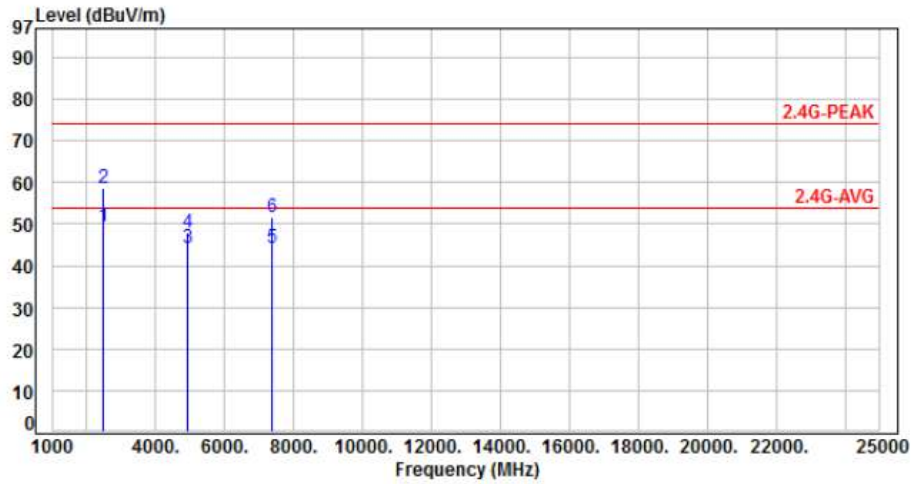

No.	Frequency (MHz)	Factor (dB)	Reading (dBuV)	Level (dBuV/m)	Limit (dBuV/m)	Margin (dB)	Detector	Height (cm)	Azimuth (deg)	P/F
1	2483.50	-14.22	63.65	49.43	54.00	-4.57	Average	100	110	P
2	2483.50	-14.22	72.90	58.68	74.00	-15.32	Peak	100	110	P
3	4924.00	-6.50	50.92	44.42	54.00	-9.58	Average	100	150	P
4	4924.00	-6.50	54.56	48.06	74.00	-25.94	Peak	100	150	P
5	7386.00	-1.19	45.37	44.18	54.00	-9.82	Average	100	210	P
6	7386.00	-1.19	52.75	51.56	74.00	-22.44	Peak	100	210	P

Note: Level=Reading+Factor
Margin=Level-Limit
Factor=Antenna Factor + cable loss - Amplifier Factor



Power	: AC 120V / 60Hz	Pol/Phase	: HORIZONTAL
Test Mode	: Mode 1, CH11		:

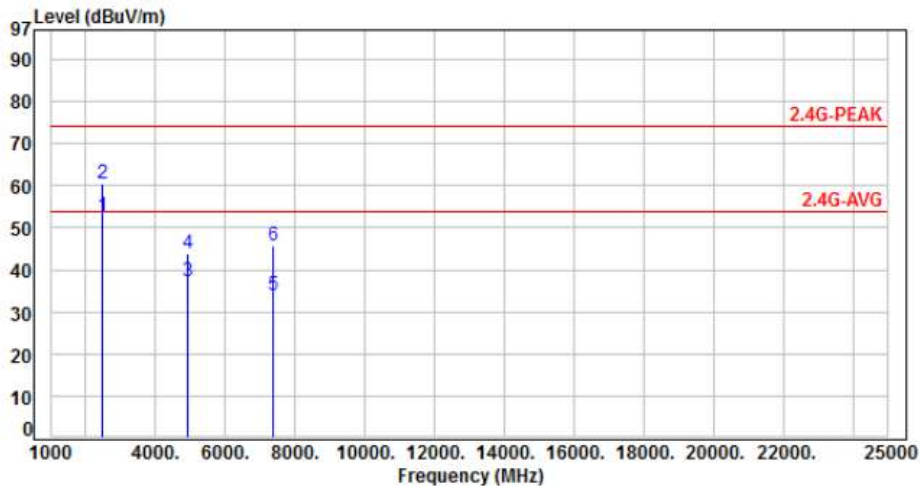

No.	Frequency (MHz)	Factor (dB)	Reading (dBUV)	Level (dBUV/m)	Limit (dBUV/m)	Margin (dB)	Detector	Height (cm)	Azimuth (deg)	P/F
1	2483.50	-14.22	66.92	52.70	54.00	-1.30	Average	100	290	P
2	2483.50	-14.22	74.74	60.52	74.00	-13.48	Peak	100	290	P
3	4924.00	-6.50	43.87	37.37	54.00	-16.63	Average	100	308	P
4	4924.00	-6.50	50.43	43.93	74.00	-30.07	Peak	100	308	P
5	7386.00	-1.19	35.19	34.00	54.00	-20.00	Average	100	78	P
6	7386.00	-1.19	46.76	45.57	74.00	-28.43	Peak	100	78	P

Note: Level=Reading+Factor
 Margin=Level-Limit
 Factor=Antenna Factor + cable loss - Amplifier Factor



Power	: AC 120V / 60Hz	Pol/Phase	: VERTICAL
Test Mode	: Mode 2, CH01		:

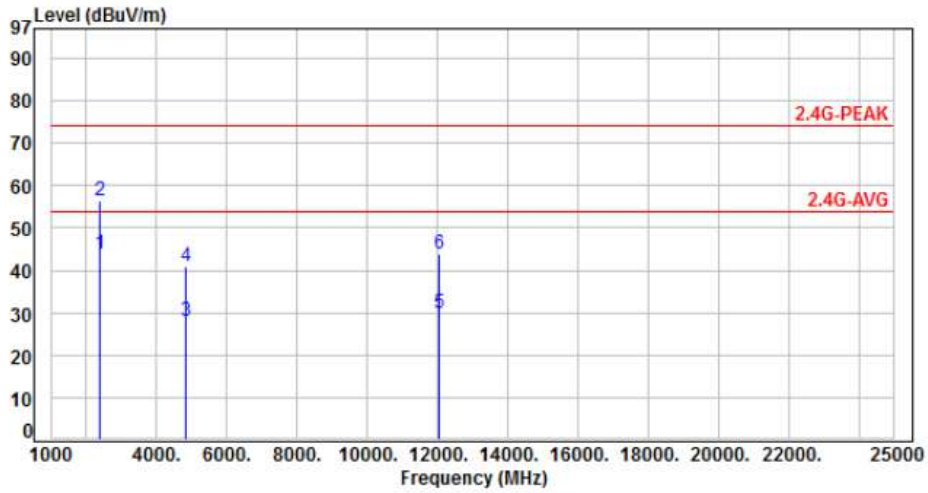

No.	Frequency (MHz)	Factor (dB)	Reading (dBuV)	Level (dBuV/m)	Limit (dBuV/m)	Margin (dB)	Detector	Height (cm)	Azimuth (deg)	P/F
1	2390.00	-14.61	58.53	43.92	54.00	-10.08	Average	100	110	P
2	2390.00	-14.61	71.12	56.51	74.00	-17.49	Peak	100	110	P
3	4824.00	-6.82	35.02	28.20	54.00	-25.80	Average	390	200	P
4	4824.00	-6.82	47.85	41.03	74.00	-32.97	Peak	390	200	P
5	12060.00	4.61	25.41	30.02	54.00	-23.98	Average	100	360	P
6	12060.00	4.61	39.10	43.71	74.00	-30.29	Peak	100	360	P

Note: Level=Reading+Factor
 Margin=Level-Limit
 Factor=Antenna Factor + cable loss - Amplifier Factor



Power	: AC 120V / 60Hz	Pol/Phase	: HORIZONTAL
Test Mode	: Mode 2, CH01		:

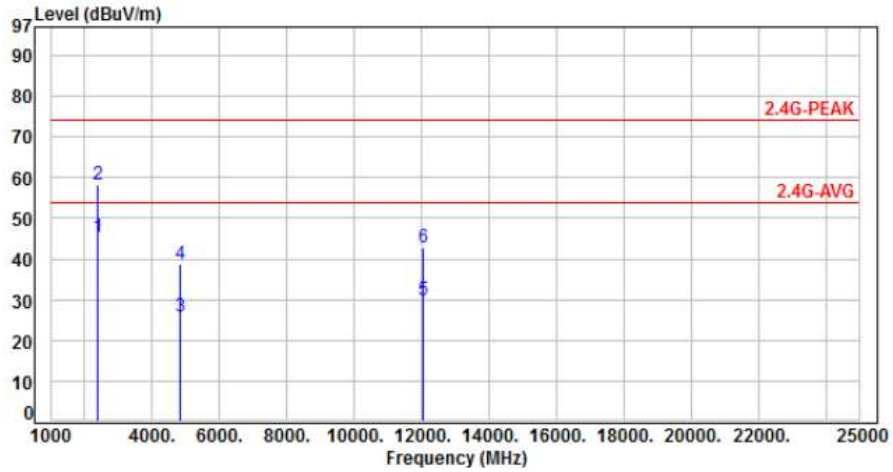

No.	Frequency (MHz)	Factor (dB)	Reading (dBuV)	Level (dBuV/m)	Limit (dBuV/m)	Margin (dB)	Detector	Height (cm)	Azimuth (deg)	P/F
1	2390.00	-14.61	60.16	45.55	54.00	-8.45	Average	100	290	P
2	2390.00	-14.61	72.91	58.30	74.00	-15.70	Peak	100	290	P
3	4824.00	-6.82	32.71	25.89	54.00	-28.11	Average	100	130	P
4	4824.00	-6.82	45.61	38.79	74.00	-35.21	Peak	100	130	P
5	12060.00	4.61	25.15	29.76	54.00	-24.24	Average	100	175	P
6	12060.00	4.61	38.21	42.82	74.00	-31.18	Peak	100	175	P

Note: Level=Reading+Factor
 Margin=Level-Limit
 Factor=Antenna Factor + cable loss - Amplifier Factor



Power	: AC 120V / 60Hz	Pol/Phase	: VERTICAL
Test Mode	: Mode 2, CH06		:

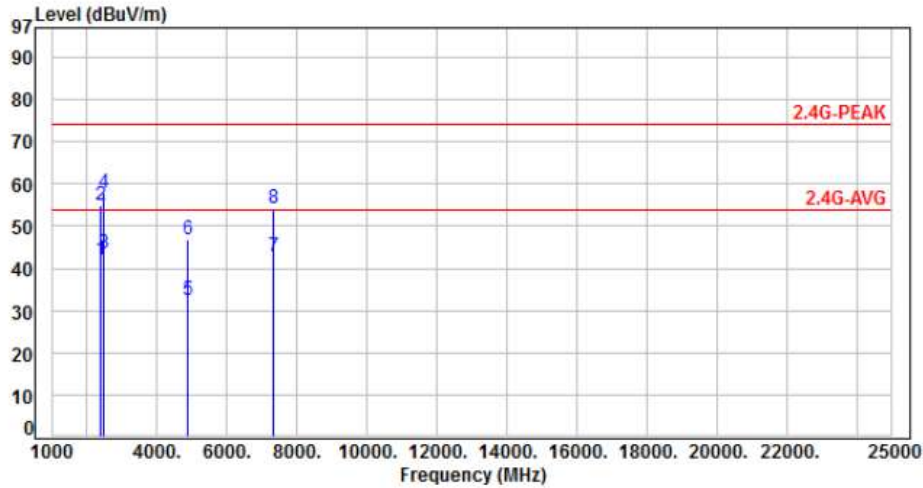

No.	Frequency (MHz)	Factor (dB)	Reading (dBuV)	Level (dBuV/m)	Limit (dBuV/m)	Margin (dB)	Detector	Height (cm)	Azimuth (deg)	P/F
1	2390.00	-14.61	56.51	41.90	54.00	-12.10	Average	100	110	P
2	2390.00	-14.61	69.51	54.90	74.00	-19.10	Peak	100	110	P
3	2483.50	-14.22	57.91	43.69	54.00	-10.31	Average	100	202	P
4	2483.50	-14.22	71.95	57.73	74.00	-16.27	Peak	100	202	P
5	4874.00	-6.63	39.09	32.46	54.00	-21.54	Average	100	195	P
6	4874.00	-6.63	53.41	46.78	74.00	-27.22	Peak	100	195	P
7	7311.00	-1.28	43.88	42.60	54.00	-11.40	Average	100	202	P
8	7311.00	-1.28	55.63	54.35	74.00	-19.65	Peak	100	202	P

Note: Level=Reading+Factor
 Margin=Level-Limit
 Factor=Antenna Factor + cable loss - Amplifier Factor



Power	: AC 120V / 60Hz	Pol/Phase	: HORIZONTAL
Test Mode	: Mode 2, CH06		:

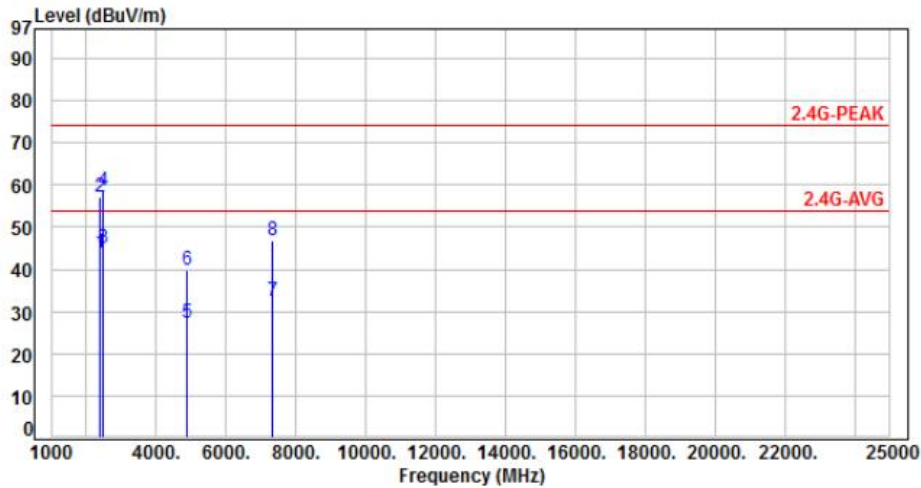

No.	Frequency (MHz)	Factor (dB)	Reading (dBuV)	Level (dBuV/m)	Limit (dBuV/m)	Margin (dB)	Detector	Height (cm)	Azimuth (deg)	P/F
1	2390.00	-14.61	58.39	43.78	54.00	-10.22	Average	100	315	P
2	2390.00	-14.61	71.69	57.08	74.00	-16.92	Peak	100	315	P
3	2483.50	-14.22	59.37	45.15	54.00	-8.85	Average	100	315	P
4	2483.50	-14.22	72.84	58.62	74.00	-15.38	Peak	100	315	P
5	4874.00	-6.63	33.92	27.29	54.00	-26.71	Average	100	119	P
6	4874.00	-6.63	46.45	39.82	74.00	-34.18	Peak	100	119	P
7	7311.00	-1.28	33.71	32.43	54.00	-21.57	Average	100	360	P
8	7311.00	-1.28	48.05	46.77	74.00	-27.23	Peak	100	360	P

Note: Level=Reading+Factor
 Margin=Level-Limit
 Factor=Antenna Factor + cable loss - Amplifier Factor



Power	: AC 120V / 60Hz	Pol/Phase	: VERTICAL
Test Mode	: Mode 2, CH11		:

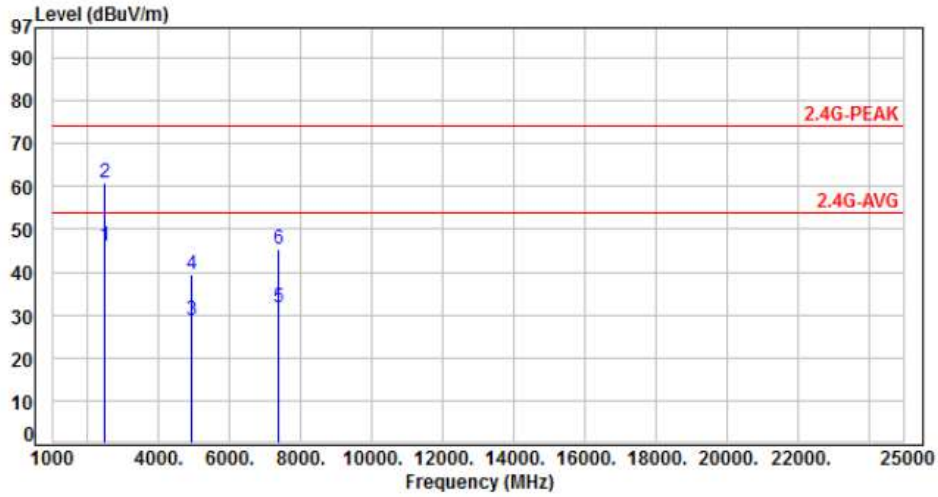

No.	Frequency (MHz)	Factor (dB)	Reading (dBuV)	Level (dBuV/m)	Limit (dBuV/m)	Margin (dB)	Detector	Height (cm)	Azimuth (deg)	P/F
1	2483.50	-14.22	60.26	46.04	54.00	-7.96	Average	100	208	P
2	2483.50	-14.22	75.13	60.91	74.00	-13.09	Peak	100	208	P
3	4924.00	-6.50	35.22	28.72	54.00	-25.28	Average	395	195	P
4	4924.00	-6.50	46.09	39.59	74.00	-34.41	Peak	395	195	P
5	7386.00	-1.19	32.74	31.55	54.00	-22.45	Average	100	205	P
6	7386.00	-1.19	46.49	45.30	74.00	-28.70	Peak	100	205	P

Note: Level=Reading+Factor
 Margin=Level-Limit
 Factor=Antenna Factor + cable loss - Amplifier Factor



Power	: AC 120V / 60Hz	Pol/Phase	: HORIZONTAL
Test Mode	: Mode 2, CH11		:

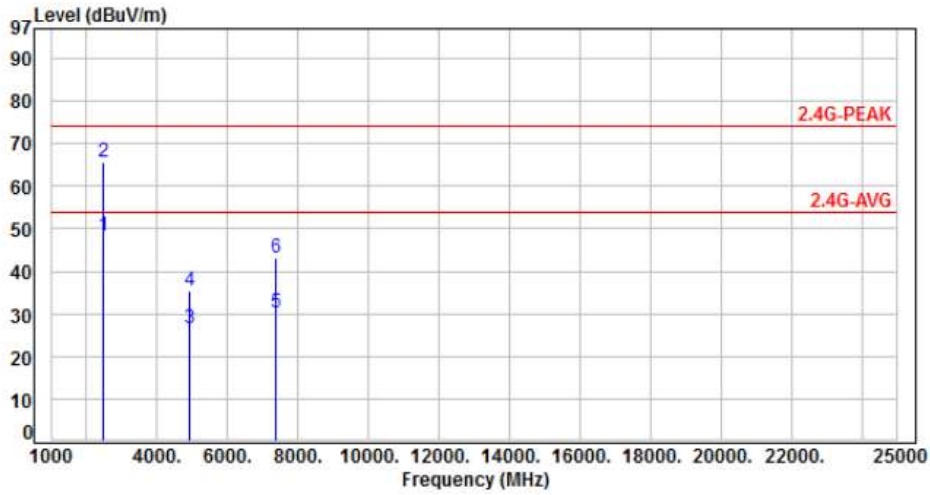

No.	Frequency (MHz)	Factor (dB)	Reading (dBuV)	Level (dBuV/m)	Limit (dBuV/m)	Margin (dB)	Detector	Height (cm)	Azimuth (deg)	P/F
1	2483.50	-14.22	62.56	48.34	54.00	-5.66	Average	100	240	P
2	2483.50	-14.22	79.73	65.51	74.00	-8.49	Peak	100	240	P
3	4924.00	-6.50	33.02	26.52	54.00	-27.48	Average	100	180	P
4	4924.00	-6.50	41.95	35.45	74.00	-38.55	Peak	100	180	P
5	7386.00	-1.19	31.43	30.24	54.00	-23.76	Average	100	255	P
6	7386.00	-1.19	44.50	43.31	74.00	-30.69	Peak	100	255	P

Note: Level=Reading+Factor
 Margin=Level-Limit
 Factor=Antenna Factor + cable loss - Amplifier Factor



Power	: AC 120V / 60Hz	Pol/Phase	: VERTICAL
Test Mode	: Mode 3, CH01		:

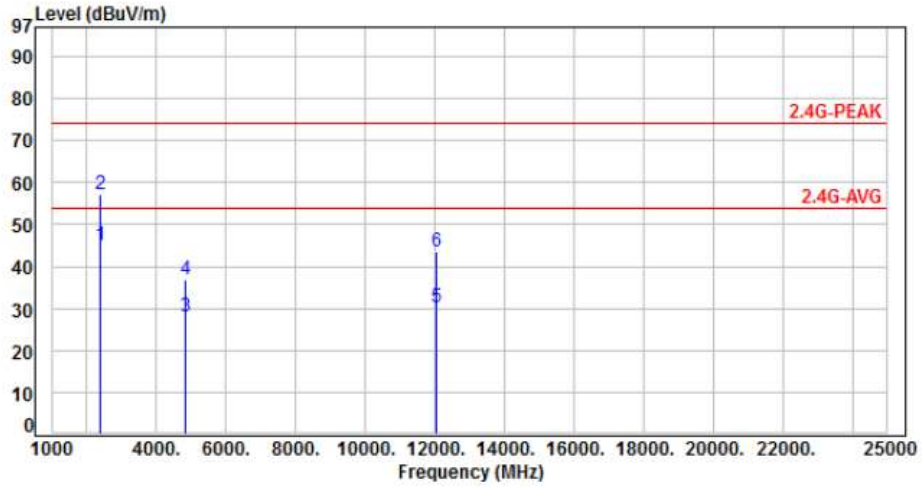

No.	Frequency (MHz)	Factor (dB)	Reading (dBuV)	Level (dBuV/m)	Limit (dBuV/m)	Margin (dB)	Detector	Height (cm)	Azimuth (deg)	P/F
1	2390.00	-14.61	59.42	44.81	54.00	-9.19	Average	100	125	P
2	2390.00	-14.61	71.80	57.19	74.00	-16.81	Peak	100	125	P
3	4824.00	-6.82	34.81	27.99	54.00	-26.01	Average	100	190	P
4	4824.00	-6.82	43.52	36.70	74.00	-37.30	Peak	100	190	P
5	12060.00	4.61	25.73	30.34	54.00	-23.66	Average	100	205	P
6	12060.00	4.61	38.88	43.49	74.00	-30.51	Peak	100	205	P

Note: Level=Reading+Factor
 Margin=Level-Limit
 Factor=Antenna Factor + cable loss - Amplifier Factor



Power	: AC 120V / 60Hz	Pol/Phase	: HORIZONTAL
Test Mode	: Mode 3, CH01		:

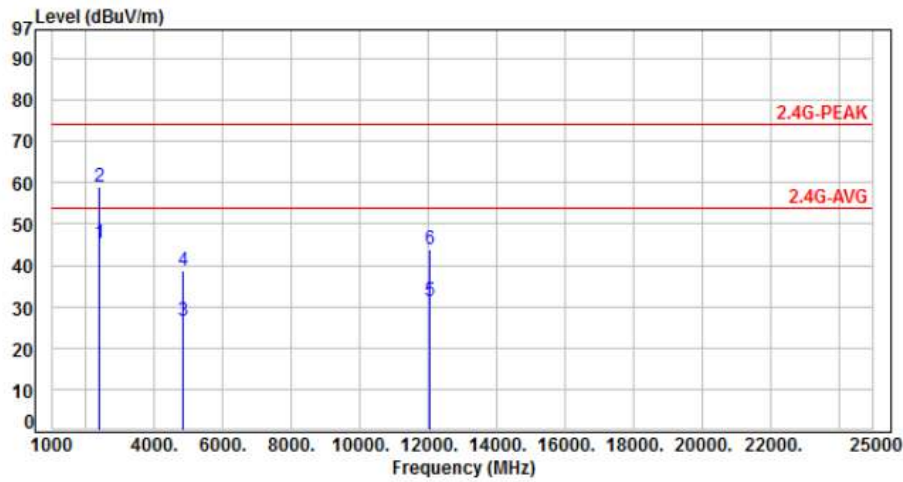

No.	Frequency (MHz)	Factor (dB)	Reading (dBuV)	Level (dBuV/m)	Limit (dBuV/m)	Margin (dB)	Detector	Height (cm)	Azimuth (deg)	P/F
1	2390.00	-14.61	59.85	45.24	54.00	-8.76	Average	100	355	P
2	2390.00	-14.61	73.67	59.06	74.00	-14.94	Peak	100	355	P
3	4824.00	-6.82	33.54	26.72	54.00	-27.28	Average	100	150	P
4	4824.00	-6.82	45.45	38.63	74.00	-35.37	Peak	100	150	P
5	12060.00	4.61	26.86	31.47	54.00	-22.53	Average	100	100	P
6	12060.00	4.61	39.10	43.71	74.00	-30.29	Peak	100	100	P

Note: Level=Reading+Factor
 Margin=Level-Limit
 Factor=Antenna Factor + cable loss - Amplifier Factor



Power	: AC 120V / 60Hz	Pol/Phase	: VERTICAL
Test Mode	: Mode 3, CH06		:

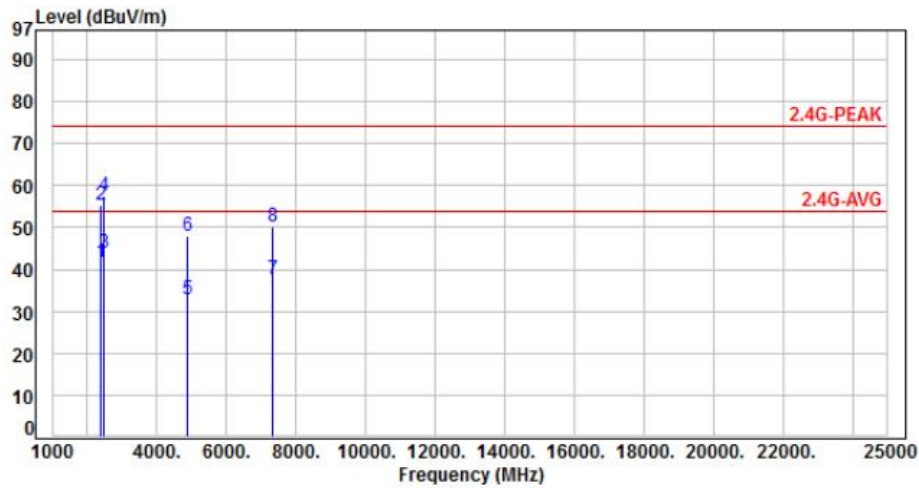

No.	Frequency (MHz)	Factor (dB)	Reading (dBuV)	Level (dBuV/m)	Limit (dBuV/m)	Margin (dB)	Detector	Height (cm)	Azimuth (deg)	P/F
1	2390.00	-14.61	56.42	41.81	54.00	-12.19	Average	160	165	P
2	2390.00	-14.61	70.01	55.40	74.00	-18.60	Peak	160	165	P
3	2483.50	-14.22	57.99	43.77	54.00	-10.23	Average	160	165	P
4	2483.50	-14.22	71.77	57.55	74.00	-16.45	Peak	160	165	P
5	4874.00	-6.63	39.54	32.91	54.00	-21.09	Average	100	137	P
6	4874.00	-6.63	54.45	47.82	74.00	-26.18	Peak	100	137	P
7	7311.00	-1.28	38.91	37.63	54.00	-16.37	Average	100	200	P
8	7311.00	-1.28	51.49	50.21	74.00	-23.79	Peak	100	200	P

Note: Level=Reading+Factor
 Margin=Level-Limit
 Factor=Antenna Factor + cable loss - Amplifier Factor



Power	: AC 120V / 60Hz	Pol/Phase	: HORIZONTAL
Test Mode	: Mode 3, CH06		:

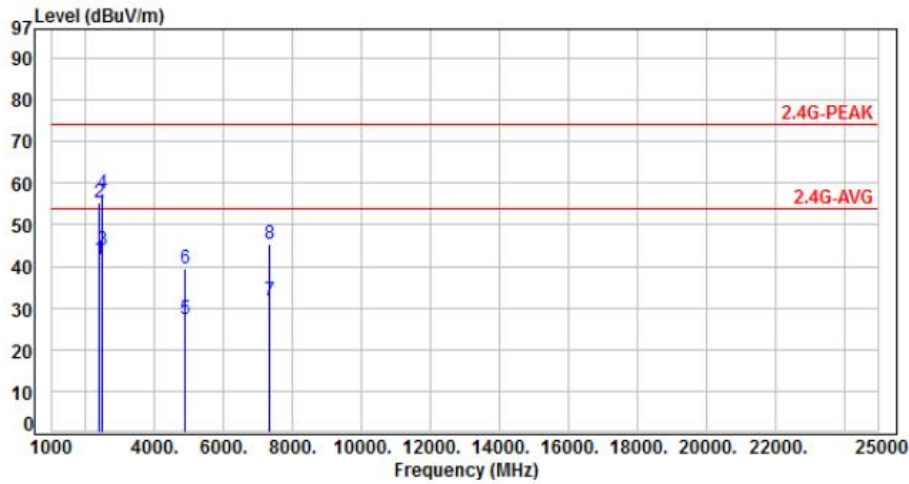

No.	Frequency (MHz)	Factor (dB)	Reading (dBUV)	Level (dBUV/m)	Limit (dBUV/m)	Margin (dB)	Detector	Height (cm)	Azimuth (deg)	P/F
1	2390.00	-14.61	56.42	41.81	54.00	-12.19	Average	160	165	P
2	2390.00	-14.61	70.01	55.40	74.00	-18.60	Peak	160	165	P
3	2483.50	-14.22	57.99	43.77	54.00	-10.23	Average	160	165	P
4	2483.50	-14.22	71.77	57.55	74.00	-16.45	Peak	160	165	P
5	4874.00	-6.63	33.80	27.17	54.00	-26.83	Average	100	30	P
6	4874.00	-6.63	46.00	39.37	74.00	-34.63	Peak	100	30	P
7	7311.00	-1.28	33.05	31.77	54.00	-22.23	Average	100	360	P
8	7311.00	-1.28	46.77	45.49	74.00	-28.51	Peak	100	360	P

Note: Level=Reading+Factor
 Margin=Level-Limit
 Factor=Antenna Factor + cable loss - Amplifier Factor



Power	: AC 120V / 60Hz	Pol/Phase	: VERTICAL
Test Mode	: Mode 2, CH11		:

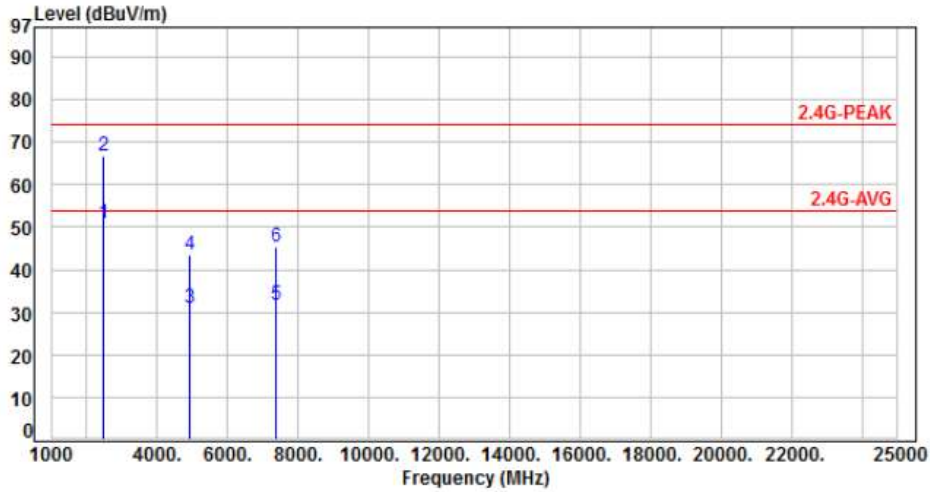

No.	Frequency (MHz)	Factor (dB)	Reading (dBuV)	Level (dBuV/m)	Limit (dBuV/m)	Margin (dB)	Detector	Height (cm)	Azimuth (deg)	P/F
1	2483.50	-14.22	65.10	50.88	54.00	-3.12	Average	100	180	P
2	2483.50	-14.22	80.86	66.64	74.00	-7.36	Peak	100	180	P
3	4924.00	-6.50	37.54	31.04	54.00	-22.96	Average	100	205	P
4	4924.00	-6.50	50.09	43.59	74.00	-30.41	Peak	100	205	P
5	7386.00	-1.19	33.05	31.86	54.00	-22.14	Average	100	100	P
6	7386.00	-1.19	46.40	45.21	74.00	-28.79	Peak	100	100	P

Note: Level=Reading+Factor
 Margin=Level-Limit
 Factor=Antenna Factor + cable loss - Amplifier Factor



Power	: AC 120V / 60Hz	Pol/Phase	: HORIZONTAL
Test Mode	: Mode 2, CH11		:

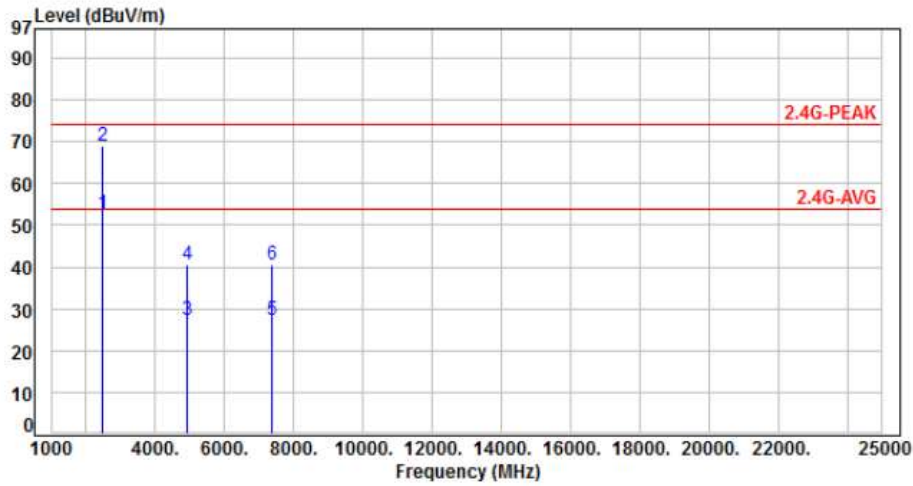

No.	Frequency (MHz)	Factor (dB)	Reading (dBuV)	Level (dBuV/m)	Limit (dBuV/m)	Margin (dB)	Detector	Height (cm)	Azimuth (deg)	P/F
1	2483.50	-14.22	67.01	52.79	54.00	-1.21	Average	100	15	P
2	2483.50	-14.22	83.21	68.99	74.00	-5.01	Peak	100	15	P
3	4924.00	-6.50	33.85	27.35	54.00	-26.65	Average	100	280	P
4	4924.00	-6.50	47.15	40.65	74.00	-33.35	Peak	100	280	P
5	7386.00	-1.19	28.33	27.14	54.00	-26.86	Average	100	50	P
6	7386.00	-1.19	41.70	40.51	74.00	-33.49	Peak	100	50	P

Note: Level=Reading+Factor
 Margin=Level-Limit
 Factor=Antenna Factor + cable loss - Amplifier Factor



Power	: AC 120V / 60Hz	Pol/Phase	: VERTICAL
Test Mode	: Mode 4, CH03		:

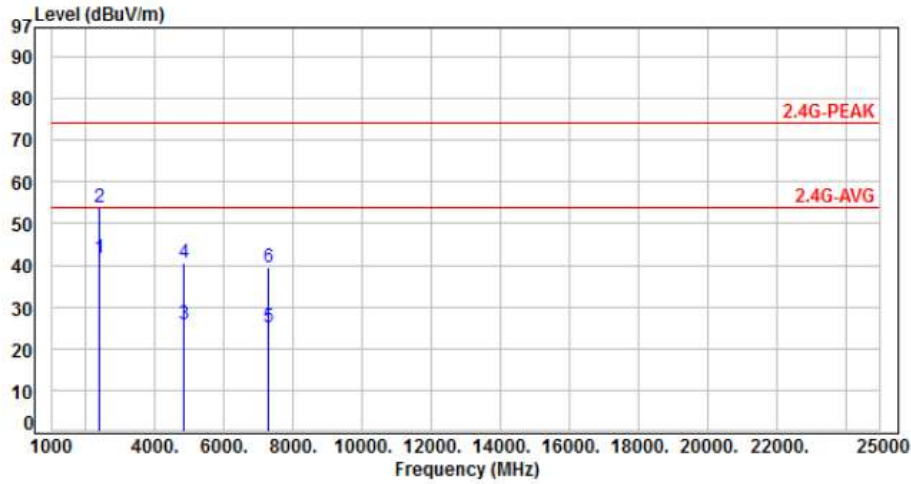

No.	Frequency (MHz)	Factor (dB)	Reading (dBuV)	Level (dBuV/m)	Limit (dBuV/m)	Margin (dB)	Detector	Height (cm)	Azimuth (deg)	P/F
1	2390.00	-14.61	56.28	41.67	54.00	-12.33	Average	105	180	P
2	2390.00	-14.61	68.60	53.99	74.00	-20.01	Peak	105	180	P
3	4844.00	-6.72	32.37	25.65	54.00	-28.35	Average	100	115	P
4	4844.00	-6.72	47.45	40.73	74.00	-33.27	Peak	100	115	P
5	7266.00	-1.49	26.65	25.16	54.00	-28.84	Average	100	135	P
6	7266.00	-1.49	40.87	39.38	74.00	-34.62	Peak	100	135	P

Note: Level=Reading+Factor
 Margin=Level-Limit
 Factor=Antenna Factor + cable loss - Amplifier Factor



Power	: AC 120V / 60Hz	Pol/Phase	: HORIZONTAL
Test Mode	: Mode 4, CH03		:

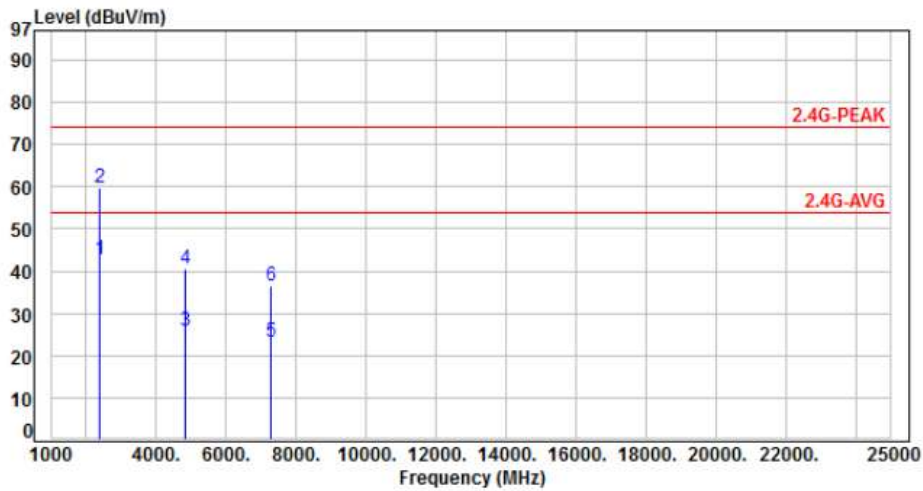

No.	Frequency (MHz)	Factor (dB)	Reading (dBuV)	Level (dBuV/m)	Limit (dBuV/m)	Margin (dB)	Detector	Height (cm)	Azimuth (deg)	P/F
1	2390.00	-14.61	57.53	42.92	54.00	-11.08	Average	100	320	P
2	2390.00	-14.61	74.19	59.58	74.00	-14.42	Peak	100	320	P
3	4844.00	-6.72	32.58	25.86	54.00	-28.14	Average	100	190	P
4	4844.00	-6.72	47.12	40.40	74.00	-33.60	Peak	100	190	P
5	7266.00	-1.49	24.58	23.09	54.00	-30.91	Average	100	250	P
6	7266.00	-1.49	38.13	36.64	74.00	-37.36	Peak	100	250	P

Note: Level=Reading+Factor
 Margin=Level-Limit
 Factor=Antenna Factor + cable loss - Amplifier Factor



Power	: AC 120V / 60Hz	Pol/Phase	: VERTICAL
Test Mode	: Mode 4, CH06		:

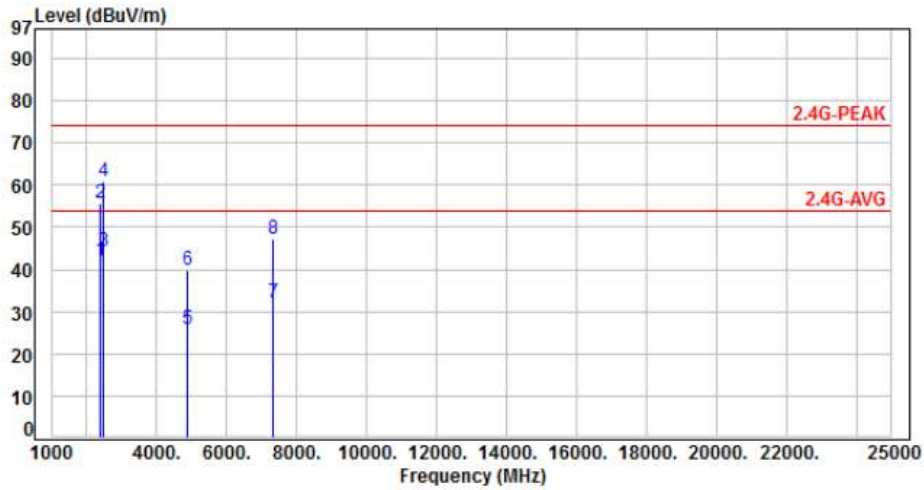

No.	Frequency (MHz)	Factor (dB)	Reading (dBuV)	Level (dBuV/m)	Limit (dBuV/m)	Margin (dB)	Detector	Height (cm)	Azimuth (deg)	P/F
1	2390.00	-14.61	56.53	41.92	54.00	-12.08	Average	100	175	P
2	2390.00	-14.61	70.14	55.53	74.00	-18.47	Peak	100	175	P
3	2483.50	-14.22	58.46	44.24	54.00	-9.76	Average	100	175	P
4	2483.50	-14.22	75.05	60.83	74.00	-13.17	Peak	100	175	P
5	4874.00	-6.63	32.61	25.98	54.00	-28.02	Average	100	145	P
6	4874.00	-6.63	46.34	39.71	74.00	-34.29	Peak	100	145	P
7	7311.00	-1.28	33.42	32.14	54.00	-21.86	Average	100	210	P
8	7311.00	-1.28	48.47	47.19	74.00	-26.81	Peak	100	210	P

Note: Level=Reading+Factor
 Margin=Level-Limit
 Factor=Antenna Factor + cable loss - Amplifier Factor



Power	: AC 120V / 60Hz	Pol/Phase	: HORIZONTAL
Test Mode	: Mode 4, CH06		:

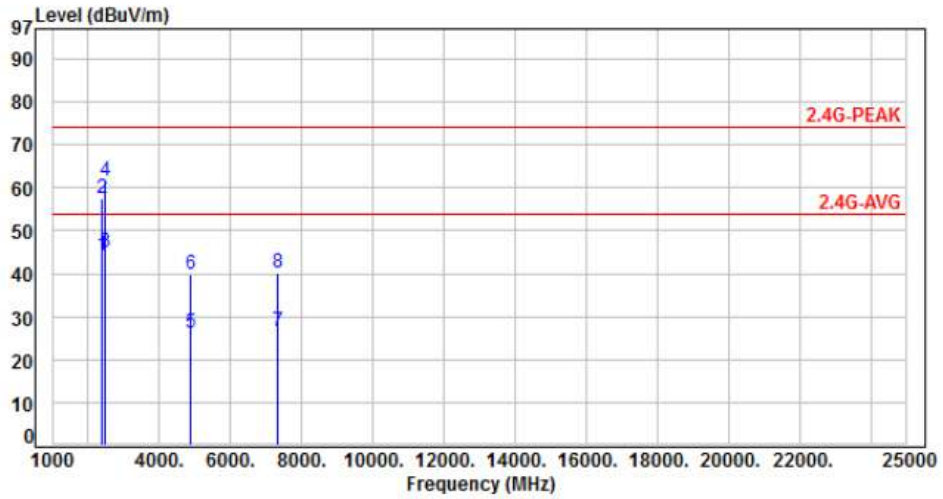

No.	Frequency (MHz)	Factor (dB)	Reading (dBUV)	Level (dBUV/m)	Limit (dBUV/m)	Margin (dB)	Detector	Height (cm)	Azimuth (deg)	P/F
1	2390.00	-14.61	58.71	44.10	54.00	-9.90	Average	100	360	P
2	2390.00	-14.61	72.10	57.49	74.00	-16.51	Peak	100	360	P
3	2483.50	-14.22	59.36	45.14	54.00	-8.86	Average	100	360	P
4	2483.50	-14.22	75.87	61.65	74.00	-12.35	Peak	100	360	P
5	4874.00	-6.63	32.74	26.11	54.00	-27.89	Average	100	135	P
6	4874.00	-6.63	46.62	39.99	74.00	-34.01	Peak	100	135	P
7	7311.00	-1.28	27.78	26.50	54.00	-27.50	Average	100	160	P
8	7311.00	-1.28	41.44	40.16	74.00	-33.84	Peak	100	160	P

Note: Level=Reading+Factor
 Margin=Level-Limit
 Factor=Antenna Factor + cable loss - Amplifier Factor



Power	: AC 120V / 60Hz	Pol/Phase	: VERTICAL
Test Mode	: Mode 4, CH09		:

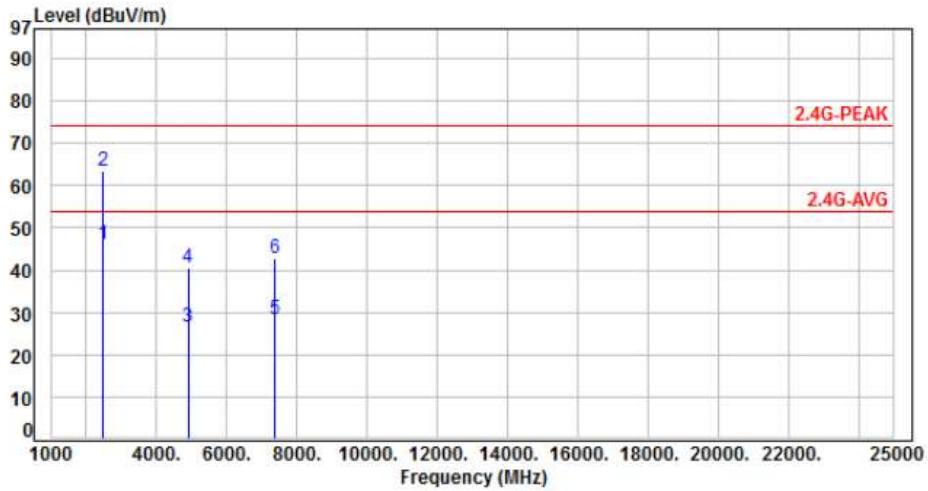

No.	Frequency (MHz)	Factor (dB)	Reading (dBuV)	Level (dBuV/m)	Limit (dBuV/m)	Margin (dB)	Detector	Height (cm)	Azimuth (deg)	P/F
1	2483.50	-14.22	60.30	46.08	54.00	-7.92	Average	100	195	P
2	2483.50	-14.22	77.52	63.30	74.00	-10.70	Peak	100	195	P
3	4904.00	-6.55	33.05	26.50	54.00	-27.50	Average	100	30	P
4	4904.00	-6.55	47.17	40.62	74.00	-33.38	Peak	100	30	P
5	7356.00	-1.26	29.74	28.48	54.00	-25.52	Average	100	85	P
6	7356.00	-1.26	44.12	42.86	74.00	-31.14	Peak	100	85	P

Note: Level=Reading+Factor
 Margin=Level-Limit
 Factor=Antenna Factor + cable loss - Amplifier Factor



Power	: AC 120V / 60Hz	Pol/Phase	: HORIZONTAL
Test Mode	: Mode 4, CH09		:

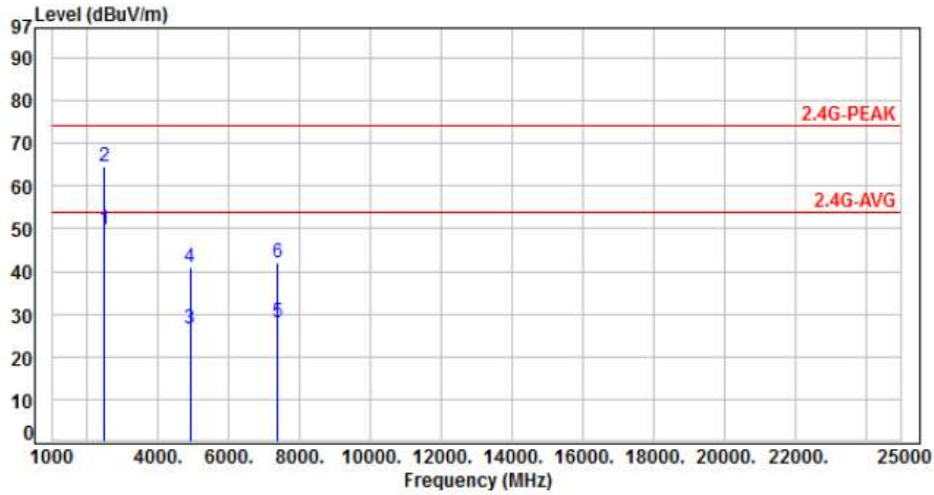

No.	Frequency (MHz)	Factor (dB)	Reading (dBuV)	Level (dBuV/m)	Limit (dBuV/m)	Margin (dB)	Detector	Height (cm)	Azimuth (deg)	P/F
1	2483.50	-14.22	64.04	49.82	54.00	-4.18	Average	100	305	P
2	2483.50	-14.22	78.90	64.68	74.00	-9.32	Peak	100	305	P
3	4904.00	-6.55	33.04	26.49	54.00	-27.51	Average	100	165	P
4	4904.00	-6.55	47.53	40.98	74.00	-33.02	Peak	100	165	P
5	7356.00	-1.26	29.13	27.87	54.00	-26.13	Average	100	110	P
6	7356.00	-1.26	43.26	42.00	74.00	-32.00	Peak	100	110	P

Note: Level=Reading+Factor
 Margin=Level-Limit
 Factor=Antenna Factor + cable loss - Amplifier Factor



6.7 Restricted Bands of Operation

Only spurious emissions are permitted in any of the frequency bands listed below:

MHz	MHz	MHz	GHz
0.09000 – 0.11000	16.42000 – 16.42300	399.9 – 410.0	4.500 – 5.250
0.49500 – 0.505**	16.69475 – 16.69525	608.0 – 614.0	5.350 – 5.460
2.17350 – 2.19050	16.80425 – 16.80475	960.0 – 1240.0	7.250 – 7.750
4.12500 – 4.12800	25.50000 – 25.67000	1300.0 – 1427.0	8.025 – 8.500
4.17725 – 4.17775	37.50000 – 38.25000	1435.0 – 1626.5	9.000 – 9.200
4.20725 – 4.20775	73.00000 – 74.60000	1645.5 – 1646.5	9.300 – 9.500
6.21500 – 6.21800	74.80000 – 75.20000	1660.0 – 1710.0	10.600 – 12.700
6.26775 – 6.26825	108.00000 – 121.94000	1718.8 – 1722.2	13.250 – 13.400
6.31175 – 6.31225	123.00000 – 138.00000	2200.0 – 2300.0	14.470 – 14.500
8.29100 – 8.29400	149.90000 – 150.05000	2310.0 – 2390.0	15.350 – 16.200
8.36200 – 8.36600	156.52475 – 156.52525	2483.5 – 2500.0	17.700 – 21.400
8.37625 – 8.38675	156.70000 – 156.90000	2655.0 – 2900.0	22.010 – 23.120
8.41425 – 8.41475	162.01250 – 167.17000	3260.0 – 3267.0	23.600 – 24.000
12.29000 – 12.29300	167.72000 – 173.20000	3332.0 – 3339.0	31.200 – 31.800
12.51975 – 12.52025	240.00000 – 285.00000	3345.8 – 3358.0	36.430 – 36.500
12.57675 – 12.57725	322.00000 – 335.40000	3600.0 – 4400.0	Above 38.6
13.36000 – 13.41000			

** : Until February 1, 1999, this restricted band shall be 0.490-0.510 MHz



6.8 Test Photographs (30MHz ~ 1GHz)

Front View



Rear View

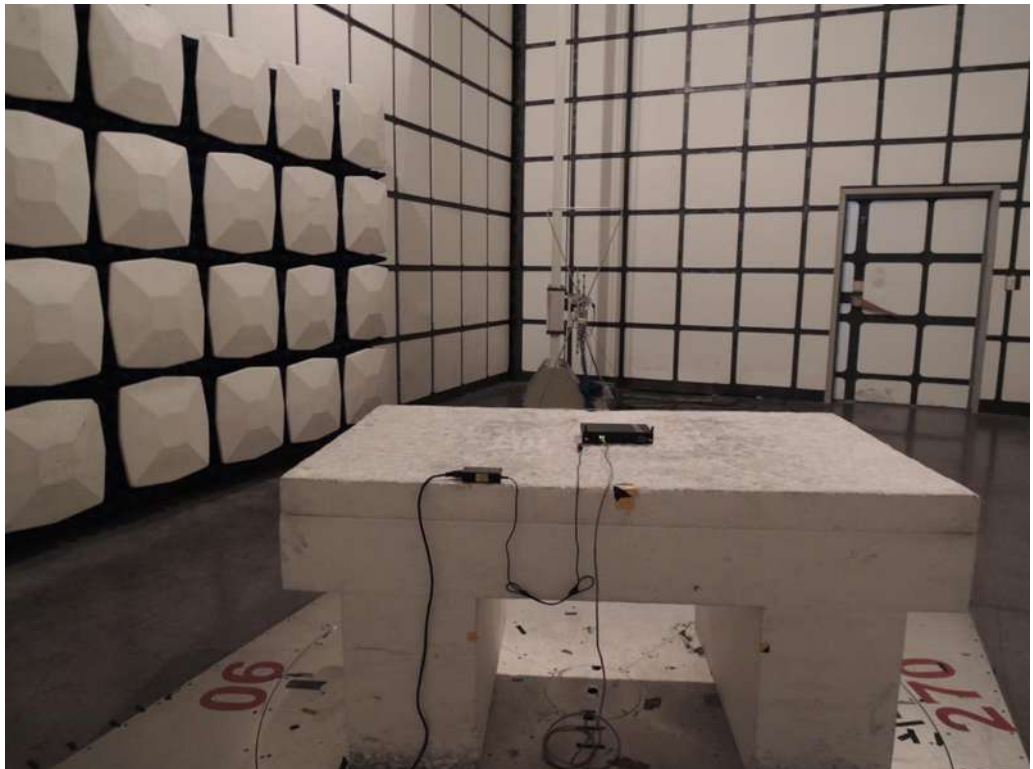



6.9 Test Photographs (1GHz ~ 25GHz)

Front View



Rear View





7. Test of Conducted Spurious Emission

7.1 Test Limit

Below -20dB of the highest emission level of operating band (In 100 kHz Resolution Bandwidth)

7.2 Test Procedure

- a. The transmitter output was connected to the spectrum analyzer via a low loss cable.
- b. Set RBW of spectrum analyzer to 100 KHz and VBW of spectrum analyzer to 300 KHz with convenient frequency span including 100 KHz bandwidth from band edge.
- c. Peak conducted output power measured within any 100 kHz outside the authorized frequency band shall be attenuated by at least 20dB relative to the maximum measured in-band peak PSD level.
- d. The band edges was measured and recorded.

7.3 Test Setup Layout

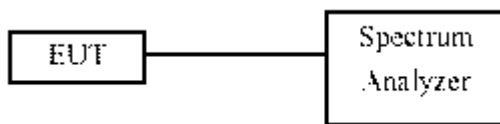

7.4 Test Result and Data

Note: Test plots refers to the following pages.



ANT A

Modulation Type: 802.11b, CH 01

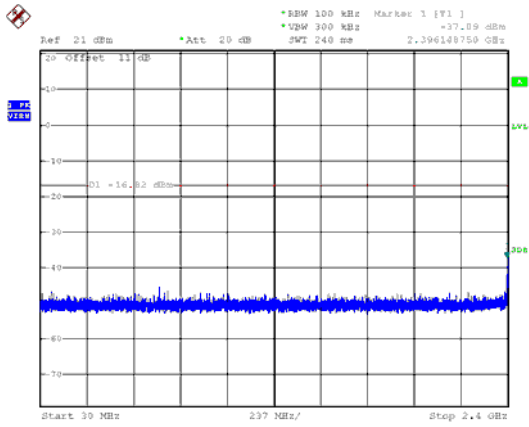

Modulation Type: 802.11b, CH 06

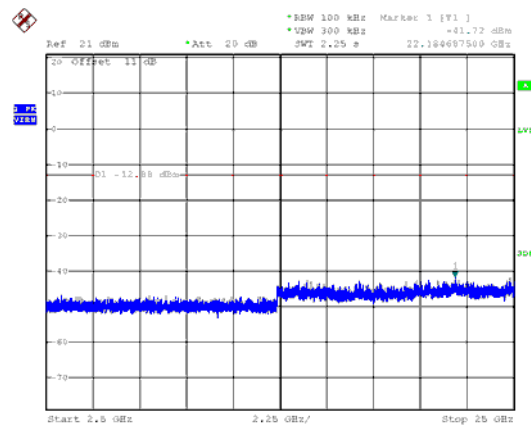
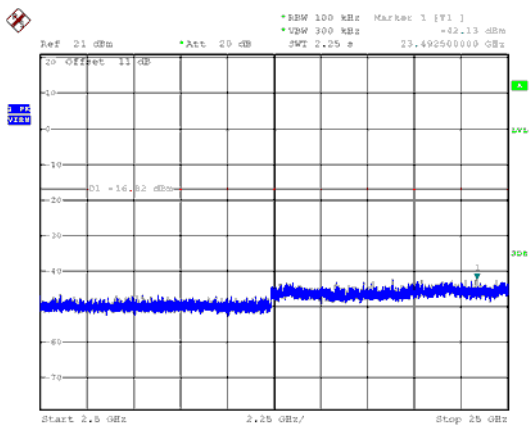
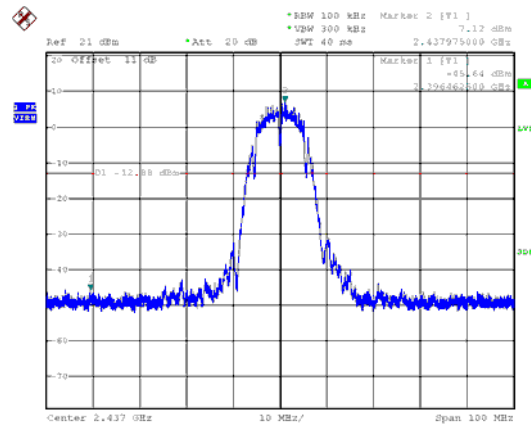
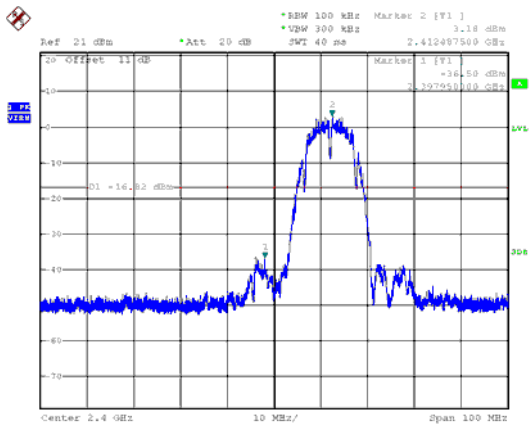
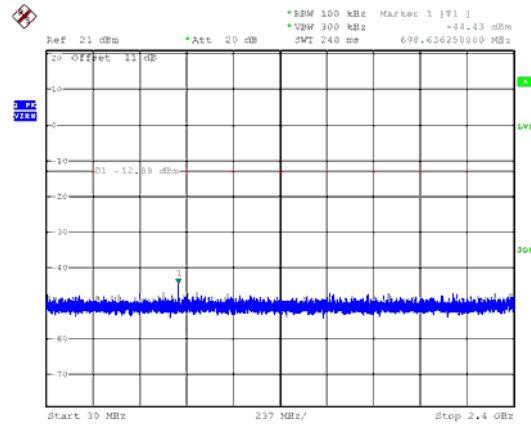



ANT A

Modulation Type: 802.11b, CH 11

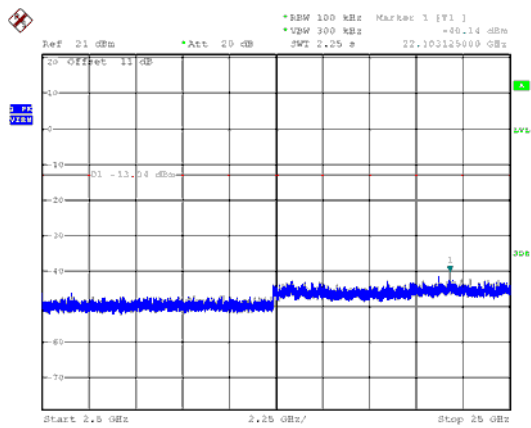
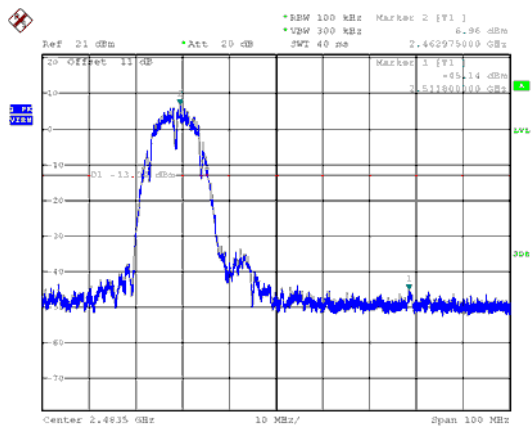
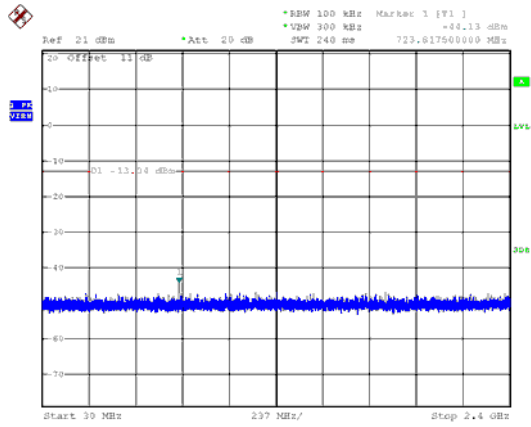



ANT A

Modulation Type: 802.11g, CH 01

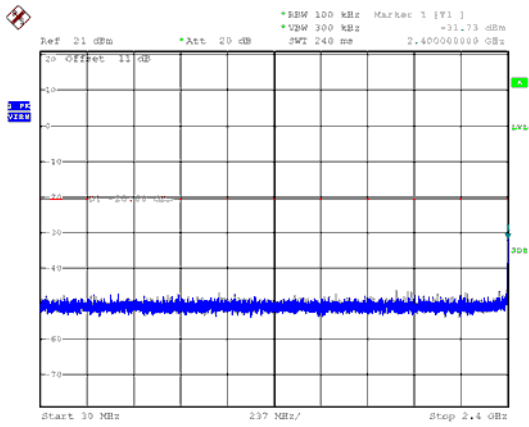

Modulation Type: 802.11g, CH 06

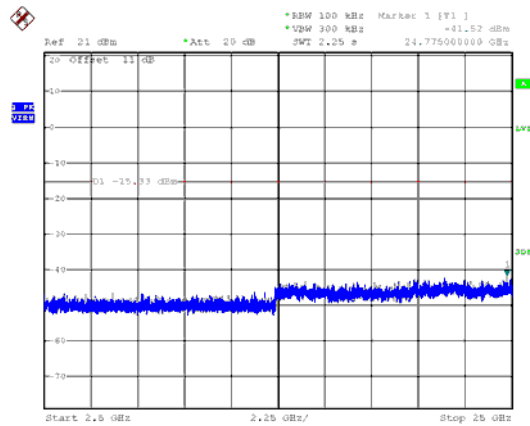
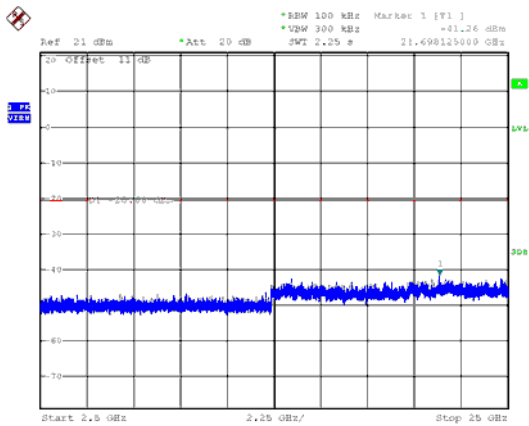
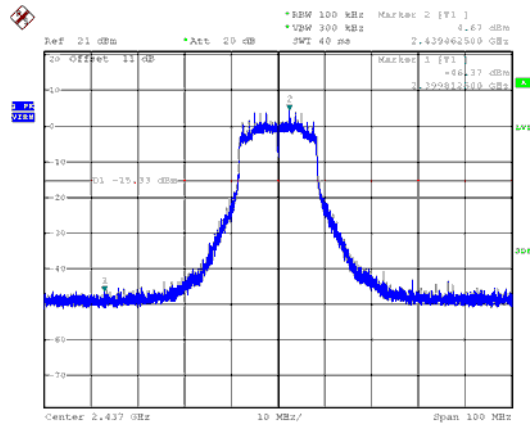
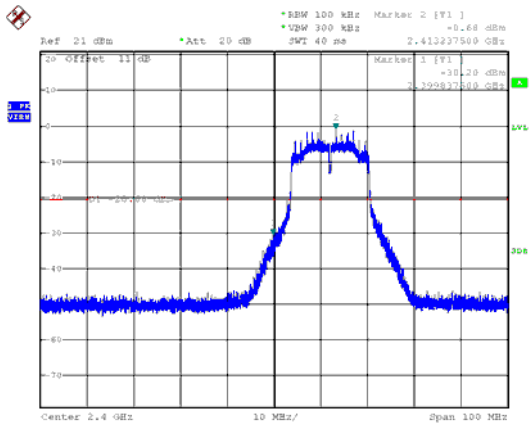
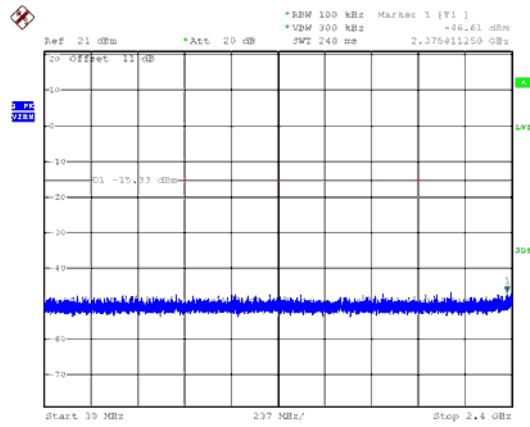



ANT A

Modulation Type: 802.11g, CH 11

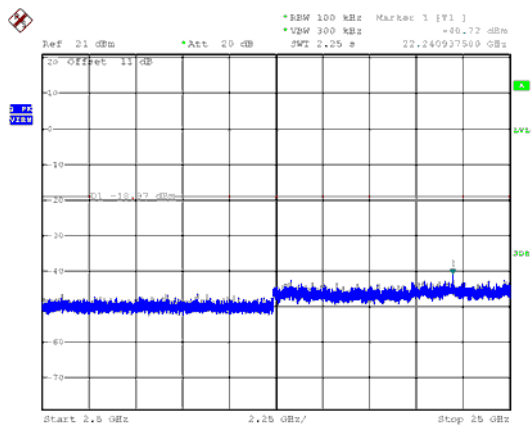
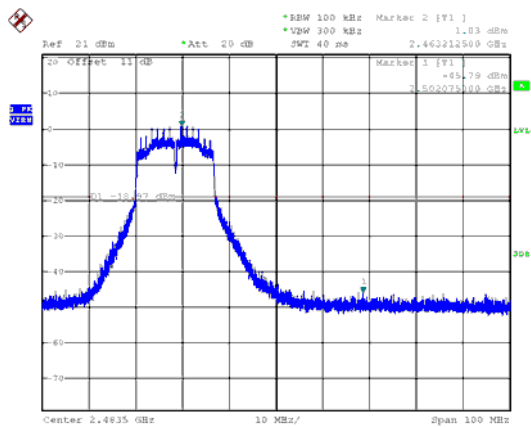
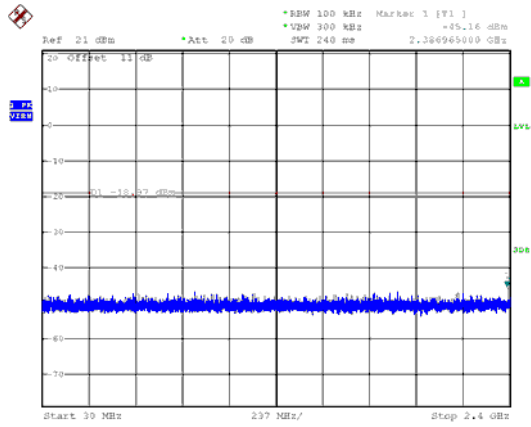



ANT A

Modulation Type: 802.11n HT20, CH01

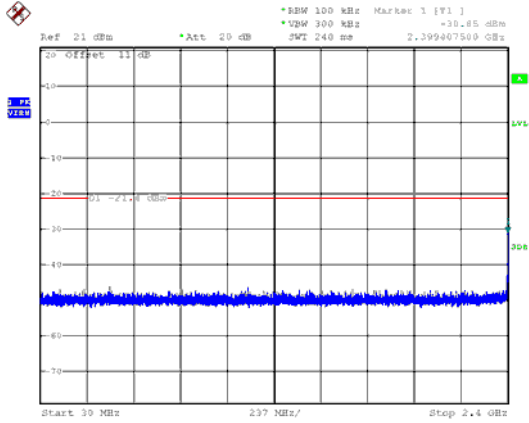

Modulation Type: 802.11n HT20, CH06

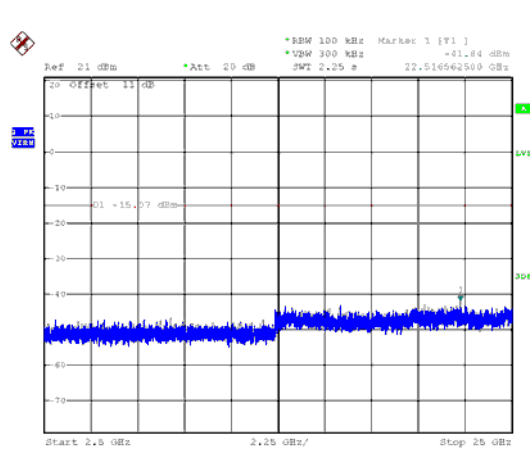
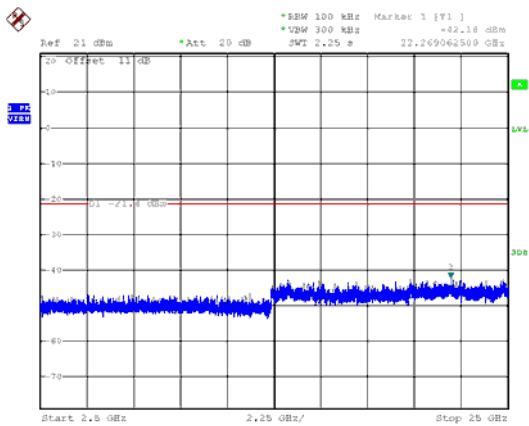
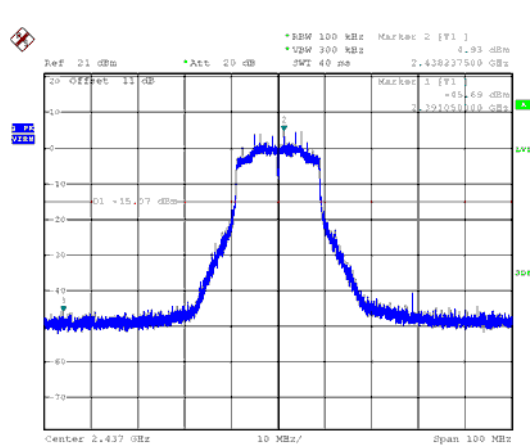
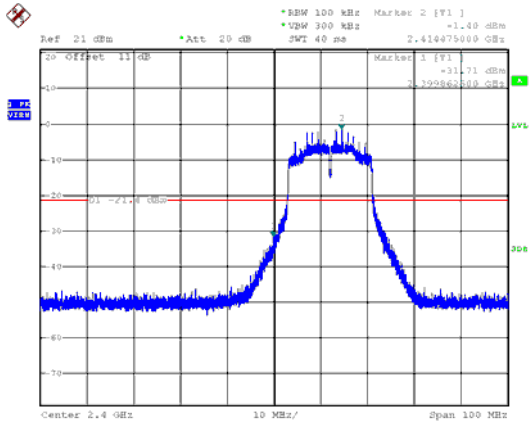
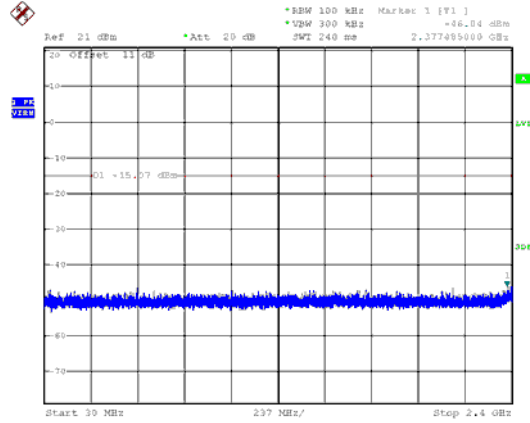



ANT A

Modulation Type: 802.11n HT20, CH11

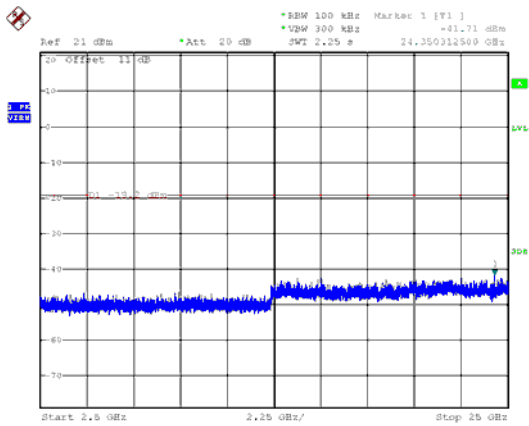
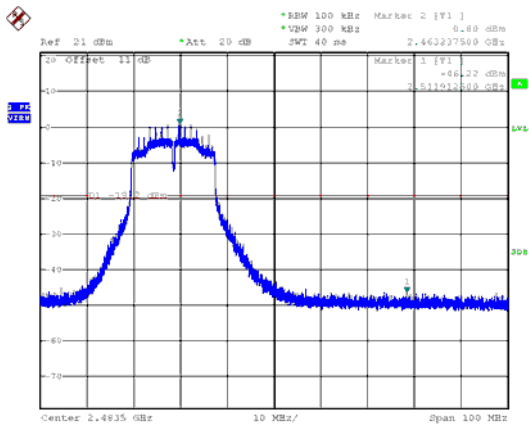
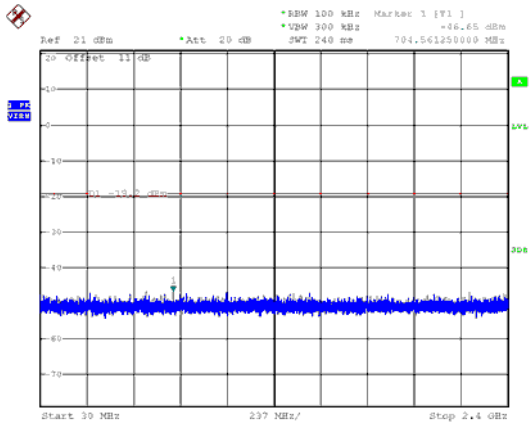



ANT A

Modulation Type: 802.11n HT40, CH03

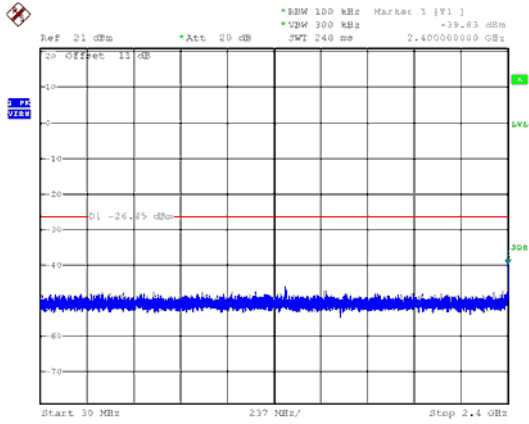

Modulation Type: 802.11n HT40, CH06

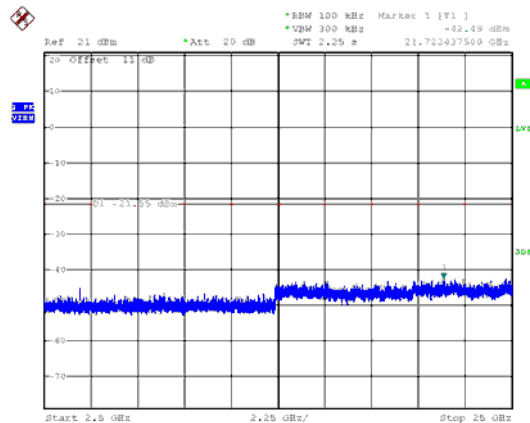
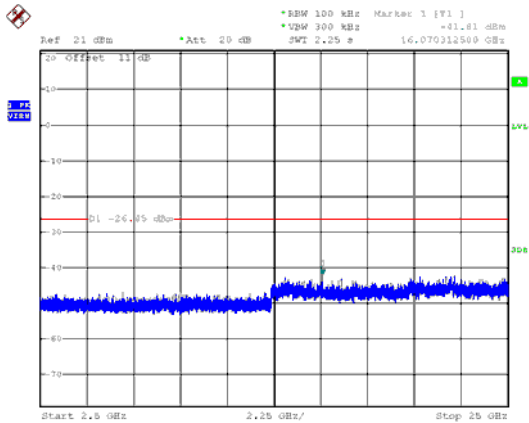
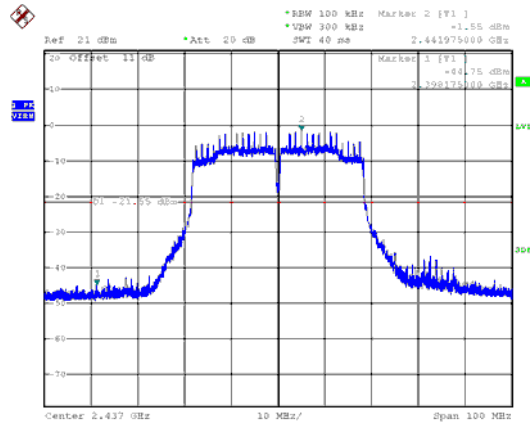
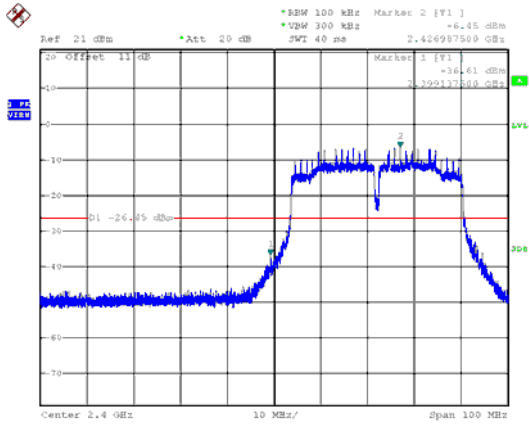
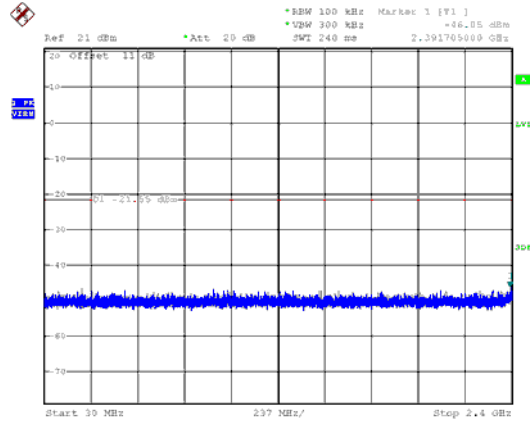



ANT A

Modulation Type: 802.11n HT40, CH09

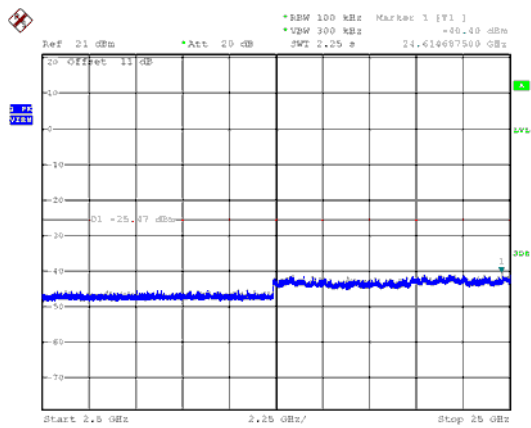
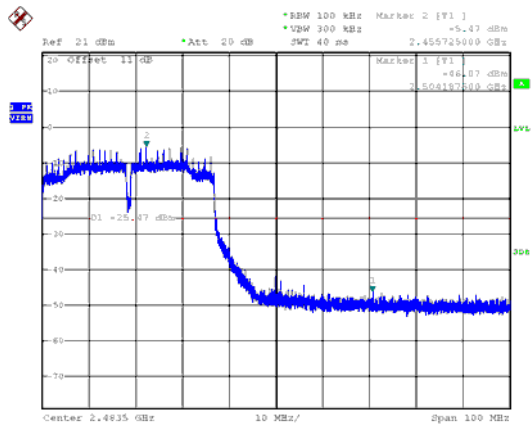
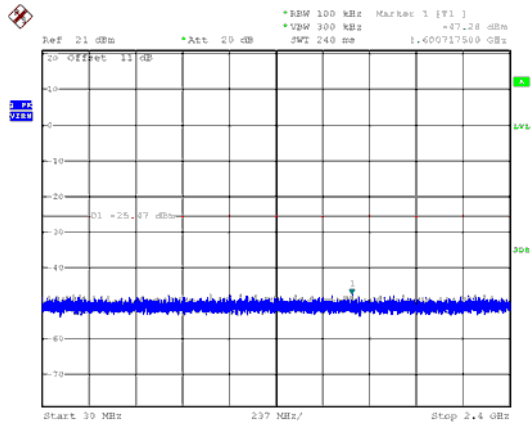



ANT B

Modulation Type: 802.11b, CH 01

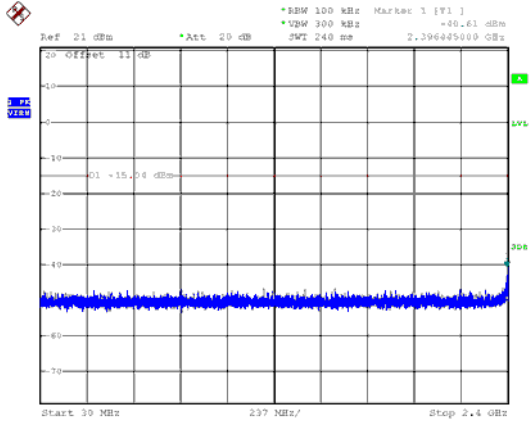

Modulation Type: 802.11b, CH 06

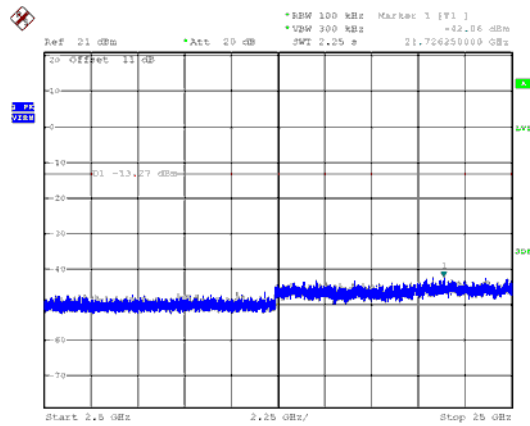
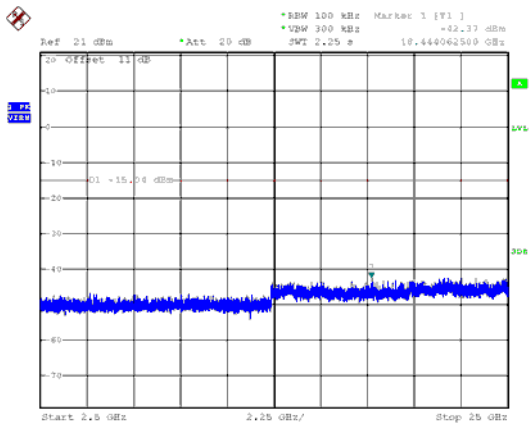
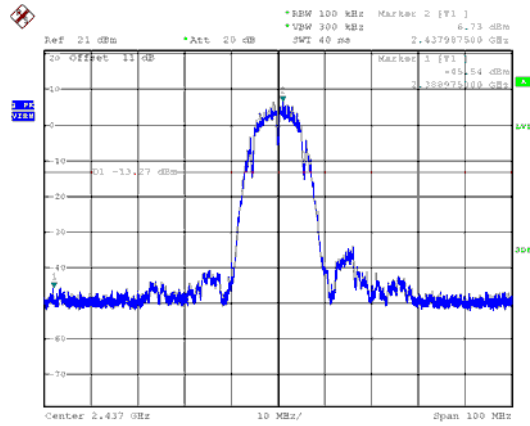
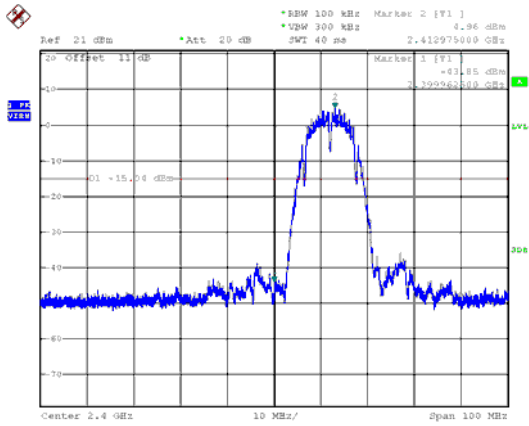
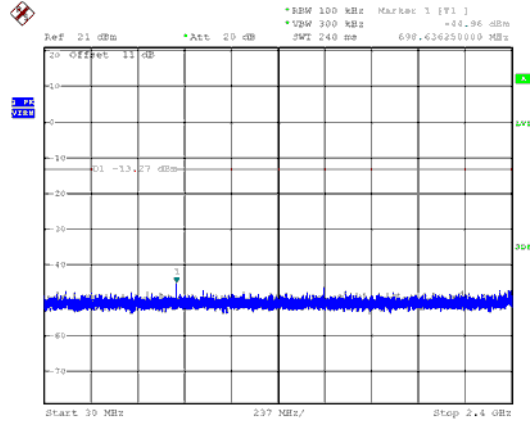



ANT B

Modulation Type: 802.11b, CH 11

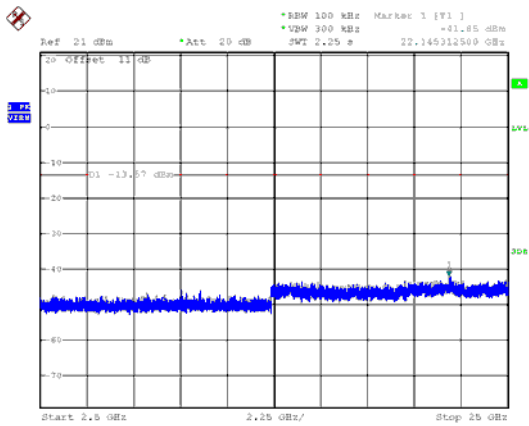
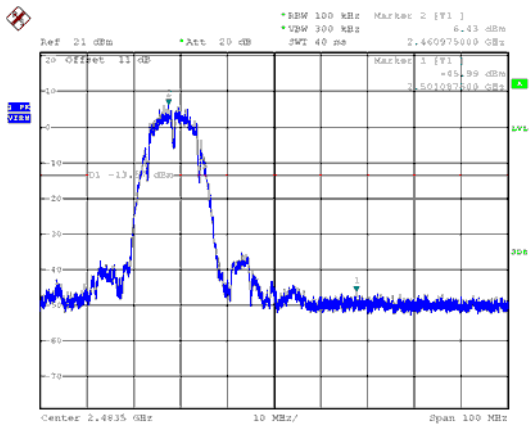
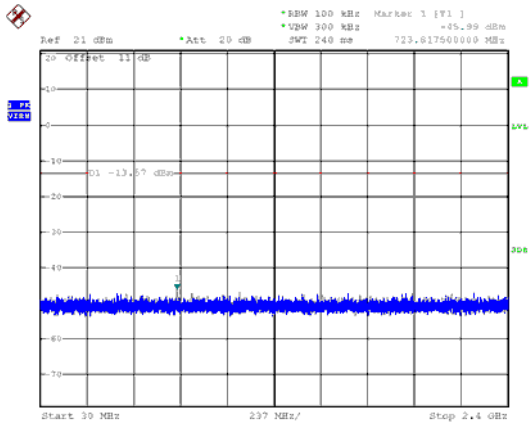



ANT B

Modulation Type: 802.11g, CH 01

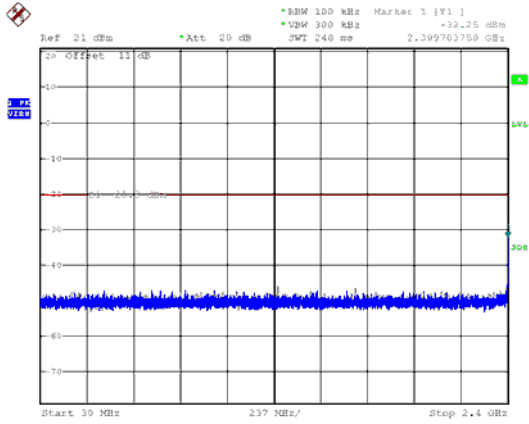

Modulation Type: 802.11g, CH 06

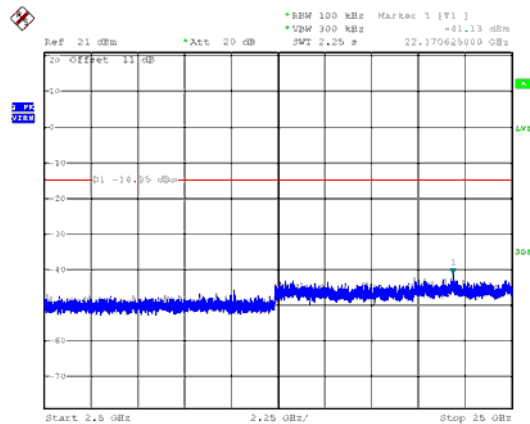
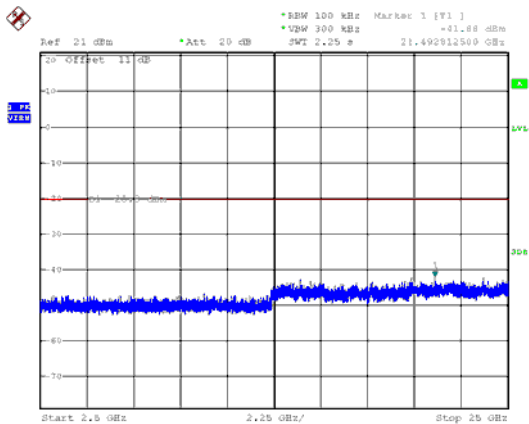
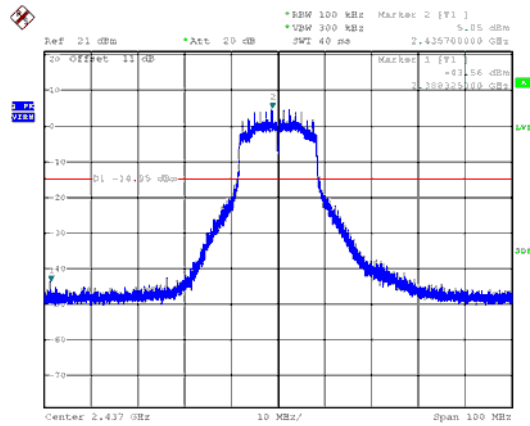
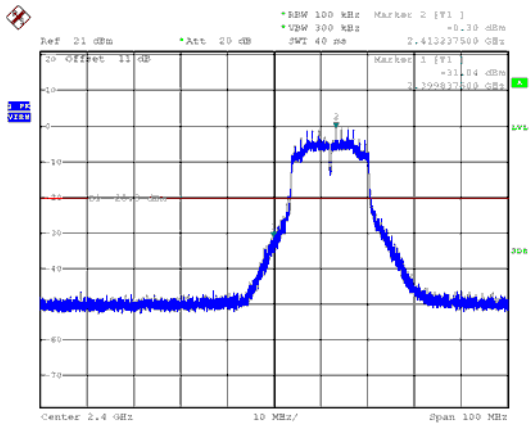
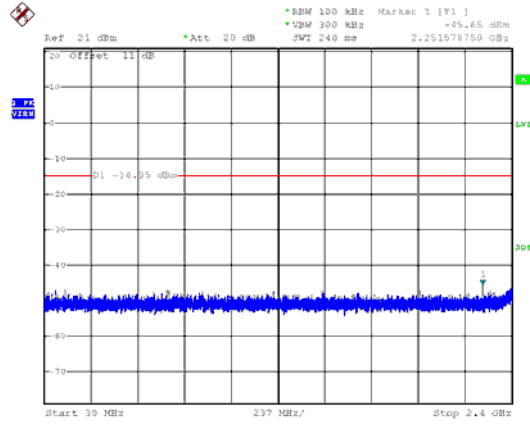



ANT B

Modulation Type: 802.11g, CH 11

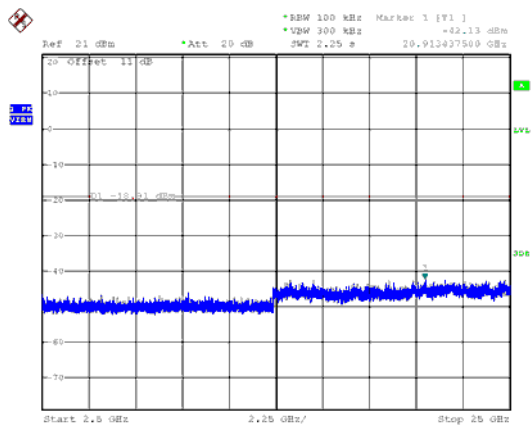
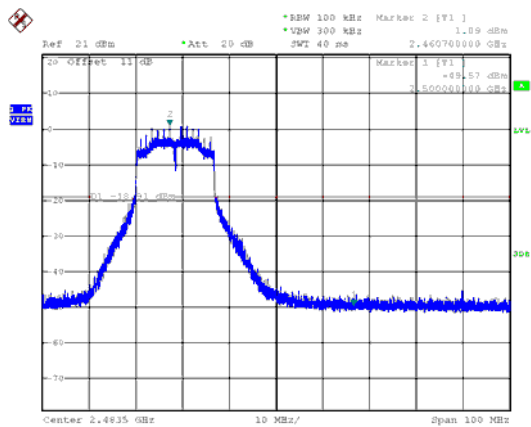
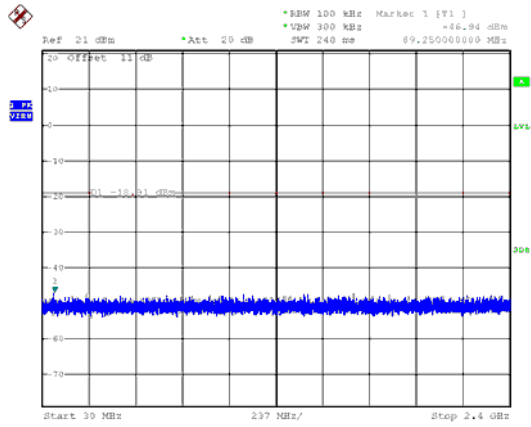



ANT B

Modulation Type: 802.11n HT20, CH01

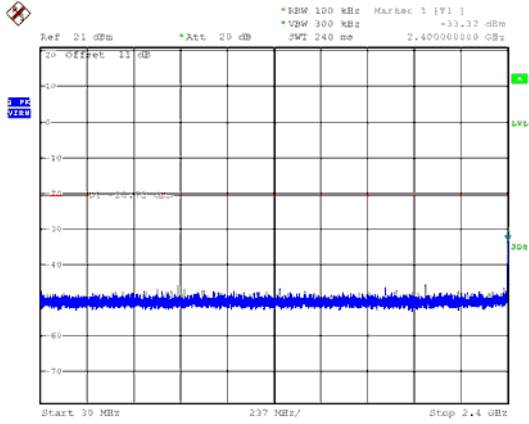

Modulation Type: 802.11n HT20, CH06

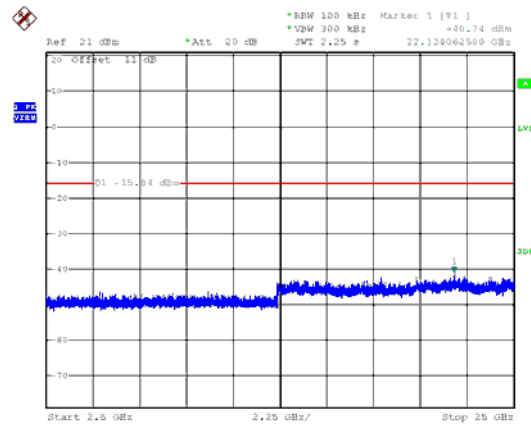
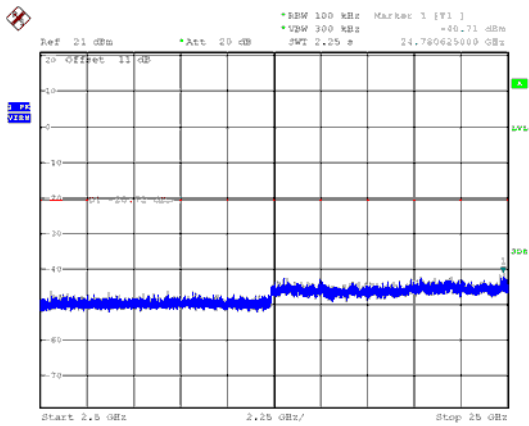
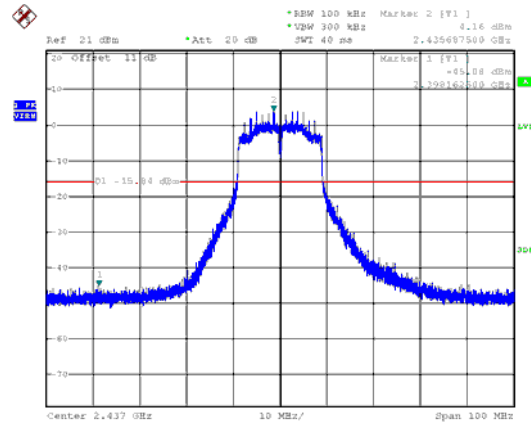
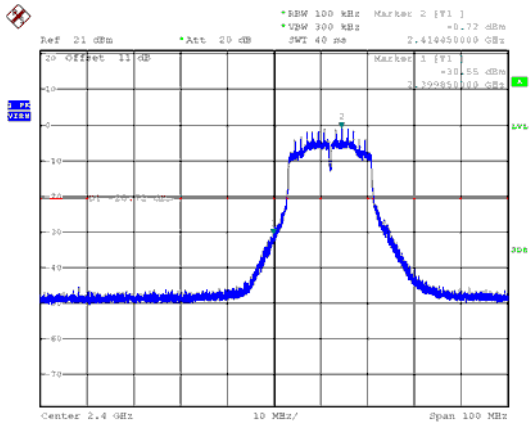
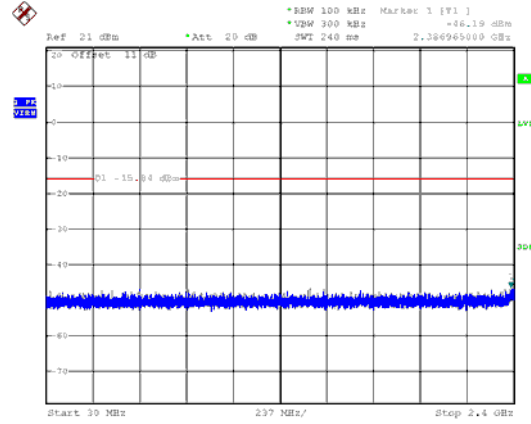



ANT B

Modulation Type: 802.11n HT20, CH11

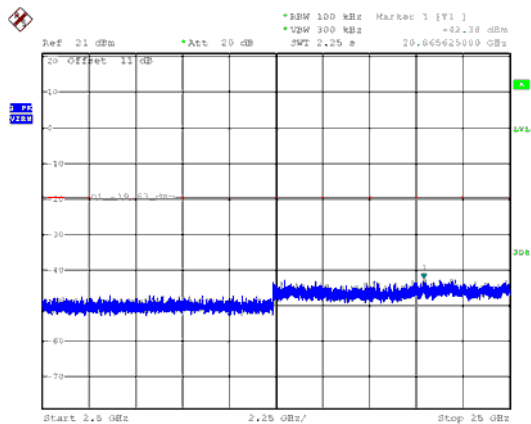
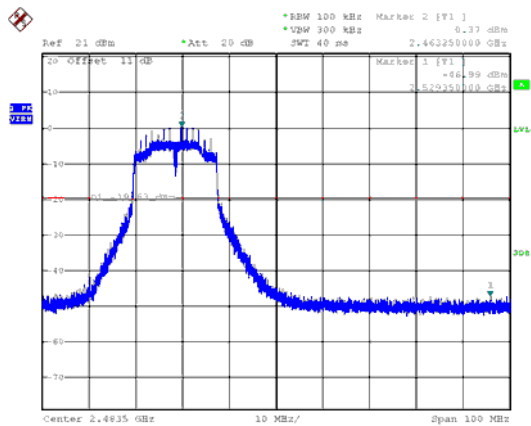
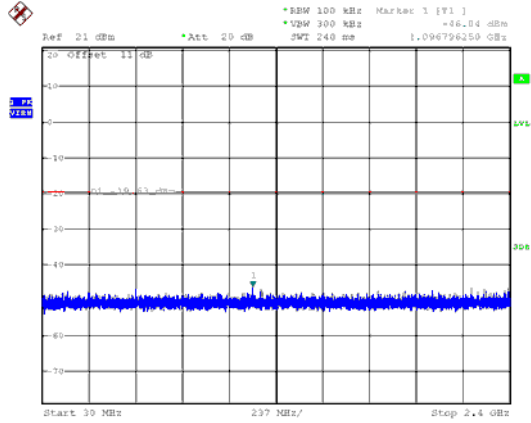



ANT B

Modulation Type: 802.11n HT40, CH03

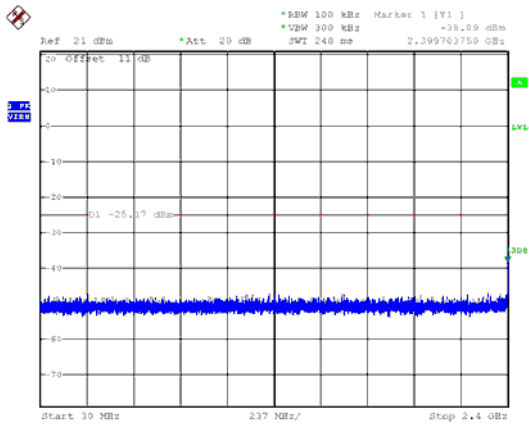

Modulation Type: 802.11n HT40, CH06

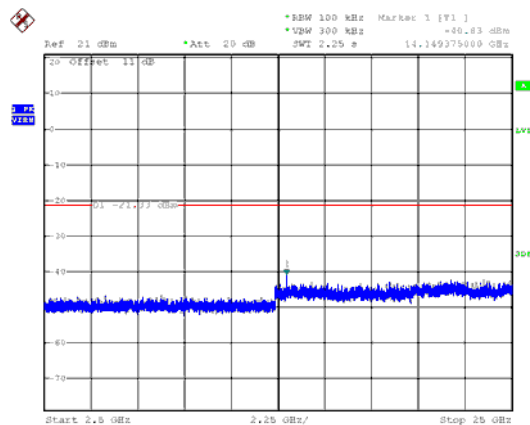
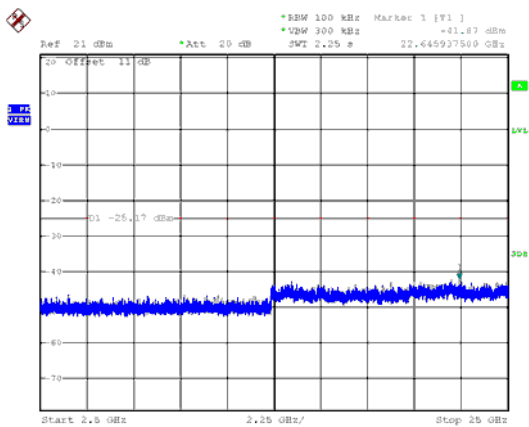
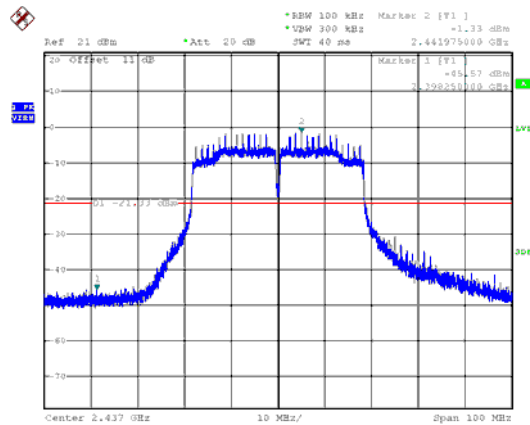
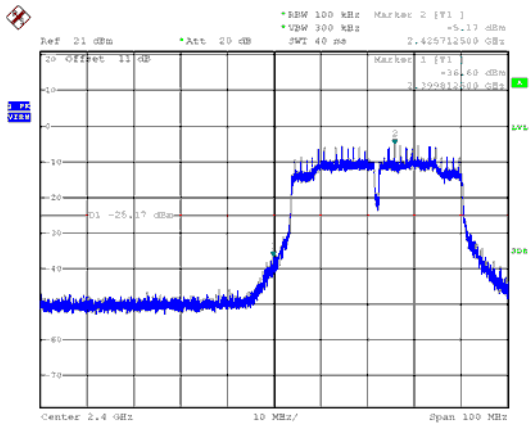
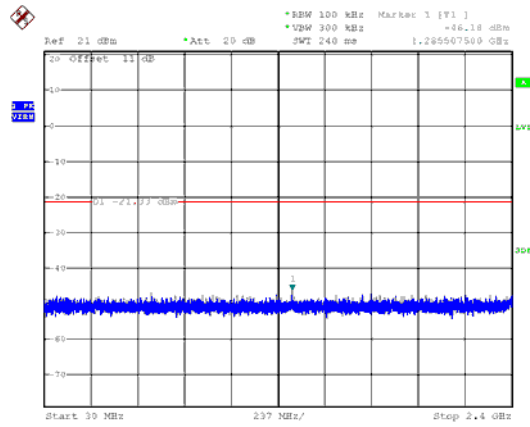



ANT B

Modulation Type: 802.11n HT40, CH09

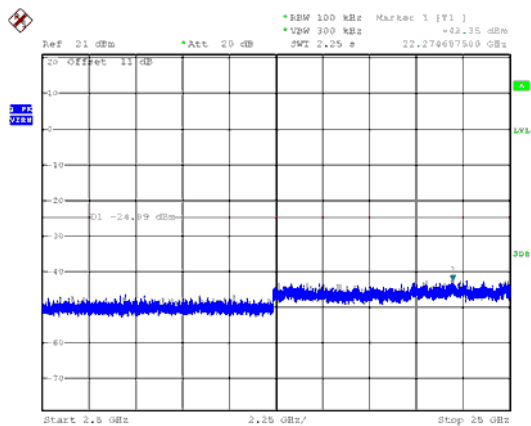
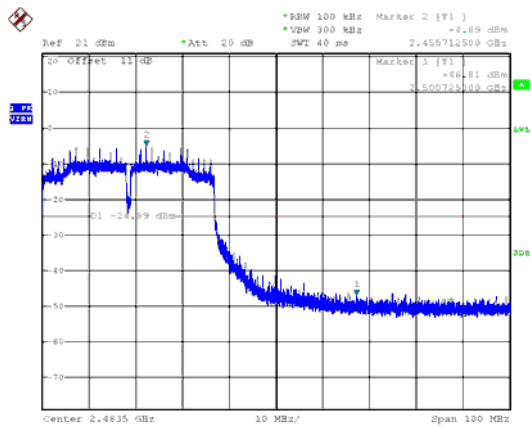
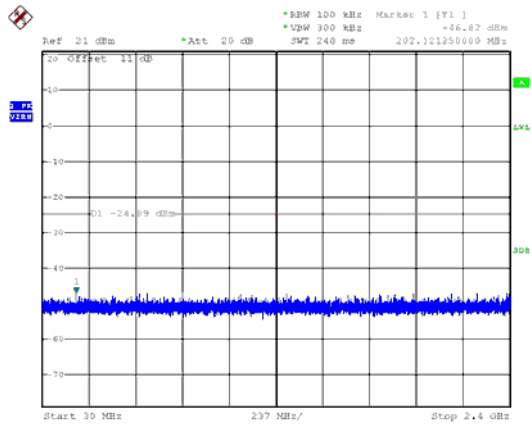



8. On Time, Duty Cycle and Measurement methods

8.1 Test Limit

None; for reporting purposes only.

8.2 Test Procedure

KDB 558074 Zero-Span Spectrum Analyzer Method.

8.3 Test Setup Layout

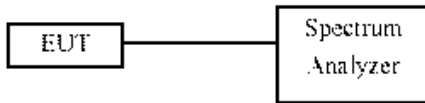

8.4 Test Result and Data

Modulation Type	On Time (msec)	Period Time (msec)	Duty Cycle (%)
11b,1M	12.40	12.44	99.68%
11g,6M	2.07	2.16	95.83%
11n HT20	2.06	2.16	95.56%
11n HT40	0.97	1.12	86.16%



Modulation Type: 802.11b (1Mbps)

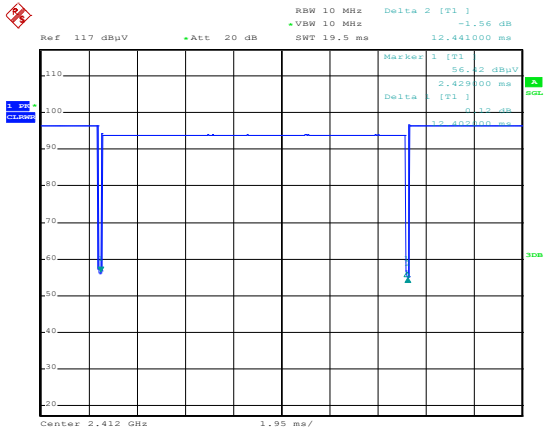

Modulation Type: 802.11g (6Mbps)

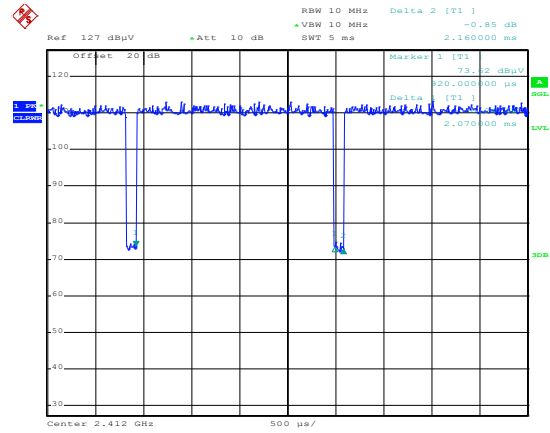

Modulation Type: 802.11n HT20 (6.5Mbps)

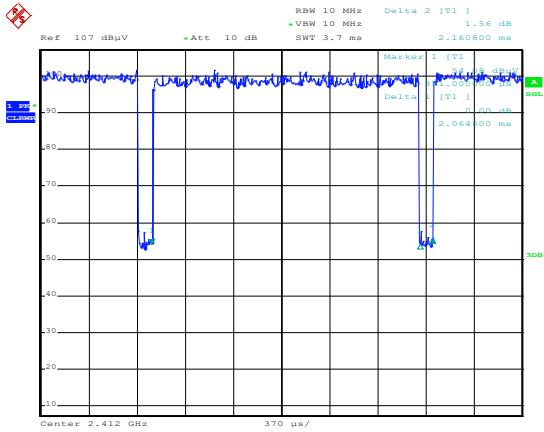

Modulation Type: 802.11n HT40 (13.5Mbps)

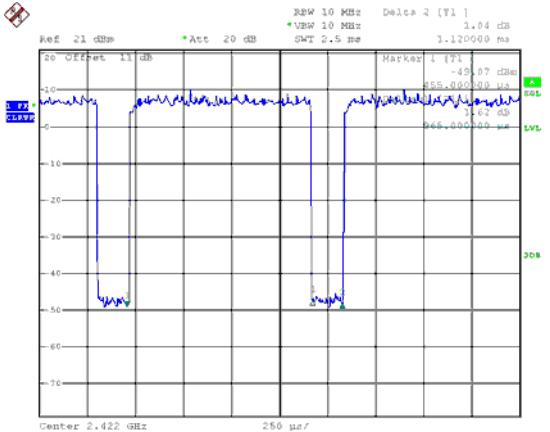



9. 6dB Bandwidth Measurement Data

9.1 Test Limit

The minimum of 6dB Bandwidth Measurement is 0.5 MHz.

9.2 Test Procedures

- The transmitter output was connected to the spectrum analyzer.
- Set RBW of spectrum analyzer to 1~5% of the emission bandwidth and VBW \geq 3x RBW.
- The 6 dB bandwidth is defined as the total spectrum the power of which is higher than peak power minus 6 dB.
- The 6dB Bandwidth was measured and recorded.

9.3 Test Setup Layout

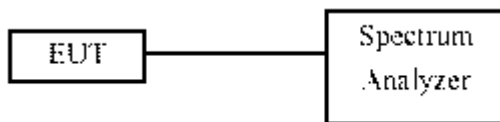

9.4 Test Result and Data

Modulation Type	Channel	Frequency (MHz)	6dB Bandwidth (MHz)		Limit (MHz)
			ANT A	ANT B	
11b	1	2412	10.00	9.20	0.5
	6	2437	9.90	9.80	0.5
	11	2462	10.20	10.20	0.5
11g	1	2412	16.30	15.80	0.5
	6	2437	15.60	15.50	0.5
	11	2462	15.70	15.70	0.5
11n HT20	1	2412	16.80	16.90	0.5
	6	2437	16.80	16.00	0.5
	11	2462	16.20	15.60	0.5
11n HT40	3	2422	35.80	35.80	0.5
	6	2437	35.80	35.60	0.5
	9	2452	35.80	36.00	0.5



ANT A

Modulation Type: 802.11b
CH01

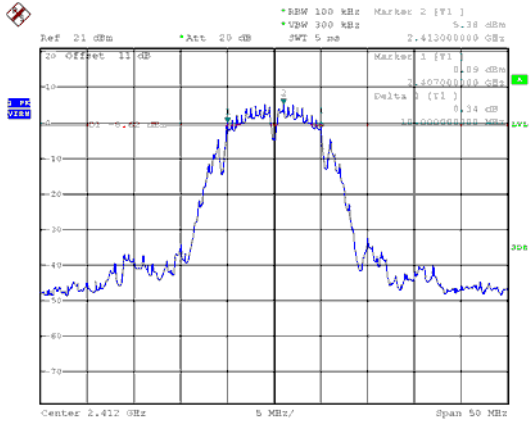

Modulation Type: 802.11g
CH01

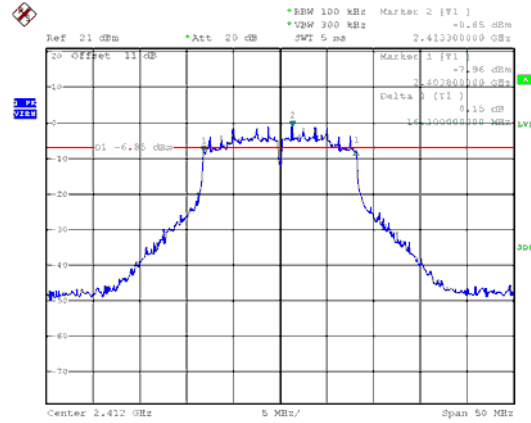

CH06

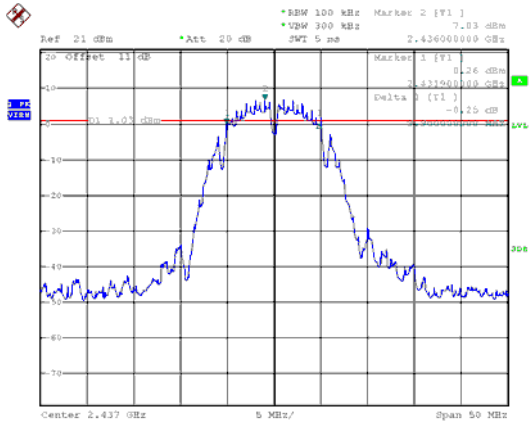

CH06

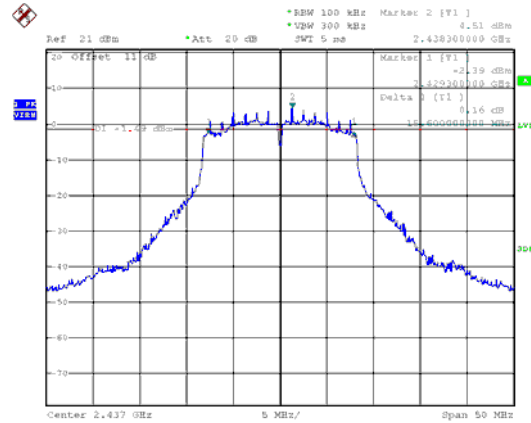

CH11

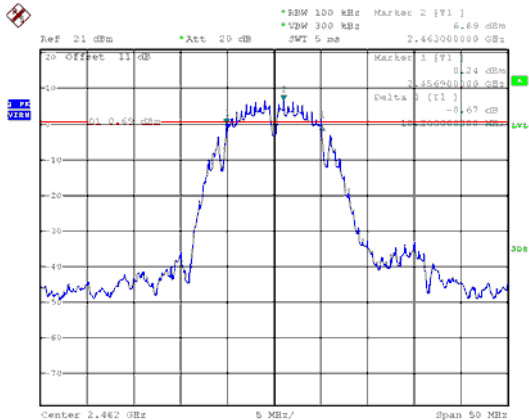

CH11

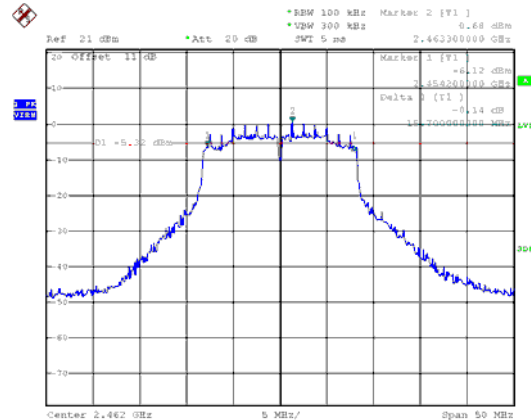



ANT A

Modulation Type: 802.11n HT20
CH01

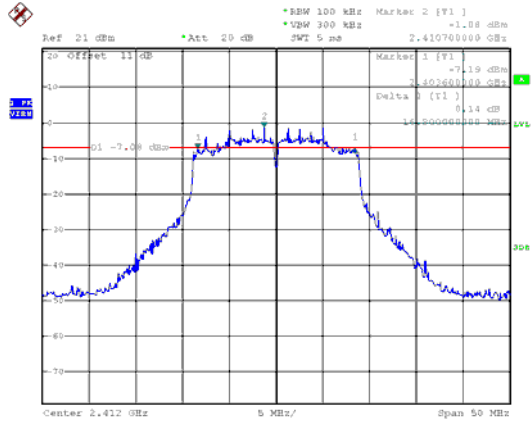

Modulation Type: 802.11n HT40
CH03

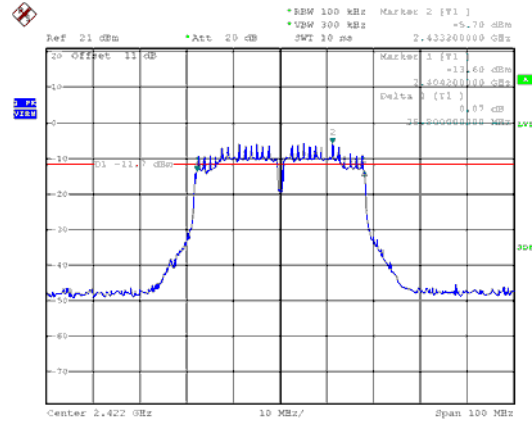

CH06

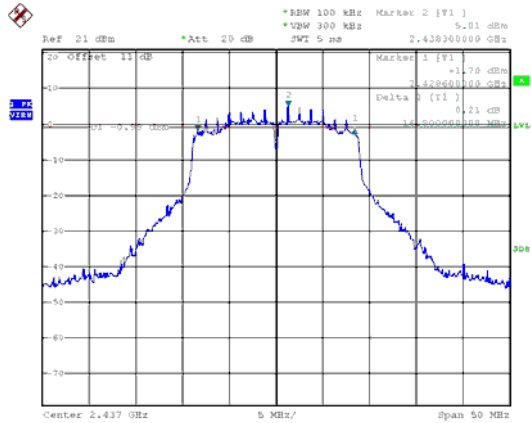

CH06

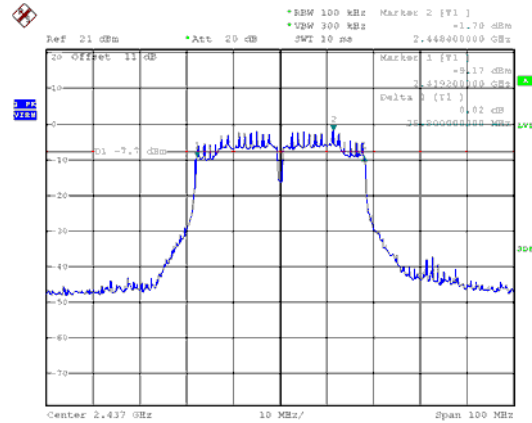

CH11

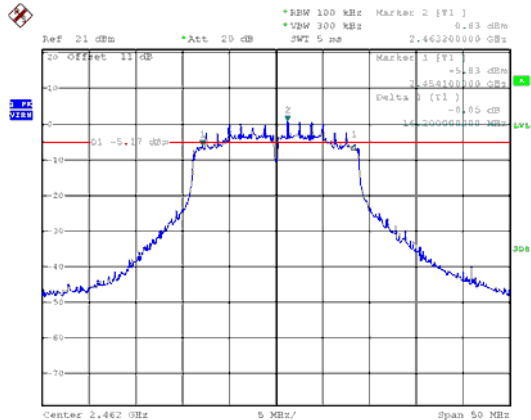

CH09

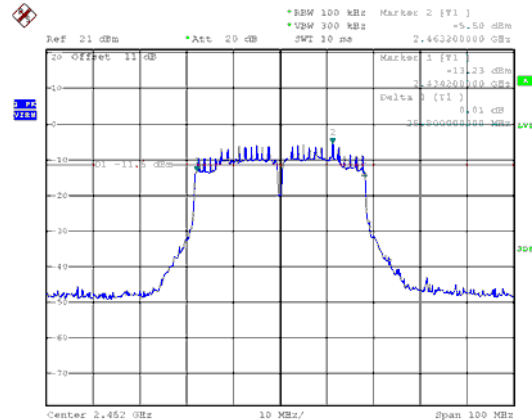



ANT B
Modulation Type: 802.11b
CH01

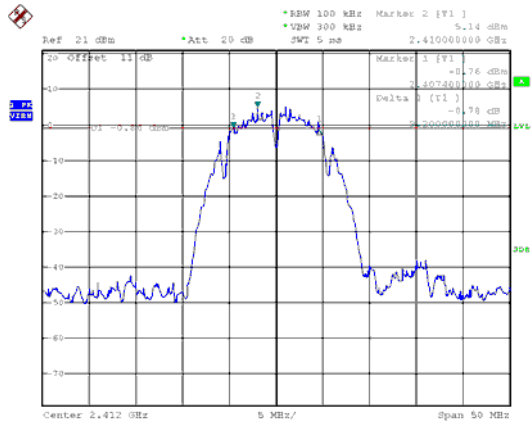

Modulation Type: 802.11g
CH01

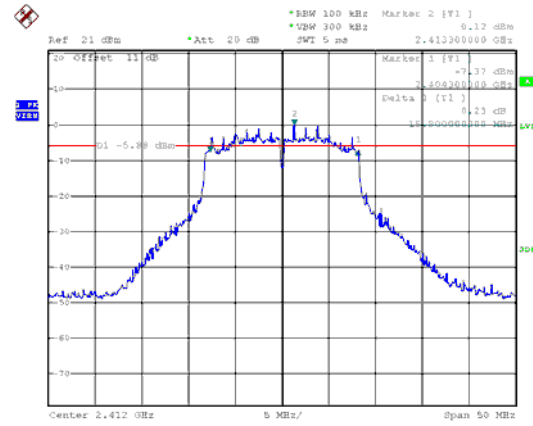

CH06

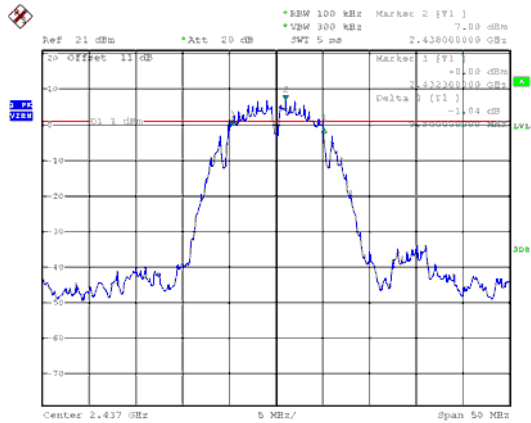

CH06

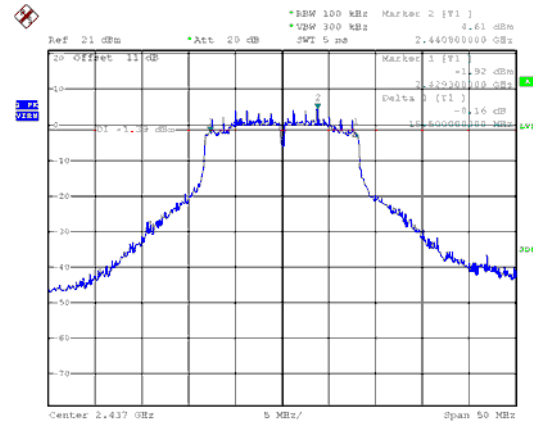

CH11

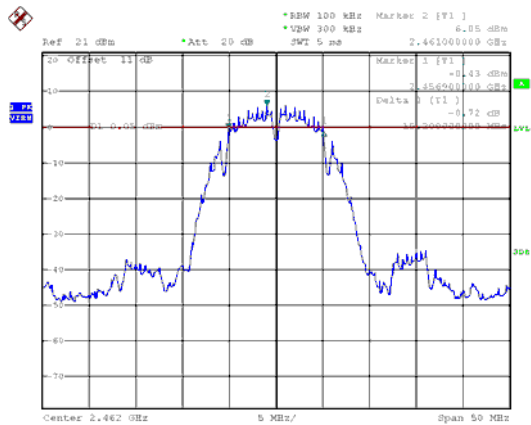

CH11

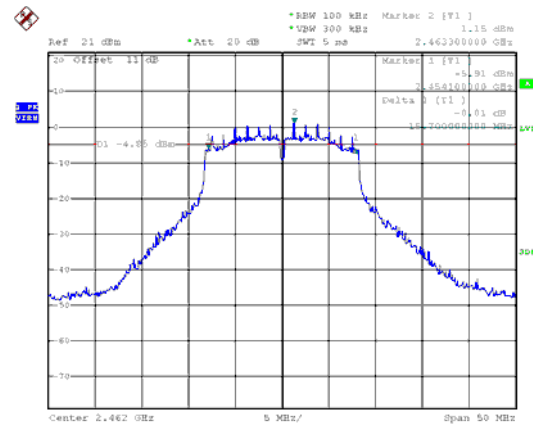



ANT B

Modulation Type: 802.11n HT20
CH01

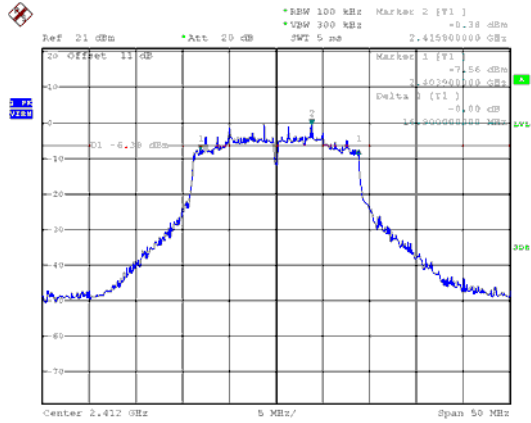

Modulation Type: 802.11n HT40
CH03

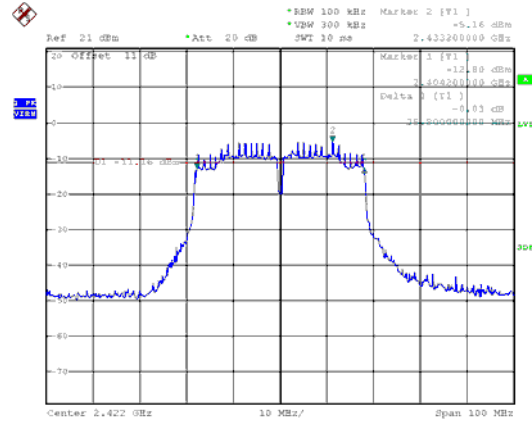

CH06

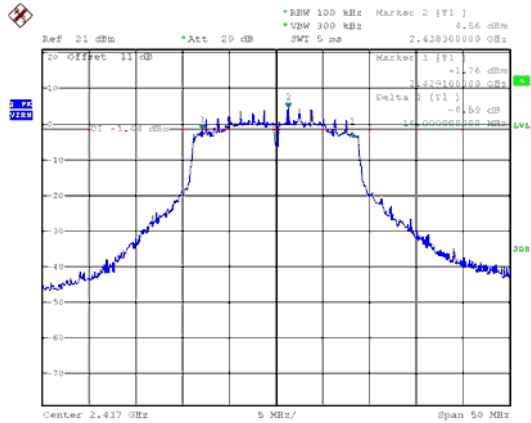

CH06

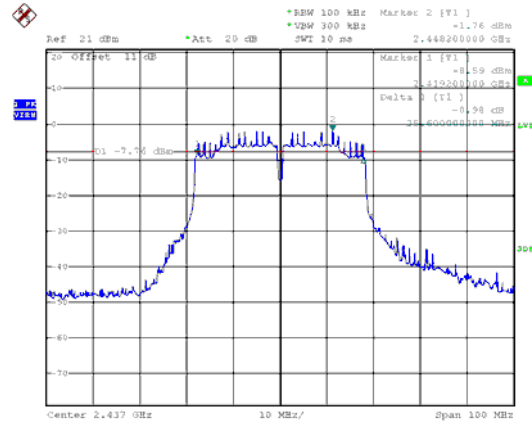

CH11

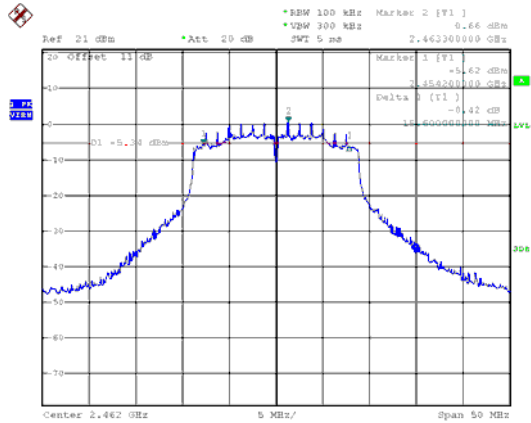

CH09

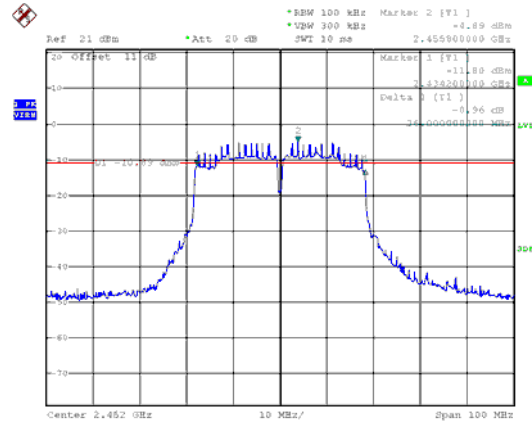



10. Maximum Peak and Average Output Power

10.1 Test Limit

The Maximum Peak Output Power Measurement is 30dBm.

If transmitting antennas of directional gain greater than 6 dBi are used, the peak output power shall be reduced by the amount in dB that the directional gain of the antenna exceeds 6 dBi

10.2 Test Procedures

The antenna port (RF output) of the EUT was connected to the input (RF input) of a power meter. Power was read directly from the meter and cable loss connection was added to the reading to obtain power at the EUT antenna terminal. The EUT Output Power was set to maximum to produce the worse case test result.

10.3 Test Setup Layout

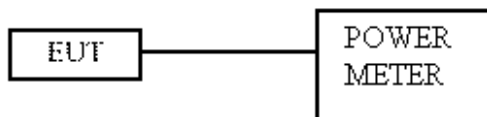

10.4 Test Result and Data

Modulation Type	Channel	Frequency (MHz)	Conducted(peak) output power (dBm)		Total PK power (dBm)	Total PK power (mW)	Power Limit (dBm)
			ANT A	ANT B			
11b	1	2412	17.54	18.48	21.05	127.224	30.00
	6	2437	18.97	18.92	21.96	156.869	30.00
	11	2462	18.28	18.06	21.18	131.271	30.00
11g	1	2412	15.45	15.77	18.62	72.832	30.00
	6	2437	20.86	20.18	23.54	226.131	30.00
	11	2462	16.32	16.24	19.29	84.928	30.00
11n HT20	1	2412	14.86	15.76	18.34	68.290	30.00
	6	2437	20.87	20.37	23.64	231.073	30.00
	11	2462	16.72	16.38	19.56	90.440	30.00
11n HT40	3	2422	12.11	13.31	15.76	37.684	30.00
	6	2437	16.97	16.82	19.91	97.858	30.00
	9	2452	13.47	13.39	16.44	44.060	30.00



Modulation Type	Channel	Frequency (MHz)	Conducted(AV) output power (dBm)		Total AV power (dBm)	Total AV power (mW)	Power Limit (dBm)
			ANT A	ANT B			
11b	1	2412	14.26	15.54	17.96	62.478	NA
	6	2437	15.73	15.93	18.84	76.585	NA
	11	2462	15.12	15.09	18.12	64.794	NA
11g	1	2412	10.14	10.57	13.37	21.730	NA
	6	2437	15.50	15.16	18.34	68.291	NA
	11	2462	11.03	11.12	14.09	25.618	NA
11n HT20	1	2412	9.51	10.45	13.02	20.025	NA
	6	2437	15.54	15.37	18.47	70.245	NA
	11	2462	11.39	11.16	14.29	26.834	NA
11n HT40	3	2422	7.21	8.43	10.87	12.226	NA
	6	2437	11.86	11.95	14.92	31.014	NA
	9	2452	8.51	8.60	11.57	14.340	NA

Note: Average power is for reference only.



11. Power Spectral Density

11.1 Test Limit

The Maximum of Power Spectral Density Measurement is 8dBm.

If transmitting antennas of directional gain greater than 6 dBi are used, the power spectral density shall be reduced by the amount in dB that the directional gain of the antenna exceeds 6 dBi

11.2 Test Procedures

- a. The transmitter output was connected to spectrum analyzer.
- b. The spectrum analyzer’s resolution bandwidth were set at 3kHz RBW and 30KHz VBW as that of the fundamental frequency. Set the sweep time=auto couple.
- c. The power spectral density was measured and recorded.

11.3 Test Setup Layout

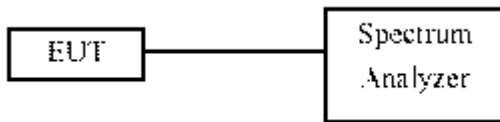

11.4 Test Result and Data

Modulation Type	Channel	Frequency (MHz)	Maximum Power Density of 3KHz Bandwidth(dBm)		Sum chain (dBm)	Duty Cycle CF(dB)	Total PSD (dBm)	Limit (dBm)
			ANT A	ANT B				
11b	1	2412	-8.26	-8.66	-5.45	0.00	-5.45	7.46
	6	2437	-7.08	-7.7	-4.37	0.00	-4.37	7.46
	11	2462	-7.08	-8.69	-4.80	0.00	-4.80	7.46
11g	1	2412	-17.1	-16.63	-13.85	0.00	-13.85	7.46
	6	2437	-10.86	-9.96	-7.38	0.00	-7.38	7.46
	11	2462	-13.95	-14.38	-11.15	0.00	-11.15	7.46
11n HT20	1	2412	-14.73	-16.08	-12.34	0.00	-12.34	7.46
	6	2437	-10.61	-9.4	-6.95	0.00	-6.95	7.46
	11	2462	-14.15	-14.68	-11.40	0.00	-11.40	7.46
11n HT40	3	2422	-21.63	-20.68	-18.12	0.00	-18.12	7.46
	6	2437	-19.57	-17.51	-15.41	0.00	-15.41	7.46
	9	2452	-19.42	-19.99	-16.69	0.00	-16.69	7.46



ANT A
Modulation Type: 802.11b
CH01

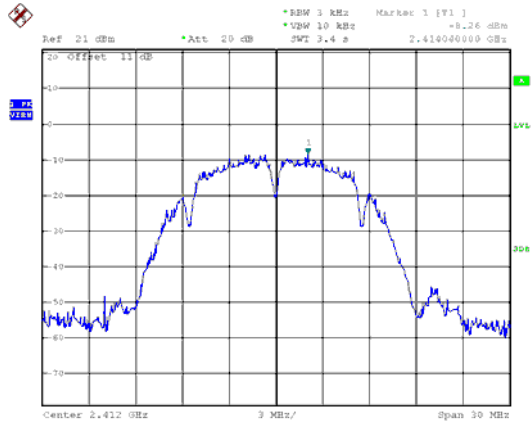

Modulation Type: 802.11b
CH01

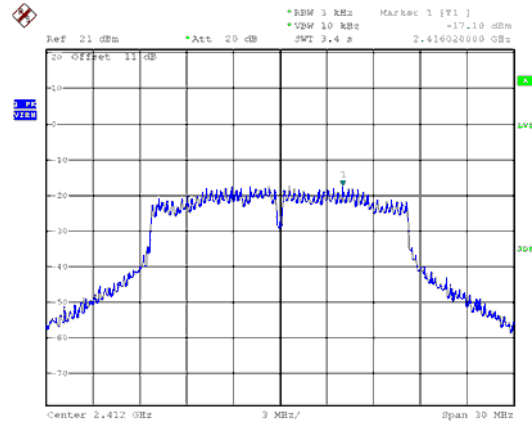

CH06

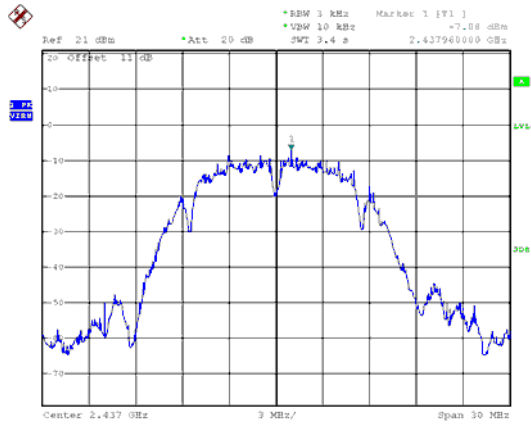

CH06

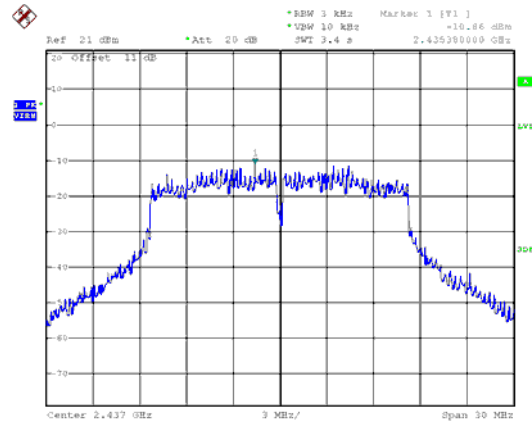

CH11

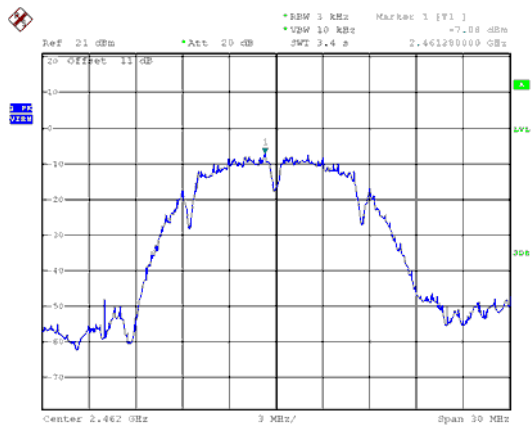

CH11

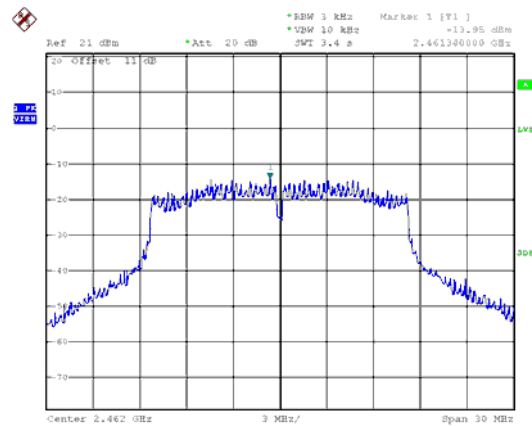



ANT A
Modulation Type: 802.11n HT20
CH01

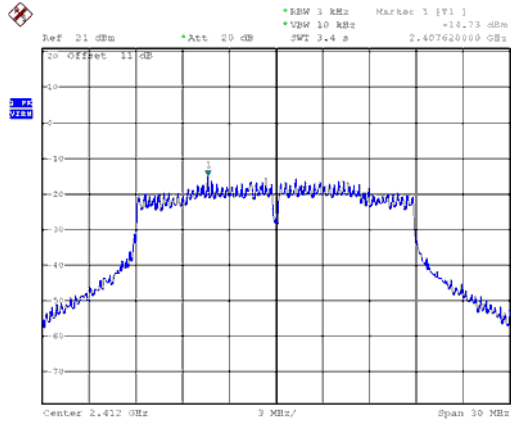

Modulation Type: 802.11n HT40
CH03

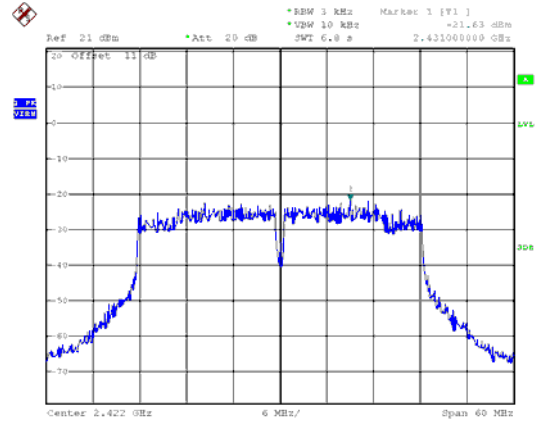

CH06

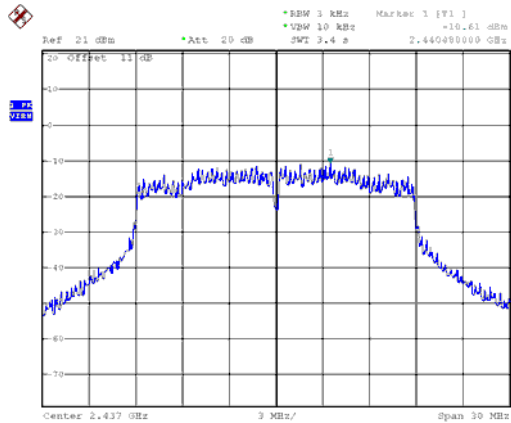

CH06

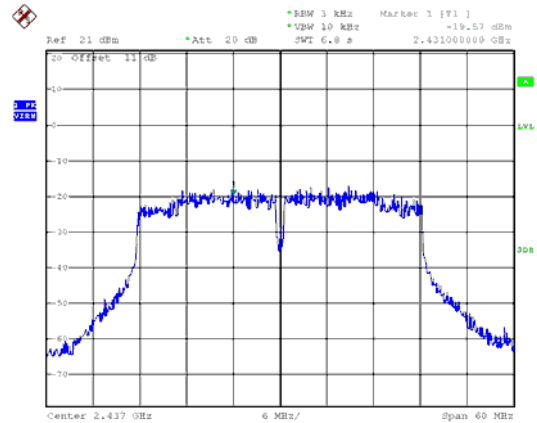

CH11

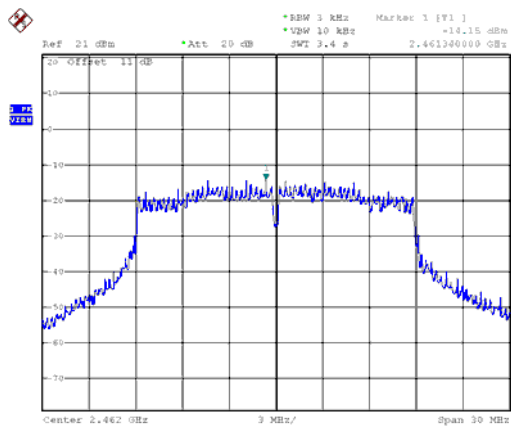

CH09

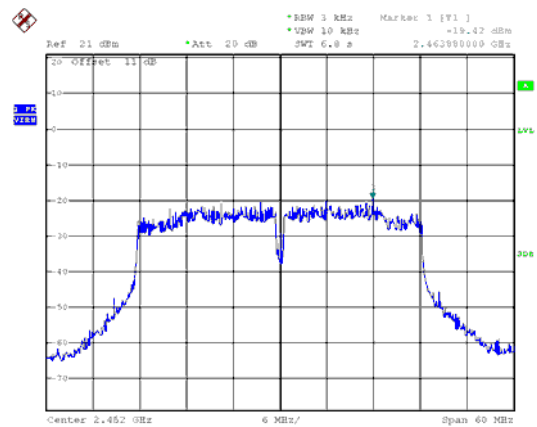



ANT B
Modulation Type: 802.11b
CH01

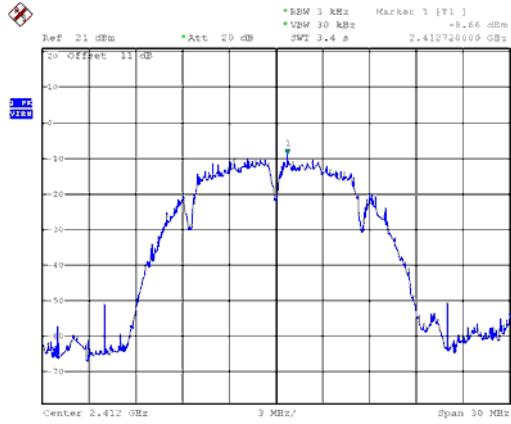

Modulation Type: 802.11g
CH01

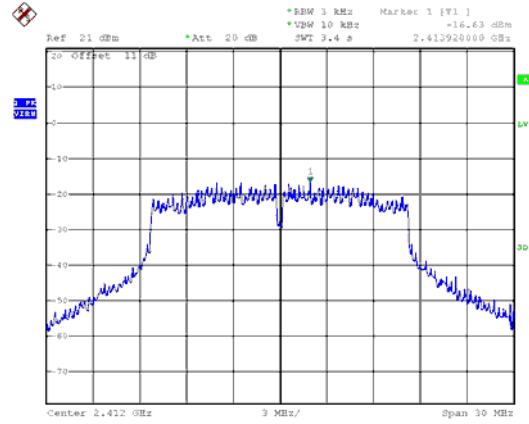

CH06

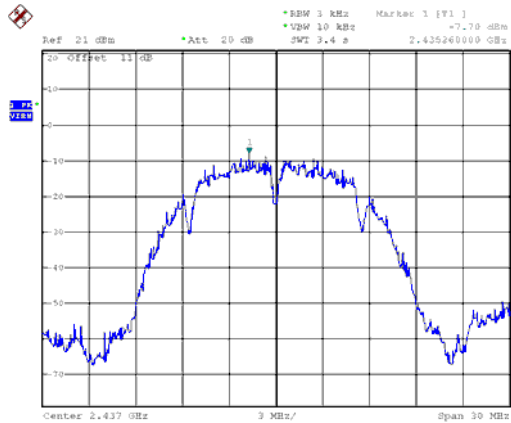

CH06

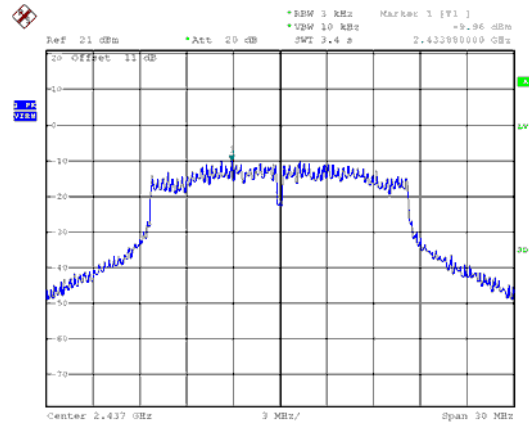

CH11

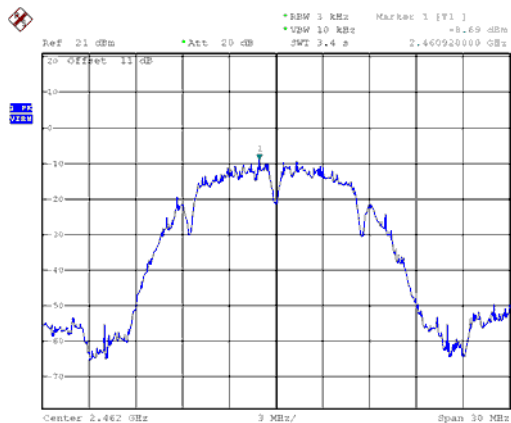

CH11

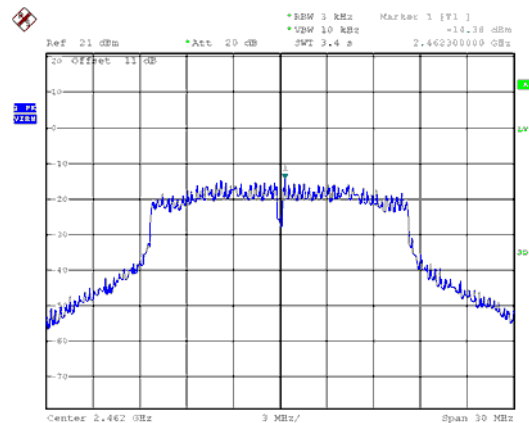



ANT B
Modulation Type: 802.11n HT20
CH01

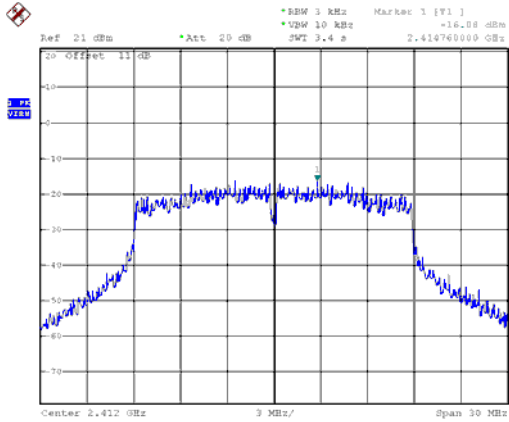

Modulation Type: 802.11n HT40
CH03

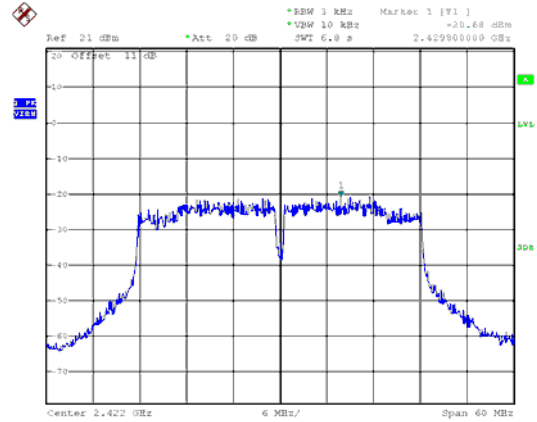

CH06

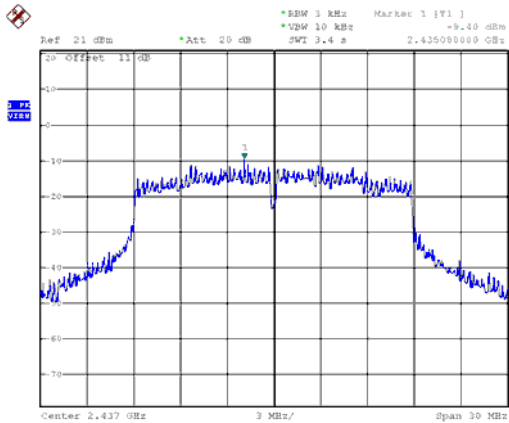

CH06

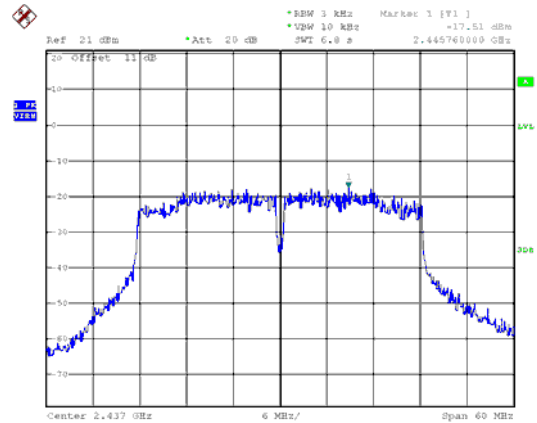

CH11

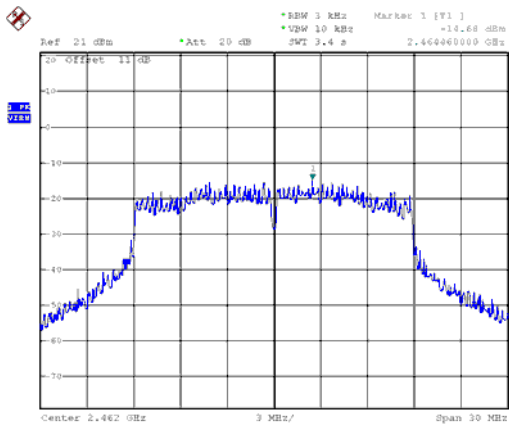

CH09

