



RADIO TEST REPORT

Applicant : AOpen Inc.

Address : 5F., No.15, Ln. 128, Sinhu 1st Rd.,
Neihu District, Taipei City 114, Taiwan(R.O.C.)

Equipment : AOPEN Chromebase Commercial

Model No. : WT22M-FBG

Trade Name : AOPEN

FCC ID : YEW -22MFBG7260NGW

IC ID : 20532-22MFBG7260N

I HEREBY CERTIFY THAT :

The sample was received on Aug. 12, 2015 and the testing was carried out on Sep. 01, 2015 at CerpPASS Technology Corp. The test result refers exclusively to the test presented test model / sample. Without written approval of CerpPASS Technology Corp., the test report shall not be reproduced except in full.

Approved by:

Tested by:

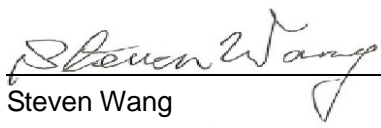
 Steven Wang
 Manager

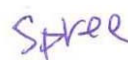
 Spree Yei
 Engineer

Laboratory Accreditation:

CerpPASS Technology Corporation Test Laboratory



CerpPASS Technology(SuZhou) Co., Ltd.





Contents

1. Summary of Test Procedure and Test Results.....	5
1.1 Applicable Standards	5
2. Test Configuration of Equipment under Test.....	6
2.1 Feature of Equipment under Test.....	6
2.2 Carrier Frequency of Channels	6
2.3 Test Mode & Test Software	7
2.4 Description of Test System.....	7
2.5 General Information of Test.....	8
3. Test Equipment and Ancillaries Used for Tests.....	9
4. Antenna Requirements.....	10
4.1 Standard Applicable	10
4.2 Antenna Construction and Directional Gain.....	10
5. Test of AC Power Line Conducted Emission	11
5.1 Test Limit	11
5.2 Test Procedures	11
5.3 Typical Test Setup	12
5.4 Test Result and Data	13
5.5 Test Photographs	15
6. Test of Spurious Emission (Radiated)	16
6.1 Test Limit	16
6.2 Test Procedures.....	16
6.3 Typical Test Setup	17
6.4 Test Result and Data (9kHz ~ 30MHz).....	18
6.5 Test Result and Data (30MHz ~ 1GHz).....	18
6.6 Test Result and Data (1GHz~25GHz).....	22
6.7 Restricted Bands of Operation	34
6.8 Restrict band emission Measurement Data	35
6.9 Test Photographs (30MHz ~ 1GHz)	37
6.10 Test Photographs (1GHz~25GHz)	38
7. Test of Spurious Emission (Conducted).....	39
7.1 Test Limit	39
7.2 Test Procedure	39
7.3 Test Setup Layout	39
7.4 Test Result and Data	39
8. Occupied Bandwidth Measurement Data	44
8.1 Test Limit	44
8.2 Test Procedures	44
8.3 Test Setup Layout	44
8.4 Test Result and Data	44
9. Frequencies Separation	47
9.1 Test Limit	47
9.2 Test Procedures	47



- 9.3 Test Setup Layout 47
- 9.4 Test Result and Data 47
- 10. Dwell Time on each channel 50**
 - 10.1 Test Limit 50
 - 10.2 Test Procedures 50
 - 10.3 Test Setup Layout 50
 - 10.4 Test Result and Data 51
- 11. Number of Hopping Channels 55**
 - 11.1 Test Limit 55
 - 11.2 Test Procedures 55
 - 11.3 Test Setup Layout 55
 - 11.4 Test Result and Data 55
- 12. Maximum Peak Output Power 57**
 - 12.1 Test Limit 57
 - 12.2 Test Procedures 57
 - 12.3 Test Setup Layout 57
 - 12.4 Test Result and Data 57



1. Summary of Test Procedure and Test Results

1.1 Applicable Standards

ANSI C63.4: 2009

FCC Rules and Regulations Part 15 Subpart C §15.247

RSS-247 issue 1

RSS-Gen issue 3

FCC Rule	IC Rule	Description of Test	Result
15.203	RSS-GEN 6.7	Antenna Requirement	Pass
15.207	RSS-GEN 8.8	AC Power Line Conducted Emission	Pass
15.209 15.205	RSS-GEN Section 8.9 & 8.10	Spurious Emission(Radiated)	Pass
15.247(d)	RSS-247 5.5	Spurious Emission(Conducted)	Pass
15.247(a)(1)	RSS-247 5.1 (2)	Channel Carrier Frequencies Separation	Pass
15.247(a)(1)	RSS-247 5.2 (1)	20dB Bandwidth Measurement	Pass
15.247(a)(1)	RSS-247 5.1 (4)	Dwell Time	Pass
15.247(b)	RSS-247 5.1 (4)	Number of Hopping Channels	Pass
15.247(b)	RSS-247 5.4 (2)	Peak Output Power Measurement Data	Pass

This EUT has been also tested and compiled with the requirement of FCC Part 15, Subpart B, and ICES-003 recorded in a separate test report.



2. Test Configuration of Equipment under Test

2.1 Feature of Equipment under Test

Frequency Range	802.11a/an/ac: 5150-5250MHz/ 5250-5350MHz, 5470-5725MHz, 5725-5850Hz 802.11b/g/n: 2412-2462MHz Bluetooth: 2402-2480 MHz
Type of Modulation	OFDM, DSSS, FHSS, GFSK (Bluetooth low energy)
Channel of Bandwidth	802.11a/an/ac: 20MHz/ 40MHz/ 80MHz 802.11b/g/n: 5MHz Bluetooth: 1MHz Bluetooth Low Energy: 2MHz
Data Rate	802.11a/an/ac: up to 867Mbps 802.11b/g/n: up to 270Mbps Bluetooth: 1, 2, 3Mbps Bluetooth Low Energy: 1Mbps
Type of Antenna	Printed Antenna *2
Antenna Gain	2 dBi
Rating Input	I/P: 100-240Vac, 50-60Hz, 1.5A O/P: 19Vdc, 4.74A

2.2 Carrier Frequency of Channels

Channel	Frequency (MHz)	Channel	Frequency (MHz)	Channel	Frequency (MHz)	Channel	Frequency (MHz)
*00	2402	20	2422	40	2442	60	2462
01	2403	21	2423	41	2443	61	2463
02	2404	22	2424	42	2444	62	2464
03	2405	23	2425	43	2445	63	2465
04	2406	24	2426	44	2446	64	2466
05	2407	25	2427	45	2447	65	2467
06	2408	26	2428	46	2448	66	2468
07	2409	27	2429	47	2449	67	2469
08	2410	28	2430	48	2450	68	2470
09	2411	29	2431	49	2451	69	2471
10	2412	30	2432	50	2452	70	2472
11	2413	31	2433	51	2453	71	2473
12	2414	32	2434	52	2454	72	2474
13	2415	33	2435	53	2455	73	2475
14	2416	34	2436	54	2456	74	2476
15	2417	35	2437	55	2457	75	2477
16	2418	36	2438	56	2458	76	2478
17	2419	37	2439	57	2459	77	2479
18	2420	38	2440	58	2460	*78	2480
19	2421	*39	2441	59	2461	---	---

Note: Channels remarked * are selected to perform test.



2.3 Test Mode & Test Software

- a. During testing, the interface cables and equipment positions were varied according to ANSI C63.4
- b. The complete test system included Mouse, Keyboard, Notebook and EUT for RF test.
- c. The test program "DRUT" under Chrome was executed to keep transmit and receive data via Bluetooth.
- d. Test modes:
 - Mode 1: GFSK (1Mbps)
 - Mode 2: $\pi/4$ -DQPSK (2Mbps)
 - Mode 3: 8DPSK (3Mbps)For AC Power Line Conducted Emission Test, Mode 3 generates the worst case; it was reported as final result.
For Radiated spurious Emission Test, Mode 1 generates the worst case; it was reported as final result.

2.4 Description of Test System

Device	Manufacturer	Model No.	Description
Mouse	DELL	M-UV83	USB Cable, Shielding, 1.8m
Keyboard	DELL	SK-8175	USB Cable, Shielding, 1.8m
Notebook	HP	ProBook 5310m	Power Cable, Unshielding, 1.8m

Used cable

Cable	Quantity	Description
Network Cable	1	Unshielding, 1.2m



2.5 General Information of Test

<input checked="" type="checkbox"/>	Test Site	Cerpass Technology Corporation Test Laboratory Address: No.10, Ln. 2, Lianfu St., Luzhu Dist., Taoyuan City 33848, Taiwan (R.O.C.) Tel:+886-3-3226-888 Fax:+886-3-3226-881 Address: No.68-1, Shihbachongsi, Shihding Township, New Taipei City 223, Taiwan, R.O.C. Tel: +886-2-2663-8582
	FCC	TW1079, TW1061,390316, 228391, 641184
	IC	4934E-1, 4934E-2
	VCCI	T-2205 for Telecommunication Test C-4663 for Conducted emission test R-3428, R-4218 for Radiated emission test G-812, G-813 for radiated disturbance above 1GHz
<input type="checkbox"/>	Test Site	Cerpass Technology (Suzhou) Co.,Ltd Address: No.66,Tangzhuang Road, Suzhou Industrial Park, Jiangsu 215006, China Tel: +86-512-6917-5888 Fax: +86-512-6917-5666
	FCC	916572, 331395
	IC	7290A-1, 7290A-2
	VCCI	T-343 for Telecommunication Test C-2919 for Conducted emission test R-2670 for Radiated emission test G-227 for radiated disturbance above 1GHz
Frequency Range Investigated:		Conducted: from 150kHz to 30 MHz Radiation: from 30 MHz to 25,000MHz
Test Distance:		The test distance of radiated emission from antenna to EUT is 3 M.



3. Test Equipment and Ancillaries Used for Tests

Instrument	Model No.	Manufacturer	Serial No.	Calibration Date	Valid Date
Spectrum Analyzer	R&S	FSP40	100047	2015/03/07	2016/03/06
PREAMPLIFIER	AGILENT	8449B	3008A01954	2015/03/05	2016/03/04
HORN ANTENNA	EMCO	3115	31589	2015/03/09	2016/03/08
HIGH PASS FILTER	HP	84300-80038	002	N/A	N/A
Bilog Antenna	SchwarzBeck	VULB 9168	275	2014/09/18	2015/09/17
SERIES POWER METER	ANRITSU	ML2495A	1224005	2015/03/05	2016/03/04
POWER SENSOR	ANRITSU	MA2411B	1207295	2015/03/05	2016/03/04
Bluetooth Tester	R&S	CBT	101133	2015/03/12	2016/03/11



4. Antenna Requirements

4.1 Standard Applicable

For intentional device, according to FCC 47 CFR Section 15.203, an intentional radiator shall be designed to ensure that no antenna other than that furnished by the responsible party shall be used with the device.

And according to FCC 47 CFR Section 15.247 (b), if transmitting antennas of directional gain greater than 6dBi are used, the power shall be reduced by the amount in dB that the directional gain of the antenna exceeds 6dBi.

4.2 Antenna Construction and Directional Gain

No.	Antenna Type	Antenna Gain
A	Printed antenna	2 dBi



5. Test of AC Power Line Conducted Emission

5.1 Test Limit

Conducted Emissions were measured from 150 kHz to 30 MHz with a bandwidth of 9 KHz on the 120 VAC power and return leads of the EUT according to the methods defined in ANSI C63.4-2009 Section 3.1. The EUT was placed on a nonmetallic stand in a shielded room 0.8 meters above the ground plane as shown in section 2.2. The interface cables and equipment positioning were varied within limits of reasonable applications to determine the position produced maximum conducted emissions.

Frequency (MHz)	Quasi Peak (dB μ V)	Average (dB μ V)
0.15 – 0.5	66-56*	56-46*
0.5 – 5.0	56	46
5.0 – 30.0	60	50

*Decreases with the logarithm of the frequency.

5.2 Test Procedures

- a. The EUT was placed 0.4 meter from the conducting wall of the shielding room was kept at least 80 centimeters from any other grounded conducting surface.
- b. Connect EUT to the power mains through a line impedance stabilization network (LISN).
- c. All the support units are connecting to the other LISN.
- d. The LISN provides 50 ohm coupling impedance for the measuring instrument.
- e. The FCC states that a 50 ohm, 50 micro-Henry LISN should be used.
- f. Both sides of AC line were checked for maximum conducted interference.
- g. The frequency range from 150 kHz to 30 MHz was searched.
- h. Set the test-receiver system to Peak Detect Function and Specified Bandwidth with Maximum Hold Mode.



5.3 Typical Test Setup

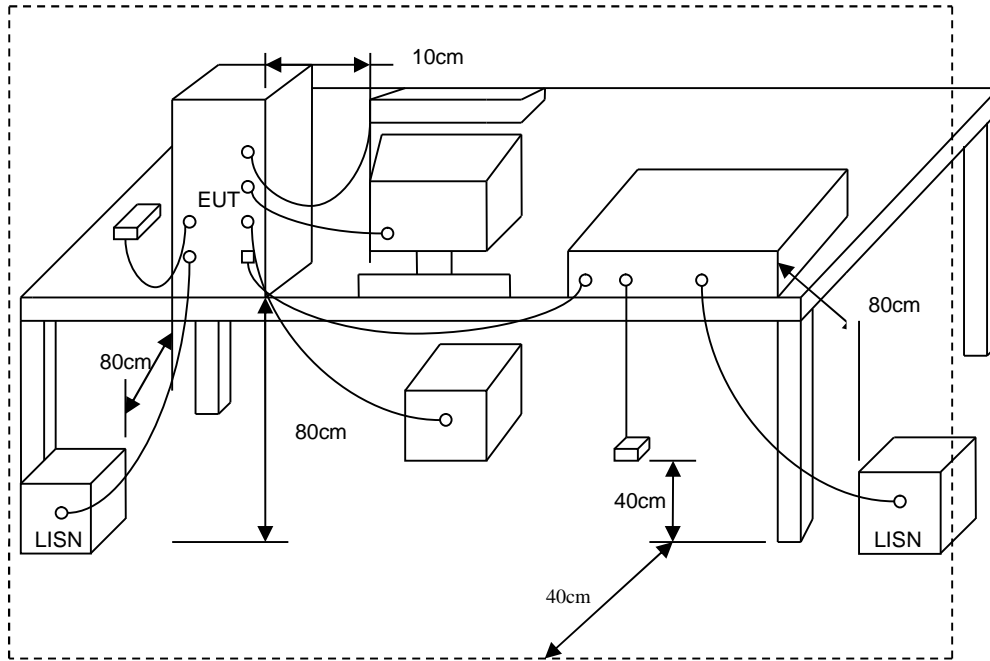



5.4 Test Result and Data

Power	: AC 120V	Pol/Phase	: LINE
Test Mode	: Mode 3	Temperature	: 26 °C
Test date	: Sep. 01, 2015	Humidity	: 48 %
Memo	:	Atmospheric Pressure	: 1008 hpa

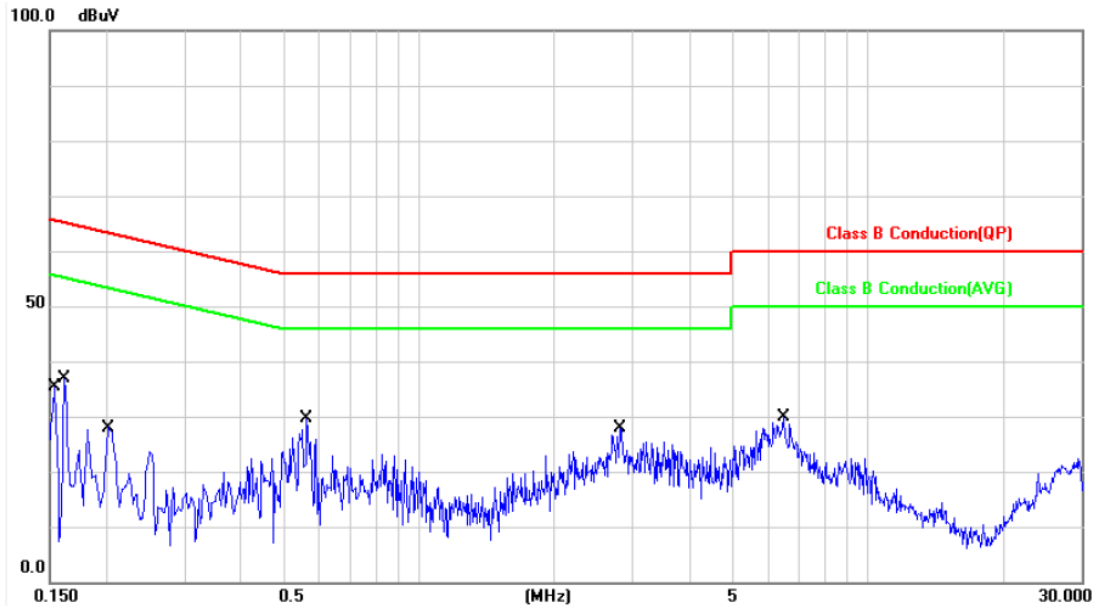

No.	Frequency (MHz)	Factor (dB)	Reading (dBuV)	Level (dBuV)	Limit (dBuV)	Margin (dB)	Detector	P/F
1	0.1539	-0.02	32.58	32.56	65.78	-33.22	QP	P
2	0.1539	-0.02	18.79	18.77	55.78	-37.01	AVG	P
3	0.1620	-0.02	29.75	29.73	65.36	-35.63	QP	P
4	0.1620	-0.02	15.30	15.28	55.36	-40.08	AVG	P
5	0.2040	-0.02	20.21	20.19	63.44	-43.25	QP	P
6	0.2040	-0.02	11.57	11.55	53.44	-41.89	AVG	P
7	0.5620	-0.04	25.27	25.23	56.00	-30.77	QP	P
8	0.5620	-0.04	14.79	14.75	46.00	-31.25	AVG	P
9	2.7980	-0.11	18.19	18.08	56.00	-37.92	QP	P
10	2.7980	-0.11	13.79	13.68	46.00	-32.32	AVG	P
11	6.5060	-0.16	23.28	23.12	60.00	-36.88	QP	P
12	6.5060	-0.16	17.17	17.01	50.00	-32.99	AVG	P

Note: Level = Reading + Factor
Margin = Level – Limit



Power	: AC 120V	Pol/Phase	: NEUTRAL
Test Mode	: Mode 3	Temperature	: 26 °C
Test date	: Sep. 01, 2015	Humidity	: 48 %
Memo	:	Atmospheric Pressure	: 1008 hpa

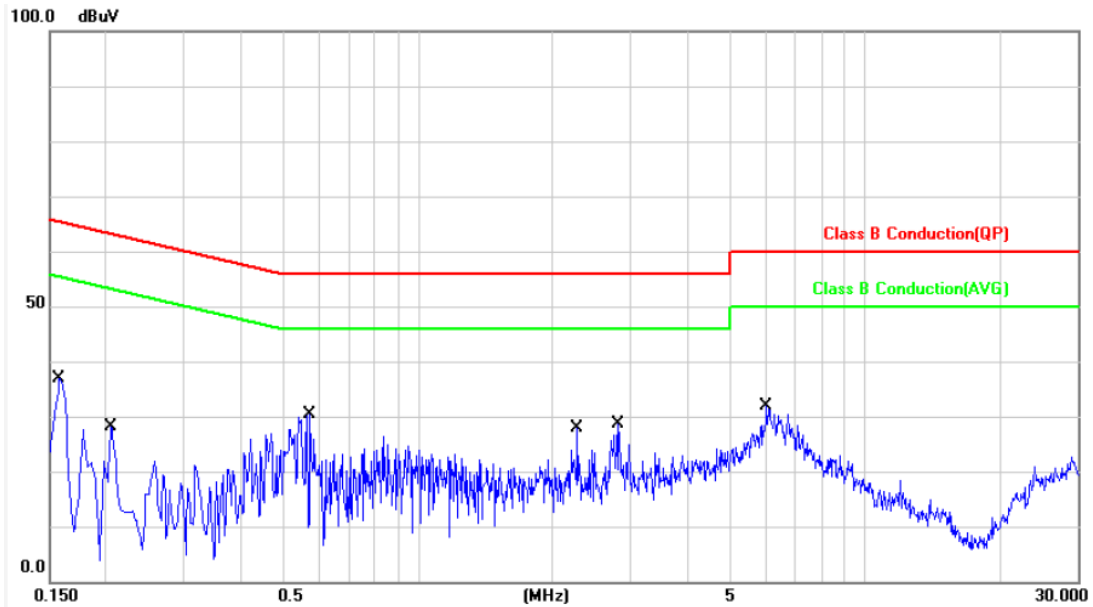

No.	Frequency (MHz)	Factor (dB)	Reading (dBuV)	Level (dBuV)	Limit (dBuV)	Margin (dB)	Detector	P/F
1	0.1580	-0.02	33.67	33.65	65.56	-31.91	QP	P
2	0.1580	-0.02	21.81	21.79	55.56	-33.77	AVG	P
3	0.2060	-0.02	25.35	25.33	63.36	-38.03	QP	P
4	0.2060	-0.02	10.33	10.31	53.36	-43.05	AVG	P
5	0.5740	-0.04	26.84	26.80	56.00	-29.20	QP	P
6	0.5740	-0.04	13.97	13.93	46.00	-32.07	AVG	P
7	2.2820	-0.10	26.21	26.11	56.00	-29.89	QP	P
8	2.2820	-0.10	14.00	13.90	46.00	-32.10	AVG	P
9	2.7980	-0.11	27.57	27.46	56.00	-28.54	QP	P
10	2.7980	-0.11	16.00	15.89	46.00	-30.11	AVG	P
11	6.0260	-0.16	25.98	25.82	60.00	-34.18	QP	P
12	6.0260	-0.16	18.08	17.92	50.00	-32.08	AVG	P

Note: Level = Reading + Factor
Margin = Level – Limit



6. Test of Spurious Emission (Radiated)

6.1 Test Limit

Radiated emissions from 30 MHz to 25 GHz were measured according to the methods defines in ANSI C63.4-2009. The EUT was placed, 0.8 meter above the ground plane, as shown in section 5.6.3. The interface cables and equipment positions were varied within limits of reasonable applications to determine the positions producing maximum radiated emissions For unintentional device, according to § 15.109(a), except for Class A digital devices, the field strength of radiated emissions from unintentional radiators at a distance of 3 meters shall not exceed the following values:

Frequency (MHz)	Distance Meters	Radiated (μ V / M)	Radiated (dB μ V / M)
30-88	3	100	40.0
88-216	3	150	43.5
216-960	3	200	46.0
Above 960	3	500	54.0

For unintentional device, according to CISPR PUB.22, for Class B digital devices, the general requirement of field strength of radiated emissions from intentional radiators at a distance of 10 meters shall not exceed the above table.

Frequency (MHz)	Distance Meters	Radiated (dB μ V / M)
30-230	10	30
230-1000	10	37

6.2 Test Procedures

- The EUT was placed on a rotatable table top 0.8 meter above ground.
- The EUT was set 3 meters from the interference receiving antenna which was mounted on the top of a variable height antenna tower.
- The table was rotated 360 degrees to determine the position of the highest radiation.
- The antenna is a broadband antenna and its height is varied between one meter and four meters above ground to find the maximum value of the field strength both horizontal polarization and vertical polarization of the antenna are set to make the measurement.
- For each suspected emission the EUT was arranged to its worst case and then tune the antenna tower (from 1 M to 4 M) and turn table (from 0 degree to 360 degrees) to find the maximum reading.
- Set the test-receiver system to Peak or CISPR quasi-peak Detect Function and specified bandwidth with Maximum Hold Mode.
- If the emission level of the EUT in peak mode was 3 dB lower than the limit specified, then testing will be stopped and peak values of EUT will be reported, otherwise, the emissions which do not have 3 dB margin will be repeated one by one using the quasi-peak method and reported.
- For testing above 1GHz, the emission level of the EUT in peak mode was 20dB lower than average limit (that means the emission level in peak mode also complies with the limit in average mode), then testing will be stopped and peak values of EUT will be reported, otherwise, the emissions will be measured in average mode again and reported.



6.3 Typical Test Setup

Below 30MHz test setup

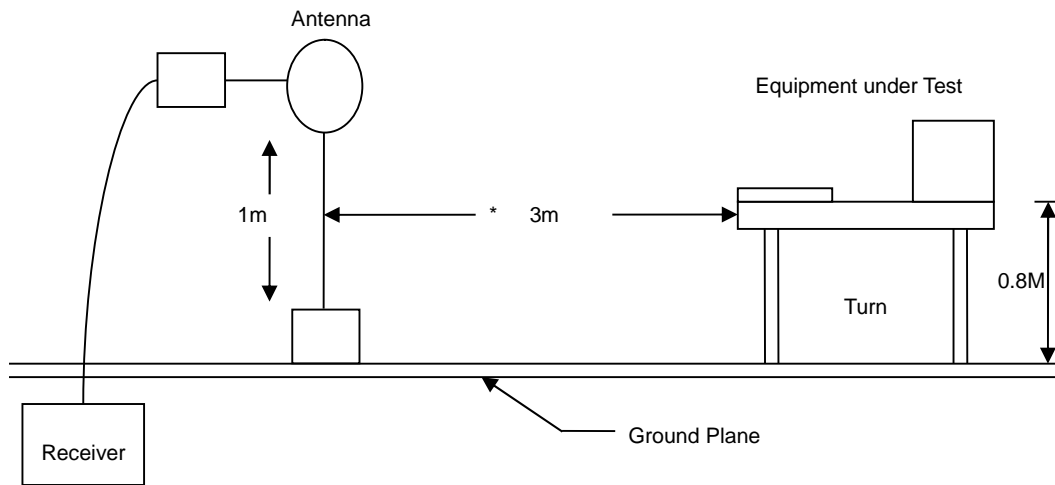

30MHz- 1GHz Test Setup

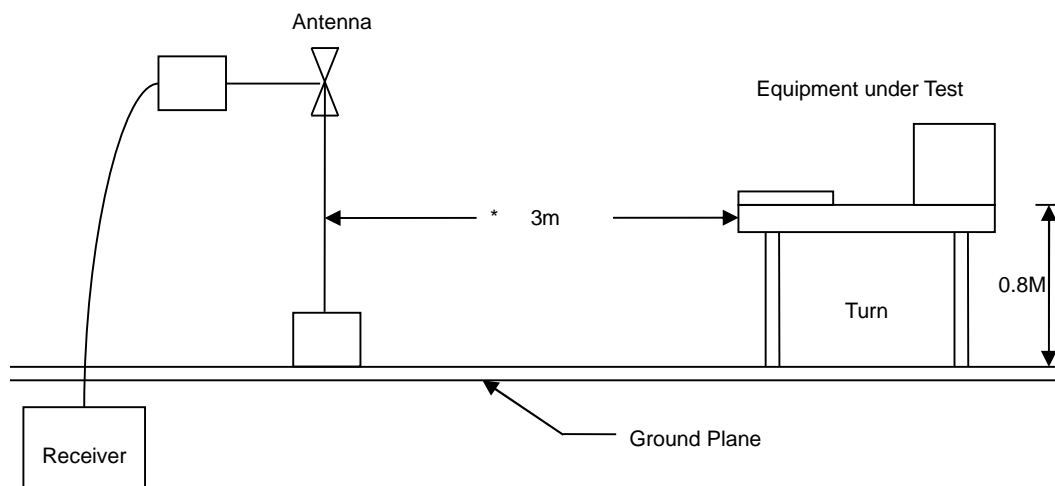

Above 1GHz Test Setup

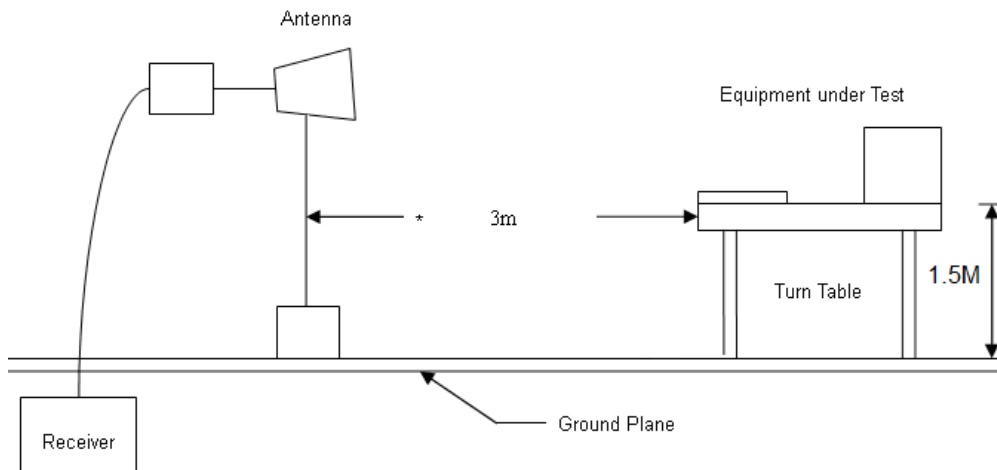



6.4 Test Result and Data (9kHz ~ 30MHz)

The 9kHz-30MHz spurious emission is under limit 20dB more.

6.5 Test Result and Data (30MHz ~ 1GHz)

6.5.1 Test Result and Data of Transmitter

Power	: AC 120V	Pol/Phase	: VERTICAL
Test Mode	: Mode 1	Temperature	: 18 °C
Test Date	: Sep. 01, 2015	Humidity	: 49 %
Memo	: CH 00	Atmospheric Pressure	: 1008 hpa

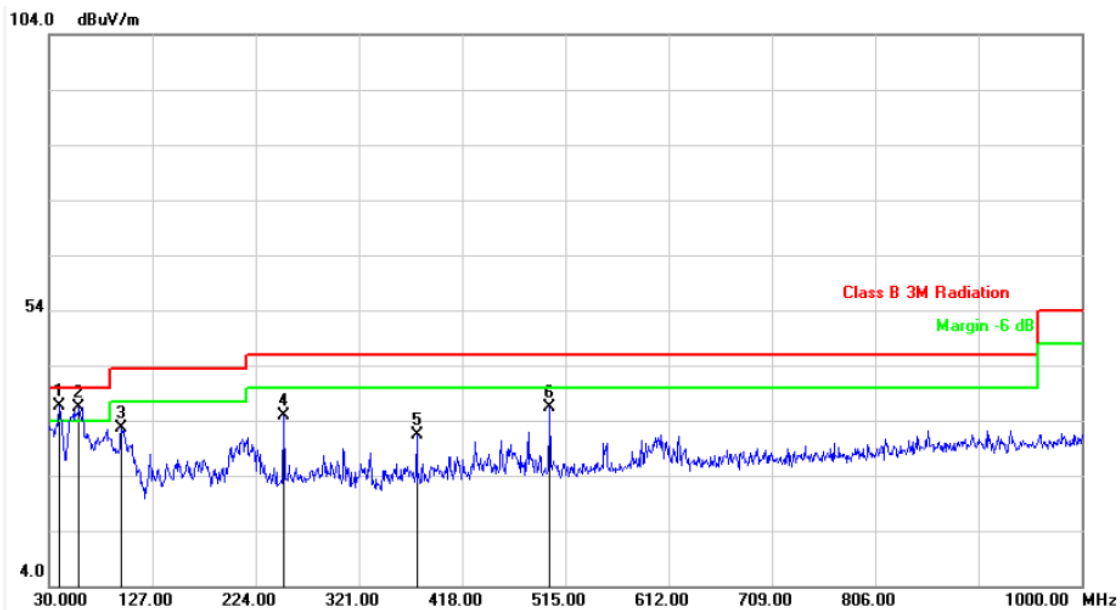

No.	Frequency (MHz)	Factor (dB/m)	Reading (dBuV)	Level (dBuV/m)	Limit (dBuV/m)	Margin (dB)	Detector	Height (cm)	Azimuth (°)	P/F
1	39.7000	-7.53	44.22	36.69	40.00	-3.31	peak	104	186	P
2	58.1300	-8.06	44.40	36.34	40.00	-3.66	peak	104	186	P
3	97.9000	-12.80	45.33	32.53	43.50	-10.97	peak	104	186	P
4	250.1900	-8.34	43.25	34.91	46.00	-11.09	peak	104	186	P
5	375.3200	-4.39	35.69	31.30	46.00	-14.70	peak	104	186	P
6	500.4500	-1.37	37.76	36.39	46.00	-9.61	peak	104	186	P

Note: Level = Reading + Factor
 Margin = Level – Limit
 Factor= Antenna Factor + Cable Loss - Amplifier Factor



Power	: AC 120V	Pol/Phase	: HORIZONTAL
Test Mode	: Mode 1	Temperature	: 18 °C
Test Date	: Sep. 01, 2015	Humidity	: 49 %
Memo	: CH 00	Atmospheric Pressure	: 1008 hpa

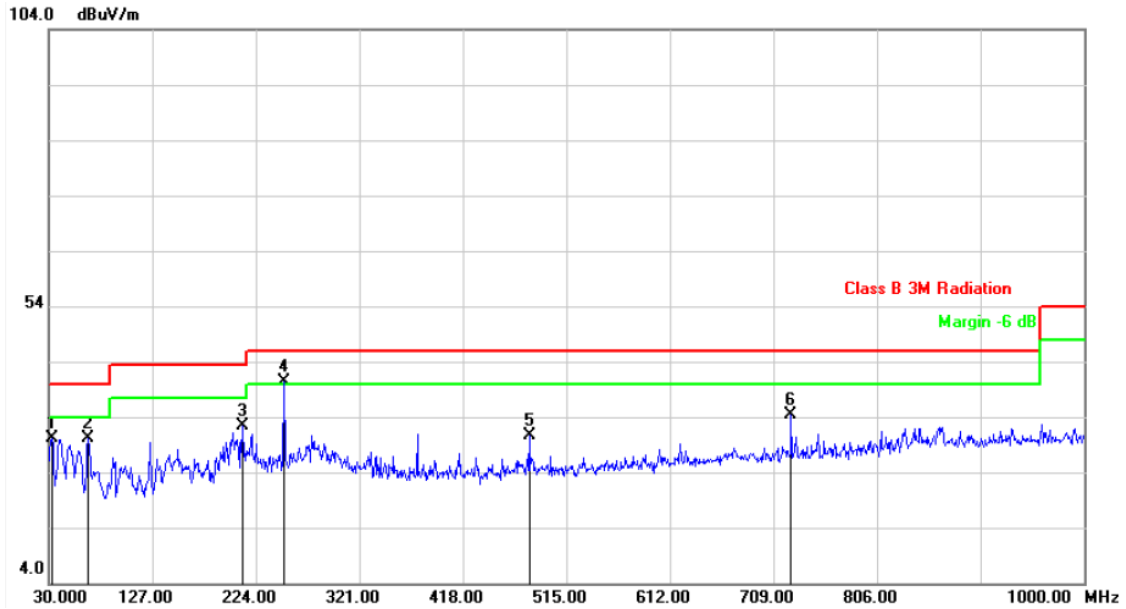

No.	Frequency (MHz)	Factor (dB/m)	Reading (dBuV)	Level (dBuV/m)	Limit (dBuV/m)	Margin (dB)	Detector	Height (cm)	Azimuth (°)	P/F
1	32.9100	-7.94	38.02	30.08	40.00	-9.92	peak	104	186	P
2	66.8600	-9.44	39.49	30.05	40.00	-9.95	peak	104	186	P
3	211.3900	-10.13	42.47	32.34	43.50	-11.16	peak	104	186	P
4	250.1900	-8.34	48.81	40.47	46.00	-5.53	peak	104	186	P
5	480.0800	-1.79	32.43	30.64	46.00	-15.36	peak	104	186	P
6	725.4900	2.42	32.08	34.50	46.00	-11.50	peak	104	186	P

Note: Level = Reading + Factor
 Margin = Level – Limit
 Factor= Antenna Factor + Cable Loss - Amplifier Factor



6.5.2 Test Result and Data of Receiver

Power	: AC 120V	Pol/Phase	: VERTICAL
Test Mode	: Mode 1	Temperature	: 18 °C
Test Date	: Sep. 01, 2015	Humidity	: 49 %
Memo	: CH 00	Atmospheric Pressure	: 1008 hpa

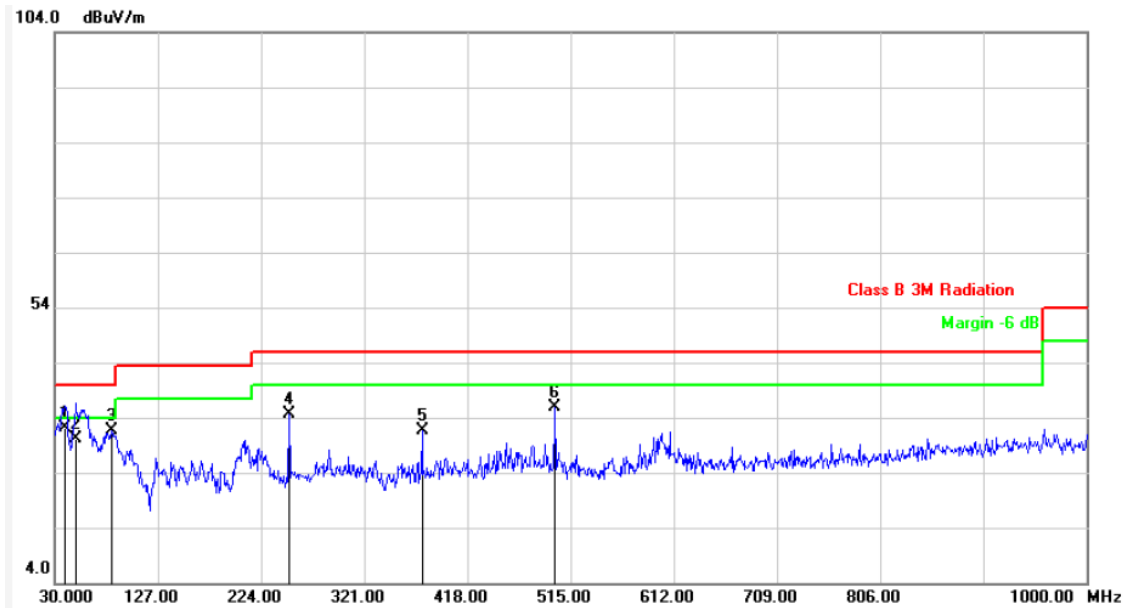

No.	Frequency (MHz)	Factor (dB/m)	Reading (dBuV)	Level (dBuV/m)	Limit (dBuV/m)	Margin (dB)	Detector	Height (cm)	Azimuth (°)	P/F
1	39.7000	-7.53	39.63	32.10	40.00	-7.90	QP	101	179	P
2	49.4000	-7.20	37.40	30.20	40.00	-9.80	QP	101	179	P
3	83.3500	-12.62	44.20	31.58	40.00	-8.42	peak	101	179	P
4	250.1900	-8.34	42.99	34.65	46.00	-11.35	peak	101	179	P
5	375.3200	-4.39	36.12	31.73	46.00	-14.27	peak	101	179	P
6	500.4500	-1.37	37.13	35.76	46.00	-10.24	peak	101	179	P

Note: Level = Reading + Factor
 Margin = Level – Limit
 Factor= Antenna Factor + Cable Loss - Amplifier Factor



Power	: AC 120V	Pol/Phase	: HORIZONTAL
Test Mode	: Mode 1	Temperature	: 18 °C
Test Date	: Sep. 01, 2015	Humidity	: 49 %
Memo	: CH 00	Atmospheric Pressure	: 1008 hpa

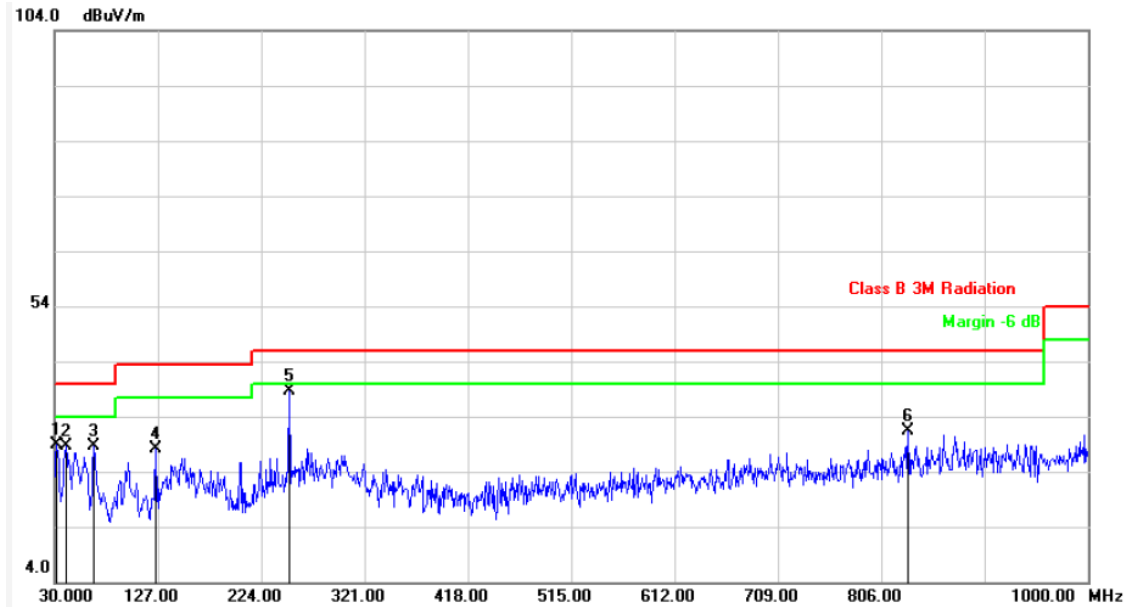

No.	Frequency (MHz)	Factor (dB/m)	Reading (dBuV)	Level (dBuV/m)	Limit (dBuV/m)	Margin (dB)	Detector	Height (cm)	Azimuth (°)	P/F
1	31.9400	-7.97	36.91	28.94	40.00	-11.06	peak	101	179	P
2	40.6699	-7.45	36.19	28.74	40.00	-11.26	peak	101	179	P
3	66.8600	-9.44	38.02	28.58	40.00	-11.42	peak	101	179	P
4	125.0600	-8.98	37.05	28.07	43.50	-15.43	peak	101	179	P
5	250.1900	-8.34	47.01	38.67	46.00	-7.33	peak	101	179	P
6	831.2199	3.95	27.55	31.50	46.00	-14.50	peak	101	179	P

Note: Level = Reading + Factor
 Margin = Level – Limit
 Factor= Antenna Factor + Cable Loss - Amplifier Factor



6.6 Test Result and Data (1GHz~25GHz)

6.6.1 Test Result and Data of Transmitter

Power	: AC 120V	Pol/Phase	: VERTICAL
Test Mode	: Mode 1	Temperature	: 21.5 °C
Test Date	: Sep. 01, 2015	Humidity	: 49 %
Memo	: CH 00	Atmospheric Pressure	: 1008 hpa

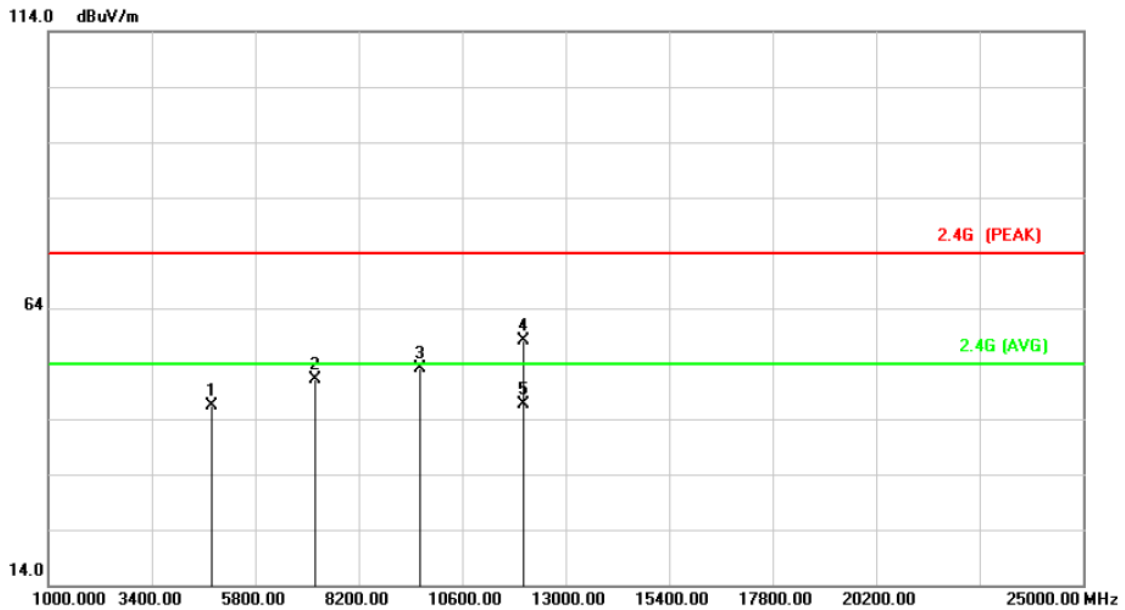

No.	Frequency (MHz)	Factor (dB/m)	Reading (dBuV)	Level (dBuV/m)	Limit (dBuV/m)	Margin (dB)	Detector	Height (cm)	Azimuth (°)	P/F
1	4804.000	7.85	38.49	46.34	74.00	-27.66	peak	101	185	P
2	7206.000	13.01	38.15	51.16	74.00	-22.84	peak	101	185	P
3	9608.000	16.37	36.76	53.13	74.00	-20.87	peak	101	185	P
4	12010.000	20.20	37.94	58.14	74.00	-15.86	peak	101	185	P
5	12010.000	20.20	26.35	46.55	54.00	-7.45	AVG	101	185	P

Note: Level = Reading + Factor
 Margin = Level – Limit
 Factor= Antenna Factor + Cable Loss - Amplifier Factor



Power	: AC 120V	Pol/Phase	: HORIZONTAL
Test Mode	: Mode 1	Temperature	: 21.5 °C
Test Date	: Sep. 01, 2015	Humidity	: 49 %
Memo	: CH 00	Atmospheric Pressure	: 1008 hpa

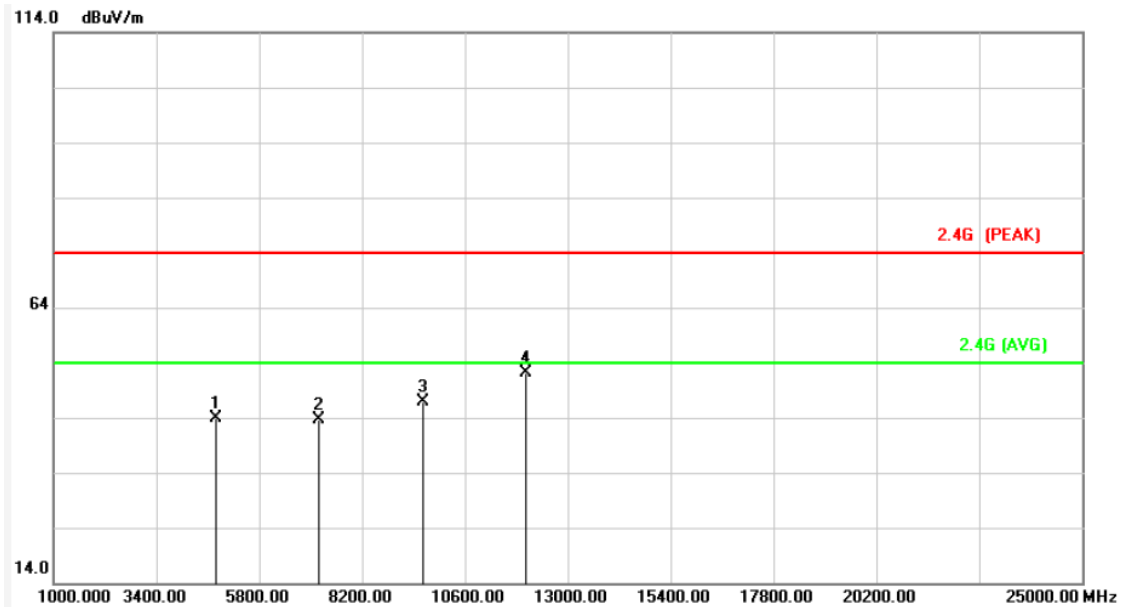

No.	Frequency (MHz)	Factor (dB/m)	Reading (dBuV)	Level (dBuV/m)	Limit (dBuV/m)	Margin (dB)	Detector	Height (cm)	Azimuth (°)	P/F
1	4804.000	7.85	36.12	43.97	74.00	-30.03	peak	101	185	P
2	7206.000	13.01	30.53	43.54	74.00	-30.46	peak	101	185	P
3	9608.000	16.37	30.62	46.99	74.00	-27.01	peak	101	185	P
4	12010.000	20.20	31.96	52.16	74.00	-21.84	peak	101	185	P

Note: Level = Reading + Factor

Margin = Level – Limit

Factor= Antenna Factor + Cable Loss - Amplifier Factor.



Power	: AC 120V	Pol/Phase	: VERTICAL
Test Mode	: Mode 1	Temperature	: 21.5 °C
Test Date	: Sep. 01, 2015	Humidity	: 49 %
Memo	: CH 39	Atmospheric Pressure	: 1008 hpa

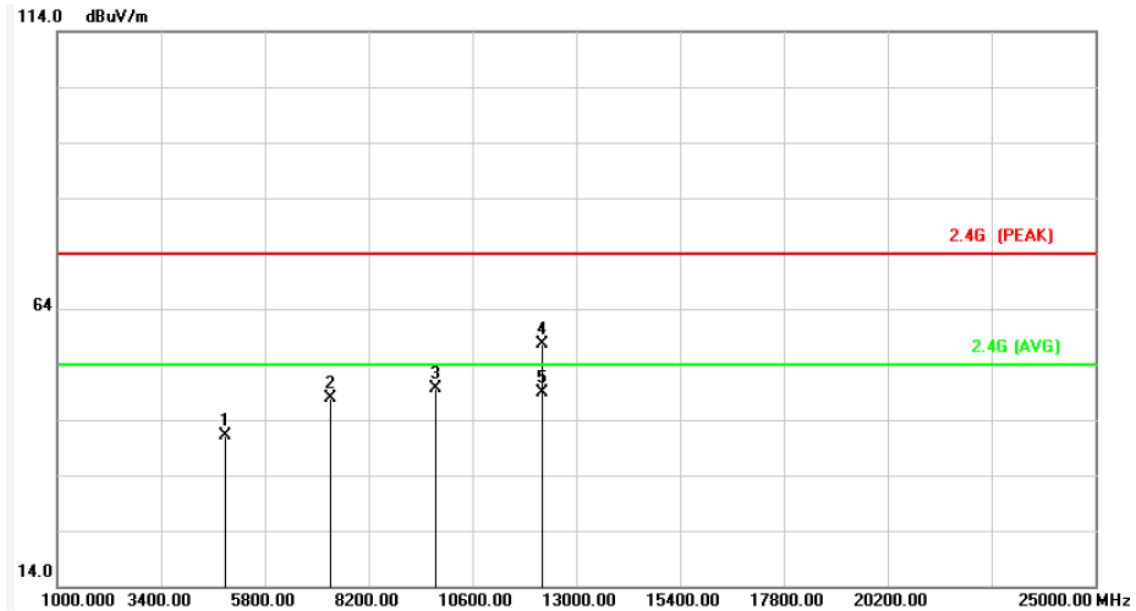

No.	Frequency (MHz)	Factor (dB/m)	Reading (dBuV)	Level (dBuV/m)	Limit (dBuV/m)	Margin (dB)	Detector	Height (cm)	Azimuth (°)	P/F
1	4880.000	8.09	33.06	41.15	74.00	-32.85	peak	100	187	P
2	7320.000	13.41	34.54	47.95	74.00	-26.05	peak	100	187	P
3	9760.000	16.60	32.93	49.53	74.00	-24.47	peak	100	187	P
4	12200.000	20.22	37.39	57.61	74.00	-16.39	peak	100	187	P
5	12200.000	20.22	28.60	48.82	54.00	-5.18	AVG	100	187	P

Note: Level = Reading + Factor
 Margin = Level – Limit
 Factor= Antenna Factor + Cable Loss - Amplifier Factor



Power	: AC 120V	Pol/Phase	: HORIZONTAL
Test Mode	: Mode 1	Temperature	: 21.5 °C
Test Date	: Sep. 01, 2015	Humidity	: 49 %
Memo	: CH 39	Atmospheric Pressure	: 1008 hpa

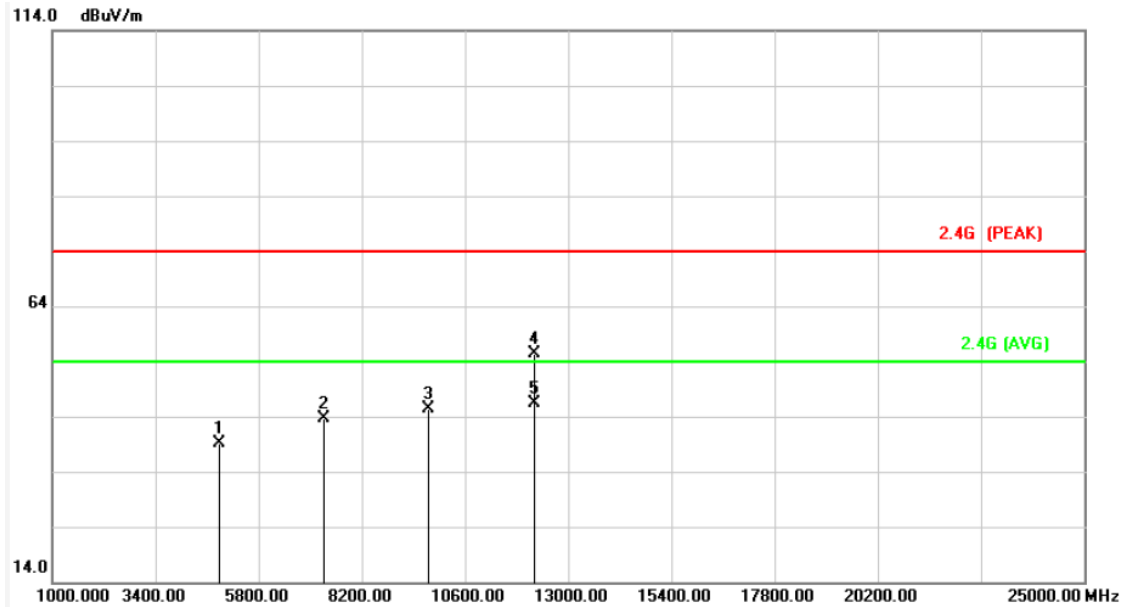

No.	Frequency (MHz)	Factor (dB/m)	Reading (dBuV)	Level (dBuV/m)	Limit (dBuV/m)	Margin (dB)	Detector	Height (cm)	Azimuth (°)	P/F
1	4880.000	8.09	31.16	39.25	74.00	-34.75	peak	100	187	P
2	7320.000	13.41	30.34	43.75	74.00	-30.25	peak	100	187	P
3	9760.000	16.60	28.68	45.28	74.00	-28.72	peak	100	187	P
4	12200.000	20.22	35.10	55.32	74.00	-18.68	peak	100	187	P
5	12200.000	20.22	26.16	46.38	54.00	-7.62	AVG	100	187	P

Note: Level = Reading + Factor
 Margin = Level – Limit
 Factor= Antenna Factor + Cable Loss - Amplifier Factor.



Power	: AC 120V	Pol/Phase	: VERTICAL
Test Mode	: Mode 1	Temperature	: 21.5 °C
Test Date	: Sep. 01, 2015	Humidity	: 49 %
Memo	: CH 78	Atmospheric Pressure	: 1008 hpa

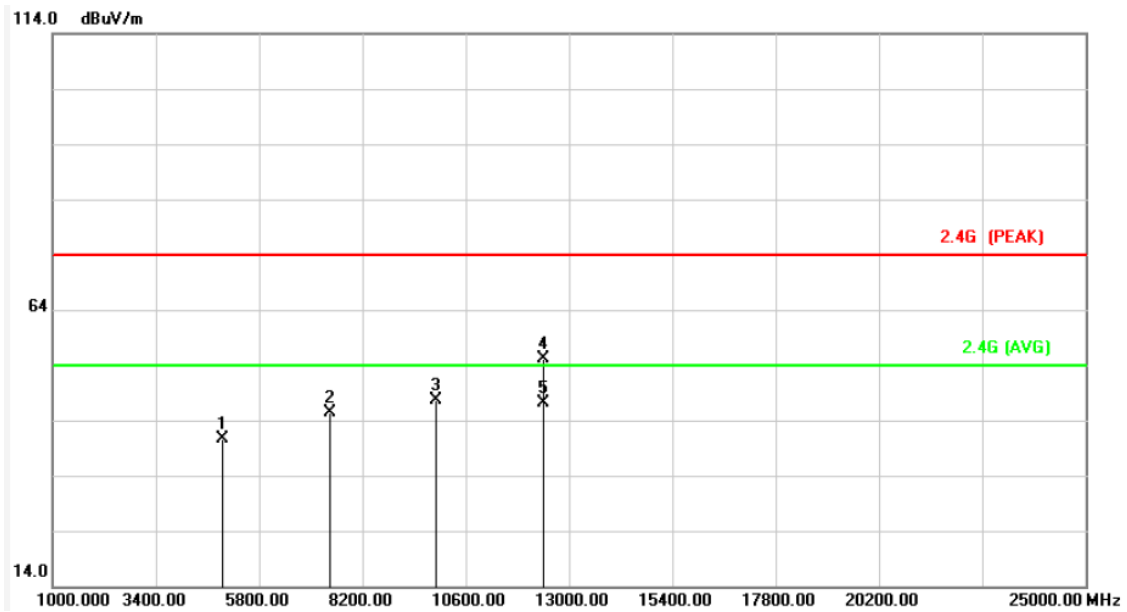

No.	Frequency (MHz)	Factor (dB/m)	Reading (dBuV)	Level (dBuV/m)	Limit (dBuV/m)	Margin (dB)	Detector	Height (cm)	Azimuth (°)	P/F
1	4960.000	8.34	32.35	40.69	74.00	-33.31	peak	103	186	P
2	7440.000	13.84	31.64	45.48	74.00	-28.52	peak	103	186	P
3	9920.000	16.84	30.81	47.65	74.00	-26.35	peak	103	186	P
4	12400.000	20.25	34.81	55.06	74.00	-18.94	peak	103	186	P
5	12400.000	20.25	26.97	47.22	54.00	-6.78	AVG	103	186	P

Note: Level = Reading + Factor
 Margin = Level – Limit
 Factor= Antenna Factor + Cable Loss - Amplifier Factor



Power	: AC 120V	Pol/Phase	: HORIZONTAL
Test Mode	: Mode 1	Temperature	: 21.5 °C
Test Date	: Sep. 01, 2015	Humidity	: 49 %
Memo	: CH 78	Atmospheric Pressure	: 1008 hpa

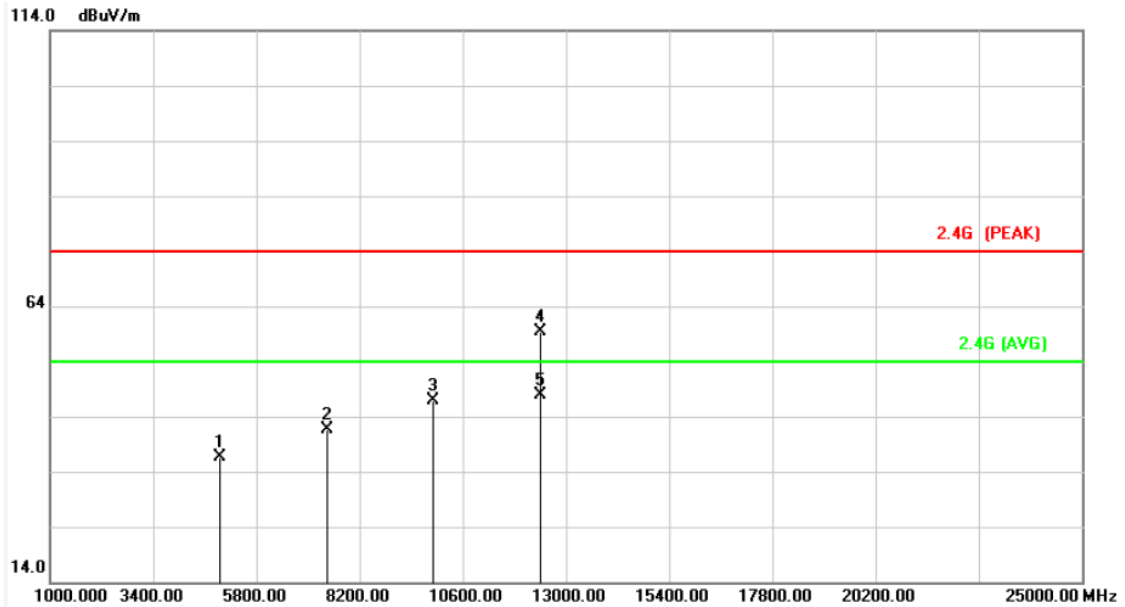

No.	Frequency (MHz)	Factor (dB/m)	Reading (dBuV)	Level (dBuV/m)	Limit (dBuV/m)	Margin (dB)	Detector	Height (cm)	Azimuth (°)	P/F
1	4960.000	8.34	28.24	36.58	74.00	-37.42	peak	103	186	P
2	7440.000	13.84	27.82	41.66	74.00	-32.34	peak	103	186	P
3	9920.000	16.84	30.03	46.87	74.00	-27.13	peak	103	186	P
4	12400.000	20.25	39.20	59.45	74.00	-14.55	peak	103	186	P
5	12400.000	20.25	27.57	47.82	54.00	-6.18	AVG	103	186	P

Note: Level = Reading + Factor
 Margin = Level – Limit
 Factor= Antenna Factor + Cable Loss - Amplifier Factor.



6.6.2 Test Result and Data of Receiver

Power	: AC 120V	Pol/Phase	: VERTICAL
Test Mode	: Mode 1	Temperature	: 21.5 °C
Test Date	: Sep. 01, 2015	Humidity	: 49 %
Memo	: CH 00	Atmospheric Pressure	: 1008 hpa

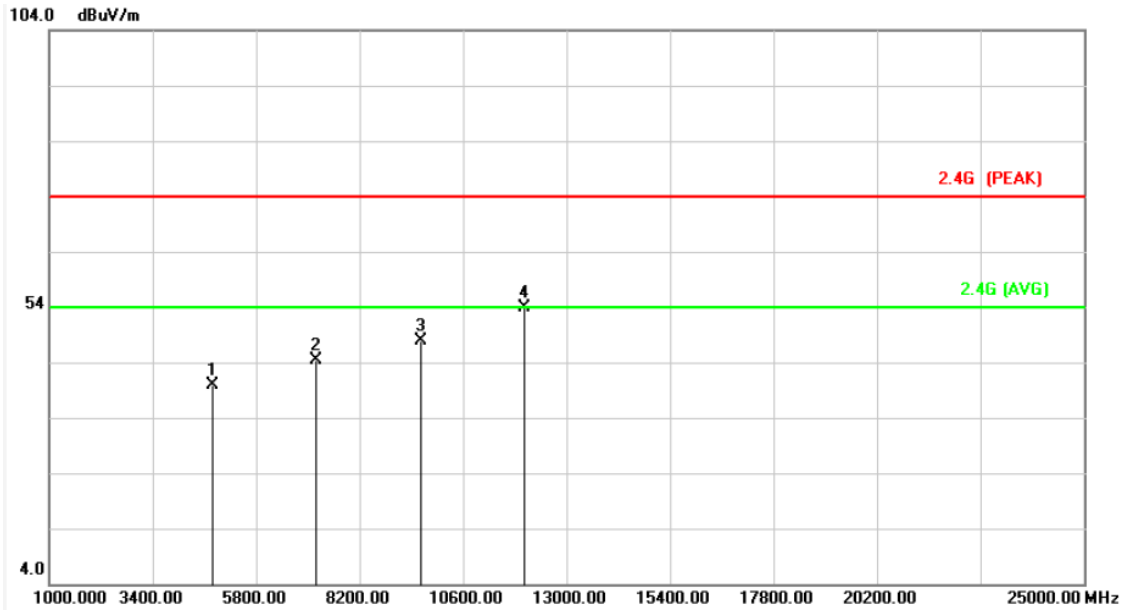

No.	Frequency (MHz)	Factor (dB/m)	Reading (dBuV)	Level (dBuV/m)	Limit (dBuV/m)	Margin (dB)	Detector	Height (cm)	Azimuth (°)	P/F
1	4804.000	7.85	31.97	39.82	74.00	-34.18	peak	100	186	P
2	7206.000	13.01	31.36	44.37	74.00	-29.63	peak	100	186	P
3	9608.000	16.37	31.40	47.77	74.00	-26.23	peak	100	186	P
4	12010.000	20.20	33.69	53.89	74.00	-20.11	peak	100	186	P

Note: Level = Reading + Factor
Margin = Level – Limit
Factor= Antenna Factor + Cable Loss - Amplifier Factor



Power	: AC 120V	Pol/Phase	: HORIZONTAL
Test Mode	: Mode 1	Temperature	: 21.5 °C
Test Date	: Sep. 01, 2015	Humidity	: 49 %
Memo	: CH 00	Atmospheric Pressure	: 1008 hpa

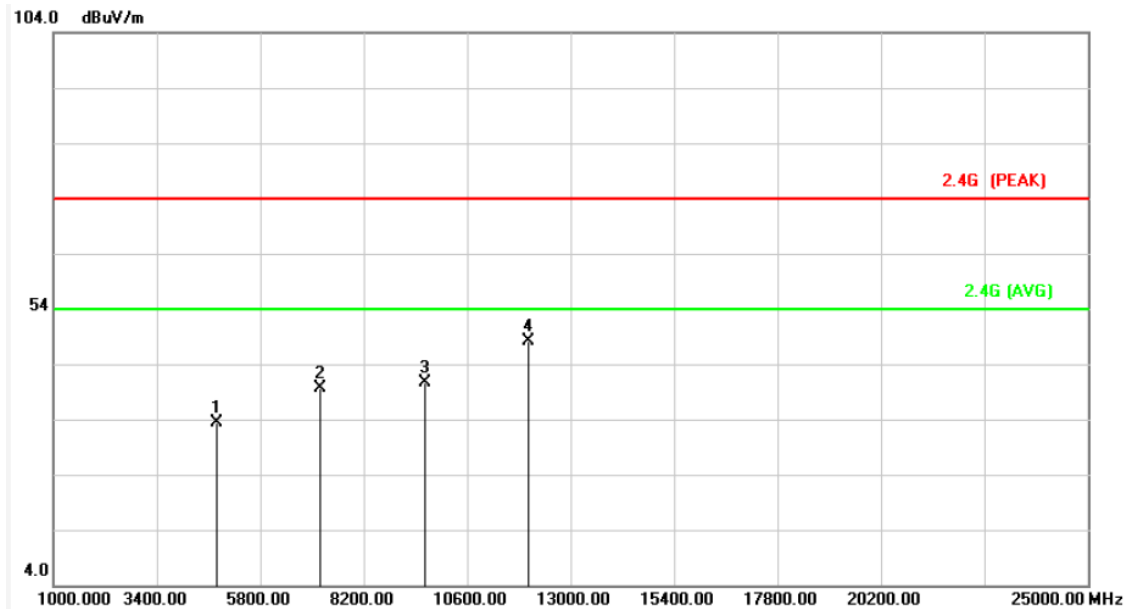

No.	Frequency (MHz)	Factor (dB/m)	Reading (dBuV)	Level (dBuV/m)	Limit (dBuV/m)	Margin (dB)	Detector	Height (cm)	Azimuth (°)	P/F
1	4804.000	7.85	25.60	33.45	74.00	-40.55	peak	100	186	P
2	7206.000	13.01	26.62	39.63	74.00	-34.37	peak	100	186	P
3	9608.000	16.37	24.30	40.67	74.00	-33.33	peak	100	186	P
4	12010.000	20.20	28.03	48.23	74.00	-25.77	peak	100	186	P

Note: Level = Reading + Factor

Margin = Level – Limit

Factor= Antenna Factor + Cable Loss - Amplifier Factor.



Power	: AC 120V	Pol/Phase	: VERTICAL
Test Mode	: Mode 1	Temperature	: 21.5 °C
Test Date	: Sep. 01, 2015	Humidity	: 49 %
Memo	: CH 39	Atmospheric Pressure	: 1008 hpa

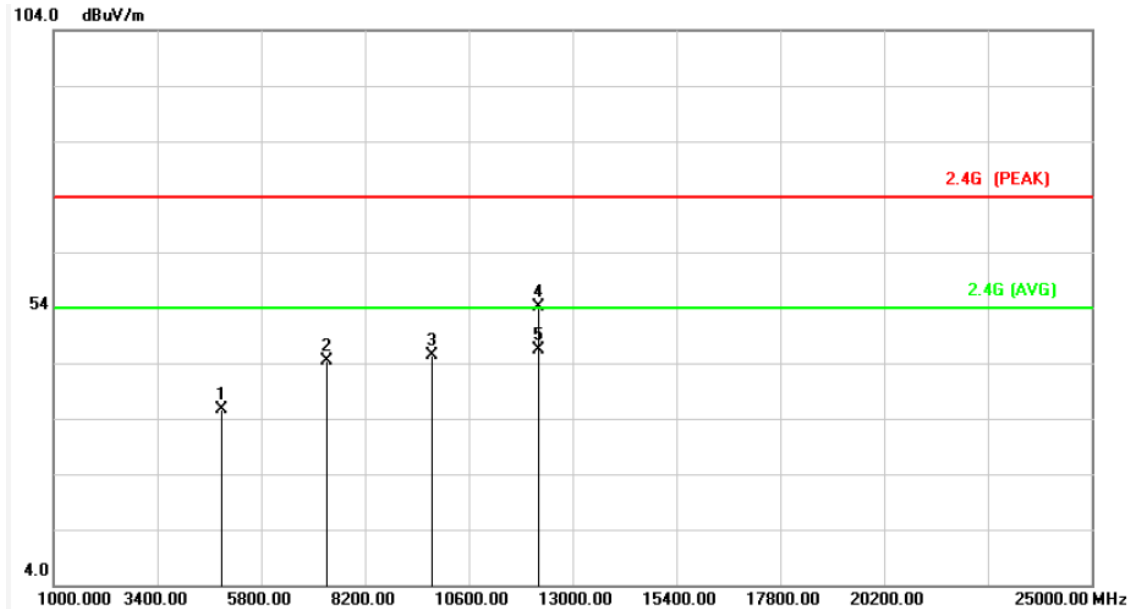

No.	Frequency (MHz)	Factor (dB/m)	Reading (dBuV)	Level (dBuV/m)	Limit (dBuV/m)	Margin (dB)	Detector	Height (cm)	Azimuth (°)	P/F
1	4882.000	8.10	27.61	35.71	74.00	-38.29	peak	105	178	P
2	7323.000	13.43	30.92	44.35	74.00	-29.65	peak	105	178	P
3	9764.000	16.61	28.70	45.31	74.00	-28.69	peak	105	178	P
4	12205.000	20.23	34.01	54.24	74.00	-19.76	peak	105	178	P
5	12205.000	20.23	26.14	46.37	54.00	-7.63	AVG	105	178	P

Note: Level = Reading + Factor
 Margin = Level – Limit
 Factor= Antenna Factor + Cable Loss - Amplifier Factor



Power	: AC 120V	Pol/Phase	: HORIZONTAL
Test Mode	: Mode 1	Temperature	: 21.5 °C
Test Date	: Sep. 01, 2015	Humidity	: 49 %
Memo	: CH 39	Atmospheric Pressure	: 1008 hpa

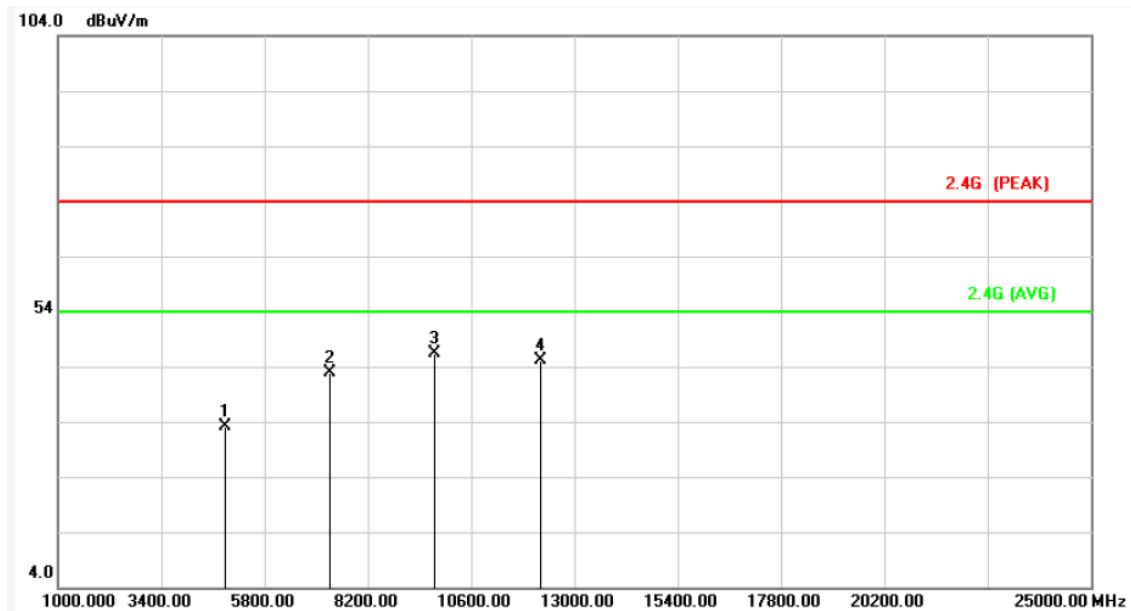

No.	Frequency (MHz)	Factor (dB/m)	Reading (dBuV)	Level (dBuV/m)	Limit (dBuV/m)	Margin (dB)	Detector	Height (cm)	Azimuth (°)	P/F
1	4882.000	8.10	25.05	33.15	74.00	-40.85	peak	105	178	P
2	7323.000	13.43	29.36	42.79	74.00	-31.21	peak	102	178	P
3	9764.000	16.61	29.71	46.32	74.00	-27.68	peak	105	178	P
4	12205.000	20.23	24.93	45.16	74.00	-28.84	peak	105	178	P

Note: Level = Reading + Factor
 Margin = Level – Limit
 Factor= Antenna Factor + Cable Loss - Amplifier Factor.



Power	: AC 120V	Pol/Phase	: VERTICAL
Test Mode	: Mode 1	Temperature	: 21.5 °C
Test Date	: Sep. 01, 2015	Humidity	: 49 %
Memo	: CH 78	Atmospheric Pressure	: 1008 hpa

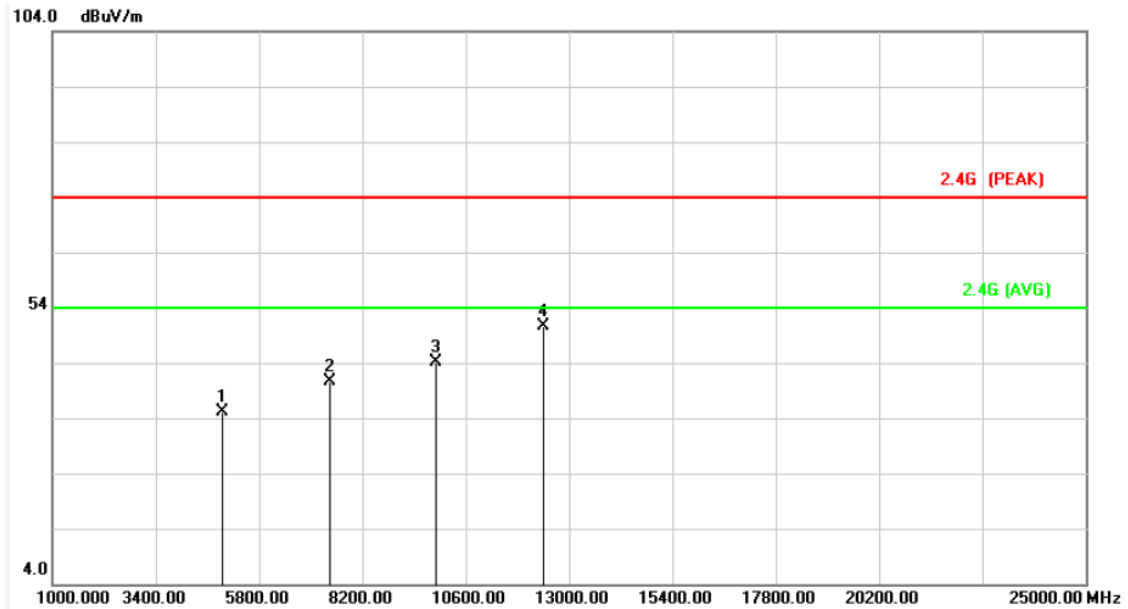

No.	Frequency (MHz)	Factor (dB/m)	Reading (dBuV)	Level (dBuV/m)	Limit (dBuV/m)	Margin (dB)	Detector	Height (cm)	Azimuth (°)	P/F
1	4960.000	8.34	26.86	35.20	74.00	-38.80	peak	104	187	P
2	7440.000	13.84	26.71	40.55	74.00	-33.45	peak	104	187	P
3	9920.000	16.84	27.35	44.19	74.00	-29.81	peak	104	187	P
4	12400.000	20.25	30.37	50.62	74.00	-23.38	peak	104	187	P

Note: Level = Reading + Factor
 Margin = Level – Limit
 Factor= Antenna Factor + Cable Loss - Amplifier Factor



Power	: AC 120V	Pol/Phase	: HORIZONTAL
Test Mode	: Mode 1	Temperature	: 21.5 °C
Test Date	: Sep. 01, 2015	Humidity	: 49 %
Memo	: CH 78	Atmospheric Pressure	: 1008 hpa

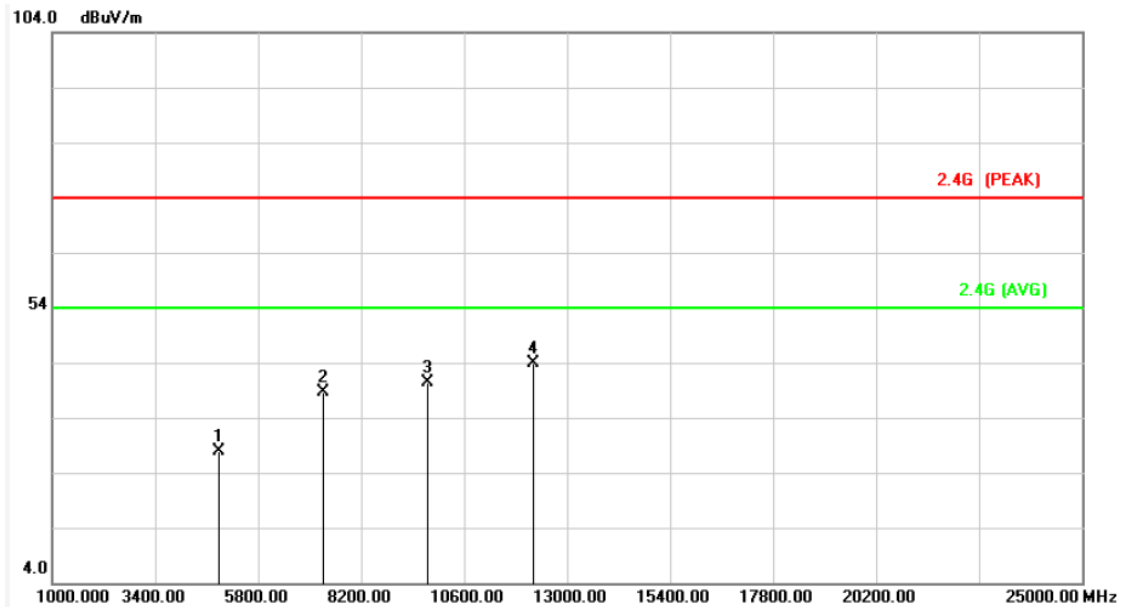

No.	Frequency (MHz)	Factor (dB/m)	Reading (dBuV)	Level (dBuV/m)	Limit (dBuV/m)	Margin (dB)	Detector	Height (cm)	Azimuth (°)	P/F
1	4882.000	8.10	19.85	27.95	74.00	-46.05	peak	104	187	P
2	7323.000	13.43	25.10	38.53	74.00	-35.47	peak	104	187	P
3	9764.000	16.61	23.75	40.36	74.00	-33.64	peak	104	187	P
4	12205.000	20.23	23.77	44.00	74.00	-30.00	peak	104	187	P

Note: Level = Reading + Factor
 Margin = Level – Limit
 Factor= Antenna Factor + Cable Loss - Amplifier Factor.



6.7 Restricted Bands of Operation

Only spurious emissions are permitted in any of the frequency bands listed below:

MHz	MHz	MHz	GHz
0.09000 – 0.11000	16.42000 – 16.42300	399.9 – 410.0	4.500 – 5.250
0.49500 – 0.505**	16.69475 – 16.69525	608.0 – 614.0	5.350 – 5.460
2.17350 – 2.19050	16.80425 – 16.80475	960.0 – 1240.0	7.250 – 7.750
4.12500 – 4.12800	25.50000 – 25.67000	1300.0 – 1427.0	8.025 – 8.500
4.17725 – 4.17775	37.50000 – 38.25000	1435.0 – 1626.5	9.000 – 9.200
4.20725 – 4.20775	73.00000 – 74.60000	1645.5 – 1646.5	9.300 – 9.500
6.21500 – 6.21800	74.80000 – 75.20000	1660.0 – 1710.0	10.600 – 12.700
6.26775 – 6.26825	108.00000 – 121.94000	1718.8 – 1722.2	13.250 – 13.400
6.31175 – 6.31225	123.00000 – 138.00000	2200.0 – 2300.0	14.470 – 14.500
8.29100 – 8.29400	149.90000 – 150.05000	2310.0 – 2390.0	15.350 – 16.200
8.36200 – 8.36600	156.52475 – 156.52525	2483.5 – 2500.0	17.700 – 21.400
8.37625 – 8.38675	156.70000 – 156.90000	2655.0 – 2900.0	22.010 – 23.120
8.41425 – 8.41475	162.01250 – 167.17000	3260.0 – 3267.0	23.600 – 24.000
12.29000 – 12.29300	167.72000 – 173.20000	3332.0 – 3339.0	31.200 – 31.800
12.51975 – 12.52025	240.00000 – 285.00000	3345.8 – 3358.0	36.430 – 36.500
12.57675 – 12.57725	322.00000 – 335.40000	3600.0 – 4400.0	Above 38.6
13.36000 – 13.41000			

** : Until February 1, 1999, this restricted band shall be 0.490-0.510 MHz



6.8 Restrict band emission Measurement Data

Test Date: Sep. 01, 2015

Temperature: 21.5 °C

Atmospheric pressure: 1008 hPa

Humidity: 49 %

Modulation Standard: GFSK

Channel 0						Fundamental Frequency: 2402 MHz				
Frequency (MHz)	Ant-Pol H/V	Meter Reading	Corrected Factor	Result (dBuV/m)	Remark	Limit@3m (dBuV/m)		Margin (dB)	Table (Deg.)	Ant High (m)
						Peak	Ave.			
2372.652	V	47.75	-1.05	46.70	Peak	74	54	-27.30	187	1.03
---	V	---	---	---	Ave	74	54	---	---	---
2325.916	H	47.75	-1.23	46.52	Peak	74	54	-27.48	187	1.03
---	H	---	---	---	Ave	74	54	---	---	---
Channel 78						Fundamental Frequency: 2480 MHz				
2492.600	V	50.82	-0.58	50.24	Peak	74	54	-23.76	188	1.02
---	V	---	---	---	Ave	74	54	---	---	---
2495.600	V	50.51	-0.57	49.94	Peak	74	54	-24.06	188	1.02
---	V	---	---	---	Ave	74	54	---	---	---
2498.240	V	50.46	-0.55	49.91	Peak	74	54	-24.09	188	1.02
---	V	---	---	---	Ave	74	54	---	---	---
2560.400	V	50.28	-0.25	50.03	Peak	74	54	-23.97	188	1.02
---	V	---	---	---	Ave	74	54	---	---	---
2580.200	V	51.24	-0.16	51.08	Peak	74	54	-22.92	188	1.02
---	V	---	---	---	Ave	74	54	---	---	---
2599.760	V	51.88	-0.05	51.83	Peak	74	54	-22.17	188	1.02
---	V	---	---	---	Ave	74	54	---	---	---
2517.200	H	46.99	-0.47	46.52	Peak	74	54	-27.48	188	1.02
---	H	---	---	---	Ave	74	54	---	---	---

Notes:

1. Result = Meter Reading + Factor
2. Factor = Antenna Factor + Cable Loss – Amplifier
3. The resolution bandwidth of test receiver/spectrum analyzer is 1 MHz and video bandwidth is 3 MHz for Peak detection at frequency above 1GHz.
4. The resolution bandwidth of test receiver/spectrum analyzer is 1MHz and video bandwidth is 10Hz for Average detection at frequency above 1GHz



Test Date: Sep. 01, 2015

Temperature: 21.5 °C

Atmospheric pressure: 1008 hPa

Humidity: 49 %

Modulation Standard: $\pi/4$ -DQPSK

Channel 0						Fundamental Frequency: 2402 MHz				
Frequency (MHz)	Ant-Pol H/V	Meter Reading	Corrected Factor	Result (dBuV/m)	Remark	Limit@3m (dBuV/m)		Margin (dB)	Table (Deg.)	Ant High (m)
						Peak	Ave.			
2366.948	V	47.29	-1.08	46.21	Peak	74	54	-27.79	185	1.01
---	V	---	---	---	Ave	74	54	---	---	---
2360.968	H	47.11	-1.09	46.02	Peak	74	54	-27.98	185	1.01
---	H	---	---	---	Ave	74	54	---	---	---
Channel 78						Fundamental Frequency: 2480 MHz				
2585.240	V	47.39	-0.13	47.26	Peak	74	54	-26.74	186	1.02
---	V	---	---	---	Ave	74	54	---	---	---
2494.760	H	47.19	-0.57	46.62	Peak	74	54	-27.38	186	1.05
---	H	---	---	---	Ave	74	54	---	---	---

Modulation Standard: 8DPSK

Channel 0						Fundamental Frequency: 2402 MHz				
Frequency (MHz)	Ant-Pol H/V	Meter Reading	Corrected Factor	Result (dBuV/m)	Remark	Limit@3m (dBuV/m)		Margin (dB)	Table (Deg.)	Ant High (m)
						Peak	Ave.			
2373.204	V	48.31	-1.05	47.26	Peak	74	54	-26.74	181	1.04
---	V	---	---	---	Ave	74	54	---	---	---
2374.492	H	47.70	-1.05	46.65	Peak	74	54	-27.35	181	1.04
---	H	---	---	---	Ave	74	54	---	---	---
Channel 78						Fundamental Frequency: 2480 MHz				
2499.080	V	-0.55	46.85	46.30	Peak	74	54	-27.70	188	1.07
---	V	---	---	---	Ave	74	54	---	---	---
2540.600	H	47.97	-0.34	47.63	Peak	74	54	-26.37	188	1.07
---	H	---	---	---	Ave	74	54	---	---	---

Notes:

1. Result = Meter Reading + Factor
2. Factor = Antenna Factor + Cable Loss – Amplifier
3. The resolution bandwidth of test receiver/spectrum analyzer is 1 MHz and video bandwidth is 3 MHz for Peak detection at frequency above 1GHz.
4. The resolution bandwidth of test receiver/spectrum analyzer is 1MHz and video bandwidth is 10Hz for Average detection at frequency above 1GHz



7. Test of Spurious Emission (Conducted)

7.1 Test Limit

Below -20dB of the highest emission level of operating band (in 100kHz Resolution Bandwidth).

7.2 Test Procedure

- a. The transmitter output was connected to the spectrum analyzer via a low lose cable.
- b. Set both RBW and VBW of spectrum analyzer to 100 KHz with convenient frequency span including 100 KHz bandwidth from band edge.
- c. The band edges was measured and recorded.

7.3 Test Setup Layout

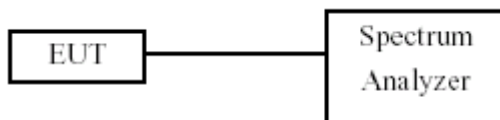

7.4 Test Result and Data

Test Date	: Aug. 12, 2015	Temperature	: 23°C
Atmospheric pressure	: 1051 hPa	Humidity	: 52%
Test Result	: PASS		

Note: Test plots refer to the following pages.



Modulation Type: GFSK, CH00

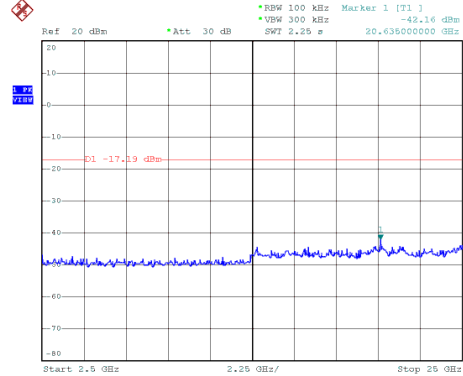
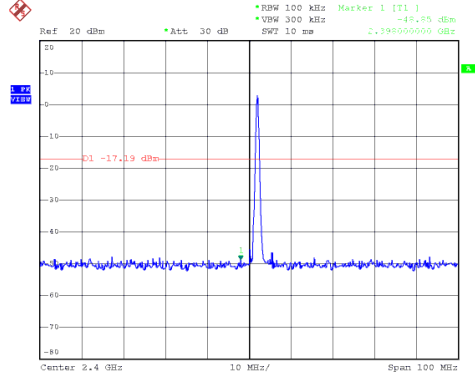

Modulation Type: GFSK, CH78

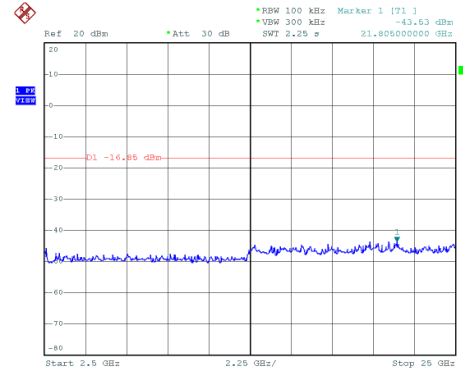
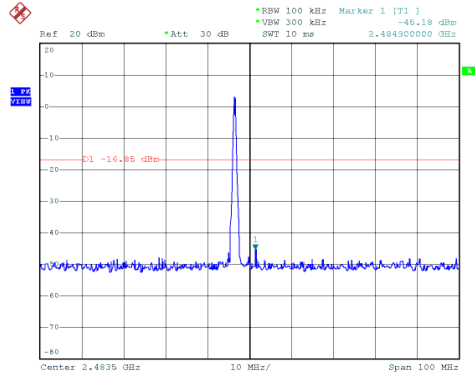

Modulation Type: $\pi/4$ -DQPSK, CH00

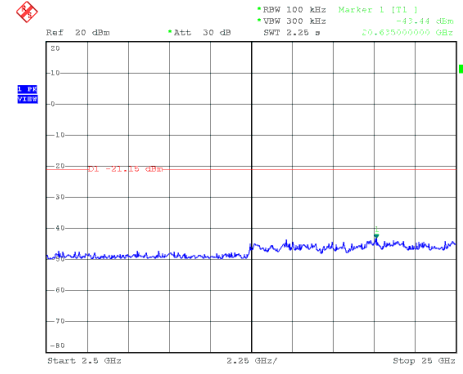
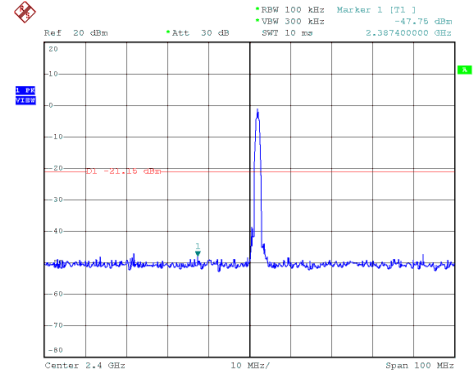

Modulation Type: $\pi/4$ -DQPSK, CH78

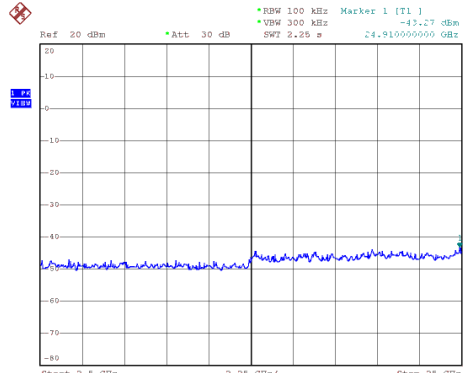
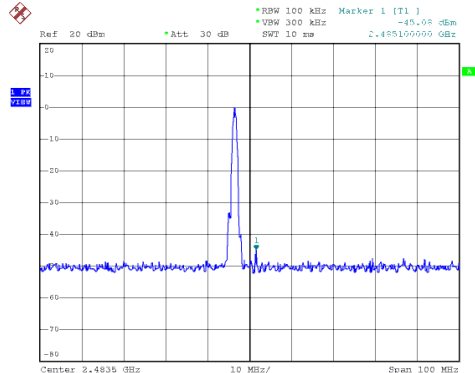



Modulation Type: 8DPSK, CH00

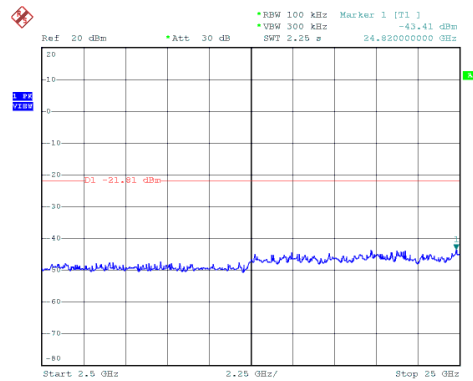
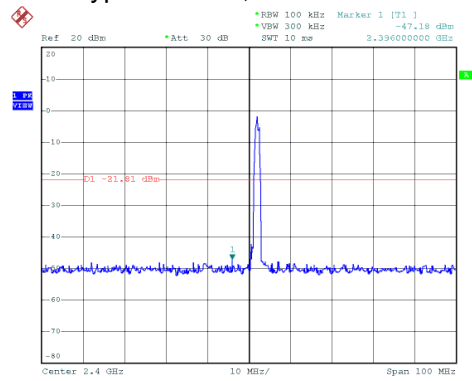

Modulation Type: 8DPSK, CH78

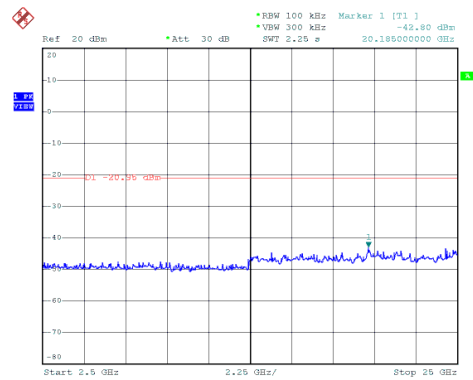
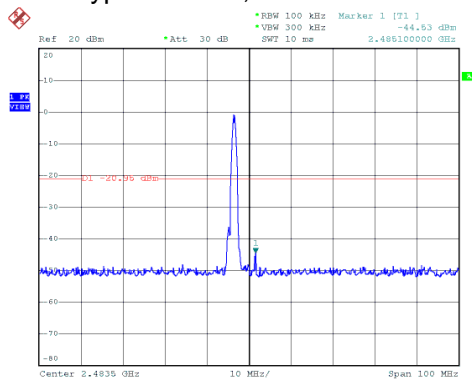



hopping mode:
Modulation Type: GFSK, CH00

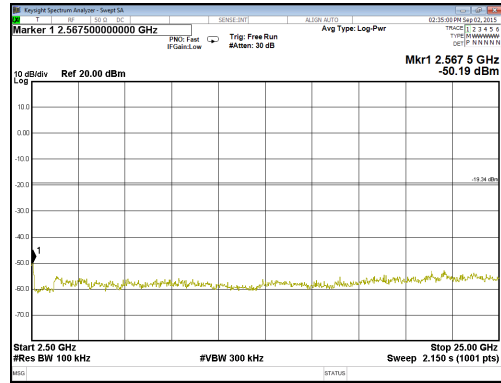
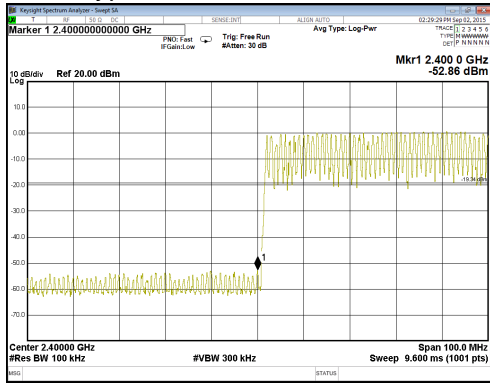

Modulation Type: GFSK, CH78

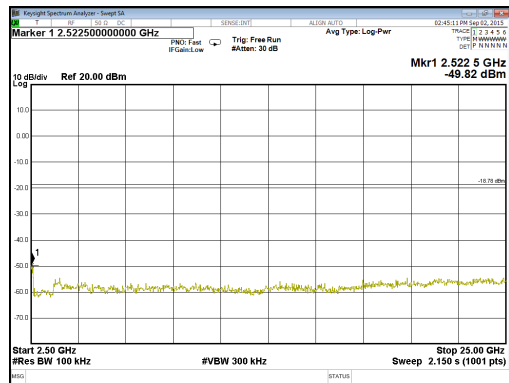
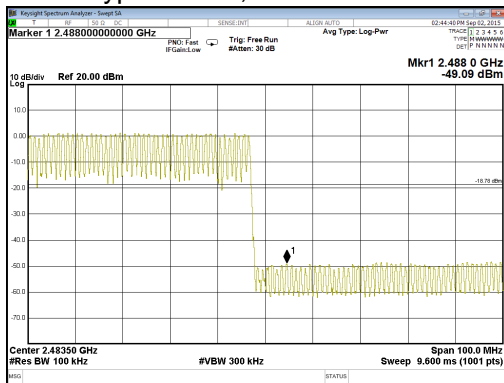

Modulation Type: $\pi/4$ -DQPSK, CH00

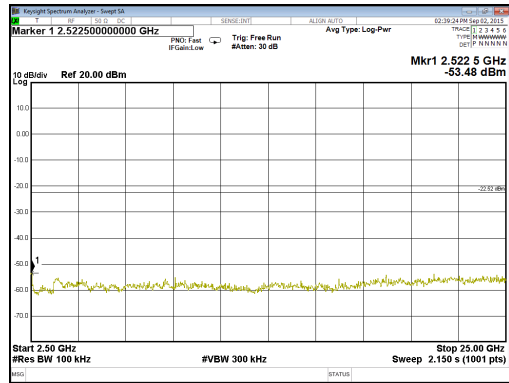
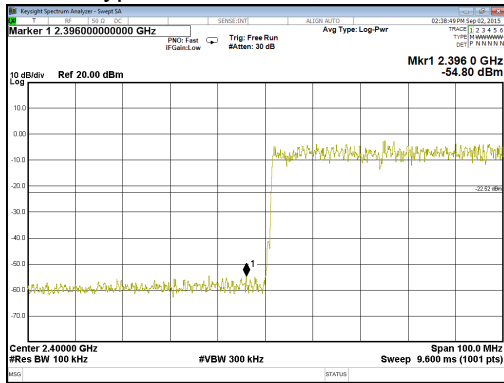

Modulation Type: $\pi/4$ -DQPSK, CH78

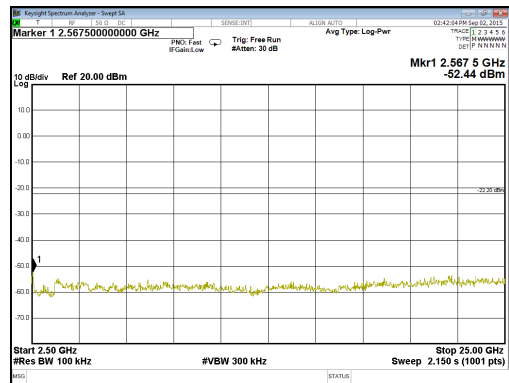
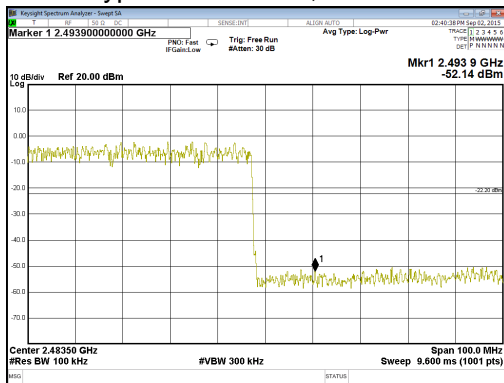



Modulation Type: 8DPSK, CH00

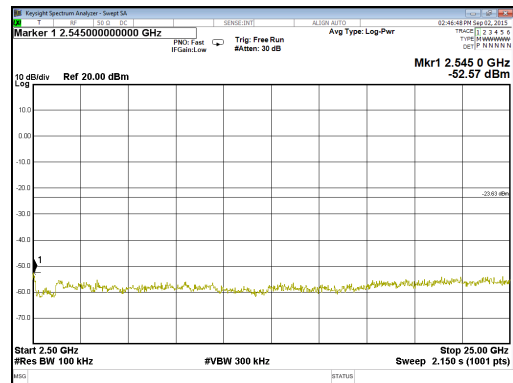
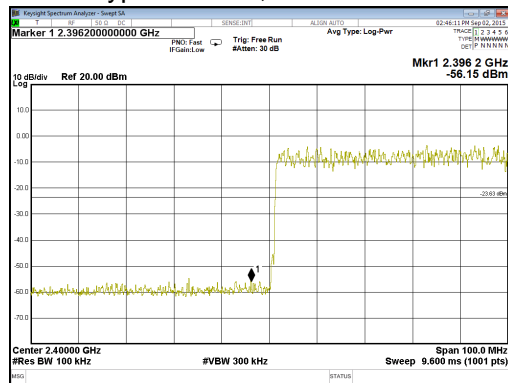

Modulation Type: 8DPSK, CH78

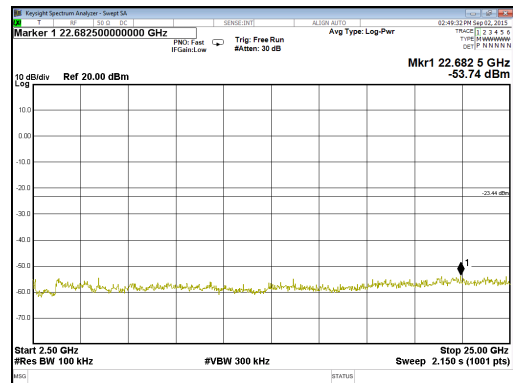
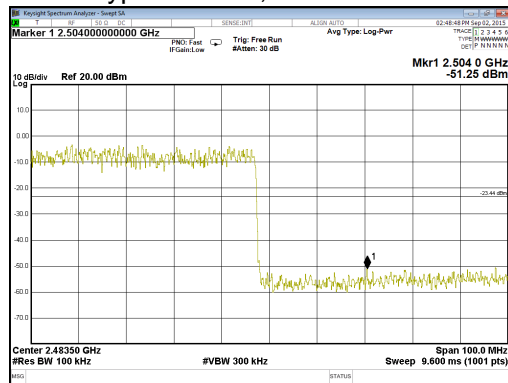



8. Occupied Bandwidth Measurement Data

8.1 Test Limit

Frequency hopping systems shall have hopping channel carrier frequencies separated by a minimum of 25 kHz or the 20 dB bandwidth of the hopping channel, whichever is greater. Alternatively, frequency hopping systems operating in the 2400–2483.5 MHz band may have hopping channel carrier frequencies that are separated by 25 kHz or two-thirds of the 20 dB bandwidth of the hopping channel, whichever is greater, provided the systems operate with an output power no greater than 125 mW.

8.2 Test Procedures

- a. The transmitter output was connected to the spectrum analyzer.
- b. Set RBW of spectrum analyzer to 30 KHz and VBW to 100 KHz.
- c. The 20 dB bandwidth is defined as the total spectrum the power of which is higher than peak power minus 20 dB.

8.3 Test Setup Layout

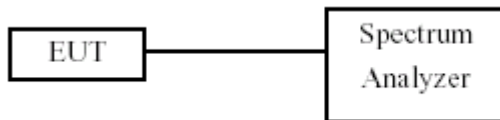

8.4 Test Result and Data

Test Date : Aug. 12, 2015 Temperature : 23°C
 Atmospheric pressure : 1051 hPa Humidity : 52%

Modulation Type	Channel	Frequency (MHz)	20dB Bandwidth (MHz)	2/3 20dB Bandwidth (KHz)
GFSK	00	2402	0.972	648.000
	39	2441	0.968	645.333
	78	2480	0.960	640.000
$\pi/4$ -DQPSK	00	2402	1.444	962.667
	39	2441	1.448	965.333
	78	2480	1.436	957.333
8DPSK	00	2402	1.496	997.33.
	39	2441	1.500	1000.000
	78	2480	1.488	992.000



Modulation Type: GFSK
CH00

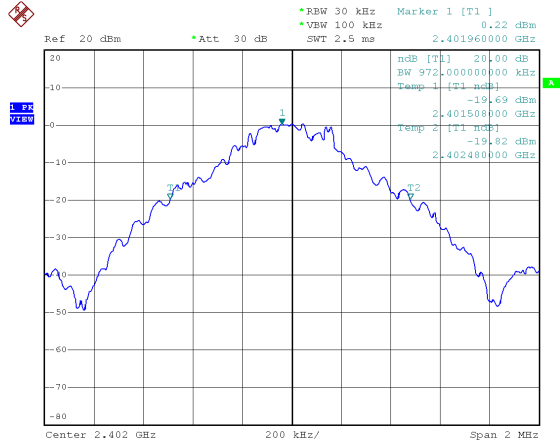

Modulation Type: $\pi/4$ -DQPSK
CH00

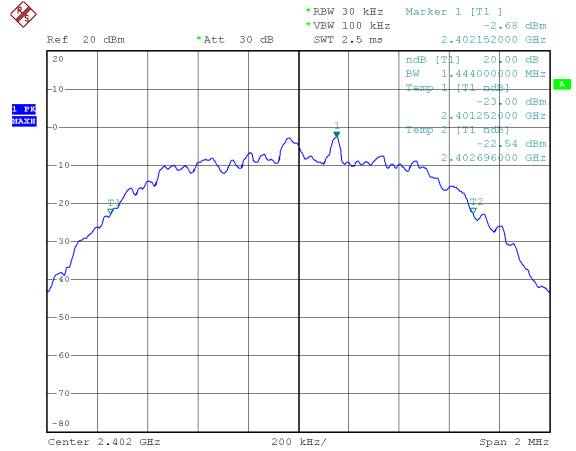

CH39

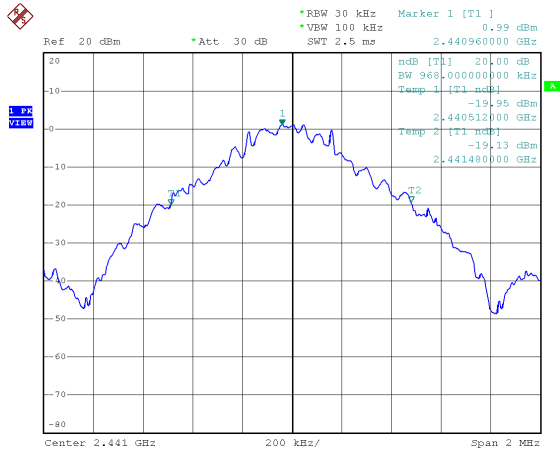

CH39

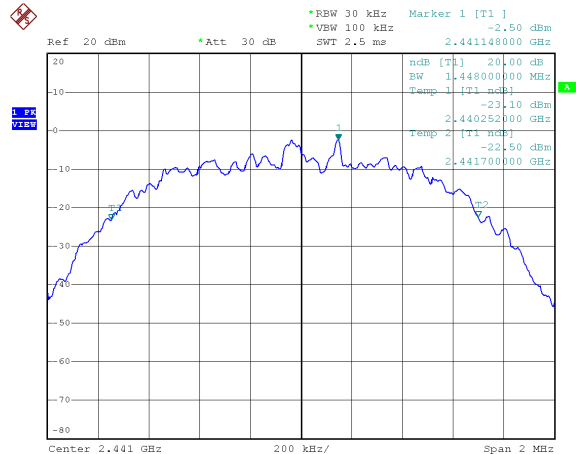

CH78

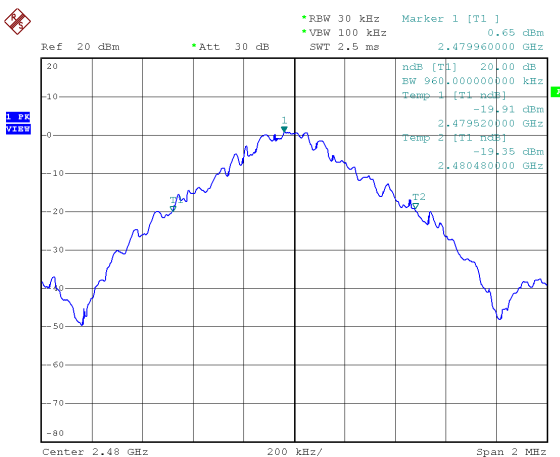

CH78

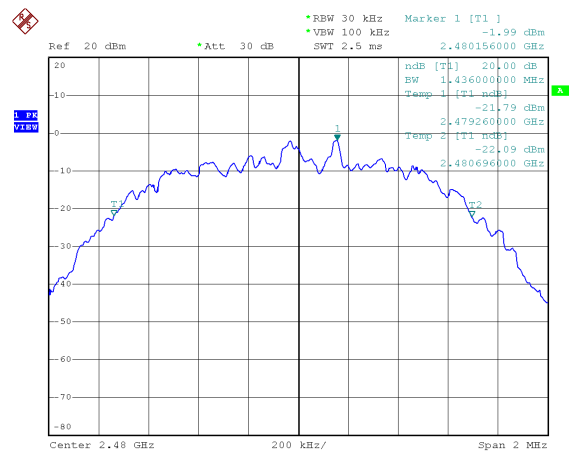



Modulation Type: 8DSPK
CH00

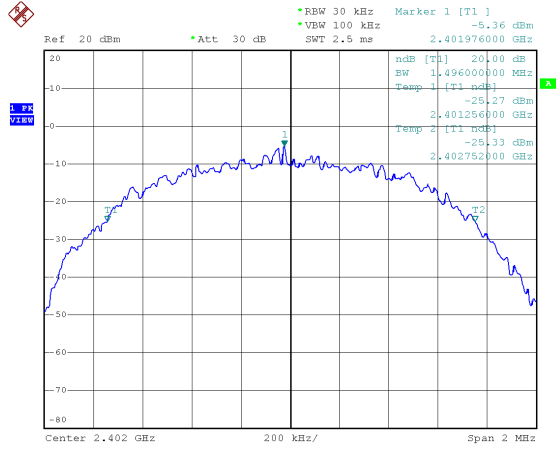

CH39

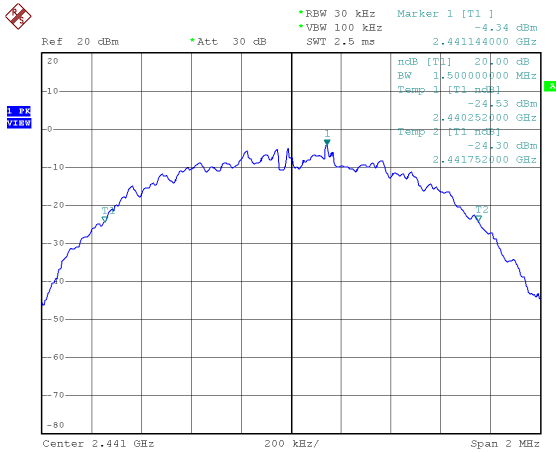

CH78

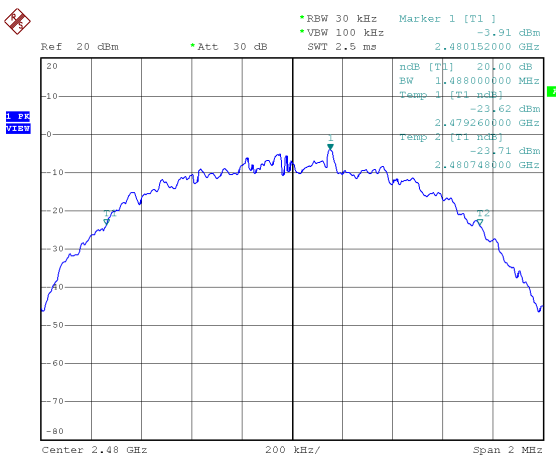



9. Frequencies Separation

9.1 Test Limit

Frequency hopping systems shall have hopping channel carrier frequencies separated by a minimum of 25 kHz or the 20 dB bandwidth of the hopping channel, whichever is greater.

9.2 Test Procedures

- a. The transmitter output was connected to the spectrum analyzer.
- b. Set RBW of spectrum analyzer to 30 KHz and VBW to 100 KHz.
- c. By using the MaxHold function record the separation of two adjacent channels.
- d. Measure the frequency difference of these two adjacent channels.

9.3 Test Setup Layout

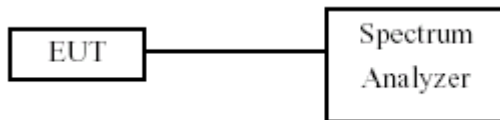

9.4 Test Result and Data

Test Date : Aug. 12, 2015 Temperature : 23°C
Atmospheric pressure : 1051 hPa Humidity : 52%

Modulation Type	Channel	Frequency (MHz)	Channel Separation (MHz)
GFSK	00	2402	1.000
	39	2441	1.012
	78	2480	1.044
$\pi/4$ -DQPSK	00	2402	1.004
	39	2441	1.044
	78	2480	1.060
8DPSK	00	2402	1.000
	39	2441	1.032
	78	2480	1.044



Modulation Type: GFSK
CH00

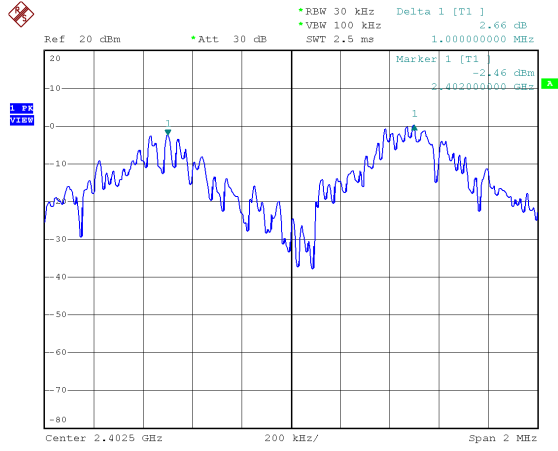

Modulation Type: $\pi/4$ -DQPSK
CH00

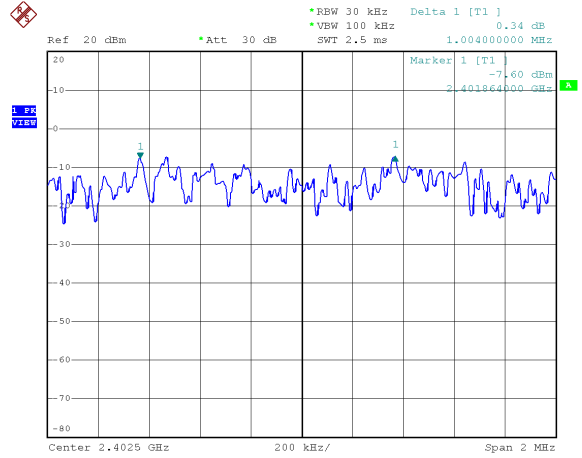

CH39

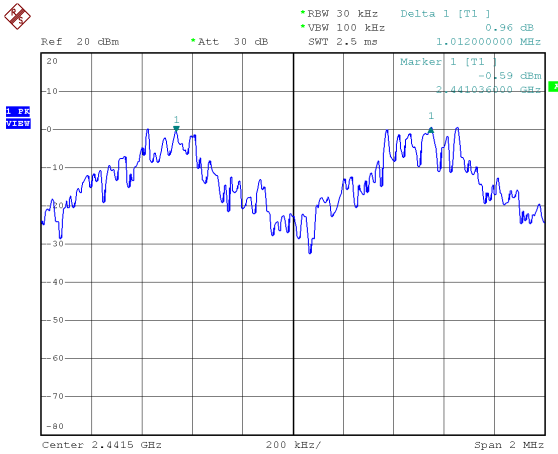

CH39

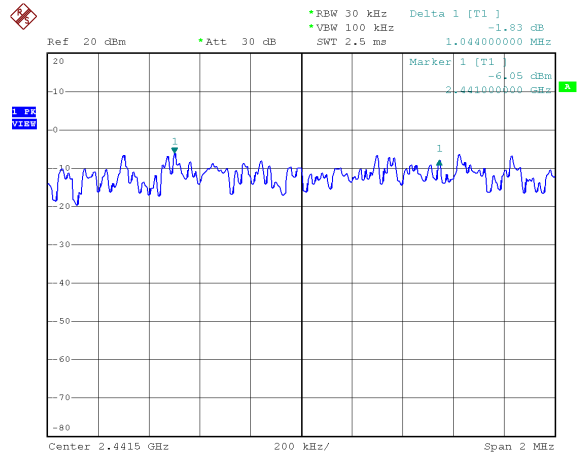

CH78

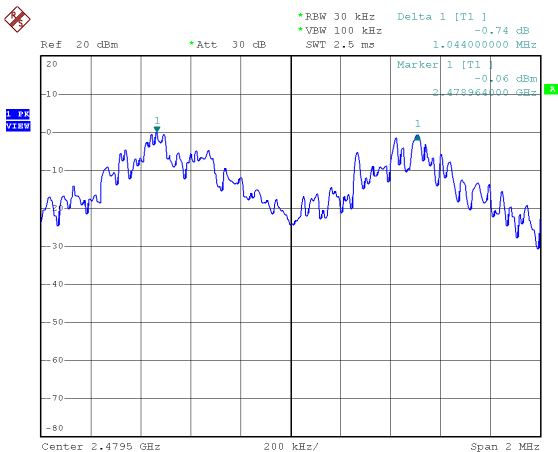

CH78

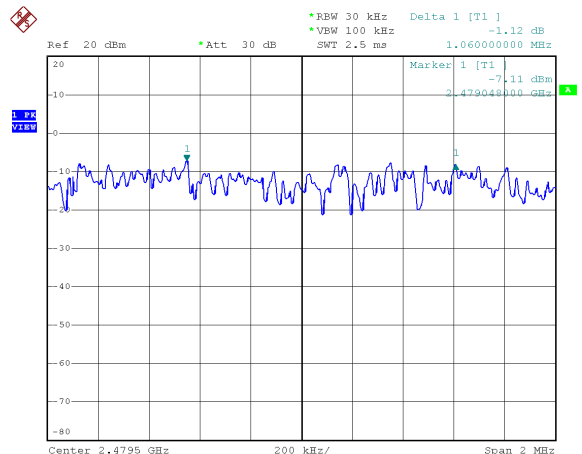



Modulation Type: 8DSPK
CH00

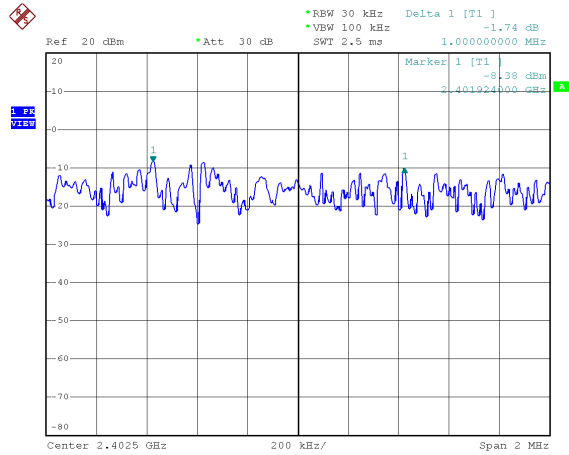

CH39

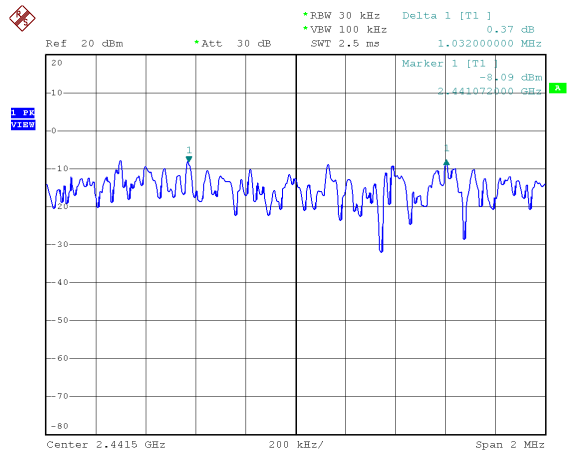

CH78

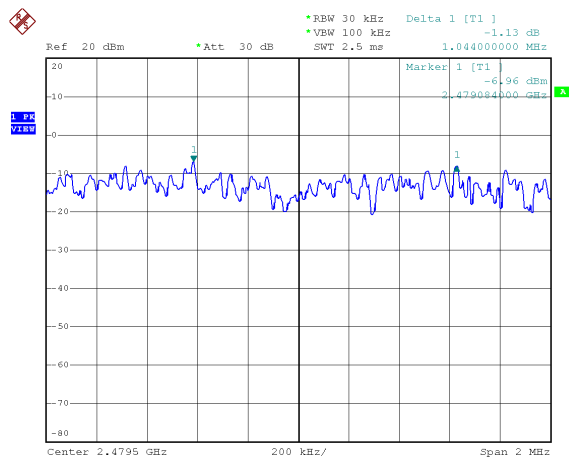



10. Dwell Time on each channel

10.1 Test Limit

The average time of occupancy on any channel shall not be greater than 0.4 seconds within a period of 0.4 seconds multiplied by the number of hopping channels employed.

10.2 Test Procedures

1. The transmitter output was connected to the spectrum analyzer.
2. Adjust the center frequency to measure frequency, then set zero span mode.
2. Set RBW of spectrum analyzer to 1 MHz and VBW to 1 MHz.
4. Measure the time duration of one transmission on the measured frequency.

10.3 Test Setup Layout

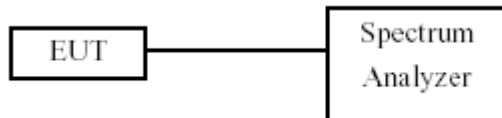



10.4 Test Result and Data

Test Date : Aug. 12, 2015 Temperature : 23°C
 Atmospheric pressure : 1051 hPa Humidity : 52%
 Test Period = 0.4 (second/ channel) x 79 Channel = 31.6 sec

Modulation Type	Channel	Frequency (MHz)	Dwell Time (ms)
GFSK (DH1)	00	2402	126.08
	39	2441	126.72
	78	2480	128.00
GFSK (DH3)	00	2402	266.56
	39	2441	267.20
	78	2480	270.40
GFSK (DH5)	00	2402	315.73
	39	2441	324.27
	78	2480	324.27
$\pi/4$ -DQPSK (2DH5)	00	2402	327.27
	39	2441	322.13
	78	2480	324.27
8DPSK (3DH5)	00	2402	326.40
	39	2441	322.13
	78	2480	326.40

Test period: 0.4(second/ channel) x 79 channel=31.6 second

Example:

CH0,DH1 mode= $0.378 \text{ (ms)} \times (1600/2)/79 \times 31.6 = 120.96 \text{ (ms)}$
 CH0,DH3 mode = $1.624 \text{ (ms)} \times (1600/4)/79 \times 31.6 = 259.84 \text{ (ms)}$
 CH0,DH5 mode = $2.872 \text{ (ms)} \times (1600/6)/79 \times 31.6 = 306.35 \text{ (ms)}$



Modulation Type: GFSK(DH1)
CH00

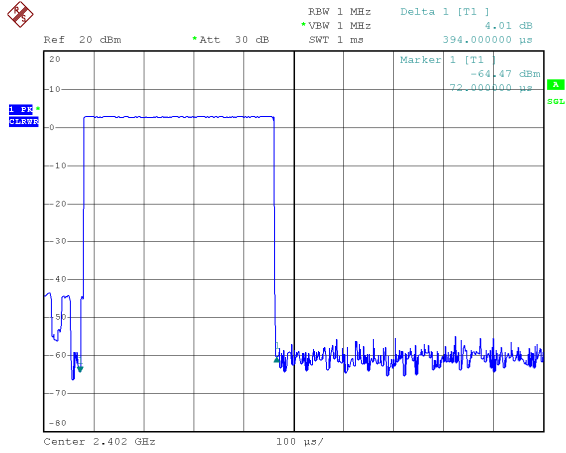

Modulation Type: GFSK(DH3)
CH00

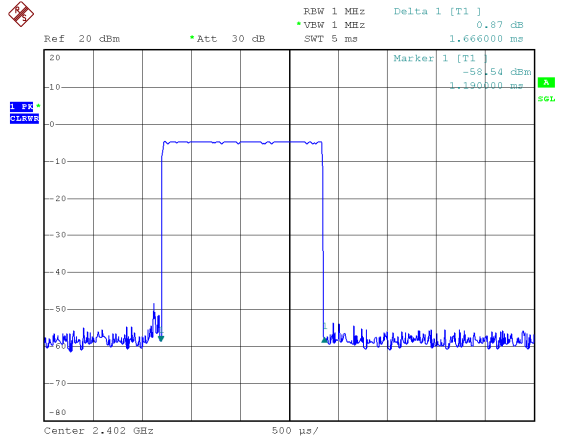

CH39

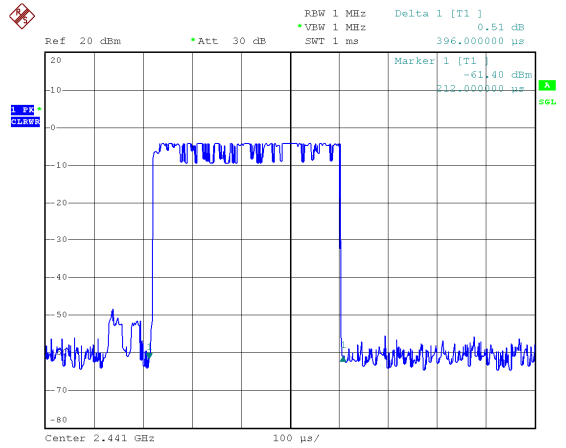

CH39

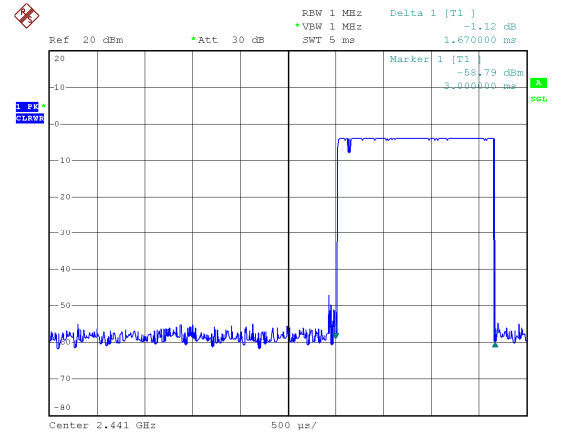

CH78

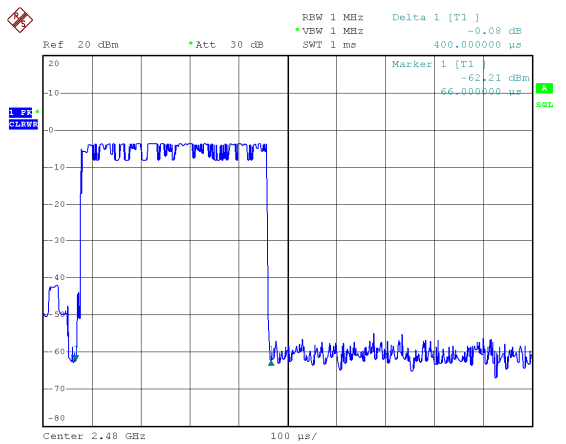

CH78

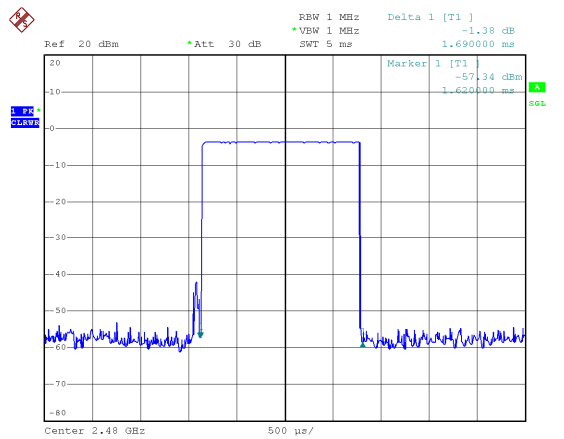



Modulation Type: GFSK(DH5)
CH00

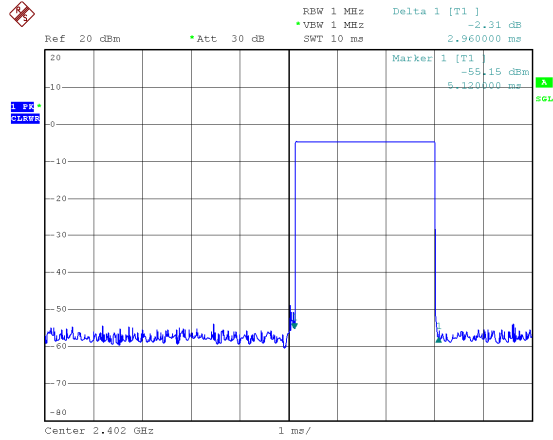

Modulation Type: $\pi/4$ -DQPSK
CH00

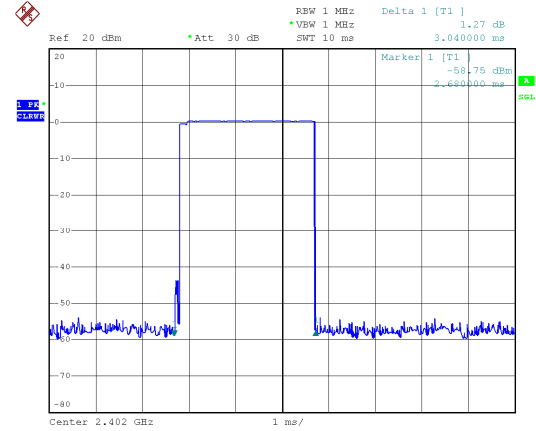

CH39

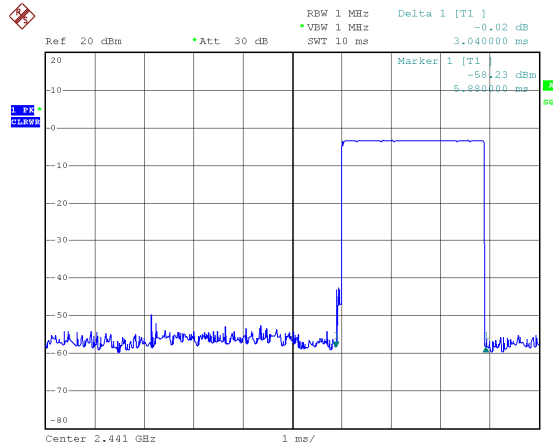

CH39

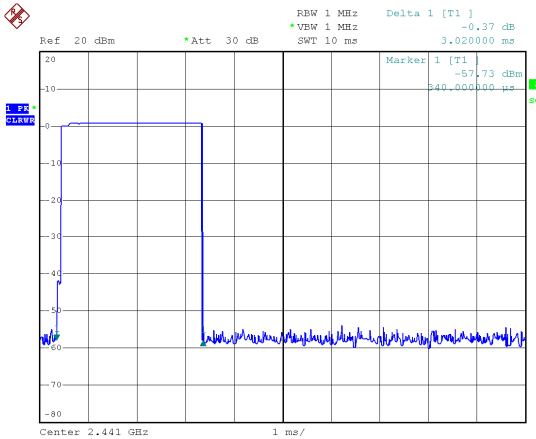

CH78

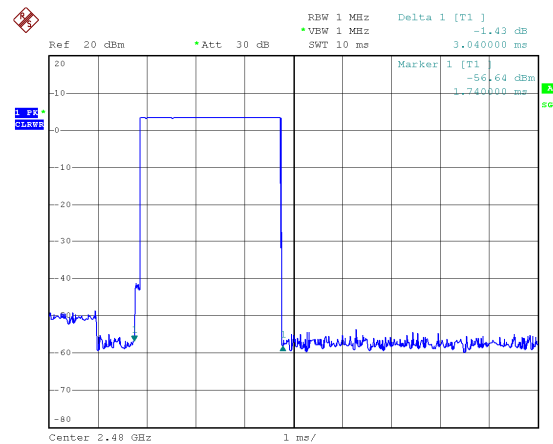

CH78

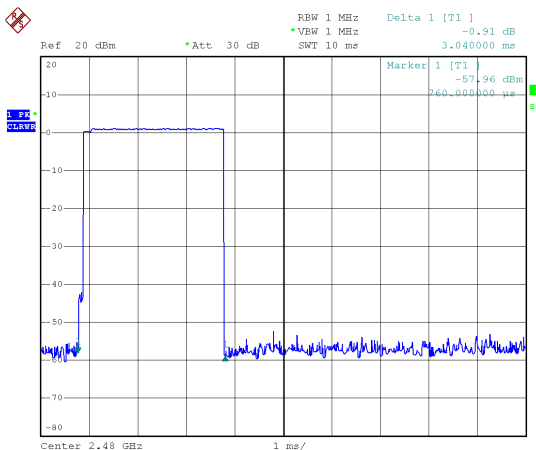



Modulation Type: 8DSPK
CH00

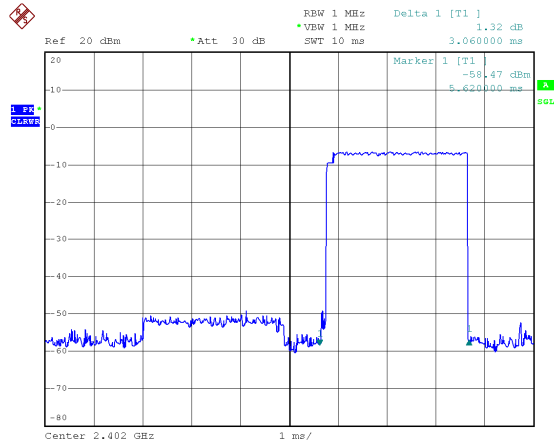

CH39

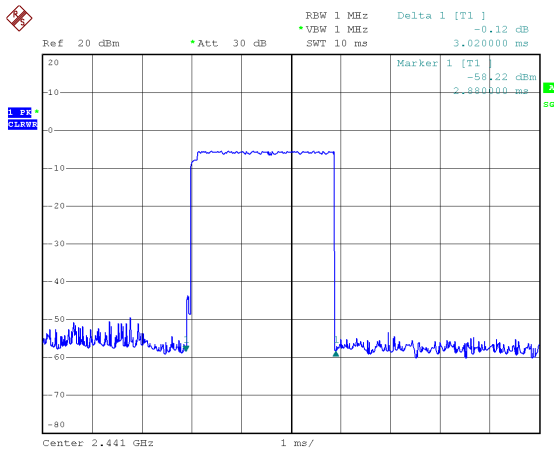

CH78

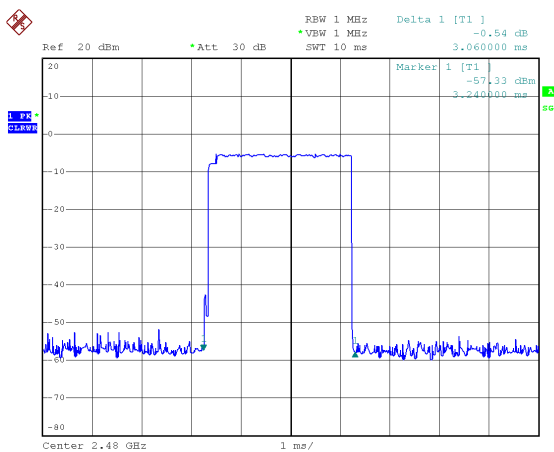



11. Number of Hopping Channels

11.1 Test Limit

Frequency hopping systems in the 2400 ~ 2483.5 MHz band shall use at least 15 channels.

11.2 Test Procedures

- a. The transmitter output was connected to the spectrum analyzer.
- b. 2. Set RBW of spectrum analyzer to 100 KHz and VBW to 100 KHz.
- c. 3. Set the MaxHold function, and then keep the EUT in hopping mode. Record all the signals from each channel until each one has been record.

11.3 Test Setup Layout

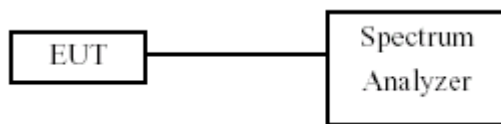

11.4 Test Result and Data

Test Date : Aug. 12, 2015 Temperature : 23°C
Atmospheric pressure : 1051 hPa Humidity : 52%

Modulation Type	Hopping Channels
GFSK	79
$\pi/4$ -DQPSK	79
8DPSK	79



Modulation Type:GFSK

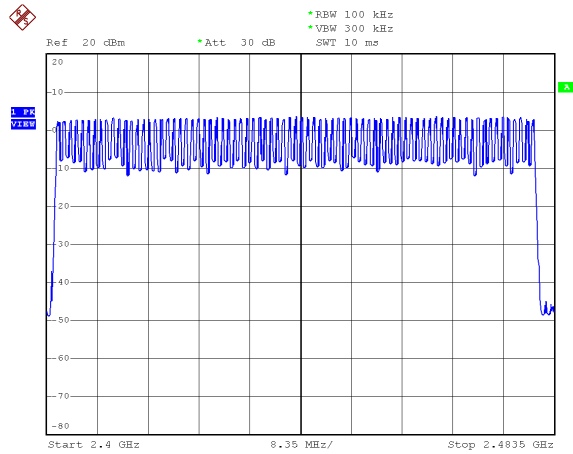

Modulation Type: $\pi/4$ -DQPSK

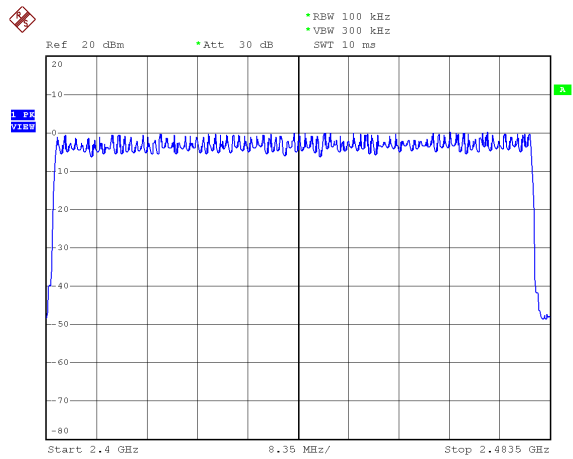

Modulation Type: 8DPSK

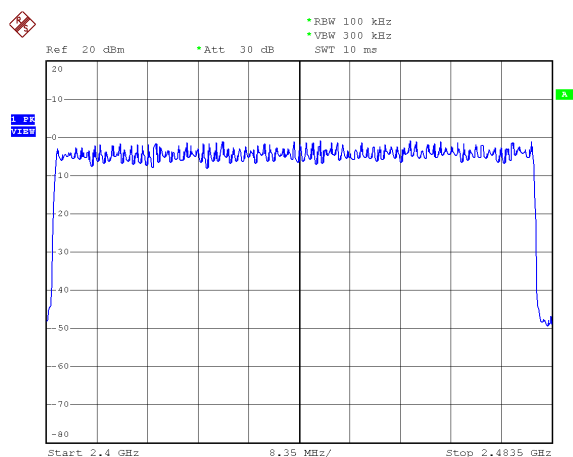



12. Maximum Peak Output Power

12.1 Test Limit

The Maximum Peak Output Power Measurement is 30dBm.

12.2 Test Procedures

The antenna port(RF output)of the EUT was connected to the input(RF input)of a power meter. Power was read directly from the meter and cable loss connection was added to the reading to obtain power at the EUT antenna terminal. The EUT Output Power was set to maximum to produce the worse case test result.

12.3 Test Setup Layout

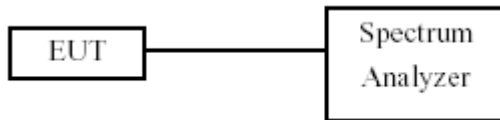

12.4 Test Result and Data

Test Date : Aug. 12, 2015 Temperature : 23°C
 Atmospheric pressure : 1051 hPa Humidity : 52%

Modulation Type	Channel	Frequency (MHz)	Output Power (dBm)	Output Power (mW)
GFSK	00	2402	2.91	1.954
	39	2441	3.66	2.323
	78	2480	3.39	2.183
$\pi/4$ -DQPSK	00	2402	1.34	1.361
	39	2441	2.11	1.626
	78	2480	2.15	1.641
8DPSK	00	2402	0.47	1.114
	39	2441	1.24	1.330
	78	2480	1.10	1.288



Modulation Type: GFSK(1Mbps)
CH00

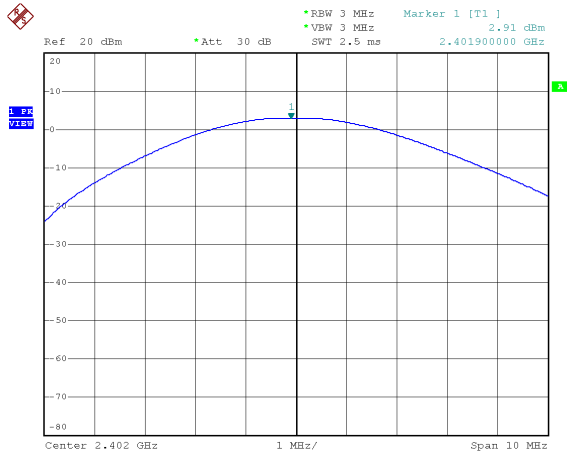

Modulation Type: $\pi/4$ -DQPSK(2Mbps)
CH00

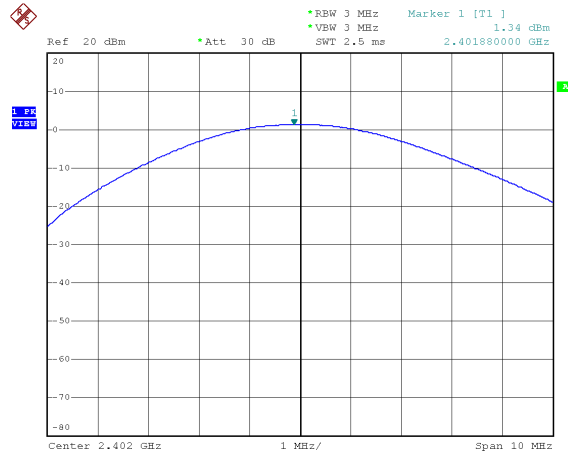

CH39

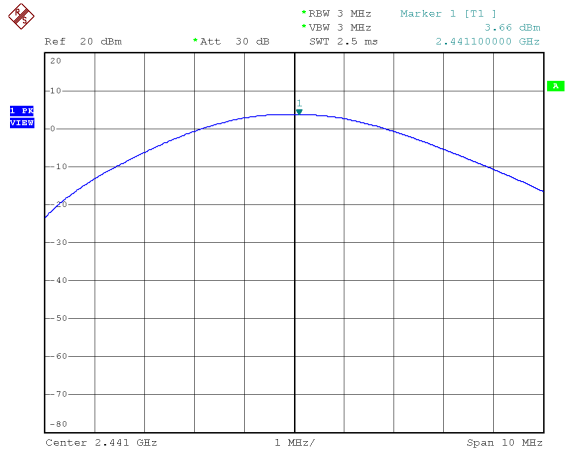

CH39

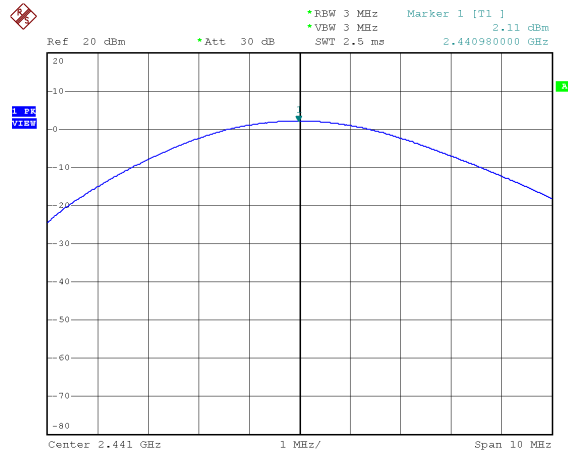

CH78

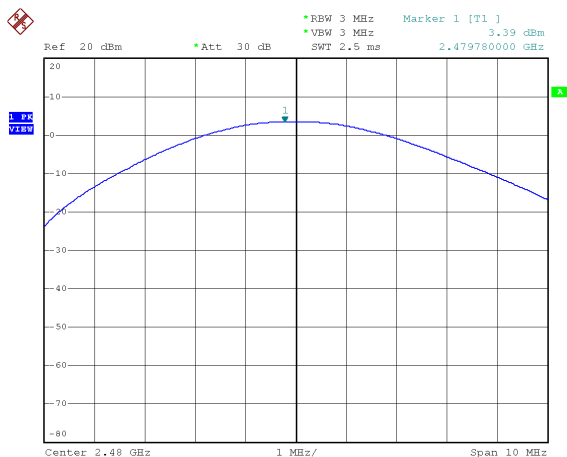

CH78

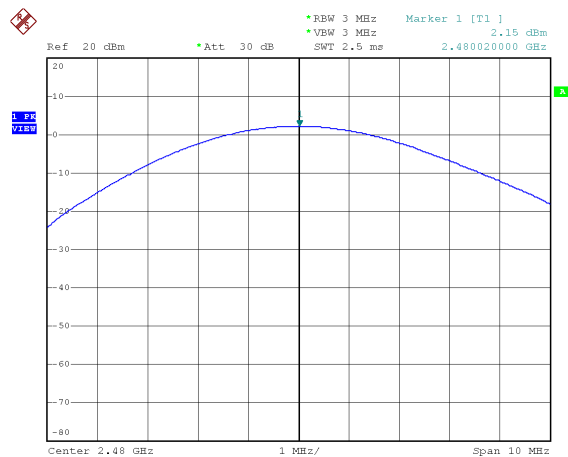



Modulation Type: 8DSPK(3Mbps)
CH00

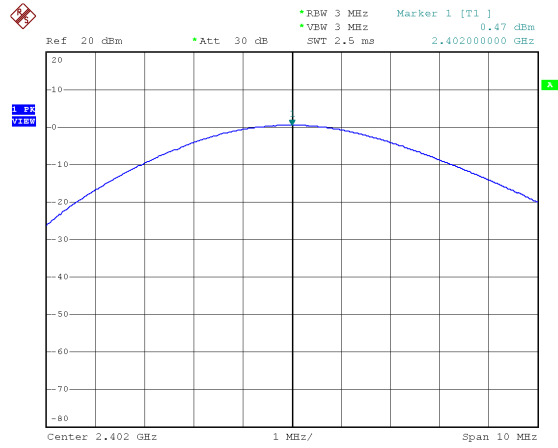

CH39

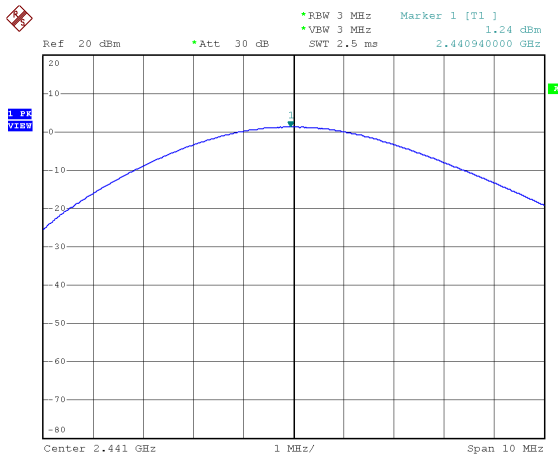

CH78

