



# FCC RADIO TEST REPORT

Applicant : AOPEN Inc.  
Address : 5F., No.15, Ln. 128, Sinhu 1st Rd., Neihu District,  
Taipei City 114, Taiwan(R.O.C.)  
Equipment : AOPEN Chromebase Mini Commercial  
Model No. : WT10M-FRG  
Trade Name : AOPEN  
FCC ID : YEW-10MFRGCM389

### I HEREBY CERTIFY THAT :

The sample was received on Feb. 16, 2017 and the testing was carried out on Mar. 02, 2017 at CerpPASS Technology Corp. The test result refers exclusively to the test presented test model / sample. Without written approval of CerpPASS Technology Corp., the test report shall not be reproduced except in full.

Approved by:

Tested by:

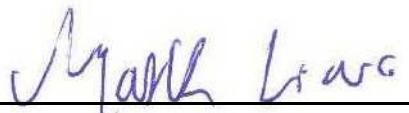
  
Mark Liao / Assistant Manager

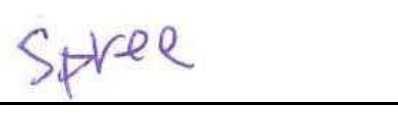
  
Spree Yei / Engineer

Laboratory Accreditation:

CerpPASS Technology Corporation Test Laboratory





**CONTENTS**

- 1. Summary of Test Procedure and Test Results ..... 5
  - 1.1. Applicable Standards ..... 5
- 2. Test Configuration of Equipment under Test ..... 6
  - 2.1. Feature of Equipment under Test..... 6
  - 2.2. Carrier Frequency of Channels ..... 7
  - 2.3. Test Mode and Test Software ..... 8
  - 2.4. Description of Test System..... 8
  - 2.5. General Information of Test..... 9
  - 2.6. Measurement Uncertainty ..... 9
- 3. Test Equipment and Ancillaries Used for Tests ..... 10
- 4. Antenna Requirements ..... 11
  - 4.1. Standard Applicable ..... 11
  - 4.2. Antenna Construction and Directional Gain..... 11
- 5. Test of AC Power Line Conducted Emission ..... 12
  - 5.1. Test Limit ..... 12
  - 5.2. Test Procedures ..... 12
  - 5.3. Typical Test Setup ..... 13
  - 5.4. Test Result and Data ..... 14
  - 5.5. Test Photographs ..... 20
- 6. Test of Spurious Emission (Radiated) ..... 21
  - 6.1. Test Limit ..... 21
  - 6.2. Test Procedures ..... 21
  - 6.3. Typical Test Setup ..... 22
  - 6.4. Test Result and Data (9kHz ~ 30MHz)..... 23
  - 6.5. Test Result and Data (30MHz ~ 1GHz)..... 23
  - 6.6. Test Result and Data (1GHz ~ 40GHz)..... 27
  - 6.7. Restricted Bands of Operation ..... 101
  - 6.8. Test Photographs (30MHz ~ 1GHz) ..... 102
  - 6.9. Test Photographs (1GHz ~ 40GHz) ..... 103
- 7. On Time, Duty Cycle and Measurement methods ..... 104
  - 7.1. Test Limit ..... 104
  - 7.2. Test Procedure ..... 104
  - 7.3. Test Setup Layout ..... 104
  - 7.4. Test Result and Data ..... 104
  - 7.5. Measurement Methods ..... 104
- 8. 6dB Bandwidth ..... 105
  - 8.1. Test Limit ..... 105
  - 8.2. Test Procedure ..... 105
  - 8.3. Test Setup Layout ..... 105
  - 8.4. Test Result and Data ..... 105
- 9. 26dB Bandwidth ..... 110
  - 9.1. Test Limit ..... 110
  - 9.2. Test Procedure ..... 110
  - 9.3. Test Setup Layout ..... 110
  - 9.4. Test Result and Data ..... 111



- 10. Average Power..... 122
  - 10.1. Test Limit ..... 122
  - 10.2. Test Procedure ..... 122
  - 10.3. Test Setup Layout ..... 122
  - 10.4. Test Result and Data ..... 123
- 11. Output Power and PPSD ..... 125
  - 11.1. Test Limit ..... 125
  - 11.2. Test Procedure ..... 127
  - 11.3. Test Setup Layout ..... 127
  - 11.4. Test Result and Data ..... 128
- 12. Frequency Stability..... 144
  - 12.1. Test Procedure ..... 144
  - 12.2. Test Setup Layout ..... 144
  - 12.3. Test Result and Data ..... 145
- 13. Automatically Discontinue Transmission ..... 146
  - 13.1. Limit of Automatically Discontinue Transmission ..... 146
  - 13.2. Test Result of Automatically Discontinue Transmission ..... 146



History of this test report

Report No.	Issue Date	Description
TEFE1701078	Mar. 07, 2017	Original



# 1. Summary of Test Procedure and Test Results

## 1.1. Applicable Standards

ANSI C63.4:2014

ANSI C63.10:2013

FCC Rules and Regulations Part 15 Subpart E §15.407

First R&O 14-30

KDB662911

KDB789033

KDB644545

FCC Rule	Description of Test	Result
15.203	. Antenna Requirement	Pass
15.207(a)	. AC Power Line Conducted Emission	Pass
15.407(b) 15.209	. Radiated Spurious Emission	Pass
15.407(a)	. 26 dB Occupied Bandwidth	Pass
15.407	. 6 dB Bandwidth	Pass
15.407 (a) & (a)(3)	. Average Power	Pass
15.407(a)	. Output and PPSD	Pass



## 2. Test Configuration of Equipment under Test

### 2.1. Feature of Equipment under Test

Frequency Range	802.11b/g/n: 2412-2462 MHz 802.11a: 5150-5850 MHz Bluetooth: 2402-2480 MHz BLE: 2402-2480 MHz
Modulation Type	OFDM, DSSS, FHSS, GFSK, $\pi/4$ -DQPSK, 8DPSK
Data Rate	WLAN: 802.11b: 1, 2, 5.5, 11Mbps 802.11g: 6, 9, 12, 18, 24, 36, 48, 54Mbps 802.11n: MCS0 – MCS15, HT20/40 802.11a: 6, 9, 12, 18, 24, 36, 48, 54Mbps 802.11ac: MCS0 – MCS9, VHT 20/40/80) Bluetooth: Bluetooth 2.1+EDR data rates of 1,2, and 3Mbps
Antenna Type	PCB Antenna
Antenna Gain	802.11b/g/n: Antenna A: 0.59dBi Antenna B: 1.85dBi 802.11a: Antenna A Band1: 2.10dBi Antenna A Band2: 2.10dBi Antenna A Band3: 2.10dBi Antenna A Band4: 2.10dBi Antenna B Band1: 0.87dBi Antenna B Band2: 0.87dBi Antenna B Band3: 0.87dBi Antenna B Band4: 0.87dBi Bluetooth: 1.85dBi BLE: 1.85dBi



### 2.2. Carrier Frequency of Channels

Band: 5150MHz-5250MHz

802.11a, 802.11an HT 20, 802.11ac VHT20

Channel	Frequency(MHz)	Channel	Frequency(MHz)
<b>*36</b>	<b>5180</b>	<b>*44</b>	<b>5220</b>
40	5200	<b>*48</b>	<b>5240</b>

802.11an HT 40, 802.11ac VHT40

Channel	Frequency(MHz)	Channel	Frequency(MHz)
<b>*38</b>	<b>5190</b>	<b>*46</b>	<b>5230</b>

802.11ac VHT80

Channel	Frequency(MHz)
<b>*42</b>	<b>5210</b>

Band: 5250MHz -5350MHz

802.11a, 802.11an HT 20, 802.11ac VHT20

Channel	Frequency(MHz)	Channel	Frequency(MHz)
<b>*52</b>	<b>5260</b>	<b>*60</b>	<b>5300</b>
56	5280	<b>*64</b>	<b>5320</b>

802.11an HT 40, 802.11ac VHT40

Channel	Frequency(MHz)	Channel	Frequency(MHz)
<b>*54</b>	<b>5270</b>	<b>*62</b>	<b>5310</b>

802.11ac VHT80

Channel	Frequency(MHz)
<b>*58</b>	<b>5290</b>

Band: 5470MHz -5725MHz

802.11a

Channel	Frequency(MHz)	Channel	Frequency(MHz)
<b>*100</b>	<b>5500</b>	<b>*116</b>	<b>5580</b>
104	5520	<b>*132</b>	<b>5660</b>
108	5540	136	5680
122	5560	<b>*140</b>	<b>5700</b>

802.11an HT 20, 802.11ac VHT20

Channel	Frequency(MHz)	Channel	Frequency(MHz)
<b>*100</b>	<b>5500</b>	<b>*116</b>	<b>5580</b>
104	5520	132	5660
108	5540	136	5680
122	5560	<b>*140</b>	<b>5700</b>

802.11an HT 40, 802.11ac VHT40

Channel	Frequency(MHz)	Channel	Frequency(MHz)
<b>*102</b>	<b>5510</b>	<b>*134</b>	<b>5670</b>
<b>*110</b>	<b>5550</b>	---	----

802.11ac VHT80

Channel	Frequency(MHz)
<b>*106</b>	<b>5530</b>



Band: 5725MHz -5850MHz  
802.11a, 802.11an HT20, 802.11ac VHT20

Channel	Frequency(MHz)	Channel	Frequency(MHz)
<b>*149</b>	<b>5745</b>	161	5805
153	5765	<b>*165</b>	<b>5825</b>
<b>*157</b>	<b>5785</b>		

802.11an HT 40, 802.11ac VHT40

Channel	Frequency(MHz)	Channel	Frequency(MHz)
<b>*151</b>	<b>5755</b>	<b>*159</b>	<b>5795</b>

802.11ac VHT80

Channel	Frequency(MHz)
<b>*155</b>	<b>5775</b>

Note: Channels remarked \* are selected to perform test.

### 2.3. Test Mode and Test Software

- a. During testing, the interface cables and equipment positions were varied according to ANSI C63.4.
- b. The complete test system included EUT for RF test.
- c. An executive program, "Dut labtool V2.0.0.44" under Chrome was executed to transmit and receive data via WLAN.
- d. The following test modes were performed for the test:
  - Test Mode 1: 802.11a (6Mbps)
  - Test Mode 2: 802.11an HT20 (6.5Mbps)
  - Test Mode 3: 802.11an HT40 (13.5Mbps)
  - Test Mode 4: 802.11ac VHT20 (6.5Mbps)
  - Test Mode 5: 802.11ac VHT40 (13.5Mbps)
  - Test Mode 6: 802.11ac VHT80 (29.3Mbps)

For conduction test, caused "Test Mode 1" generated the worst case, it was reported as the final data.  
 For radiated test (below 1GHz), caused "Test Mode 1" generated the worst case, it was reported as the final data.  
 For radiated test (above 1GHz), caused "Test Mode 1,4,5,6" generated the worst case, they were reported as the final data.

### 2.4. Description of Test System

The EUT was tested alone. No support devices are needed for testing.





## 2.5. General Information of Test

Test Site	<b>Cerpass Technology Corporation Test Laboratory</b> Address: No.10, Ln. 2, Lianfu St., Luzhu Dist., Taoyuan City 33848, Taiwan (R.O.C.) Tel:+886-3-3226-888 Fax:+886-3-3226-881 Address: No.68-1, Shihbachongsi, Shihding Township, New Taipei City 223, Taiwan, R.O.C. Tel: +886-2-2663-8582	
	FCC	TW1079, TW1061, 390316, 228391, 641184
	IC	4934E-1, 4934E-2
	VCCI	T-2205 for Telecommunication Test C-4663 for Conducted emission test R-4218, R-4399 for Radiated emission test G-812, G-813 for radiated disturbance above 1GHz
Frequency Range Investigated:	Conducted: from 150kHz to 30 MHz Radiation: from 30 MHz to 40,000MHz	
Test Distance:	The test distance of radiated emission from antenna to EUT is 3 M.	

## 2.6. Measurement Uncertainty

Measurement Item	Measurement Frequency	Polarization	Uncertainty
Conducted Emission	9 kHz ~ 30 MHz	Line / Neutral	±2.9076 dB
Radiated Emission	9 kHz ~ 25,000 MHz	Vertical / Horizontal	±0.948 dB
Spurious Emission (Conducted)	-	-	±4.011 dB
Maximum Peak and Average Output Power	-	-	±0.322 dB
Power Spectral Density	-	-	±0.322 dB
Bandwidth	-	-	74.224Hz



### 3. Test Equipment and Ancillaries Used for Tests

Instrument	Manufacturer	Model No.	Serial No.	Calibration Date	Valid Date
EMI Receiver	R&S	ESCI3	100443	2016/03/28	2017/03/27
LISN	Schwarzbeck	NSLK 8127	8127-740	2016/08/30	2017/08/29
LISN	Schwarzbeck	NSLK 8127	8127-516	2016/09/06	2017/09/05
Pulse Limiter	R&S	ESH3-Z2	101934	2017/02/14	2018/02/13
Bilog Antenna	Schwarzbeck	VULB9168	369	2016/03/22	2017/03/21
Active Loop Antenna	EMCO	6507	40855	2016/05/11	2017/05/10
Horn Antenna	EMCO	3115	31601	2016/09/05	2017/09/04
Horn Antenna	EMCO	3116	31970	2016/03/18	2017/03/17
EXA Signal Analyzer	KEYSIGHT	N9010A	MY54200207	2016/03/16	2017/03/15
Preamplifier	EM	EM330	660	2016/03/16	2017/03/15
Preamplifier	EMC INSTRUMENTS	EMC051845SE	980333	2016/09/13	2017/09/12
Preamplifier	Agilent	8449B	3008A01954	2017/02/09	2018/02/08
Preamplifier	MITEQ	AMF-7D-00101 00-30-10P	1860212	2016/03/16	2017/03/15
Preamplifier	EMC INSTRUMENTS	EMC184045	980065	2016/11/04	2017/11/03
MXG MW Analog Signal Generator	KEYSIGHT	N5183A	MY50142931	2016/03/18	2017/03/17
Spectrum Analyzer	R&S	FSP40	100219	2016/09/01	2017/08/31
Bluetooth Tester	R&S	CBT	101133	2016/03/18	2017/03/17
Attenuator	KEYSIGHT	8491B	MY39250703	2016/03/07	2017/03/06
Rotary Attenuator	Agilent	8494B	MY42154466	2016/03/08	2017/03/07
Rotary Attenuator	Agilent	8495B	MY42146680	2016/03/08	2017/03/07
Temp & Humi chamber	T-MACHINE	TMJ-9712	T-12-040111	2016/09/05	2017/09/04
Series Power Meter	Anritsu	ML2495A	1224005	2016/03/03	2017/03/02
Power Sensor	Anritsu	MA2411B	1207295	2016/03/03	2017/03/02
Cable	HUBER SUHNER	SUCOFLEX 102	28422/2	2016/03/15	2017/03/14
Cable	HUBER SUHNER	SUCOFLEX 102	28418/2	2016/03/16	2017/03/15
Cable	HUBER SUHNER	SUCOFLEX 102	28417/2	2016/03/04	2017/03/03
Software	Farad	Ez-EMC	ver.ct3a1	N/A	N/A
Software	AUDIX	E3	V8.2014-8-6	N/A	N/A
Software	Keysight	N7607B Signal Studio	v2.0.0.1	N/A	N/A
Software	Keysight	Inservice MonitorUtility	N/A	N/A	N/A



## 4. Antenna Requirements

### 4.1. Standard Applicable

For intentional device, according to FCC 47 CFR Section 15.203, an intentional radiator shall be designed to ensure that no antenna other than that furnished by the responsible party shall be used with the device.

And according to FCC 47 CFR Section 15.407 (a), if transmitting antennas of directional gain greater than 6dBi are used, the power shall be reduced by the amount in dB that the directional gain of the antenna exceeds 6dBi.

### 4.2. Antenna Construction and Directional Gain

Antenna Type	Antenna Gain
PCB Antenna	Antenna A: 0.59 dBi
	Antenna B: 1.85 dBi

For Power directional gain=  $G_{ant} = 1.85$  dBi

For PSD directional gain =  $10 \log[(10^{G1/20} + 10^{G2/20} + \dots + 10^{GN/20})^2 / NANT]$   
= 4.25 (dBi)



## 5. Test of AC Power Line Conducted Emission

### 5.1. Test Limit

Conducted Emissions were measured from 150 kHz to 30 MHz with a bandwidth of 9 KHz, according to the methods defined in ANSI C63.4-2014. The EUT was placed on a nonmetallic stand in a shielded room 0.8 meters above the ground plane. The interface cables and equipment positioning were varied within limits of reasonable applications to determine the position produced maximum conducted emissions.

Frequency (MHz)	Quasi Peak (dB $\mu$ V)	Average (dB $\mu$ V)
0.15 – 0.5	66-56*	56-46*
0.5 – 5.0	56	46
5.0 – 30.0	60	50

\*Decreases with the logarithm of the frequency.

### 5.2. Test Procedures

- The EUT was placed 0.4 meter from the conducting wall of the shielding room was kept at least 80 centimeters from any other grounded conducting surface.
- Connect EUT to the power mains through a line impedance stabilization network (LISN).
- All the support units are connecting to the other LISN.
- The LISN provides 50 ohm coupling impedance for the measuring instrument.
- The FCC states that a 50 ohm, 50 micro-Henry LISN should be used.
- Both sides of AC line were checked for maximum conducted interference.
- The frequency range from 150 kHz to 30 MHz was searched.
- Set the test-receiver system to Peak Detect Function and Specified Bandwidth with Maximum Hold Mode.



### 5.3. Typical Test Setup

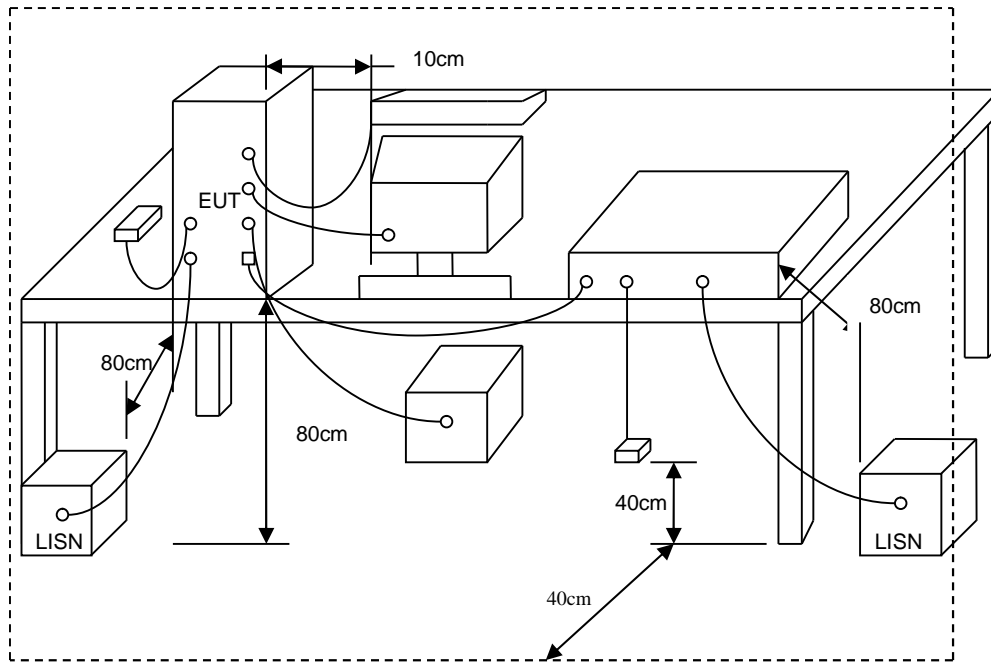



### 5.4. Test Result and Data

Power	: AC 120V	Pol/Phase	: LINE
Test Mode	: Mode 1, CH36	Temperature	: 22 °C
Test date	: Feb. 18, 2017	Humidity	: 56 %

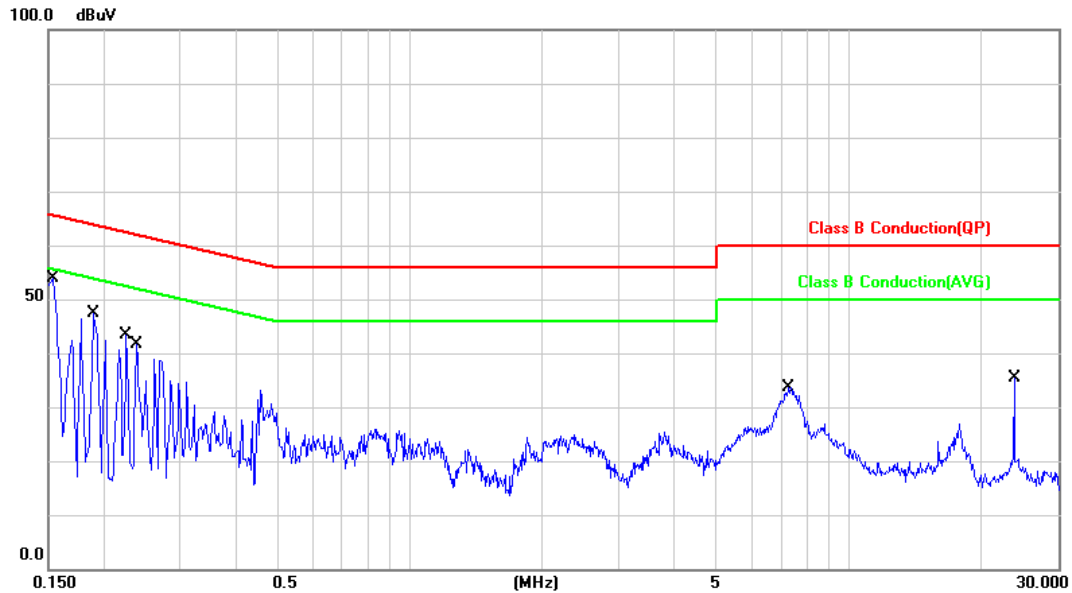

No.	Frequency (MHz)	Factor (dB)	Reading (dBuV)	Level (dBuV)	Limit (dBuV)	Margin (dB)	Detector	P/F
1	0.1539	9.98	41.64	51.62	65.78	-14.16	QP	P
2	0.1539	9.98	23.93	33.91	55.78	-21.87	AVG	P
3	0.1900	9.97	36.03	46.00	64.03	-18.03	QP	P
4	0.1900	9.97	18.56	28.53	54.03	-25.50	AVG	P
5	0.2260	9.97	31.15	41.12	62.59	-21.47	QP	P
6	0.2260	9.97	13.75	23.72	52.59	-28.87	AVG	P
7	0.2380	9.97	26.80	36.77	62.16	-25.39	QP	P
8	0.2380	9.97	7.02	16.99	52.16	-35.17	AVG	P
9	7.3260	10.21	19.31	29.52	60.00	-30.48	QP	P
10	7.3260	10.21	14.92	25.13	50.00	-24.87	AVG	P
11	23.8740	10.59	23.51	34.10	60.00	-25.90	QP	P
12	23.8740	10.59	23.62	34.21	50.00	-15.79	AVG	P

Note: Level = Reading + Factor  
Margin = Level – Limit  
Factor = (LISN, ISN, PLC or current probe) Factor + Cable Loss+ Attenuator



Power	: AC 120V	Pol/Phase	: NEUTRAL
Test Mode	: Mode 1, CH36	Temperature	: 22 °C
Test date	: Feb. 18, 2017	Humidity	: 56 %

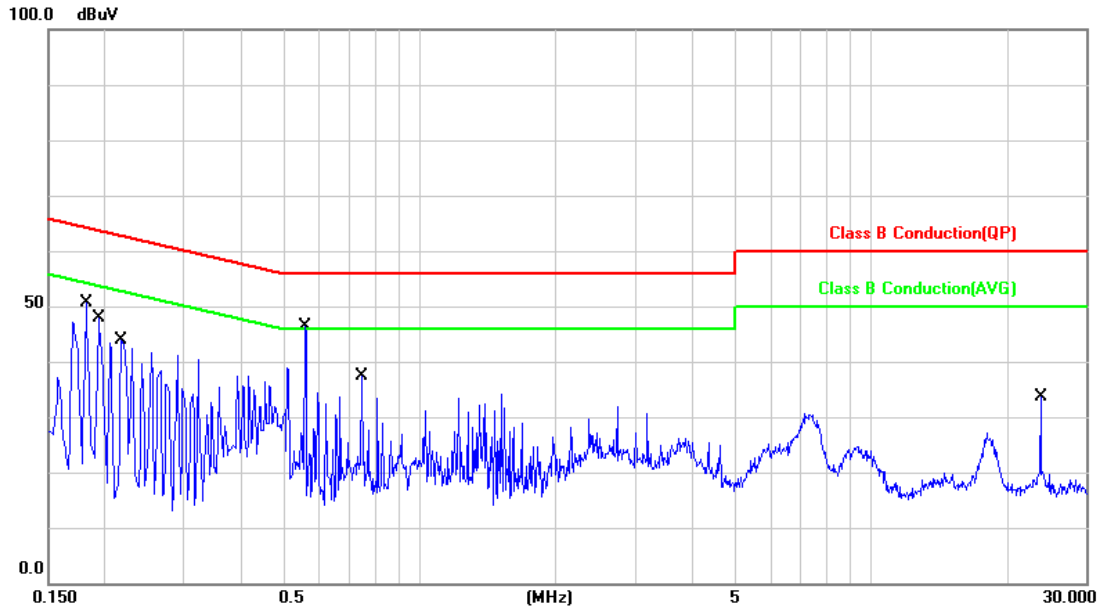

No.	Frequency (MHz)	Factor (dB)	Reading (dBuV)	Level (dBuV)	Limit (dBuV)	Margin (dB)	Detector	P/F
1	0.1819	9.98	36.17	46.15	64.39	-18.24	QP	P
2	0.1819	9.98	16.68	26.66	54.39	-27.73	AVG	P
3	0.1940	9.98	35.30	45.28	63.86	-18.58	QP	P
4	0.1940	9.98	16.52	26.50	53.86	-27.36	AVG	P
5	0.2180	9.98	31.36	41.34	62.89	-21.55	QP	P
6	0.2180	9.98	10.96	20.94	52.89	-31.95	AVG	P
7	0.5580	9.95	14.27	24.22	56.00	-31.78	QP	P
8	0.5580	9.95	0.32	10.27	46.00	-35.73	AVG	P
9	0.7460	9.97	19.17	29.14	56.00	-26.86	QP	P
10	0.7460	9.97	2.69	12.66	46.00	-33.34	AVG	P
11	23.8740	10.64	22.21	32.85	60.00	-27.15	QP	P
12	23.8740	10.64	22.30	32.94	50.00	-17.06	AVG	P

Note: Level = Reading + Factor  
 Margin = Level – Limit  
 Factor = (LISN, ISN, PLC or current probe) Factor + Cable Loss+ Attenuator



Power	: AC 120V	Pol/Phase	: LINE
Test Mode	: Mode 1, CH52	Temperature	: 22 °C
Test date	: Feb. 18, 2017	Humidity	: 56 %

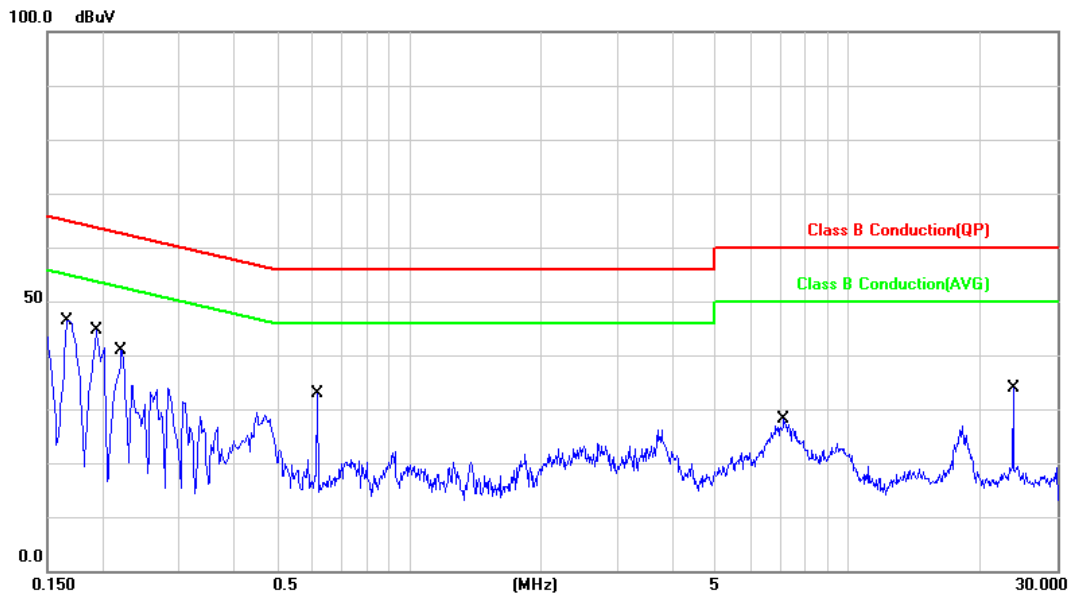

No.	Frequency (MHz)	Factor (dB)	Reading (dBuV)	Level (dBuV)	Limit (dBuV)	Margin (dB)	Detector	P/F
1	0.1660	9.98	36.06	46.04	65.15	-19.11	QP	P
2	0.1660	9.98	19.57	29.55	55.15	-25.60	AVG	P
3	0.1940	9.98	32.00	41.98	63.86	-21.88	QP	P
4	0.1940	9.98	15.78	25.76	53.86	-28.10	AVG	P
5	0.2220	9.97	28.42	38.39	62.74	-24.35	QP	P
6	0.2220	9.97	12.13	22.10	52.74	-30.64	AVG	P
7	0.6180	9.95	3.52	13.47	56.00	-42.53	QP	P
8	0.6180	9.95	-0.92	9.03	46.00	-36.97	AVG	P
9	7.1660	10.24	13.10	23.34	60.00	-36.66	QP	P
10	7.1660	10.24	8.17	18.41	50.00	-31.59	AVG	P
11	23.8740	10.64	22.14	32.78	60.00	-27.22	QP	P
12	23.8740	10.64	22.28	32.92	50.00	-17.08	AVG	P

Note: Level = Reading + Factor  
Margin = Level – Limit  
Factor = (LISN, ISN, PLC or current probe) Factor + Cable Loss+ Attenuator





Power	: AC 120V	Pol/Phase	: NEUTRAL
Test Mode	: Mode 1, CH52	Temperature	: 22 °C
Test date	: Feb. 18, 2017	Humidity	: 56 %

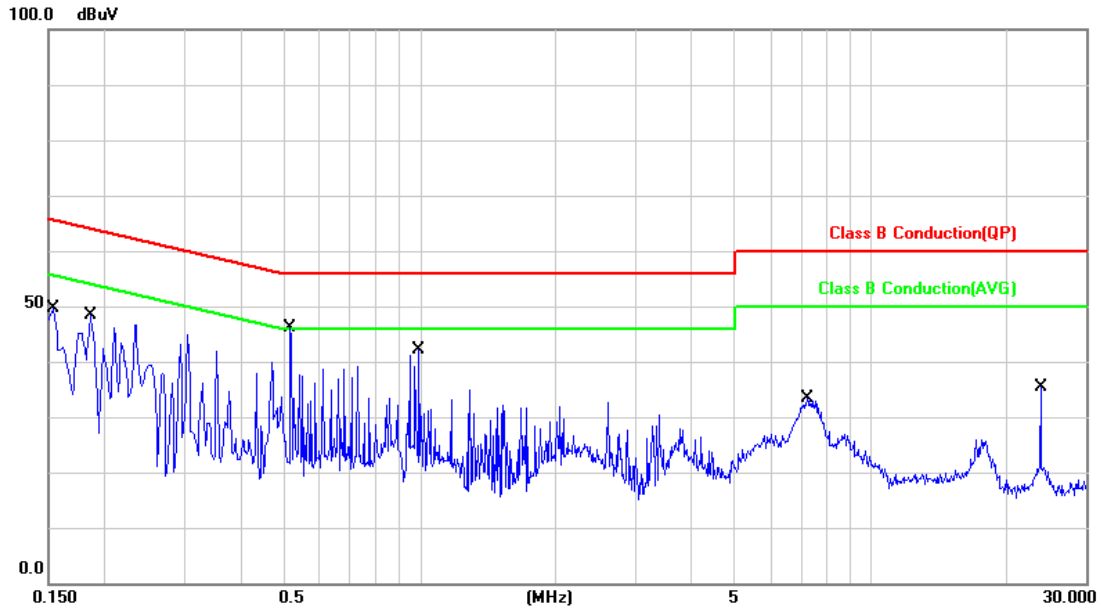

No.	Frequency (MHz)	Factor (dB)	Reading (dBuV)	Level (dBuV)	Limit (dBuV)	Margin (dB)	Detector	P/F
1	0.1539	9.98	31.15	41.13	65.78	-24.65	QP	P
2	0.1539	9.98	11.28	21.26	55.78	-34.52	AVG	P
3	0.1860	9.97	23.88	33.85	64.21	-30.36	QP	P
4	0.1860	9.97	6.34	16.31	54.21	-37.90	AVG	P
5	0.5180	9.98	8.18	18.16	56.00	-37.84	QP	P
6	0.5180	9.98	2.09	12.07	46.00	-33.93	AVG	P
7	0.9980	10.03	5.44	15.47	56.00	-40.53	QP	P
8	0.9980	10.03	1.92	11.95	46.00	-34.05	AVG	P
9	7.2140	10.21	15.55	25.76	60.00	-34.24	QP	P
10	7.2140	10.21	10.99	21.20	50.00	-28.80	AVG	P
11	23.8740	10.59	23.41	34.00	60.00	-26.00	QP	P
12	23.8740	10.59	23.56	34.15	50.00	-15.85	AVG	P

Note: Level = Reading + Factor

Margin = Level – Limit

Factor = (LISN, ISN, PLC or current probe) Factor + Cable Loss+ Attenuator



Power	: AC 120V	Pol/Phase	: LINE
Test Mode	: Mode 1, CH149	Temperature	: 22 °C
Test date	: Feb. 18, 2017	Humidity	: 56 %

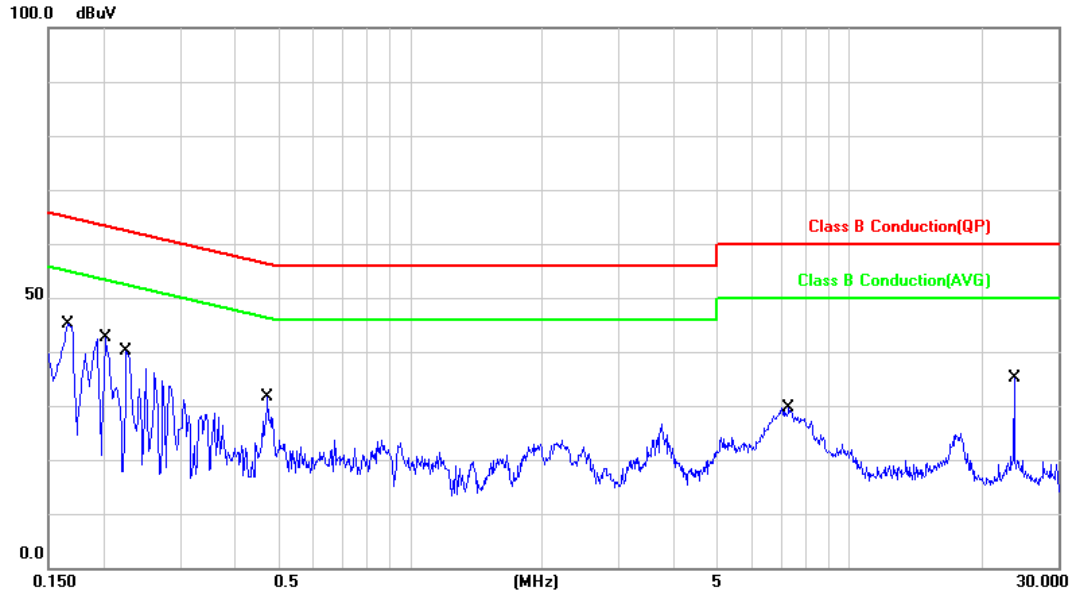

No.	Frequency (MHz)	Factor (dB)	Reading (dBuV)	Level (dBuV)	Limit (dBuV)	Margin (dB)	Detector	P/F
1	0.1660	9.98	36.15	46.13	65.15	-19.02	QP	P
2	0.1660	9.98	19.18	29.16	55.15	-25.99	AVG	P
3	0.2020	9.97	36.64	46.61	63.52	-16.91	QP	P
4	0.2020	9.97	16.02	25.99	53.52	-27.53	AVG	P
5	0.2260	9.97	32.98	42.95	62.59	-19.64	QP	P
6	0.2260	9.97	14.11	24.08	52.59	-28.51	AVG	P
7	0.4740	9.97	25.01	34.98	56.44	-21.46	QP	P
8	0.4740	9.97	10.30	20.27	46.44	-26.17	AVG	P
9	7.3020	10.21	19.21	29.42	60.00	-30.58	QP	P
10	7.3020	10.21	14.81	25.02	50.00	-24.98	AVG	P
11	23.8700	10.59	21.33	31.92	60.00	-28.08	QP	P
12	23.8700	10.59	21.41	32.00	50.00	-18.00	AVG	P

Note: Level = Reading + Factor  
Margin = Level – Limit  
Factor = (LISN, ISN, PLC or current probe) Factor + Cable Loss+ Attenuator



Power	: AC 120V	Pol/Phase	: NEUTRAL
Test Mode	: Mode 1, CH149	Temperature	: 22 °C
Test date	: Feb. 18, 2017	Humidity	: 56 %

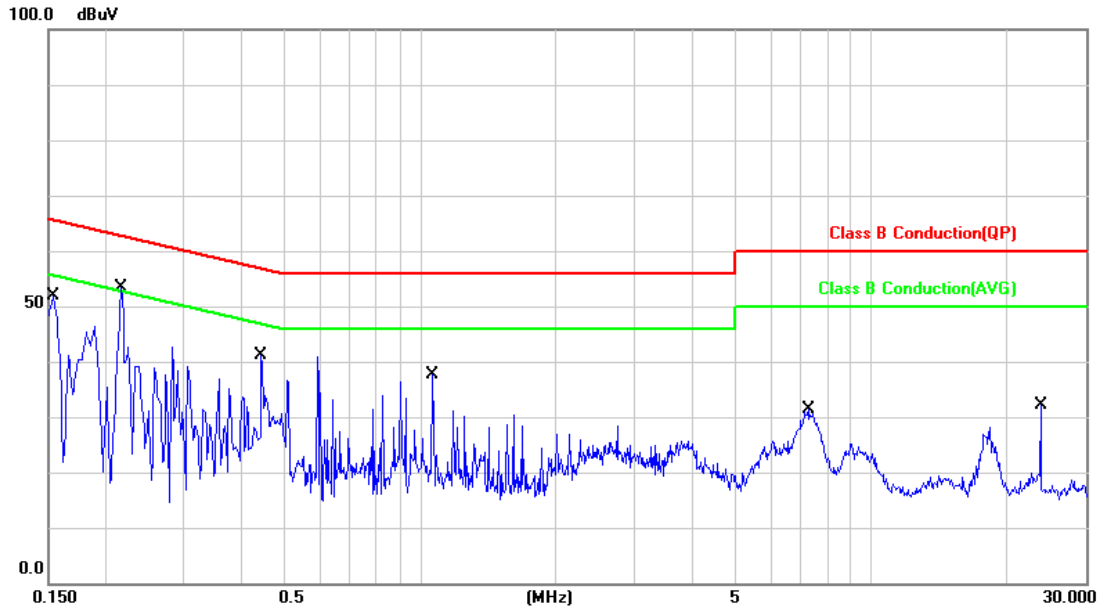

No.	Frequency (MHz)	Factor (dB)	Reading (dBuV)	Level (dBuV)	Limit (dBuV)	Margin (dB)	Detector	P/F
1	0.1539	9.98	41.12	51.10	65.78	-14.68	QP	P
2	0.1539	9.98	23.81	33.79	55.78	-21.99	AVG	P
3	0.2180	9.98	30.61	40.59	62.89	-22.30	QP	P
4	0.2180	9.98	10.13	20.11	52.89	-32.78	AVG	P
5	0.4460	9.94	17.50	27.44	56.95	-29.51	QP	P
6	0.4460	9.94	7.59	17.53	46.95	-29.42	AVG	P
7	1.0660	9.99	7.80	17.79	56.00	-38.21	QP	P
8	1.0660	9.99	1.26	11.25	46.00	-34.75	AVG	P
9	7.2700	10.24	17.05	27.29	60.00	-32.71	QP	P
10	7.2700	10.24	11.97	22.21	50.00	-27.79	AVG	P
11	23.8740	10.64	20.26	30.90	60.00	-29.10	QP	P
12	23.8740	10.64	20.36	31.00	50.00	-19.00	AVG	P

Note: Level = Reading + Factor  
Margin = Level – Limit  
Factor = (LISN, ISN, PLC or current probe) Factor + Cable Loss+ Attenuator



## 6. Test of Spurious Emission (Radiated)

### 6.1. Test Limit

Undesirable emission limits. Except as shown in paragraph (b)(7) of this section, the maximum emissions outside of the frequency bands of operation shall be attenuated in accordance with the following limits:

- (1) For transmitters operating in the 5.15-5.25 GHz band: All emissions outside of the 5.15-5.35 GHz band shall not exceed an e.i.r.p. of  $-27$  dBm/MHz.
- (2) For transmitters operating in the 5.25-5.35 GHz band: All emissions outside of the 5.15-5.35 GHz band shall not exceed an e.i.r.p. of  $-27$  dBm/MHz.
- (3) For transmitters operating in the 5.47-5.725 GHz band: All emissions outside of the 5.47-5.725 GHz band shall not exceed an e.i.r.p. of  $-27$  dBm/MHz.
- (4) For transmitters operating in the 5.725-5.85 GHz band:  
All emissions shall be limited to a level of  $-27$  dBm/MHz at 75 MHz or more above or below the band edge increasing linearly to 10 dBm/MHz at 25 MHz above or below the band edge, and from 25MHz above or below the band edge increasing linearly to a level of 15.6 dBm/MHz at 5 MHz above or below the band edge, and from 5 MHz above or below the band edge increasing linearly to a level of 27dBm/MHz at the band edge.
- (5) The emission measurements shall be performed using a minimum resolution bandwidth of 1 MHz. A lower resolution bandwidth may be employed near the band edge, when necessary, provided the measured energy is integrated to show the total power over 1 MHz.
- (6) Unwanted emissions below 1 GHz must comply with the general field strength limits set forth in §15.209. Further, any U-NII devices using an AC power line are required to comply also with the conducted limits set forth in §15.207.
- (7) The provisions of §15.205 apply to intentional radiators operating under this section.
- (8) When measuring the emission limits, the nominal carrier frequency shall be adjusted as close to the upper and lower frequency band edges as the design of the equipment permits.

### 6.2. Test Procedures

- a. The EUT was placed on a rotatable table top 0.8 meter above ground.
- b. The EUT was set 3 meters from the interference receiving antenna which was mounted on the top of a variable height antenna tower.
- c. The table was rotated 360 degrees to determine the position of the highest radiation.
- d. The antenna is a broadband antenna and its height is varied between one meter and four meters above ground to find the maximum value of the field strength both horizontal polarization and vertical polarization of the antenna are set to make the measurement.
- e. For each suspected emission the EUT was arranged to its worst case and then tune the antenna tower (from 1 M to 4 M) and turn table (from 0 degree to 360 degrees) to find the maximum reading.
- f. Set the test-receiver system to Peak or CISPR quasi-peak Detect Function and specified bandwidth with Maximum Hold Mode.
- g. If the emission level of the EUT in peak mode was 3 dB lower than the limit specified, then testing will be stopped and peak values of EUT will be reported, otherwise, the emissions which do not have 3 dB margin will be repeated one by one using the quasi-peak method and reported.
- h. For testing above 1GHz, the emission level of the EUT in peak mode was 20dB lower than average limit (that means the emission level in peak mode also complies with the limit in average mode), then testing will be stopped and peak values of EUT will be reported, otherwise, the emissions will be measured in average mode again and reported.
- i. "Cone of radiation" has been considered to be 3dB bandwidth of the measurement antenna.



### 6.3. Typical Test Setup

Below 30MHz test setup

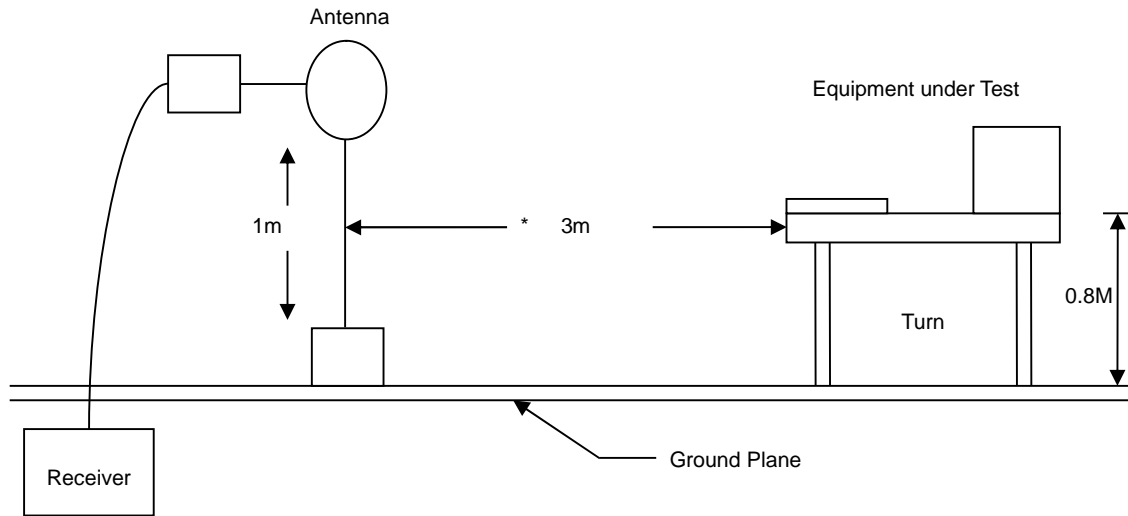

30MHz- 1GHz Test Setup

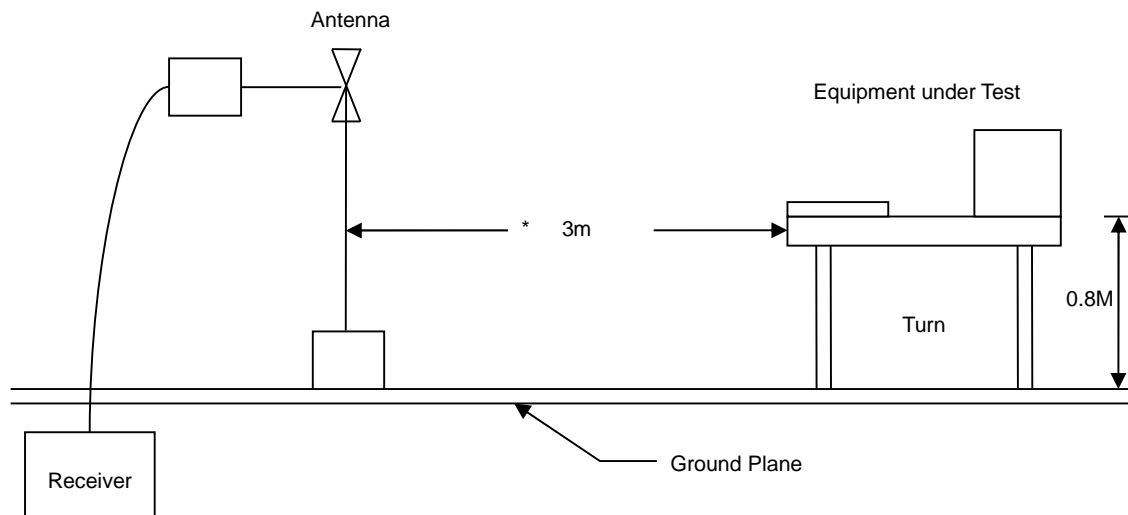

Above 1GHz Test Setup

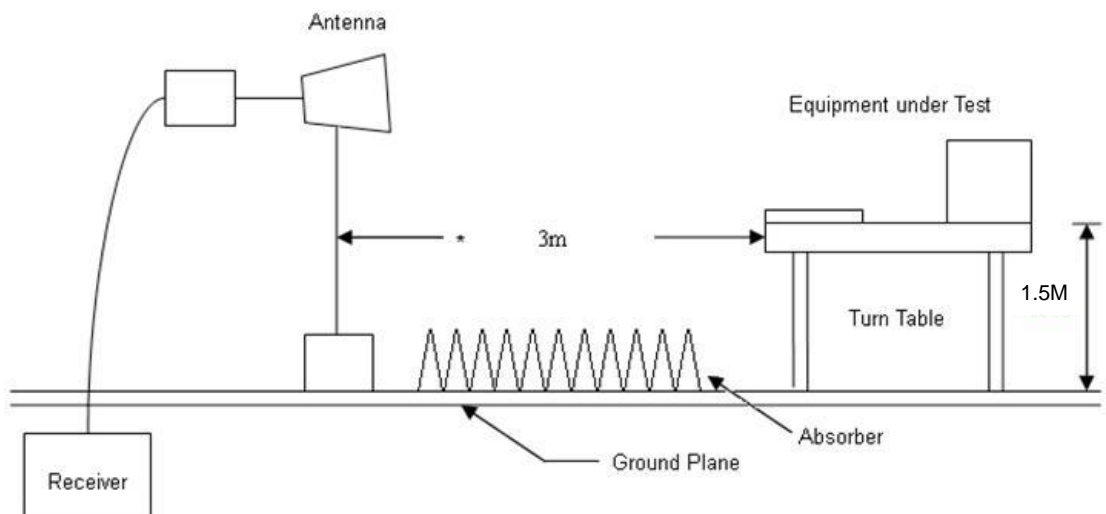



6.4. Test Result and Data (9kHz ~ 30MHz)

The 9kHz - 30MHz spurious emission is under limit 20dB more.

6.5. Test Result and Data (30MHz ~ 1GHz)

Power	: AC 120V	Pol/Phase	: VERTICAL
Test Mode	: Mode 1, CH36	Temperature	: 24 °C
Test Date	: Feb. 20, 2017	Humidity	: 63 %

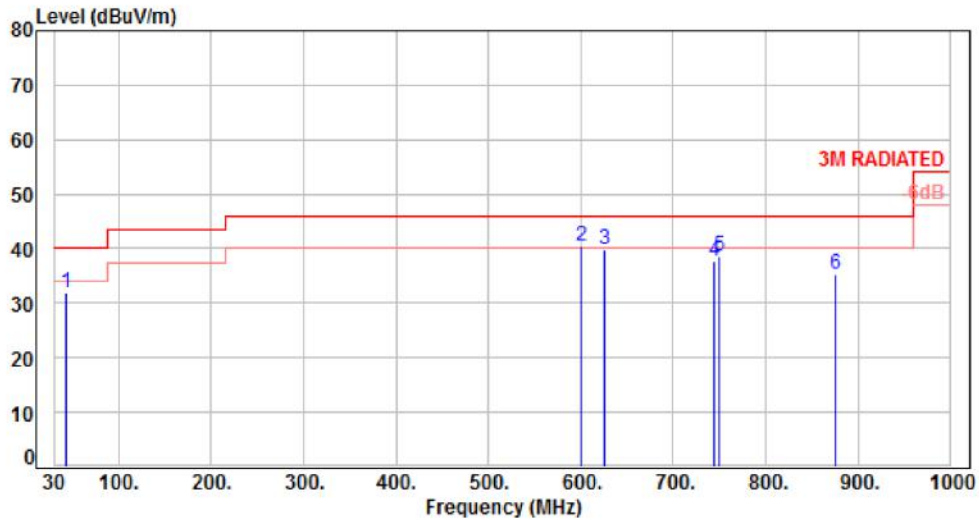

No.	Frequency (MHz)	Factor (dB)	Reading (dBUV)	Level (dBUV)	Limit (dBUV)	Margin (dB)	Detector	Height (cm)	Azimuth (deg)	P/F
1	43.58	-9.87	41.86	31.99	40.00	-8.01	Peak	100	0	P
2	600.36	-1.98	42.51	40.53	46.00	-5.47	Peak	100	0	P
3	625.58	-1.70	41.67	39.97	46.00	-6.03	Peak	100	0	P
4	743.92	0.27	37.41	37.68	46.00	-8.32	Peak	100	0	P
5	749.74	0.38	38.25	38.63	46.00	-7.37	Peak	100	0	P
6	875.84	1.87	33.46	35.33	46.00	-10.67	Peak	100	0	P

Note: Level=Reading+Factor  
Margin=Level-Limit  
Factor=Antenna Factor + cable loss - Amplifier Factor



Power	: AC 120V	Pol/Phase	: HORIZONTAL
Test Mode	: Mode 1, CH36	Temperature	: 24 °C
Test Date	: Feb. 20, 2017	Humidity	: 63 %

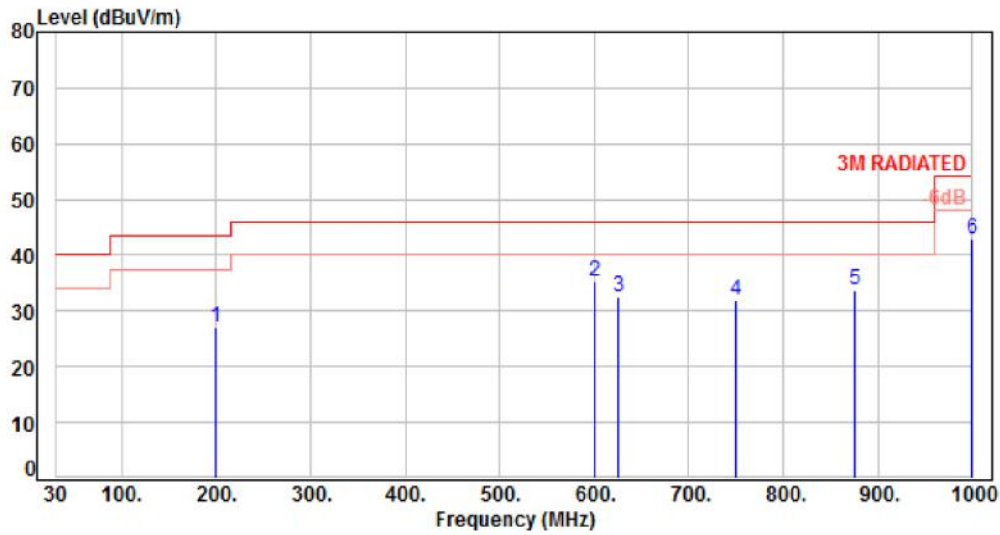

No.	Frequency (MHz)	Factor (dB)	Reading (dBuV)	Level (dBuV)	Limit (dBuV)	Margin (dB)	Detector	Height (cm)	Azimuth (deg)	P/F
1	198.78	-12.50	39.52	27.02	43.50	-16.48	Peak	100	0	P
2	600.36	-1.98	37.34	35.36	46.00	-10.64	Peak	100	0	P
3	625.58	-1.70	34.27	32.57	46.00	-13.43	Peak	100	0	P
4	749.74	0.38	31.56	31.94	46.00	-14.06	Peak	100	0	P
5	875.84	1.87	31.97	33.84	46.00	-12.16	Peak	100	0	P
6	1000.00	3.44	39.49	42.93	54.00	-11.07	Peak	100	0	P

Note: Level=Reading+Factor  
 Margin=Level-Limit  
 Factor=Antenna Factor + cable loss - Amplifier Factor



Power	: AC 120V	Pol/Phase	: VERTICAL
Test Mode	: Mode 1, CH149	Temperature	: 24 °C
Test Date	: Feb. 20, 2017	Humidity	: 63 %

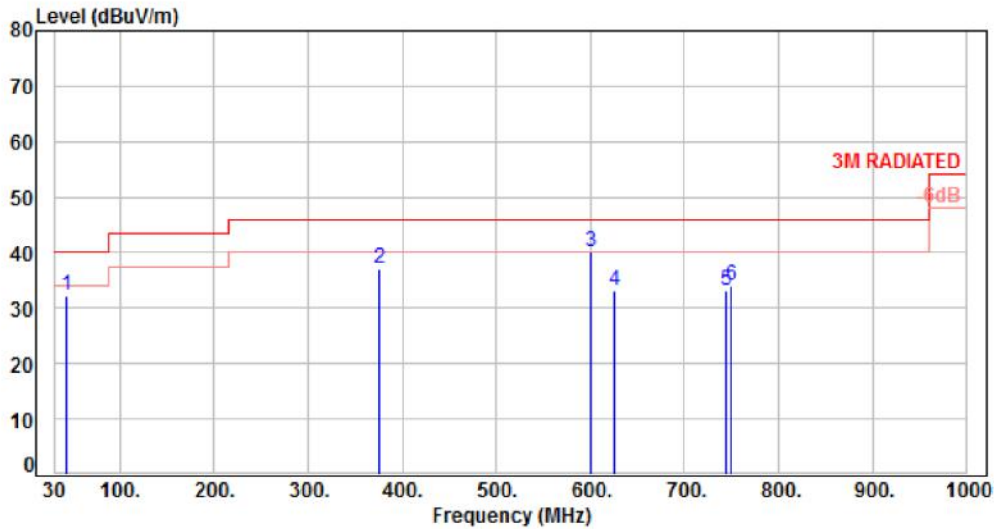

No.	Frequency (MHz)	Factor (dB)	Reading (dBuV)	Level (dBuV)	Limit (dBuV)	Margin (dB)	Detector	Height (cm)	Azimuth (deg)	P/F
1	43.58	-9.87	42.08	32.21	40.00	-7.79	Peak	100	0	P
2	375.32	-7.06	44.13	37.07	46.00	-8.93	Peak	100	0	P
3	600.36	-1.98	42.26	40.28	46.00	-5.72	Peak	100	0	P
4	625.58	-1.70	34.85	33.15	46.00	-12.85	Peak	100	0	P
5	743.92	0.27	32.98	33.25	46.00	-12.75	Peak	100	0	P
6	749.74	0.38	33.70	34.08	46.00	-11.92	Peak	100	0	P

Note: Level=Reading+Factor  
Margin=Level-Limit  
Factor=Antenna Factor + cable loss - Amplifier Factor





Power	: AC 120V	Pol/Phase	: HORIZONTAL
Test Mode	: Mode 1, CH149	Temperature	: 24 °C
Test Date	: Feb. 20, 2017	Humidity	: 63 %

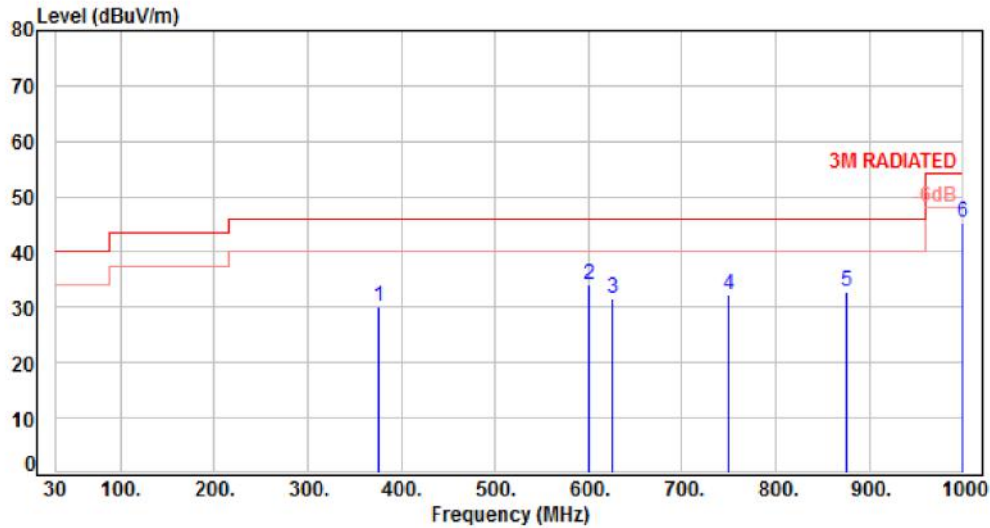

No.	Frequency (MHz)	Factor (dB)	Reading (dBuV)	Level (dBuV)	Limit (dBuV)	Margin (dB)	Detector	Height (cm)	Azimuth (deg)	P/F
1	375.32	-7.06	37.27	30.21	46.00	-15.79	Peak	100	0	P
2	600.36	-1.98	36.09	34.11	46.00	-11.89	Peak	100	0	P
3	625.58	-1.70	33.28	31.58	46.00	-14.42	Peak	100	0	P
4	749.74	0.38	31.84	32.22	46.00	-13.78	Peak	100	0	P
5	875.84	1.87	30.99	32.86	46.00	-13.14	Peak	100	0	P
6	1000.00	3.44	41.80	45.24	54.00	-8.76	Peak	100	0	P

Note: Level=Reading+Factor  
Margin=Level-Limit  
Factor=Antenna Factor + cable loss - Amplifier Factor



6.6. Test Result and Data (1GHz ~ 40GHz)

Power	: AC 120V	Pol/Phase	: VERTICAL
Test Mode	: Mode 1, CH36	Temperature	: 24°C
Test Date	: Feb. 16, 2017	Humidity	: 63%

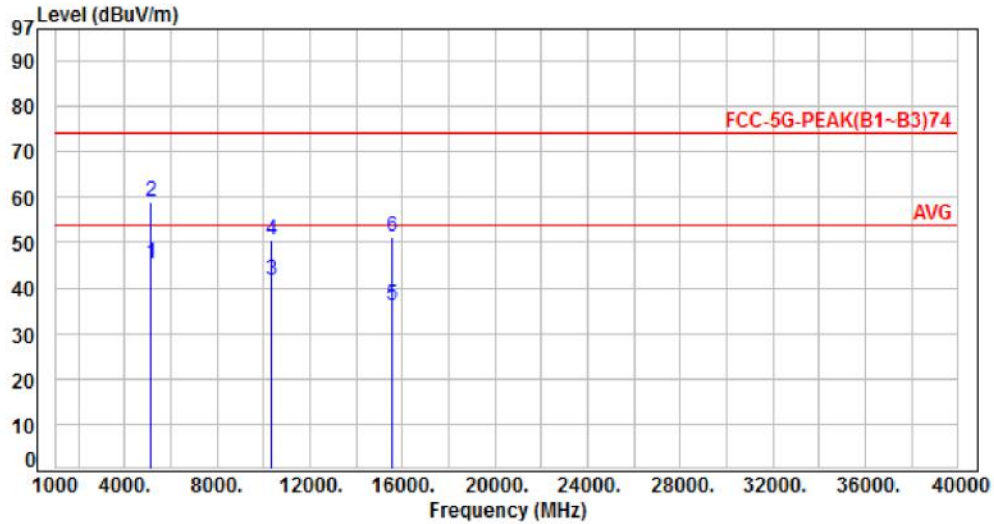

No.	Frequency (MHz)	Factor (dB)	Reading (dBuV)	Level (dBuV)	Limit (dBuV)	Margin (dB)	Detector	Height (cm)	Azimuth (deg)	P/F
1	5150.00	-6.54	52.04	45.50	54.00	-8.50	Average	100	145	P
2	5150.00	-6.54	65.37	58.83	74.00	-15.17	Peak	100	145	P
3	10360.00	0.66	40.87	41.53	54.00	-12.47	Average	100	304	P
4	10360.00	0.66	50.01	50.67	74.00	-23.33	Peak	100	304	P
5	15540.00	5.36	30.80	36.16	54.00	-17.84	Average	112	316	P
6	15540.00	5.36	45.86	51.22	74.00	-22.78	Peak	112	316	P

Note: Level=Reading+Factor  
 Margin=Level-Limit  
 Factor=Antenna Factor + cable loss - Amplifier Factor



Power	: AC 120V	Pol/Phase	: HORIZONTAL
Test Mode	: Mode 1, CH36	Temperature	: 24°C
Test Date	: Feb. 16, 2017	Humidity	: 63%

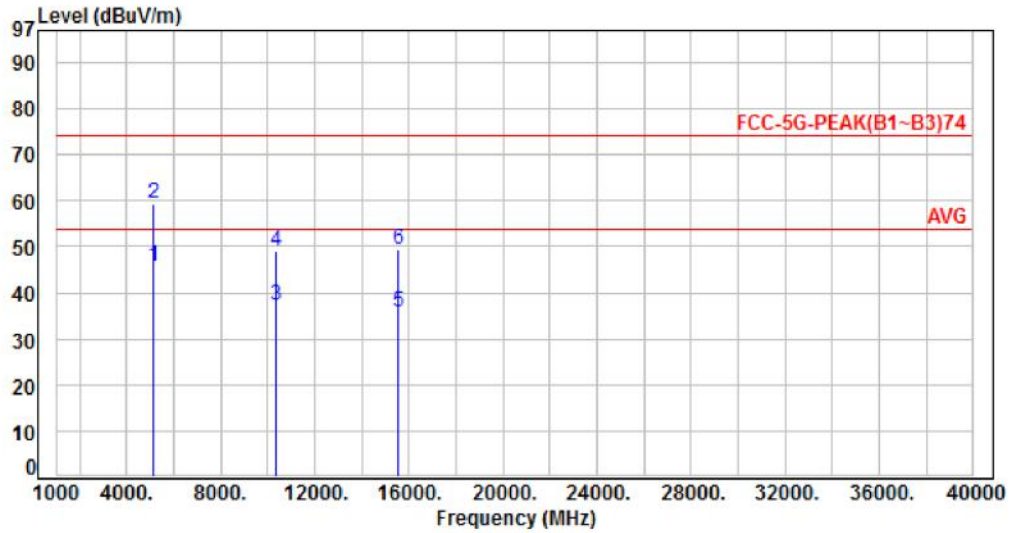

No.	Frequency (MHz)	Factor (dB)	Reading (dBuV)	Level (dBuV)	Limit (dBuV)	Margin (dB)	Detector	Height (cm)	Azimuth (deg)	P/F
1	5150.00	-6.54	52.40	45.86	54.00	-8.14	Average	100	179	P
2	5150.00	-6.54	65.84	59.30	74.00	-14.70	Peak	100	179	P
3	10360.00	0.66	36.73	37.39	54.00	-16.61	Average	100	134	P
4	10360.00	0.66	48.24	48.90	74.00	-25.10	Peak	100	134	P
5	15540.00	5.36	30.51	35.87	54.00	-18.13	Average	100	182	P
6	15540.00	5.36	43.99	49.35	74.00	-24.65	Peak	100	182	P

Note: Level=Reading+Factor  
 Margin=Level-Limit  
 Factor=Antenna Factor + cable loss - Amplifier Factor



Power	: AC 120V	Pol/Phase	: VERTICAL
Test Mode	: Mode 1, CH44	Temperature	: 24°C
Test Date	: Feb. 16, 2017	Humidity	: 63%

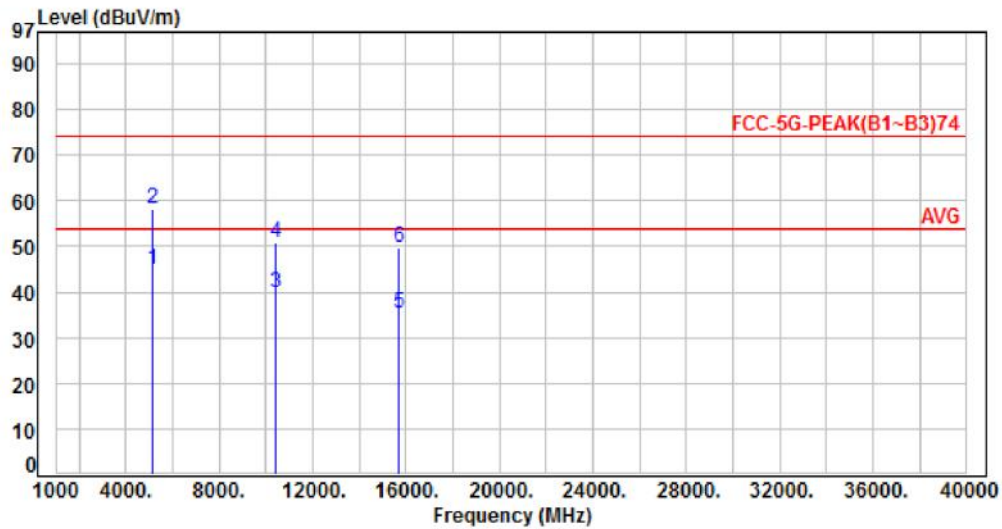

No.	Frequency (MHz)	Factor (dB)	Reading (dBuV)	Level (dBuV)	Limit (dBuV)	Margin (dB)	Detector	Height (cm)	Azimuth (deg)	P/F
1	5150.00	-6.54	51.65	45.11	54.00	-8.89	Average	133	201	P
2	5150.00	-6.54	64.88	58.34	74.00	-15.66	Peak	133	201	P
3	10440.00	0.70	39.15	39.85	54.00	-14.15	Average	122	261	P
4	10440.00	0.70	50.14	50.84	74.00	-23.16	Peak	122	261	P
5	15660.00	5.38	30.06	35.44	54.00	-18.56	Average	103	214	P
6	15660.00	5.38	44.23	49.61	74.00	-24.39	Peak	103	214	P

Note: Level=Reading+Factor  
Margin=Level-Limit  
Factor=Antenna Factor + cable loss - Amplifier Factor



Power	: AC 120V	Pol/Phase	: HORIZONTAL
Test Mode	: Mode 1, CH44	Temperature	: 24°C
Test Date	: Feb. 16, 2017	Humidity	: 63%

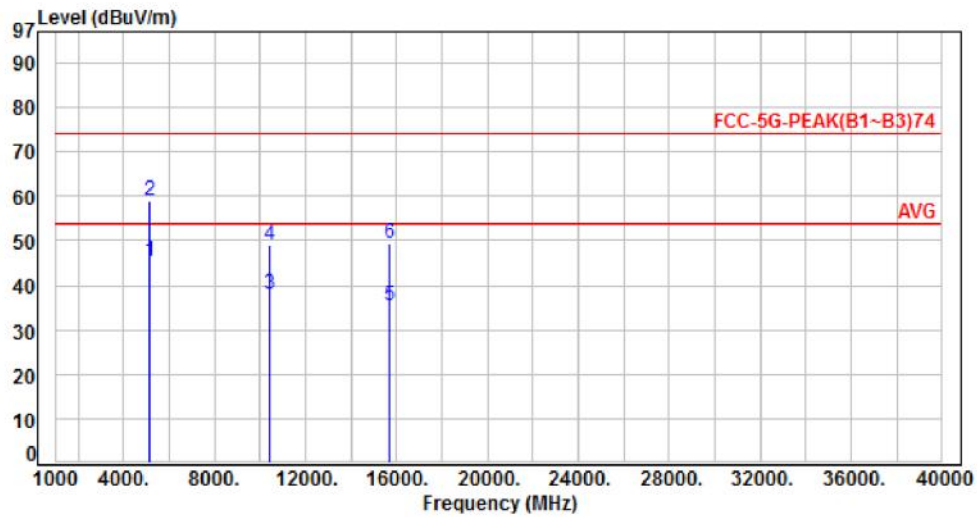

No.	Frequency (MHz)	Factor (dB)	Reading (dBuV)	Level (dBuV)	Limit (dBuV)	Margin (dB)	Detector	Height (cm)	Azimuth (deg)	P/F
1	5150.00	-6.54	51.94	45.40	54.00	-8.60	Average	100	145	P
2	5150.00	-6.54	65.53	58.99	74.00	-15.01	Peak	100	145	P
3	10440.00	0.70	37.26	37.96	54.00	-16.04	Average	103	298	P
4	10440.00	0.70	48.24	48.94	74.00	-25.06	Peak	103	298	P
5	15660.00	5.38	29.88	35.26	54.00	-18.74	Average	110	312	P
6	15660.00	5.38	43.96	49.34	74.00	-24.66	Peak	110	312	P

Note: Level=Reading+Factor  
 Margin=Level-Limit  
 Factor=Antenna Factor + cable loss - Amplifier Factor



Power	: AC 120V	Pol/Phase	: VERTICAL
Test Mode	: Mode 1, CH48	Temperature	: 24°C
Test Date	: Feb. 16, 2017	Humidity	: 63%

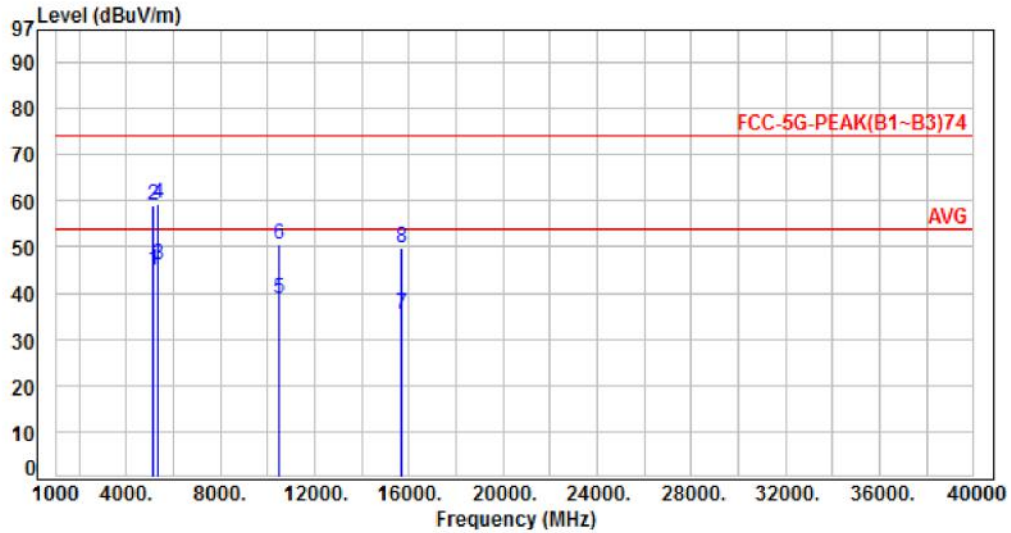

No.	Frequency (MHz)	Factor (dB)	Reading (dBuV)	Level (dBuV)	Limit (dBuV)	Margin (dB)	Detector	Height (cm)	Azimuth (deg)	P/F
1	5150.00	-6.54	51.71	45.17	54.00	-8.83	Average	116	301	P
2	5150.00	-6.54	65.42	58.88	74.00	-15.12	Peak	116	301	P
3	5350.00	-6.06	52.17	46.11	54.00	-7.89	Average	116	301	P
4	5350.00	-6.06	65.35	59.29	74.00	-14.71	Peak	116	301	P
5	10480.00	0.73	38.16	38.89	54.00	-15.11	Average	122	163	P
6	10480.00	0.73	49.71	50.44	74.00	-23.56	Peak	122	163	P
7	15720.00	5.37	30.08	35.45	54.00	-18.55	Average	127	93	P
8	15720.00	5.37	44.32	49.69	74.00	-24.31	Peak	127	93	P

Note: Level=Reading+Factor  
 Margin=Level-Limit  
 Factor=Antenna Factor + cable loss - Amplifier Factor



Power	: AC 120V	Pol/Phase	: HORIZONTAL
Test Mode	: Mode 1, CH48	Temperature	: 24°C
Test Date	: Feb. 16, 2017	Humidity	: 63%

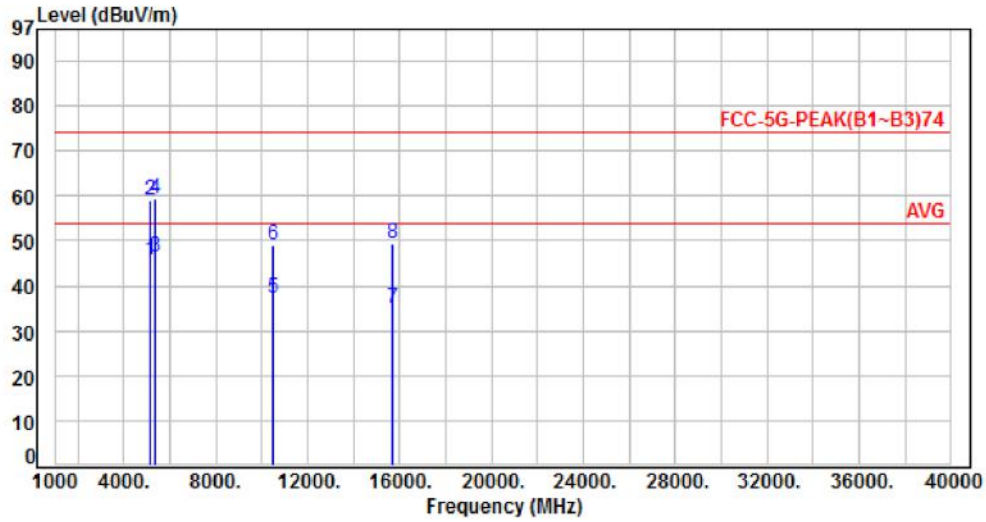

No.	Frequency (MHz)	Factor (dB)	Reading (dBuV)	Level (dBuV)	Limit (dBuV)	Margin (dB)	Detector	Height (cm)	Azimuth (deg)	P/F
1	5150.00	-6.54	52.17	45.63	54.00	-8.37	Average	100	151	P
2	5150.00	-6.54	65.60	59.06	74.00	-14.94	Peak	100	151	P
3	5350.00	-6.06	52.41	46.35	54.00	-7.65	Average	100	151	P
4	5350.00	-6.06	65.61	59.55	74.00	-14.45	Peak	100	151	P
5	10480.00	0.73	36.35	37.08	54.00	-16.92	Average	100	312	P
6	10480.00	0.73	48.41	49.14	74.00	-24.86	Peak	100	312	P
7	15720.00	5.37	29.84	35.21	54.00	-18.79	Average	106	308	P
8	15720.00	5.37	43.91	49.28	74.00	-24.72	Peak	106	308	P

Note: Level=Reading+Factor  
 Margin=Level-Limit  
 Factor=Antenna Factor + cable loss - Amplifier Factor



Power	: AC 120V	Pol/Phase	: VERTICAL
Test Mode	: Mode 1, CH52	Temperature	: 24°C
Test Date	: Feb. 16, 2017	Humidity	: 63%

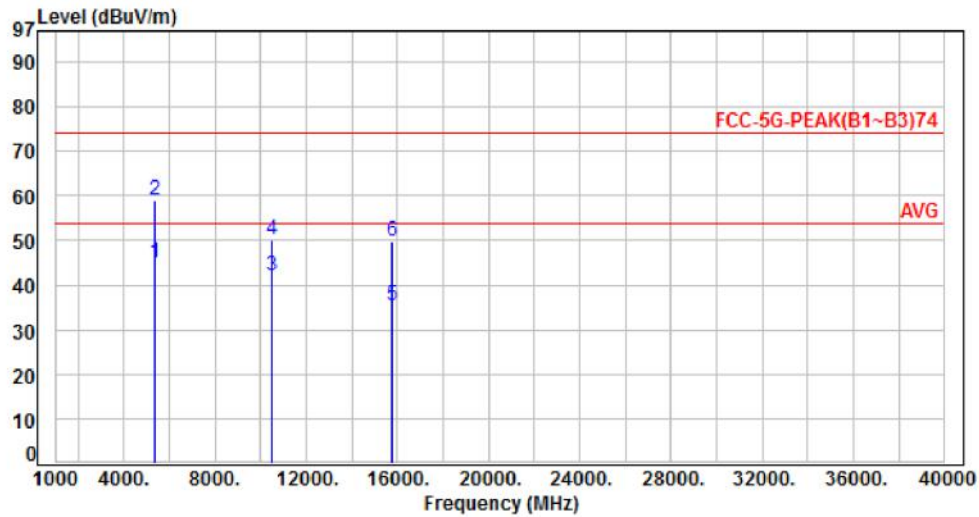

No.	Frequency (MHz)	Factor (dB)	Reading (dBuV)	Level (dBuV)	Limit (dBuV)	Margin (dB)	Detector	Height (cm)	Azimuth (deg)	P/F
1	5350.00	-6.06	51.19	45.13	54.00	-8.87	Average	138	255	P
2	5350.00	-6.06	64.90	58.84	74.00	-15.16	Peak	138	255	P
3	10520.00	0.77	41.39	42.16	54.00	-11.84	Average	153	287	P
4	10520.00	0.77	49.36	50.13	74.00	-23.87	Peak	153	287	P
5	15780.00	5.37	30.05	35.42	54.00	-18.58	Average	144	301	P
6	15780.00	5.37	44.31	49.68	74.00	-24.32	Peak	144	301	P

Note: Level=Reading+Factor  
Margin=Level-Limit  
Factor=Antenna Factor + cable loss - Amplifier Factor





Power	: AC 120V	Pol/Phase	: HORIZONTAL
Test Mode	: Mode 1, CH52	Temperature	: 24°C
Test Date	: Feb. 16, 2017	Humidity	: 63%

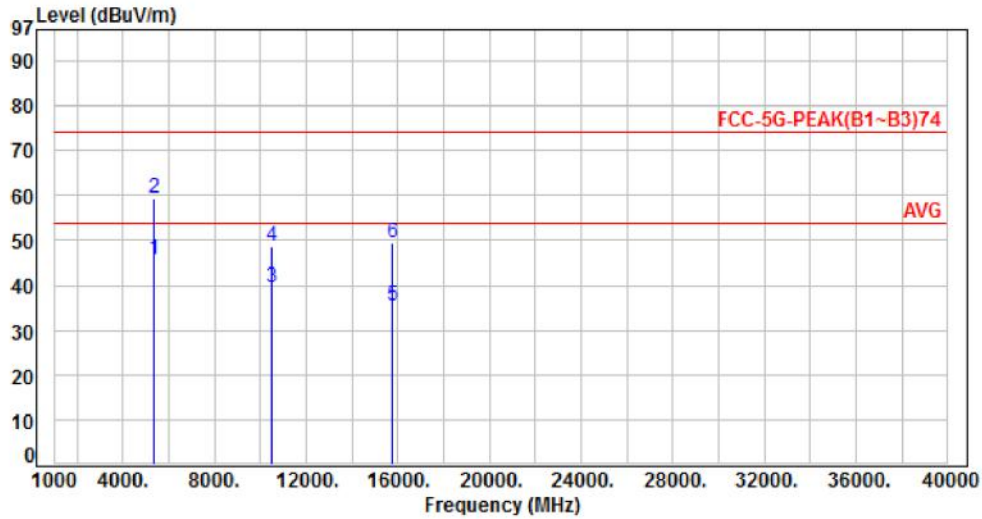

No.	Frequency (MHz)	Factor (dB)	Reading (dBuV)	Level (dBuV)	Limit (dBuV)	Margin (dB)	Detector	Height (cm)	Azimuth (deg)	P/F
1	5350.00	-6.06	51.94	45.88	54.00	-8.12	Average	100	168	P
2	5350.00	-6.06	65.26	59.20	74.00	-14.80	Peak	100	168	P
3	10520.00	0.77	38.69	39.46	54.00	-14.54	Average	100	304	P
4	10520.00	0.77	48.01	48.78	74.00	-25.22	Peak	100	304	P
5	15780.00	5.37	29.86	35.23	54.00	-18.77	Average	160	176	P
6	15780.00	5.37	43.96	49.33	74.00	-24.67	Peak	160	176	P

Note: Level=Reading+Factor  
Margin=Level-Limit  
Factor=Antenna Factor + cable loss - Amplifier Factor



Power	: AC 120V	Pol/Phase	: VERTICAL
Test Mode	: Mode 1, CH60	Temperature	: 24°C
Test Date	: Feb. 16, 2017	Humidity	: 63%

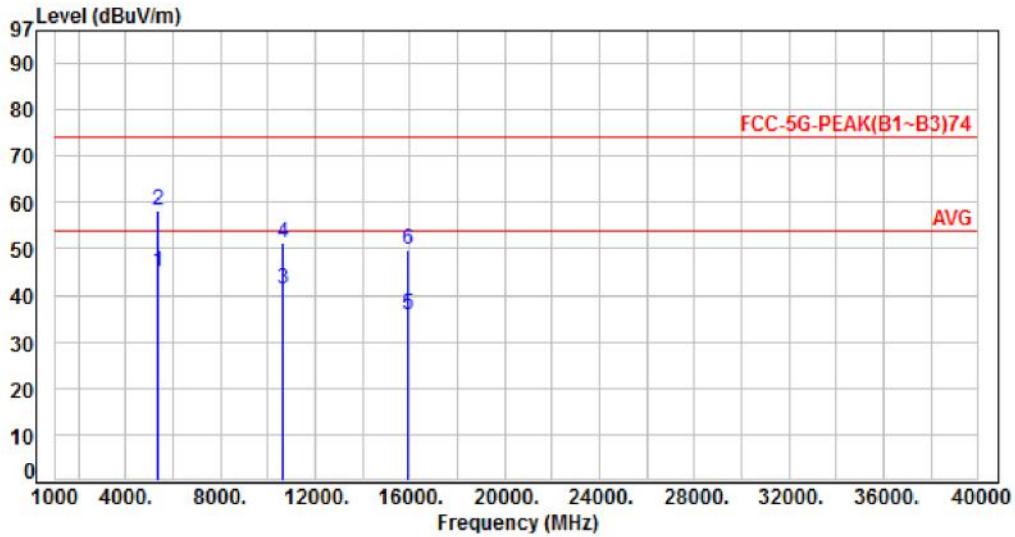

No.	Frequency (MHz)	Factor (dB)	Reading (dBuV)	Level (dBuV)	Limit (dBuV)	Margin (dB)	Detector	Height (cm)	Azimuth (deg)	P/F
1	5350.00	-6.06	51.18	45.12	54.00	-8.88	Average	153	322	P
2	5350.00	-6.06	64.17	58.11	74.00	-15.89	Peak	153	322	P
3	10600.00	0.87	40.41	41.28	54.00	-12.72	Average	143	201	P
4	10600.00	0.87	50.35	51.22	74.00	-22.78	Peak	143	201	P
5	15900.00	5.37	30.35	35.72	54.00	-18.28	Average	133	76	P
6	15900.00	5.37	44.59	49.96	74.00	-24.04	Peak	133	76	P

Note: Level=Reading+Factor  
 Margin=Level-Limit  
 Factor=Antenna Factor + cable loss - Amplifier Factor



Power	: AC 120V	Pol/Phase	: HORIZONTAL
Test Mode	: Mode 1, CH60	Temperature	: 24°C
Test Date	: Feb. 16, 2017	Humidity	: 63%

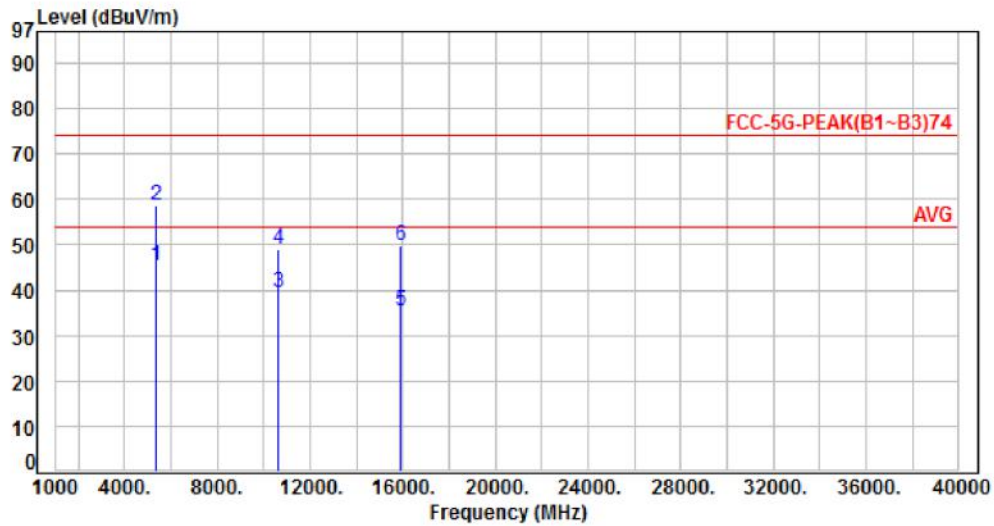

No.	Frequency (MHz)	Factor (dB)	Reading (dBuV)	Level (dBuV)	Limit (dBuV)	Margin (dB)	Detector	Height (cm)	Azimuth (deg)	P/F
1	5350.00	-6.06	51.57	45.51	54.00	-8.49	Average	100	174	P
2	5350.00	-6.06	64.79	58.73	74.00	-15.27	Peak	100	174	P
3	10600.00	0.87	38.76	39.63	54.00	-14.37	Average	121	299	P
4	10600.00	0.87	48.27	49.14	74.00	-24.86	Peak	121	299	P
5	15900.00	5.37	29.97	35.34	54.00	-18.66	Average	148	186	P
6	15900.00	5.37	44.31	49.68	74.00	-24.32	Peak	148	186	P

Note: Level=Reading+Factor  
 Margin=Level-Limit  
 Factor=Antenna Factor + cable loss - Amplifier Factor



Power	: AC 120V	Pol/Phase	: VERTICAL
Test Mode	: Mode 1, CH64	Temperature	: 24°C
Test Date	: Feb. 16, 2017	Humidity	: 63%

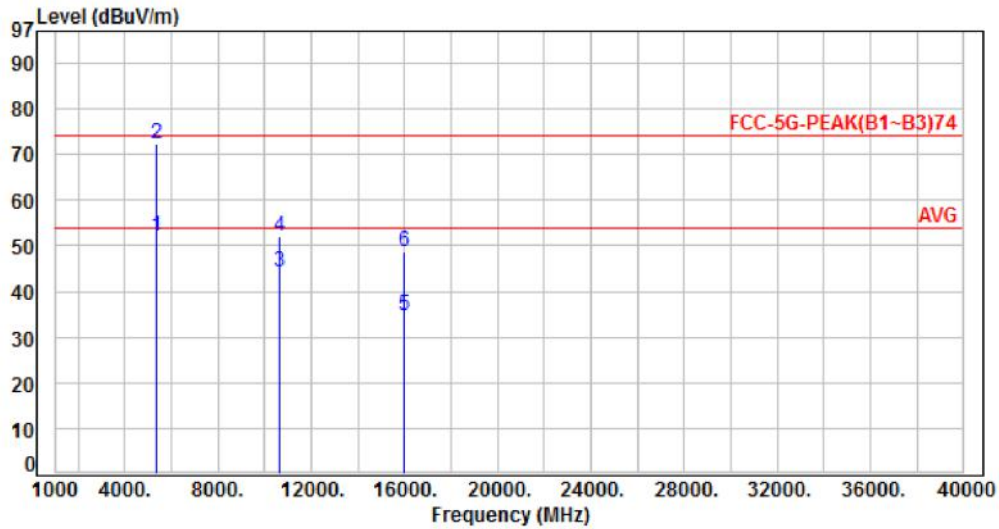

No.	Frequency (MHz)	Factor (dB)	Reading (dBuV)	Level (dBuV)	Limit (dBuV)	Margin (dB)	Detector	Height (cm)	Azimuth (deg)	P/F
1	5350.00	-6.06	58.04	51.98	54.00	-2.02	Average	137	185	P
2	5350.00	-6.06	78.51	72.45	74.00	-1.55	Peak	137	185	P
3	10640.00	0.93	43.41	44.34	54.00	-9.66	Average	261	294	P
4	10640.00	0.93	51.11	52.04	74.00	-21.96	Peak	261	294	P
5	15960.00	5.38	29.18	34.56	54.00	-19.44	Average	137	162	P
6	15960.00	5.38	43.19	48.57	74.00	-25.43	Peak	137	162	P

Note: Level=Reading+Factor  
 Margin=Level-Limit  
 Factor=Antenna Factor + cable loss - Amplifier Factor



Power	: AC 120V	Pol/Phase	: HORIZONTAL
Test Mode	: Mode 1, CH64	Temperature	: 24°C
Test Date	: Feb. 16, 2017	Humidity	: 63%

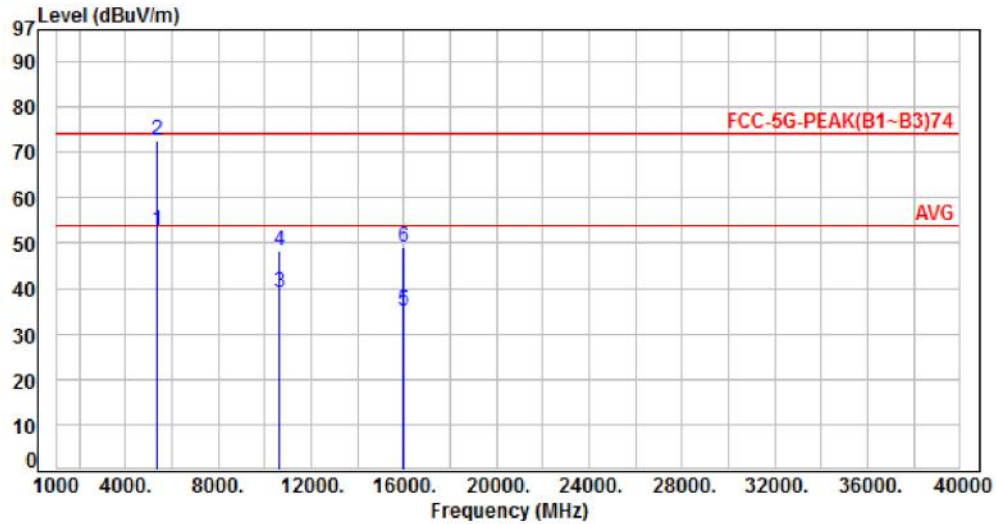

No.	Frequency (MHz)	Factor (dB)	Reading (dBuV)	Level (dBuV)	Limit (dBuV)	Margin (dB)	Detector	Height (cm)	Azimuth (deg)	P/F
1	5350.00	-6.06	58.79	52.73	54.00	-1.27	Average	151	152	P
2	5350.00	-6.06	78.72	72.66	74.00	-1.34	Peak	151	152	P
3	10640.00	0.93	38.10	39.03	54.00	-14.97	Average	108	249	P
4	10640.00	0.93	47.27	48.20	74.00	-25.80	Peak	108	249	P
5	15960.00	5.38	29.52	34.90	54.00	-19.10	Average	100	196	P
6	15960.00	5.38	43.79	49.17	74.00	-24.83	Peak	100	196	P

Note: Level=Reading+Factor  
 Margin=Level-Limit  
 Factor=Antenna Factor + cable loss - Amplifier Factor



Power	: AC 120V	Pol/Phase	: VERTICAL
Test Mode	: Mode 1, CH100	Temperature	: 24°C
Test Date	: Feb. 16, 2017	Humidity	: 63%

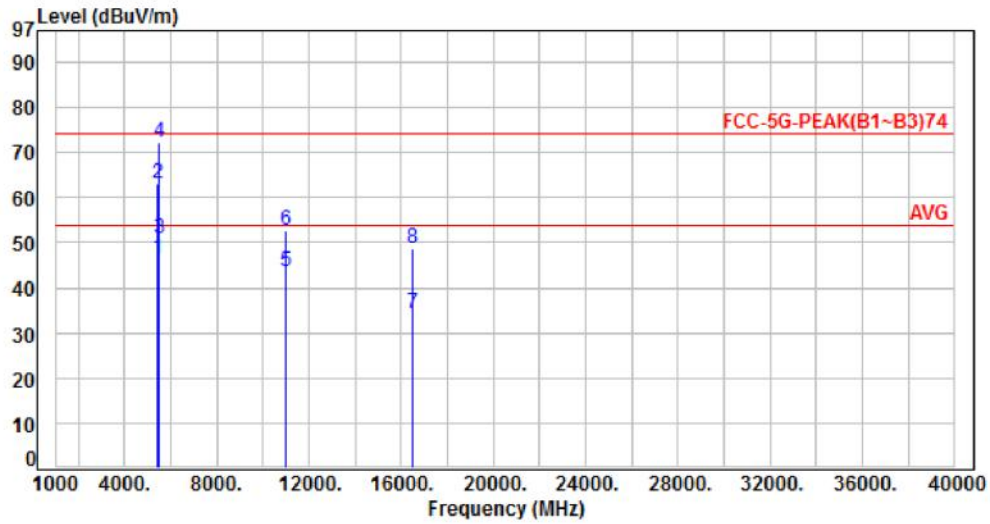

No.	Frequency (MHz)	Factor (dB)	Reading (dBuV)	Level (dBuV)	Limit (dBuV)	Margin (dB)	Detector	Height (cm)	Azimuth (deg)	P/F
1	5460.00	-5.80	52.23	46.43	54.00	-7.57	Average	277	182	P
2	5460.00	-5.80	69.05	63.25	74.00	-10.75	Peak	277	182	P
3	5470.00	-5.78	56.62	50.84	54.00	-3.16	Average	277	182	P
4	5470.00	-5.78	78.01	72.23	74.00	-1.77	Peak	277	182	P
5	11000.00	1.41	42.13	43.54	54.00	-10.46	Average	278	312	P
6	11000.00	1.41	51.44	52.85	74.00	-21.15	Peak	278	312	P
7	16500.00	6.62	27.85	34.47	54.00	-19.53	Average	167	211	P
8	16500.00	6.62	41.97	48.59	74.00	-25.41	Peak	167	211	P

Note: Level=Reading+Factor  
 Margin=Level-Limit  
 Factor=Antenna Factor + cable loss - Amplifier Factor



Power	: AC 120V	Pol/Phase	: HORIZONTAL
Test Mode	: Mode 1, CH100	Temperature	: 24°C
Test Date	: Feb. 16, 2017	Humidity	: 63%

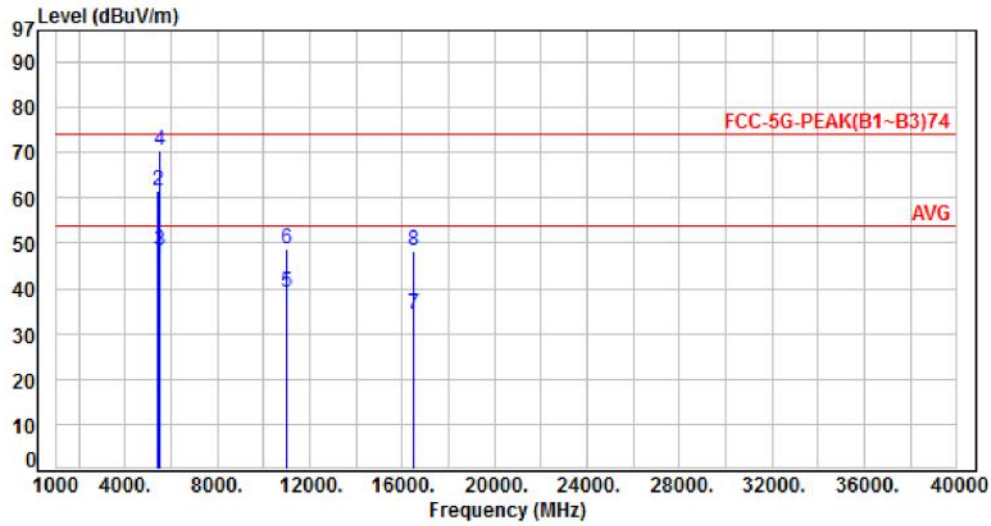

No.	Frequency (MHz)	Factor (dB)	Reading (dBuV)	Level (dBuV)	Limit (dBuV)	Margin (dB)	Detector	Height (cm)	Azimuth (deg)	P/F
1	5460.00	-5.80	52.19	46.39	54.00	-7.61	Average	100	153	P
2	5460.00	-5.80	67.35	61.55	74.00	-12.45	Peak	100	153	P
3	5470.00	-5.78	54.28	48.50	54.00	-5.50	Average	100	153	P
4	5470.00	-5.78	76.12	70.34	74.00	-3.66	Peak	100	153	P
5	11000.00	1.41	37.52	38.93	54.00	-15.07	Average	114	149	P
6	11000.00	1.41	47.21	48.62	74.00	-25.38	Peak	114	149	P
7	16500.00	6.62	27.79	34.41	54.00	-19.59	Average	100	184	P
8	16500.00	6.62	41.80	48.42	74.00	-25.58	Peak	100	184	P

Note: Level=Reading+Factor  
Margin=Level-Limit  
Factor=Antenna Factor + cable loss - Amplifier Factor



Power	: AC 120V	Pol/Phase	: VERTICAL
Test Mode	: Mode 1, CH116	Temperature	: 24°C
Test Date	: Feb. 16, 2017	Humidity	: 63%

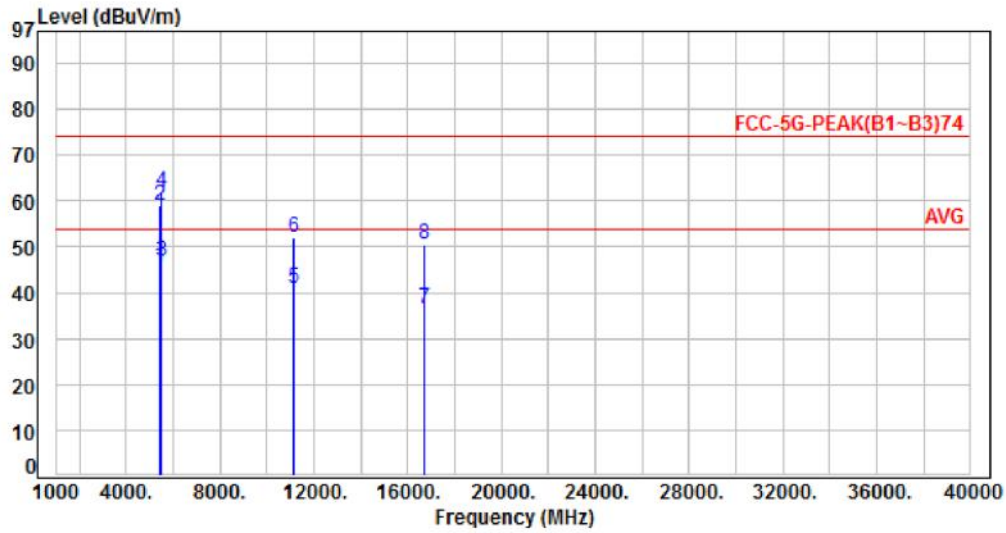

No.	Frequency (MHz)	Factor (dB)	Reading (dBuV)	Level (dBuV)	Limit (dBuV)	Margin (dB)	Detector	Height (cm)	Azimuth (deg)	P/F
1	5460.00	-5.80	51.69	45.89	54.00	-8.11	Average	117	261	P
2	5460.00	-5.80	64.92	59.12	74.00	-14.88	Peak	117	261	P
3	5470.00	-5.78	52.80	47.02	54.00	-6.98	Average	117	261	P
4	5470.00	-5.78	67.58	61.80	74.00	-12.20	Peak	117	261	P
5	11160.00	1.62	39.19	40.81	54.00	-13.19	Average	124	188	P
6	11160.00	1.62	50.40	52.02	74.00	-21.98	Peak	124	188	P
7	16740.00	8.00	28.62	36.62	54.00	-17.38	Average	114	247	P
8	16740.00	8.00	42.35	50.35	74.00	-23.65	Peak	114	247	P

Note: Level=Reading+Factor  
 Margin=Level-Limit  
 Factor=Antenna Factor + cable loss - Amplifier Factor





Power	: AC 120V	Pol/Phase	: HORIZONTAL
Test Mode	: Mode 1, CH116	Temperature	: 24°C
Test Date	: Feb. 16, 2017	Humidity	: 63%

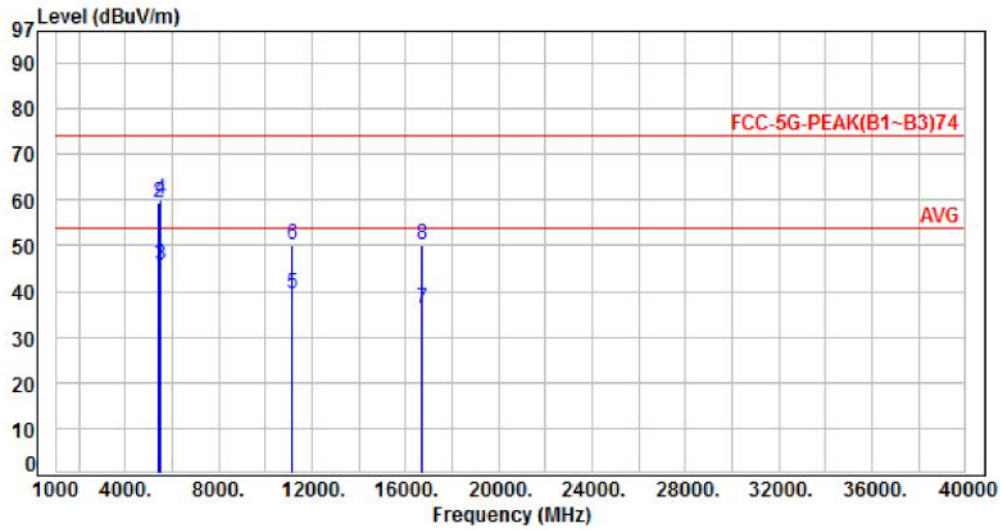

No.	Frequency (MHz)	Factor (dB)	Reading (dBuV)	Level (dBuV)	Limit (dBuV)	Margin (dB)	Detector	Height (cm)	Azimuth (deg)	P/F
1	5460.00	-5.80	51.98	46.18	54.00	-7.82	Average	100	152	P
2	5460.00	-5.80	65.31	59.51	74.00	-14.49	Peak	100	152	P
3	5470.00	-5.78	51.35	45.57	54.00	-8.43	Average	100	152	P
4	5470.00	-5.78	65.98	60.20	74.00	-13.80	Peak	100	152	P
5	11160.00	1.62	37.78	39.40	54.00	-14.60	Average	116	138	P
6	11160.00	1.62	48.57	50.19	74.00	-23.81	Peak	116	138	P
7	16740.00	8.00	28.13	36.13	54.00	-17.87	Average	100	173	P
8	16740.00	8.00	42.02	50.02	74.00	-23.98	Peak	100	173	P

Note: Level=Reading+Factor  
 Margin=Level-Limit  
 Factor=Antenna Factor + cable loss - Amplifier Factor



Power	: AC 120V	Pol/Phase	: VERTICAL
Test Mode	: Mode 1, CH132	Temperature	: 24°C
Test Date	: Feb. 16, 2017	Humidity	: 63%

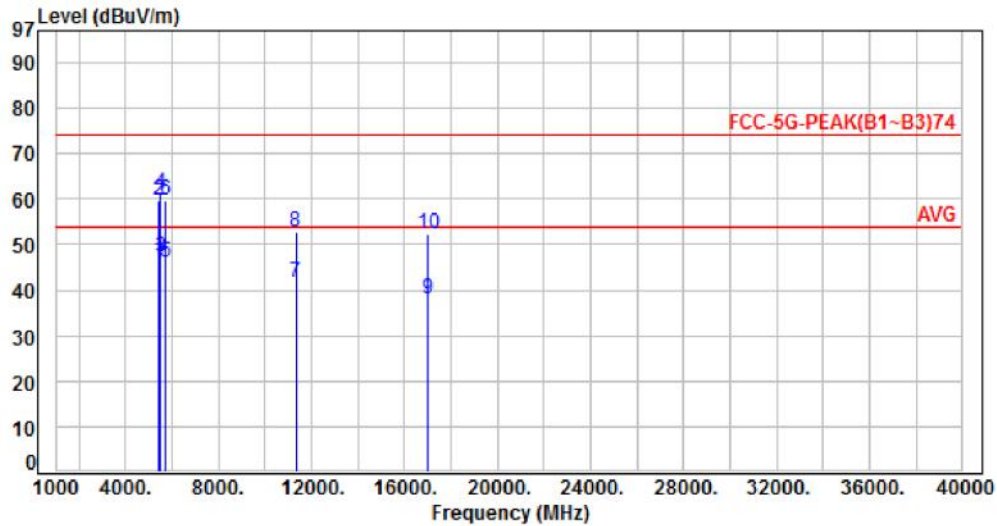

No.	Frequency (MHz)	Factor (dB)	Reading (dBuV)	Level (dBuV)	Limit (dBuV)	Margin (dB)	Detector	Height (cm)	Azimuth (deg)	P/F
1	5460.00	-5.80	52.33	46.53	54.00	-7.47	Average	128	166	P
2	5460.00	-5.80	65.68	59.88	74.00	-14.12	Peak	128	166	P
3	5470.00	-5.78	52.85	47.07	54.00	-6.93	Average	128	166	P
4	5470.00	-5.78	67.01	61.23	74.00	-12.77	Peak	128	166	P
5	5725.00	-5.80	51.92	46.12	54.00	-7.88	Average	128	166	P
6	5725.00	-5.80	65.61	59.81	74.00	-14.19	Peak	128	166	P
7	11320.00	1.83	39.99	41.82	54.00	-12.18	Average	157	201	P
8	11320.00	1.83	50.89	52.72	74.00	-21.28	Peak	157	201	P
9	16980.00	9.41	28.61	38.02	54.00	-15.98	Average	141	229	P
10	16980.00	9.41	42.81	52.22	74.00	-21.78	Peak	141	229	P

Note: Level=Reading+Factor  
 Margin=Level-Limit  
 Factor=Antenna Factor + cable loss - Amplifier Factor



Power	: AC 120V	Pol/Phase	: HORIZONTAL
Test Mode	: Mode 1, CH132	Temperature	: 24°C
Test Date	: Feb. 16, 2017	Humidity	: 63%

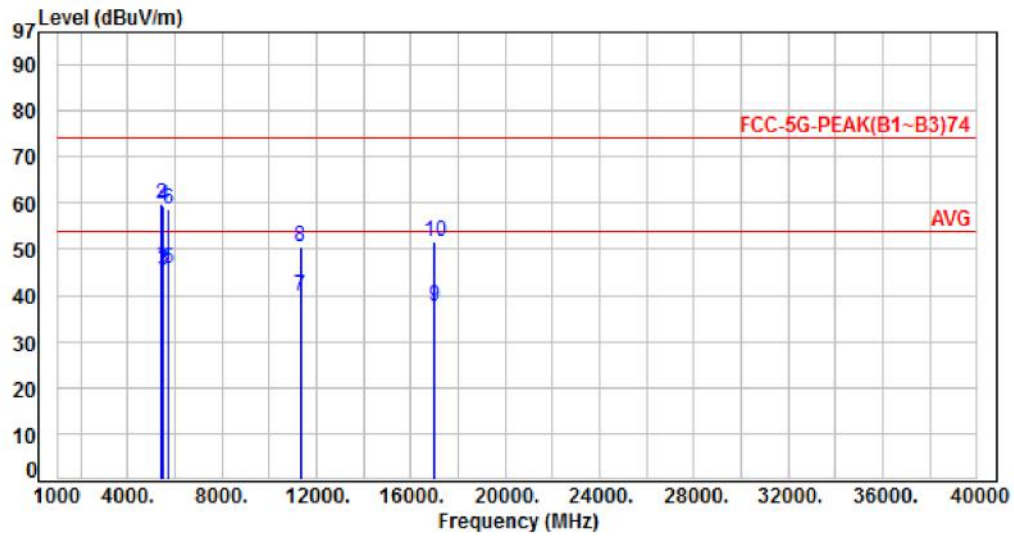

No.	Frequency (MHz)	Factor (dB)	Reading (dBuV)	Level (dBuV)	Limit (dBuV)	Margin (dB)	Detector	Height (cm)	Azimuth (deg)	P/F
1	5460.00	-5.80	52.26	46.46	54.00	-7.54	Average	118	154	P
2	5460.00	-5.80	65.44	59.64	74.00	-14.36	Peak	118	154	P
3	5470.00	-5.78	51.25	45.47	54.00	-8.53	Average	118	154	P
4	5470.00	-5.78	65.18	59.40	74.00	-14.60	Peak	118	154	P
5	5725.00	-5.80	51.64	45.84	54.00	-8.16	Average	118	154	P
6	5725.00	-5.80	64.53	58.73	74.00	-15.27	Peak	118	154	P
7	11320.00	1.83	37.92	39.75	54.00	-14.25	Average	120	141	P
8	11320.00	1.83	48.62	50.45	74.00	-23.55	Peak	120	141	P
9	16980.00	9.41	28.38	37.79	54.00	-16.21	Average	100	169	P
10	16980.00	9.41	42.34	51.75	74.00	-22.25	Peak	100	169	P

Note: Level=Reading+Factor  
 Margin=Level-Limit  
 Factor=Antenna Factor + cable loss - Amplifier Factor



Power	: AC 120V	Pol/Phase	: VERTICAL
Test Mode	: Mode 1, CH140	Temperature	: 24°C
Test Date	: Feb. 16, 2017	Humidity	: 63%

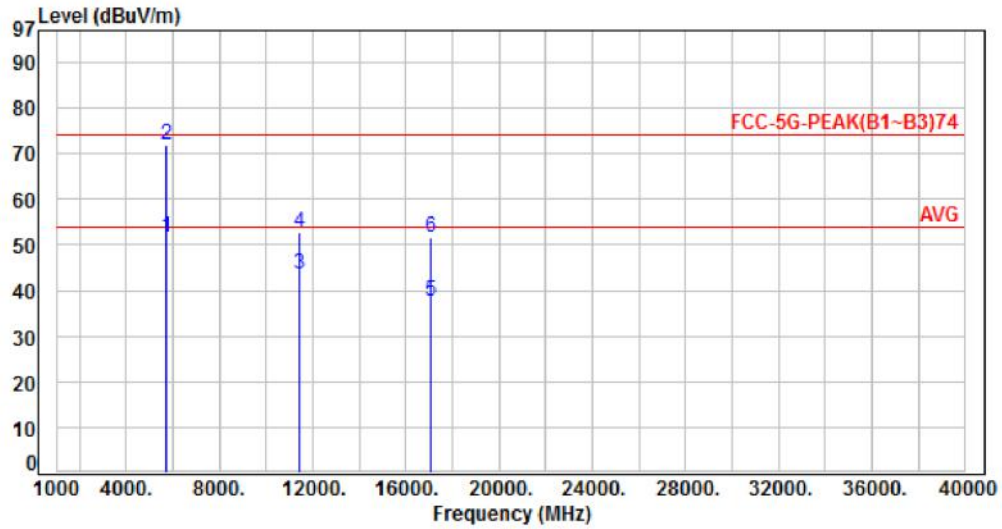

No.	Frequency (MHz)	Factor (dB)	Reading (dBuV)	Level (dBuV)	Limit (dBuV)	Margin (dB)	Detector	Height (cm)	Azimuth (deg)	P/F
1	5725.00	-5.80	57.27	51.47	54.00	-2.53	Average	100	141	P
2	5725.00	-5.80	77.71	71.91	74.00	-2.09	Peak	100	141	P
3	11400.00	1.94	41.50	43.44	54.00	-10.56	Average	266	304	P
4	11400.00	1.94	50.67	52.61	74.00	-21.39	Peak	266	304	P
5	17100.00	10.14	27.62	37.76	54.00	-16.24	Average	168	214	P
6	17100.00	10.14	41.56	51.70	74.00	-22.30	Peak	168	214	P

Note: Level=Reading+Factor  
 Margin=Level-Limit  
 Factor=Antenna Factor + cable loss - Amplifier Factor



Power	: AC 120V	Pol/Phase	: HORIZONTAL
Test Mode	: Mode 1, CH140	Temperature	: 24°C
Test Date	: Feb. 16, 2017	Humidity	: 63%

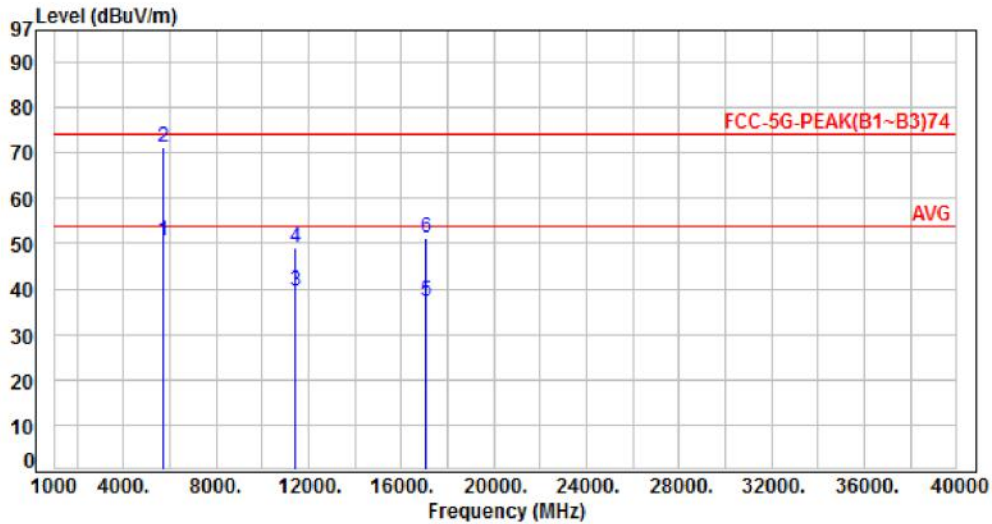

No.	Frequency (MHz)	Factor (dB)	Reading (dBuV)	Level (dBuV)	Limit (dBuV)	Margin (dB)	Detector	Height (cm)	Azimuth (deg)	P/F
1	5725.00	-5.80	56.32	50.52	54.00	-3.48	Average	100	215	P
2	5725.00	-5.80	76.95	71.15	74.00	-2.85	Peak	100	215	P
3	11400.00	1.94	37.44	39.38	54.00	-14.62	Average	100	137	P
4	11400.00	1.94	47.26	49.20	74.00	-24.80	Peak	100	137	P
5	17100.00	10.14	27.13	37.27	54.00	-16.73	Average	100	174	P
6	17100.00	10.14	41.16	51.30	74.00	-22.70	Peak	100	174	P

Note: Level=Reading+Factor  
 Margin=Level-Limit  
 Factor=Antenna Factor + cable loss - Amplifier Factor



Power	: AC 120V	Pol/Phase	: VERTICAL
Test Mode	: Mode 4, CH36	Temperature	: 24°C
Test Date	: Feb. 16, 2017	Humidity	: 63%

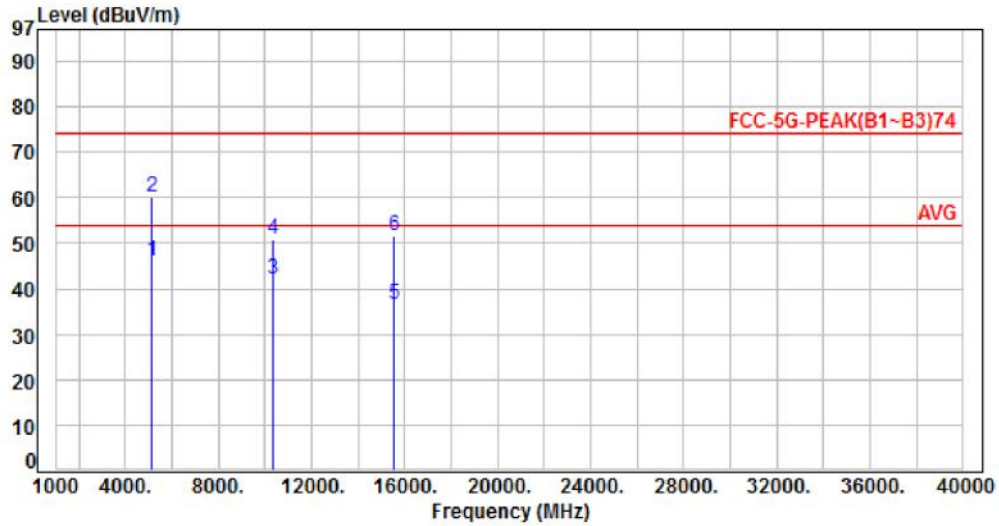

No.	Frequency (MHz)	Factor (dB)	Reading (dBuV)	Level (dBuV)	Limit (dBuV)	Margin (dB)	Detector	Height (cm)	Azimuth (deg)	P/F
1	5150.00	-6.54	52.61	46.07	54.00	-7.93	Average	170	142	P
2	5150.00	-6.54	66.56	60.02	74.00	-13.98	Peak	170	142	P
3	10360.00	0.66	41.34	42.00	54.00	-12.00	Average	100	298	P
4	10360.00	0.66	50.37	51.03	74.00	-22.97	Peak	100	298	P
5	15540.00	5.36	31.26	36.62	54.00	-17.38	Average	106	302	P
6	15540.00	5.36	46.13	51.49	74.00	-22.51	Peak	106	302	P

Note: Level=Reading+Factor  
 Margin=Level-Limit  
 Factor=Antenna Factor + cable loss - Amplifier Factor



Power	: AC 120V	Pol/Phase	: HORIZONTAL
Test Mode	: Mode 4, CH36	Temperature	: 24°C
Test Date	: Feb. 16, 2017	Humidity	: 63%

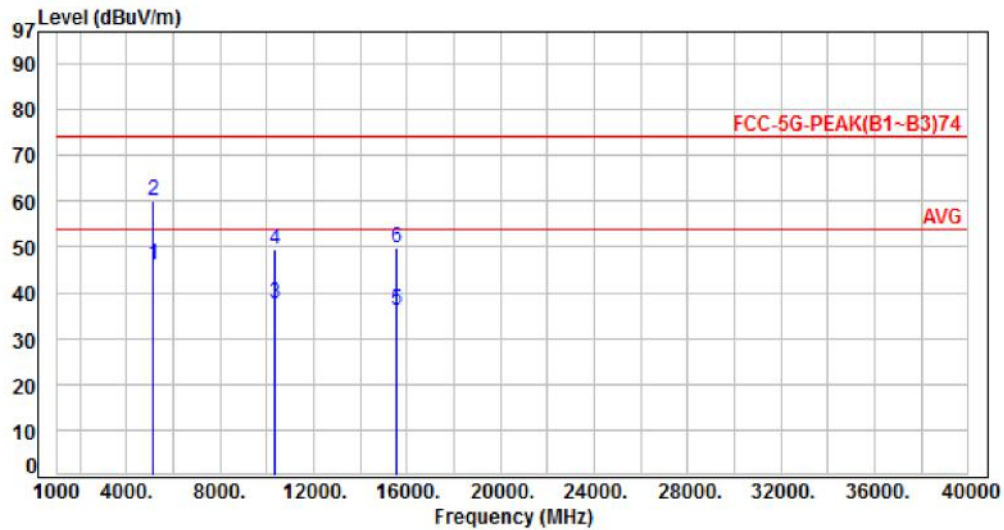

No.	Frequency (MHz)	Factor (dB)	Reading (dBuV)	Level (dBuV)	Limit (dBuV)	Margin (dB)	Detector	Height (cm)	Azimuth (deg)	P/F
1	5150.00	-6.54	52.58	46.04	54.00	-7.96	Average	223	182	P
2	5150.00	-6.54	66.81	60.27	74.00	-13.73	Peak	223	182	P
3	10360.00	0.66	36.92	37.58	54.00	-16.42	Average	100	147	P
4	10360.00	0.66	48.66	49.32	74.00	-24.68	Peak	100	147	P
5	15540.00	5.36	30.79	36.15	54.00	-17.85	Average	124	173	P
6	15540.00	5.36	44.28	49.64	74.00	-24.36	Peak	124	173	P

Note: Level=Reading+Factor  
 Margin=Level-Limit  
 Factor=Antenna Factor + cable loss - Amplifier Factor



Power	: AC 120V	Pol/Phase	: VERTICAL
Test Mode	: Mode 4, CH44	Temperature	: 24°C
Test Date	: Feb. 16, 2017	Humidity	: 63%

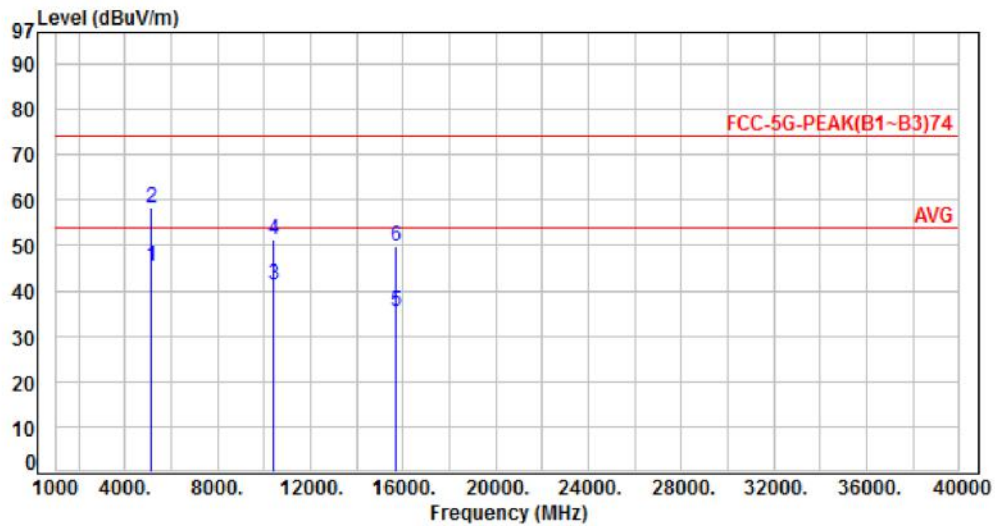

No.	Frequency (MHz)	Factor (dB)	Reading (dBuV)	Level (dBuV)	Limit (dBuV)	Margin (dB)	Detector	Height (cm)	Azimuth (deg)	P/F
1	5150.00	-6.54	51.85	45.31	54.00	-8.69	Average	128	196	P
2	5150.00	-6.54	64.92	58.38	74.00	-15.62	Peak	128	196	P
3	10440.00	0.70	40.65	41.35	54.00	-12.65	Average	145	199	P
4	10440.00	0.70	50.58	51.28	74.00	-22.72	Peak	145	199	P
5	15660.00	5.38	30.20	35.58	54.00	-18.42	Average	112	213	P
6	15660.00	5.38	44.46	49.84	74.00	-24.16	Peak	112	213	P

Note: Level=Reading+Factor  
 Margin=Level-Limit  
 Factor=Antenna Factor + cable loss - Amplifier Factor





Power	: AC 120V	Pol/Phase	: HORIZONTAL
Test Mode	: Mode 4, CH44	Temperature	: 24°C
Test Date	: Feb. 16, 2017	Humidity	: 63%

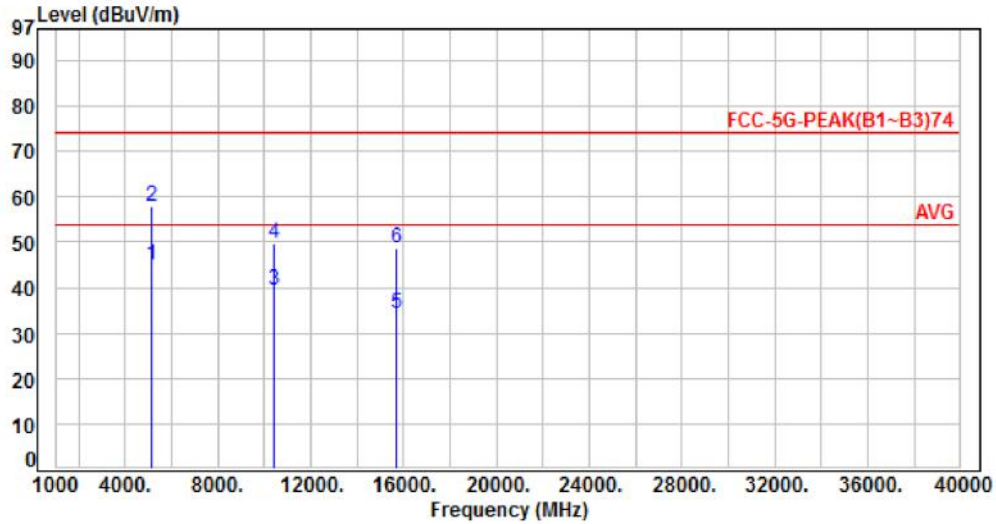

No.	Frequency (MHz)	Factor (dB)	Reading (dBuV)	Level (dBuV)	Limit (dBuV)	Margin (dB)	Detector	Height (cm)	Azimuth (deg)	P/F
1	5150.00	-6.54	51.37	44.83	54.00	-9.17	Average	143	238	P
2	5150.00	-6.54	64.56	58.02	74.00	-15.98	Peak	143	238	P
3	10440.00	0.70	38.76	39.46	54.00	-14.54	Average	127	164	P
4	10440.00	0.70	49.03	49.73	74.00	-24.27	Peak	127	164	P
5	15660.00	5.38	28.85	34.23	54.00	-19.77	Average	120	283	P
6	15660.00	5.38	43.29	48.67	74.00	-25.33	Peak	120	283	P

Note: Level=Reading+Factor  
Margin=Level-Limit  
Factor=Antenna Factor + cable loss - Amplifier Factor



Power	: AC 120V	Pol/Phase	: VERTICAL
Test Mode	: Mode 4, CH48	Temperature	: 24°C
Test Date	: Feb. 16, 2017	Humidity	: 63%

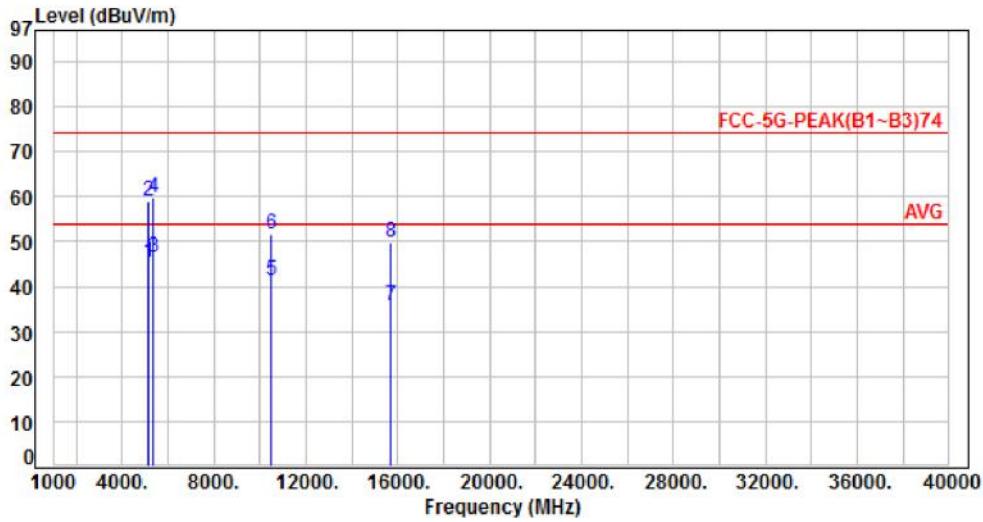

No.	Frequency (MHz)	Factor (dB)	Reading (dBuV)	Level (dBuV)	Limit (dBuV)	Margin (dB)	Detector	Height (cm)	Azimuth (deg)	P/F
1	5150.00	-6.54	51.85	45.31	54.00	-8.69	Average	102	298	P
2	5150.00	-6.54	65.66	59.12	74.00	-14.88	Peak	102	298	P
3	5350.00	-6.06	52.47	46.41	54.00	-7.59	Average	102	298	P
4	5350.00	-6.06	65.64	59.58	74.00	-14.42	Peak	102	298	P
5	10480.00	0.73	40.47	41.20	54.00	-12.80	Average	126	187	P
6	10480.00	0.73	50.89	51.62	74.00	-22.38	Peak	126	187	P
7	15720.00	5.37	30.24	35.61	54.00	-18.39	Average	113	99	P
8	15720.00	5.37	44.58	49.95	74.00	-24.05	Peak	113	99	P

Note: Level=Reading+Factor  
 Margin=Level-Limit  
 Factor=Antenna Factor + cable loss - Amplifier Factor



Power	: AC 120V	Pol/Phase	: HORIZONTAL
Test Mode	: Mode 4, CH48	Temperature	: 24°C
Test Date	: Feb. 16, 2017	Humidity	: 63%

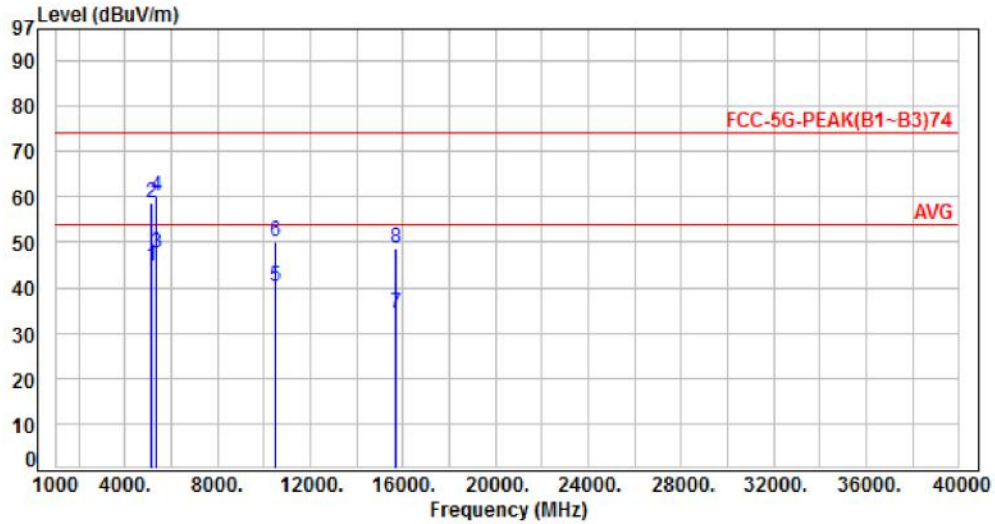

No.	Frequency (MHz)	Factor (dB)	Reading (dBuV)	Level (dBuV)	Limit (dBuV)	Margin (dB)	Detector	Height (cm)	Azimuth (deg)	P/F
1	5150.00	-6.54	51.35	44.81	54.00	-9.19	Average	127	133	P
2	5150.00	-6.54	65.29	58.75	74.00	-15.25	Peak	127	133	P
3	5350.00	-6.06	53.68	47.62	54.00	-6.38	Average	127	133	P
4	5350.00	-6.06	66.29	60.23	74.00	-13.77	Peak	127	133	P
5	10480.00	0.73	39.60	40.33	54.00	-13.67	Average	118	290	P
6	10480.00	0.73	49.46	50.19	74.00	-23.81	Peak	118	290	P
7	15720.00	5.37	29.05	34.42	54.00	-19.58	Average	135	63	P
8	15720.00	5.37	43.25	48.62	74.00	-25.38	Peak	135	63	P

Note: Level=Reading+Factor  
 Margin=Level-Limit  
 Factor=Antenna Factor + cable loss - Amplifier Factor



Power	: AC 120V	Pol/Phase	: VERTICAL
Test Mode	: Mode 4, CH52	Temperature	: 24°C
Test Date	: Feb. 16, 2017	Humidity	: 63%

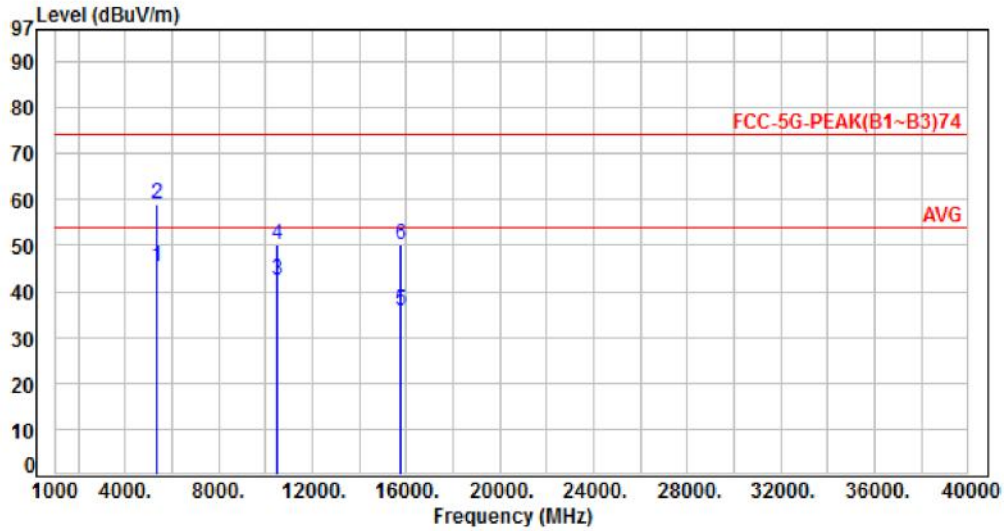

No.	Frequency (MHz)	Factor (dB)	Reading (dBuV)	Level (dBuV)	Limit (dBuV)	Margin (dB)	Detector	Height (cm)	Azimuth (deg)	P/F
1	5350.00	-6.06	51.45	45.39	54.00	-8.61	Average	147	262	P
2	5350.00	-6.06	65.21	59.15	74.00	-14.85	Peak	147	262	P
3	10520.00	0.77	41.49	42.26	54.00	-11.74	Average	151	283	P
4	10520.00	0.77	49.44	50.21	74.00	-23.79	Peak	151	283	P
5	15780.00	5.37	30.27	35.64	54.00	-18.36	Average	138	298	P
6	15780.00	5.37	44.64	50.01	74.00	-23.99	Peak	138	298	P

Note: Level=Reading+Factor  
Margin=Level-Limit  
Factor=Antenna Factor + cable loss - Amplifier Factor



Power	: AC 120V	Pol/Phase	: HORIZONTAL
Test Mode	: Mode 4, CH52	Temperature	: 24°C
Test Date	: Feb. 16, 2017	Humidity	: 63%

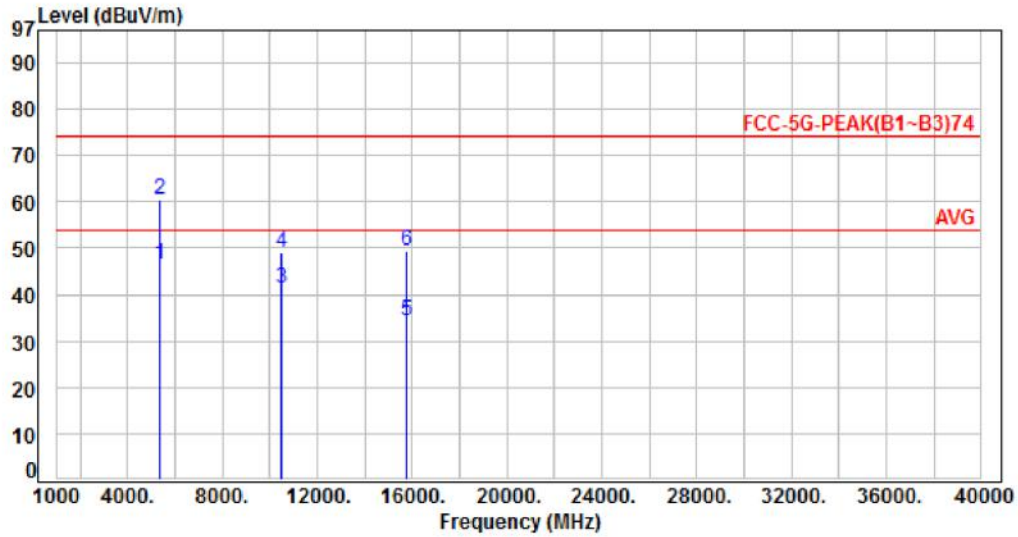

No.	Frequency (MHz)	Factor (dB)	Reading (dBuV)	Level (dBuV)	Limit (dBuV)	Margin (dB)	Detector	Height (cm)	Azimuth (deg)	P/F
1	5350.00	-6.06	52.56	46.50	54.00	-7.50	Average	157	281	P
2	5350.00	-6.06	66.72	60.66	74.00	-13.34	Peak	157	281	P
3	10520.00	0.77	40.36	41.13	54.00	-12.87	Average	118	253	P
4	10520.00	0.77	48.25	49.02	74.00	-24.98	Peak	118	253	P
5	15780.00	5.37	28.91	34.28	54.00	-19.72	Average	144	173	P
6	15780.00	5.37	44.14	49.51	74.00	-24.49	Peak	144	173	P

Note: Level=Reading+Factor  
Margin=Level-Limit  
Factor=Antenna Factor + cable loss - Amplifier Factor



Power	: AC 120V	Pol/Phase	: VERTICAL
Test Mode	: Mode 4, CH60	Temperature	: 24°C
Test Date	: Feb. 16, 2017	Humidity	: 63%

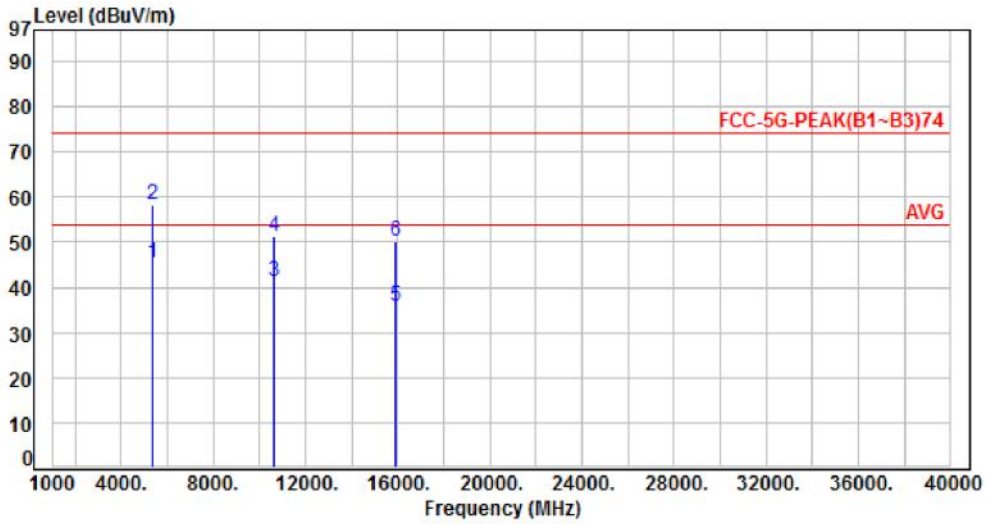

No.	Frequency (MHz)	Factor (dB)	Reading (dBuV)	Level (dBuV)	Limit (dBuV)	Margin (dB)	Detector	Height (cm)	Azimuth (deg)	P/F
1	5350.00	-6.06	51.31	45.25	54.00	-8.75	Average	148	322	P
2	5350.00	-6.06	64.40	58.34	74.00	-15.66	Peak	148	322	P
3	10600.00	0.87	40.61	41.48	54.00	-12.52	Average	155	212	P
4	10600.00	0.87	50.50	51.37	74.00	-22.63	Peak	155	212	P
5	15900.00	5.37	30.48	35.85	54.00	-18.15	Average	134	88	P
6	15900.00	5.37	44.72	50.09	74.00	-23.91	Peak	134	88	P

Note: Level=Reading+Factor  
 Margin=Level-Limit  
 Factor=Antenna Factor + cable loss - Amplifier Factor



Power	: AC 120V	Pol/Phase	: HORIZONTAL
Test Mode	: Mode 4, CH60	Temperature	: 24°C
Test Date	: Feb. 16, 2017	Humidity	: 63%

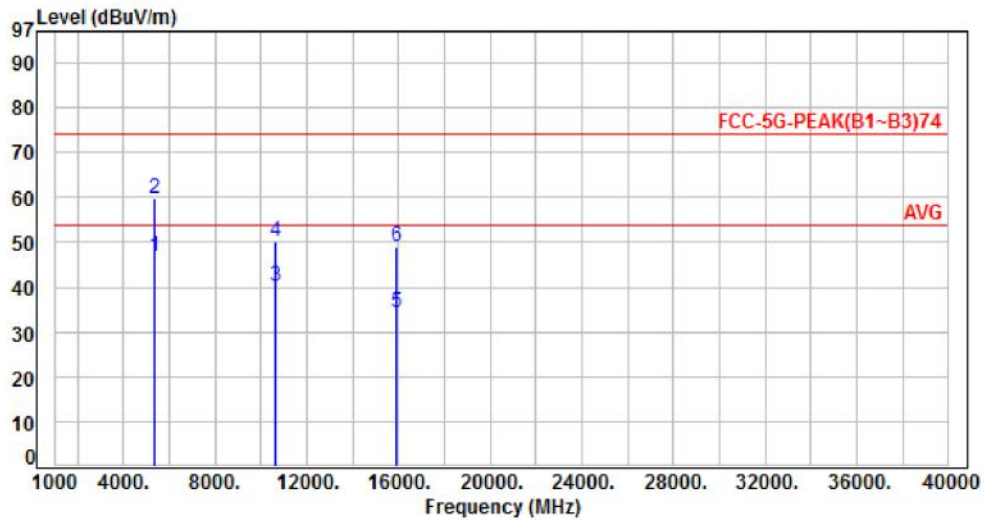

No.	Frequency (MHz)	Factor (dB)	Reading (dBuV)	Level (dBuV)	Limit (dBuV)	Margin (dB)	Detector	Height (cm)	Azimuth (deg)	P/F
1	5350.00	-6.06	52.73	46.67	54.00	-7.33	Average	134	299	P
2	5350.00	-6.06	65.68	59.62	74.00	-14.38	Peak	134	299	P
3	10600.00	0.87	39.28	40.15	54.00	-13.85	Average	120	177	P
4	10600.00	0.87	49.27	50.14	74.00	-23.86	Peak	120	177	P
5	15900.00	5.37	28.82	34.19	54.00	-19.81	Average	125	273	P
6	15900.00	5.37	43.74	49.11	74.00	-24.89	Peak	125	273	P

Note: Level=Reading+Factor  
 Margin=Level-Limit  
 Factor=Antenna Factor + cable loss - Amplifier Factor



Power	: AC 120V	Pol/Phase	: VERTICAL
Test Mode	: Mode 4, CH64	Temperature	: 24°C
Test Date	: Feb. 16, 2017	Humidity	: 63%

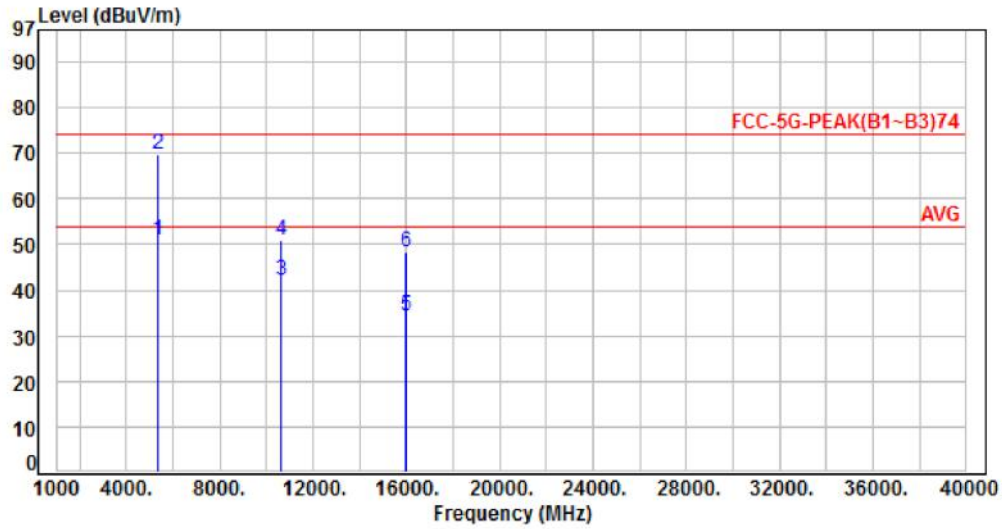

No.	Frequency (MHz)	Factor (dB)	Reading (dBuV)	Level (dBuV)	Limit (dBuV)	Margin (dB)	Detector	Height (cm)	Azimuth (deg)	P/F
1	5350.00	-6.06	57.07	51.01	54.00	-2.99	Average	286	189	P
2	5350.00	-6.06	75.86	69.80	74.00	-4.20	Peak	286	189	P
3	10640.00	0.93	40.98	41.91	54.00	-12.09	Average	248	301	P
4	10640.00	0.93	49.88	50.81	74.00	-23.19	Peak	248	301	P
5	15960.00	5.38	29.01	34.39	54.00	-19.61	Average	137	158	P
6	15960.00	5.38	42.97	48.35	74.00	-25.65	Peak	137	158	P

Note: Level=Reading+Factor  
 Margin=Level-Limit  
 Factor=Antenna Factor + cable loss - Amplifier Factor





Power	: AC 120V	Pol/Phase	: HORIZONTAL
Test Mode	: Mode 4, CH64	Temperature	: 24°C
Test Date	: Feb. 16, 2017	Humidity	: 63%

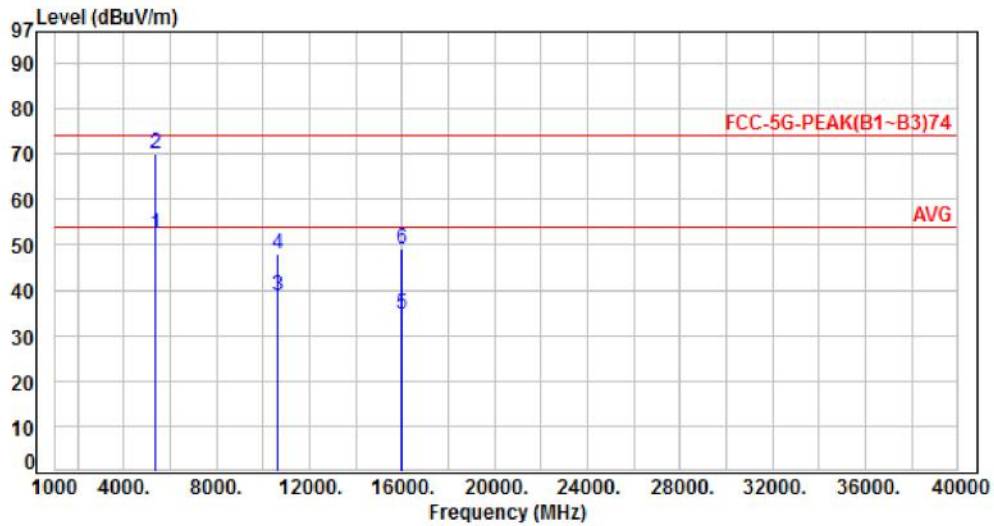

No.	Frequency (MHz)	Factor (dB)	Reading (dBuV)	Level (dBuV)	Limit (dBuV)	Margin (dB)	Detector	Height (cm)	Azimuth (deg)	P/F
1	5350.00	-6.06	58.31	52.25	54.00	-1.75	Average	133	156	P
2	5350.00	-6.06	76.27	70.21	74.00	-3.79	Peak	133	156	P
3	10640.00	0.93	37.76	38.69	54.00	-15.31	Average	100	231	P
4	10640.00	0.93	46.87	47.80	74.00	-26.20	Peak	100	231	P
5	15960.00	5.38	29.34	34.72	54.00	-19.28	Average	100	188	P
6	15960.00	5.38	43.61	48.99	74.00	-25.01	Peak	100	188	P

Note: Level=Reading+Factor  
 Margin=Level-Limit  
 Factor=Antenna Factor + cable loss - Amplifier Factor



Power	: AC 120V	Pol/Phase	: VERTICAL
Test Mode	: Mode 4, CH100	Temperature	: 24°C
Test Date	: Feb. 16, 2017	Humidity	: 63%

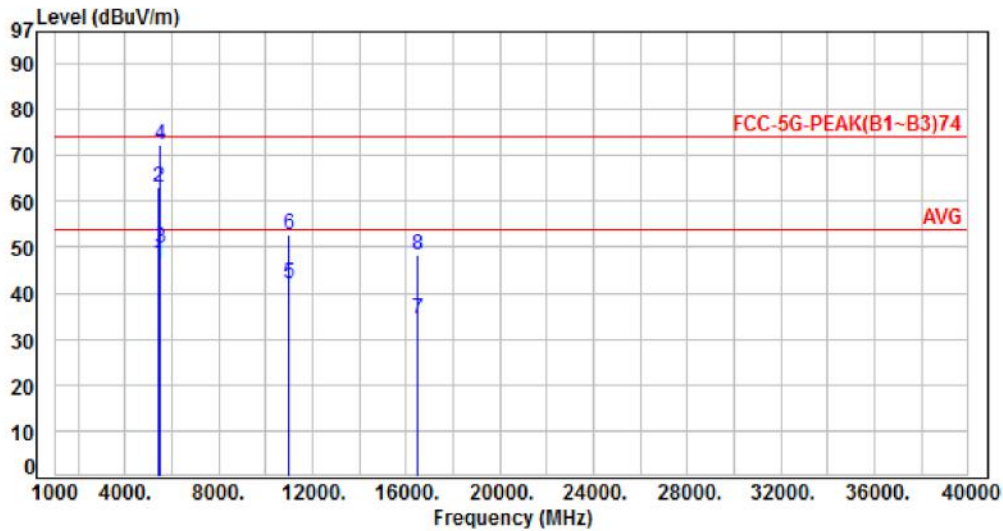

No.	Frequency (MHz)	Factor (dB)	Reading (dBuV)	Level (dBuV)	Limit (dBuV)	Margin (dB)	Detector	Height (cm)	Azimuth (deg)	P/F
1	5460.00	-5.80	52.31	46.51	54.00	-7.49	Average	140	183	P
2	5460.00	-5.80	68.83	63.03	74.00	-10.97	Peak	140	183	P
3	5470.00	-5.78	55.63	49.85	54.00	-4.15	Average	140	183	P
4	5470.00	-5.78	77.92	72.14	74.00	-1.86	Peak	140	183	P
5	11000.00	1.41	40.77	42.18	54.00	-11.82	Average	262	284	P
6	11000.00	1.41	51.15	52.56	74.00	-21.44	Peak	262	284	P
7	16500.00	6.62	27.66	34.28	54.00	-19.72	Average	163	211	P
8	16500.00	6.62	41.72	48.34	74.00	-25.66	Peak	163	211	P

Note: Level=Reading+Factor

Margin=Level-Limit

Factor=Antenna Factor + cable loss - Amplifier Factor



Power	: AC 120V	Pol/Phase	: HORIZONTAL
Test Mode	: Mode 4, CH100	Temperature	: 24°C
Test Date	: Feb. 16, 2017	Humidity	: 63%

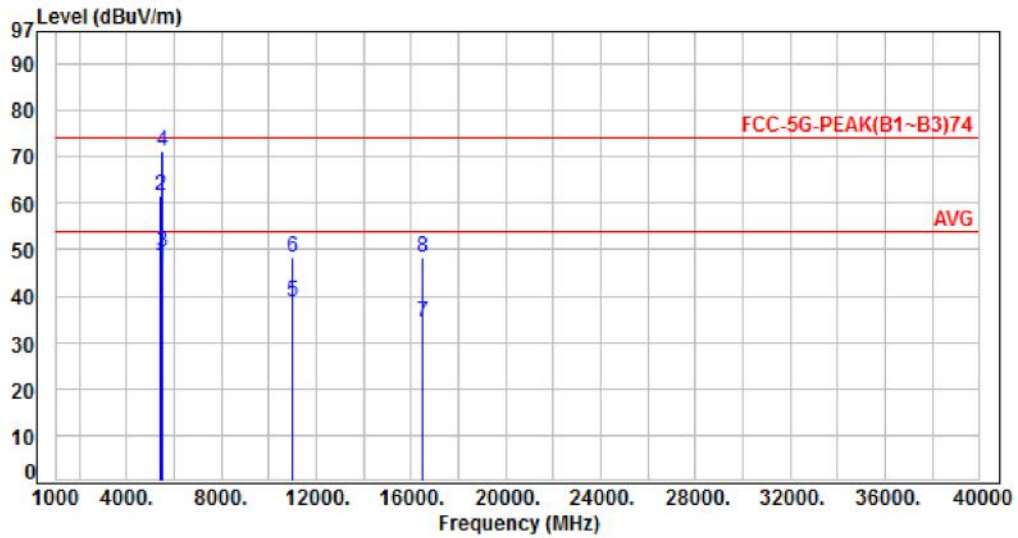

No.	Frequency (MHz)	Factor (dB)	Reading (dBuV)	Level (dBuV)	Limit (dBuV)	Margin (dB)	Detector	Height (cm)	Azimuth (deg)	P/F
1	5460.00	-5.80	52.38	46.58	54.00	-7.42	Average	296	157	P
2	5460.00	-5.80	67.47	61.67	74.00	-12.33	Peak	296	157	P
3	5470.00	-5.78	55.27	49.49	54.00	-4.51	Average	296	157	P
4	5470.00	-5.78	76.90	71.12	74.00	-2.88	Peak	296	157	P
5	11000.00	1.41	37.35	38.76	54.00	-15.24	Average	100	153	P
6	11000.00	1.41	47.03	48.44	74.00	-25.56	Peak	100	153	P
7	16500.00	6.62	27.51	34.13	54.00	-19.87	Average	100	178	P
8	16500.00	6.62	41.62	48.24	74.00	-25.76	Peak	100	178	P

Note: Level=Reading+Factor  
 Margin=Level-Limit  
 Factor=Antenna Factor + cable loss - Amplifier Factor



Power	: AC 120V	Pol/Phase	: VERTICAL
Test Mode	: Mode 4, CH116	Temperature	: 24°C
Test Date	: Feb. 16, 2017	Humidity	: 63%

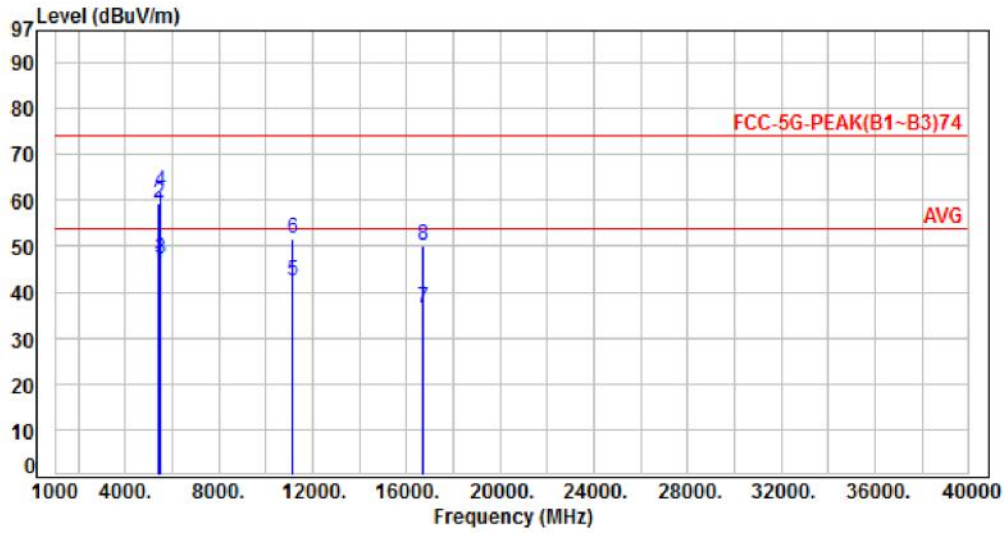

No.	Frequency (MHz)	Factor (dB)	Reading (dBuV)	Level (dBuV)	Limit (dBuV)	Margin (dB)	Detector	Height (cm)	Azimuth (deg)	P/F
1	5460.00	-5.80	51.85	46.05	54.00	-7.95	Average	134	276	P
2	5460.00	-5.80	65.12	59.32	74.00	-14.68	Peak	134	276	P
3	5470.00	-5.78	53.11	47.33	54.00	-6.67	Average	134	276	P
4	5470.00	-5.78	67.81	62.03	74.00	-11.97	Peak	134	276	P
5	11160.00	1.62	40.89	42.51	54.00	-11.49	Average	156	189	P
6	11160.00	1.62	50.15	51.77	74.00	-22.23	Peak	156	189	P
7	16740.00	8.00	28.50	36.50	54.00	-17.50	Average	127	232	P
8	16740.00	8.00	42.13	50.13	74.00	-23.87	Peak	127	232	P

Note: Level=Reading+Factor  
 Margin=Level-Limit  
 Factor=Antenna Factor + cable loss - Amplifier Factor



Power	: AC 120V	Pol/Phase	: HORIZONTAL
Test Mode	: Mode 4, CH116	Temperature	: 24°C
Test Date	: Feb. 16, 2017	Humidity	: 63%

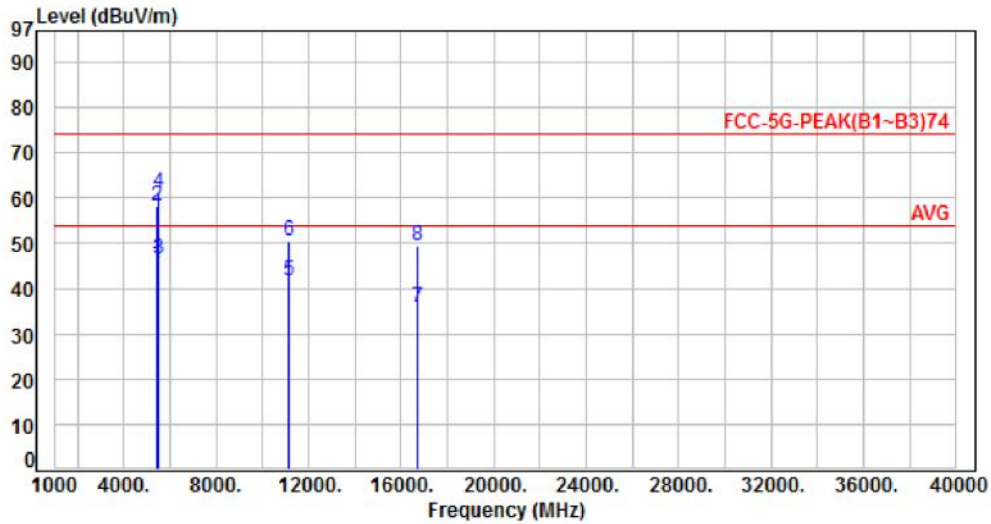

No.	Frequency (MHz)	Factor (dB)	Reading (dBuV)	Level (dBuV)	Limit (dBuV)	Margin (dB)	Detector	Height (cm)	Azimuth (deg)	P/F
1	5460.00	-5.80	51.02	45.22	54.00	-8.78	Average	123	294	P
2	5460.00	-5.80	64.04	58.24	74.00	-15.76	Peak	123	294	P
3	5470.00	-5.78	52.31	46.53	54.00	-7.47	Average	123	294	P
4	5470.00	-5.78	66.91	61.13	74.00	-12.87	Peak	123	294	P
5	11160.00	1.62	40.21	41.83	54.00	-12.17	Average	133	94	P
6	11160.00	1.62	48.81	50.43	74.00	-23.57	Peak	133	94	P
7	16740.00	8.00	27.72	35.72	54.00	-18.28	Average	118	237	P
8	16740.00	8.00	41.27	49.27	74.00	-24.73	Peak	118	237	P

Note: Level=Reading+Factor  
 Margin=Level-Limit  
 Factor=Antenna Factor + cable loss - Amplifier Factor



Power	: AC 120V	Pol/Phase	: VERTICAL
Test Mode	: Mode 4, CH132	Temperature	: 24°C
Test Date	: Feb. 16, 2017	Humidity	: 63%

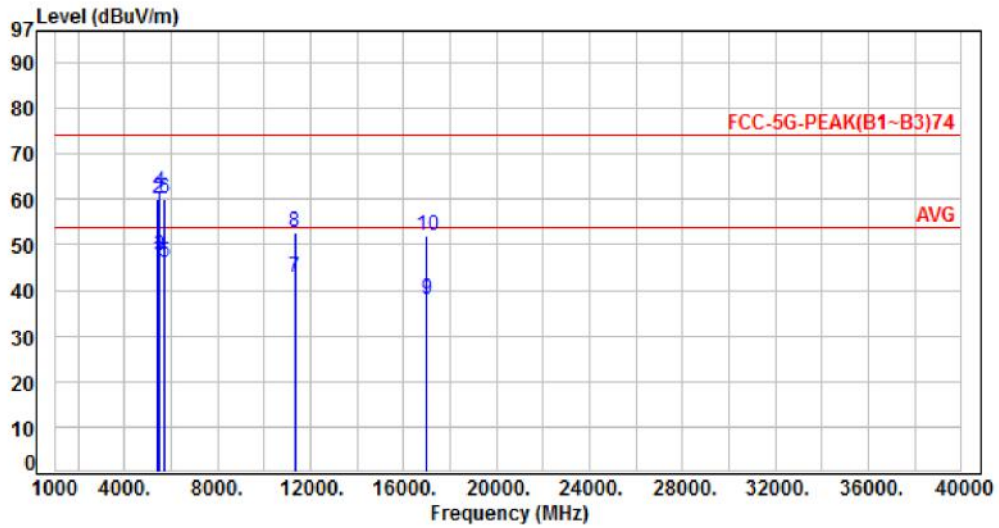

No.	Frequency (MHz)	Factor (dB)	Reading (dBuV)	Level (dBuV)	Limit (dBuV)	Margin (dB)	Detector	Height (cm)	Azimuth (deg)	P/F
1	5460.00	-5.80	52.65	46.85	54.00	-7.15	Average	184	232	P
2	5460.00	-5.80	65.81	60.01	74.00	-13.99	Peak	184	232	P
3	5470.00	-5.78	53.24	47.46	54.00	-6.54	Average	184	232	P
4	5470.00	-5.78	67.47	61.69	74.00	-12.31	Peak	184	232	P
5	5725.00	-5.80	52.03	46.23	54.00	-7.77	Average	184	232	P
6	5725.00	-5.80	65.87	60.07	74.00	-13.93	Peak	184	232	P
7	11320.00	1.83	40.82	42.65	54.00	-11.35	Average	162	188	P
8	11320.00	1.83	50.76	52.59	74.00	-21.41	Peak	162	188	P
9	16980.00	9.41	28.51	37.92	54.00	-16.08	Average	138	229	P
10	16980.00	9.41	42.72	52.13	74.00	-21.87	Peak	138	229	P

Note: Level=Reading+Factor

Margin=Level-Limit

Factor=Antenna Factor + cable loss - Amplifier Factor



Power	: AC 120V	Pol/Phase	: HORIZONTAL
Test Mode	: Mode 4, CH132	Temperature	: 24°C
Test Date	: Feb. 16, 2017	Humidity	: 63%

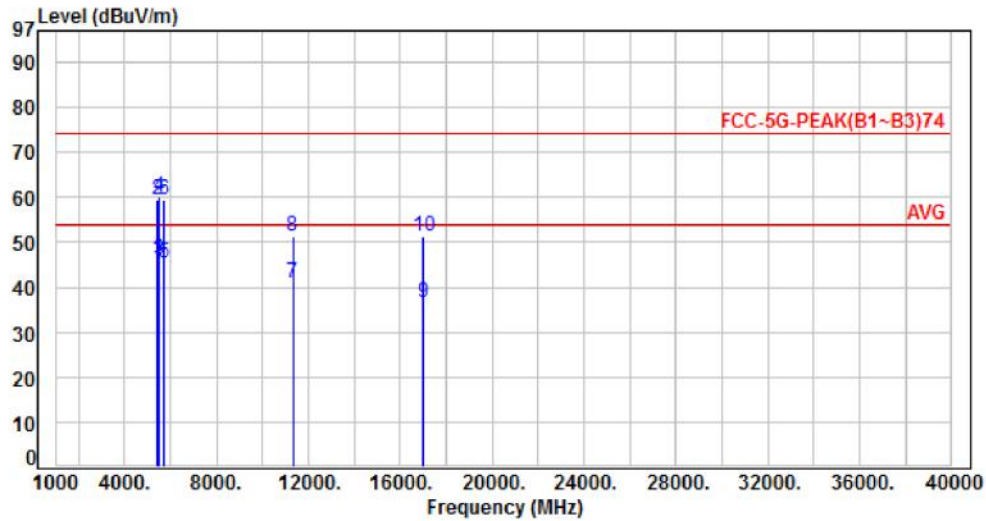

No.	Frequency (MHz)	Factor (dB)	Reading (dBuV)	Level (dBuV)	Limit (dBuV)	Margin (dB)	Detector	Height (cm)	Azimuth (deg)	P/F
1	5460.00	-5.80	51.92	46.12	54.00	-7.88	Average	142	173	P
2	5460.00	-5.80	65.07	59.27	74.00	-14.73	Peak	142	173	P
3	5470.00	-5.78	51.91	46.13	54.00	-7.87	Average	142	173	P
4	5470.00	-5.78	66.01	60.23	74.00	-13.77	Peak	142	173	P
5	5725.00	-5.80	51.19	45.39	54.00	-8.61	Average	142	173	P
6	5725.00	-5.80	65.12	59.32	74.00	-14.68	Peak	142	173	P
7	11320.00	1.83	39.29	41.12	54.00	-12.88	Average	121	81	P
8	11320.00	1.83	49.45	51.28	74.00	-22.72	Peak	121	81	P
9	16980.00	9.41	27.21	36.62	54.00	-17.38	Average	109	332	P
10	16980.00	9.41	41.97	51.38	74.00	-22.62	Peak	109	332	P

Note: Level=Reading+Factor  
 Margin=Level-Limit  
 Factor=Antenna Factor + cable loss - Amplifier Factor



Power	: AC 120V	Pol/Phase	: VERTICAL
Test Mode	: Mode 4, CH140	Temperature	: 24°C
Test Date	: Feb. 16, 2017	Humidity	: 63%

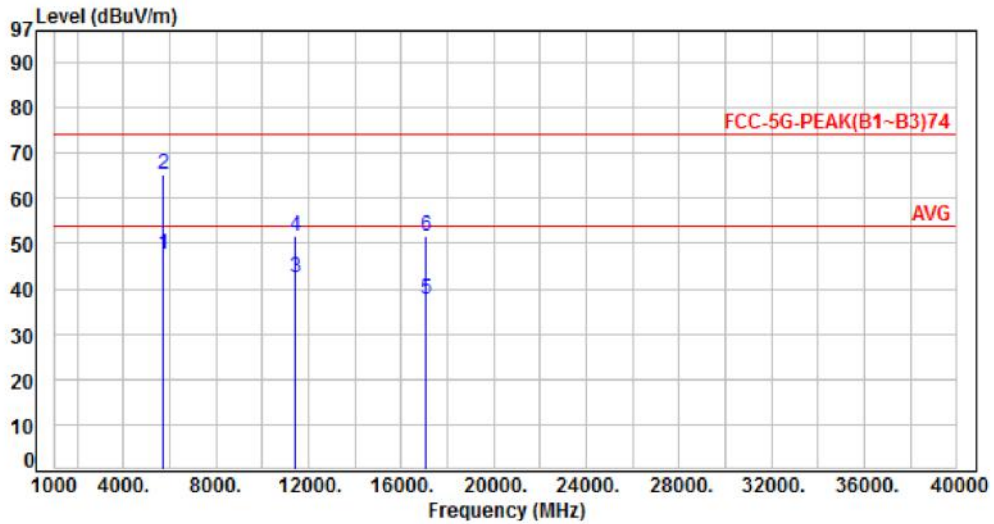

No.	Frequency (MHz)	Factor (dB)	Reading (dBUV)	Level (dBUV)	Limit (dBUV)	Margin (dB)	Detector	Height (cm)	Azimuth (deg)	P/F
1	5725.00	-5.80	53.46	47.66	54.00	-6.34	Average	100	187	P
2	5725.00	-5.80	71.19	65.39	74.00	-8.61	Peak	100	187	P
3	11400.00	1.94	40.56	42.50	54.00	-11.50	Average	254	286	P
4	11400.00	1.94	49.61	51.55	74.00	-22.45	Peak	254	286	P
5	17100.00	10.14	27.53	37.67	54.00	-16.33	Average	172	214	P
6	17100.00	10.14	41.33	51.47	74.00	-22.53	Peak	172	214	P

Note: Level=Reading+Factor  
 Margin=Level-Limit  
 Factor=Antenna Factor + cable loss - Amplifier Factor





Power	: AC 120V	Pol/Phase	: HORIZONTAL
Test Mode	: Mode 4, CH140	Temperature	: 24°C
Test Date	: Feb. 16, 2017	Humidity	: 63%

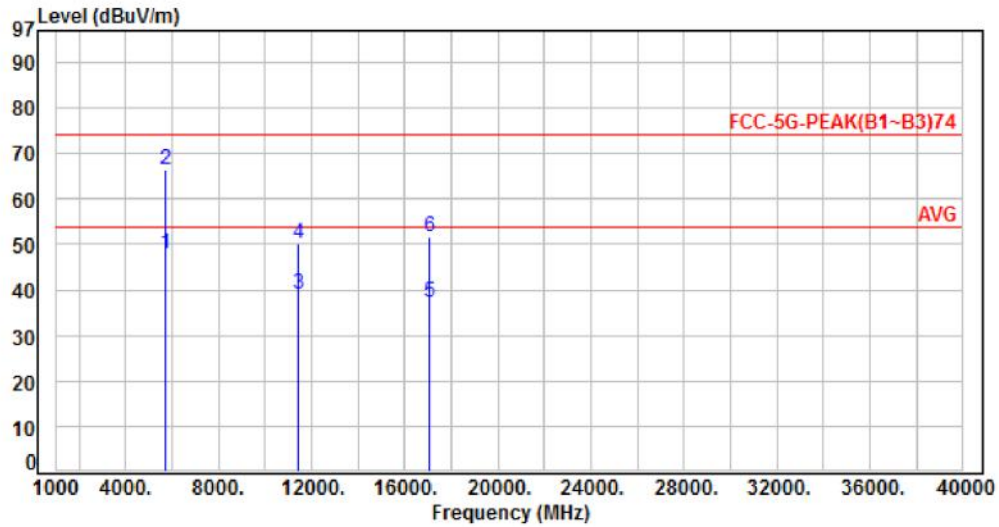

No.	Frequency (MHz)	Factor (dB)	Reading (dBuV)	Level (dBuV)	Limit (dBuV)	Margin (dB)	Detector	Height (cm)	Azimuth (deg)	P/F
1	5725.00	-5.80	53.87	48.07	54.00	-5.93	Average	209	174	P
2	5725.00	-5.80	72.19	66.39	74.00	-7.61	Peak	209	174	P
3	11400.00	1.94	37.25	39.19	54.00	-14.81	Average	100	142	P
4	11400.00	1.94	48.13	50.07	74.00	-23.93	Peak	100	142	P
5	17100.00	10.14	27.26	37.40	54.00	-16.60	Average	100	168	P
6	17100.00	10.14	41.37	51.51	74.00	-22.49	Peak	100	168	P

Note: Level=Reading+Factor  
 Margin=Level-Limit  
 Factor=Antenna Factor + cable loss - Amplifier Factor



Power	: AC 120V	Pol/Phase	: VERTICAL
Test Mode	: Mode 5, CH38	Temperature	: 24°C
Test Date	: Feb. 16, 2017	Humidity	: 63%

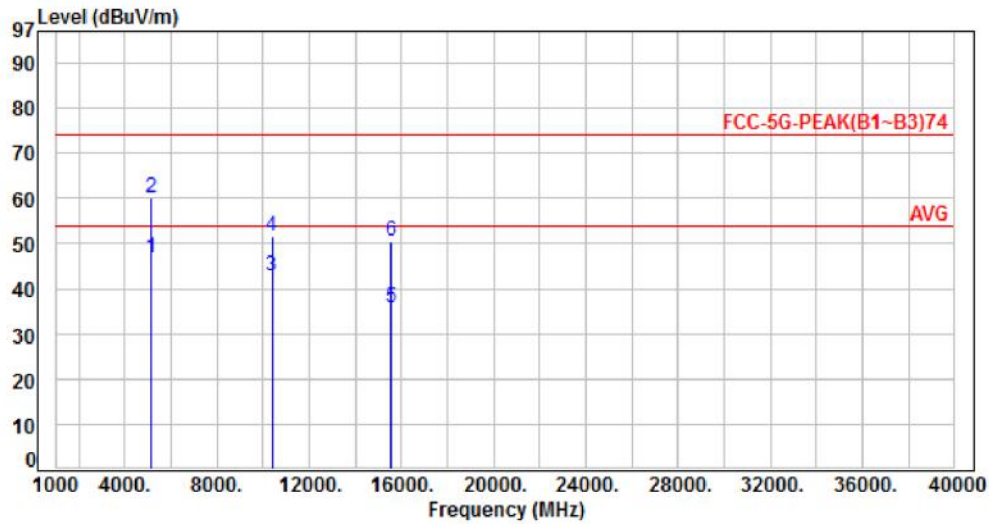

No.	Frequency (MHz)	Factor (dB)	Reading (dBuV)	Level (dBuV)	Limit (dBuV)	Margin (dB)	Detector	Height (cm)	Azimuth (deg)	P/F
1	5150.00	-6.54	53.26	46.72	54.00	-7.28	Average	142	190	P
2	5150.00	-6.54	66.69	60.15	74.00	-13.85	Peak	142	190	P
3	10380.00	0.68	42.23	42.91	54.00	-11.09	Average	106	299	P
4	10380.00	0.68	51.12	51.80	74.00	-22.20	Peak	106	299	P
5	15570.00	5.37	30.43	35.80	54.00	-18.20	Average	167	218	P
6	15570.00	5.37	45.03	50.40	74.00	-23.60	Peak	167	218	P

Note: Level=Reading+Factor  
Margin=Level-Limit  
Factor=Antenna Factor + cable loss - Amplifier Factor



Power	: AC 120V	Pol/Phase	: HORIZONTAL
Test Mode	: Mode 5, CH38	Temperature	: 24°C
Test Date	: Feb. 16, 2017	Humidity	: 63%

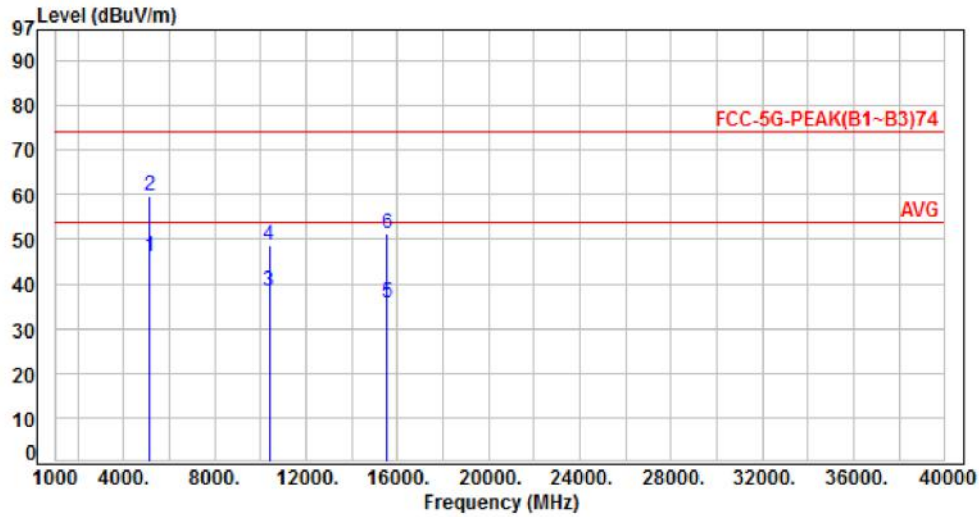

No.	Frequency (MHz)	Factor (dB)	Reading (dBuV)	Level (dBuV)	Limit (dBuV)	Margin (dB)	Detector	Height (cm)	Azimuth (deg)	P/F
1	5150.00	-6.54	52.57	46.03	54.00	-7.97	Average	100	192	P
2	5150.00	-6.54	66.13	59.59	74.00	-14.41	Peak	100	192	P
3	10380.00	0.68	37.56	38.24	54.00	-15.76	Average	100	140	P
4	10380.00	0.68	48.01	48.69	74.00	-25.31	Peak	100	147	P
5	15570.00	5.37	30.56	35.93	54.00	-18.07	Average	116	157	P
6	15570.00	5.37	45.76	51.13	74.00	-22.87	Peak	116	157	P

Note: Level=Reading+Factor  
Margin=Level-Limit  
Factor=Antenna Factor + cable loss - Amplifier Factor



Power	: AC 120V	Pol/Phase	: VERTICAL
Test Mode	: Mode 5, CH46	Temperature	: 24°C
Test Date	: Feb. 16, 2017	Humidity	: 63%

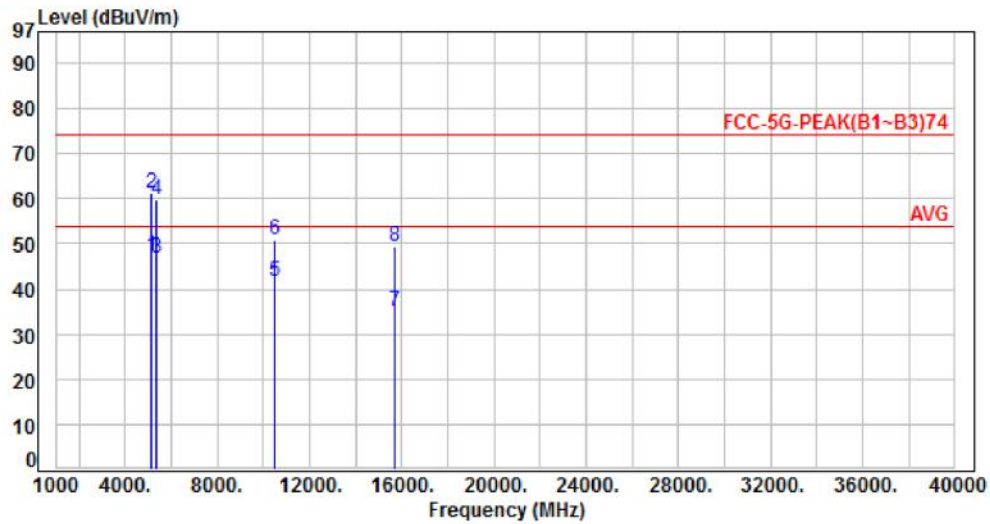

No.	Frequency (MHz)	Factor (dB)	Reading (dBuV)	Level (dBuV)	Limit (dBuV)	Margin (dB)	Detector	Height (cm)	Azimuth (deg)	P/F
1	5150.00	-6.54	53.72	47.18	54.00	-6.82	Average	137	278	P
2	5150.00	-6.54	67.84	61.30	74.00	-12.70	Peak	137	278	P
3	5350.00	-6.06	52.75	46.69	54.00	-7.31	Average	137	278	P
4	5350.00	-6.06	65.88	59.82	74.00	-14.18	Peak	137	278	P
5	10460.00	0.72	40.79	41.51	54.00	-12.49	Average	142	308	P
6	10460.00	0.72	50.00	50.72	74.00	-23.28	Peak	142	308	P
7	15690.00	5.36	29.80	35.16	54.00	-18.84	Average	138	269	P
8	15690.00	5.36	44.04	49.40	74.00	-24.60	Peak	138	269	P

Note: Level=Reading+Factor  
 Margin=Level-Limit  
 Factor=Antenna Factor + cable loss - Amplifier Factor



Power	: AC 120V	Pol/Phase	: HORIZONTAL
Test Mode	: Mode 5, CH46	Temperature	: 24°C
Test Date	: Feb. 16, 2017	Humidity	: 63%

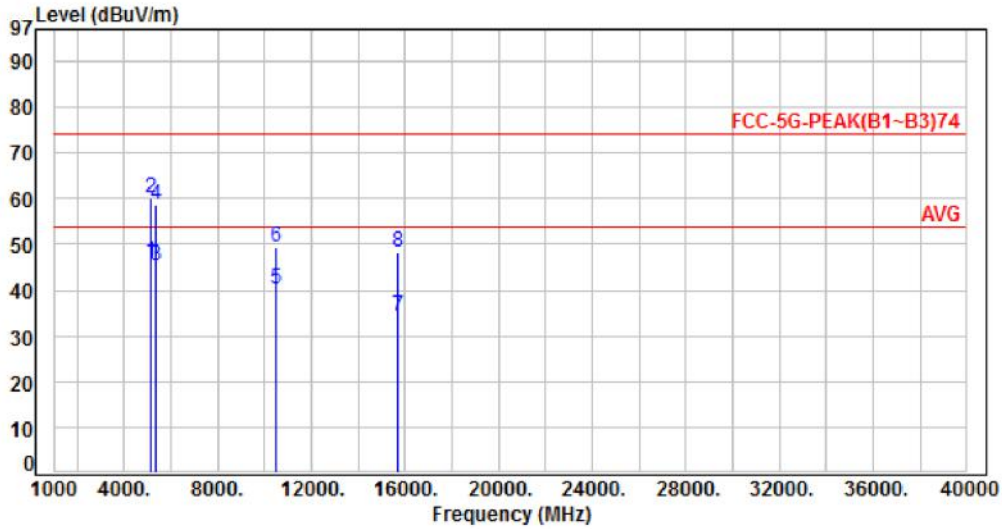

No.	Frequency (MHz)	Factor (dB)	Reading (dBuV)	Level (dBuV)	Limit (dBuV)	Margin (dB)	Detector	Height (cm)	Azimuth (deg)	P/F
1	5150.00	-6.54	52.82	46.28	54.00	-7.72	Average	125	254	P
2	5150.00	-6.54	66.73	60.19	74.00	-13.81	Peak	125	254	P
3	5350.00	-6.06	51.49	45.43	54.00	-8.57	Average	125	254	P
4	5350.00	-6.06	64.73	58.67	74.00	-15.33	Peak	125	254	P
5	10460.00	0.72	39.47	40.19	54.00	-13.81	Average	117	323	P
6	10460.00	0.72	48.70	49.42	74.00	-24.58	Peak	117	323	P
7	15690.00	5.36	29.00	34.36	54.00	-19.64	Average	142	218	P
8	15690.00	5.36	42.82	48.18	74.00	-25.82	Peak	142	218	P

Note: Level=Reading+Factor  
 Margin=Level-Limit  
 Factor=Antenna Factor + cable loss - Amplifier Factor



Power	: AC 120V	Pol/Phase	: VERTICAL
Test Mode	: Mode 5, CH54	Temperature	: 24°C
Test Date	: Feb. 16, 2017	Humidity	: 63%

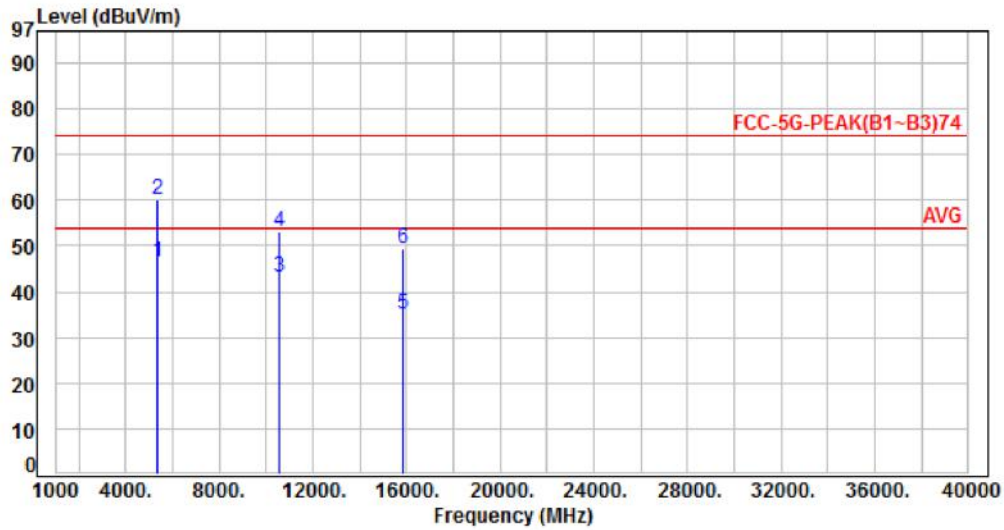

No.	Frequency (MHz)	Factor (dB)	Reading (dBuV)	Level (dBuV)	Limit (dBuV)	Margin (dB)	Detector	Height (cm)	Azimuth (deg)	P/F
1	5350.00	-6.06	52.49	46.43	54.00	-7.57	Average	146	288	P
2	5350.00	-6.06	66.21	60.15	74.00	-13.85	Peak	146	288	P
3	10540.00	0.79	42.37	43.16	54.00	-10.84	Average	152	311	P
4	10540.00	0.79	52.16	52.95	74.00	-21.05	Peak	152	311	P
5	15810.00	5.38	29.84	35.22	54.00	-18.78	Average	122	273	P
6	15810.00	5.38	44.06	49.44	74.00	-24.56	Peak	122	273	P

Note: Level=Reading+Factor  
 Margin=Level-Limit  
 Factor=Antenna Factor + cable loss - Amplifier Factor