



Report On

Application for Grant of Equipment Authorization of the
Nextivity Inc.

Cel-Fi Quatra Cellphone Signal Repeater

FCC CFR 47 Part 20
RSS-131

Report No. SD72113545-0216F Rev1.0

June 2016

FCC ID: NU: YETQ34-251266NU
CU: YETQ34-251266CU
IC: NU: 9298A-Q34251266NU
CU: 9298A-Q34251266CU
Report No. SD72113545-0216F Rev1.0



REPORT ON Radio Testing of the
Nextivity Inc.
Cellphone Signal Repeater

TEST REPORT NUMBER SD72113545-0216F Rev1.0

PREPARED FOR Nextivity Inc.
12230 World Trade Drive, Suite 250
San Diego, CA 92128

CONTACT PERSON CK Li
Sr. Principal Engineer, Regulatory
(858) 829-1692
CLi@NextivityInc.com

PREPARED BY 
Xiaoying Zhang
Name
Authorized Signatory
Title: EMC/Wireless Test Engineer

APPROVED BY 
Juan M. Gonzalez
Name
Authorized Signatory
Title: Commercial Wireless EMC Lab Manager

DATED June 23, 2016

FCC ID: NU: YETQ34-251266NU
 CU: YETQ34-251266CU
 IC: NU: 9298A-Q34251266NU
 CU: 9298A-Q34251266CU
 Report No. SD72113545-0216F Rev1.0



Revision History

SD72113545-0216F Rev1.0 Nextivity Inc. Cel-Fi Quatra Cellphone Signal Repeater					
DATE	OLD REVISION	NEW REVISION	REASON	PAGES AFFECTED	APPROVED BY
06/23/16	Initial Release				Juan M Gonzalez
06/23/16	Initial Release	Rev1.0	Add missing result in the table of section 1.2	7	Juan M Gonzalez



CONTENTS

Section	Page No
1	REPORT SUMMARY 5
1.1	Introduction 6
1.2	Brief Summary of Results..... 7
1.3	Product Information 8
1.4	EUT Test configuration..... 11
1.5	Deviations from the Standard..... 16
1.6	Modification Record 16
1.7	Test Methodology 16
1.8	Test Facility Location..... 16
1.9	Test Facility Registration 16
2	TEST DETAILS 18
2.1	Authorized Frequency Band Verification 19
2.2	Authorized CMRS Provider 25
2.3	Maximum Power Measurement and Booster Gain Computation 43
2.4	Intermodulation Product 46
2.5	Out of Band Emissions 56
2.6	Noise Limit 73
2.7	Uplink Inactivity 77
2.8	Variable Booster Gain 81
2.9	Oscillation Detection..... 88
2.10	Out of Band Gain Limit..... 95
3	TEST EQUIPMENT USED 101
3.1	Test Equipment Used..... 102
3.2	Measurement Uncertainty 103
4	DIAGRAM OF TEST SETUP 104
4.1	Test Setup Diagram..... 105
5	ACCREDITATION, DISCLAIMERS AND COPYRIGHT 110
5.1	Accreditation, Disclaimers and Copyright..... 111

FCC ID: NU: YETQ34-251266NU
CU: YETQ34-251266CU
IC: NU: 9298A-Q34251266NU
CU: 9298A-Q34251266CU
Report No. SD72113545-0216F Rev1.0



SECTION 1

REPORT SUMMARY

Radio Testing of the
Nextivity Inc.
Cel-Fi Quatra Cellphone Signal Repeater



1.1 INTRODUCTION

The information contained in this report is intended to show verification of the Nextivity Inc. Cellphone Signal Repeater to the requirements of the following:

- FCC CFR 47 Part 20
- RSS-131

Objective	To perform Radio Testing to determine the Equipment Under Test's (EUT's) compliance with the Test Specification, for the series of tests carried out.
Manufacturer	Nextivity Inc.
Model Name	Cel-Fi Quatra
Model Number(s)	Q34-2/5/12/66NU Q34-2/5/12/66CU
FCC ID Number	NU: YETQ34-251266NU CU: YETQ34-251266CU
IC Number	NU: 9298A-Q34251266NU CU: 9298A-Q34251266CU
Serial Number(s)	25860200035 (NU) and 25955100346 (CU) 258602000014 (NU) and 259551000131 (CU)
Number of Samples Tested	4
Test Specification/Issue/Date	<ul style="list-style-type: none">• FCC CRF 47 Part 20 (October 1, 2015).• RSS-131 – Zone Enhancers (Issue 3, January 2016)• KDB935210 (D04 Provider Specific booster Measurements v01r01) Provider-Specific Consumer Signal Booster Compliance Measurements Guidance.
Start of Test	April 20, 2016
Finish of Test	June 16, 2016
Name of Engineer(s)	Xiaoying Zhang
Related Document(s)	<ul style="list-style-type: none">• Supporting documents for EUT certification are separate exhibits.



1.2 BRIEF SUMMARY OF RESULTS

A brief summary of the tests carried out in accordance with FCC CFR 47 Part 20 with cross-reference to the corresponding KDB935210 D04 is shown below.

Section	Spec Clause		Test Description	Result
	FCC Part 20	KDB935210 D04		
2.1 2.2	20.21 (e)(3) Frequency Bands 20.21 (a)(4)	7.1	Authorized Frequency Band Verification Test and authorized CMRS provider test	Compliant
2.3	20.21(e)(9)(i)(D) Power Limits	7.2	Maximum Power measurement procedure Maximum Booster Gain Computer	Compliant
	20.21(e)(9)(i)(B) Bidirectional Capability 20.21(e)(9)(i)(C)(1) and (2) Booster Gain Limits	7.3		
2.4	20.21(e)(9)(i)(G) Intermodulation Limit	7.4	Intermodulation Product	Compliant
2.5	20.21(e)(9)(i)(F) Out of Band Gain Limit	7.5	Out-of-Band Emissions	Compliant
-	2.1051	7.6	Conducted Spurious Emissions	N/A*
2.6	20.21(e)(9)(i)(A) Noise Limits	7.7	Noise Limits	Compliant
	20.21(e)(9)(i)(I) Transmit Power Off Mode			
2.7	20.21(e)(9)(i)(J) Uplink Inactivity	7.8	Uplink inactivity	Compliant
2.8	20.21(e)(9)(i)(C)(1) Booster Gain Limits	7.9	Variable Booster Gain	Compliant
	20.21(e)(9)(i)(I) Transmit Power Off Mode			
-	2.1049	7.10	Occupied Bandwidth	N/A*
2.9	20.21(e)(9)(ii)(A) Anti-Oscillation	7.11	Oscillation Detection	Compliant
-	2.1053	7.12	Radiated Spurious Emissions	N/A*
-	20.21(e)(9)(i)(B) Bidirectional Capability 20.21(e)(3) Frequency Band	7.13	Spectrum Block Filtering	N/A**
2.10	20.21(e)(9)(i)(E) Out of Band Gain Limit	7.14	Out of Band Gain	Compliant
-	2.1055	7.15	Frequency Stability	N/A*

N/A* - Not Applicable. Different Standard Applies; Refer to test report SD72113545-0216C for WCDMA Band 2 and Band 5, SD72113545-0216D for LTE Band 12 and SD72113545-0216G for LTE Band 4
 N/A** - Not Applicable. The EUT does not utilize spectrum block filtering.



1.3 PRODUCT INFORMATION

1.3.1 Technical Description

The Equipment Under Test (EUT) was a Nextivity Inc. Cel-Fi Quatra Cellphone Signal Repeater. The EUT is a WCDMA/LTE Signal Booster to improve voice and data cellular performance in large enterprise environments. The EUT consists of two separate units: the Network Unit (NU) and the Coverage Unit (CU). The NU comprises a transmitter and receiver which communicate with the cell tower and the CU. Users place the NU in an area with the strongest signal from the carrier network. The CU is then placed in the center of the home or office, or in the area where the best signal quality is best needed. The NU and CU are placed at varying distances apart and are communicated via Ethernet cables. The WCDMA Band 2, Band 5 and LTE Band 12, Band 4 function of the EUT were verified in this test report.



1.3.2 EUT General Description

EUT Description	Cellphone Signal Repeater
Model Name	Cel-Fi Quatra
Model Number(s)	Q34-2/5/12/66NU Q34-2/5/12/66CU
Rated Voltage	NU: 54V DC via external AC/DC adapter CU: 54V DC via POE
Mode Verified	WCDMA Band 2, Band 5 and LTE Band 12, Band 4
Frequency Bands	WCDMA Band 2: NU: 1850 - 1910MHz CU: 1930 - 1990MHz WCDMA Band 5: NU: 824 - 849MHz CU: 869 - 894MHz LTE Band 12: NU: 699 - 716MHz CU: 729 - 746MHz LTE Band 4: NU: 1710 - 1755MHz CU: 2110 - 2155MHz
Channel Bandwidth	WCDMA Band 2: 5MHz,10MHz (2C), 15MHz (3C) and 20MHz (4C) WCDMA Band 5: 5MHz, 10MHz (2C) and 15MHz (3C) LTE Band 12: 5MHz, 10MHz LTE Band 4: 5MHz, 10MHz, 15MHz and 20MHz
Capability	WCDMA Band 2, Band 5 and LTE Band 12, Band 4 and BT-LE
Primary Unit (EUT)	<input type="checkbox"/> Production <input checked="" type="checkbox"/> Pre-Production <input type="checkbox"/> Engineering
Manufacturer Declared Temperature Range	0°C to 40°C

FCC ID: NU: YETQ34-251266NU
CU: YETQ34-251266CU
IC: NU: 9298A-Q34251266NU
CU: 9298A-Q34251266CU
Report No. SD72113545-0216F Rev1.0



Antenna Type

PCB PIFA

Manufacturer

Nextivity Inc.

Antenna Model

N/A

Antenna Gain

Band	NU	CU
2, 4	2 dBi	2 dBi
5, 12	0 dBi	0 dBi



1.4 EUT TEST CONFIGURATION

1.4.1 Test Configuration Description

Test Configuration	Description
A	Test Mode - Downlink (CU TX). Input signal is applied to B2, B5, B12, or B4 antenna port of NU. Output is monitored from B2, B5, B12, or B4 Top antenna port of CU. (refer to 1.4.4 Figure 2)
B	Test Mode - Uplink (NU TX). Input signal is applied to B2, B5, B12, or B4 antenna port of CU. Output is monitored from B2, B5, B12, or B4 Top antenna port of NU. (refer to 1.4.4 Figure 3)
C	Normal Mode - Downlink (CU TX). Base Station Simulator is employed to send a modulated signal to B2, B5, B12, or B4 antenna port of NU. B2, B5, B12, or B4 Top antenna port of CU is terminated with a 50Ω load. (refer to 1.4.4 Figure 1)
D	Normal Mode - Uplink (NU TX). Base Station Simulator is employed to send a modulated signal to B2, B5, B12, or B4 antenna port of NU. Input signal is applied to B2, B5, B12, or B4 antenna port of CU. (refer to 1.4.4 Figure 1)
E	Inter-modulation. Test setup identical to Test Configuration A and B above with the addition of another signal applied to the input of the EUT. A coupler was used in the setup to ensure that the additional signal is directed to the EUT input port. (refer to 1.4.4 Figure 4)
F	Max Downlink noise limit testing - A 50 Ohm Termination is connected to the NU antenna port and Measure the Noise Limit at the CU antenna port. (refer to 1.4.4 Figure 5)
G	Max Uplink noise limit testing - A 50 Ohm Termination is connected to the CU antenna port. A signal is connected to a step attenuator and then applied to the NU antenna port. Output is monitored from B2, B5, B12, or B4 Top antenna port of NU. (refer to 1.4.4 Figure 6)
H	Max Downlink noise limit testing - A 50 Ohm Termination is connected to the CU antenna port. A signal is connected to a step attenuator and then applied to the NU antenna port. Output is monitored from B2, B5, B12, or B4 Top antenna port of CU. (refer to 1.4.4 Figure 6)

1.4.2 EUT Exercise Software

Manufacturer provided a configuration software (conformanceTest.exe)



1.4.3 Support Equipment and I/O cables

Manufacturer	Equipment/Cable	Description
Nextivity	AC/DC Adapter (EUT)	M/N: 290N029-001, IP: 100-240VAC, 1.6A, 50-60Hz OP: 54VDC, 2.22A
-	Support USB cable	1.75 meters, shielded Type A to Micro B connector
Nextivity	Support USB cable	Custom 1.0 meter shielded USB Type A to DB9 for the Shielded Test Enclosure
Lenovo	Support Laptop	M/N: 2912-3VU, S/N: R9-92MH0 10/11
Lenovo	Support Laptop AC Adapter	M/N: 42T4430 S/N: 11S42T4430Z1ZGWE27AA9X
Rhode & Schwarz	Support Wideband Radio Communication Tester	M/N CMW500 S/N 1201.0002K50/103829
Rhode & Schwarz	Support Radio Communication Tester	M/N: CMU200, S/N: 114536
Agilent	ESG Vector Signal Generator	M/N: E4438C, S/N: MY47271033
Aeroflex international LTD.	DFS Radar Simulator and Analyzer*	M/N: Aeroflex 3005, S/N: 30050A/09L
K&L	1500 - 3000 MHz Tuneable Bypass Filter	M/N 5BT-1500/3000-5-N/N
Agilent	11dB Step Attenuator	M/N 8494B Frequency Range DC - 18GHz S/N 2812A17193
Agilent	110dB Step Attenuator	M/N 8496B Frequency Range DC - 18GHz S/N MY42143874
Ramsey	Support Shielded Test Enclosure	With custom USB cable

1.4.4 Simplified Test Configuration Diagram

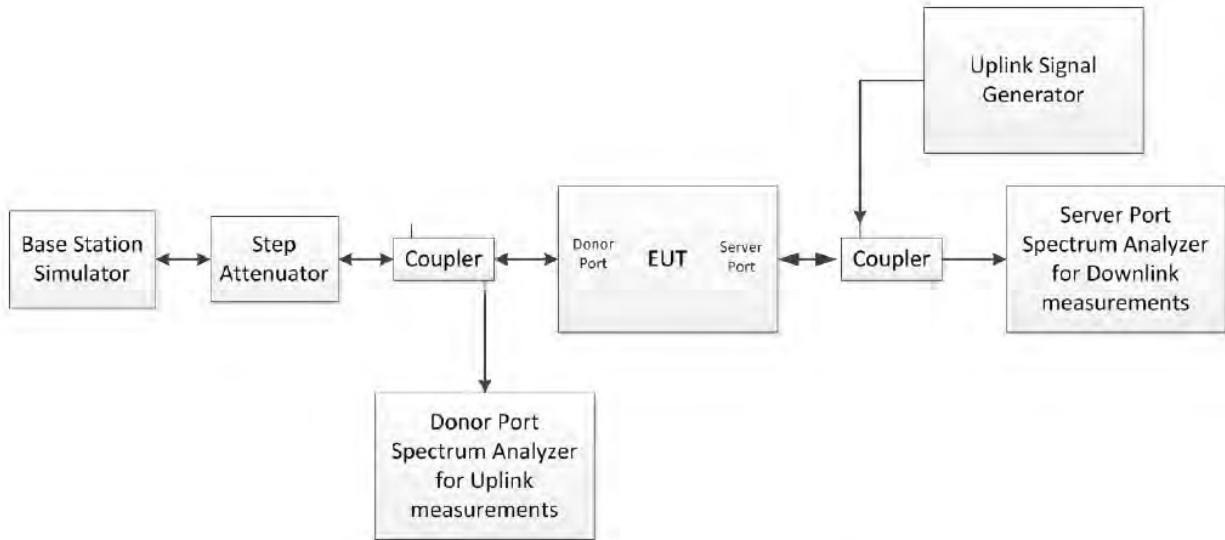

Figure 1: Test Configuration in Normal Mode

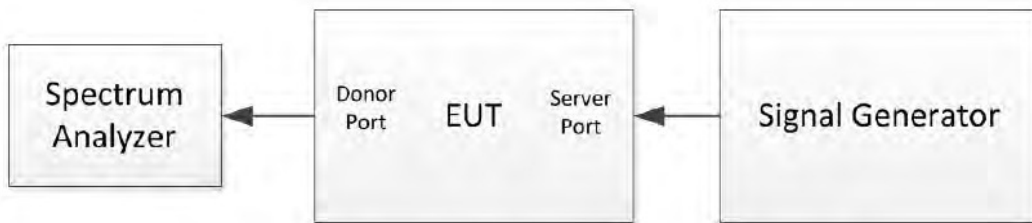

Figure 2: Uplink Test Configuration in Test Mode



Figure 3: Downlink Test Configuration in Test Mode

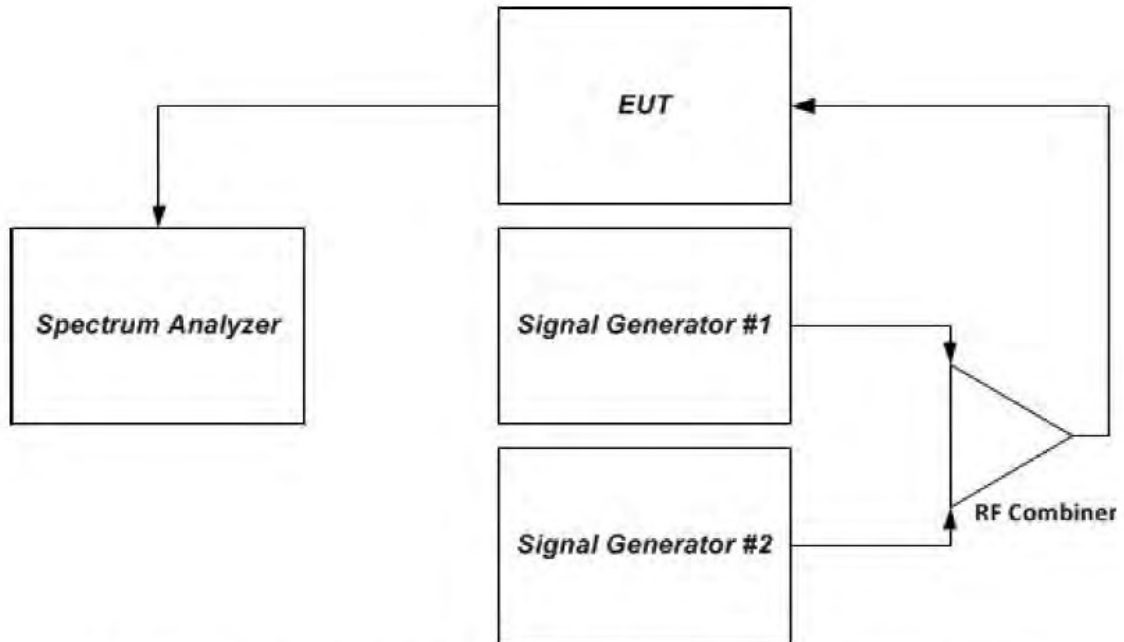

Figure 4 – Intermodulation product instrumentation test setup



Figure 5: Maximum downlink noise limit test configuration

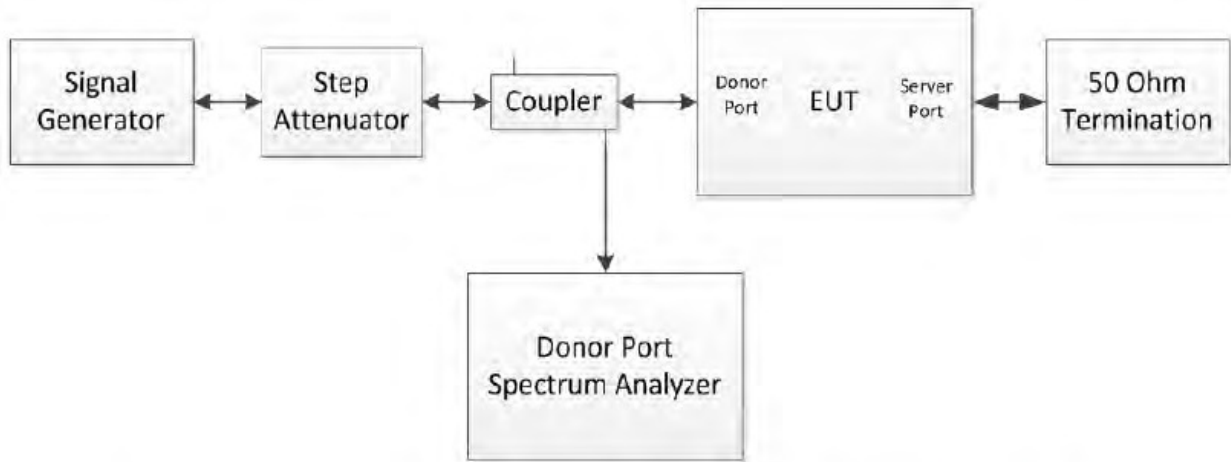

Figure 6: Uplink RSSI dependent noise limit test configuration

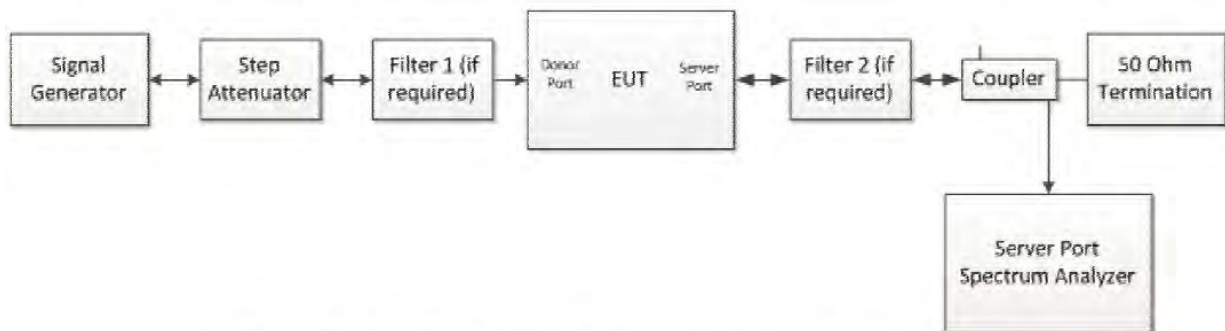

Figure 7: Downlink RSSI dependent noise limit test configuration



1.5 DEVIATIONS FROM THE STANDARD

No deviations from the applicable test standards or test plan were made during testing.

1.6 MODIFICATION RECORD

Description of Modification	Modification Fitted By	Date Modification Fitted
Serial Number 25860200035 (NU) and 25955100346 (CU); 258602000014 (NU) and 259551000131 (CU)		
N/A		

The table above details modifications made to the EUT during the test programme. The modifications incorporated during each test (if relevant) are recorded on the appropriate test pages.

1.7 TEST METHODOLOGY

All measurements contained in this report were conducted as per KDB935210 D04 Provider-Specific Consumer Signal Boosters Compliance Measurements Guidance (January 5, 2015).

1.8 TEST FACILITY LOCATION

1.8.1 TÜV SÜD America Inc. (Mira Mesa)

10040 Mesa Rim Road, San Diego, CA 92121-2912 (32.901268,-117.177681). Phone: 858 678 1400 FAX: 858-546 0364

1.8.2 TÜV SÜD America Inc. (Rancho Bernardo)

Building #8, 16530 Via Esprillo, San Diego, CA 92127-1708 (33.018644,-117.092409). Phone: 858 942 5542 Fax: 858 546 0364.

1.9 TEST FACILITY REGISTRATION

1.9.1 FCC – Registration No.: US1146

TUV SUD America Inc. (San Diego), is an accredited test facility with the site description report on file and has met all the requirements specified in §2.948 of the FCC rules. The acceptance letter from the FCC is maintained in our files and the Registration is US1146.

FCC ID: NU: YETQ34-251266NU
CU: YETQ34-251266CU
IC: NU: 9298A-Q34251266NU
CU: 9298A-Q34251266CU
Report No. SD72113545-0216F Rev1.0



1.9.2 Innovation, Science and Economic Development Canada Registration No.: 3067A

The 10m Semi-anechoic chamber of TÜV SÜD America Inc. (San Diego) has been registered by Certification and Engineering Bureau of Innovation, Science and Economic Development Canada for radio equipment testing with Registration No. 3067A.

FCC ID: NU: YETQ34-251266NU
CU: YETQ34-251266CU
IC: NU: 9298A-Q34251266NU
CU: 9298A-Q34251266CU
Report No. SD72113545-0216F Rev1.0



SECTION 2

TEST DETAILS

Radio Testing of the
Nextivity Inc.
Cel-Fi Quatra Cellphone Signal Repeater



2.1 AUTHORIZED FREQUENCY BAND VERIFICATION

2.1.1 Specification Reference

FCC 47 CFR Part 20, Clause 20.21 (e)(3)
FCC 47 CFR Part 20, Clause 20.21(a)(4)
KDB935210 D04, Clause 7.1

2.1.2 Standard Applicable

FCC 47 CFR Part 20, Clause 20.21 (e)(3) Frequency Bands:
Consumer Signal Boosters must be designed and manufactured such that they only operate on the frequencies used for the provision of subscriber-based services under parts 22 (Cellular), 24 (Broadband PCS), 27 (AWS-1, 700 MHz Lower A-E Blocks, and 700 MHz Upper C Block), and 90 (Specialized Mobile Radio) of this chapter. The Commission will not certificate any Consumer Signal Boosters for operation on part 90 of this chapter (Specialized Mobile Radio) frequencies until the Commission releases a public notice announcing the date Consumer Signal Boosters may be used in the band.

FCC 47 CFR Part 20, Clause 20.21(a)(4) Self Monitoring:
The subscriber operates the Consumer Signal Booster on frequencies used for the provision of subscriberbased services under parts 22 (Cellular), 24 (Broadband PCS), 27 (AWS-1, 700 MHz Lower A-E Blocks, and 700 MHz Upper C Block), and 90 (Specialized Mobile Radio) of this chapter. Operation on part 90 (Specialized Mobile Radio) frequencies is permitted upon the Commission's release of a public notice announcing the date Consumer Signal Boosters may be used in the band;

2.1.3 Equipment Under Test and Modification State

Serial No: 25860200035 (NU) and 25955100346 (CU) / Test Configuration A and B

2.1.4 Date of Test/Initial of test personnel who performed the test

April 20, 2016/XYZ

2.1.5 Test Equipment Used

The major items of test equipment used for the above tests are identified in Section 3.1.

2.1.6 Environmental Conditions

Test performed at TÜV SÜD America Inc. Rancho Bernardo facility.

Ambient Temperature	28.8°C
Relative Humidity	21.6%
ATM Pressure	98.9kPa



2.1.7 Additional Observations

- 1) This is conducted Test. Test procedure is per Section 7.1.1 of KDB935210 (D04 Provider Specific Booster Measurements v01r01). Appropriate offset (line losses) applied.
- 2) The EUT operated in Test Mode, with the gain manually set to the maximum gain and a minimum bandwidth setting (5MHz).
- 3) Setup the EUT according to Figure 2 or 3 of Section 6.3.3 of KDB935210 (D04 Provider Specific Booster Measurements v01r01) as appropriate.
- 4) Evaluations are conducted at CU antenna ports B2/12, and B5/B4, and NU antenna ports B2/12, and B5/B4.
- 5) All operational uplink and downlink bands for WCDMA Band 2, 5, and LTE Band 12 and 4 were tested.
- 6) The signal generator was set to transmit a 5MHz LTE or WCDMA signal.
- 7) DL: B2: 1930 – 1990MHz; B5: 869 - 894MHz, B12:729 – 746MHz; B4:2110 – 2155MHz;
 UL: B2: 1850 – 1910MHz; B5: 824 - 849MHz, B12:699 – 716MHz; B4:1710 – 1755MHz;

2.1.8 Test Results

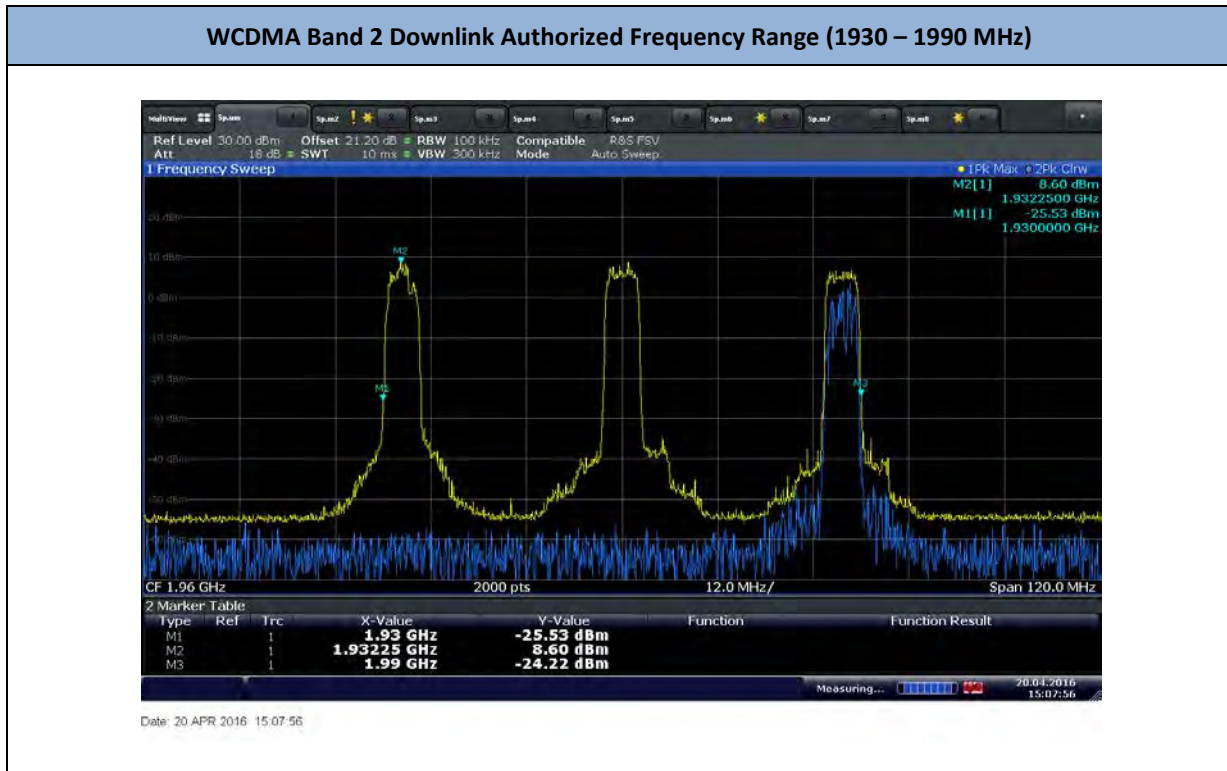

WCDMA Band 2 Uplink Authorized Frequency Range (1850 – 1910 MHz)

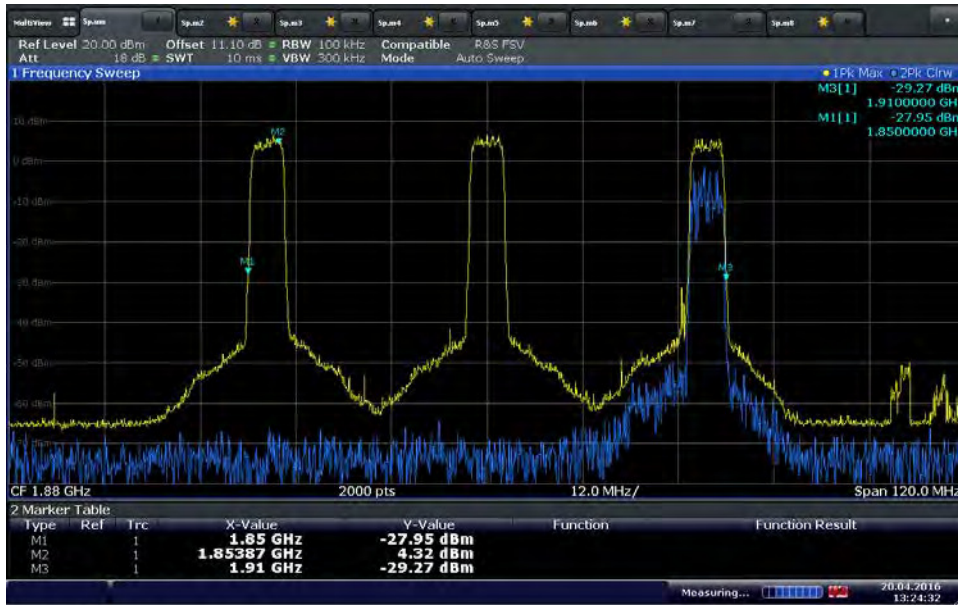

Date: 20 APR 2016 13:24:32

WCDMA Band 5 Downlink Authorized Frequency Range (869 – 894 MHz)



Date: 20 APR 2016 14:48:54

WCDMA Band 5 Uplink Authorized Frequency Range (824 – 849 MHz)

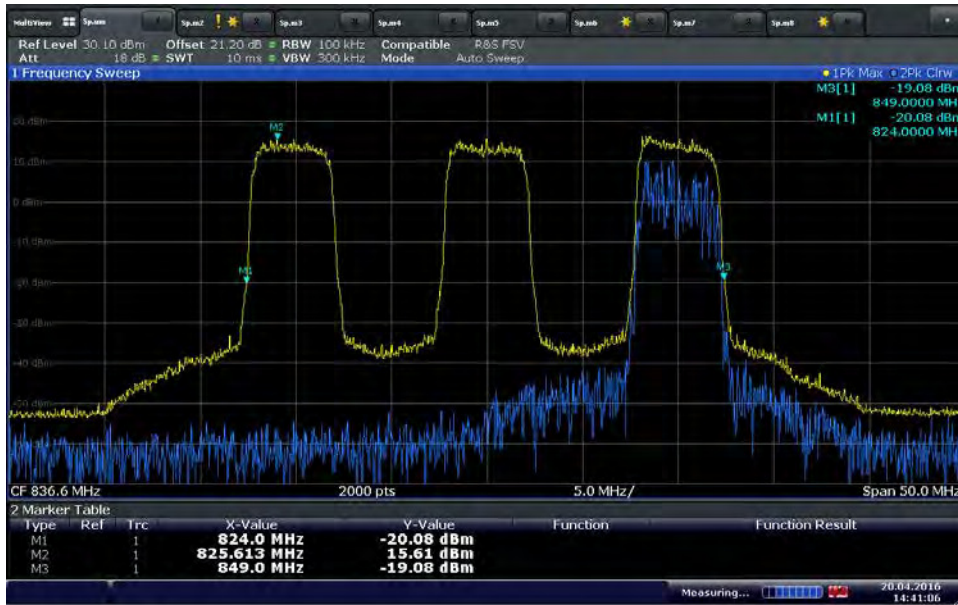

Date: 20 APR 2016 14:41:06

LTE Band 12 Downlink Authorized Frequency Range (729 – 746 MHz)



Date: 20 APR 2016 15:03:20



LTE Band 12 Uplink Authorized Frequency Range (699 – 716 MHz)

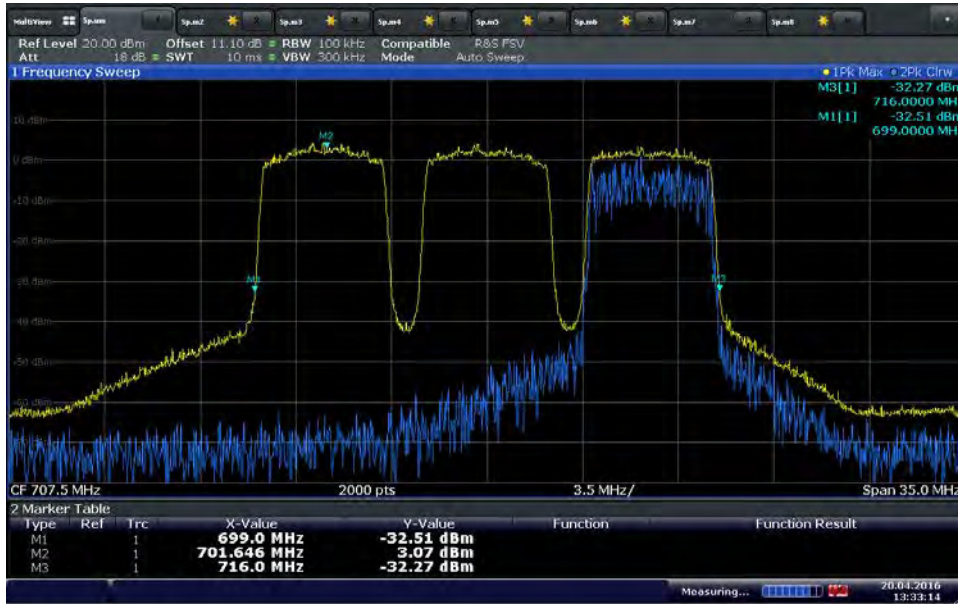

Date: 20 APR 2016 13:33:14

LTE Band 4 Downlink Authorized Frequency Range (2110 – 2155 MHz)

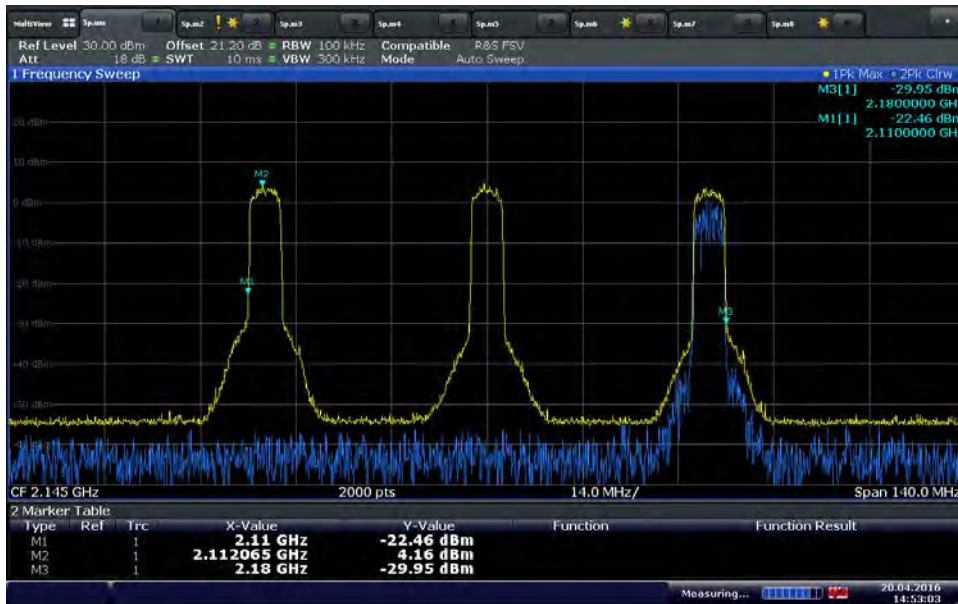

Date: 20 APR 2016 14:53:03



LTE Band 4 Uplink Authorized Frequency Range (1710 – 1755 MHz)

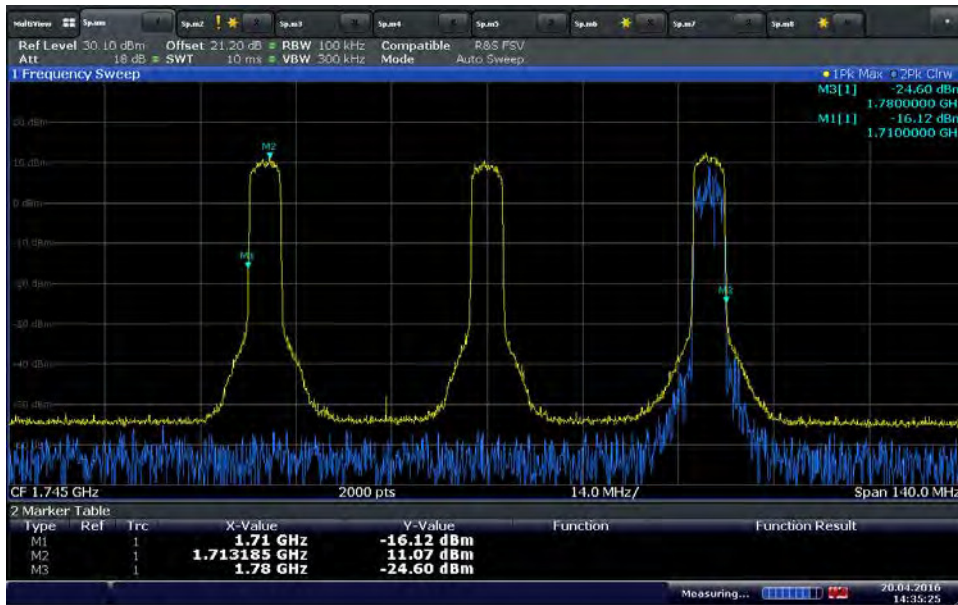

Date: 20 APR 2016 14:35:26



2.2 AUTHORIZED CMRS PROVIDER

2.2.1 Specification Reference

FCC 47 CFR Part 20, Clause 20.21 (e)(3)
FCC 47 CFR Part 20, Clause 20.21(a)(4)
KDB935210 D04, Clause 7.1

2.2.2 Standard Applicable

FCC 47 CFR Part 20, Clause 20.21 (e)(3) Frequency Bands:
Consumer Signal Boosters must be designed and manufactured such that they only operate on the frequencies used for the provision of subscriber-based services under parts 22 (Cellular), 24 (Broadband PCS), 27 (AWS-1, 700 MHz Lower A-E Blocks, and 700 MHz Upper C Block), and 90 (Specialized Mobile Radio) of this chapter. The Commission will not certificate any Consumer Signal Boosters for operation on part 90 of this chapter (Specialized Mobile Radio) frequencies until the Commission releases a public notice announcing the date Consumer Signal Boosters may be used in the band.

FCC 47 CFR Part 20, Clause 20.21(a)(4) Self Monitoring:
The subscriber operates the Consumer Signal Booster on frequencies used for the provision of subscriberbased services under parts 22 (Cellular), 24 (Broadband PCS), 27 (AWS-1, 700 MHz Lower A-E Blocks, and 700 MHz Upper C Block), and 90 (Specialized Mobile Radio) of this chapter. Operation on part 90 (Specialized Mobile Radio) frequencies is permitted upon the Commission's release of a public notice announcing the date Consumer Signal Boosters may be used in the band;

2.2.3 Equipment Under Test and Modification State

Serial No: 258602000014 (NU) and 259551000131 (CU) / Test Configuration C and D

2.2.4 Date of Test/Initial of test personnel who performed the test

May 12 and 13, 2016/XYZ

2.2.5 Test Equipment Used

The major items of test equipment used for the above tests are identified in Section 3.1.

2.2.6 Environmental Conditions

Test performed at TÜV SÜD America Inc. Rancho Bernardo facility.

Ambient Temperature	26.9 - 27.4°C
Relative Humidity	44.4 - 47.0%
ATM Pressure	99.2kPa



2.2.7 Additional Observations

- 1) This is conducted Test. Test procedure is per Section 7.1.2 of KDB935210 (D04 Provider Specific Booster Measurements v01r01). Appropriate offset (line losses) applied.
- 2) The EUT operated in Normal Mode, with the gain manually set to the maximum gain and a minimum bandwidth setting (5MHz).
- 3) Setup the EUT according to Figure 1 of Section 6.3.2 of KDB935210 (D04 Provider Specific Booster Measurements v01r01) with the Base Station Simulator transmitting an authorized CMRS provider signal to the booster.
- 4) Evaluations are conducted at CU antenna ports B2/B12 and B5/B4, and NU antenna ports B2/B12 and B5/B4.
- 5) All operational uplink and downlink bands for WCDMA Band 2, 5, and LTE Band 12 and 4 were tested.
- 6) The Base Station Simulator was set to transmit a 5MHz LTE signal or WCDMA.
- 7) The authorized CMRS Provider ID: 310/410
- 8) Four Non- authorized CMRS Provider signals were verified.
- 9) DL: B2: 1930 – 1990MHz; B5: 869 – 894MHz; B12: 729 – 746MHz; B4:2110 – 2155MHz;
UL: B2: 1850 – 1910MHz; B5: 824 – 849MHz; B12: 699 – 716MHz; B4:1710 – 1755MHz;

2.2.8 Test Results

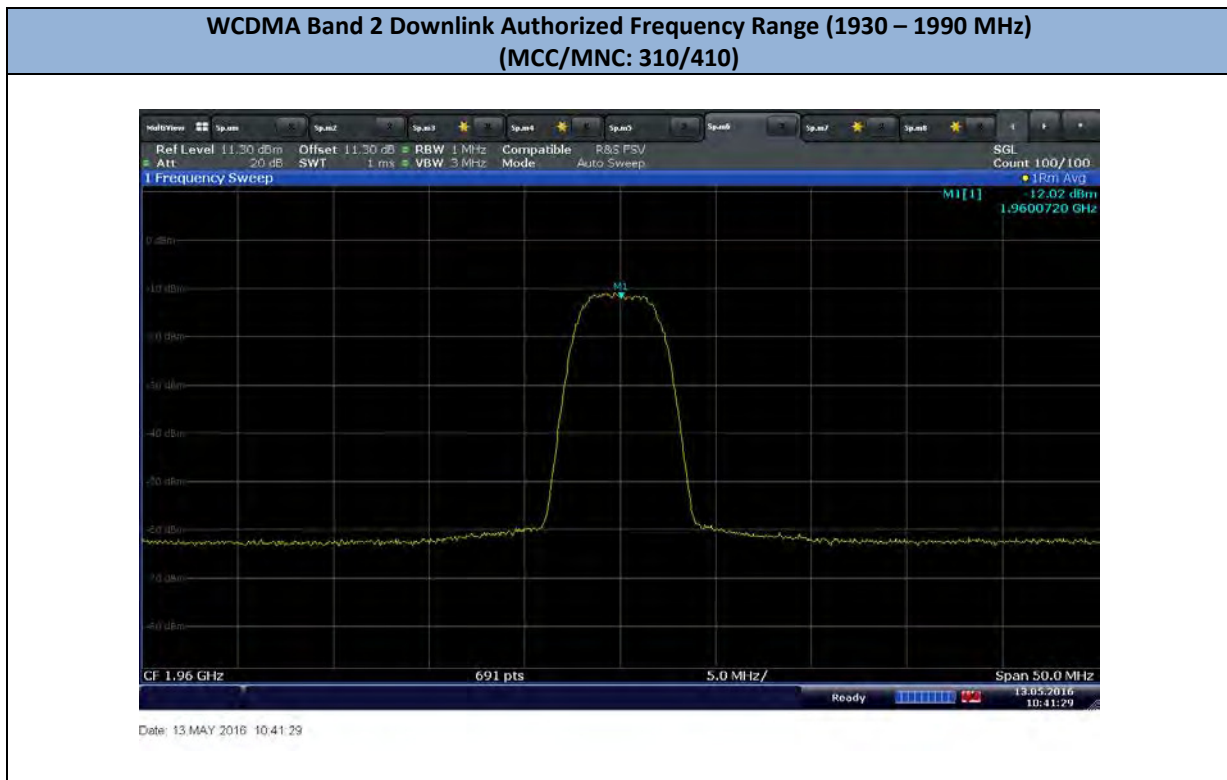



**WCDMA Band 2 Downlink Authorized Frequency Range (1930 – 1990 MHz)
 (MCC/MNC: 310/070)**



Date: 12.MAY.2016 10:15:18

**WCDMA Band 2 Downlink Authorized Frequency Range (1930 – 1990 MHz)
 (MCC/MNC: 310/120)**



Date: 12.MAY.2016 10:15:41



**WCDMA Band 2 Uplink Authorized Frequency Range (1850 – 1910 MHz)
 (MCC/MNC: 310/410)**



Date: 13 MAY 2016 11:26:21

**WCDMA Band 2 Uplink Authorized Frequency Range (1850 – 1910 MHz)
 (MCC/MNC: 310/070)**



Date: 12 MAY 2016 10:16:59



**WCDMA Band 2 Uplink Authorized Frequency Range (1850 – 1910 MHz)
 (MCC/MNC: 310/120)**



Date: 12 MAY 2016 10:16:33

**WCDMA Band 5 Downlink Authorized Frequency Range (869 – 894 MHz)
 (MCC/MNC: 310/410)**

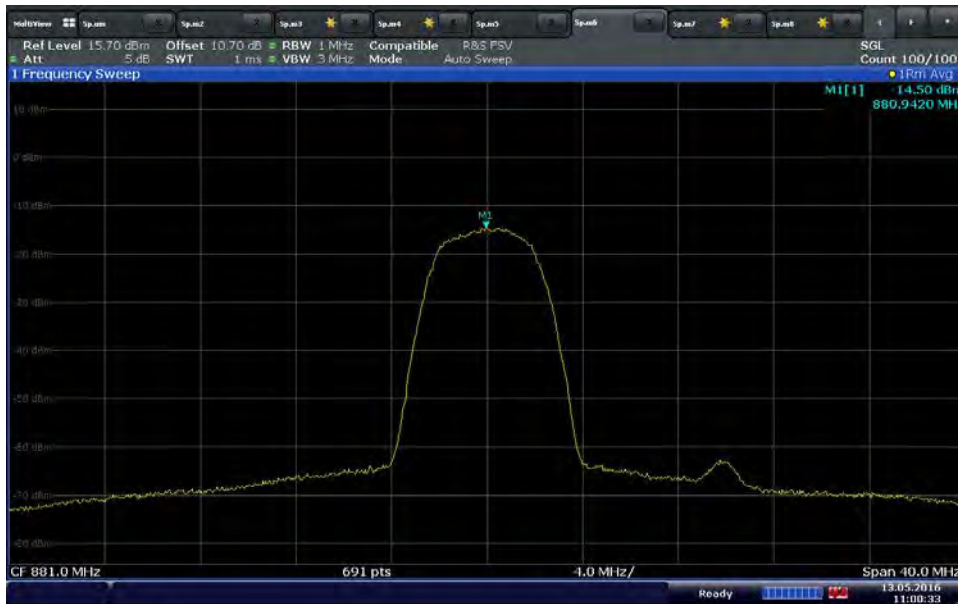

Date: 13 MAY 2016 11:00:33



**WCDMA Band 5 Downlink Authorized Frequency Range (869 – 894 MHz)
(MCC/MNC: 310/070)**



Date: 13.MAY 2016 11:21:56

**WCDMA Band 5 Downlink Authorized Frequency Range (869 – 894 MHz)
(MCC/MNC: 310/120)**



Date: 13.MAY 2016 11:21:33



**WCDMA Band 5 Uplink Authorized Frequency Range (824 – 849 MHz)
(MCC/MNC: 310/410)**



Date: 13 MAY 2016 11:12:32

**WCDMA Band 5 Uplink Authorized Frequency Range (824 – 849 MHz)
(MCC/MNC: 310/070)**



Date: 13 MAY 2016 11:18:39



WCDMA Band 5 Uplink Authorized Frequency Range (824 – 849 MHz)
(MCC/MNC: 310/120)



LTE Band 12 Downlink Authorized Frequency Range (729 – 746 MHz)
(MCC/MNC: 310/410)





**LTE Band 12 Downlink Authorized Frequency Range (729 – 746 MHz)
(MCC/MNC: 310/070)**



**LTE Band 12 Downlink Authorized Frequency Range (729 – 746 MHz)
(MCC/MNC: 310/120)**





LTE Band 12 Uplink Authorized Frequency Range (699 – 716 MHz)
(MCC/MNC: 310/410)



Date: 12 MAY 2016 13:18:58

LTE Band 12 Uplink Authorized Frequency Range (699 – 716 MHz)
(MCC/MNC: 310/070)



Date: 12 MAY 2016 10:14:18



**LTE Band 12 Uplink Authorized Frequency Range (699 – 716 MHz)
 (MCC/MNC: 310/120)**



Date: 12 MAY 2016 10:13:32

**LTE Band 4 Downlink Authorized Frequency Range (2110 – 2155 MHz)
 (MCC/MNC: 310/410)**



Date: 12 MAY 2016 11:05:11



**LTE Band 4 Downlink Authorized Frequency Range (2110 – 2155 MHz)
 (MCC/MNC: 310/070)**



Date: 12 MAY 2016 10:31:01

**LTE Band 4 Downlink Authorized Frequency Range (2110 – 2155 MHz)
 (MCC/MNC: 310/120)**



Date: 12 MAY 2016 10:31:26



**LTE Band 4 Uplink Authorized Frequency Range (1710 – 1755 MHz)
 (MCC/MNC: 310/410)**

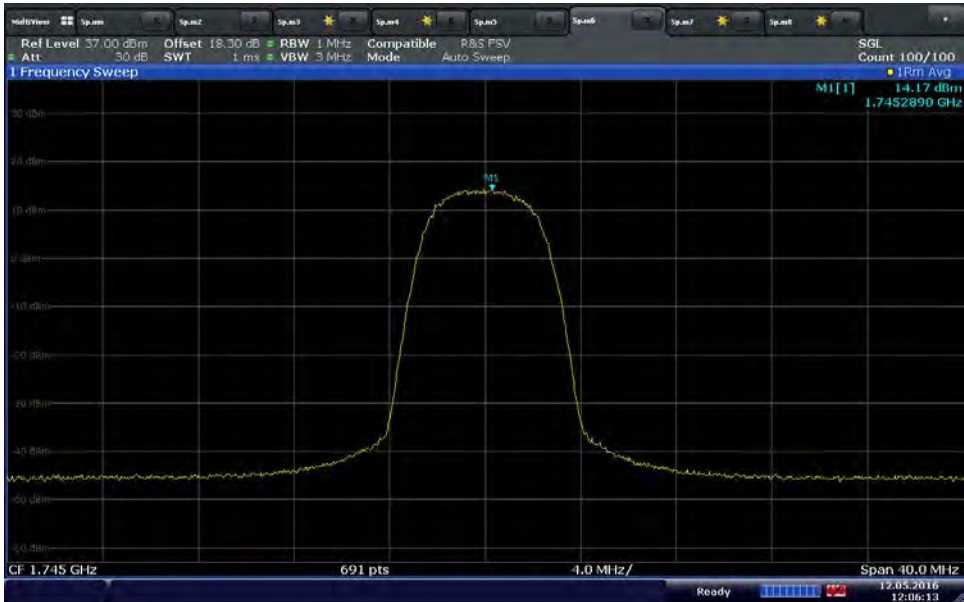

Date: 12 MAY 2016 12:06:13

**LTE Band 4 Uplink Authorized Frequency Range (1710 – 1755 MHz)
 (MCC/MNC: 310/070)**



Date: 12 MAY 2016 10:32:25



**LTE Band 4 Uplink Authorized Frequency Range (1710 – 1755 MHz)
 (MCC/MNC: 310/120)**



Date: 12.MAY.2016 10:31:58

WCDMA Band 2 Downlink Inactive time after reset (>30s)



Date: 13.MAY.2016 10:47:26



WCDMA Band 2 Uplink Inactive time after reset (>30s)



Date: 13.MAY.2016 11:29:15

LTE Band 5 Downlink Inactive time after reset (>30s)



Date: 13.MAY.2016 11:03:18



LTE Band 5 Uplink Inactive time after reset (>30s)



Date: 13 MAY 2016 11:15:54

LTE Band 12 Downlink Inactive time after reset (>30s)



Date: 12 MAY 2016 10:58:04



LTE Band 12 Uplink Inactive time after reset (>30s)



Date: 12 MAY 2016 13:21:12

LTE Band 4 Downlink Inactive time after reset (>30s)



Date: 12 MAY 2016 11:07:42



LTE Band 4 Uplink Inactive time after reset (>30s)



Date: 12.MAY 2016 12:20:34



2.3 MAXIMUM POWER MEASUREMENT AND BOOSTER GAIN COMPUTATION

2.3.1 Specification Reference

FCC 47 CFR Part 20, Clause 20.21(e)(9)(i)(D)
FCC 47 CFR Part 20, Clause 20.21(e)(9)(i)(B)
FCC 47 CFR Part 20, Clause 20.21(e)(9)(i)(C)(1) and (2)
KDB935210 D04, Clause 7.2
KDB935210 D04, Clause 7.3

2.3.2 Standard Applicable

FCC 47 CFR Part 20, Clause 20.21(e)(9)(i)(B) Bidirectional Capability:
Consumer Boosters must be able to provide equivalent (within 9dB as per ANSI ASC C63) uplink and downlink gain and conducted uplink power output that is at least 0.05 watts. One-way consumer boosters (i.e., uplink only, downlink only, uplink impaired, downlink impaired) are prohibited. Spectrum block filtering used must provide uplink filter attenuation not less than the downlink filter attenuation, and where RSSI is measured after spectrum block filtering is applied referenced to the booster's input port for each band of operation.

FCC 47 CFR Part 20, Clause 20.21(e)(9)(i)(D) Power Limits:
A booster's uplink power must not exceed 1 watt composite conducted power and equivalent isotropic radiated power (EIRP) for each band of operation. Downlink power shall not exceed 0.05 watt (17dBm) composite and 10 dBm per channel conducted and EIRP for each band of operation. Compliance with power limits will use instrumentation calibrated in terms of RMS equivalent voltage.

FCC 47 CFR Part 20, Clause 20.21(e)(9)(i)(C) Booster Gain Limits.
The gain of the frequency selective consumer booster shall meet the limits below.
(1) The uplink and downlink gain in dB of a frequency selective consumer booster referenced to its input and output ports shall not exceed BSCL - 28 dB - (40 dB - MSCL).
(2) The uplink and downlink maximum gain of a frequency selective consumer booster referenced to its input and output ports shall not exceed 19.5 dB + 20 Log (Frequency), or 100 dB for systems having automatic gain adjustment based on isolation measurements between booster donor and server antennas.
Where, Frequency is the uplink midband frequency of the supported spectrum bands in MHz.

2.3.3 Equipment Under Test and Modification State

Serial No: 25860200035 (NU) and 25955100346 (CU)/ Test Configuration A and B

2.3.4 Date of Test/Initial of test personnel who performed the test

April 25 and 26, 2016/XYZ

2.3.5 Test Equipment Used

The major items of test equipment used for the above tests are identified in Section 3.1.



2.3.6 Environmental Conditions

Test performed at TÜV SÜD America Inc. Rancho Bernardo facility.

Ambient Temperature	26.5 - 27.2°C
Relative Humidity	31.8 - 32.7%
ATM Pressure	99.0 - 99.1kPa

2.3.7 Additional Observations

- 1) This is conducted Test. Test procedure is per Section 7.2.2 of KDB935210 (D04 Provider Specific Booster Measurements v01r01). Appropriate offset (line losses) applied.
- 2) The EUT operated in Test Mode, with the gain manually set to the maximum gain and a minimum bandwidth setting (5MHz).
- 3) Setup the EUT according to Figure 2 or 3 of Section 6.3.3 of KDB935210 (D04 Provider Specific Booster Measurements v01r01) as appropriate.
- 4) Evaluations are conducted at CU antenna ports B2/B12 and B5/B4, and NU antenna ports B2/B12 and B5/B4.
- 5) Maximum Gain of the booster was calculated.
- 6) The Gain with Maximum Transmitter Input Level (-20dBm for Downlink and 0dBm for Uplink) injected was also calculated.
- 7) Operational uplink and downlink bands for WCDMA Band 2, 5, and LTE Band 12 and 4 were tested.
- 8) The signal generator was set to transmit a 5MHz LTE or WCDMA signal.

2.3.8 Test Results

Maximum Gain/Maximum Power										
Band	Frequency Range (MHz)	Input Power (dBm)	Output Power (dBm)	Antenna Gain (dB)	EIRP (dBm)	EIRP Limit (dBm)	Gain (dB)	Gain Limit (dB)	UL vs DL Gain	UL vs DL Gain Limit (dB)
WCDMA Band 2 Downlink	1930 - 1990	-77.7	9.19	2	11.19	<17	86.89	100	4.91	9
WCDMA Band 2 Uplink	1850 - 1910	-71.8	19.38	2	21.38	17-30	91.18	100		
WCDMA Band 5 Downlink	869 - 894	-85.1	10.02	0	10.02	<17	95.12	100	0.06	9
WCDMA Band 5 Uplink	824 - 849	-77.8	17.38	0	17.38	17-30	95.18	100		
LTE Band 12 Downlink	729 - 746	-85.8	10.55	0	10.55	<17	96.35	100	5.74	9
LTE Band 12 Uplink	699 - 716	-71.2	19.41	0	19.41	17-30	90.61	100		
LTE Band 4 Downlink	2110 - 2200	-85.7	9.47	2	11.47	<17	95.17	100	0.77	9
LTE Band 4 Uplink	1710 - 1755	-74.5	19.99	2	21.99	17-30	94.4	100		



Maximum Gain/Maximum Power with Maximum Transmitter Input Level								
Band	Frequency Range (MHz)	Input Power (dBm)	Output Power (dBm)	Antenna Gain (dB)	EIRP (dBm)	EIRP Limit (dBm)	Gain (dB)	Gain Limit (dB)
WCDMA Band 2 Downlink	1930 - 1990	-20	9.25	2	11.25	<17	29.25	100
WCDMA Band 2 Uplink	1850 - 1910	0	17.98	2	19.98	17-30	19.98	100
WCDMA Band 5 Downlink	869 - 894	-20	9.96	0	9.96	<17	29.96	100
WCDMA Band 5 Uplink	824 - 849	0	17.27	0	17.27	17-30	17.27	100
LTE Band 12 Downlink	729 - 746	-20	10.35	0	10.35	<17	30.35	100
LTE Band 12 Uplink	699 - 716	0	21.74	0	21.74	17-30	21.74	100
LTE Band 4 Downlink	2110 - 2200	-20	9.56	2	11.56	<17	29.56	100
LTE Band 4 Uplink	1710 - 1755	0	19.97	2	21.97	17-30	21.97	100



2.4 INTERMODULATION PRODUCT

2.4.1 Specification Reference

FCC 47 CFR Part 20. Clause 20.21(e)(9)(i)(G)
KDB935210 D04, Clause 7.4

2.4.2 Standard Applicable

FCC 47 CFR Part 20. Clause 20.21(e)(9)(i)(G) Intermodulation Limits:
The transmitted intermodulation products of a consumer booster at its uplink and downlink ports shall not exceed the power level of -19 dBm for the supported bands of operation. Compliance with intermodulation limits will use boosters operating at maximum gain and maximum rated output power, with two continuous wave (CW) input signals spaced 600 kHz apart and centered in the pass band of the booster, and with a 3 kHz measurement bandwidth.

2.4.3 Equipment Under Test and Modification State

Serial No: 25860200035 (NU) and 25955100346 (CU) / Test Configuration E

2.4.4 Date of Test/Initial of test personnel who performed the test

April 21 and 26, 2016/XYZ

2.4.5 Test Equipment Used

The major items of test equipment used for the above tests are identified in Section 3.1.

2.4.6 Environmental Conditions

Test performed at TÜV SÜD America Inc. Rancho Bernardo facility.

Ambient Temperature	26.5 - 28.6°C
Relative Humidity	23.0 - 31.8%
ATM Pressure	98.8 - 99.1kPa



2.4.7 Additional Observations

- 1) This is conducted Test. Test procedure is per Section 7.4 of KDB935210 (D04 Provider Specific Booster Measurements v01r01). Appropriate offset (line losses) applied.
- 2) The EUT operated in Test Mode with the gain manually set to the maximum gain and a minimum bandwidth setting (5MHz).
- 3) Setup the EUT according to Figure 4 of Section 7.4 of KDB935210 (D04 Provider Specific Booster Measurements v01r01).
- 4) Evaluations are conducted at CU antenna ports B2/B12 and B5/B4, and NU antenna ports B2/B12 and B5/B4.
- 5) Operational uplink and downlink bands for WCDMA Band 2, 5, and LTE Band 12 and 4 were tested.

2.4.8 Test Results

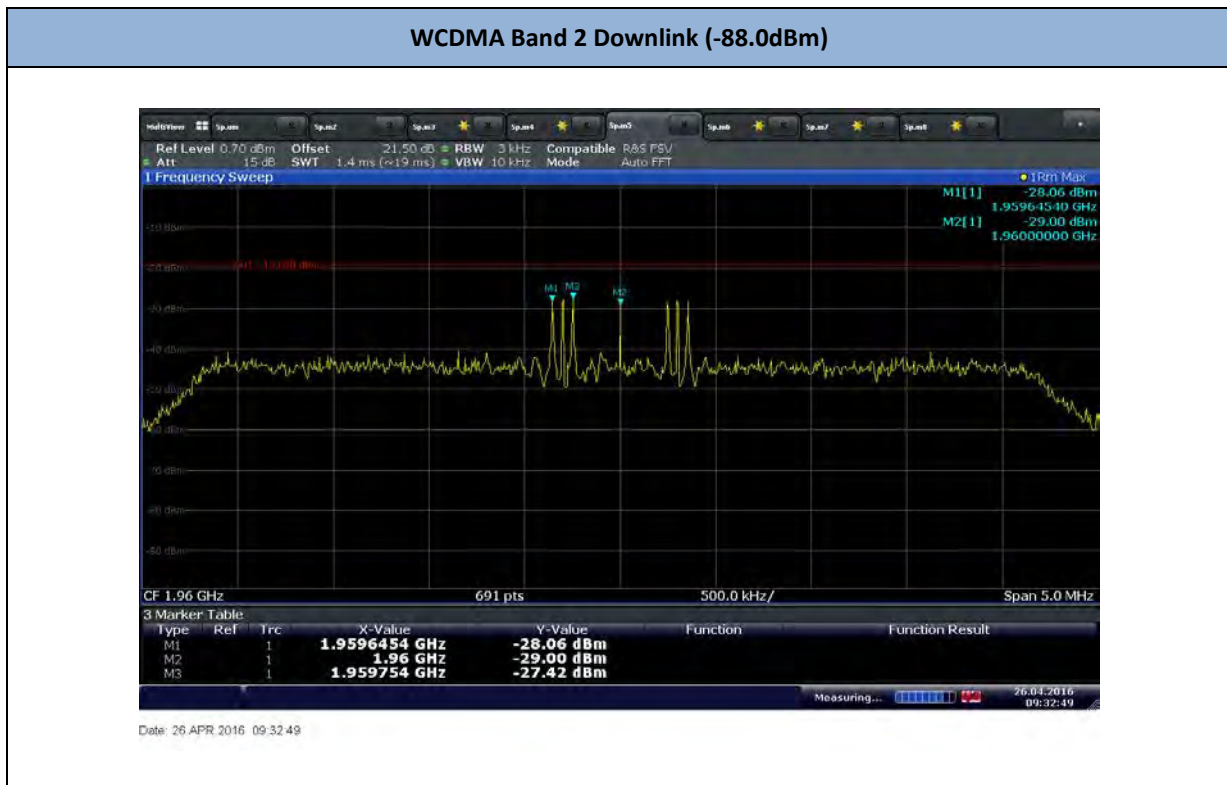



WCDMA Band 2 Downlink (-78.0dBm)



Date: 26 APR 2016 09:35:05

WCDMA Band 2 Uplink (-84.0dBm)



Date: 21 APR 2016 14:55:01



WCDMA Band 2 Uplink (-74.0dBm)



Date: 21.APR.2016 15:04:20

WCDMA Band 5 Downlink (-91.5dBm)



Date: 26.APR.2016 09:43:53



WCDMA Band 5 Downlink (-81.5dBm)



Date: 26 APR 2016 09:53:39

WCDMA Band 5 Uplink (-79.7dBm)



Date: 21 APR 2016 13:39:00

WCDMA Band 5 Uplink (-69.7dBm)

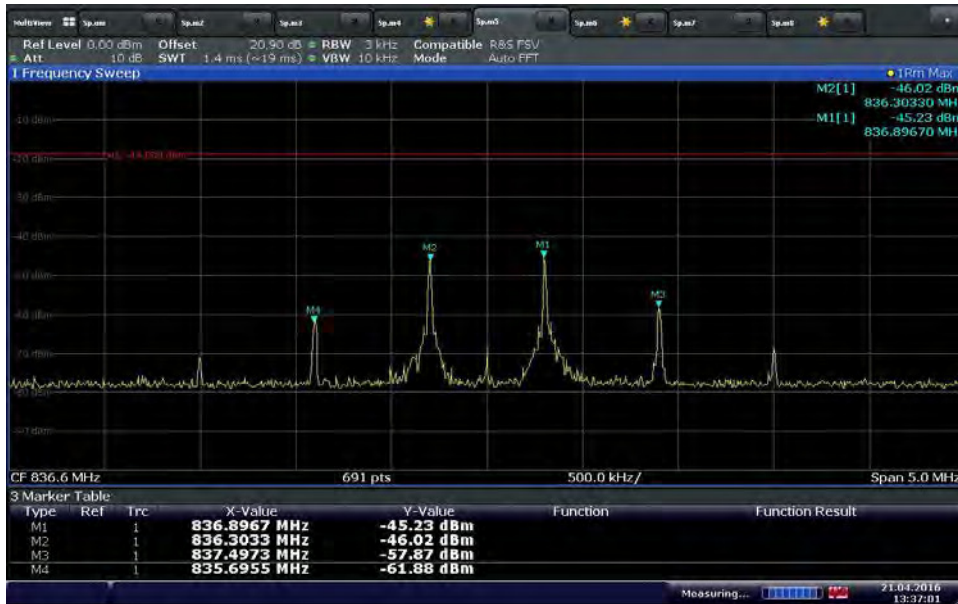

Date: 21.APR.2016 13:37:01

LTE Band 12 Downlink (-86.0dBm)

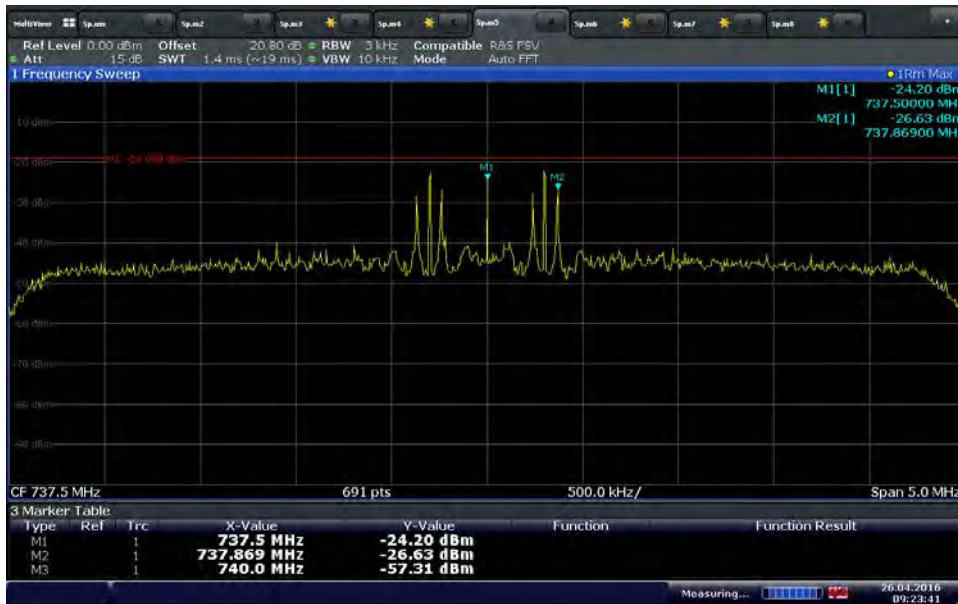

Date: 26.APR.2016 09:23:41



LTE Band 12 Downlink (-76.0dBm)



Date: 26 APR 2016 09:27:32

LTE Band 12 Uplink (-85.8dBm)



Date: 21 APR 2016 14:42:41



LTE Band 12 Uplink (-75.8dBm)



Date: 21.APR.2016 14:44:27

LTE Band 4 Downlink (-85.3 dBm)

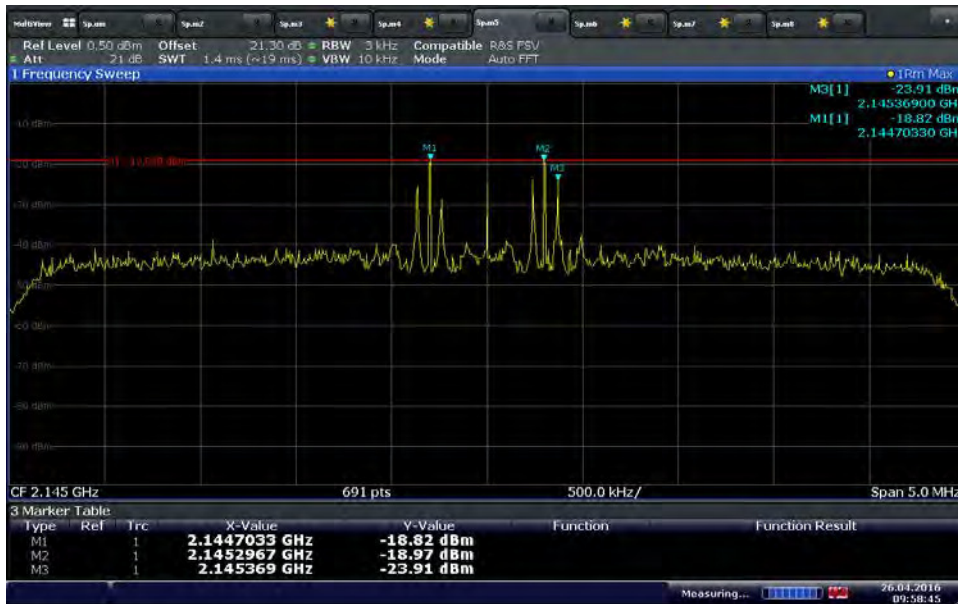

Date: 26.APR.2016 09:58:45

LTE Band 4 Downlink (-75.3 dBm)



Date: 26 APR 2016 10:00:59

LTE Band 4 Uplink (-73.5 dBm)



Date: 21 APR 2016 14:22:08

Note: M1 and M2 are the interfere CW signals



LTE Band 4 Uplink (-63.5 dBm)



Date: 21.APR.2016 14:23:49



2.5 OUT OF BAND EMISSIONS

2.5.1 Specification Reference

FCC 47 CFR Part 20. Clause 20.21(e)(9)(i)(F)
KDB935210 D04, Clause 7.5

2.5.2 Standard Applicable

FCC 47 CFR Part 20. Clause 20.21(e)(9)(i)(F) Out of Band Emissions Limits:
Booster out of band emissions (OOBE) shall meet the FCC's mobile emission limits for the supported bands of operation. Compliance to OOBE limits will utilize high peak-to-average CMRS signal types..

2.5.3 Equipment Under Test and Modification State

Serial No: 25860200035 (NU) and 25955100346 (CU) / Test Configuration A

2.5.4 Date of Test/Initial of test personnel who performed the test

April 20 and 21, 2016/XYZ

2.5.5 Test Equipment Used

The major items of test equipment used for the above tests are identified in Section 3.1.

2.5.6 Environmental Conditions

Test performed at TÜV SÜD America Inc. Rancho Bernardo facility.

Ambient Temperature	28.6 - 28.8°C
Relative Humidity	21.6 - 23.0%
ATM Pressure	98.8 - 98.9kPa

2.5.7 Additional Observations

- 1) This is conducted Test. Test procedure is per Section 7.5 of KDB935210 (D04 Provider Specific Booster Measurements v01r01). Appropriate offset (line losses) applied.
- 2) The EUT operated in Test Mode, with the gain manually set to the maximum gain and a minimum bandwidth setting (5MHz).
- 3) Evaluations are conducted at CU antenna ports B2/B12 and B5/B4, and NU antenna ports B2/B12 and B5/B4.
- 4) Operational uplink and downlink bands for WCDMA Band 2, 5, and LTE Band 12 and 4 were tested.
- 5) Signal: 5MHz LTE or WCDMA.



2.5.8 Test Results

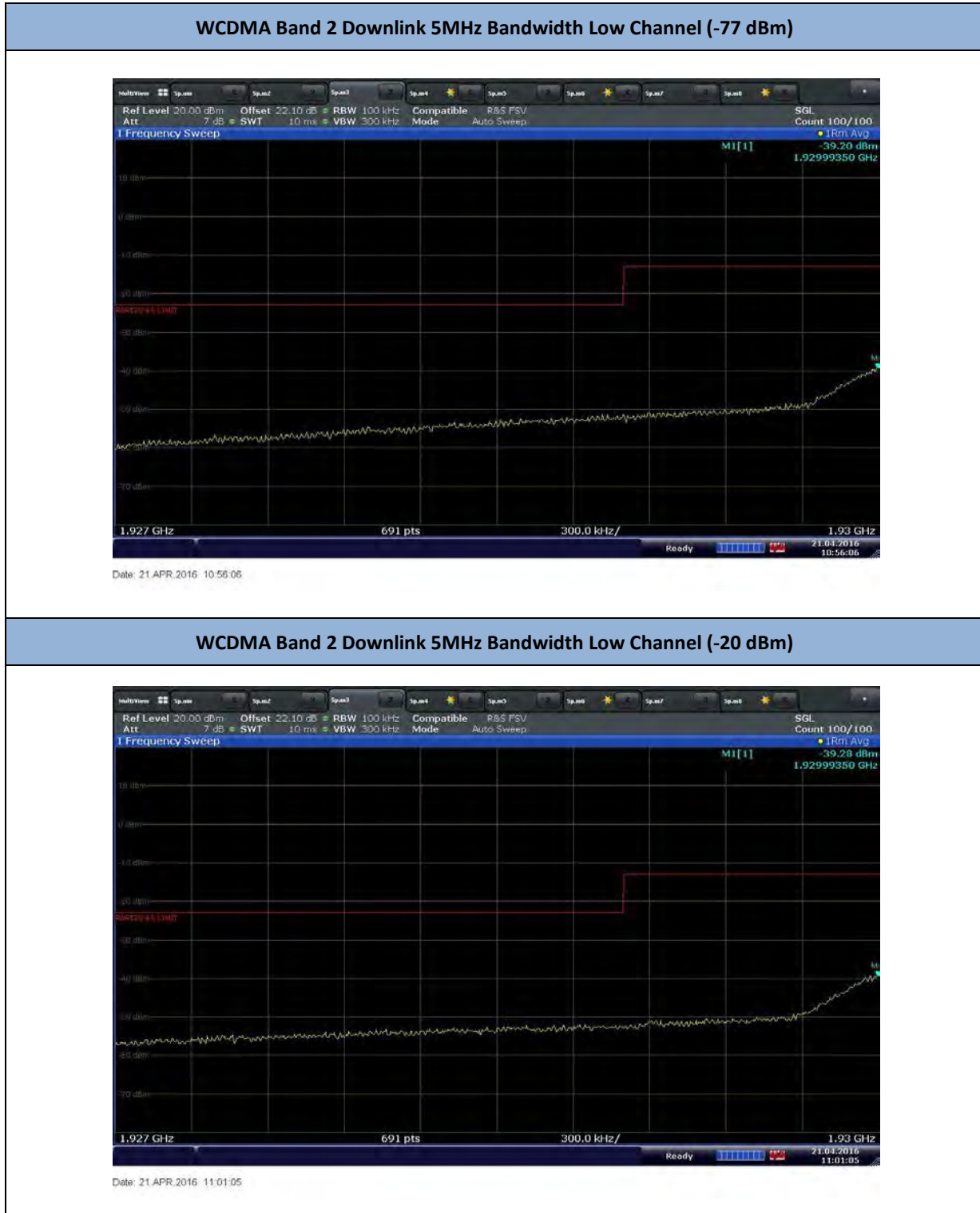



WCDMA Band 2 Downlink 5MHz Bandwidth High Channel (-77 dBm)



Date: 21 APR 2016 11:05:10

WCDMA Band 2 Downlink 5MHz Bandwidth High Channel (-20 dBm)



Date: 21 APR 2016 11:04:25



WCDMA Band 5 Downlink 5MHz Bandwidth Low Channel (-79.7 dBm)

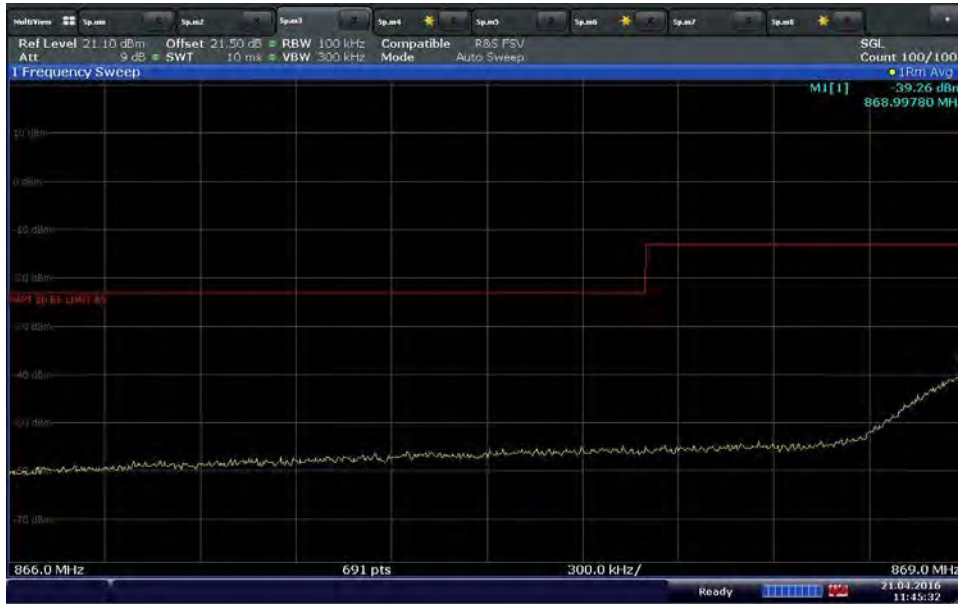

Date: 21 APR.2016 11:45:32

WCDMA Band 5 Downlink 5MHz Bandwidth Low Channel (-20 dBm)

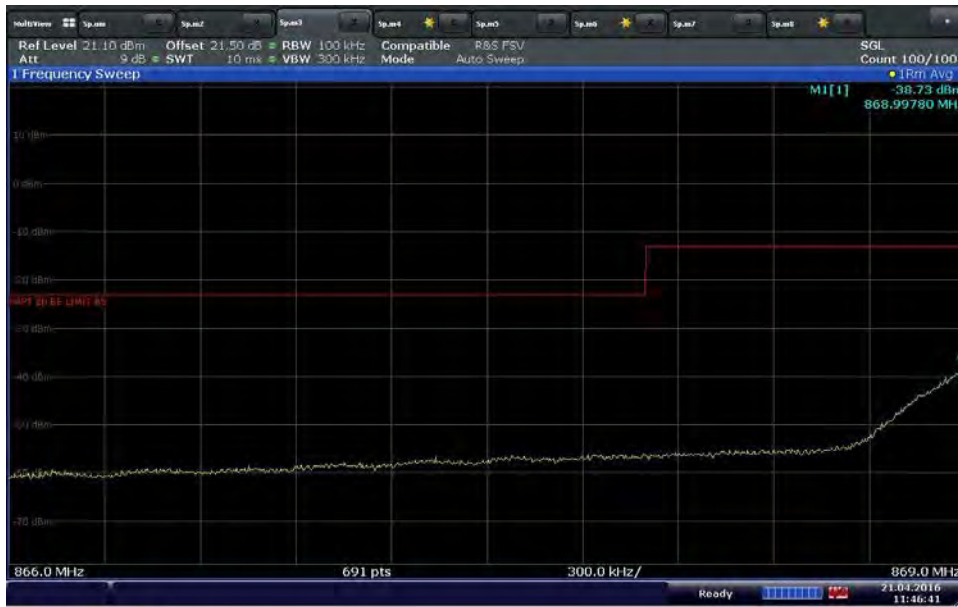

Date: 21 APR.2016 11:46:40



WCDMA Band 5 Downlink 5MHz Bandwidth High Channel (-79.7 dBm)

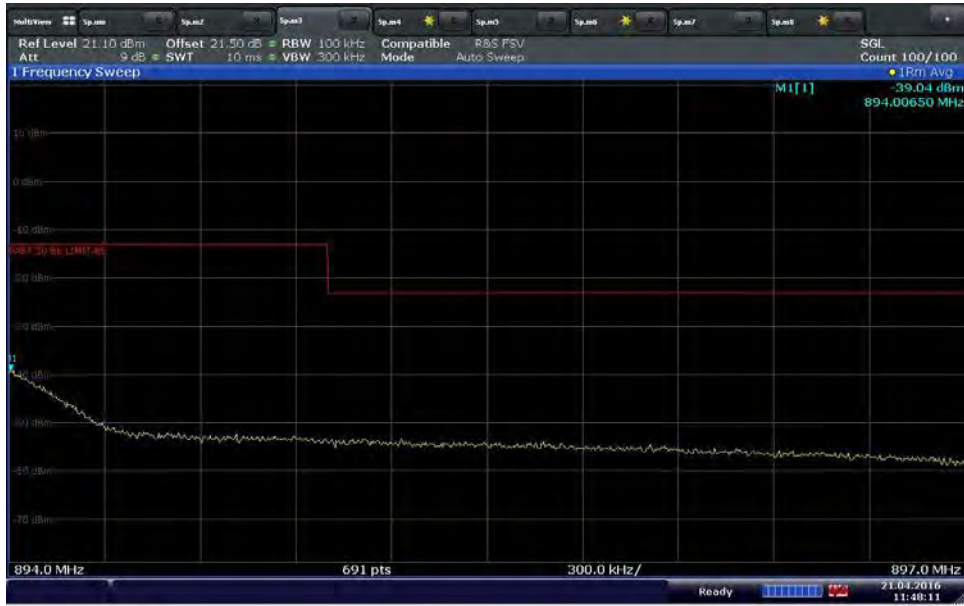

Date: 21 APR.2016 11:48:11

WCDMA Band 5 Downlink 5MHz Bandwidth High Channel (-20 dBm)

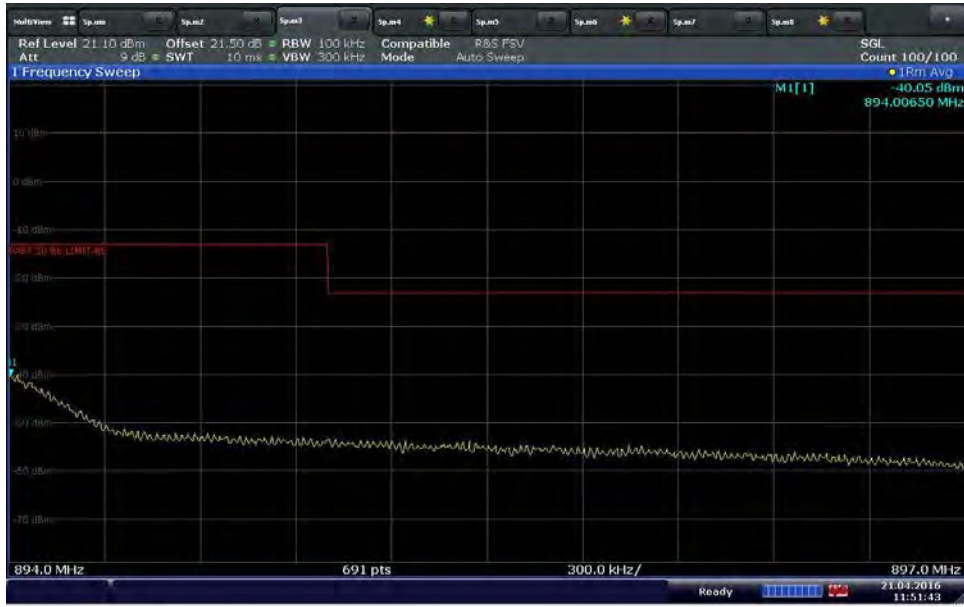

Date: 21 APR.2016 11:51:44



LTE Band 12 Downlink 5MHz Bandwidth Low Channel (-80.2 dBm)



LTE Band 12 Downlink 5MHz Bandwidth Low Channel (-20 dBm)





LTE Band 12 Downlink 5MHz Bandwidth High Channel (-80.2 dBm)

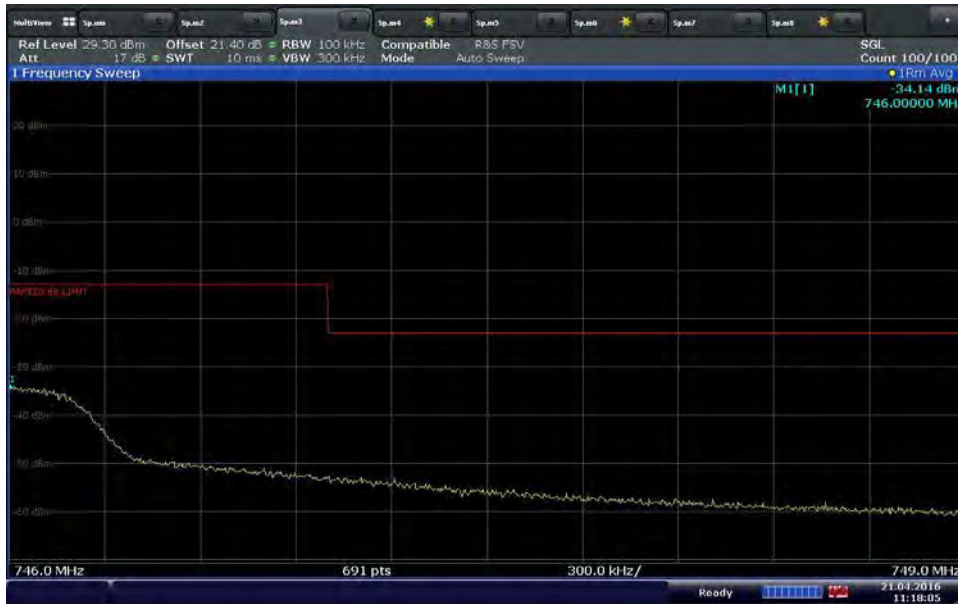

Date: 21.APR.2016 11:18:05

LTE Band 12 Downlink 5MHz Bandwidth High Channel (-20 dBm)



Date: 21.APR.2016 11:18:50



LTE Band 4 Downlink 5MHz Bandwidth Low Channel (-73.8 dBm)

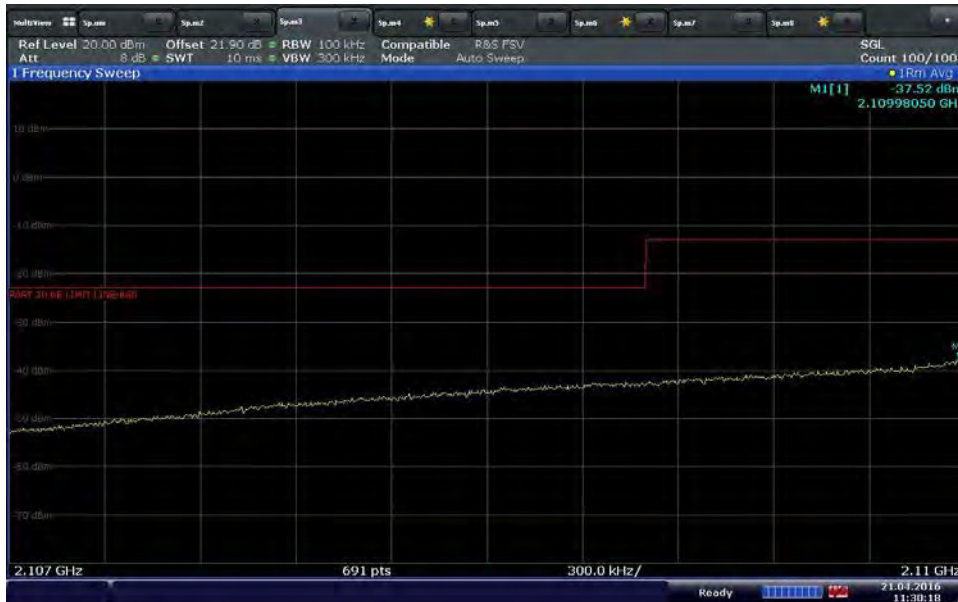

LTE Band 4 Downlink 5MHz Bandwidth Low Channel (-20 dBm)

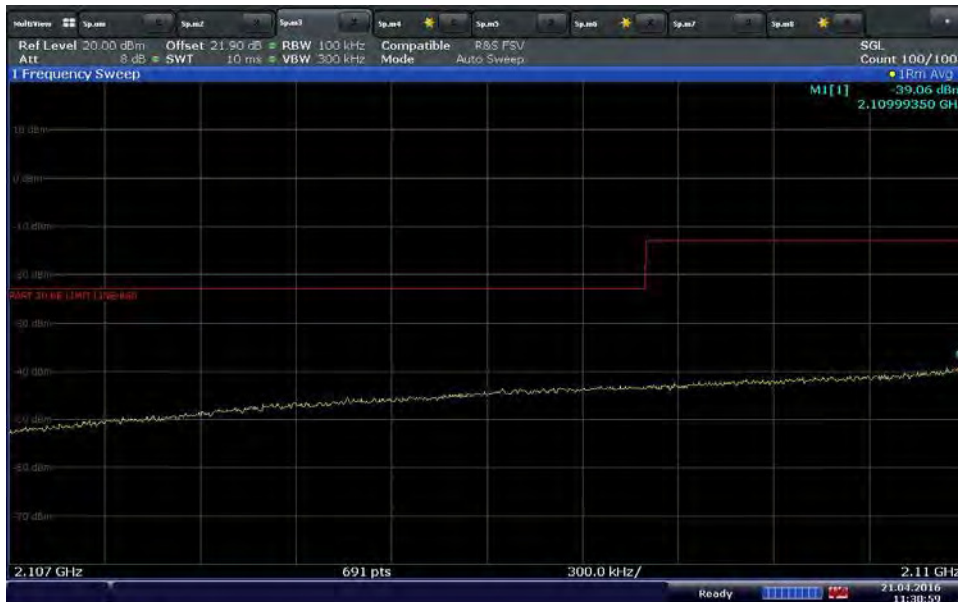



LTE Band 4 Downlink 5MHz Bandwidth High Channel (-73.8 dBm)

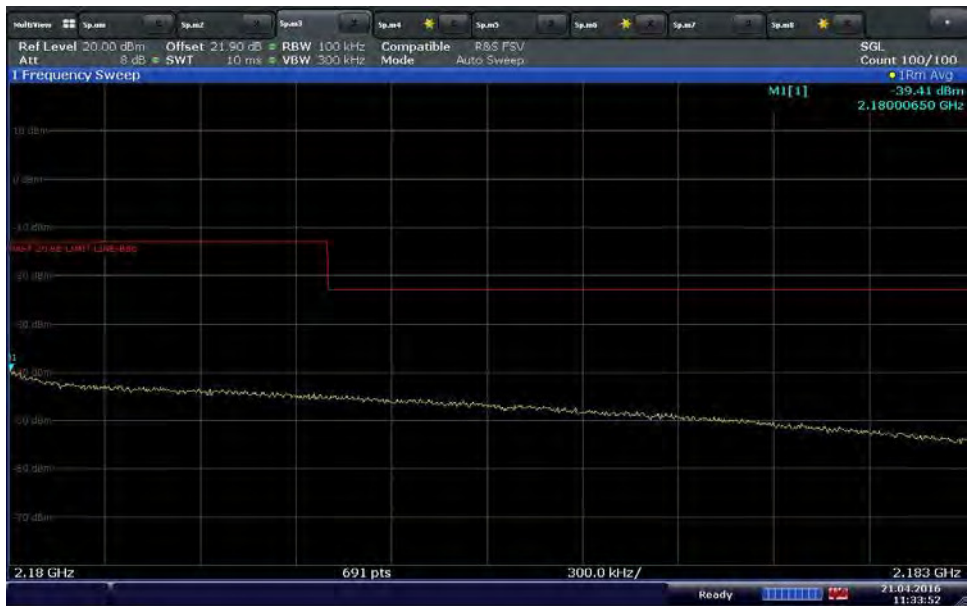

Date: 21 APR 2016 11:33:52

LTE Band 4 Downlink 5MHz Bandwidth High Channel (-20 dBm)



Date: 21 APR 2016 11:32:39



WCDMA Band 2 Uplink 5MHz Bandwidth Low Channel (-78 dBm)



Date: 20 APR.2016 15:56:40

WCDMA Band 2 Uplink 5MHz Bandwidth Low Channel (0 dBm)

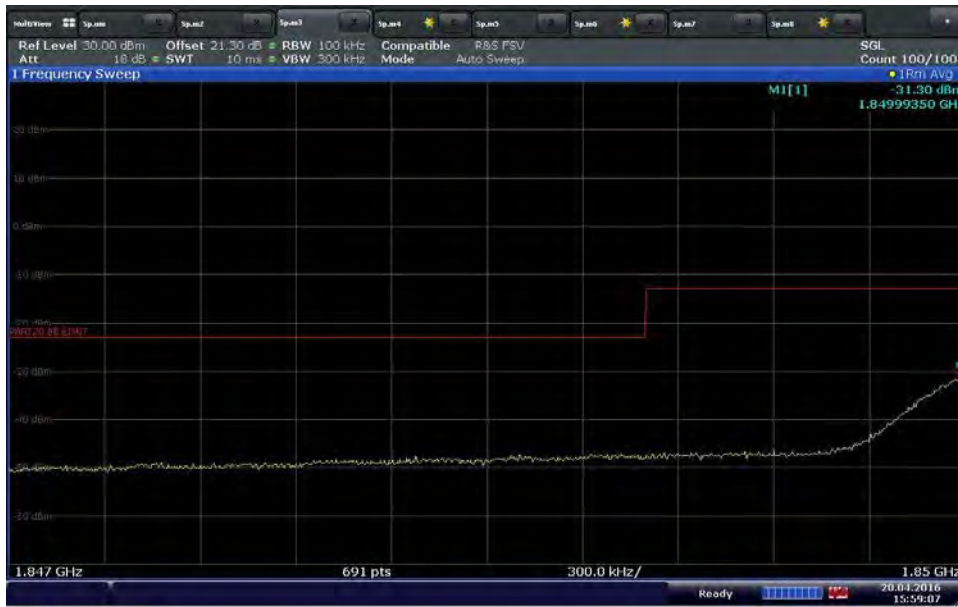

Date: 20 APR.2016 15:59:06



WCDMA Band 2 Uplink 5MHz Bandwidth High Channel (-78 dBm)



Date: 20 APR 2016 15:50:58

WCDMA Band 2 Uplink 5MHz Bandwidth High Channel (0 dBm)



Date: 20 APR 2016 15:53:21



WCDMA Band 5 Uplink 5MHz Bandwidth Low Channel (-78 dBm)



WCDMA Band 5 Uplink 5MHz Bandwidth Low Channel (0 dBm)

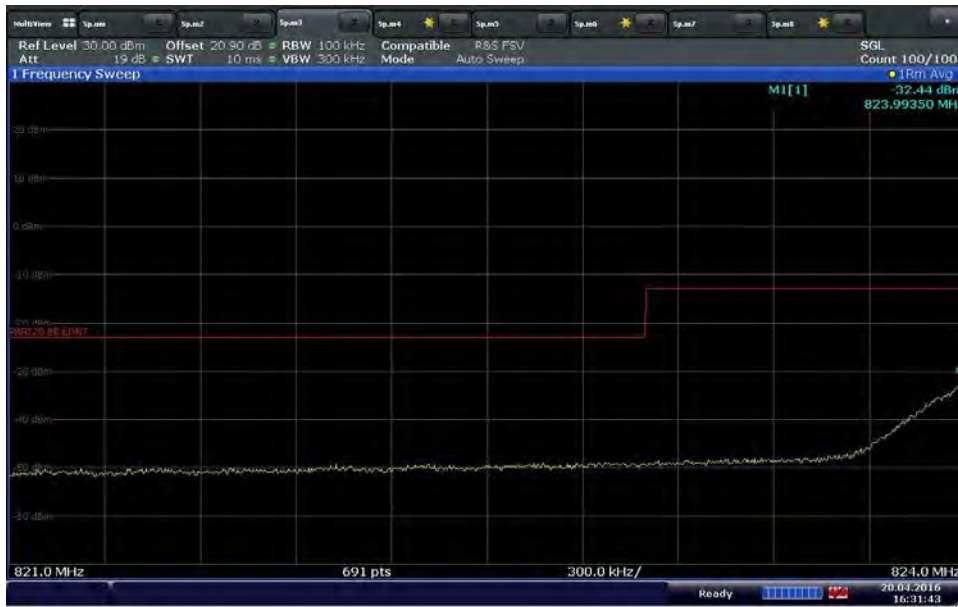



WCDMA Band 5 Uplink 5MHz Bandwidth High Channel (-78 dBm)



Date: 20 APR.2016 16:37:31

WCDMA Band 5 Uplink 5MHz Bandwidth High Channel (0 dBm)



Date: 20 APR.2016 16:38:09



LTE Band 12 Uplink 5MHz Bandwidth Low Channel (-75.2 dBm)



Date: 20 APR.2016 16:12:11

LTE Band 12 Uplink 5MHz Bandwidth Low Channel (0 dBm)



Date: 20 APR.2016 16:13:15



LTE Band 12 Uplink 5MHz Bandwidth High Channel (-75.2 dBm)



Date: 20 APR.2016 16:16:19

LTE Band 12 Uplink 5MHz Bandwidth High Channel (0 dBm)



Date: 20 APR.2016 16:15:32



LTE Band 4 Uplink 5MHz Bandwidth Low Channel (-75.2 dBm)

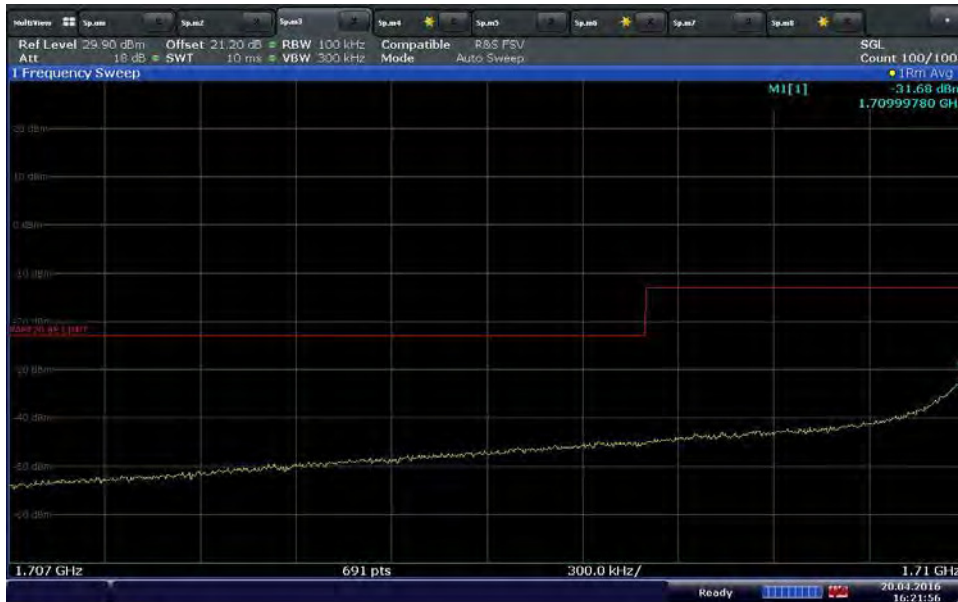

LTE Band 4 Uplink 5MHz Bandwidth Low Channel (0 dBm)





LTE Band 4 Uplink 5MHz Bandwidth High Channel (-75.2 dBm)

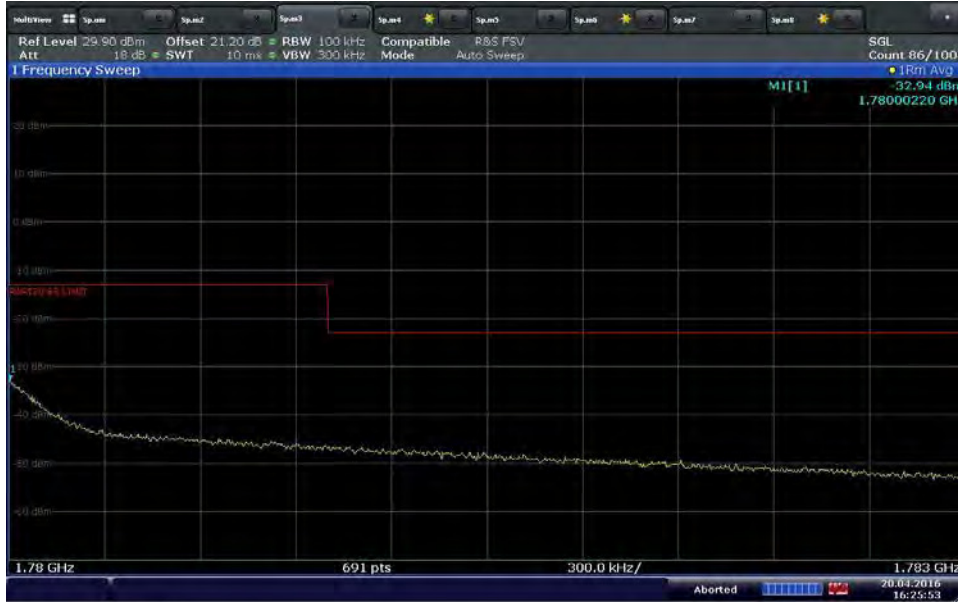

Date: 20 APR.2016 16:25:53

LTE Band 4 Uplink 5MHz Bandwidth High Channel (0 dBm)



Date: 20 APR.2016 16:25:09



2.6 NOISE LIMIT

2.6.1 Specification Reference

FCC 47 CFR Part 20. Clause 20.21(e)(9)(i)(A)
FCC 47 CFR Part 20. Clause 20.21(e)(9)(i)(I)
KDB935210 D04, Clause 7.7

2.6.2 Standard Applicable

FCC 47 CFR Part 20. Clause 20.21(e)(9)(i)(A) Noise Limits.:

The transmitted noise power in dBm/MHz of frequency selective consumer boosters outside the licensee's spectrum blocks at their uplink and downlink ports shall not exceed the following limits:

(1) -103 dBm/MHz - RSSI

(i) Where RSSI is the downlink composite signal power received in dBm for frequencies in the band of operation outside the licensee's spectrum block as measured after spectrum block filtering is applied and is referenced to the booster's donor port for each band of operation. RSSI is expressed in negative dB units relative to 1 mW.

(ii) Boosters with MSCL less than 40 dB, shall reduce the Noise output in (A) by 40 dB - MSCL, where MSCL is the minimum coupling loss in dB between the wireless device and booster's server port. MSCL must be calculated or measured for each band of operation and provided in compliance test reports.

(2)(i) Maximum downlink noise power shall not exceed $-102.5 \text{ dBm/MHz} + 20 \text{ Log}_{10}(\text{Frequency})$, where Frequency is the uplink mid-band frequency of the supported spectrum bands in MHz.

(ii) Compliance with Noise limits will use instrumentation calibrated in terms of RMS equivalent voltage, and with booster input ports terminated or without input signals applied within the band of measurement.

FCC 47 CFR Part 20. Clause 20.21(e)(9)(i)(I) Transmit Power Off Mode.

When the consumer booster cannot otherwise meet the noise and gain limits defined herein it must operate in "Transmit Power OFF Mode." In this mode of operation, the uplink and downlink noise power shall not exceed -70 dBm/MHz and uplink gain shall not exceed the lesser of 23 dB or MSCL.

2.6.3 Equipment Under Test and Modification State

Serial No: 25860200035 (NU) and 25955100346 (CU) / Test Configuration E, F and G

2.6.4 Date of Test/Initial of test personnel who performed the test

April 27 and May 16, 2016/XYZ

2.6.5 Test Equipment Used

The major items of test equipment used for the above tests are identified in Section 3.1.



2.6.6 Environmental Conditions/ Test Location

Test performed at TÜV SÜD America Inc. Rancho Bernardo facility

Ambient Temperature 26.6°C
 Relative Humidity 34.1%
 ATM Pressure 98.8kPa

2.6.7 Additional Observations

- 1) This is conducted Test. Test procedure is per Section 7.7 of KDB935210 (D04 Provider Specific Booster Measurements v01r01). Appropriate offset (line losses) applied.
- 2) The EUT operated in Test Mode with the gain manually set to the maximum gain and a minimum bandwidth setting (5MHz).
- 3) For Maximum Noise (frequency Dependent) testing, setup the EUT according to Figure 5 of Section 7.7 of KDB935210 (D04 Provider Specific Booster Measurements v01r01).
- 4) Maximum Noise (frequency Dependent) evaluations are conducted at CU antenna ports B2/B12 and B5/B4. Operational downlink bands for WCDMA Band 2, 5, and LTE Band 12 and 4 were tested.
- 5) For Maximum Noise (RSSI Dependent and Transmit Power off mode) and Noise Response Time tests, setup the EUT according to Figure 5 of Figure 6 or 7 of Section 7.7 of KDB935210 (D04 Provider Specific Booster Measurements v01r01) as appropriate.
- 6) Maximum Noise (RSSI Dependent and Transmit Power off mode) and Noise Response Time evaluations are conducted at CU antenna ports B2/B12 and B5/B4, and NU antenna ports B2/B12 and B5/B4. Operational uplink and downlink bands for WCDMA Band 2, 5, and LTE Band 12 and 4 were tested.
- 7) Signal generator was configured to transmit: 200 kHz AWGN.

2.6.8 Test Results

Maximum Noise (Frequency Dependent)				
Band	Frequency Range (MHz)	Max Noise (dBm/MHz)	Limit* (dBm/MHz)	Margin (dB)
WCDMA Band 2 Downlink	1930 - 1990	-66.86	-36.65	30.21
WCDMA Band 5 Downlink	869 - 894	-67.92	-43.59	24.33
LTE Band 12 Downlink	729 - 746	-65.13	-45.14	19.99
LTE Band 4 Downlink	2110 - 2155	-71.77	-35.87	35.9

*: $-102.5 \text{ dBm/MHz} + 20 \text{ Log}_{10}(\text{Frequency})$, where Frequency is the uplink mid-band frequency of the supported spectrum bands in MHz. (Downlink only)



Maximum Noise (RSSI Dependent and Transmit Power off mode)					
Band	Frequency (MHz)	Signal Generator Output Level (dBm)	Max Noise (dBm/MHz)	Limit (dBm/MHz)	Margin (dB)
WCDMA Band 2 Downlink	1930 - 1990	-77.9	-70.42	-30.1	40.32
		-67.9	-70.64	-40.1	30.54
		-47.9	-70.45	-60.1	10.35
		-35.9	-70.65	-70	0.65
		-32.9**	-71.93	-70	1.93
		-30.9	-71.76	-70	1.76
WCDMA Band 2 Uplink	1850 - 1910	-87.9	-67.79	-20.1	47.69
		-77.9	-67.7	-30.1	37.6
		-57.9	-68.49	-50.1	18.39
		-37.9**	-77.38	-70	7.38
		-32.9	-76.83	-70	6.83
		-30.9	-77.27	-70	7.27
WCDMA Band 5 Downlink	869 - 894	-50.7	-70.28	-57.3	12.98
		-40.7	-70.37	-67.3	3.07
		-30.7**	-71.24	-70	1.24
		-25.7	-71.34	-70	1.34
		-23.7	-71.97	-70	1.97
		-20.7	-71.83	-70	1.83
WCDMA Band 5 Uplink	824 - 849	-87	-69.72	-21	48.72
		-77	-69.55	-31	38.55
		-67	-71.12	-41	30.12
		-37**	-79.59	-70	9.59
		-35	-80.32	-70	10.32
		-27	-80.12	-70	10.12
LTE Band 12 Downlink	729 - 746	-70.4	-63.8	-37.6	26.2
		-60.4	-63.93	-47.6	16.33
		-50.4	-64.14	-57.6	6.54
		-47.4**	-73.67	-60.6	13.07
		-45.4	-73.34	-62.6	10.74
		-30.4	-73.48	-70	3.48
LTE Band 12 Uplink	699 - 716	-86.7	-71.71	-21.3	50.41
		-76.7	-71.19	-31.3	39.89
		-46.7	-84.49	-61.3	23.19
		-36.7**	-84.5	-70	14.5
		-31.7	-84.58	-70	14.58
		-29.7	-84.66	-70	14.66



LTE Band 4 Downlink	2110 – 2155	-60.6	-72.73	-47.4	25.33
		-50.6	-72.83	-47.4	25.43
		-42.6**	-72.67	-65.4	7.27
		-30.6	-72.79	-70	2.79
		-23.6	-72.97	-70	2.97
		-20.6	-72.63	-70	2.63
LTE Band 4 Uplink	1710 - 1755	-60.4	-69.0	-47.6	21.4
		-59.4	-68.92	-48.6	20.32
		-57.4	-68.77	-50.6	18.17
		-47.4**	-76.7	-60.6	16.1
		-37.4	-77.81	-70	7.81
		-30.4	-78.58	-70	8.58

** : Transmit Power off mode

Noise Response Time				
Band	Frequency (MHz)	Noise Response Time (Sec)	Limit (Sec)	Margin (Sec)
WCDMA Band 2 Downlink	1930 - 1990	0.9	3	2.1
WCDMA Band 2 Uplink	1850 - 1910	0.36	3	2.64
WCDMA Band 5 Downlink	869 - 894	0.19	3	2.81
WCDMA Band 5 Uplink	824 - 849	0.32	3	2.68
LTE Band 12 Downlink	729 - 746	0.38	3	2.62
LTE Band 12 Uplink	699 - 716	0.29	3	2.71
LTE Band 4 Downlink	2110 - 2155	1.58	3	1.42
LTE Band 4 Uplink	1710 - 1755	0.46	3	2.54



2.7 UPLINK INACTIVITY

2.7.1 Specification Reference

FCC 47 CFR Part 20. Clause 20.21(e)(9)(i)(J)
KDB935210 D04, Clause 7.8

2.7.2 Standard Applicable

FCC 47 CFR Part 20. Clause 20.21(e)(9)(i)(J) Uplink Inactivity:
Uplink Inactivity. When a consumer booster is not serving an active device connection after 5 seconds the uplink noise power shall not exceed -70 dBm/MHz.

2.7.3 Equipment Under Test and Modification State

Serial No: 258602000014 (NU) and 259551000131 (CU) / Test Configuration C and D

2.7.4 Date of Test/Initial of test personnel who performed the test

May 13 and June 16, 2016/XYZ

2.7.5 Test Equipment Used

The major items of test equipment used for the above tests are identified in Section 3.1.

2.7.6 Environmental Conditions

Test performed at TÜV SÜD America Inc. Rancho Bernardo facility.

Ambient Temperature	26.9 - 27.2°C
Relative Humidity	41.4 – 44.4%
ATM Pressure	99.2kPa



2.7.7 Additional Observations

- 1) This is conducted Test.
- 2) Test procedure is per Section 7.8 of KDB935210 (D04 Provider Specific Booster Measurements v01r01). Appropriate offset (line losses) applied.
- 3) The EUT operated in Normal Mode with a minimum bandwidth setting (5MHz).
- 4) Setup the EUT according to Figure 1 of Section 6.3.2 of KDB935210 (D04 Provider Specific Booster Measurements v01r01).
- 5) Evaluations are conducted at NU antenna ports B2/B12 and B5/B4.
- 6) Operational uplink bands for WCDMA Band 2, 5, and LTE Band 12 and 4 were tested.
- 7) Signal: 5MHz LTE or WCDMA.

2.7.8 Test Results

Uplink Inactivity				
Band	Frequency (MHz)	UL Inactive Time (Sec)	Limit (Sec)	Margin (Sec)
Band 2 Uplink	1880	1.78	5.0	3.22
Band 5 Uplink	836.6	2.20	5.0	2.80
Band 12 Uplink	707.5	1.78	5.0	3.22
Band 4 Uplink	1745	1.43	5.0	3.57

WCDMA Band 2 Uplink 5MHz Bandwidth Mid Channel



Date: 13.MAY.2016 11:44:26

WCDMA Band 5 Uplink 5MHz Bandwidth Mid Channel



Date: 13.MAY.2016 12:02:50



LTE Band 12 Uplink 5MHz Bandwidth Mid Channel



Date: 16 JUN 2016 16:36:01

LTE Band 4 Uplink 5MHz Bandwidth Mid Channel



Date: 16 JUN 2016 16:45:31



2.8 VARIABLE BOOSTER GAIN

2.8.1 Specification Reference

FCC 47 CFR Part 20. Clause 20.21(e)(9)(i)(C)(1)
FCC 47 CFR Part 20. Clause 20.21(e)(9)(i)(I)
KDB935210 D04, Clause 7.9

2.8.2 Standard Applicable

FCC 47 CFR Part 20. Clause 20.21(e)(9)(i)(C)(1) Booster Gain Limits:
The gain of the frequency selective consumer booster shall meet the limits below.

- 1) The uplink and downlink gain in dB of a frequency selective consumer booster referenced to its input and output ports shall not exceed BSCL - 28dB - (40 dB - MSCL).
 - (i) Where BSCL is the coupling loss between the booster's donor port and the base station's input port, and MSCL is the minimum coupling loss in dB between the wireless device and the booster's server port. MSCL must be calculated or measured for each band of operation and provided in compliance test reports.
 - (ii) In order of preference, BSCL is determined as follows: determine path loss between the base station and the booster; such measurement shall be based on measuring the received forward pilot/control channel power at the booster and reading the pilot/control channel transmit power from the base station as defined in the system information messages sent by the base station; estimate BSCL by assuming that the base station is transmitting at a level of +25 dBm per channel (assume a small, lightly loaded cell) and measuring the total received signal power level within the channel in dBm (RPCH) received at the booster input port. BSCL is then calculated as 25- RPCH; or assume that the BSCL is 70dB without performing any measurement.

FCC 47 CFR Part 20. Clause 20.21(e)(9)(i)(I) Transmit Power Off Mode.
When the consumer booster cannot otherwise meet the noise and gain limits defined herein it must operate in "Transmit Power OFF Mode." In this mode of operation, the uplink and downlink noise power shall not exceed -70 dBm/MHz and uplink gain shall not exceed the lesser of 23 dB or MSCL.

2.8.3 Equipment Under Test and Modification State

Serial No: 258602000014 (NU) and 259551000131 (CU) / Test Configuration C and D

2.8.4 Date of Test/Initial of test personnel who performed the test

May 13 and 15, 2016/XYZ

2.8.5 Test Equipment Used

The major items of test equipment used for the above tests are identified in Section 3.1.



2.8.6 Environmental Conditions

Test performed at TÜV SÜD America Inc. Rancho Bernardo facility.

Ambient Temperature	26.8 - 27.4°C
Relative Humidity	40.9 - 44.4%
ATM Pressure	99.0 - 99.2kPa

2.8.7 Additional Observations

- 1) This is conducted Test.
- 2) Test procedure is per Section 7.9 of KDB935210 (D04 Provider Specific Booster Measurements v01r01). Appropriate offset (line losses) applied.
- 3) The EUT operated in Normal Mode;
- 4) Setup the EUT according to Figure 1 of Section 6.3.2 of KDB935210 (D04 Provider Specific Booster Measurements v01r01).
- 5) Evaluations are conducted at CU antenna ports B2/B12 and B5/B4, and NU antenna ports B2/B12 and B5/B4.
- 6) Variable Gain: Operational uplink and downlink bands for WCDMA Band 2, 5, and LTE Band 12 and 4 were tested.
- 7) Uplink Gain Timing: Operational uplink bands for WCDMA Band 2, 5, and LTE Band 12 and 4 were tested.
- 8) Signal: 5MHz LTE or WCDMA.
- 9) MSCL:
 $L_p = 20\log f + 20\log d - 27.5$
 L_p = Basic free space path loss,
 f = frequency in MHz,
 d = separation distance in meters (2m)
 lowest MSCL value was utilized.
- 10) BSCL:
 The coupling loss (in dB) between the donor port (NU) of the Consumer Booster and the input port of the Base Station

2.8.8 Test Results

WCDMA B2 Downlink Gain vs RPCH and BSCL - Middle Channel					
RPCH Power (dBm)	BSCL (dB)	Measured Power (dBm)	Gain (dB)	Limit (dB)	Margin (dB)
-80.7	105.5	-8.76	71.78	74.5	2.72
-77.7	102.5	-9.39	67.74	71.5	3.36
-74.7	99.5	-9.82	64.48	68.5	4.02
-68.7	93.5	-10.19	58.31	62.5	4.19
-66.7	91.5	-11.07	55.47	60.5	5.03
-60.7	85.5	-16.49	44.35	54.5	10.15



WCDMA B5 Downlink Gain vs RPCH and BSCL - Middle Channel					
RPCH Power (dBm)	BSCL (dB)	Measured Power (dBm)	Gain (dB)	Limit (dB)	Margin (dB)
-80.5	105	-9.17	71.06	74	2.94
-70.5	95	-11.47	59.09	64	4.91
-65.5	90	-12.39	53.11	59	5.89
-60.5	85	-13.75	46.9	54	7.1
-50.5	75	-15.02	35.95	44	8.05
-40.5	65	-15.48	25.28	34	8.72

LTE B12 Downlink Gain vs RPCH and BSCL - Middle Channel					
RPCH Power (dBm)	BSCL (dB)	Measured Power (dBm)	Gain (dB)	Limit (dB)	Margin (dB)
-80.5	105	-9.3	71.2	74	2.8
-70.5	95	-10.72	59.78	64	4.22
-65.5	90	-12.8	52.7	59	6.3
-60.5	85	-13.63	46.87	54	7.13
-50.5	75	-16.8	33.7	44	10.3
-40.5	65	-26.0	14.5	34	19.5

LTE B4 Downlink Gain vs RPCH and BSCL - Middle Channel					
RPCH Power (dBm)	BSCL (dB)	Measured Power (dBm)	Gain (dB)	Limit (dB)	Margin (dB)
-85.7	114	-5.16	80.54	83	2.46
-80.7	109	-5.42	75.28	78	2.72
-70.7	99	-7.65	63.05	68	4.95
-60.7	89	-18.3	42.4	58	15.6
-50.7	79	-19.67	31.03	48	16.97
-40.7	69	-23.7	17	38	21



WCDMA B2 Uplink Gain vs RPCH and BSCL - Middle Channel					
RPCH Power (dBm)	BSCL (dB)	Measured Power (dBm)	Gain (dB)	Limit (dB)	Margin (dB)
-85.7	100	-11.15	58.85	79	20.15
-75.7	90	-21.09	49.91	69	19.09
-65.7	80	-33.15	36.85	59	22.15
-55.7	70	-42.05	27.95	49	21.05
-45.7	60	-51.95	18.05	39	20.95
-35.7	50	-55.97	14.03	29	14.97

WCDMA B5 Uplink Gain vs RPCH and BSCL - Middle Channel					
RPCH Power (dBm)	BSCL (dB)	Measured Power (dBm)	Gain (dB)	Limit (dB)	Margin (dB)
-94.5	107	-19.29	50.71	76	25.29
-84.5	97	-28.82	41.18	66	24.82
-74.5	87	-38.91	31.09	56	24.91
-64.5	77	-48.79	21.21	46	24.79
-54.5	67	-57.86	12.14	36	23.86
-44.5	57	-60.54	9.46	26	16.54

B12 Uplink Gain vs RPCH and BSCL - Middle Channel					
RPCH Power (dBm)	BSCL (dB)	Measured Power (dBm)	Gain (dB)	Limit (dB)	Margin (dB)
-80.5	104	-23.75	46.25	73	26.75
-70.5	94	-33.67	36.33	63	26.67
-60.5	84	-43.58	26.42	53	26.58
-50.5	74	-51.65	18.35	43	24.65
-40.5	64	-56.48	13.52	33	19.48
-30.5	54	-56.21	13.79	23	9.21



B4 Uplink Gain vs RPCH and BSCL - Middle Channel					
RPCH Power (dBm)	BSCL (dB)	Measured Power (dBm)	Gain (dB)	Limit (dB)	Margin (dB)
-90.6	101	-18.09	51.91	70	18.09
-80.56	91	-28.58	41.42	60	18.58
-70.34	81	-30.91	39.09	50	10.91
-60.81	71	-39.07	30.93	40	9.07
-50.46	61	-43.94	26.06	30	3.94
-40.7	51	-57.76	12.24	23	10.76

Uplink Gain Timing				
Band	Frequency (MHz)	UL Gain Timing (Sec)	Limit (Sec)	Margin (Sec)
Band 2 Uplink	1880.0	1.30	3	1.70
Band 5 Uplink	836.0	1.43	3	1.57
Band 12 Uplink	707.5	0.34	3	2.66
Band 4 Downlink	1745	0.47	3	1.53



2.8.9 Test Results





LTE Band 12 Uplink Gain Timing_5MHz Bandwidth Mid Channel



Date: 15.MAY.2016 10:24:51

LTE Band 4 Uplink Gain Timing_5MHz Bandwidth Mid Channel



Date: 15.MAY.2016 11:00:22



2.9 OSCILLATION DETECTION

2.9.1 Specification Reference

FCC 47 CFR Part 20. Clause 20.21(e)(9)(ii)(A)
KDB935210 D04, Clause 7.11

2.9.2 Standard Applicable

FCC 47 CFR Part 20. Clause 20.21(e)(9)(ii)(A) Anti-Oscillation:
Consumer boosters must be able to detect and mitigate (i.e., by automatic gain reduction or shut down), any oscillations in uplink and downlink bands. Oscillation detection and mitigation must occur automatically within 0.3 seconds in the uplink band and within 1 second in the downlink band. In cases where oscillation is detected, the booster must continue mitigation for at least one minute before restarting. After five such restarts, the booster must not resume operation until manually reset.

2.9.3 Equipment Under Test and Modification State

Serial No: 258602000014 (NU) and 259551000131 (CU), 258602000035 (NU) and 25955100346 (CU) /
Test Configuration A, B, C and D

2.9.4 Date of Test/Initial of test personnel who performed the test

May 12, 2016/XYZ

2.9.5 Test Equipment Used

The major items of test equipment used for the above tests are identified in Section 3.1.

2.9.6 Environmental Conditions

Test performed at TÜV SÜD America Inc. Rancho Bernardo facility.

Ambient Temperature	26.9°C
Relative Humidity	47.0%
ATM Pressure	99.2kPa



2.9.7 Additional Observations

- 1) This is conducted Test.
- 2) Test procedure is per Section 7.11 of KDB935210 (D04 Provider Specific Booster Measurements v01r01). Appropriate offset (line losses) applied.
- 3) The EUT operated in Normal Mode when testing Oscillation Mitigation Time;
- 4) Setup the EUT according to Figure 1 of Section 6.3.2 of KDB935210 (D04 Provider Specific Booster Measurements v01r01) for Normal Mode.
- 5) The EUT operated in Test Mode when testing Re-Try event;
- 6) Setup the EUT according to Figure 2 and Figure 3 of Section 6.3.3 of KDB935210 (D04 Provider Specific Booster Measurements v01r01) for Test Mode.
- 7) Evaluations are conducted at CU antenna ports B2/B12 and B5/B4, and NU antenna ports B2/B12 and B5/B4.
- 8) Signal: 5MHz LTE or WCDMA.

2.9.8 Test Results Summary

Band	Frequency (MHz)	Mitigation Time (Sec)	Limit (Sec)	Margin (Sec)
Band 2 Downlink	1960	0.065	1	0.935
Band 2 Uplink	1880	0.058	0.3	0.242
Band 5 Downlink	881.6	0.087	1	0.913
Band 5 Uplink	836.6	0.058	0.3	0.242
Band 12 Downlink	737.5	0.043	1	0.957
Band 12 Uplink	707.5	0.094	0.3	0.206
Band 4 Downlink	2145	0.043	1	0.957
Band 4 Uplink	1745	0.138	0.3	0.162



Band	Frequency (MHz)	Re-Try Event	Limit Event	Margin (dB)
Band 2 Downlink	1960	0	5	-5
Band 2 Uplink	1880	0	5	-5
Band 5 Downlink	881.6	0	5	-5
Band 5 Uplink	836.6	0	5	-5
Band 12 Downlink	737.5	0	5	-5
Band 12 Uplink	707.5	0	5	-5
Band 4 Downlink	2145	0	5	-5
Band 4 Uplink	1745	0	5	-5



2.9.9 Test Plots

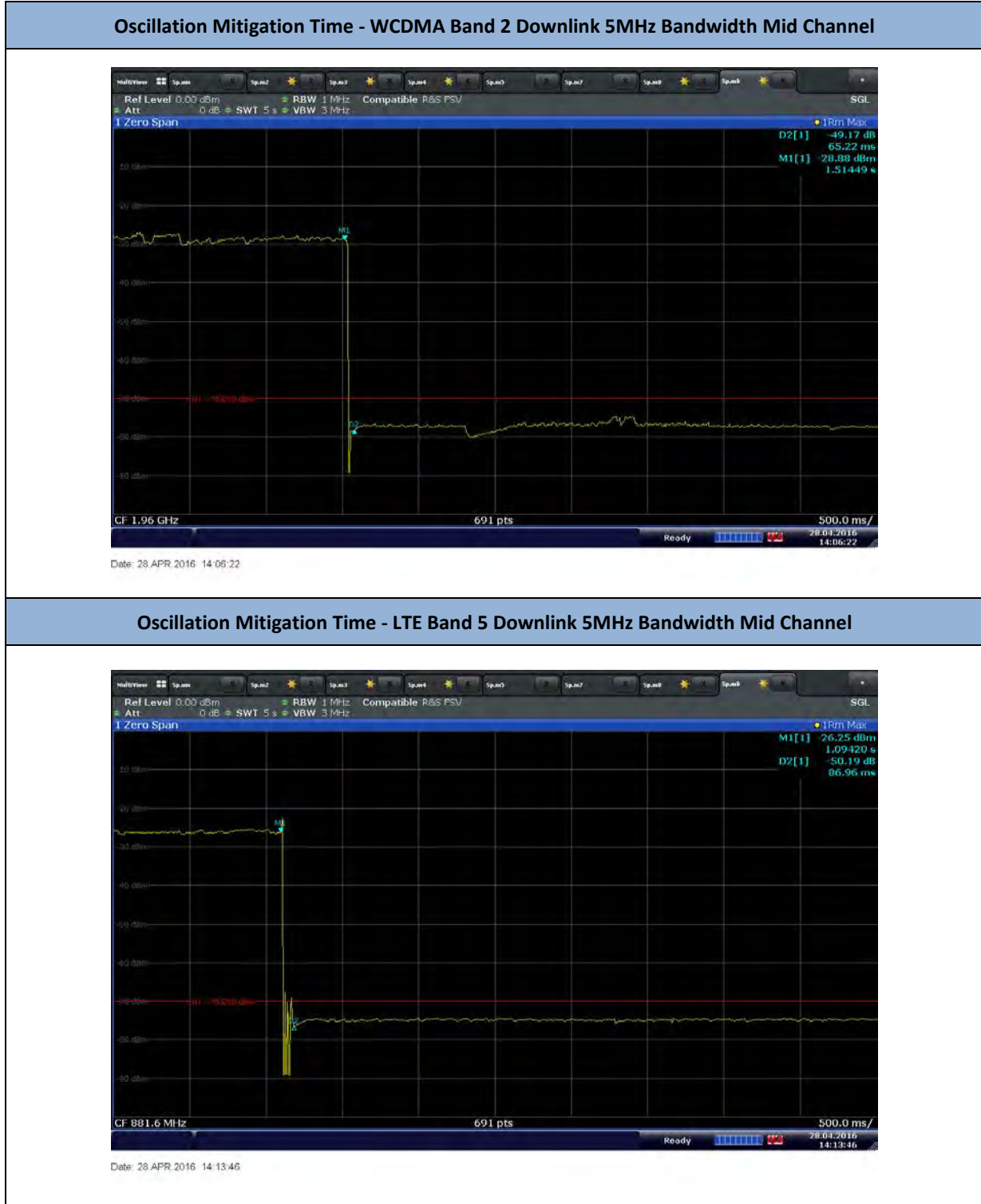



Oscillation Mitigation Time - LTE Band 12 Downlink 5MHz Bandwidth Mid Channel



Date: 28 APR 2016 14:03:18

Oscillation Mitigation Time - LTE Band 4 Downlink 5MHz Bandwidth Mid Channel



Date: 28 APR 2016 14:19:23



Oscillation Mitigation Time - WCDMA Band 2 Uplink 5MHz Bandwidth Mid Channel



Date: 28.APR.2016 12:32:16

Oscillation Mitigation Time - WCDMA Band 5 Uplink 5MHz Bandwidth Mid Channel



Date: 28.APR.2016 14:47:25



Oscillation Mitigation Time - LTE Band 12 Uplink 5MHz Bandwidth Mid Channel



Date: 28 APR 2016 12:38:33

Oscillation Mitigation Time - LTE Band 4 Uplink 5MHz Bandwidth Mid Channel



Date: 28 APR 2016 14:42:04



2.10 OUT OF BAND GAIN LIMIT

2.10.1 Specification Reference

FCC 47 CFR Part 20. Clause 20.21(e)(9)(i)(E)
KDB935210 D04, Clause 7.14

2.10.2 Standard Applicable

FCC 47 CFR Part 20. Clause 20.21(e)(9)(i)(E) Out of Band Gain Limits.:

(1) A frequency selective booster shall have the following minimum attenuation referenced to the gain in the center of the pass band of the booster:

- (i) -20 dB at the band edge, where band edge is the end of the licensee's allocated spectrum,
- (ii) -30 dB at 1 MHz offset from band edge,
- (iii) -40 dB at 5 MHz offset from band edge.

(2) A frequency selective booster having maximum gain greater than 80 dB (referenced to the center of the pass band) shall limit the out of band gain to 60 dB at 0.2 MHz offset from the band edge, and 45 dB at 1 MHz offset from the band edge, where band edge is the end of the licensee's allocated spectrum.

2.10.3 Equipment Under Test and Modification State

Serial No: 25860200035 (NU) and 25955100346 (CU) / Test Configuration A and B

2.10.4 Date of Test/Initial of test personnel who performed the test

April 25 and 26, 2016 /XYZ

2.10.5 Test Equipment Used

The major items of test equipment used for the above tests are identified in Section 3.1.

2.10.6 Environmental Conditions/ Test Location

Test performed at TÜV SÜD America Inc. Rancho Bernardo facility

Ambient Temperature	26.5 - 27.2°C
Relative Humidity	31.8 - 32.7%
ATM Pressure	99.0 - 99.1kPa



2.10.7 Additional Observations

- 1) This is conducted Test. Test procedure is per Section 7.14 of KDB935210 (D04 Provider Specific Booster Measurements v01r01). Appropriate offset (line losses) applied.
- 2) The EUT operated in Test Mode with the gain manually set to the maximum gain and a minimum bandwidth setting (5MHz).
- 3) Setup the EUT according to Figure 2 or 3 of Section 6.3.3 of KDB935210 (D04 Provider Specific Booster Measurements v01r01) as appropriate.
- 4) Evaluations are conducted at CU antenna ports B2/B12 and B5/B4, and NU antenna ports B2/B12 and B5/B4.
- 5) Operational uplink and downlink bands for WCDMA Band 2, 5, and LTE Band 12 and 4 were tested.
- 6) The signal generator was set to transmit a CW signal with output power level set to that as determined in clause 7.1.2 of KDB935210 (D04 Provider Specific Booster Measurements v01r01).

2.10.8 Test Results

Out of Band Gain Limit Band 2 Downlink (1930 – 1990MHz)				
Offset (MHz)	Input Power (dBm)	Output Power (dBm)	Gain (dB)	Gain Limit (dB)
Centre Frequency	-80.20	10.83	91.03	-
0 (Low Band Edge)	-81.00	-70.76	10.24	71.03
-0.2	-81.02	-70.74	10.28	60
-1	-81.04	-70.85	10.19	45
-5	-81.13	-72.1	9.03	51.03
0 (High Band Edge)	-80.88	-70.23	10.65	71.03
+0.2	-80.88	-70.48	10.4	60
+1	-80.82	-70.39	10.43	45
+5	-81.01	-70.95	10.06	51.03



Out of Band Gain Limit Band 2 Uplink (1850 – 1910MHz)				
Offset (MHz)	Input Power (dBm)	Output Power (dBm)	Gain (dB)	Gain Limit (dB)
Centre Frequency	-75.32	11.93	87.25	-
0 (Low Band Edge)	-75.82	-64.58	11.24	67.25
-0.2	-75.81	-64.56	11.25	60
-1	-75.97	-64.62	11.35	45
-5	-75.85	-62.83	13.02	47.25
0 (High Band Edge)	-75.38	-66.02	9.36	67.25
+0.2	-75.34	-66.07	9.27	60
+1	-75.35	-66.25	9.1	45
+5	-75.28	-67.32	7.96	47.25

Out of Band Gain Limit Band 5 Downlink (869– 894MHz)				
Offset (MHz)	Input Power (dBm)	Output Power (dBm)	Gain (dB)	Gain Limit (dB)
Centre Frequency	-80.2	9.70	89.9	-
0 (Low Band Edge)	-80.08	-68.24	11.84	69.9
-0.2	-80.11	-68.48	11.63	60
-1	-80.07	-68.59	11.48	45
-5	-80.21	-70.57	9.64	49.9
0 (High Band Edge)	-80.62	-68.39	12.23	69.9
+0.2	-80.63	-68.65	11.98	60
+1	-80.53	-68.60	11.93	45
+5	-80.34	-69.97	10.37	49.9



Out of Band Gain Limit Band 5 Uplink (824 – 849MHz)				
Offset (MHz)	Input Power (dBm)	Output Power (dBm)	Gain (dB)	Gain Limit (dB)
Centre Frequency	-75.42	5.41	80.83	-
0 (Low Band Edge)	-75.21	-69.47	5.74	60.83
-0.2	-75.21	-69.66	5.55	60
-1	-75.17	-69.68	5.49	45
-5	-75.12	-70.90	4.22	40.83
0 (High Band Edge)	-75.42	-69.71	5.71	60.83
+0.2	-75.41	-69.76	5.65	60
+1	-75.4	-69.87	5.53	45
+5	-75.32	-71.76	3.56	40.83

Out of Band Gain Limit Band 12 Downlink (729 – 746MHz)				
Offset (MHz)	Input Power (dBm)	Output Power (dBm)	Gain (dB)	Gain Limit (dB)
Centre Frequency	-79.00	9.70	88.7	-
0 (Low Band Edge)	-79.36	-66.95	12.41	68.7
-0.2	-79.36	-66.96	12.4	60
-1	-79.39	-67.28	12.11	45
-5	-79.43	-72.85	6.58	48.7
0 (High Band Edge)	-78.99	-72.6	6.39	68.7
+0.2	-79.10	-67.61	11.49	60
+1	-79.07	-67.65	11.42	45
+5	-79.20	-71.21	7.99	48.7



Out of Band Gain Limit Band 12 Uplink (699 – 716MHz)				
Offset (MHz)	Input Power (dBm)	Output Power (dBm)	Gain (dB)	Gain Limit (dB)
Centre Frequency	-75.33	5.42	80.75	-
0 (Low Band Edge)	-75.4	-67.65	7.75	60.75
-0.2	-75.32	-67.79	7.53	60
-1	-75.23	-67.89	7.34	45
-5	-75.2	-72.69	2.51	40.75
0 (High Band Edge)	-75.53	-67.87	7.66	60.75
+0.2	-75.34	-67.98	7.36	60
+1	-75.65	-68.68	6.97	45
+5	-75.88	-72.23	3.65	40.75

Out of Band Gain Limit Band 4 Downlink (2110 – 2155MHz)				
Offset (MHz)	Input Power (dBm)	Output Power (dBm)	Gain (dB)	Gain Limit (dB)
Centre Frequency	-79.7	10.22	89.92	-
0 (Low Band Edge)	-79.68	-71.31	8.37	69.92
-0.2	-79.65	-71.17	8.48	60
-1	-79.69	-71.36	8.33	45
-5	-79.74	-71.81	7.93	49.92
0 (High Band Edge)	-79.6	-71.62	7.98	69.92
+0.2	-79.62	-71.53	8.09	60
+1	-79.62	-70.45	9.17	45
+5	-79.65	-71.59	8.06	49.92



Out of Band Gain Limit Band 4 Uplink (1710 – 1755MHz)				
Offset (MHz)	Input Power (dBm)	Output Power (dBm)	Gain (dB)	Gain Limit (dB)
Centre Frequency	-76.43	4.89	81.32	-
0 (Low Band Edge)	-76.7	-68.79	7.91	61.32
-0.2	-76.98	-68.84	8.14	60
-1	-76.4	-69.98	6.42	45
-5	-76.56	-69.29	7.27	41.32
0 (High Band Edge)	-76.88	-69.7	7.18	61.32
+0.2	-76.5	-69.68	6.82	60
+1	-76.34	-68.03	8.31	45
+5	-76.45	-68.97	7.48	41.32

FCC ID: NU: YETQ34-251266NU
CU: YETQ34-251266CU
IC: NU: 9298A-Q34251266NU
CU: 9298A-Q34251266CU
Report No. SD72113545-0216F Rev1.0



SECTION 3

TEST EQUIPMENT USED



3.1 TEST EQUIPMENT USED

List of absolute measuring and other principal items of test equipment.

ID Number (SDGE/SDRB)	Test Equipment	Type	Serial Number	Manufacturer	Cal Date	Cal Due Date
Antenna Conducted Port Setup						
7569	P-Series Power Meter	N1911A P-	MY45100625	Agilent	06/19/15	06/19/16
7605	50MHz-18GHz Wideband Power Sensor	N1921A	MY51100054	Agilent	04/19/16	04/19/17
7582	Signal/Spectrum Analyzer	FSW26	101614	Rhode & Schwarz	10/05/15	10/05/16
7608	Vector Signal Generator	SMBV100A	259021	Rhode & Schwarz	07/29/15	07/29/16
9063	Universal Radio Communication	CMW200	1400-38269	Rhode & Schwarz	For Signal Only	
7562	Wideband Radio Communication Tester	CMW 500	1201.0002k50 /103829	Rhode & Schwarz	For Signal Only	
-	11dB Step Attenuator	8494B	2812A17193	Agilent	Verified by 7582 and 7608	
-	110 dB Step Attenuator	8496B	MY42143874	Agilent	Verified by 7582 and 7608	
8825	20dB Attenuator	46-20-34	BK5773	Weinschel Corp.	Verified by 7582 and 7608	
-	10dB Attenuator	PE7010-10	-	Pasternack	Verified by 7582 and 7608	
-	3dB Attenuator	PE7010-6	-	Pasternack	Verified by 7582 and 7608	
Miscellaneous						
6792	Multimeter	3478A	2911A70964	Hewlett Packard	08/14/15	08/14/16
7560	Barometer/Temperature /Humidity Transmitter	iBTHX-W	1240476	Omega	10/19/15	10/19/16
	Test Software	EMC32	V8.53	Rhode & Schwarz	N/A	



3.2 MEASUREMENT UNCERTAINTY

For a 95% confidence level, the measurement uncertainties for defined systems are:

3.2.1 General Direct Conducted Antenna Port Measurement

Contribution		Probability Distribution Type	Probability Distribution x_i	Standard Uncertainty $u(x_i)$	$[u(x_i)]^2$
1	Receiver/Spectrum Analyzer	Rectangular	0.34	0.20	0.04
2	Cables	Rectangular	1.00	0.58	0.33
3	EUT Setup	Rectangular	0.50	0.29	0.08
Combined Uncertainty (u_c):					0.67
Coverage Factor (k):					1.96
Expanded Uncertainty:					1.32

FCC ID: NU: YETQ34-251266NU
CU: YETQ34-251266CU
IC: NU: 9298A-Q34251266NU
CU: 9298A-Q34251266CU
Report No. SD72113545-0216F Rev1.0



SECTION 4

DIAGRAM OF TEST SETUP

4.1 TEST SETUP DIAGRAM

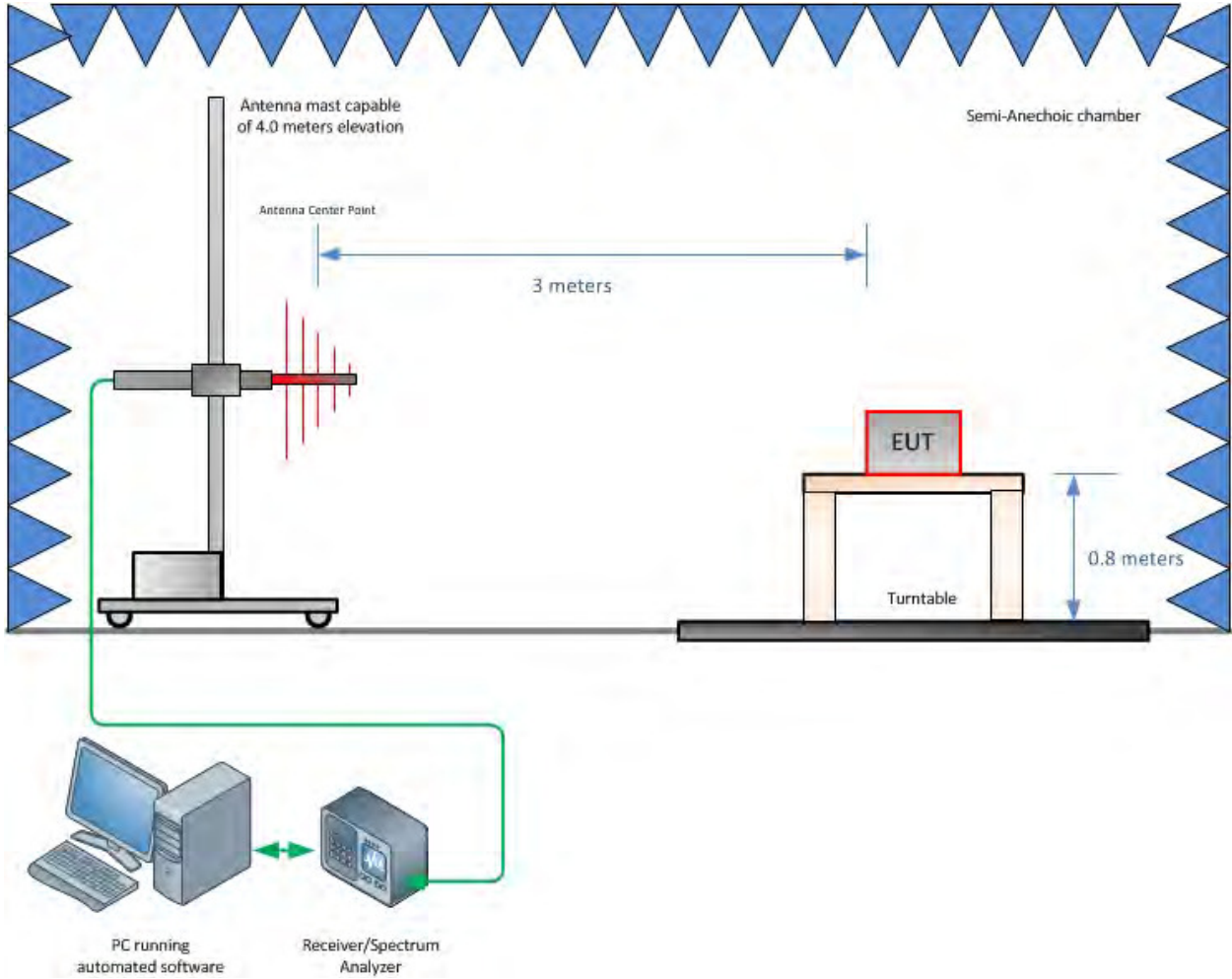

Radiated Emission Test Setup (Below 1GHz) (if applicable)

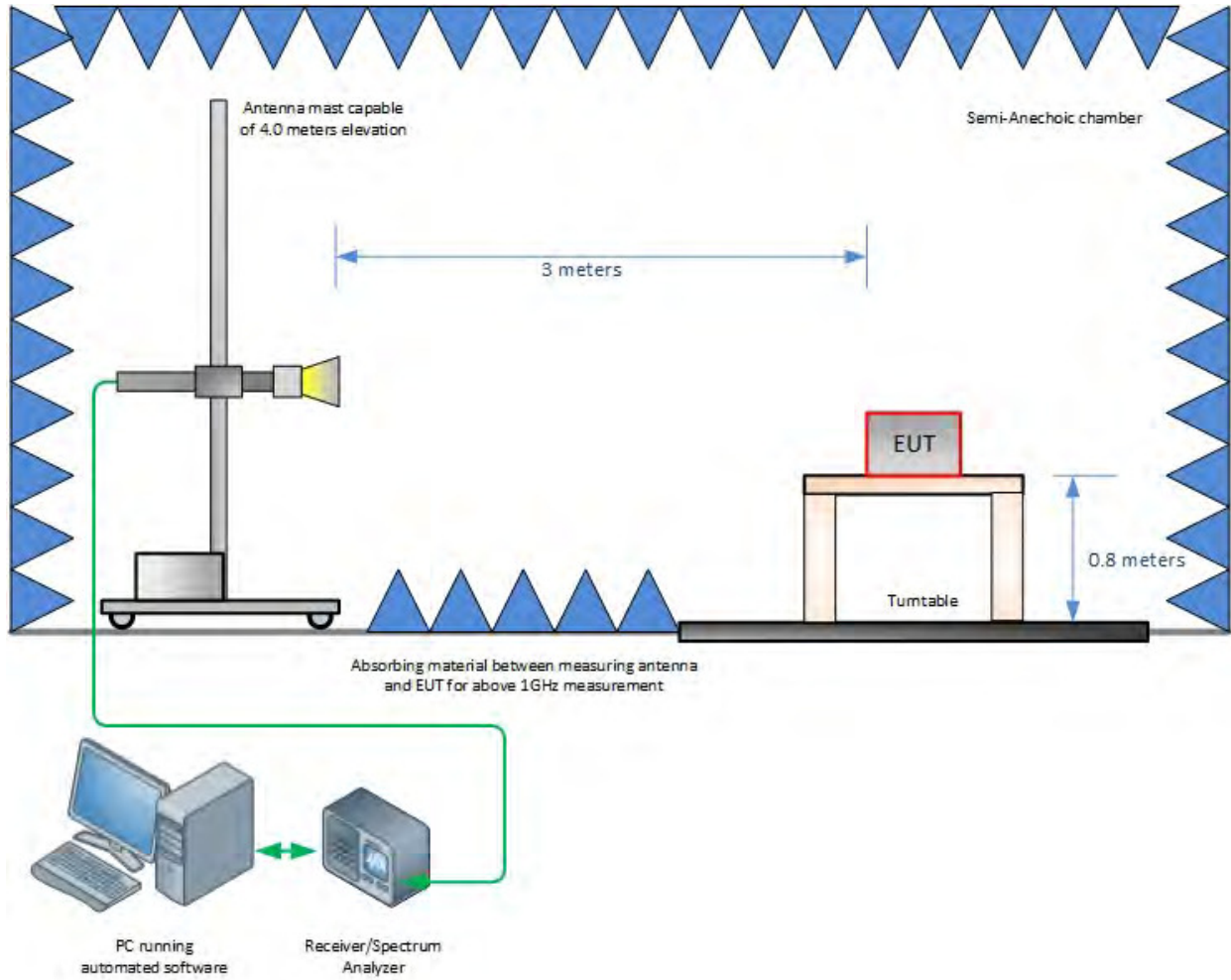

Radiated Emission Test Setup (Above 1GHz) (if applicable)

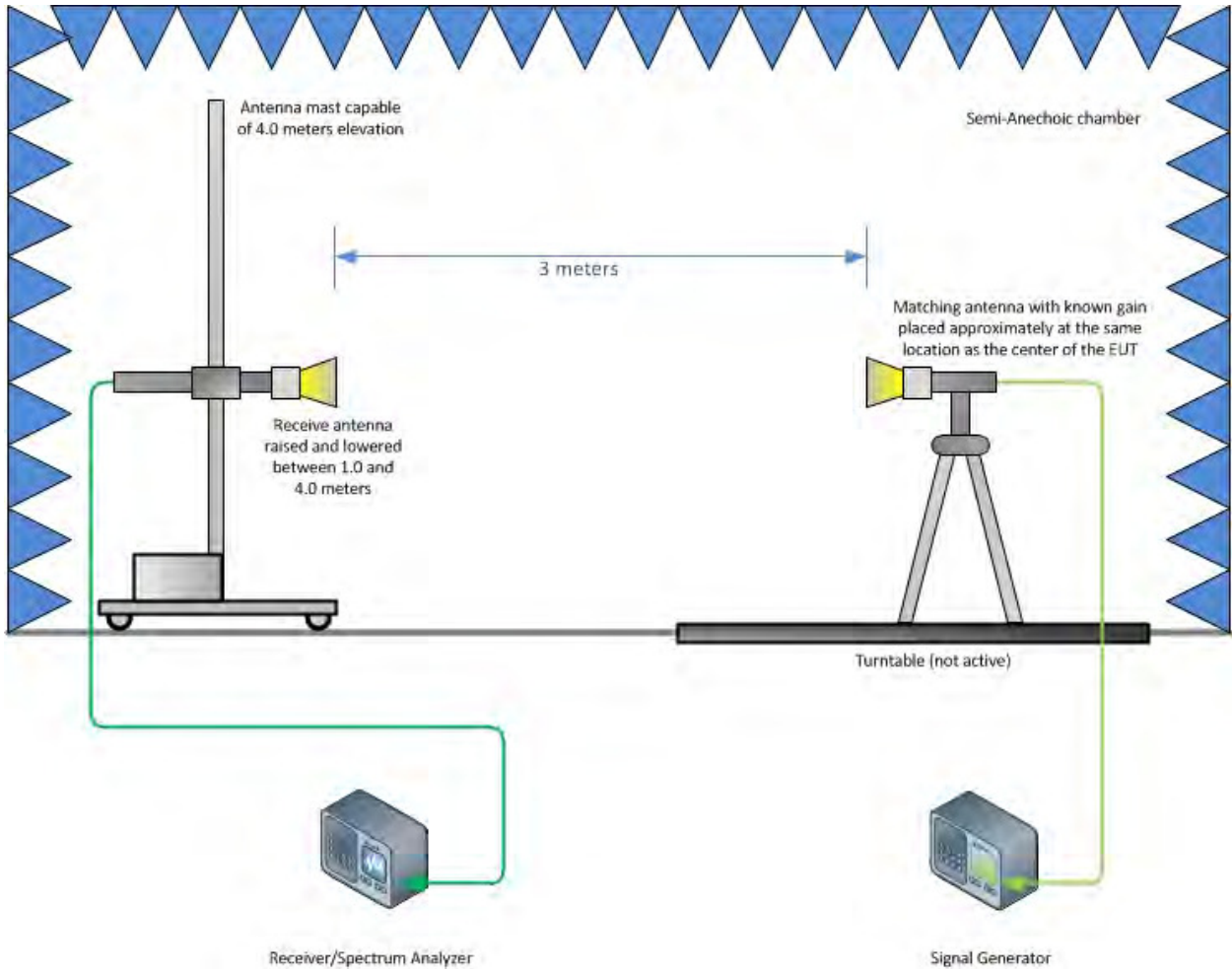

Substitution Test Method (Above 1GHz, if applicable)

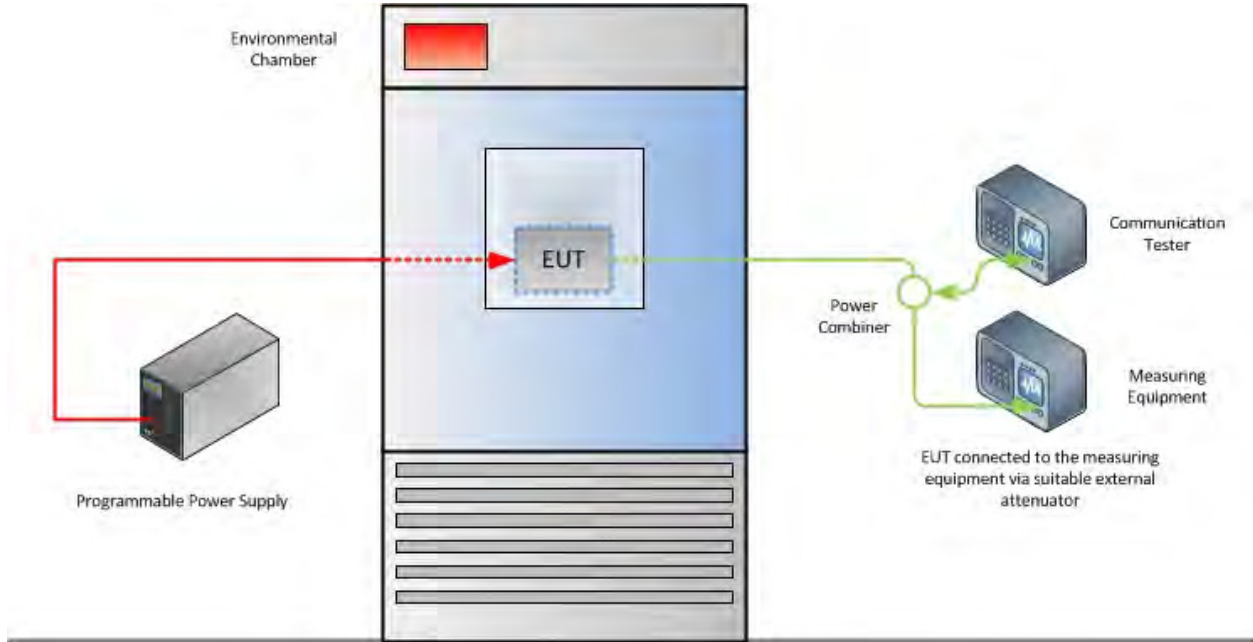

Frequency Stability Test Configuration

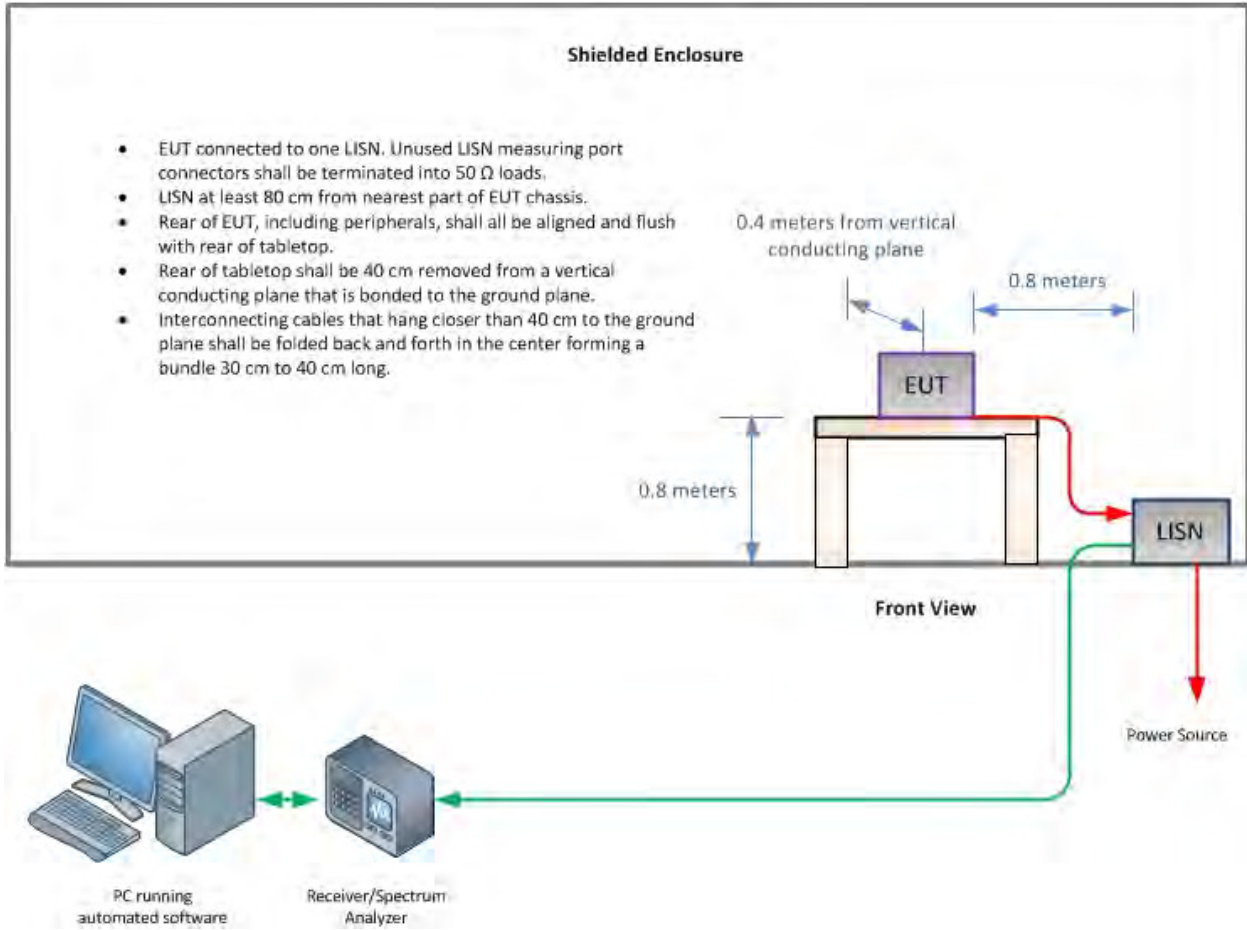

Conducted Emissions Test Configuration (if applicable)

FCC ID: NU: YETQ34-251266NU
CU: YETQ34-251266CU
IC: NU: 9298A-Q34251266NU
CU: 9298A-Q34251266CU
Report No. SD72113545-0216F Rev1.0



SECTION 5

ACCREDITATION, DISCLAIMERS AND COPYRIGHT



5.1 ACCREDITATION, DISCLAIMERS AND COPYRIGHT

TÜV SÜD America Inc.'s reports apply only to the specific sample tested under stated test conditions. It is the manufacturer's responsibility to assure the continued compliance of production units of this model. TÜV SÜD America, Inc. shall have no liability for any deductions, inferences or generalizations drawn by the client or others from TÜV SÜD America, Inc.'s issued reports.

This report is the confidential property of the client. As a mutual protection to our clients, the public and TÜV SÜD America, Inc., extracts from the test report shall not be reproduced, except in full without TÜV SÜD America, Inc.'s written approval.

This report must not be used to claim product certification, approval, or endorsement by A2LA, NIST, or any agency of the federal government.

TÜV SÜD America, Inc. and its professional staff hold government and professional organization certifications for AAMI, ACIL, AEA, ANSI, IEEE, A2LA, NIST and VCCI.



A2LA Cert. No. 2955.13

