

# Radio Testing of the

Nextivity Inc.

Industrial Signal Booster

Model: Cel-Fi QUATRA

Q34-2/12/14/66NU\_EXA (NU)

Q34-2/12/14/66CU\_EXA (CU)

In accordance with

FCC CFR 47 Part 90

RSS-140 issue 1 (April 2018)

RSS-131 issue 3 (May 2017)

Nextivity Inc.

16550 West Bernardo Drive, Bldg 5, Suite 550,  
San Diego, CA 92127, USA

Date: November 2020

Document Number: 72162443B Issue 01 | Version Number: 01

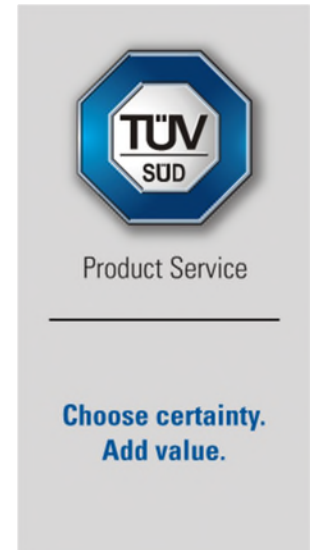

RESPONSIBLE FOR	NAME	DATE	SIGNATURE
Authorized Signatory	Alex Chang	November 17, 2020	<i>Alex Chang</i>

Signatures in this approval box have checked this document in line with the requirements of TÜV SÜD Product Service document control rules.

### EXECUTIVE SUMMARY

The EUT in general was confirmed to be in compliance with FCC CFR 47 Part 90, RSS-140 issue 1 (April 2018) and RSS-131 issue 3 (May 2017).



A2LA Cert. No. 2955.13

### DISCLAIMER AND COPYRIGHT

This non-binding report has been prepared by TÜV SÜD Product Service with all reasonable skill and care. The document is confidential to the potential Client and TÜV SÜD Product Service. No part of this document may be reproduced without the prior written approval of TÜV SÜD Product Service. © 2016 TÜV SÜD Product Service.

### ACCREDITATION

Our A2LA Accreditation does not cover opinions and interpretations and any expressed are outside the scope of our A2LA Accreditation.

TÜV SÜD America, Inc.  
10040 Mesa Rim Road  
San Diego, CA 92121-2912

TÜV SÜD America, Inc.  
Rancho Bernardo Facility  
16936 Via Del Campo  
San Diego, CA 92127

Phone: 858 678 1400  
[www.tuv-sud-america.com](http://www.tuv-sud-america.com)



America

TÜV SÜD America Inc., 10040 Mesa Rim Road, San Diego, CA 92121  
Tel: (858) 678-1400. Website: [www.TUVamerica.com](http://www.TUVamerica.com)

**REPORT ON** Radio Testing of the  
Nextivity Inc.  
Cel-Fi QUATRA Industrial Signal Booster

**TEST REPORT NUMBER** 72162443B

**REPORT DATE** November 2020

**PREPARED FOR** Nextivity Inc.  
16550 West Bernardo Drive, Bldg 5, Suite 550,  
San Diego, CA 92127, USA

**CONTACT PERSON** CK Li  
Sr. Principal Engineer, Regulatory  
(858) 485-9422  
CLi@NextivityInc.com

**PREPARED BY**   
Xiaoying Zhang

---

**Name**  
Authorized Signatory  
Title: EMC/Wireless Test Engineer



America

TÜV SÜD America Inc., 10040 Mesa Rim Road, San Diego, CA 92121  
Tel: (858) 678-1400. Website: [www.TUVamerica.com](http://www.TUVamerica.com)

### Revision History

72162443B Nextivity Inc. Cel-Fi QUATRA Industrial Signal Booster					
DATE	OLD REVISION	NEW REVISION	REASON	PAGES AFFECTED	APPROVED BY
11/17/2020	—	Initial Release			Alex Chang



# CONTENTS

Section	Page No
<b>1</b>	<b>REPORT SUMMARY ..... 4</b>
1.1	Introduction ..... 5
1.2	Brief Summary of Results ..... 7
1.3	Product Information ..... 8
1.4	EUT Test Configuration ..... 11
1.5	Deviations from the Standard ..... 15
1.6	Modification Record ..... 15
1.7	Test Methodology ..... 15
1.8	Test Facility Location ..... 15
1.9	Test Facility Registration ..... 15
<b>2</b>	<b>TEST DETAILS ..... 17</b>
2.1	Transmitter Conducted Output Power ..... 18
2.2	Effective Radiated Power ..... 21
2.3	Occupied Bandwidth ..... 23
2.4	Peak-Average Ratio ..... 29
2.5	Band Edge ..... 33
2.6	Conducted Spurious Emissions ..... 39
2.7	Field Strength of Spurious Radiation ..... 61
2.8	Frequency Stability ..... 69
2.9	Power Line Conducted Emissions ..... 73
2.10	AGC Threshold Level ..... 77
2.11	Out-of-Band Rejection ..... 79
2.12	Input-versus-Output Signal Comparison ..... 82
2.13	Emission Mask and Adjacent Channel Power ..... 92
2.14	Input and Output Power and Amplifier/Booster Gain ..... 94
2.15	Noise Figure ..... 96
2.16	Out-of-Band/Out-of-Block (Intermodulation) and Spurious Emissions ..... 99
<b>3</b>	<b>TEST EQUIPMENT USED ..... 102</b>
3.1	Test Equipment Used ..... 103
3.2	Measurement Uncertainty ..... 104
<b>4</b>	<b>Diagram Of Test Setup ..... 106</b>
4.1	Test Setup Diagram ..... 107
<b>5</b>	<b>ACCREDITATION, DISCLAIMERS AND COPYRIGHT ..... 111</b>
5.1	Accreditation, Disclaimers and Copyright ..... 112



## **SECTION 1**

### **REPORT SUMMARY**

Radio Testing of the  
Nextivity Inc.  
Cel-Fi QUATRA Industrial Signal Booster



## 1.1 INTRODUCTION

The information contained in this report is intended to show verification of the Nextivity Inc. Cel-Fi QUATRA to the requirements of FCC CFR 47 Part 90, RSS-140 issue 1 (April 2018) and RSS-131 issue 3 (May 2017).

Objective	To perform Radio Testing to determine the Equipment Under Test's (EUT's) compliance with the Test Specification, for the series of tests carried out.
Manufacturer	Nextivity Inc.
EUT	Industrial Signal Booster
Model Name	Cel-Fi QUATRA
Model Number(s)	Q34-2/12/14/66NU_EXA (NU) Q34-2/12/14/66CU_EXA (CU)
FCC ID	NU: YETQ34-2121466NU CU: YETQ34-2121466CU
IC ID	N/A
Serial Number(s)	NU: 976036000256 CU: 977036000055
Number of Samples Tested	2
Date sample(s) received	September 25, 2020
Test Specification/Issue/Date	<ul style="list-style-type: none"> <li>• FCC CFR 47 Part 90 (October 1, 2019)</li> <li>• RSS-140 - Equipment Operating in the Public Safety Broadband Frequency Bands 758-768 MHz and 788-798 MHz (issue 1, April 2018)</li> <li>• RSS-131 – Zone Enhancers (issue 3, Updated May 2017)</li> <li>• SRSP-540 - Technical Requirements for Public Safety Broadband Systems in the Bands 758-768 MHz and 788-798 MHz (issue 1, April 2018)</li> <li>• RSS-Gen - General Requirements for Compliance of Radio Apparatus (Issue 5, November 2019 Amendment 1)</li> <li>• ANSI C63.26-2015: American National Standard for Compliance Testing of Transmitters Used in Licensed Radio Services</li> </ul>
Start of Test	September 26, 2020
Finish of Test	October 15, 2020
Name of Engineer(s)	Xiaoying Zhang



Related Document(s)

- KDB971168 D01 Power Meas License Digital Systems v03r01 (Measurement Guidance for Certification of Licensed Digital Transmitters)
- KDB412172 D01 Determining ERP and EIRP v01r01 (Guidelines for Determining the Effective Radiated Power (ERP) and Equivalent Isotropically Radiated Power (EIRP) of a RF Transmitting System)
- KDB662911 D01 Multiple Transmitter Output v02r01 (Emissions Testing of Transmitters with Multiple Outputs in the Same Band)
- Supporting documents for EUT certification are separate exhibits.

## 1.2 BRIEF SUMMARY OF RESULTS

A brief summary of the tests carried out in accordance with FCC CFR 47 Part 90 is shown below:

Section	Part 2	Part 90	RSS-140	KDB 935210 D05/ RSS-131	Test Description	Result
2.1	2.1046	-	-	-	Transmitter Conducted Output Power	Compliant
2.2	2.1046	90.219(e)(1) 90.542(a)(3)	4.3	-	Effective Radiated Power	Compliant
2.3	2.1049	90.219(e)(4)	RSS-Gen 6.7	-	Occupied Bandwidth	Compliant
2.4	-	-	4.3	-	Peak-Average Ratio	Compliant
2.5	2.1051	90.543(e)(1)(3)	4.4	-	Band Edge	Compliant
2.7	2.1051	90.219(e)(3) 90.543(e)(1)(3)(f)	4.4	4.7.3	Conducted Spurious Emissions	Compliant
2.7	2.1053	90.219(e)(3) 90.543(e)(3)	4.4	4.9	Field Strength of Spurious Radiation	Compliant
2.8	2.1055	90.213	4.2	4.8 / 5.2.4	Frequency Stability	Compliant
-	-	-	RSS-Gen 7.1	-	Receiver Spurious Emissions	N/A
2.9	-	-	RSS-GEN 8.8	-	Power line conducted emissions	Compliant
2.10	-	-	-	4.2	ACG Threshold Level	Compliant
2.11	-	-	-	4.3 / 5.2.1	Out of Band Rejection	Compliant
2.12	-	90.219(e)(4)(ii)	-	4.4 / 5.2.2	Input-versus-output signal comparison	Compliant
2.13	-	90.219 (e)(4)(iii) 90.210	-	4.4	Emission Mask and Adjacent Channel Power	Justification
2.14	-	90.219(e)(1)	-	4.5 / 5.2.3	Input / Output Power and Amplifier / Booster Gain	Compliant
2.15	-	90.219(e)(2)	-	4.6	Noise Figure	Compliant
2.16	2.1051	90.219(e)(3)	4.4	4.7	Out-of-band/out-of-block (Intermodulation) and Spurious Emissions	Compliant

**N/A** Not required as per RSS-GEN 5.3. EUT is not a Stand-alone receiver.



### 1.3 PRODUCT INFORMATION

#### 1.3.1 Technical Description

The Equipment Under Test (EUT) was a Nextivity Inc. Cel-Fi QUATRA Industrial Signal Booster. The EUT is a Public Safety LTE Signal Booster to improve voice and data cellular performance in large enterprise environments. QUATRA consists of two separate units: The Network Unit (NU), and the Coverage Unit (CU). The NU comprises a transmitter and receiver which communicate with the cell tower and the CU. Figure 1 illustrates the typical application. The CU is a self-contained unit with internal antennas. It operates without the need to install external antennas. However, external antenna ports are available as an option on CU. NU uses external antennas only. External antenna or MicroCell donor signal input can be connected to these ports.

LTE Band 14 function of the EUT was verified in this test report.

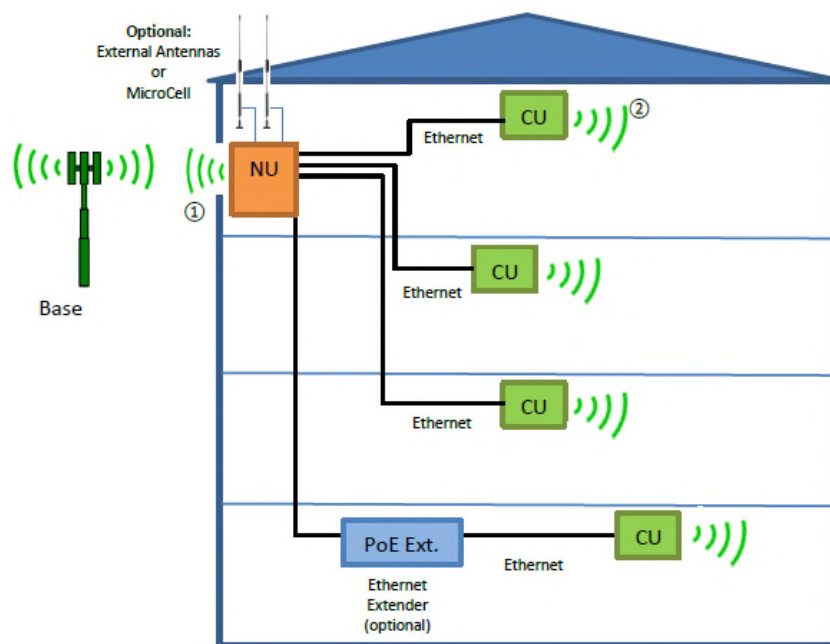

Figure 1: Cel-Fi QUATRA Connections



**1.3.2 EUT General Description**

EUT Description Industrial Signal Booster

Trade Name Cel-Fi™

Model Name Cel-Fi QUATRA

Model Number(s) Q34-2/12/14/66NU\_EXA (NU)  
Q34-2/12/14/66CU\_EXA (CU)

Rated Voltage NU: 54V DC via external AC/DC Power Supply  
CU: 48V DC, powered from NU via Ethernet cable

Mode Verified LTE Band 14

Frequency Bands LTE Band 14: Uplink: 788 - 798 MHz  
Downlink: 758 - 768 MHz

Product Specifications

Band	Signal Bandwidth (MHz)	Rated Power (dBm)	
		Downlink	Uplink
14	5 – 20	10 dBm / 5MHz (Max. 13)	20

Power Tolerance (dBm) ± 2

Capability LTE (Band 2, 4, 12 and 14)

Primary Unit (EUT)  Production  
 Pre-Production  
 Engineering

Environment Fixed, Indoor

Manufacturer Declared Temperature Range 0°C to 40°C

Antenna Type NU: External MIMO Antenna  
CU: Internal or External MIMO Antenna

Antenna Model Refer to the Antenna information supplied by the manufacture

Antenna gain Refer to the Antenna information supplied by the manufacture

Maximum Antenna Gain

Radio	Uplink (Donor)	Downlink (Server)
LTE Band 14	6.5 dBi	6.5 dBi



### 1.3.3 Transmit Frequency Table

Mode	Channel Bandwidth (MHz)	Tx Frequency (MHz)	Emission Designator	ERP	
				Max. Power Avg (dBm)	Max. Power Avg (W)
LTE Band 14 Downlink	5	758 - 768	4M44F9W	18.24	0.07
	10	758 - 768	8M70F9W	20.88	0.12
LTE Band 14 Uplink	5	788 - 798	4M41F9W	29.34	0.86
	10	788 - 798	8M77F9W	28.80	0.76

## 1.4 EUT TEST CONFIGURATION

### 1.4.1 Test Configuration Description

Test Configuration	Description
A	Downlink. Input signal is applied to the external antenna port of Donor (NU). Output is monitored from the internal antenna port of Server (CU).
B	Uplink. Input signal is applied to the internal antenna port of Server (CU). Output is monitored from the external antenna port of Donor (NU).
C	Radiated test setup. Downlink. Input signal is applied to the external antenna port of Donor (NU). The internal antenna ports of Server (CU) are terminated with 50Ω loads.
D	Radiated test setup. Uplink. Input signal is applied to the internal antenna port of Server (CU). The antenna ports of Donor (NU) are terminated with 50Ω loads.
E	Both CU (Downlink) and NU (Uplink) are set to transmit LTE Band 2, 4 and 14 simultaneously at full power using safety testing of the configuration software. CU and NU output Antenna ports were terminated with 50Ω loads.

### 1.4.2 EUT Exercise Software

Manufacturer provided a configuration software (ConformanceTest.exe) running from a support laptop where both NU and CU are connected via USB.

### 1.4.3 Support Equipment and I/O cables

Manufacturer	Equipment/Cable	Description
Lenovo	Support Laptop	M/N: 2912-3VU, S/N: R9-92MH0 10/11
Lenovo	Support Laptop AC Adapter	M/N: 42T4430 S/N: 11S42T4430Z1ZGWE27AA9X
Nextivity	Support USB cable x 2	Custom 1.0 meter shielded USB Type A to Micro B cable
Nextivity	Support USB cable x 1	Custom 1.0 meter shielded USB Type A to Micro A cable
Nextivity	Support Ethernet cable x 1	Custom 2.0 meter unshielded CAT 5e Ethernet Cables
Agilent	Vector Signal Generator	M/N: SMBV100A, S/N: 259021
Aeroflex	Signal Generator	M/N: 3005, S/N: 3005A/09L
Ramsey	Support Shielded Test Enclosure	With custom USB cable

#### 1.4.4 Worst Case Configuration

Worst-case configuration used in this test report per Transmitter Conducted Output Power (Section 2.1 of this test report). This is for single channel verification. Otherwise all three channels (Low, Middle and High) are verified:

Mode	Bandwidth	Channel No.	Frequency
LTE Band 14 Downlink	10 MHz	Middle Channel 5330	763 MHz
LTE Band 14 Uplink	5 MHz	Top Channel 23355	795.5 MHz

Final installation position is unknown at the time of verification. For radiated measurements X and Z orientations were verified since the EUT won't work on Y orientation. No major variation in emissions observed between the three (3) orientations. Verifications performed using "X" configuration.

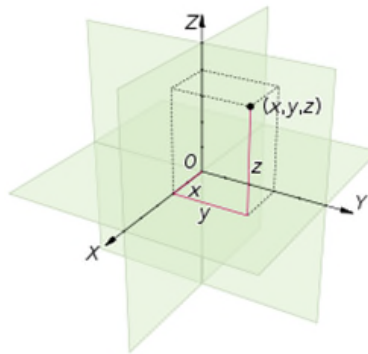

1.4.5 Simplified Test Configuration Diagram

**Downlink (CU Tx) Conducted Test**

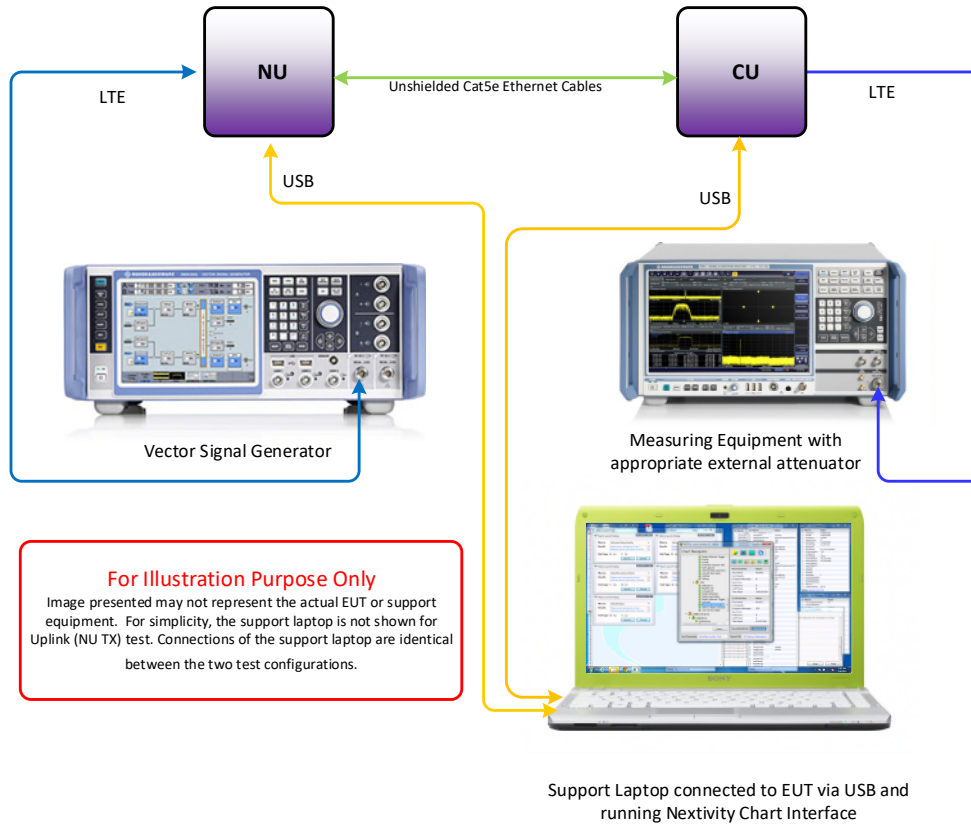

**For Illustration Purpose Only**  
 Image presented may not represent the actual EUT or support equipment. For simplicity, the support laptop is not shown for Uplink (NU Tx) test. Connections of the support laptop are identical between the two test configurations.

**Uplink (NU Tx) Conducted Test**

Monitoring the output can be done simultaneously (2 SA) or single output

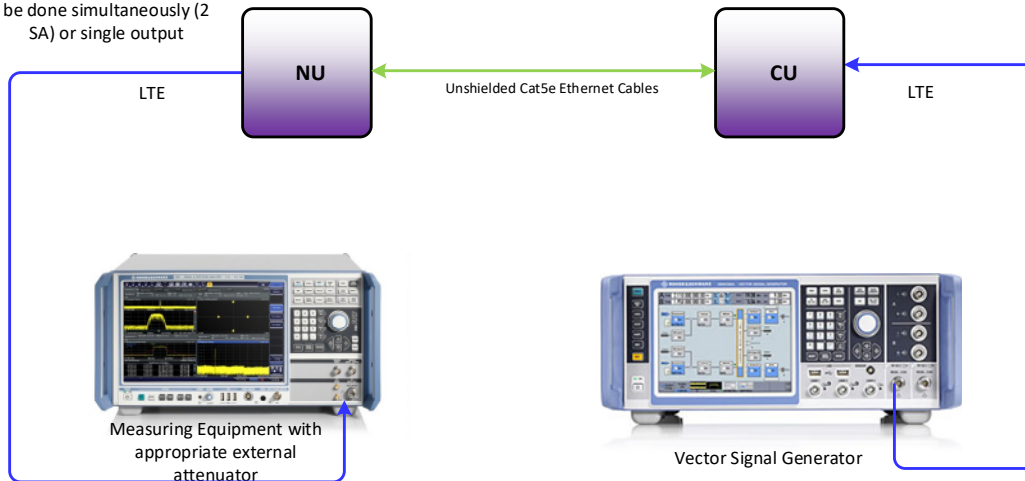

### Radiated Testing (Downlink)

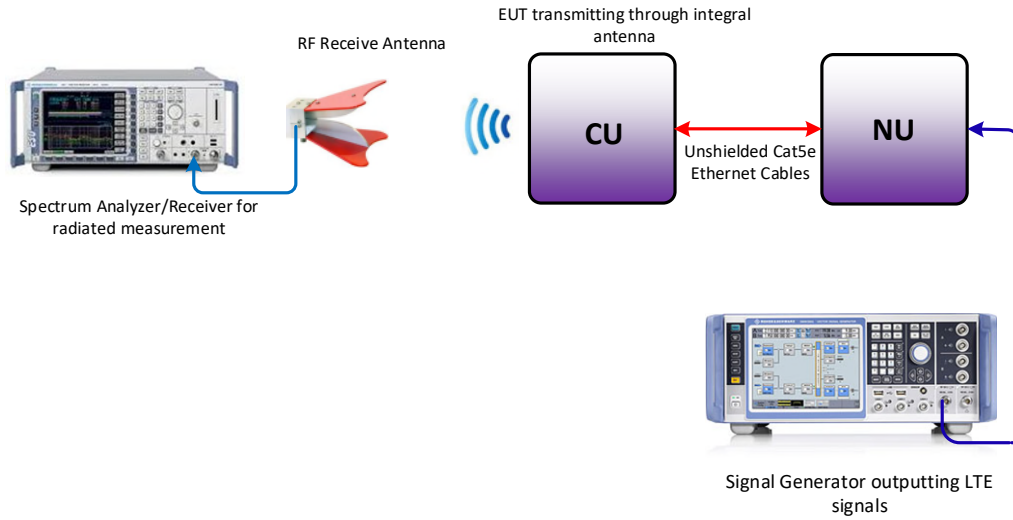

### Radiated Testing (Uplink)

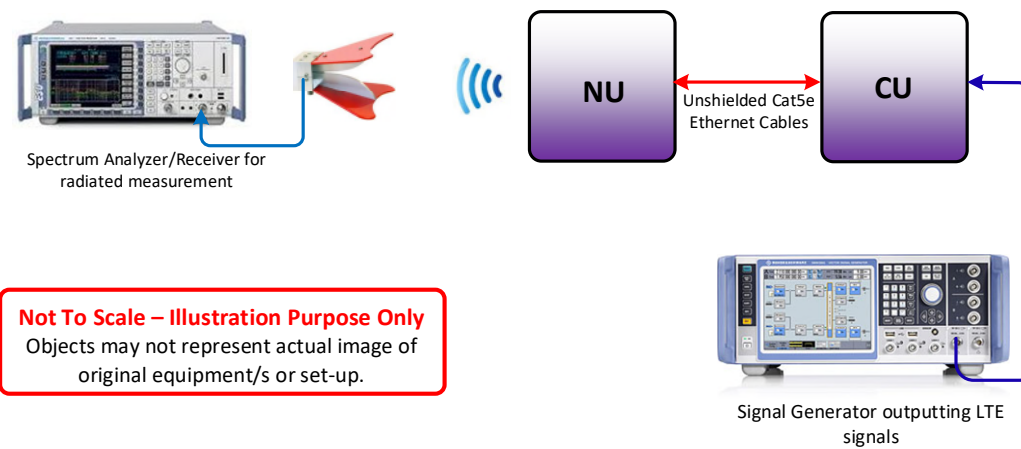

**Not To Scale – Illustration Purpose Only**  
Objects may not represent actual image of original equipment/s or set-up.



## 1.5 DEVIATIONS FROM THE STANDARD

No deviations from the applicable test standards or test plan were made during testing.

## 1.6 MODIFICATION RECORD

Description of Modification	Modification Fitted By	Date Modification Fitted
Serial Number: NU: 976036000256 and CU: 977036000055		
None	-	-

The table above details modifications made to the EUT during the test program. The modifications incorporated during each test (if relevant) are recorded on the appropriate test pages.

## 1.7 TEST METHODOLOGY

All measurements contained in this report were conducted with ANSI C63.26 2015, American National Standard for Compliance Testing of Transmitters Used in Licensed Radio Services

For conducted (if applicable) and radiated emissions the equipment under test (EUT) was configured to measure its highest possible emission level. This level was based on the maximized cable configuration from exploratory testing per ANSI C63.26-2015. The test modes were adapted according to the Operating Instructions provided by the manufacturer/client.

## 1.8 TEST FACILITY LOCATION

### 1.8.1 TÜV SÜD America Inc. (Mira Mesa)

10040 Mesa Rim Road, San Diego, CA 92121-2912 (32.901268,-117.177681). Phone: (858) 678 1400 Fax: (858) 546 0364.

### 1.8.2 TÜV SÜD America Inc. (Rancho Bernardo)

16936 Via Del Campo, San Diego, CA 92127-1708 (33.018644,-117.092409). Phone: (858) 678 1400 Fax: (858) 546 0364.

## 1.9 TEST FACILITY REGISTRATION

### 1.9.1 FCC – Designation No.: US1146

TÜV SÜD America Inc. (San Diego), is an accredited test facility with the site description report on file and has met all the requirements specified in §2.948 of the FCC rules. The acceptance letter from the FCC is maintained in our files and the Designation is US1146.





**1.9.2 Innovation, Science and Economic Development Canada (ISED) Registration No.: 3067A-1 & 22806-1**

The 10m Semi-anechoic chamber of TÜV SÜD America Inc. (San Diego Rancho Bernardo) has been registered by Certification and Engineering Bureau of Innovation, Science and Economic Development Canada for radio equipment testing with Registration No. 3067A-1.

The 3m Semi-anechoic chamber of TÜV SÜD America Inc. (San Diego Mira Mesa) has been registered by Certification and Engineering Bureau of Innovation, Science and Economic Development Canada for radio equipment testing with Registration No. 22806-1.

**1.9.3 BSMI – Laboratory Code: SL2-IN-E-028R (US0102)**

TÜV Product Service Inc. (San Diego) is a recognized EMC testing laboratory by the BSMI under the MRA (Mutual Recognition Arrangement) with the United States. Accreditation includes CNS 13438 up to 6GHz.

**1.9.4 NCC (National Communications Commission - US0102)**

TÜV SÜD America Inc. (San Diego) is listed as a Foreign Recognized Telecommunication Equipment Testing Laboratory and is accredited to ISO/IEC 17025 (A2LA Certificate No.2955.13) which under APEC TEL MRA Phase 1 was designated as a Conformity Assessment Body competent to perform testing of equipment subject to the Technical Regulations covered under its scope of accreditation including RTTE01, PLMN01 and PLMN08 for TTE type of testing and LP002 for Low-Power RF Device type of testing.

**1.9.5 VCCI – Registration No. A-0280 and A-0281**

TÜV SÜD America Inc. (San Diego) is a VCCI registered measurement facility which includes radiated field strength measurement, radiated field strength measurement above 1GHz, mains port interference measurement and telecommunication port interference measurement.

**1.9.6 RRA – Identification No. US0102**

TÜV SÜD America Inc. (San Diego) is National Radio Research Agency (RRA) recognized laboratory under Phase I of the APEC Tel MRA.

**1.9.7 OFCA – U.S. Identification No. US0102**

TÜV SÜD America Inc. (San Diego) is recognized by Office of the Communications Authority (OFCA) under Appendix B, Phase I of the APEC Tel MRA.



## **SECTION 2**

### **TEST DETAILS**

Radio Test of the  
Nextivity Inc.  
Cel-Fi QUATRA Industrial Signal Booster



## 2.1 TRANSMITTER CONDUCTED OUTPUT POWER

### 2.1.1 Specification Reference

FCC 47 CFR Part 2, Clause 2.1046

### 2.1.2 Standard Applicable

The conducted power measurements were made in accordance to FCC Part 2 Clause 2.1046:

(a) For transmitters other than single sideband, independent sideband and controlled carrier radiotelephone, power output shall be measured at the RF output terminals when the transmitter is adjusted in accordance with the tune-up procedure to give the values of current and voltage on the circuit elements specified in §2.1033(c)(8). The electrical characteristics of the radio frequency load attached to the output terminals when this test is made shall be stated.

(c) For measurements conducted pursuant to paragraphs (a) and (b) of this section, all calculations and methods used by the applicant for determining carrier power or peak envelope power, as appropriate, on the basis of measured power in the radio frequency load attached to the transmitter output terminals shall be shown. Under the test conditions specified, no components of the emission spectrum shall exceed the limits specified in the applicable rule parts as necessary for meeting occupied bandwidth or emission limitations.

### 2.1.3 Equipment Under Test and Modification State

Serial No: NU: 976036000256 and CU: 977036000055 / Test Configuration A and B

### 2.1.4 Date of Test/Initial of test personnel who performed the test

October 12, 2020 / XYZ

### 2.1.5 Test Equipment Used

The major items of test equipment used for the above tests are identified in Section 3.1.

### 2.1.6 Environmental Conditions/ Test Location

Test performed at TÜV SÜD America Inc. Rancho Bernardo facility

Ambient Temperature	23.2 °C
Relative Humidity	48.7 %
ATM Pressure	98.7 kPa

### 2.1.7 Additional Observations

- This is a conducted test using power meter.
- The path loss was measured and entered as a level offset.
- Both Peak and Average measurements presented.
- EUT Downlink transmits on two internal antennas and uplink transmits on two external antennas simultaneously in the same frequency range, i.e. TX MIMO mode. However, there is no much difference between two antenna ports and the measurement was performed on one antenna port as representative configuration. The total conducted average output power was adjusted with a correction of 3 dB [ $10\log(2)$ ] by using Measure and Add  $10\log(N)$  dB technique according to FCC KDB 662911 D01 Multiple Transmitter Output accounting for simultaneous transmission from two internal or external antenna ports.



- LTE Band 14 supports 5 and 10 MHz bandwidths.
- Low, Middle and High channels for supporting bandwidths were verified and reported.

**2.1.8 Test Results**

LTE Band 14 Downlink					
Bandwidth (MHz)	Channel	Frequency (MHz)	Average Power (dBm)	PK Power (dBm)	Total Average Power of MIMO Ports (dBm)
5	5305	760.5	10.89	17.97	13.89
	5330	763.0	10.82	23.53	13.82
	5355	765.5	10.73	19.06	13.73
10	-	-	-	-	-
	<b>5330</b>	<b>763.0</b>	<b>13.53</b>	22.94	<b>16.53</b>
	-	-	-	-	-

LTE Band 14 Uplink					
Bandwidth (MHz)	Channel	Frequency (MHz)	Average Power (dBm)	PK Power (dBm)	Total Average Power of MIMO Ports (dBm)
5	23305	790.5	21.96	32.09	24.96
	23330	793.0	21.96	32.20	24.96
	<b>23355</b>	<b>795.5</b>	<b>21.99</b>	32.23	<b>24.99</b>
10	-	-	-	-	-
	23330	793.0	21.45	31.71	24.45
	-	-	-	-	-



2.1.9 Sample Test Plot

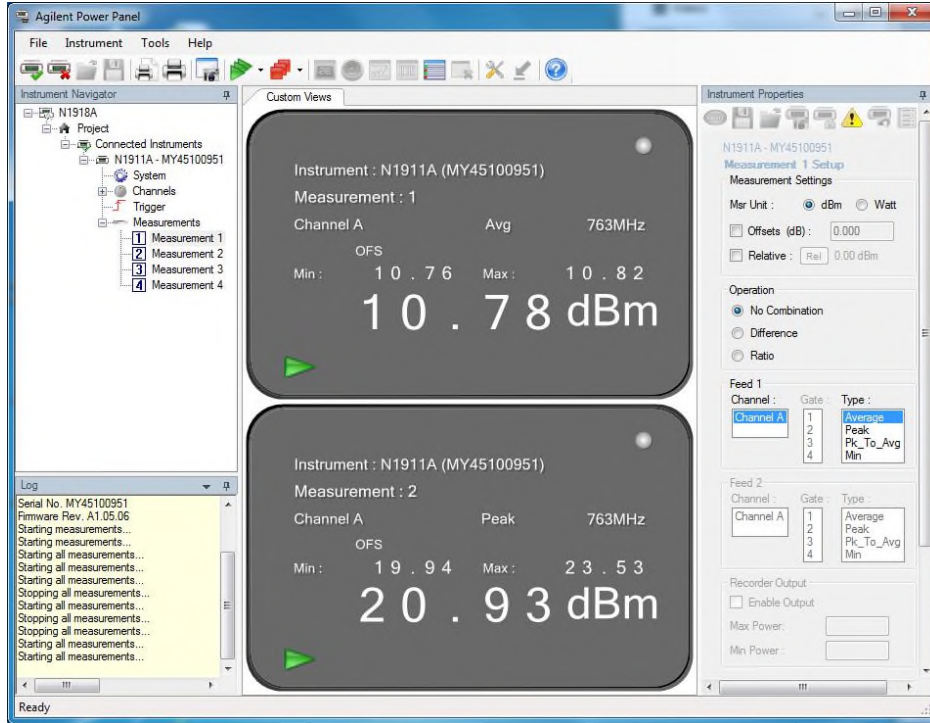

LTE Band 14 DL 5MHz Bandwidth Middle Channel

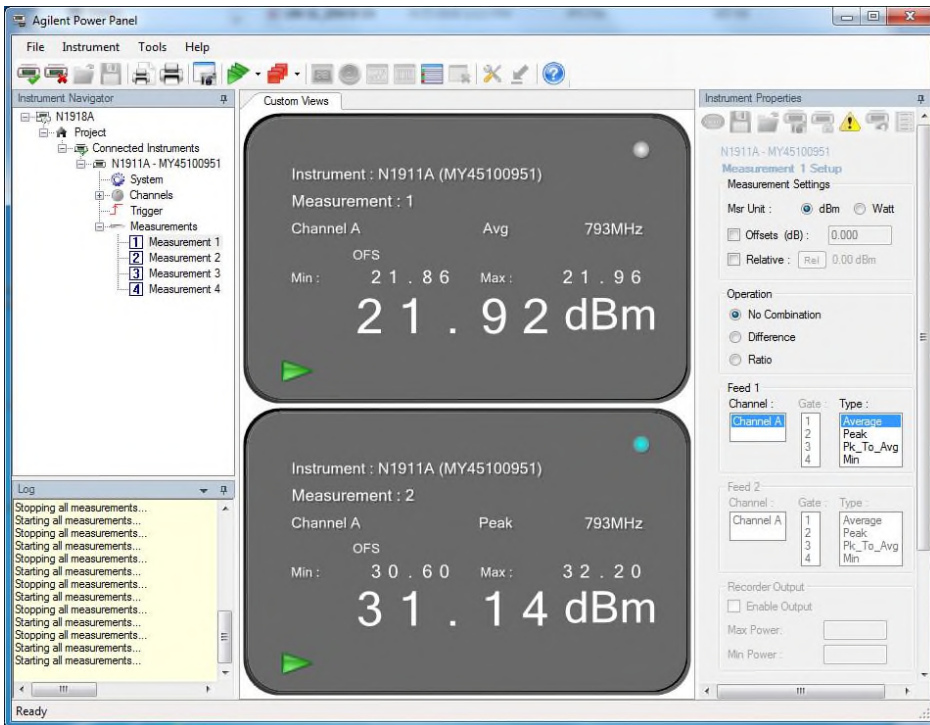

LTE Band 14 UL 5MHz Bandwidth Middle Channel



## **2.2 EFFECTIVE RADIATED POWER**

### **2.2.1 Specification Reference**

FCC 47 CFR Part 90, Clause 90.219(e)(1),  
FCC 47 CFR Part 90, Clause 90.542(a)(3),  
RSS-140 issue 1, Clause 4.3

### **2.2.2 Standard Applicable**

FCC 47 CFR Part 90, Clause 90.219(e):

- 1) The output power capability of a signal booster must be designed for deployments providing a radiated power not exceeding 5 Watts ERP for each retransmitted channel.

FCC 47 CFR Part 90, Clause 90.542:

(a) The following power limits apply to the 758–768/788–798 MHz band:

(3) Fixed and base stations transmitting a signal in the 758–768 MHz band with an emission bandwidth greater than 1 MHz must not exceed an ERP of 1000 watts/MHz and an antenna height of 305 m HAAT, except that antenna heights greater than 305 m HAAT are permitted if power levels are reduced below 1000 watts/MHz ERP accordance with Table 3 of this section.

RSS-140 Clause 4.3 Transmitter Output Power:

The equivalent radiated power (e.r.p.) for control and mobile equipment shall not exceed 30 W. The e.r.p. for portable equipment including handheld devices shall not exceed 3 W.

Fixed and base station equipment shall comply with the e.r.p. limits in SRSP-540.

### **2.2.3 Equipment Under Test and Modification State**

Serial No: NU: 976036000256 and CU: 977036000055 (Calculation only)

### **2.2.4 Date of Test/Initial of test personnel who performed the test**

October 22, 2020 / XYZ

### **2.2.5 Test Equipment Used**

The major items of test equipment used for the above tests are identified in Section 3.1.

### **2.2.6 Environmental Conditions/ Test Location**

Test performed at TÜV SÜD America Inc. Rancho Bernardo facility

Ambient Temperature	23.2 °C
Relative Humidity	48.7 %
ATM Pressure	98.7 kPa



**2.2.7 Additional Observations**

- ERP and EIRP were calculated as per Section 1.2 and 1.3 of KDB412172 D01 (Determining ERP and EIRP v01).
- Calculation formula in logarithmic terms:

$$\text{ERP or EIRP} = P_T + G_T - L_C$$

Where:

$P_T$  = transmitter output power, expressed in dBm (Section 2.1 of this test report)

$G_T$  = gain of the transmitting antenna, in dBd (ERP) or dBi (EIRP);

$$G_T(\text{dBd}) = G_T(\text{dBi}) - 2.15 \text{ dB}$$

$L_C$  = signal attenuation in the connecting cable between the transmitter and antenna, in dB.

- Since the EUT Downlink transmits on two internal antennas simultaneously in the same frequency range, i.e. TX MIMO mode, the total ERP was adjusted with a correction of 3 dB [10Log(2)] by using Measure and Add 10Log(N) dB technique according to FCC KDB 662911 D01 Multiple Transmitter Output accounting for simultaneous transmission from two internal antenna ports.

**2.2.8 Sample Computation**

$$\begin{aligned} \text{ERP} &= P_T + G_T - L_C - 2.15\text{dB} \\ &= 29.87 \text{ (Peak)} + 0.13 \text{ (max. gain)} - 3.84 \text{ (cable loss)} - 2.15 \\ &= 24.01 \text{ dBm} \end{aligned}$$

**2.2.9 Test Results**

LTE Band 14 Downlink						
Bandwidth (MHz)	Frequency (MHz)	Max Power Average (dBm)	Antenna Gain (dBi)	ERP (dBm)	Total ERP of MIMO Ports (dBm)	Limit (dBm)
5	760.5	10.89	6.5	15.24	18.24	36.99
	763.0	10.82	6.5	15.17	18.17	36.99
	765.5	10.73	6.5	15.08	18.08	36.99
10	-	-	-	-	-	-
	<b>763.0</b>	<b>13.53</b>	<b>6.5</b>	<b>17.88</b>	<b>20.88</b>	<b>36.99</b>
	-	-	-	-	-	-

LTE Band 14 Uplink						
Bandwidth (MHz)	Frequency (MHz)	Max Power Average (dBm)	Antenna Gain (dBi)	ERP (dBm)	Total ERP of MIMO Ports (dBm)	Limit (dBm)
5	790.5	21.96	6.5	26.31	29.31	36.99
	793.0	21.96	6.5	26.31	29.31	36.99
	<b>795.5</b>	<b>21.99</b>	<b>6.5</b>	<b>26.34</b>	<b>29.34</b>	<b>36.99</b>
10	-	-	-	-	-	-
	793.0	21.45	6.5	25.80	28.80	36.99
	-	-	-	-	-	-



## 2.3 OCCUPIED BANDWIDTH

### 2.3.1 Specification Reference

FCC 47 CFR Part 2, Clause 2.1049  
FCC 47 CFR Part 90, Clause 90.219(e)(4)  
RSS-GEN Issue 5, Clause 6.7

### 2.3.2 Standard Applicable

The transmitted signal bandwidth shall be reported as the 99% emission bandwidth, that is the frequency bandwidth such that, below its lower and above its upper frequency limits, the mean powers radiated are each equal to 0.5 percent of the total mean power radiated by a given emission.

Using the occupied bandwidth measurement function in the spectrum analyzer, the 99% occupied bandwidth was measured.

### 2.3.3 Equipment Under Test and Modification State

Serial No: NU: 976036000256 and CU: 977036000055 / Test Configuration A and B

### 2.3.4 Date of Test/Initial of test personnel who performed the test

September 29, 2020 / XYZ

### 2.3.5 Test Equipment Used

The major items of test equipment used for the above tests are identified in Section 3.1.

### 2.3.6 Environmental Conditions/ Test Location

Test performed at TÜV SÜD America Inc. Rancho Bernardo facility

Ambient Temperature	23.0 °C
Relative Humidity	57.6 %
ATM Pressure	98.9 kPa

### 2.3.7 Additional Observations

- This is a conducted test. Both 26dB bandwidth and 99% bandwidth presented.
- EUT Downlink transmits on two internal antennas and uplink transmits on two external antennas simultaneously in the same frequency range, i.e. TX MIMO mode. However, there is no much difference between two antenna ports and the measurement was performed on one antenna port as representative configuration.
- Using the occupied bandwidth measurement function in the spectrum analyzer, the 99% occupied bandwidth was measured.
- The 26dB bandwidth was measured in accordance with ANSI C63.26 clause 5.4.3 using the ndB measurement function in the spectrum analyzer.
- The transmitter shall be operated at its maximum carrier power measured under normal test conditions.
- The span of the analyzer shall be set to capture all products of the modulation process, including the emission skirts.
- The RBW is set to 1% of the OBW while the VBW is  $\geq 3X$  RBW.





- The detector is peak and the trace mode is max hold.
- All low, middle and high channels were verified. Only test plots for middle channel presented in this test report as the representative configuration.

**2.3.8 Test Results and Sample Test Plot**

LTE Band 14 Downlink				
Bandwidth (MHz)	Channel	Frequency (MHz)	OBW (MHz)	-26dB BW (MHz)
5	5305	760.5	4.41	4.82
	5330	763.0	4.44	4.84
	5355	765.5	4.40	4.83
10	-	-	-	-
	5330	763.0	8.70	9.25
	-	-	-	-

LTE Band 14 Uplink				
Bandwidth (MHz)	Channel	Frequency (MHz)	OBW (MHz)	-26dB BW (MHz)
5	23305	790.5	4.41	4.72
	23330	793.0	4.41	4.72
	23355	795.5	4.41	4.72
10	-	-	-	-
	23330	793.0	8.77	9.28
	-	-	-	-



**LTE Band 14 Downlink (5 MHz BW) / Middle Channel 763 MHz / 99%OBW**



10:47:20 29.09.2020

**LTE Band 14 Downlink (5 MHz BW) / Middle Channel 763 MHz / 26dB BW**



10:48:08 29.09.2020

**LTE Band 14 Downlink (10 MHz BW) / Middle Channel 763 MHz / 99%OBW**



10:42:02 29.09.2020

**LTE Band 14 Downlink (10 MHz BW) / Middle Channel 763 MHz / 26dB BW**



10:43:54 29.09.2020



**LTE Band 14 Uplink (5 MHz BW) / Middle Channel 793 MHz / 99%OBW**



09:48:04 29.09.2020

**LTE Band 14 Uplink (5 MHz BW) / Middle Channel 793 MHz / 26dB BW**



10:06:33 29.09.2020



**LTE Band 14 Uplink (10 MHz BW) / Middle Channel 793 MHz / 99%OBW**



10:31:28 29.09.2020

**LTE Band 14 Uplink (10 MHz BW) / Middle Channel 793 MHz / 26dB BW**



10:31:07 29.09.2020





## 2.4 PEAK-AVERAGE RATIO

### 2.4.1 Specification Reference

RSS-140 Issue 1, Clause 4.3

### 2.4.2 Standard Applicable

The peak-to-average power ratio (PAPR) of the transmitter shall not exceed 13 dB for more than 0.1% of the time and shall use a signal corresponding to the highest PAPR during periods of continuous transmission.

### 2.4.3 Equipment Under Test and Modification State

Serial No: NU: 976036000256 and CU: 977036000055 / Test Configuration A and B

### 2.4.4 Date of Test/Initial of test personnel who performed the test

September 29, 2020 / XYZ

### 2.4.5 Test Equipment Used

The major items of test equipment used for the above tests are identified in Section 3.1.

### 2.4.6 Environmental Conditions/ Test Location

Test performed at TÜV SÜD America Inc. Rancho Bernardo facility

Ambient Temperature	23.0 °C
Relative Humidity	57.6 %
ATM Pressure	98.9 kPa

### 2.4.7 Additional Observations

- This is a conducted test.
- EUT Downlink transmits on two internal antennas and uplink transmits on two external antennas simultaneously in the same frequency range, i.e. TX MIMO mode. However, there is no much difference between two antenna ports and the measurement was performed on one antenna port as representative configuration.
- Test procedure is per FCC KDB 971168 D01 v03r01 clause 5.7, the PAPR was measured in accordance with ANSI C63.26 clause 5.2.3.4.
- Measurement was done using the Spectrum Analyzer's Complementary Cumulative Distribution Function (CCDF) measurement profile. The built-in function is used to determine the largest deviation between the average and the peak power of the EUT in a given bandwidth (crest factor or peak-to-average ratio) A CCDF curve depicts the probability of the peak signal amplitude exceeding the average power level. Most contemporary measurement instrumentation include the capability to produce CCDF curves for an input signal provided that the instrument's resolution bandwidth can be set wide enough to accommodate the entire input signal bandwidth.
- RBW was set to maximum the SA can support.
- There are no measured PAR levels greater than 13dB.
- Low, Middle and High channels for all supporting bandwidths were verified.
- Only test plots for middle channel were presented as the representative configuration.



**2.4.8 Test Results**

LTE Band 14 Downlink			
Bandwidth (MHz)	Channels	Frequency (MHz)	PAR (dB)
5 MHz	5305	760.5	6.89
	5330	763.0	7.33
	5355	765.5	6.86
10 MHz	-	-	-
	5330	763.0	6.62
	-	-	-

LTE Band 14 Uplink			
Bandwidth (MHz)	Channels	Frequency (MHz)	PAR (dB)
5 MHz	23305	790.5	6.55
	23330	793.0	6.57
	23355	795.5	6.27
10 MHz	-	-	-
	23330	793.0	6.57
	-	-	-

2.4.9 Sample Test Plot

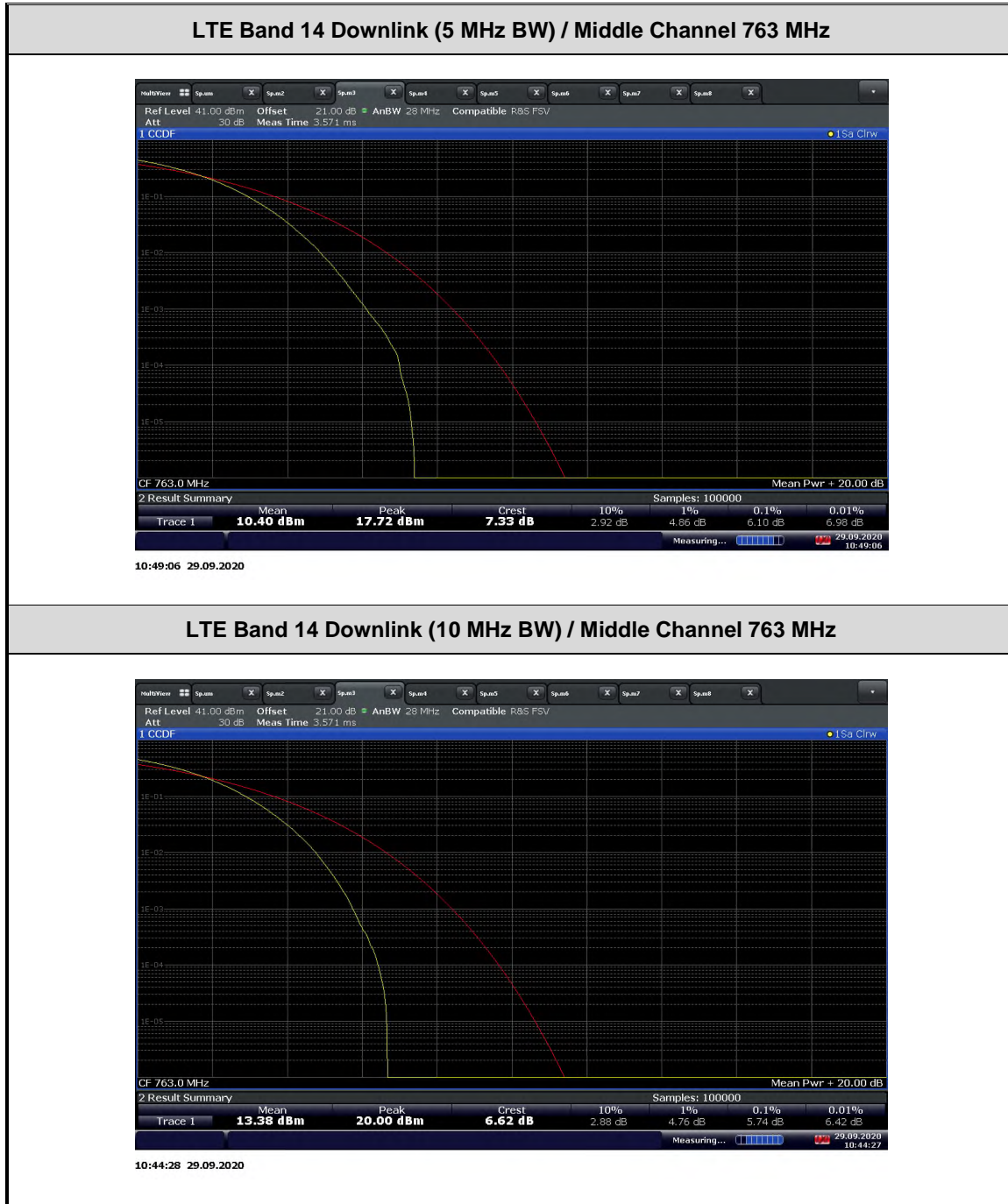



**LTE Band 14 Uplink (5 MHz BW) / Middle Channel 793 MHz**



08:57:17 29.09.2020

**LTE Band 14 Uplink (10 MHz BW) / Middle Channel 793 MHz**



10:31:47 29.09.2020



## 2.5 BAND EDGE

### 2.5.1 Specification Reference

FCC 47 CFR Part 2, Clause 2.1051  
FCC 47 CFR Part 90, Clause 90.543(e)  
RSS-140 issue 1, Clause 4.4

### 2.5.2 Standard Applicable

FCC 47 CFR Part 90, Clause 90.543:

(e) For operations in the 758–768 MHz and the 788–798 MHz bands, the power of any emission outside the licensee’s frequency band(s) of operation shall be attenuated below the transmitter power (P) within the licensed band(s) of operation, measured in watts, in accordance with the following:

(1) On all frequencies between 769–775 MHz and 799–805 MHz, by a factor not less than  $76 + 10 \log (P)$  dB in a 6.25 kHz band segment, for base and fixed stations.

(3) On any frequency between 775–788 MHz, above 805 MHz, and below 758 MHz, by at least  $43 + 10 \log (P)$  dB.

RSS-140:

4.4 Transmitter unwanted emissions limits

The power of any unwanted emission outside the bands 758-768 MHz and 788-798 MHz shall be attenuated below the transmitter output power P in dBW as follows, where p is the transmitter output power in watts:

a. For any frequency between 769-775 MHz and 799-806 MHz:

i  $76 + 10 \log (p)$ , dB in a 6.25 kHz band for fixed and base station equipment

ii  $65 + 10 \log (p)$ , dB in a 6.25 kHz band for mobile and portable/hand-held equipment

b For any frequency between 775-788 MHz, above 806 MHz, and below 758 MHz:  $43 + 10 \log (p)$ , dB in a bandwidth of 100 kHz or greater. However, in the 100 kHz bands immediately outside and adjacent to the frequency bands 758-768 MHz and 788-798 MHz, a resolution bandwidth of 30 kHz may be employed.

### 2.5.3 Equipment Under Test and Modification State

Serial No: NU: 976036000256 and CU: 977036000055 / Test Configuration A and B

### 2.5.4 Date of Test/Initial of test personnel who performed the test

October 02, 03 and 06, 2020 / XYZ

### 2.5.5 Test Equipment Used

The major items of test equipment used for the above tests are identified in Section 3.1.



### 2.5.6 Environmental Conditions/ Test Location

Test performed at TÜV SÜD America Inc. Rancho Bernardo facility

Ambient Temperature	23.5 - 24.5 °C
Relative Humidity	30.7 - 33.8 %
ATM Pressure	98.6 – 99.0 kPa

### 2.5.7 Additional Observations

- This is a conducted test.
- Test guidance is per Section 6.1 of KDB971168 (D01 Power Meas License Digital Systems v03r01).
- The path loss was measured and entered as a level offset.
- For LTE Band 14, RBW was set to 30 kHz and the limit for emissions 100 kHz outside of the low frequency edge and the high frequency edge of each frequency block range(s) was set to:

$$\text{Limit} = -13\text{dBm} + 10\lg(30/100) = -18.23 \text{ dBm}$$

- EUT Downlink transmits on two internal antennas and uplink transmits on two external antennas simultaneously in the same frequency range, i.e. TX MIMO mode. However, there is no much difference between two antenna ports and the measurement was performed on one antenna port as representative configuration. The limit should be adjusted with a correction of -3 dB [10Log(2)] by using Measure and Add 10Log(N) dB technique according to FCC KDB 662911 D01 Multiple Transmitter Output accounting for simultaneous transmission from two internal or external antenna ports.

2.5.8 Test Results

LTE Band 14 Downlink 5MHz Bandwidth Low Channel Band Edge

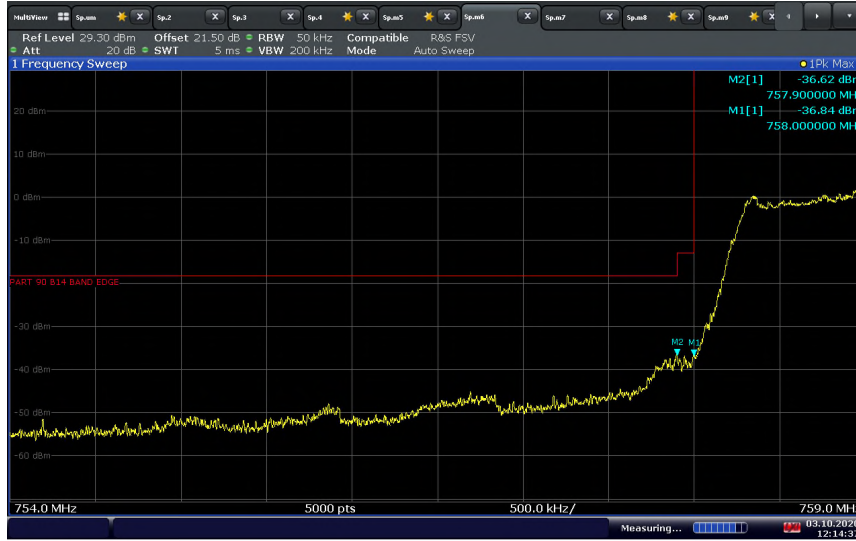

12:14:38 03.10.2020

The limit should be adjusted with a correction of -3 dB [10Log(2)]  
accounting for MIMO transmission on both internal antennas

LTE Band 14 Downlink 5MHz Bandwidth High Channel Band Edge

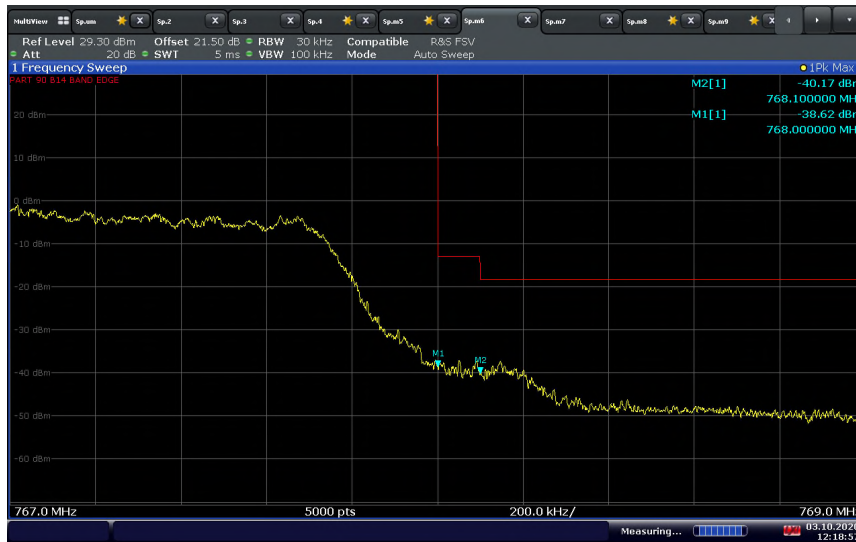

12:18:58 03.10.2020

The limit should be adjusted with a correction of -3 dB [10Log(2)]  
accounting for MIMO transmission on both internal antennas

**LTE Band 14 Downlink 10MHz Bandwidth Middle Channel Low Band Edge**

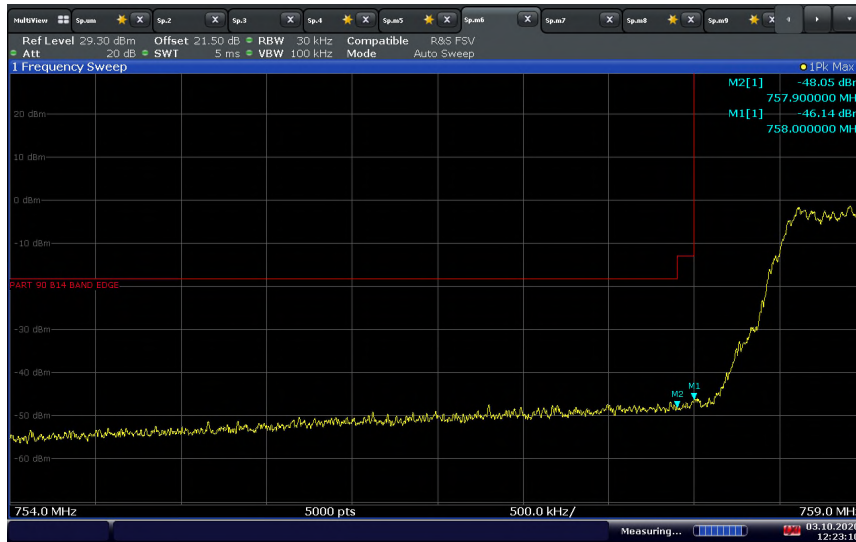

12:23:11 03.10.2020

The limit should be adjusted with a correction of -3 dB [10Log(2)]  
accounting for MIMO transmission on both internal antennas

**LTE Band 14 Downlink 10MHz Bandwidth Middle Channel High Band Edge**

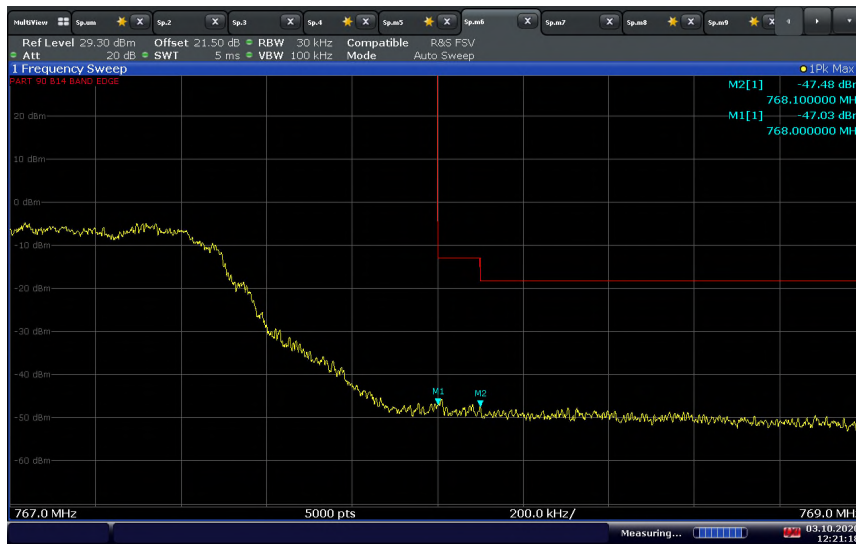

12:21:19 03.10.2020

The limit should be adjusted with a correction of -3 dB [10Log(2)]  
accounting for MIMO transmission on both internal antennas

### LTE Band 14 Uplink 5MHz Bandwidth Low Channel Band Edge

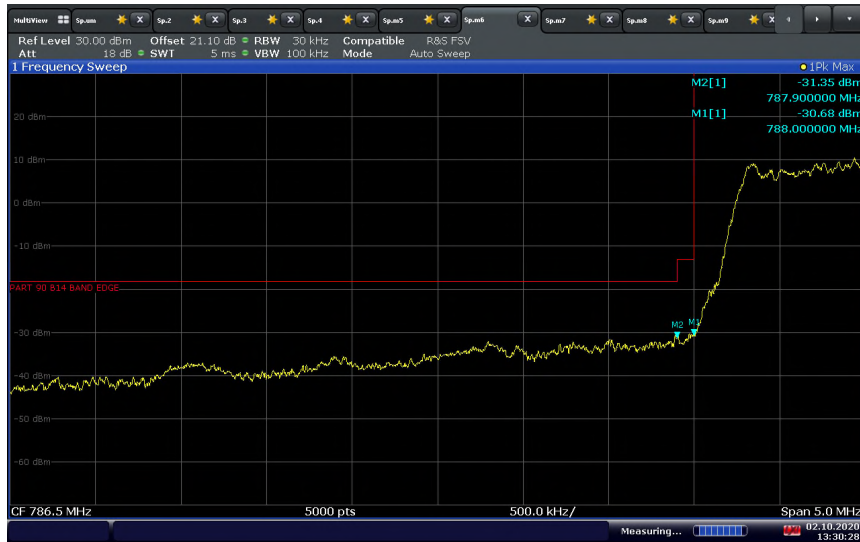

The limit should be adjusted with a correction of -3 dB  $[10\log(2)]$  accounting for MIMO transmission on both internal antennas

### LTE Band 14 Uplink 5MHz Bandwidth High Channel Band Edge

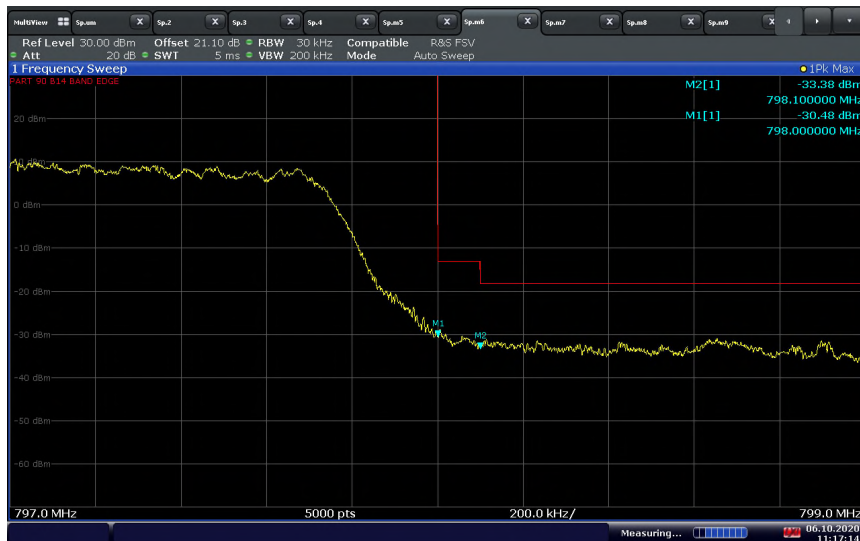

The limit should be adjusted with a correction of -3 dB  $[10\log(2)]$  accounting for MIMO transmission on both internal antennas



**LTE Band 14 Uplink 10MHz Bandwidth Middle Channel Low Band Edge**

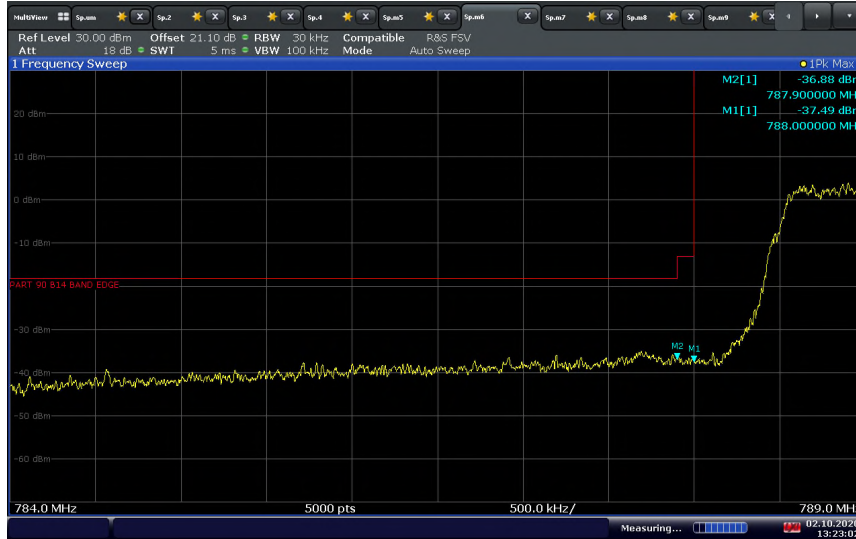

13:23:03 02.10.2020

The limit should be adjusted with a correction of -3 dB [10Log(2)]  
accounting for MIMO transmission on both internal antennas

**LTE Band 14 Uplink 10MHz Bandwidth Middle Channel High Band Edge**



12:28:26 03.10.2020

The limit should be adjusted with a correction of -3 dB [10Log(2)]  
accounting for MIMO transmission on both internal antennas



## 2.6 CONDUCTED SPURIOUS EMISSIONS

### 2.6.1 Specification Reference

FCC 47 CFR Part 2, Clause 2.1051  
 FCC 47 CFR Part 90, Clause 90.219(e)(3)  
 FCC 47 CFR Part 90, Clause 90.543(e)(1)(3)(f)  
 RSS-140 issue 1, Clause 4.4  
 KDB935210 D05, Clause 4.73

### 2.6.2 Standard Applicable

FCC 47 CFR Part 90, Clause 90.219(e):  
 (3) Spurious emissions from a signal booter must not exceed -13 dBm within any 100 kHz measurement bandwidth.

FCC 47 CFR Part 90, Clause 90.543:

(e) For operations in the 758–768 MHz and the 788–798 MHz bands, the power of any emission outside the licensee's frequency band(s) of operation shall be attenuated below the transmitter power (P) within the licensed band(s) of operation, measured in watts, in accordance with the following:

(1) On all frequencies between 769–775 MHz and 799–805 MHz, by a factor not less than  $76 + 10 \log (P)$  dB in a 6.25 kHz band segment, for base and fixed stations.

(3) On any frequency between 775–788 MHz, above 805 MHz, and below 758 MHz, by at least  $43 + 10 \log (P)$  dB.

(f) For operations in the 758–775 MHz and 788–805 MHz bands, all emissions including harmonics in the band 1559–1610 MHz shall be limited to -70 dBW/MHz equivalent isotropically radiated power (EIRP) for wideband signals, and -80 dBW EIRP for discrete emissions of less than 700 Hz bandwidth. For the purpose of equipment authorization, a transmitter shall be tested with an antenna that is representative of the type that will be used with the equipment in normal operation.

RSS-140:

4.4 Transmitter unwanted emissions limits

The power of any unwanted emission outside the bands 758-768 MHz and 788-798 MHz shall be attenuated below the transmitter output power P in dBW as follows, where p is the transmitter output power in watts:

a. For any frequency between 769-775 MHz and 799-806 MHz:

i  $76 + 10 \log (p)$ , dB in a 6.25 kHz band for fixed and base station equipment

ii  $65 + 10 \log (p)$ , dB in a 6.25 kHz band for mobile and portable/hand-held equipment

b For any frequency between 775-788 MHz, above 806 MHz, and below 758 MHz:  $43 + 10 \log (p)$ , dB in a bandwidth of 100 kHz or greater. However, in the 100 kHz bands immediately outside and adjacent to the frequency bands 758-768 MHz and 788-798 MHz, a resolution bandwidth of 30 kHz may be employed.

In addition, the equivalent isotropically radiated power (e.i.r.p.) of all emissions, including harmonics in the band 1559-1610 MHz, shall not exceed -70 dBW/MHz for wideband emissions, and -80 dBW/kHz for discrete emissions of less than 700 Hz bandwidth.

### 2.6.3 Equipment Under Test and Modification State

Serial No: NU: 976036000256 and CU: 977036000055 / Test Configuration A and B

Page 39 of 112





**2.6.4 Date of Test/Initial of test personnel who performed the test**

October 01 and 02, 2020 / XYZ

**2.6.5 Test Equipment Used**

The major items of test equipment used for the above tests are identified in Section 3.1.

**2.6.6 Environmental Conditions/ Test Location**

Test performed at TÜV SÜD America Inc. Rancho Bernardo facility

Ambient Temperature	23.4 - 23.5 °C
Relative Humidity	30.7 - 33.6 %
ATM Pressure	98.7 - 98.8 kPa

**2.6.7 Additional Observations**

- This is a conducted test.
- Test guidance is per Section 6.1 of KDB971168 (D01 Power Meas License Digital Systems v03r01).
- The transducer factor (TDF) used is from the external attenuators and cables used.
- EUT Downlink transmits on two internal antennas and uplink transmits on two external antennas simultaneously in the same frequency range, i.e. TX MIMO mode. However, there is no much difference between two antenna ports and the measurement was performed on one antenna port as representative configuration. The limit was adjusted with a correction of -3dB [10Log(2)] by using Measure and Add 10Log(N) dB technique according to FCC KDB 662911 D01 Multiple Transmitter Output accounting for simultaneous transmission from two internal or external antenna ports.
- Detector is peak and trace is set to max hold as the worst case setting.
- The spectrum was searched from 9 kHz to up to the 10<sup>th</sup> harmonic
- All low, middle and high channels for all supporting bandwidths were verified presented in this test report as representative configuration.

2.6.8 Test Results

LTE Band 14 Downlink 5MHz Bandwidth Low Channel Conducted Spurious Emissions

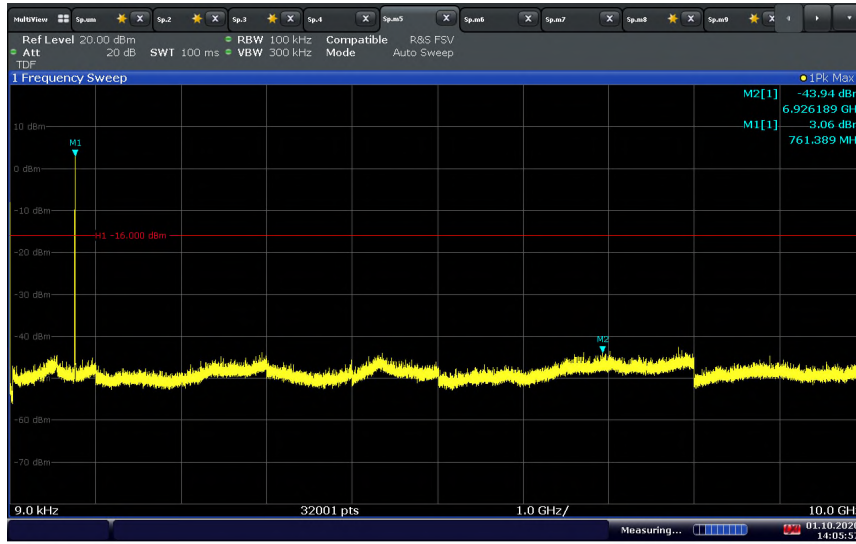

14:05:58 01.10.2020

LTE Band 14 Downlink 5MHz Bandwidth Low Channel Conducted Spurious Emissions  
769 – 775 MHz

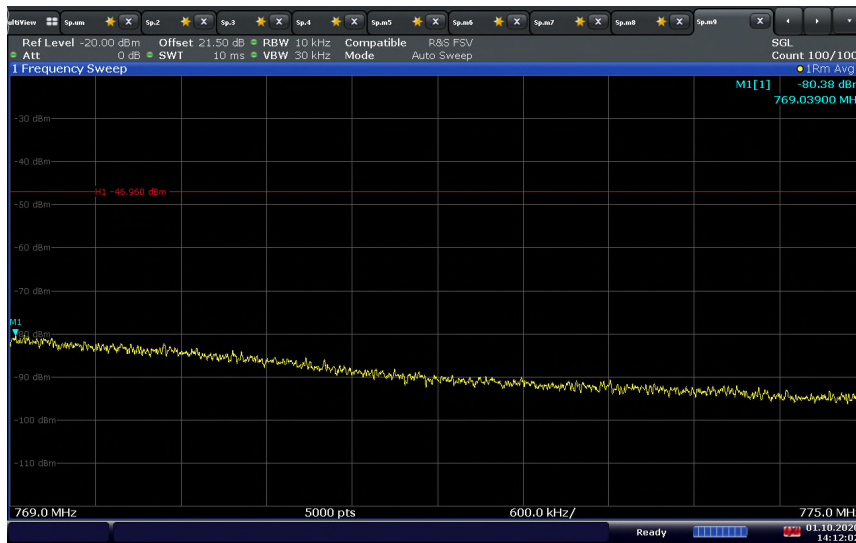

14:12:03 01.10.2020

$$\text{Limit} = -46 + 10\lg(10/6.25) - 3 = -46.96 \text{ dBm}$$



### LTE Band 14 Downlink 5MHz Bandwidth Low Channel Conducted Spurious Emissions 799 – 806 MHz

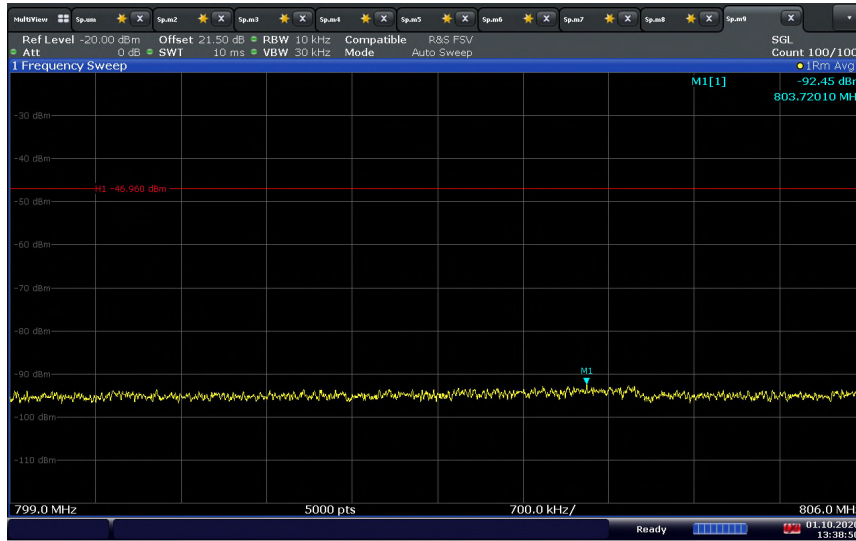

13:38:50 01.10.2020

$$\text{Limit} = -46 + 10\lg(10/6.25) - 3 = -46.96 \text{ dBm}$$

### LTE Band 14 Downlink 5MHz Bandwidth Low Channel Conducted Spurious Emissions 775 – 788 MHz

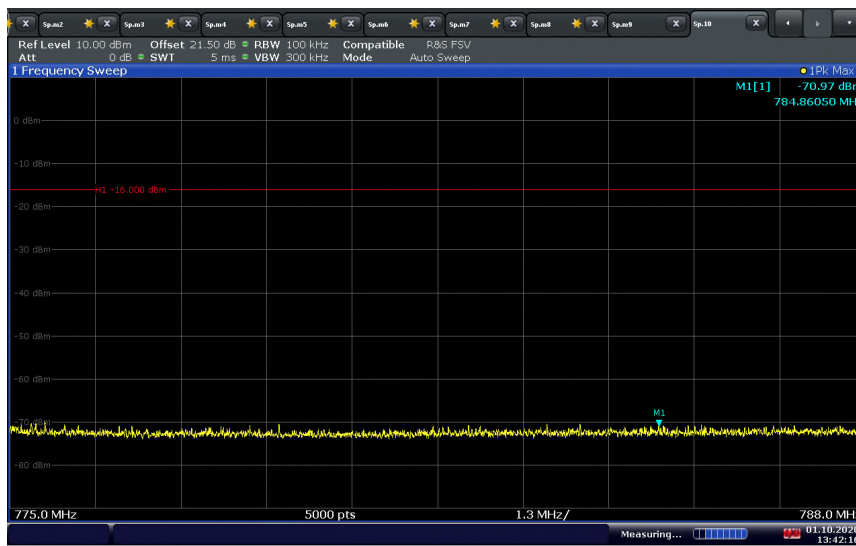

13:42:16 01.10.2020

**LTE Band 14 Downlink 5MHz Bandwidth Low Channel Conducted Spurious Emissions  
1559 – 1610 MHz (EIRP)**

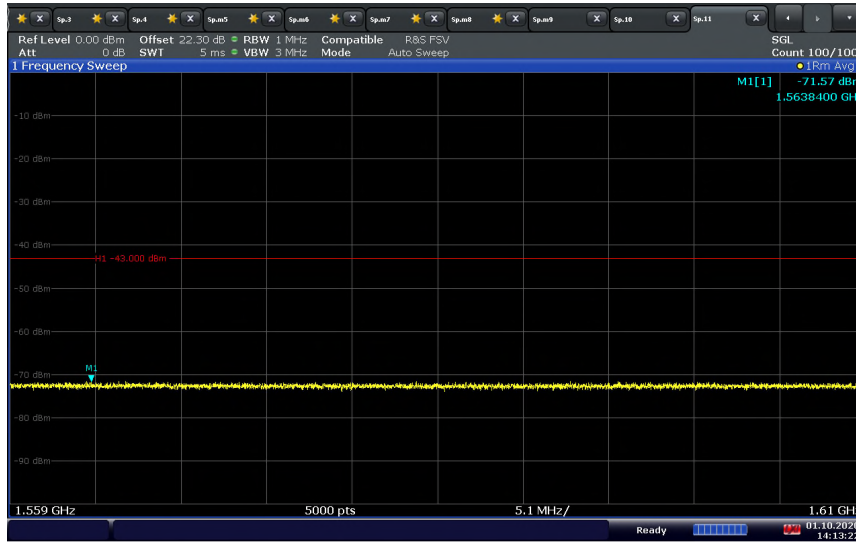

14:13:23 01.10.2020

The limit should be adjusted with a correction of -6.5 dB accounting for antenna gain.  
Limit = -43 - 6.5 = -49.5 dBm

**LTE Band 14 Downlink 5MHz Bandwidth Middle Channel Conducted Spurious Emissions**

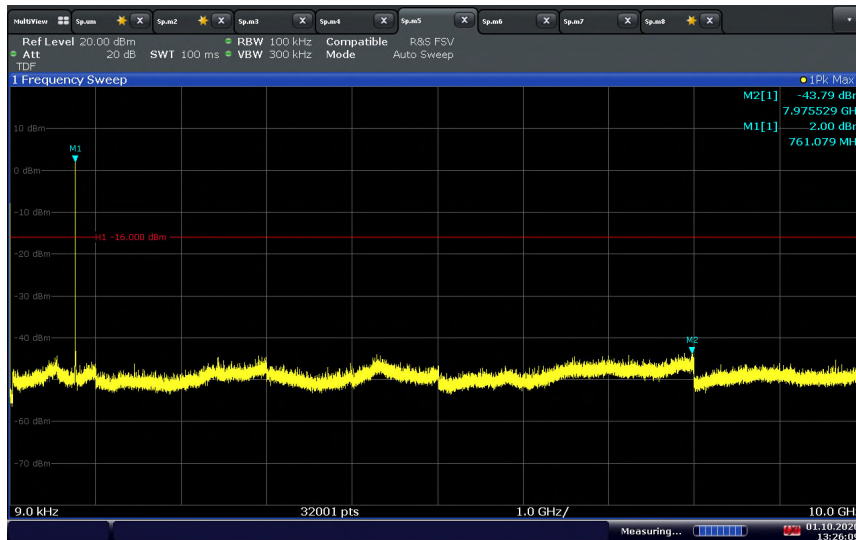

13:26:10 01.10.2020



**LTE Band 14 Downlink 5MHz Bandwidth Middle Channel Conducted Spurious Emissions  
769 – 775 MHz**

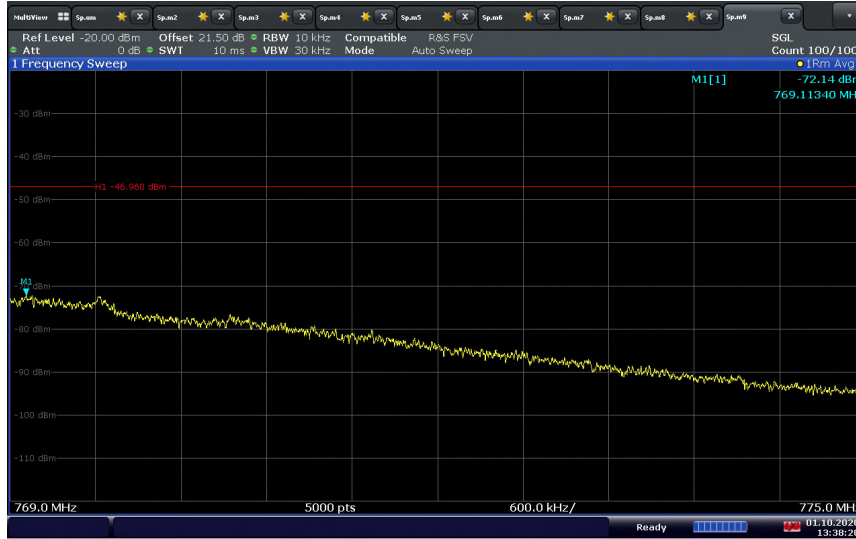

13:38:21 01.10.2020

$$\text{Limit} = -46 + 10\lg(10/6.25) - 3 = -46.96 \text{ dBm}$$

**LTE Band 14 Downlink 5MHz Bandwidth Middle Channel Conducted Spurious Emissions  
799 – 806 MHz**

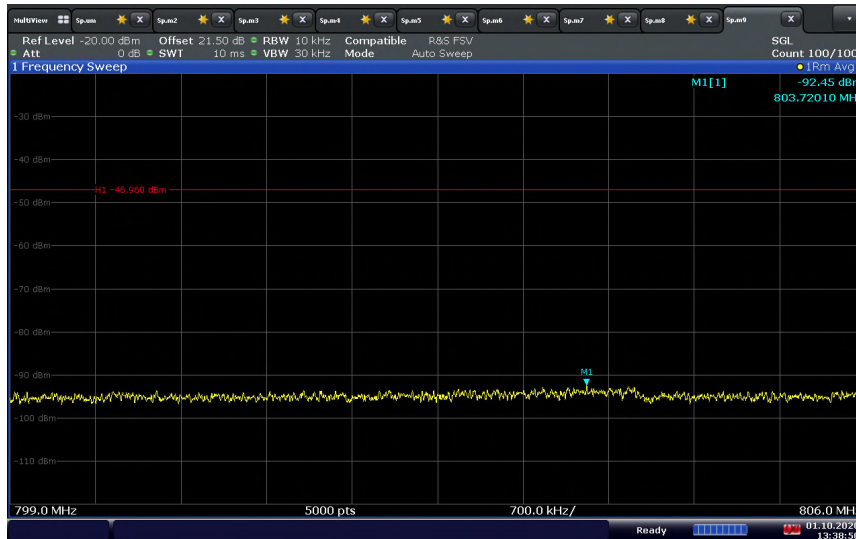

13:38:50 01.10.2020

$$\text{Limit} = -46 + 10\lg(10/6.25) - 3 = -46.96 \text{ dBm}$$

**LTE Band 14 Downlink 5MHz Bandwidth Middle Channel Conducted Spurious Emissions  
775 – 788 MHz**

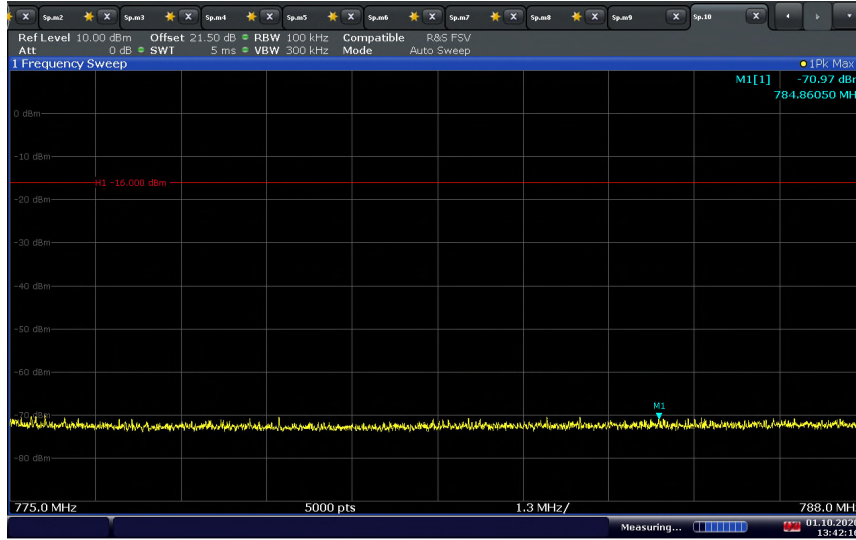

13:42:16 01.10.2020

**LTE Band 14 Downlink 5MHz Bandwidth Middle Channel Conducted Spurious Emissions  
1559 – 1610 MHz (EIRP)**

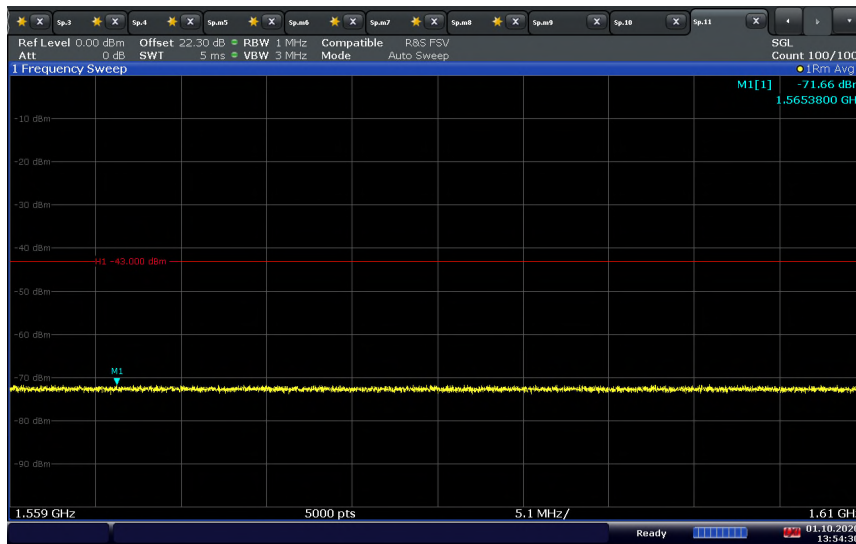

13:54:30 01.10.2020

The limit should be adjusted with a correction of -6.5 dB accounting for antenna gain.  
Limit = -43 - 6.5 = -49.5 dBm

**LTE Band 14 Downlink 5MHz Bandwidth High Channel Conducted Spurious Emissions**

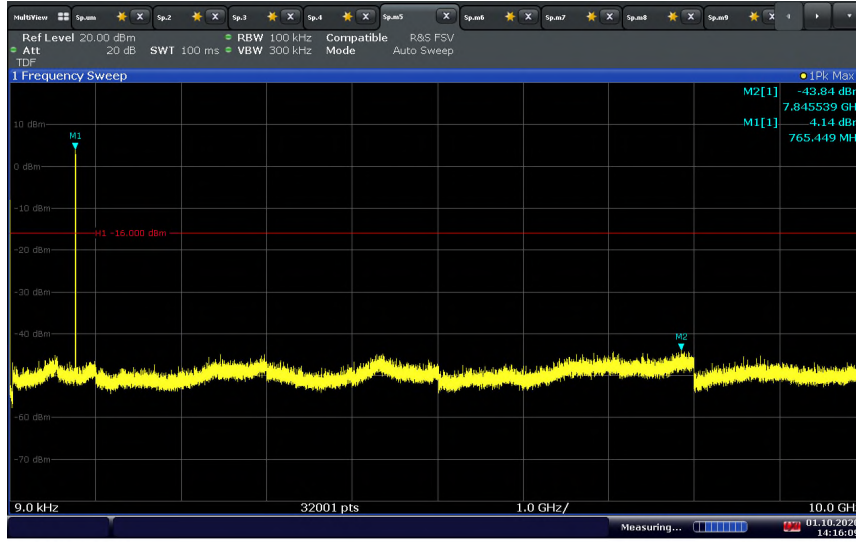

**LTE Band 14 Downlink 5MHz Bandwidth High Channel Conducted Spurious Emissions  
769 – 775 MHz**



$$\text{Limit} = -46 + 10\lg(10/6.25) - 3 = -46.96 \text{ dBm}$$





**LTE Band 14 Downlink 5MHz Bandwidth High Channel Conducted Spurious Emissions  
799 – 806 MHz**

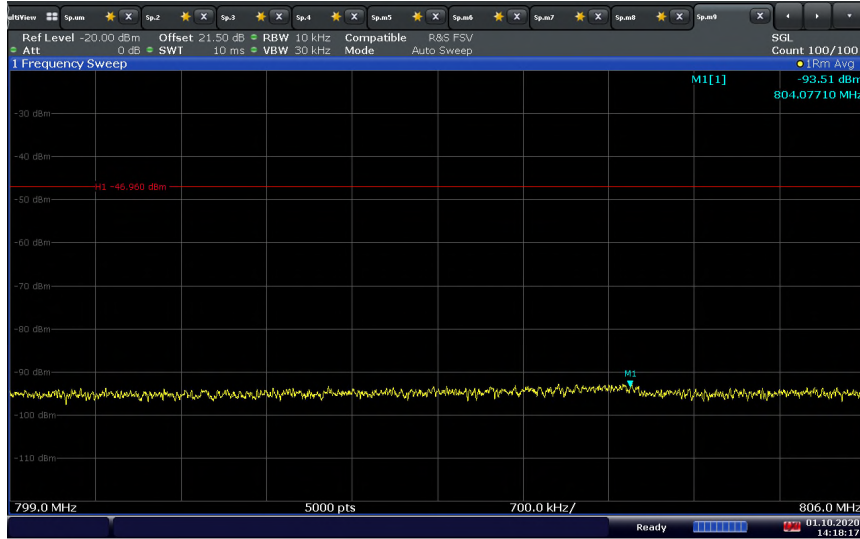

14:18:18 01.10.2020

$$\text{Limit} = -46 + 10\lg(10/6.25) - 3 = -46.96 \text{ dBm}$$

**LTE Band 14 Downlink 5MHz Bandwidth High Channel Conducted Spurious Emissions  
775 – 788 MHz**

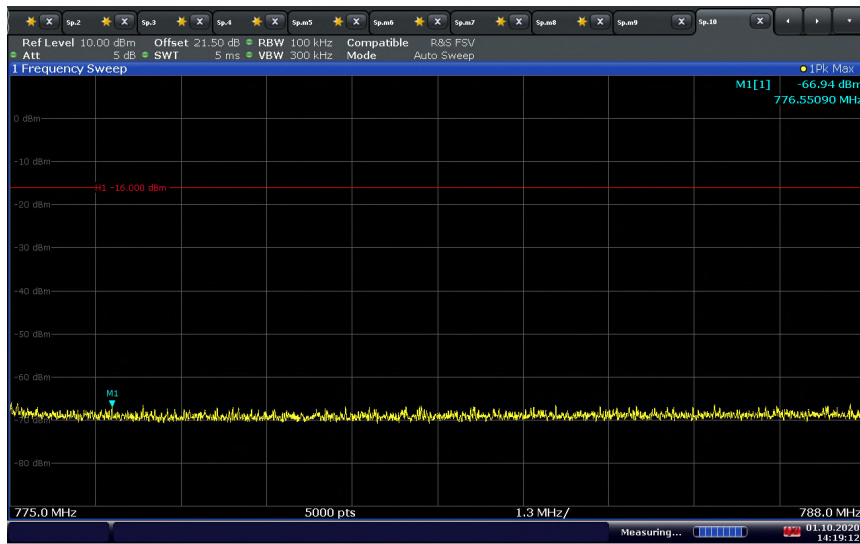

14:19:13 01.10.2020



**LTE Band 14 Downlink 5MHz Bandwidth High Channel Conducted Spurious Emissions  
1559 – 1610 MHz (EIRP)**

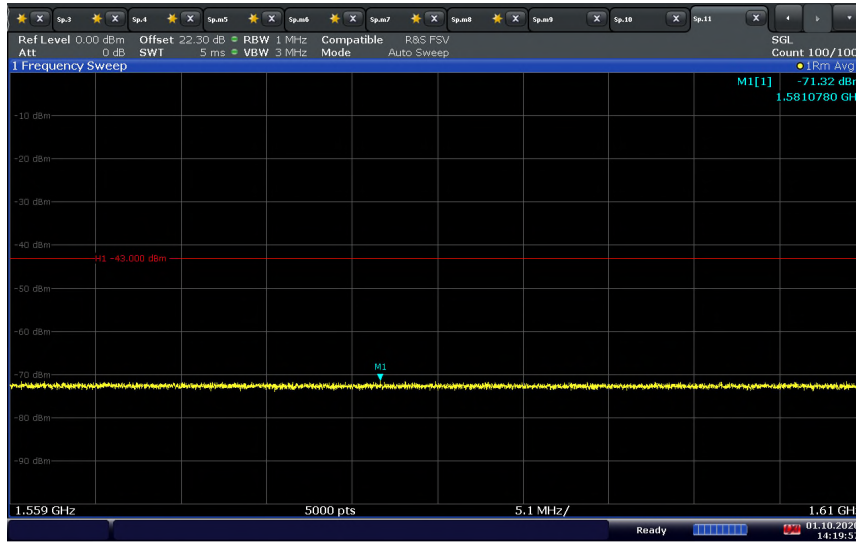

14:19:57 01.10.2020

The limit should be adjusted with a correction of -6.5 dB accounting for antenna gain.  
Limit = -43 - 6.5 = -49.5 dBm

**LTE Band 14 Downlink 10MHz Bandwidth Middle Channel Conducted Spurious Emissions**

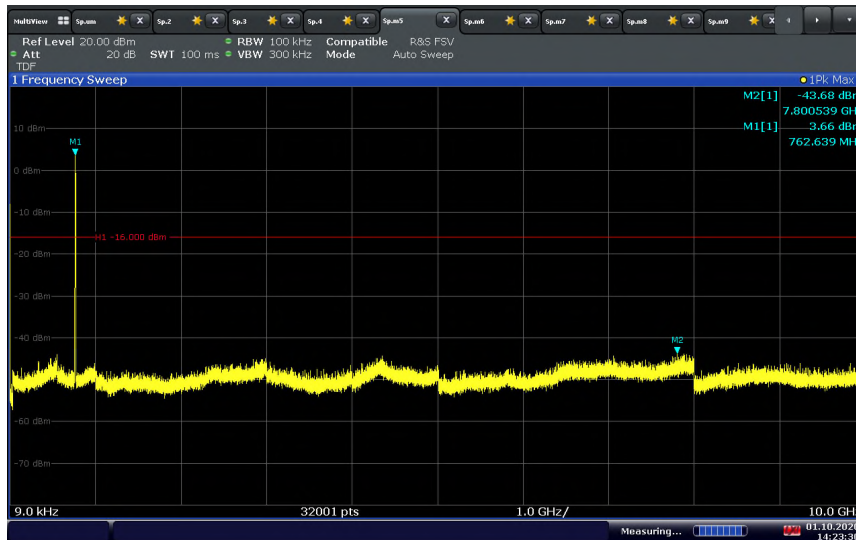

14:23:31 01.10.2020



**LTE Band 14 Downlink 10MHz Bandwidth Middle Channel Conducted Spurious Emissions  
769 – 775 MHz**

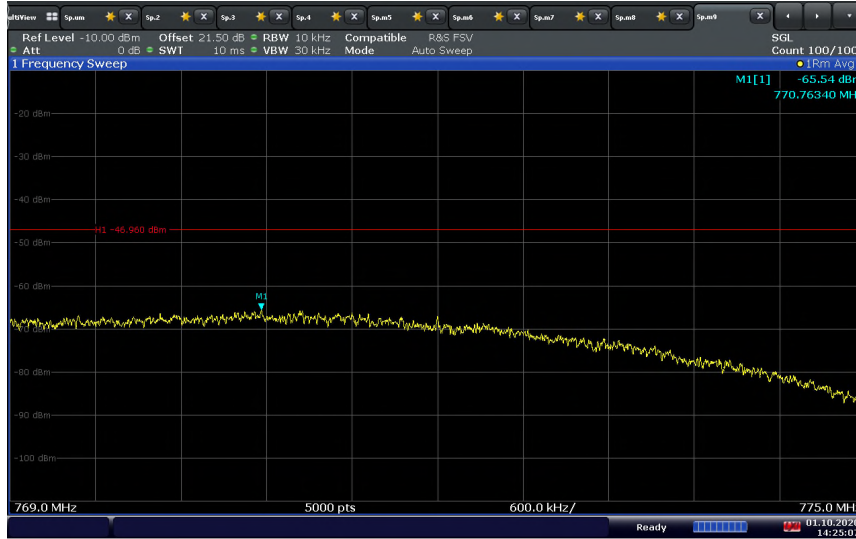

14:25:07 01.10.2020

$$\text{Limit} = -46 + 10\lg(10/6.25) - 3 = -46.96 \text{ dBm}$$

**LTE Band 14 Downlink 10MHz Bandwidth Middle Channel Conducted Spurious Emissions  
799 – 806 MHz**

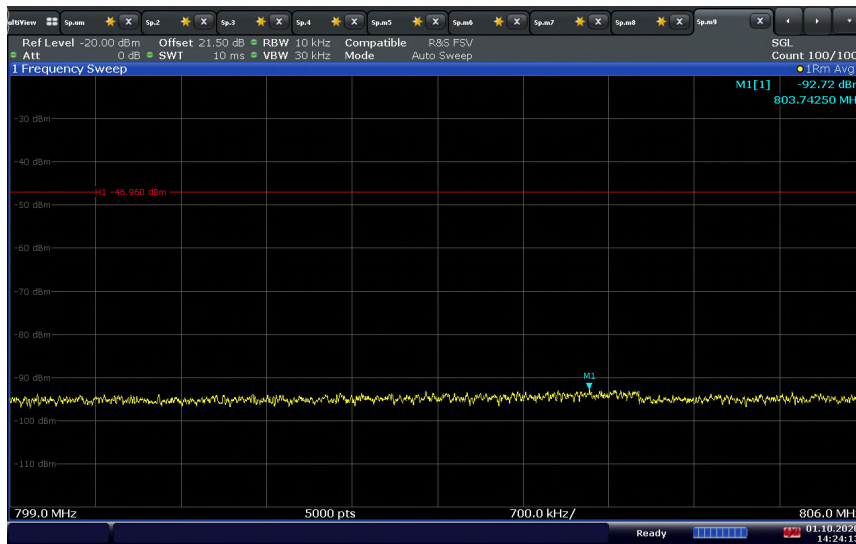

14:24:14 01.10.2020

$$\text{Limit} = -46 + 10\lg(10/6.25) - 3 = -46.96 \text{ dBm}$$

**LTE Band 14 Downlink 10MHz Bandwidth Middle Channel Conducted Spurious Emissions  
775 – 788 MHz**

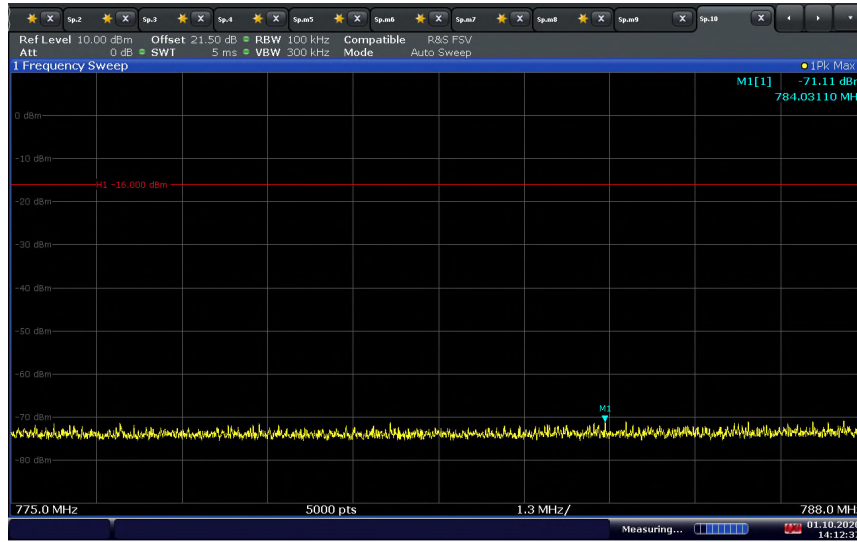

**LTE Band 14 Downlink 10MHz Bandwidth Middle Channel Conducted Spurious Emissions  
1559 – 1610 MHz (EIRP)**



The limit should be adjusted with a correction of -6.5 dB accounting for antenna gain.  
Limit = -43 - 6.5 = -49.5 dBm



**LTE Band 14 Uplink 5MHz Bandwidth Low Channel Conducted Spurious Emissions**

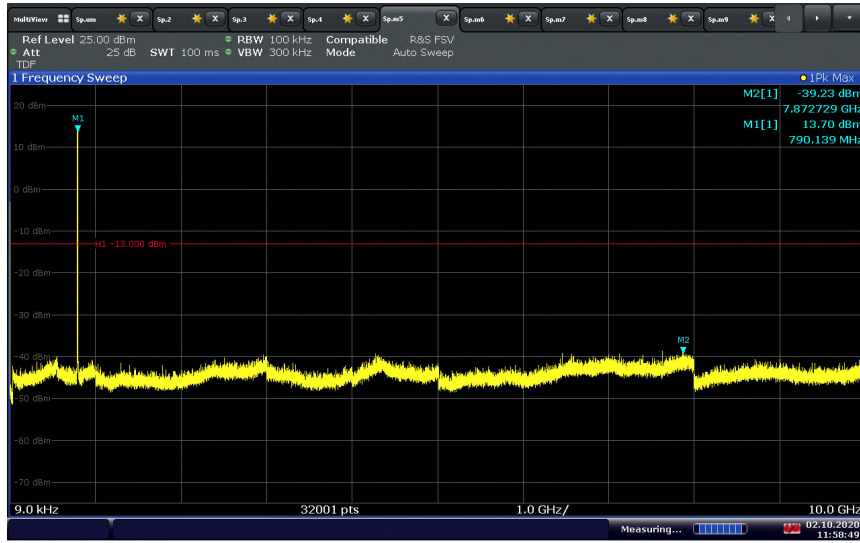

11:58:50 02.10.2020

The limit should be adjusted with a correction of -3 dB  $[10\text{Log}(2)]$  accounting for MIMO transmission on both external antennas  
 Limit = -13 - 3 = -16 dBm

**LTE Band 14 Uplink 5MHz Bandwidth Low Channel Conducted Spurious Emissions  
769 – 775 MHz**

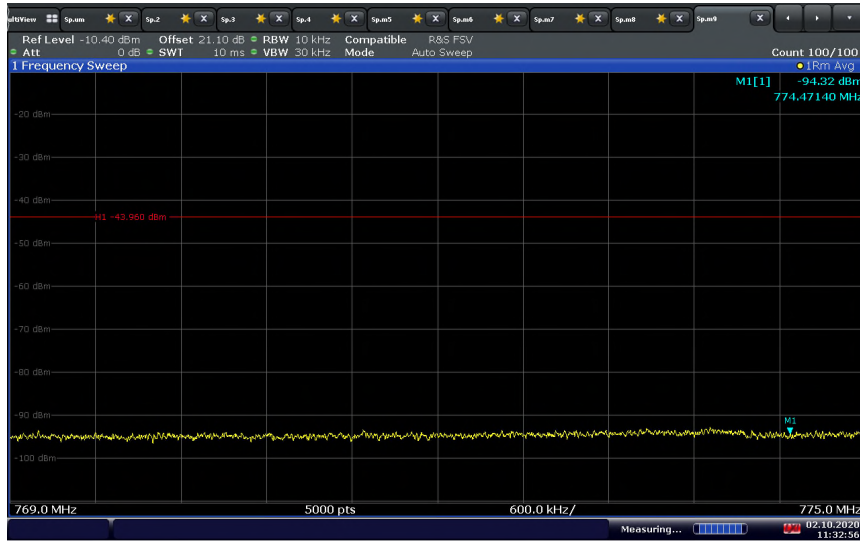

11:32:57 02.10.2020

The limit should be adjusted with a correction of -3 dB  $[10\text{Log}(2)]$  accounting for MIMO transmission on both external antennas  
 Limit = -46 +  $10\text{lg}(10/6.25)$  - 3 = -46.96 dBm

**LTE Band 14 Uplink 5MHz Bandwidth Low Channel Conducted Spurious Emissions  
799 – 806 MHz**

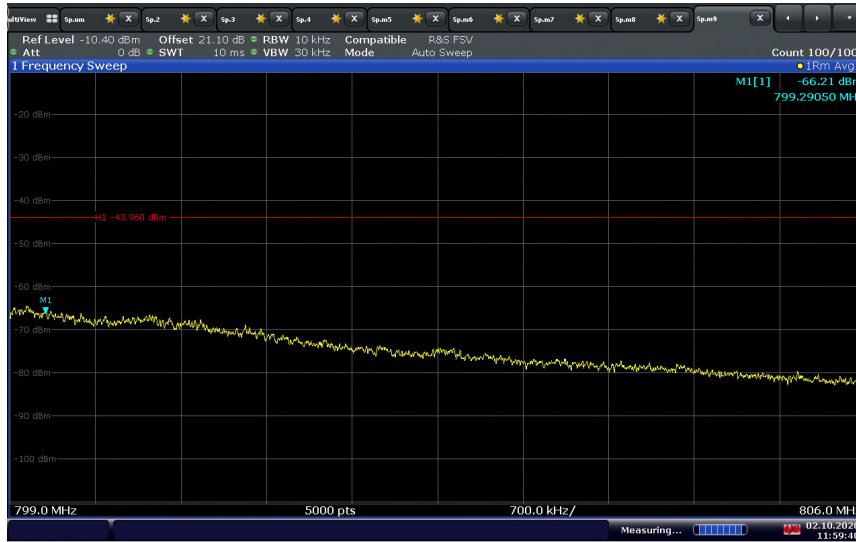

11:59:40 02.10.2020

The limit should be adjusted with a correction of -3 dB [10Log(2)]  
accounting for MIMO transmission on both external antennas  
Limit = -46 + 10lg (10/6.25) - 3 = -46.96 dBm

**LTE Band 14 Uplink 5MHz Bandwidth Low Channel Conducted Spurious Emissions  
775 – 788 MHz**



12:02:57 02.10.2020

The limit should be adjusted with a correction of -3 dB [10Log(2)]  
accounting for MIMO transmission on both external antennas  
Limit = -13 - 3 = -16 dBm

**LTE Band 14 Uplink 5MHz Bandwidth Low Channel Conducted Spurious Emissions  
1559 – 1610 MHz (EIRP)**

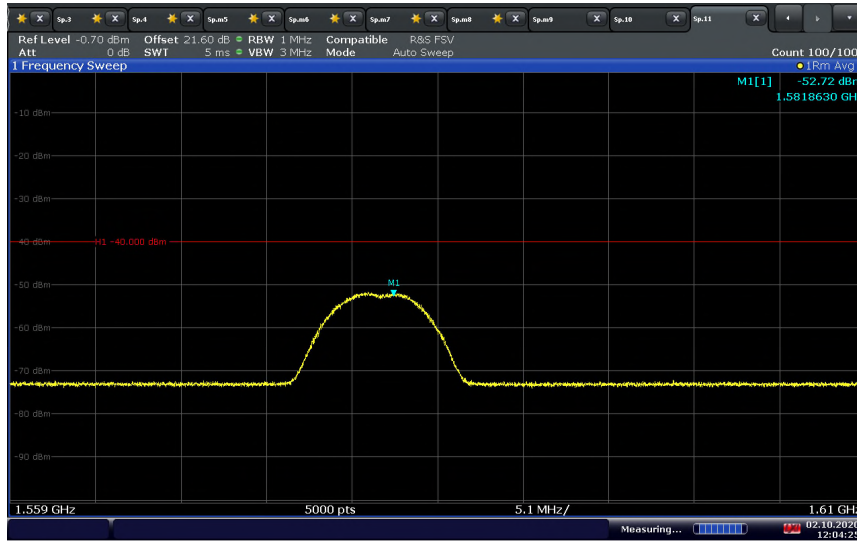

12:04:26 02.10.2020

The limit should be adjusted with a correction of -9.5 dB:  
-3 dB [10Log(2)] accounting for MIMO transmission on both external antennas,  
and -6.5 dB accounting for antenna gain.  
Limit = -40 - 9.5 = -49.5 dBm

**LTE Band 14 Uplink 5MHz Bandwidth Middle Channel Conducted Spurious Emissions**

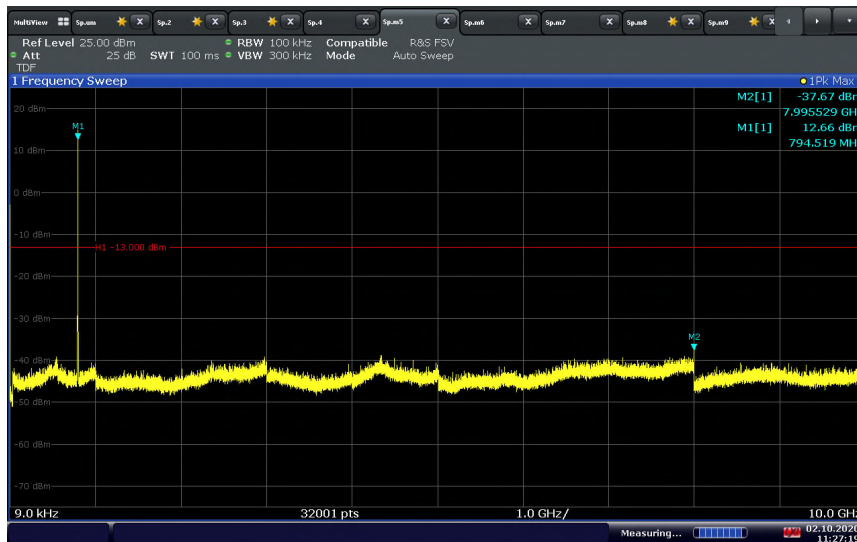

11:27:20 02.10.2020

The limit should be adjusted with a correction of -3 dB [10Log(2)]  
accounting for MIMO transmission on both external antennas  
Limit = -13 - 3 = -16 dBm





America

**LTE Band 14 Uplink 5MHz Bandwidth Middle Channel Conducted Spurious Emissions  
769 – 775 MHz**

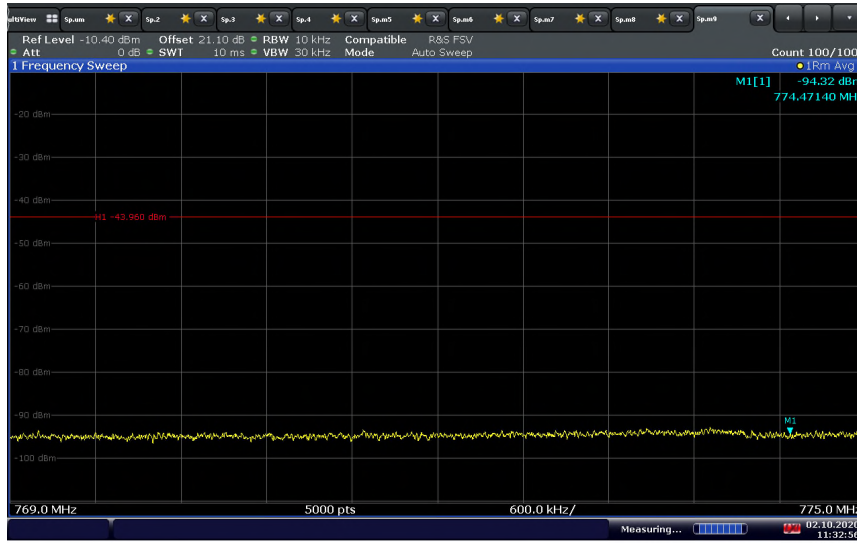

11:32:57 02.10.2020

The limit should be adjusted with a correction of -3 dB [10Log(2)]  
accounting for MIMO transmission on both external antennas  
Limit = -46 + 10lg (10/6.25) - 3 = -46.96 dBm

**LTE Band 14 Uplink 5MHz Bandwidth Middle Channel Conducted Spurious Emissions  
799 – 806 MHz**

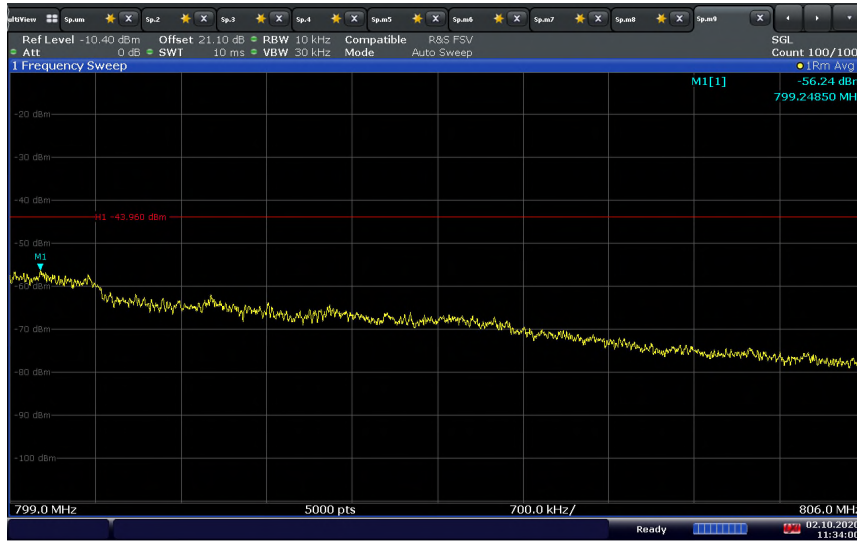

11:34:01 02.10.2020

The limit should be adjusted with a correction of -3 dB [10Log(2)]  
accounting for MIMO transmission on both external antennas  
Limit = -46 + 10lg (10/6.25) - 3 = -46.96 dBm



America

**LTE Band 14 Uplink 5MHz Bandwidth Middle Channel Conducted Spurious Emissions  
775 – 788 MHz**

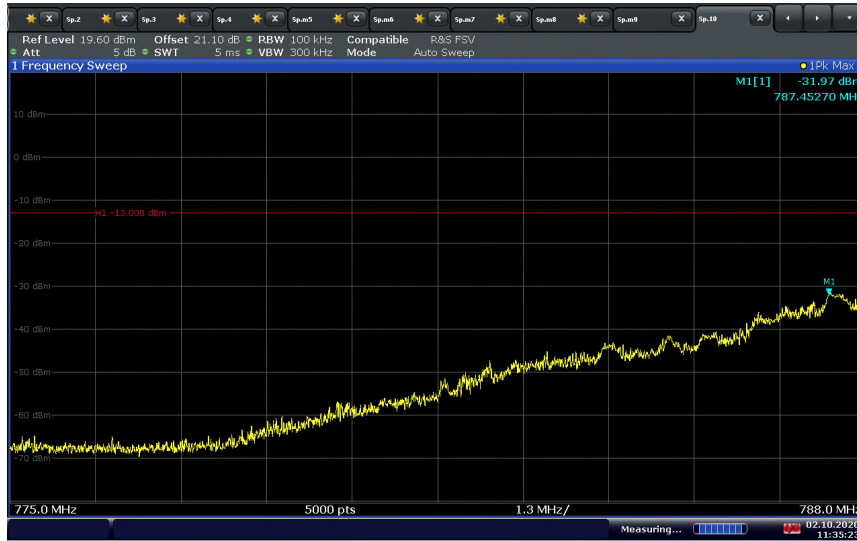

11:35:24 02.10.2020

The limit should be adjusted with a correction of -3 dB  $[10\text{Log}(2)]$   
accounting for MIMO transmission on both external antennas  
Limit = -13 - 3 = -16 dBm

**LTE Band 14 Uplink 5MHz Bandwidth Middle Channel Conducted Spurious Emissions  
1559 – 1610 MHz (EIRP)**

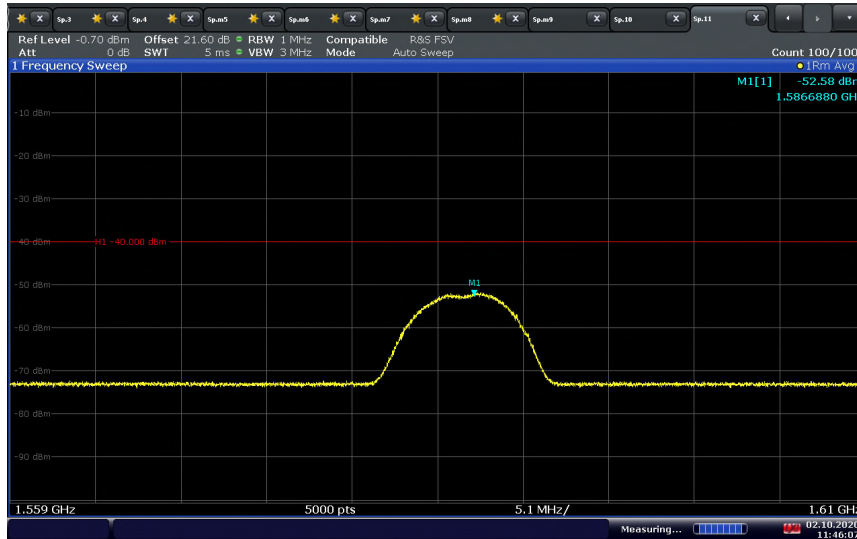

11:46:08 02.10.2020

The limit should be adjusted with a correction of -9.5 dB:  
-3 dB  $[10\text{Log}(2)]$  accounting for MIMO transmission on both external antennas,  
and -6.5 dB accounting for antenna gain.  
Limit = -40 - 9.5 = -49.5 dBm





America

**LTE Band 14 Uplink 5MHz Bandwidth High Channel Conducted Spurious Emissions**

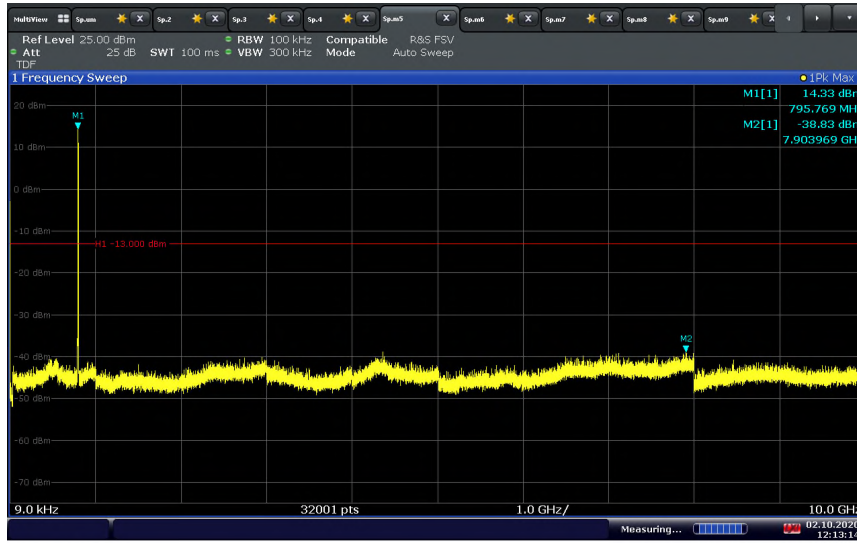

12:13:15 02.10.2020

The limit should be adjusted with a correction of -3 dB [10Log(2)]  
 accounting for MIMO transmission on both external antennas  
 Limit = -13 - 3 = -16 dBm

**LTE Band 14 Uplink 5MHz Bandwidth High Channel Conducted Spurious Emissions  
 769 – 775 MHz**

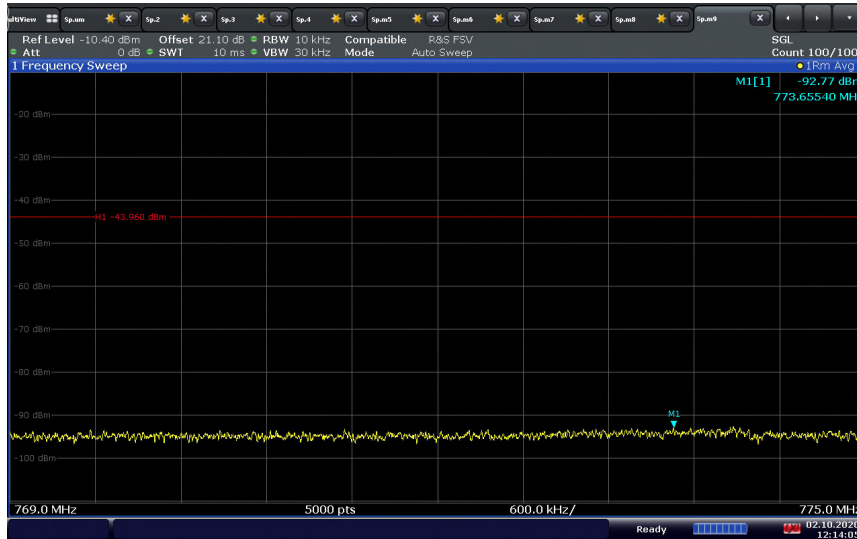

12:14:05 02.10.2020

The limit should be adjusted with a correction of -3 dB [10Log(2)]  
 accounting for MIMO transmission on both external antennas  
 Limit = -46 + 10lg (10/6.25) - 3 = -46.96 dBm

**LTE Band 14 Uplink 5MHz Bandwidth High Channel Conducted Spurious Emissions  
799 – 806 MHz**

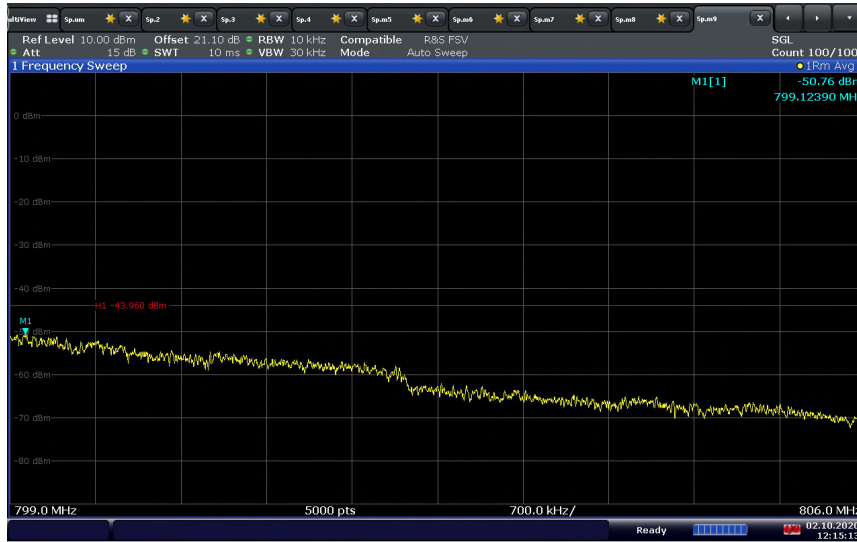

12:15:14 02.10.2020

The limit should be adjusted with a correction of -3 dB [10Log(2)]  
accounting for MIMO transmission on both external antennas  
Limit = -46 + 10lg (10/6.25) - 3 = -46.96 dBm

**LTE Band 14 Uplink 5MHz Bandwidth High Channel Conducted Spurious Emissions  
775 – 788 MHz**

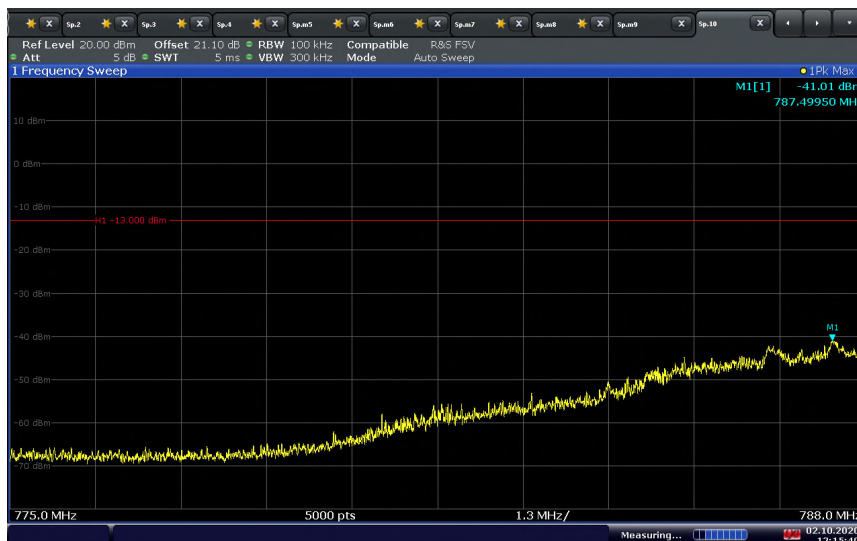

12:15:50 02.10.2020

The limit should be adjusted with a correction of -3 dB [10Log(2)]  
accounting for MIMO transmission on both external antennas  
Limit = -13 - 3 = -16 dBm



America

**LTE Band 14 Uplink 5MHz Bandwidth High Channel Conducted Spurious Emissions  
1559 – 1610 MHz (EIRP)**

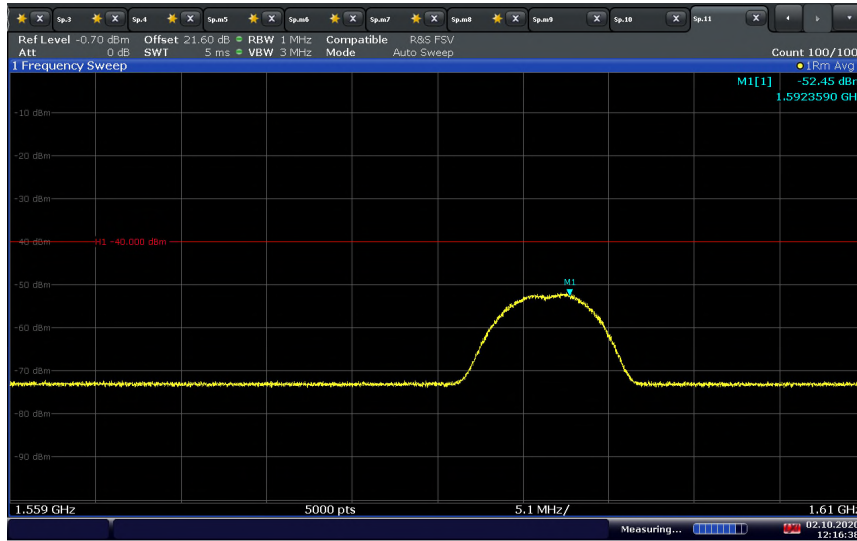

12:16:39 02.10.2020

The limit should be adjusted with a correction of -9.5 dB:  
-3 dB [10Log(2)] accounting for MIMO transmission on both external antennas,  
and -6.5 dB accounting for antenna gain.  
Limit = -40 - 9.5 = -49.5 dBm

**LTE Band 14 Uplink 10MHz Bandwidth Middle Channel Conducted Spurious Emissions**

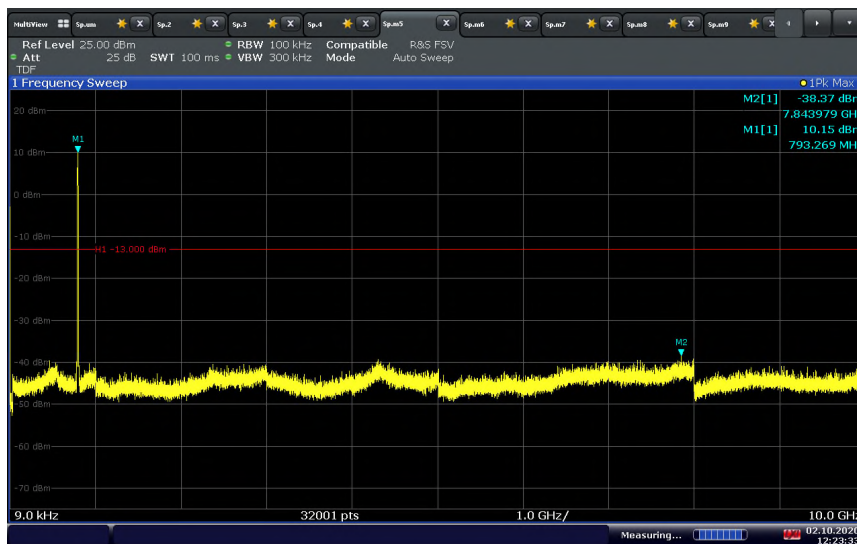

12:23:33 02.10.2020

The limit should be adjusted with a correction of -3 dB [10Log(2)]  
accounting for MIMO transmission on both external antennas  
Limit = -13 - 3 = -16 dBm



**LTE Band Up Downlink 10MHz Bandwidth Middle Channel Conducted Spurious Emissions  
769 – 775 MHz**

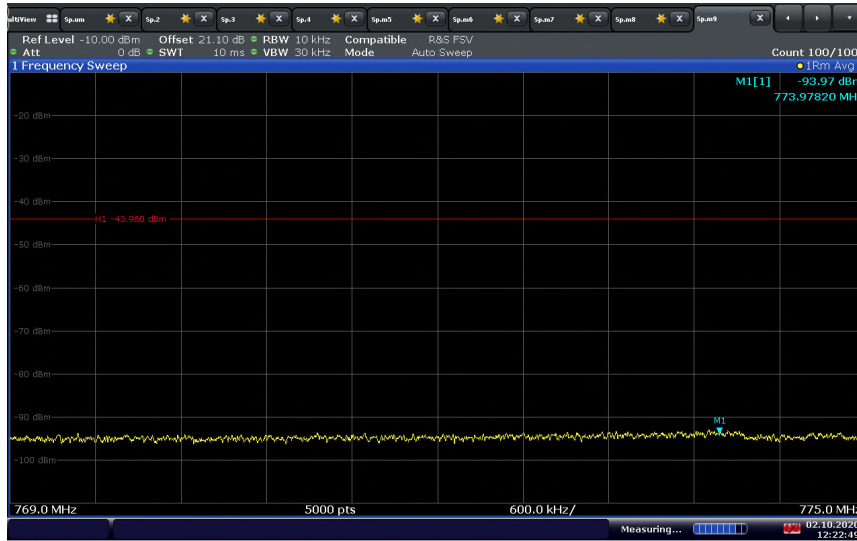

12:22:49 02.10.2020

The limit should be adjusted with a correction of -3 dB [10Log(2)]  
accounting for MIMO transmission on both external antennas  
Limit = -46 + 10lg (10/6.25) - 3 = -46.96 dBm

**LTE Band Up Downlink 10MHz Bandwidth Middle Channel Conducted Spurious Emissions  
799 – 806 MHz**

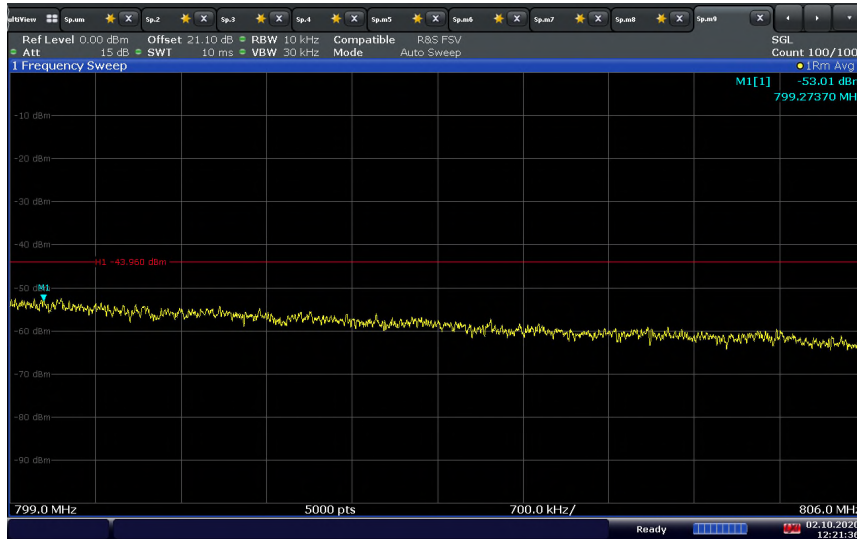

12:21:37 02.10.2020

The limit should be adjusted with a correction of -3 dB [10Log(2)]  
accounting for MIMO transmission on both external antennas  
Limit = -46 + 10lg (10/6.25) - 3 = -46.96 dBm



America

**LTE Band 14 Uplink 10MHz Bandwidth Middle Channel Conducted Spurious Emissions  
775 – 788 MHz**

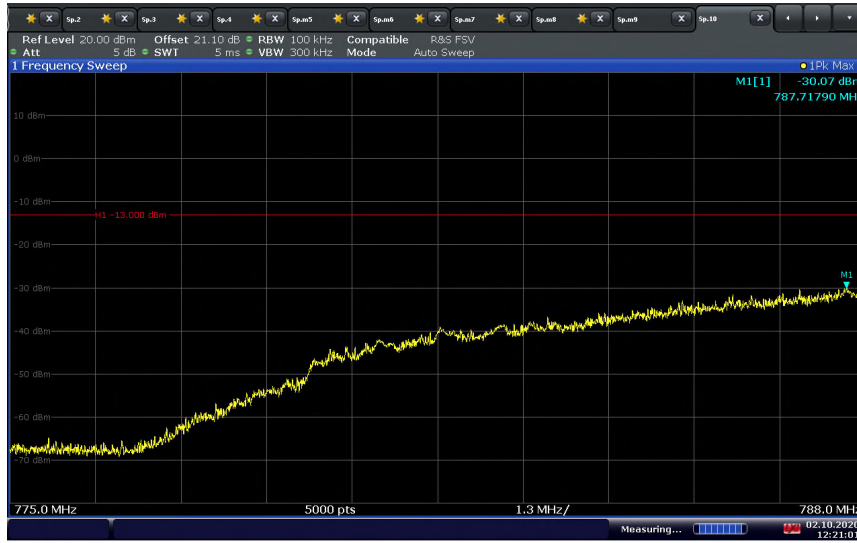

12:21:01 02.10.2020

The limit should be adjusted with a correction of -3 dB  $[10\text{Log}(2)]$  accounting for MIMO transmission on both external antennas  
 Limit = -13 - 3 = -16 dBm

**LTE Band 14 Uplink 10MHz Bandwidth Middle Channel Conducted Spurious Emissions  
1559 – 1610 MHz (EIRP)**

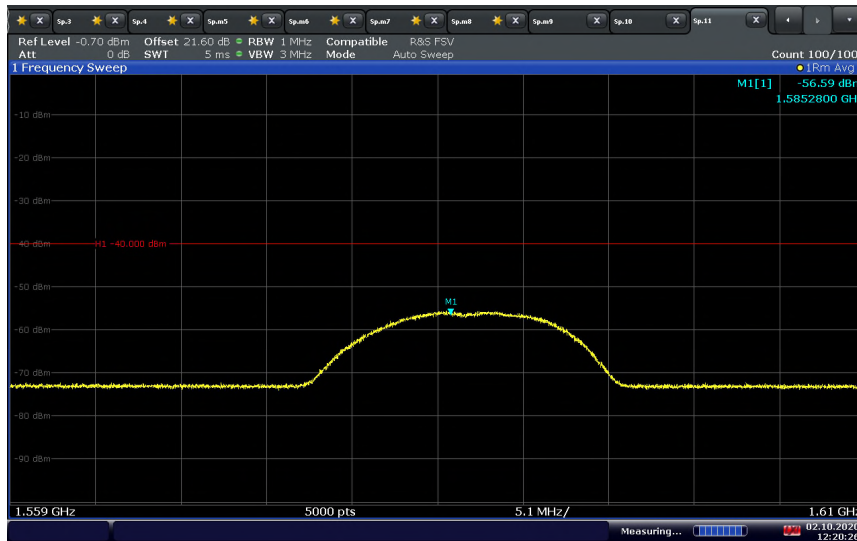

12:20:27 02.10.2020

The limit should be adjusted with a correction of -9.5 dB:  
 -3 dB  $[10\text{Log}(2)]$  accounting for MIMO transmission on both external antennas,  
 and -6.5 dB accounting for antenna gain.  
 Limit = -40 - 9.5 = -49.5 dBm