

## Internal Photos

CEL-FI Model #: QUATRA 4000  
 NU

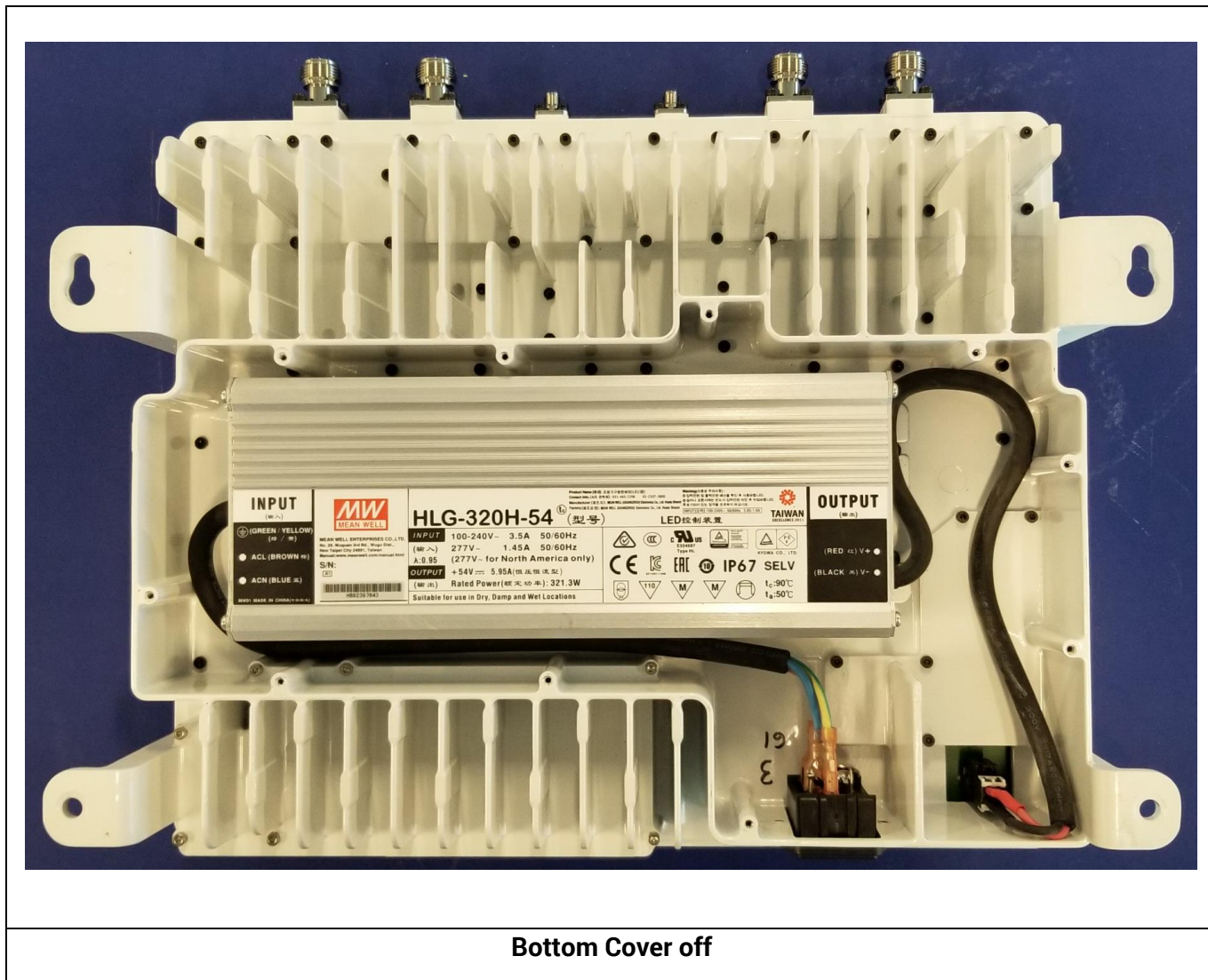

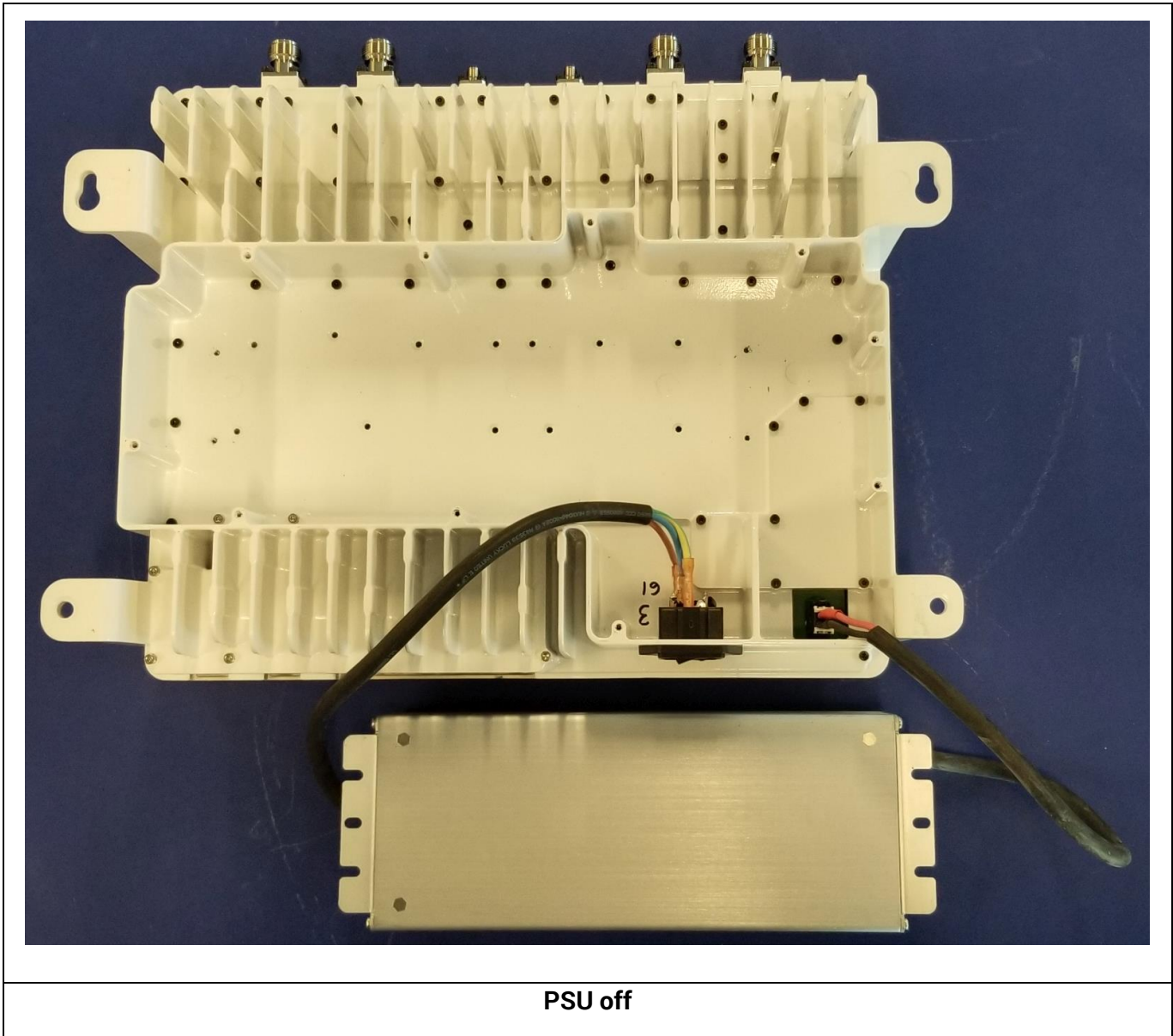



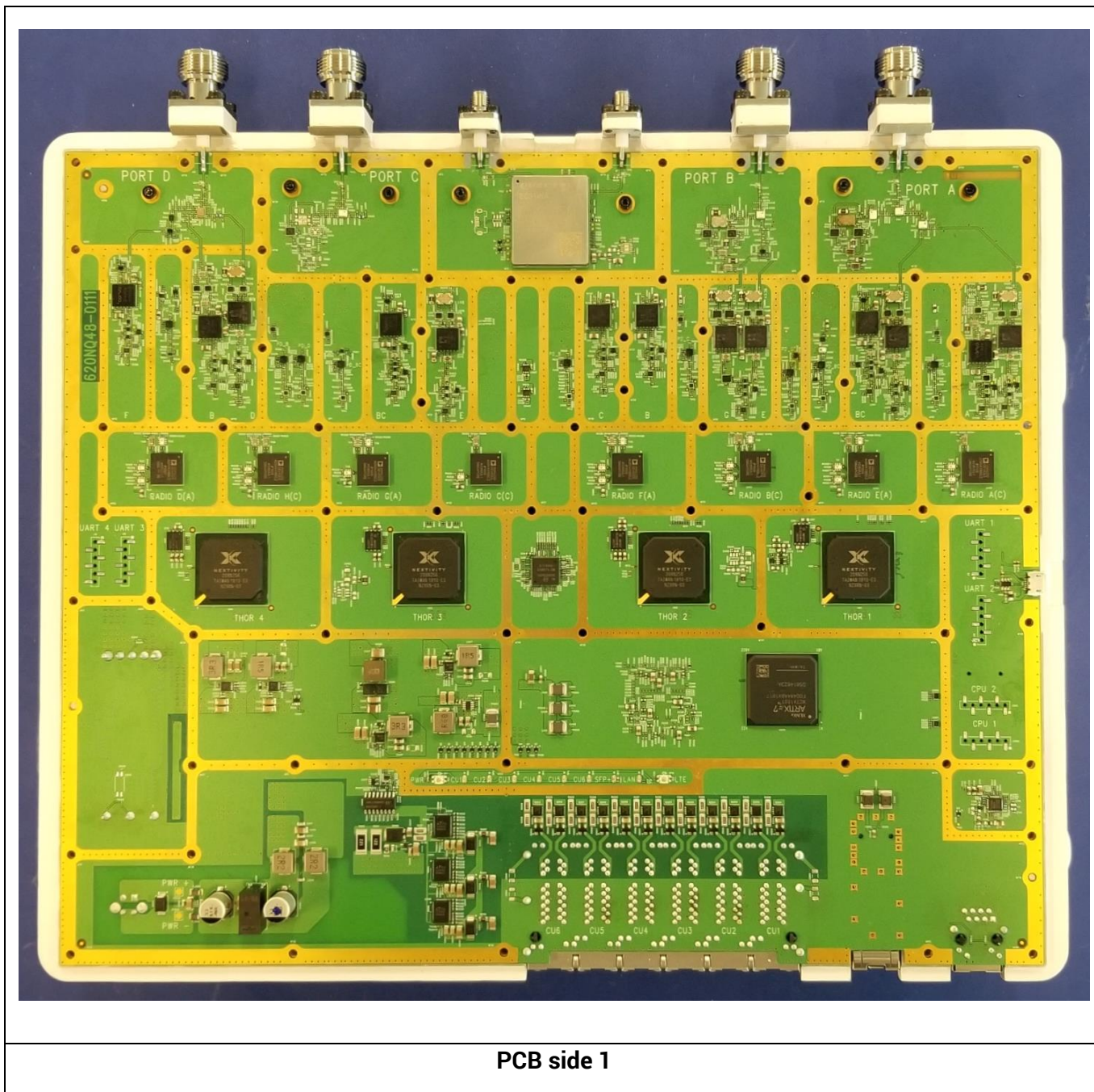

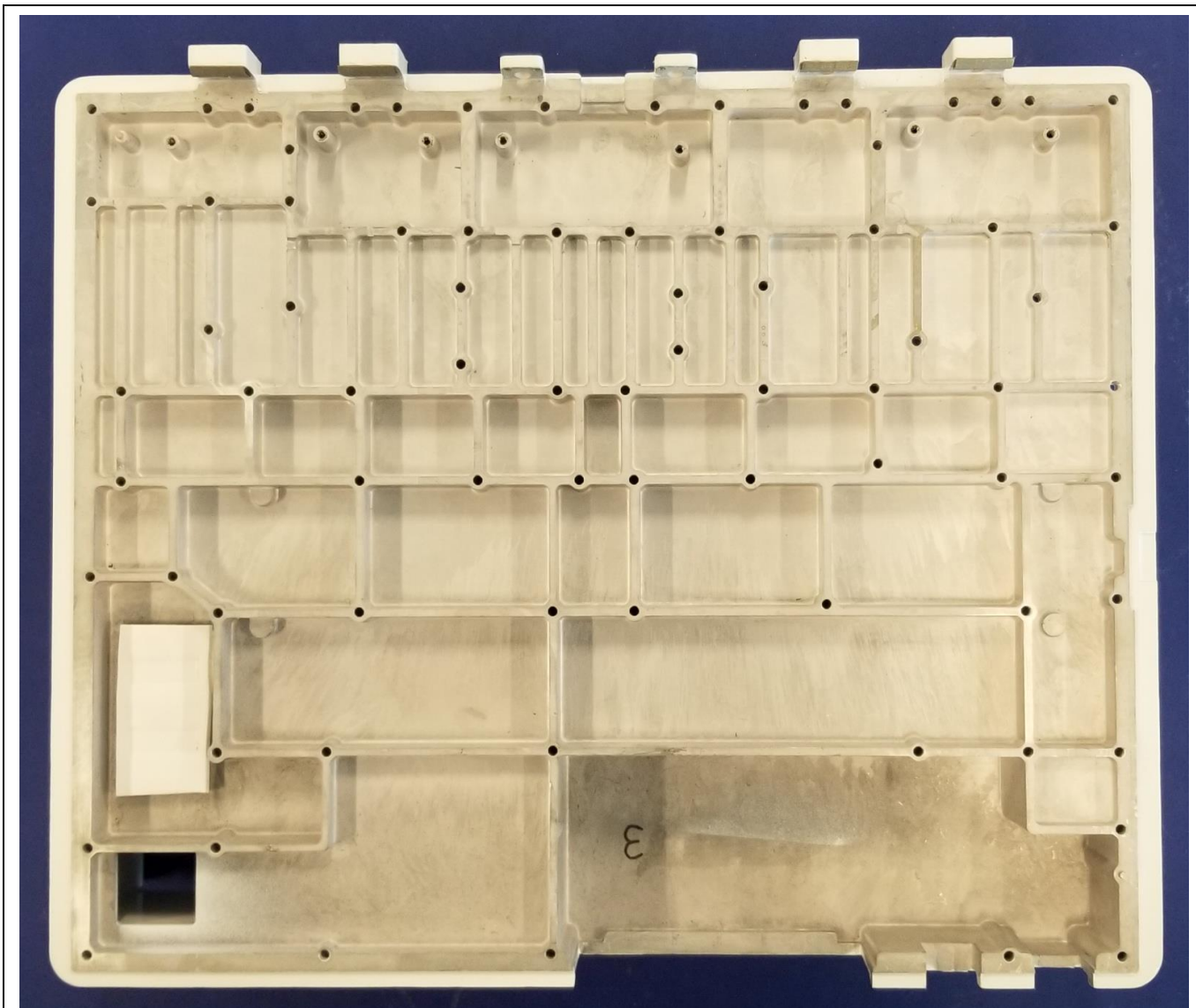

**Housing\_Bottom\_Internal**



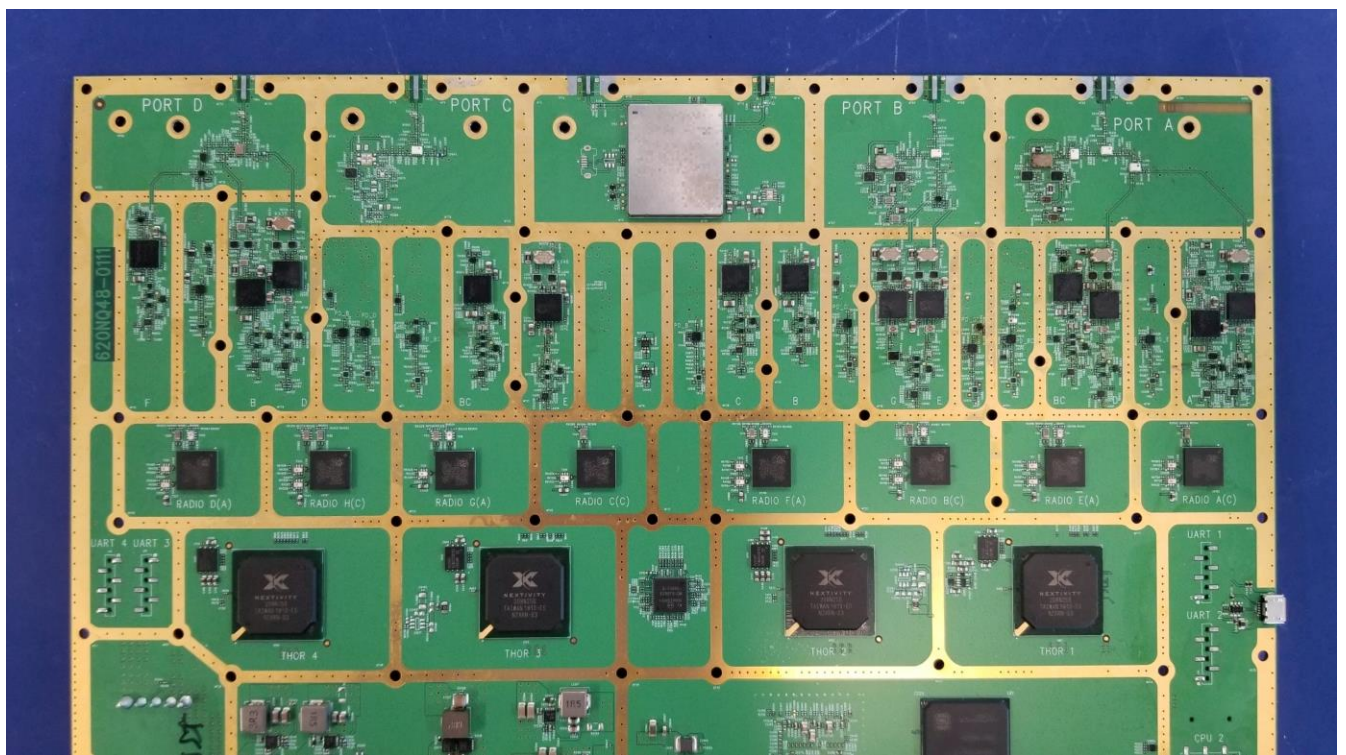

**PCB Side 1\_Radio**

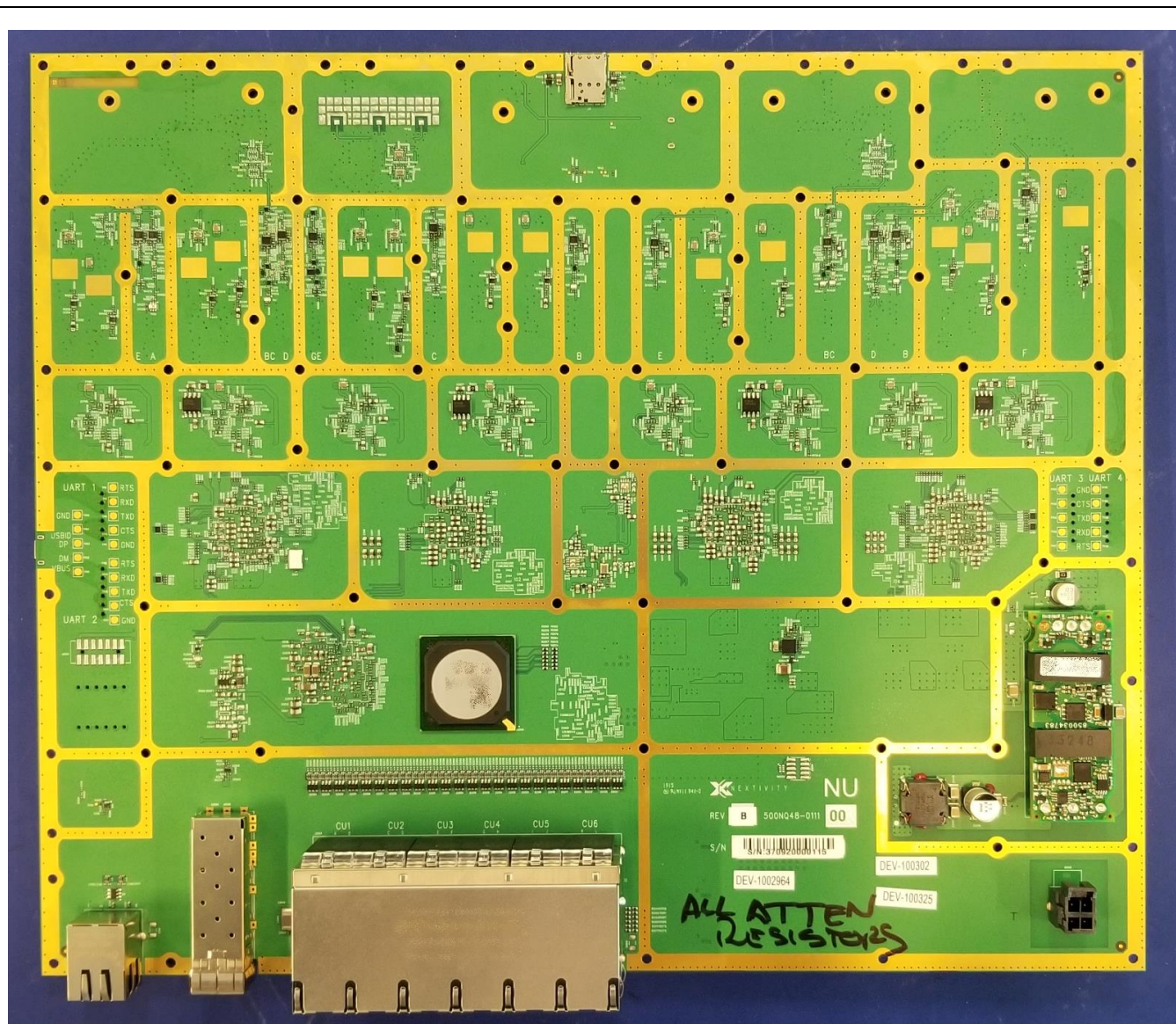

PCB side 2



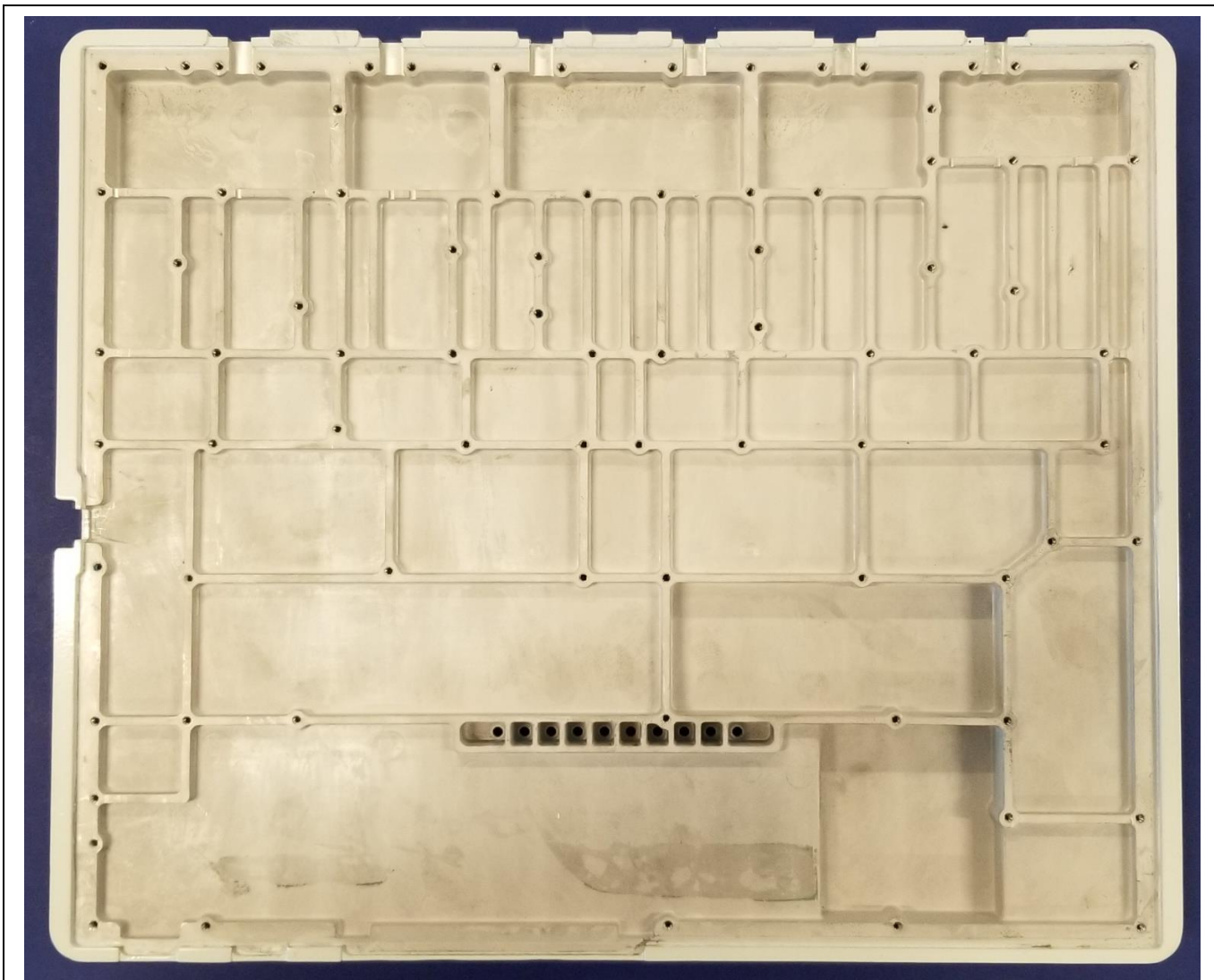

**Housing\_Top\_Internal**