



America

---

**Choose certainty.  
Add value.**

# Report On

Application for Grant of Equipment Authorization of the  
Nextivity Inc.

Cel-Fi DUO Smart Cellular Signal Booster

FCC CFR 47 Part 20

Report No. SD72112724-0116E

April 2016

FCC ID: NU: YETD32-21366NU  
CU: YETD32-21366CU  
IC: N/A  
Report No. SD72112724-0116E



**REPORT ON** Radio Testing of the  
Nextivity Inc.  
Smart Cellular Signal Booster

**TEST REPORT NUMBER** SD72112724-0116E

**PREPARED FOR** Nextivity Inc.  
12230 World Trade Drive, Suite 250  
San Diego, CA 92128

**CONTACT PERSON** CK Li  
Sr. Principal Engineer, Regulatory  
(858) 829-1692  
CLi@NextivityInc.com

**PREPARED BY**   
Xiaoying Zhang  
**Name**  
Authorized Signatory  
Title: EMC/Wireless Test Engineer

**APPROVED BY**   
Juan M. Gonzalez  
**Name**  
Authorized Signatory  
Title: Commercial Wireless EMC Lab Manager

**DATED** April 22, 2016

FCC ID: NU: YETD32-21366NU  
CU: YETD32-21366CU  
IC: N/A  
Report No. SD72112724-0116E



**Revision History**

SD72112724-0116E Nextivity Inc. M/N D32-2/13/66 Cel-Fi DUO Smart Cellular Signal Booster					
DATE	OLD REVISION	NEW REVISION	REASON	PAGES AFFECTED	APPROVED BY
04/22/16	Initial Release				Juan M Gonzalez



## CONTENTS

Section	Page No
<b>1</b>	<b>REPORT SUMMARY..... 5</b>
1.1	Introduction ..... 6
1.2	Brief Summary of Results..... 7
1.3	Product Information ..... 8
1.4	EUT Test configuration..... 10
1.5	Deviations From The Standard ..... 15
1.6	Modification Record ..... 15
1.7	Test Methodology..... 15
1.8	Test Facility Location..... 15
1.9	Test Facility Registration..... 15
1.10	Sample Calculations ..... 17
<b>2</b>	<b>TEST DETAILS ..... 18</b>
2.1	Authorized Frequency Band Verification ..... 19
2.2	Authorized CMRS Provider ..... 24
2.3	Maximum Power Measurement and Booster Gain Computation ..... 38
2.4	Intermodulation Product ..... 41
2.5	Out of Band Emissions ..... 49
2.6	Noise Limit ..... 62
2.7	Uplink Inactivity ..... 66
2.8	Variable Booster Gain ..... 70
2.9	Oscillation Detection..... 77
2.10	Out of Band Gain Limit..... 82
<b>3</b>	<b>TEST EQUIPMENT USED ..... 87</b>
3.1	Test Equipment Used..... 88
3.2	Measurement Uncertainty ..... 89
<b>4</b>	<b>DIAGRAM OF TEST SETUP ..... 90</b>
4.1	Test Setup Diagram..... 91
<b>5</b>	<b>ACCREDITATION, DISCLAIMERS AND COPYRIGHT ..... 96</b>
5.1	Accreditation, Disclaimers and Copyright..... 97

FCC ID: NU: YETD32-21366NU  
CU: YETD32-21366CU  
IC: N/A  
Report No. SD72112724-0116E



## **SECTION 1**

### **REPORT SUMMARY**

Radio Testing of the  
Nextivity Inc.  
Cel-Fi DUO Smart Cellular Signal Booster



## 1.1 INTRODUCTION

The information contained in this report is intended to show verification of the Nextivity Inc. Smart Cellular Signal Booster to the requirements of the following:

- FCC CFR 47 Part 20

Objective	To perform Radio Testing to determine the Equipment Under Test's (EUT's) compliance with the Test Specification, for the series of tests carried out.
Manufacturer	Nextivity Inc.
Model Name	Cel-Fi DUO
Model Number(s)	D32-2/13/66
FCC ID Number	NU: YETD32-21366NU CU: YETD32-21366CU
IC Number	N/A
Serial Number(s)	951550000015 (NU and CU) 296546000592 (NU) and 297546000384 (CU)
Number of Samples Tested	4
Test Specification/Issue/Date	<ul style="list-style-type: none"><li>• FCC CRF 47 Part 20 (October 1, 2015).</li><li>• KDB935210 (D04 Provider Specific booster Measurements v01r01) Provider-Specific Consumer Signal Booster Compliance Measurements Guidance.</li></ul>
Start of Test	January 21, 2016
Finish of Test	April 03, 2016
Name of Engineer(s)	Xiaoying Zhang
Related Document(s)	<ul style="list-style-type: none"><li>• Supporting documents for EUT certification are separate exhibits.</li></ul>



## 1.2 BRIEF SUMMARY OF RESULTS

A brief summary of the tests carried out in accordance with FCC CFR 47 Part 20 with cross-reference to the corresponding KDB935210 D04 is shown below.

Section	Spec Clause		Test Description	Result
	KDB935210 D04	FCC Part 20		
2.1 2.2	20.21 (e)(3) Frequency Bands 20.21 (a)(4)	7.1	Authorized Frequency Band Verification Test and authorized CMRS provider test	Compliant
2.3	20.21(e)(9)(i)(D) Power Limits 20.21(e)(9)(i)(B) Bidirectional Capability 20.21(e)(9)(i)(C)(1) and (2) Booster Gain Limits	7.2 7.3	Maximum Power measurement procedure Maximum Booster Gain Computer	Compliant
2.4	20.21(e)(9)(i)(G) Intermodulation Limit	7.4	Intermodulation Product	Compliant
2.5	20.21(e)(9)(i)(F) Out of Band Gain Limit	7.5	Out-of-Band Emissions	Compliant
-	2.1051	7.6	Conducted Spurious Emissions	N/A*
2.6	20.21(e)(9)(i)(A) Noise Limits 20.21(e)(9)(i)(I) Transmit Power Off Mode	7.7	Noise Limits	Compliant
2.7	20.21(e)(9)(i)(J) Uplink Inactivity	7.8	Uplink inactivity	Compliant
2.8	20.21(e)(9)(i)(C)(1) Booster Gain Limits 20.21(e)(9)(i)(I) Transmit Power Off Mode	7.9	Variable Booster Gain	Compliant
-	2.1049	7.10	Occupied Bandwidth	N/A*
2.9	20.21(e)(9)(ii)(A) Anti-Oscillation	7.11	Oscillation Detection	
-	2.1053	7.12	Radiated Spurious Emissions	N/A*
-	20.21(e)(9)(i)(B) Bidirectional Capability 20.21(e)(3) Frequency Band	7.13	Spectrum Block Filtering	N/A**
2.10	20.21(e)(9)(i)(E) Out of Band Gain Limit	7.14	Out of Band Gain	Compliant
-	2.1055	7.15	Frequency Stability	N/A*

N/A\* - Not Applicable. Different Standard Applies; Refer to test report SD72112724-0116B for LTE Band 2, SD72112724-0116C for LTE Band 13 and SD72112724-0116D for LTE Band 66

N/A\*\* - Not Applicable. The EUT does not utilize spectrum block filtering.



### **1.3 PRODUCT INFORMATION**

#### **1.3.1 Technical Description**

The Equipment Under Test (EUT) was a Nextivity Inc. Cel-Fi DUO Smart Cellular Signal Booster. The EUT is a signal booster for indoor residential, small business and small enterprise use. It consists of two units: the Network Unit (NU), and the Coverage Unit (CU). NU and CU are shipped and sold as one unit. The NU transmits and receives Cellular signals from the base station and operates similar to a cellular handset. The CU transmits and receives signals with the cellular handset and operates on frequencies similar to the cellular base station. The NU and CU are connected wirelessly over a full-duplex wireless link in the UNII band using a mixed OFDM and muxed cellular signal over a 30 or 40 MHz channel in each direction. The CU also includes Bluetooth LE connectivity. With the use of smart phone application, it allows user to register the product, update software, capture/display details metrics of the system. NU does not support Bluetooth LE. The LTE Band 2, Band 13, Band 66 function of the EUT were verified in this test report.





**1.3.2 EUT General Description**

EUT Description Smart Cellular Signal Booster

Model Name Cel-Fi DUO

Model Number(s) D32-2/13/66

Rated Voltage 12V DC via external AC/DC adapter.

Mode Verified LTE Band 2, Band 13, Band 66

Frequency Bands  
 Band 2:  
 NU: 1850 - 1910MHz  
 CU: 1930 - 1990MHz  
 Band 13:  
 NU: 746 - 756MHz  
 CU: 777 - 787MHz  
 Band 66:  
 NU: 1710 - 1780MHz  
 CU: 2110 - 2180MHz

Channel Bandwidth LTE Band 2 and 66: 5MHz, 10MHz, 15MHz and 20MHz  
 LTE Band 13: 5MHz, 10MHz

Capability LTE Band 2, 13, 66/UNII and BT-LE

Primary Unit (EUT)  Production  
 Pre-Production  
 Engineering

Manufacturer Declared Temperature Range 0°C to 40°C

Antenna Type PCB PIFA

Manufacturer Nextivity Inc.

Antenna Model N/A

Antenna Gain	Band	NU	CU
	2, 66	2 dBi	2 dBi
	13	0 dBi	0 dBi



## 1.4 EUT TEST CONFIGURATION

### 1.4.1 Test Configuration Description

Test Configuration	Description
A	Test Mode - Downlink (CU TX). Input signal is applied to B2, B13, B66 antenna port of NU. Output is monitored from B66 Top antenna port of CU. (refer to 1.4.4 Figure 2)
B	Test Mode - Uplink (NU TX). Input signal is applied to B2, B13, B66 antenna port of CU. Output is monitored from B2, B13, B66 Top antenna port of NU. (refer to 1.4.4 Figure 3)
C	Normal Mode - Downlink (CU TX). Base Station Simulator is employed to send a modulated signal to B2, B13, B66 antenna port of NU. B2, B13, B66 Top antenna port of CU is terminated with a 50Ω load. (refer to 1.4.4 Figure 1)
D	Normal Mode - Uplink (NU TX). Base Station Simulator is employed to send a modulated signal to B2, B13, B66 antenna port of NU. Input signal is applied to B2, B13, B66 antenna port of CU. (refer to 1.4.4 Figure 1)
E	Inter-modulation. Test setup identical to Test Configuration A and B above with the addition of another signal applied to the input of the EUT. A coupler was used in the setup to ensure that the additional signal is directed to the EUT input port. (refer to 1.4.4 Figure 4)
F	Max Downlink noise limit testing - A 50 Ohm Termination is connected to the NU antenna port and Measure the Noise Limit at the CU antenna port. (refer to 1.4.4 Figure 5)
G	Max Uplink noise limit testing - A 50 Ohm Termination is connected to the CU antenna port. A signal is connected to a step attenuator and then applied to the NU antenna port. Output is monitored from B2, B13, B66 Top antenna port of NU. (refer to 1.4.4 Figure 6)
H	Max Downlink noise limit testing - A 50 Ohm Termination is connected to the CU antenna port. A signal is connected to a step attenuator and then applied to the NU antenna port. Output is monitored from B2, B13, B66 Top antenna port of CU. (refer to 1.4.4 Figure 6)

### 1.4.2 EUT Exercise Software

Manufacturer provided a configuration software (ConformanceTest.exe) running from a support laptop where both EUT are connected via USB.



**1.4.3 Support Equipment and I/O cables**

Manufacturer	Equipment/Cable	Description
Hon-Kwang	AC/DC Adapter (EUT)	M/N HK-AB-120A250-US P/N 290N025-001, 12VDC 2.5A
-	Support USB cable	1.75 meters, shielded Type A to Micro B connector
Nextivity	Support USB cable	Custom 1.0 meter shielded USB Type A to DB9 for the Shielded Test Enclosure
Sony	Support Laptop	M/N PCG-31311L S/N 27545534 3006488
Sony	Support Laptop AC Adapter	M/N PCGA-AC19V9 S/N 147839091 0023259
Mini-Circuits	Support Coaxial SMA Fixed Attenuator (x4)	M/N VAT-30W2 30dB DC-6GHz
Agilent	11dB Step Attenuator	M/N 8494B Frequency Range DC - 18GHz S/N 2812A17193
Agilent	110dB Step Attenuator	M/N 8496B Frequency Range DC - 18GHz S/N MY42143874
K&L	1500 - 3000 MHz Tuneable Bypass Filter	M/N 5BT-1500/3000-5-N/N
Ramsey	Support Shielded Test Enclosure	M/N STE3300 S/N 3042 with custom USB cable and AC/DC Adapter

#### 1.4.4 Simplified Test Configuration Diagram

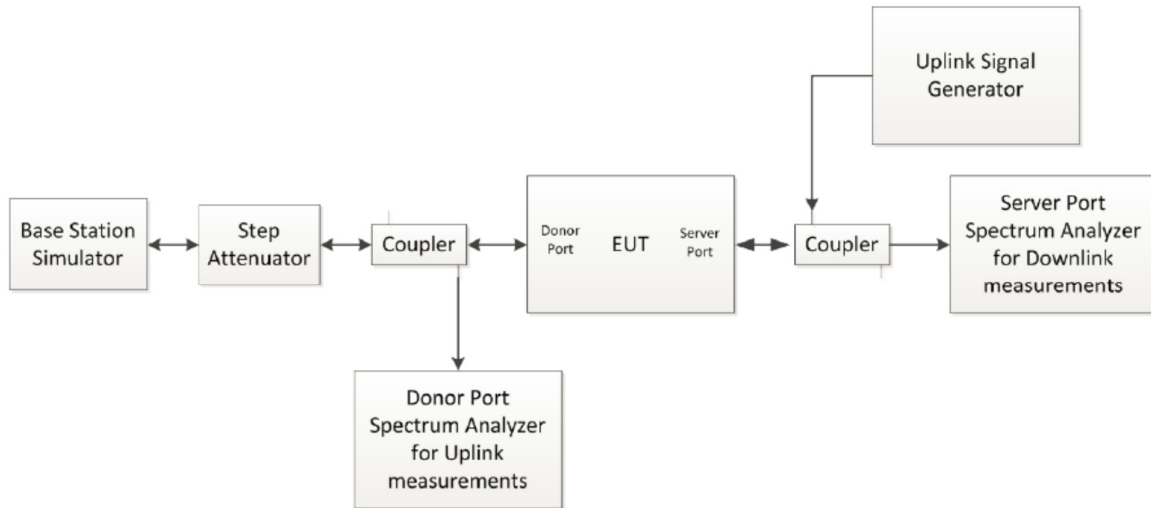

Figure 1: Test Configuration in Normal Mode

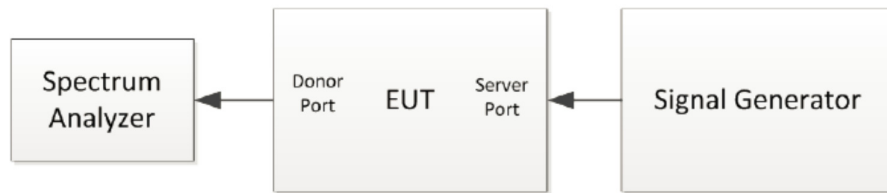

Figure 2: Uplink Test Configuration in Test Mode

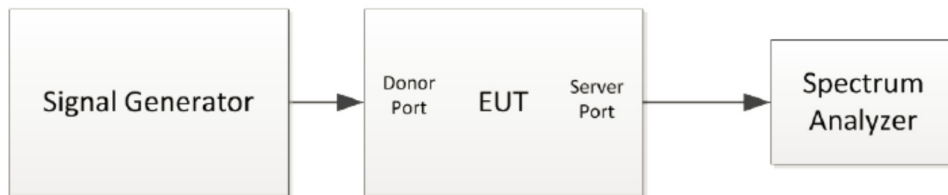

Figure 3: Downlink Test Configuration in Test Mode

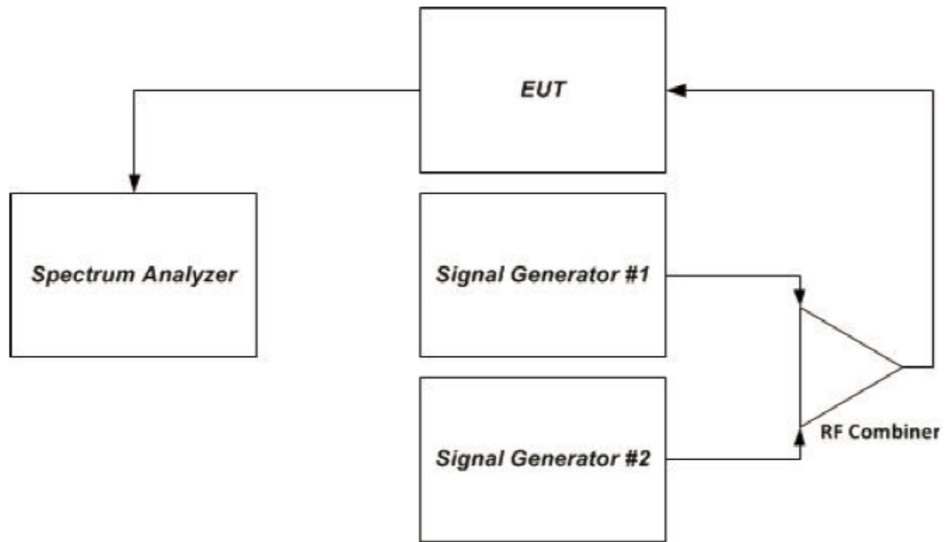

Figure 4 – Intermodulation product instrumentation test setup

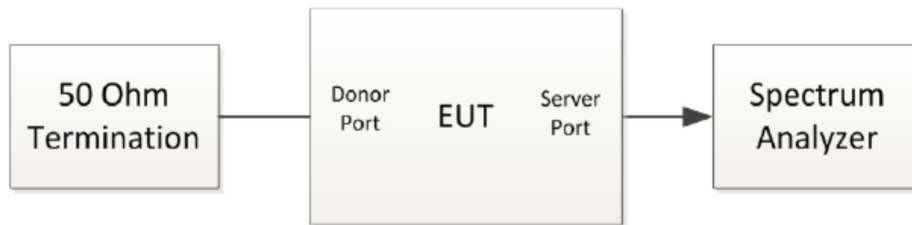

Figure 5: Maximum downlink noise limit test configuration

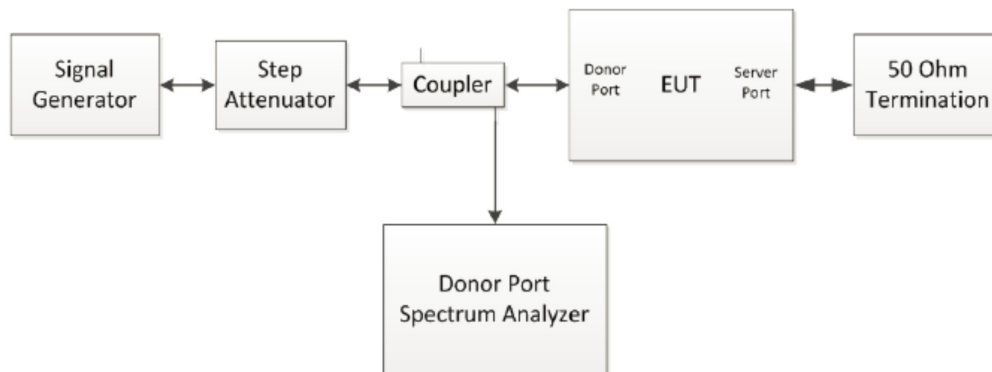

Figure 6: Uplink RSSI dependent noise limit test configuration

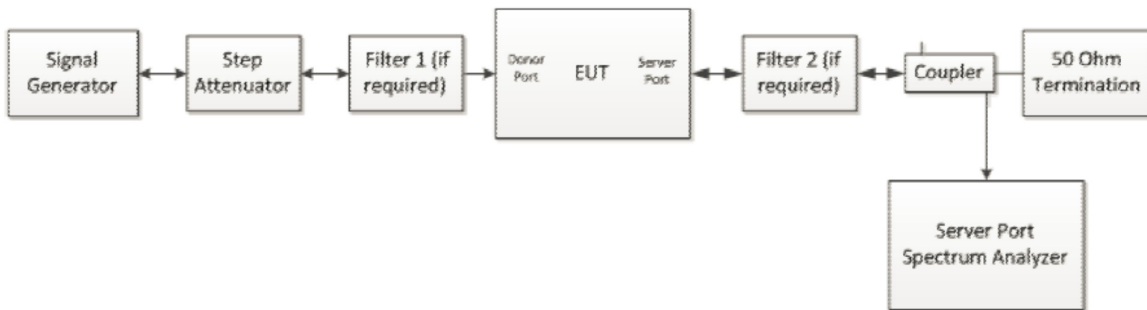

Figure 7: Downlink RSSI dependent noise limit test configuration



## 1.5 DEVIATIONS FROM THE STANDARD

No deviations from the applicable test standards or test plan were made during testing.

## 1.6 MODIFICATION RECORD

Description of Modification	Modification Fitted By	Date Modification Fitted
Serial Number 95155000015 (NU and CU), 297546000384 (CU) and 296546000592 (NU)		
N/A		

The table above details modifications made to the EUT during the test programme. The modifications incorporated during each test (if relevant) are recorded on the appropriate test pages.

## 1.7 TEST METHODOLOGY

All measurements contained in this report were conducted as per KDB935210 D04 Provider-Specific Consumer Signal Boosters Compliance Measurements Guidance (January 5, 2015).

## 1.8 TEST FACILITY LOCATION

### 1.8.1 TÜV SÜD America Inc. (Mira Mesa)

10040 Mesa Rim Road, San Diego, CA 92121-2912 (32.901268,-117.177681). Phone: 858 678 1400 FAX: 858-546 0364

### 1.8.2 TÜV SÜD America Inc. (Rancho Bernardo)

Building #8, 16530 Via Esprillo, San Diego, CA 92127-1708 (33.018644,-117.092409). Phone: 858 942 5542 Fax: 858 546 0364.

## 1.9 TEST FACILITY REGISTRATION

### 1.9.1 FCC – Registration No.: US1146

TUV SUD America Inc. (San Diego), is an accredited test facility with the site description report on file and has met all the requirements specified in §2.948 of the FCC rules. The acceptance letter from the FCC is maintained in our files and the Registration is US1146.

FCC ID: NU: YETD32-21366NU  
CU: YETD32-21366CU  
IC: N/A  
Report No. SD72112724-0116E



**1.9.2 Innovation, Science and Economic Development Canada Registration No.: 3067A**

The 10m Semi-anechoic chamber of TÜV SÜD America Inc. (San Diego) has been registered by Certification and Engineering Bureau of Innovation, Science and Economic Development Canada for radio equipment testing with Registration No. 3067A.





**1.10 SAMPLE CALCULATIONS**

**1.10.1 LTE Emission Designator**

Emission Designator = 1M30F9W  
 F = Frequency Modulation  
 9= Composite Digital Info  
 W = Combination (Audio/Data)

**1.10.2 Spurious Radiated Emission (below 1GHz)**

Measuring equipment raw measurement (dBµV/m) @ 30 MHz			24.4
Correction Factor (dB)	Asset# 1066 (cable)	0.3	-12.6
	Asset# 1172 (cable)	0.3	
	Asset# 1016 (preamplifier)	-30.7	
	Asset# 1175(cable)	0.3	
	Asset# 1002 (antenna)	17.2	
Reported QuasiPeak Final Measurement (dBµV/m) @ 30MHz			<b>11.8</b>

**1.10.3 Spurious Radiated Emission – Substitution Method**

Example = 84dBµV/m @ 1413 MHz (numerical sample only)

The field strength reading of 84dBµV/m @ 1413 MHz (2<sup>nd</sup> Harmonic of 706.5 MHz) is the maximized measurement when the EUT is on the turntable measured at 3 meters. The gain of the substituted antenna is 7.8dBi while the transmit cable loss is 1.0 dB (cable between signal generator and the substituted antenna). The signal generator level is adjusted until the 84dBµV/m level at the receiving end is replicated (identical test setup, i.e. same antenna, cable/s and preamp). If the adjusted signal generator level is -18dBm, then we have the following for both EIRP and ERP as required:

$$\begin{aligned}
 P_{EIRP} &= -18 \text{ dBm} + 7.8 \text{ dBi} - 1 \text{ dB} \\
 &= 11.2 \text{ dBm} \\
 P_{ERP} &= P_{EIRP} - 2.15 \text{ dB} \\
 &= 11.2 \text{ dBm} - 2.15 \text{ dB} \\
 &= 9.05 \text{ dBm}
 \end{aligned}$$

FCC ID: NU: YETD32-21366NU  
CU: YETD32-21366CU  
IC: N/A  
Report No. SD72112724-0116E



## **SECTION 2**

### **TEST DETAILS**

Radio Testing of the  
Nextivity Inc.  
Cel-Fi DUO Smart Cellular Signal Booster



## **2.1 AUTHORIZED FREQUENCY BAND VERIFICATION**

### **2.1.1 Specification Reference**

FCC 47 CFR Part 20, Clause 20.21 (e)(3)  
FCC 47 CFR Part 20, Clause 20.21(a)(4)  
KDB935210 D04, Clause 7.1

### **2.1.2 Standard Applicable**

FCC 47 CFR Part 20, Clause 20.21 (e)(3) Frequency Bands:  
Consumer Signal Boosters must be designed and manufactured such that they only operate on the frequencies used for the provision of subscriber-based services under parts 22 (Cellular), 24 (Broadband PCS), 27 (AWS-1, 700 MHz Lower A-E Blocks, and 700 MHz Upper C Block), and 90 (Specialized Mobile Radio) of this chapter. The Commission will not certificate any Consumer Signal Boosters for operation on part 90 of this chapter (Specialized Mobile Radio) frequencies until the Commission releases a public notice announcing the date Consumer Signal Boosters may be used in the band.

FCC 47 CFR Part 20, Clause 20.21(a)(4) Self Monitoring:  
The subscriber operates the Consumer Signal Booster on frequencies used for the provision of subscriber-based services under parts 22 (Cellular), 24 (Broadband PCS), 27 (AWS-1, 700 MHz Lower A-E Blocks, and 700 MHz Upper C Block), and 90 (Specialized Mobile Radio) of this chapter. Operation on part 90 (Specialized Mobile Radio) frequencies is permitted upon the Commission's release of a public notice announcing the date Consumer Signal Boosters may be used in the band;

### **2.1.3 Equipment Under Test and Modification State**

Serial No: 95155000015 (NU and CU) / Test Configuration A and B

### **2.1.4 Date of Test/Initial of test personnel who performed the test**

January 21 and February 17, 2016/XYZ

### **2.1.5 Test Equipment Used**

The major items of test equipment used for the above tests are identified in Section 3.1.

### **2.1.6 Environmental Conditions**

Test performed at TÜV SÜD America Inc. Rancho Bernardo facility.

Ambient Temperature	23.4 - 27.4°C
Relative Humidity	33.7 - 46.7%
ATM Pressure	98.7 - 99.7kPa



**2.1.7 Additional Observations**

- 1) This is conducted Test. Test procedure is per Section 7.1.1 of KDB935210 (D04 Provider Specific Booster Measurements v01r01). Appropriate offset (line losses) applied.
- 2) The EUT operated in Test Mode, with the gain manually set to the maximum gain and a minimum bandwidth setting (5MHz).
- 3) Setup the EUT according to Figure 2 or 3 of Section 6.3.3 of KDB935210 (D04 Provider Specific Booster Measurements v01r01) as appropriate.
- 4) Evaluations are conducted at CU antenna ports B2/13 and B66, and NU antenna ports B2/13 and B66.
- 5) All operational uplink and downlink bands for LTE Band 2, 13 and 66 were tested.
- 6) The signal generator was set to transmit a 4.1MHz AWGN signal.
- 7) DL: B2: 1930 – 1990MHz; B13:746 – 756MHz; B66:2110 – 2180MHz;  
 UL: B2: 1850 – 1910MHz; B13:777 – 787MHz; B66:1710 – 1780MHz;

**2.1.8 Test Results**

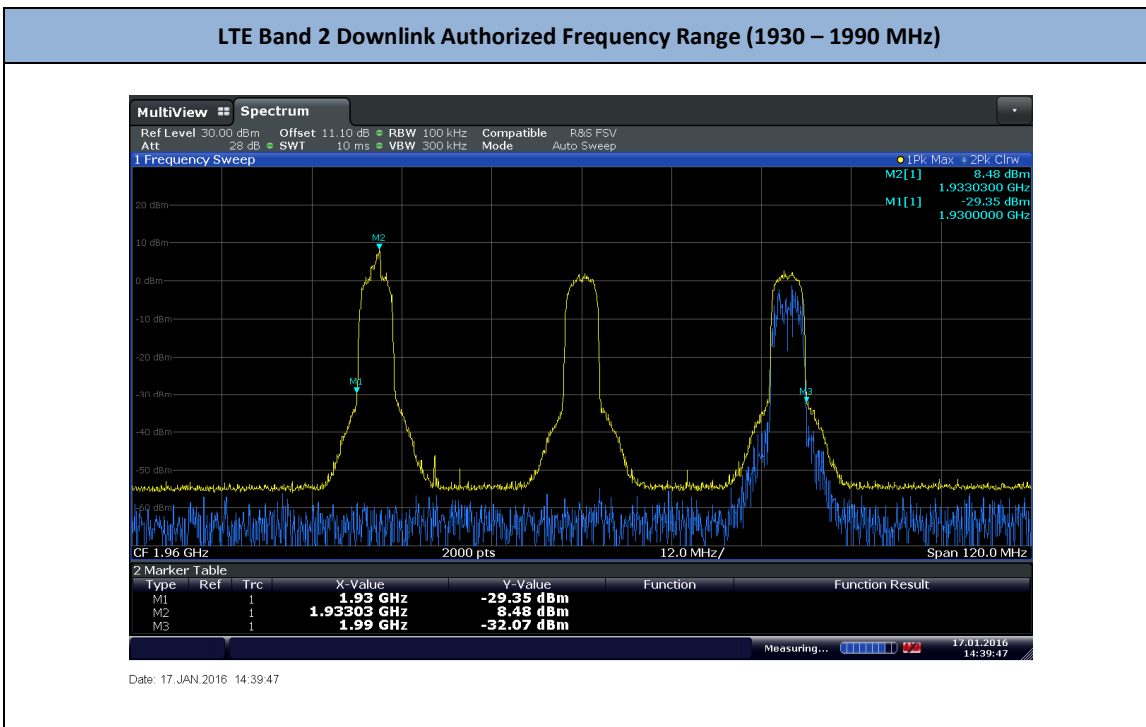



### LTE Band 2 Uplink Authorized Frequency Range (1850 – 1910 MHz)

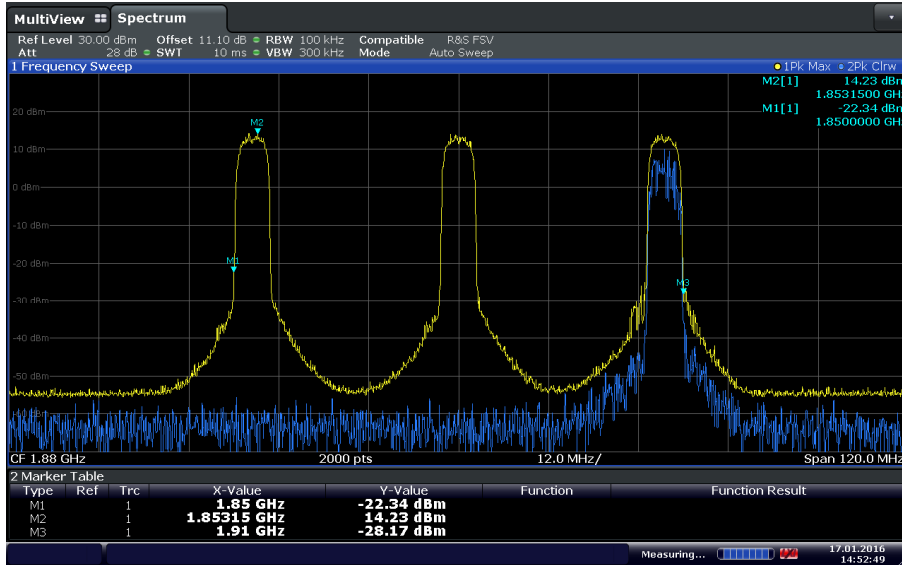

Date: 17 JAN 2016 14:52:50

### LTE Band 13 Downlink Authorized Frequency Range (746 – 756 MHz)

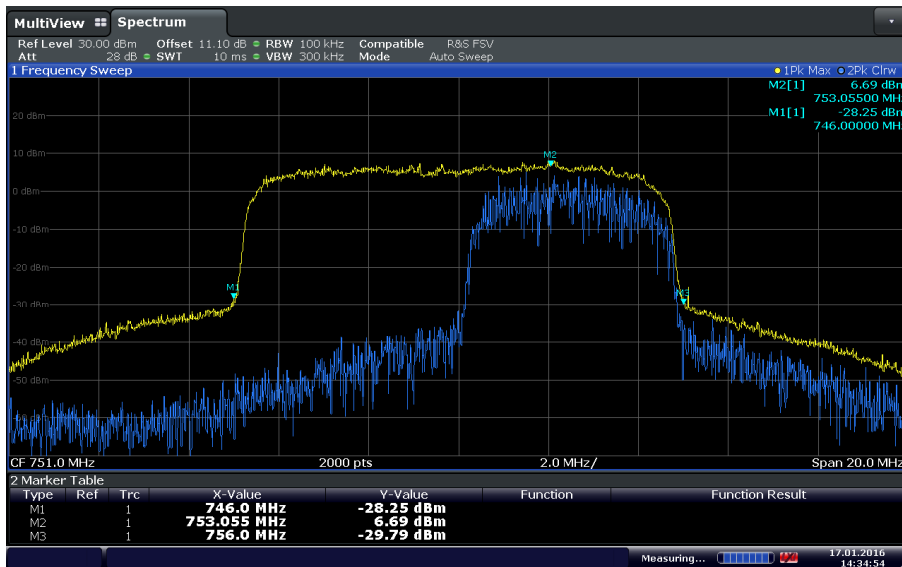

Date: 17 JAN 2016 14:34:55



**LTE Band 13 Uplink Authorized Frequency Range (777 – 787 MHz)**

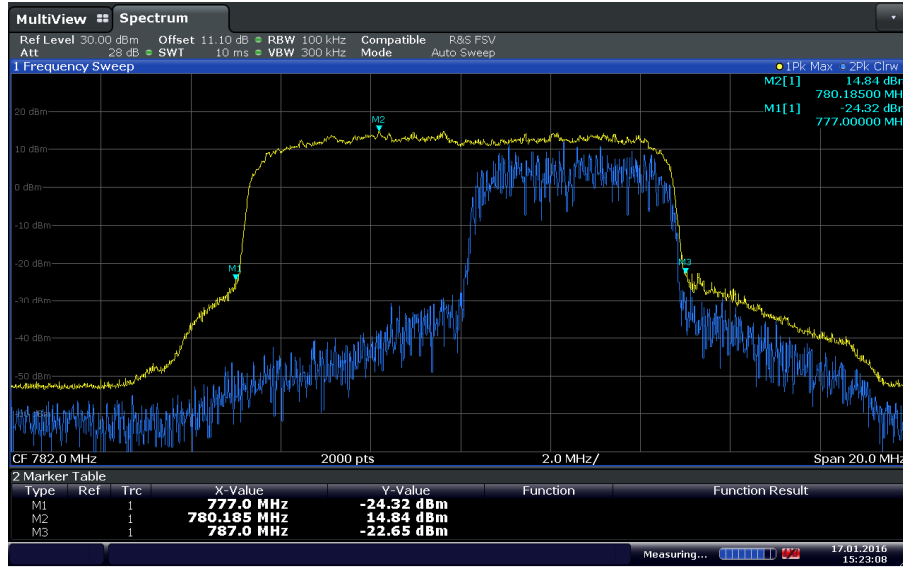

Date: 17 JAN 2016 15:23:08

**LTE Band 66 Downlink Authorized Frequency Range (2110 – 2180 MHz)**

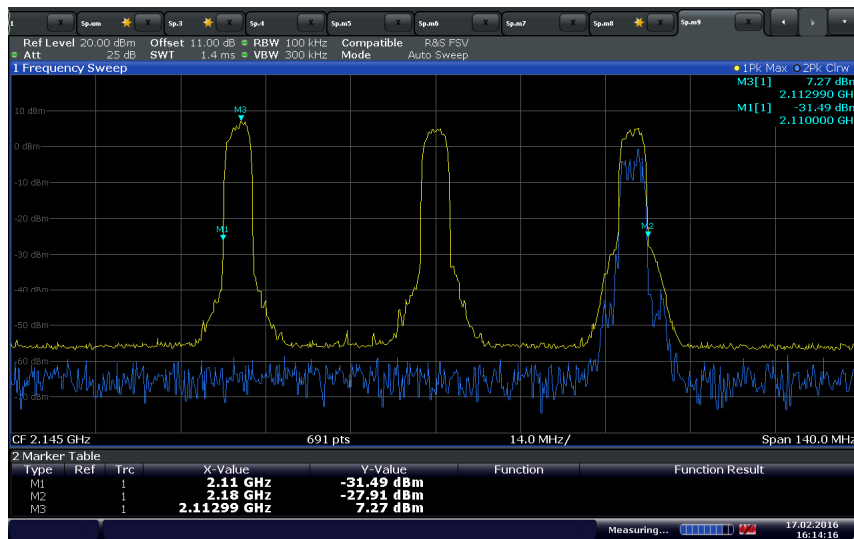

Date: 17 FEB 2016 16:14:17



LTE Band 66 Uplink Authorized Frequency Range (1710 – 1780 MHz)

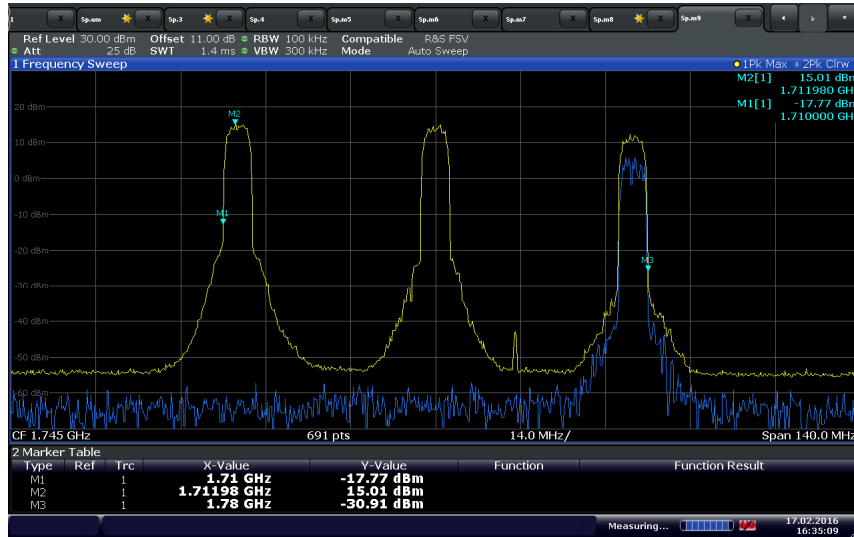

Date: 17 FEB 2016 16:35:09



## **2.2 AUTHORIZED CMRS PROVIDER**

### **2.2.1 Specification Reference**

FCC 47 CFR Part 20, Clause 20.21 (e)(3)  
FCC 47 CFR Part 20, Clause 20.21(a)(4)  
KDB935210 D04, Clause 7.1

### **2.2.2 Standard Applicable**

FCC 47 CFR Part 20, Clause 20.21 (e)(3) Frequency Bands:  
Consumer Signal Boosters must be designed and manufactured such that they only operate on the frequencies used for the provision of subscriber-based services under parts 22 (Cellular), 24 (Broadband PCS), 27 (AWS-1, 700 MHz Lower A-E Blocks, and 700 MHz Upper C Block), and 90 (Specialized Mobile Radio) of this chapter. The Commission will not certificate any Consumer Signal Boosters for operation on part 90 of this chapter (Specialized Mobile Radio) frequencies until the Commission releases a public notice announcing the date Consumer Signal Boosters may be used in the band.

FCC 47 CFR Part 20, Clause 20.21(a)(4) Self Monitoring:  
The subscriber operates the Consumer Signal Booster on frequencies used for the provision of subscriber-based services under parts 22 (Cellular), 24 (Broadband PCS), 27 (AWS-1, 700 MHz Lower A-E Blocks, and 700 MHz Upper C Block), and 90 (Specialized Mobile Radio) of this chapter. Operation on part 90 (Specialized Mobile Radio) frequencies is permitted upon the Commission's release of a public notice announcing the date Consumer Signal Boosters may be used in the band;

### **2.2.3 Equipment Under Test and Modification State**

Serial No: 296546000592 (NU) and 297546000384 (CU) / Test Configuration C and D

### **2.2.4 Date of Test/Initial of test personnel who performed the test**

January 25, February 24 and 29, 2016/XYZ

### **2.2.5 Test Equipment Used**

The major items of test equipment used for the above tests are identified in Section 3.1.

### **2.2.6 Environmental Conditions**

Test performed at TÜV SÜD America Inc. Rancho Bernardo facility.

Ambient Temperature	22.5 - 27.5 °C
Relative Humidity	39.9 – 43.4 %
ATM Pressure	99.2 – 99.5 kPa



## 2.2.7 Additional Observations

- 1) This is conducted Test. Test procedure is per Section 7.1.2 of KDB935210 (D04 Provider Specific Booster Measurements v01r01). Appropriate offset (line losses) applied.
- 2) The EUT operated in Normal Mode, with the gain manually set to the maximum gain and a minimum bandwidth setting (5MHz).
- 3) Setup the EUT according to Figure 1 of Section 6.3.2 of KDB935210 (D04 Provider Specific Booster Measurements v01r01) with the Base Station Simulator transmitting an authorized CMRS provider signal to the booster.
- 4) Evaluations are conducted at CU antenna ports B2/13 and B66, and NU antenna ports B2/13 and B66.
- 5) All operational uplink and downlink bands for LTE Band 2, 13 and 66 were tested.
- 6) The Base Station Simulator was set to transmit a 5MHz LTE signal.
- 7) The authorized CMRS Provider ID: 311/480
- 8) Three Non- authorized CMRS Provider signals were verified.
- 9) DL: B2: 1930 – 1990MHz; B13:746 – 756MHz; B66:2110 – 2180MHz;  
UL: B2: 1850 – 1910MHz; B13:777 – 787MHz; B66:1710 – 1780MHz;

## 2.2.8 Test Results

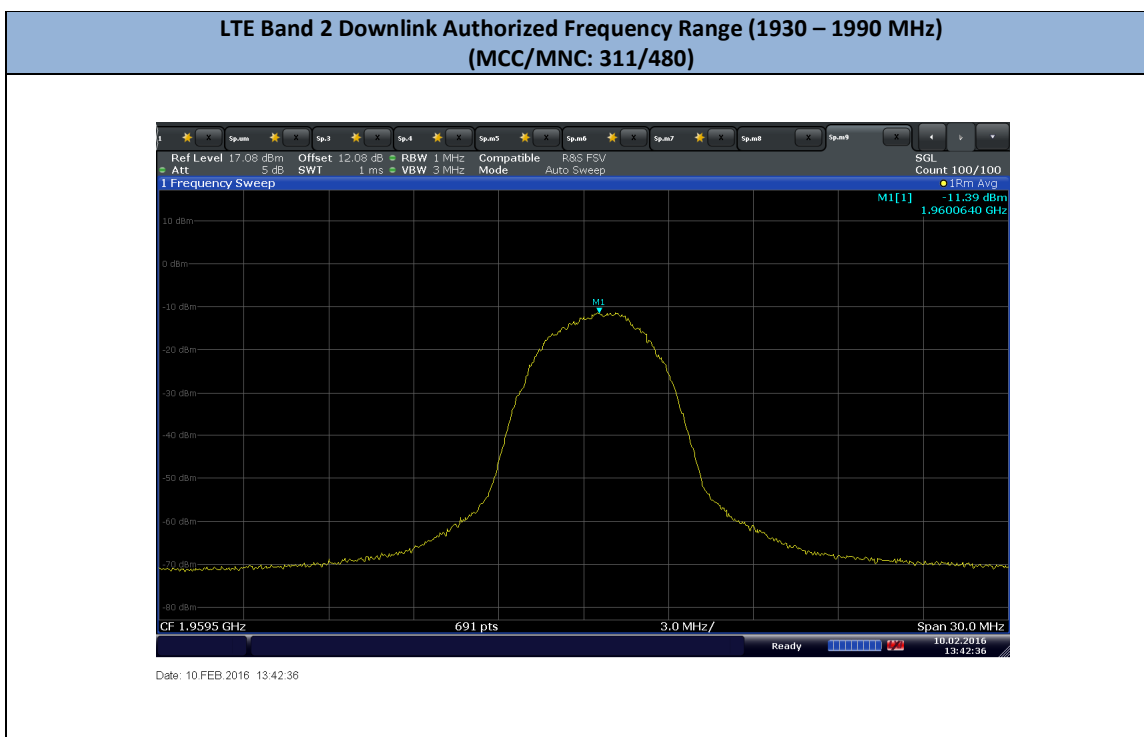



LTE Band 2 Downlink Authorized Frequency Range (1930 – 1990 MHz)  
(MCC/MNC: 310/070)

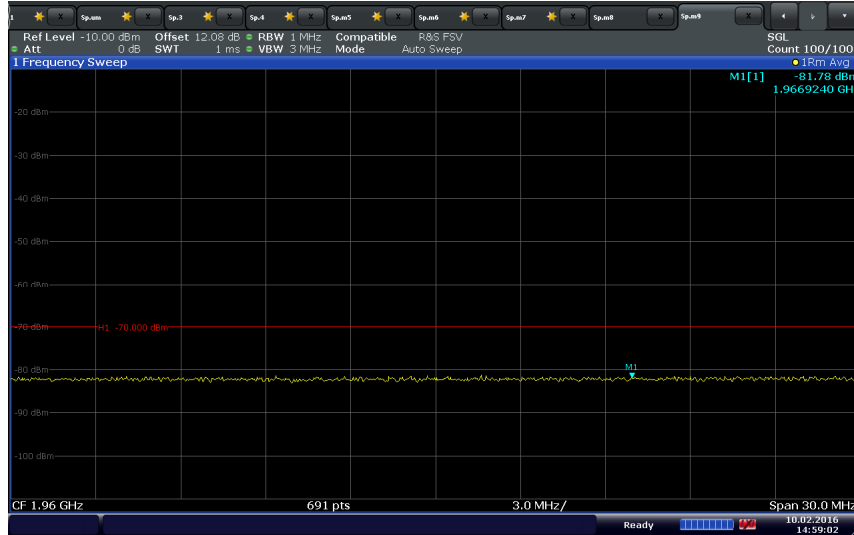

Date: 10 FEB 2016 14:59:03

LTE Band 2 Downlink Authorized Frequency Range (1930 – 1990 MHz)  
(MCC/MNC: 310/120)

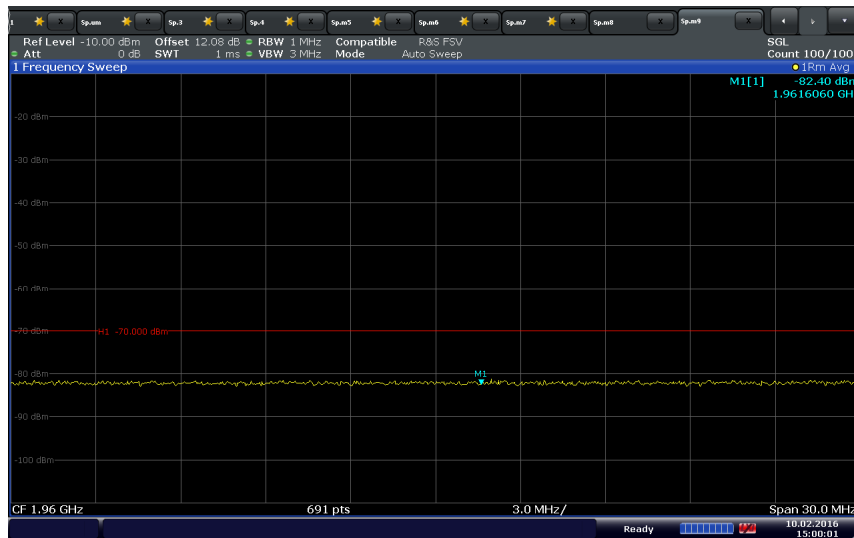

Date: 10 FEB 2016 15:00:01



**LTE Band 2 Uplink Authorized Frequency Range (1850 – 1910 MHz)**  
**(MCC/MNC: 311/480)**

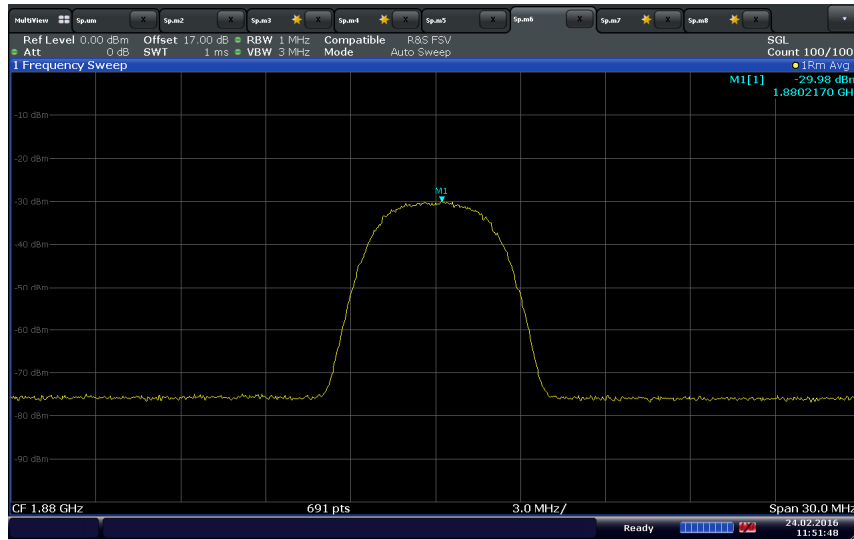

Date: 24 FEB.2016 11:51:49

**LTE Band 2 Uplink Authorized Frequency Range (1850 – 1910 MHz)**  
**(MCC/MNC: 310/070)**

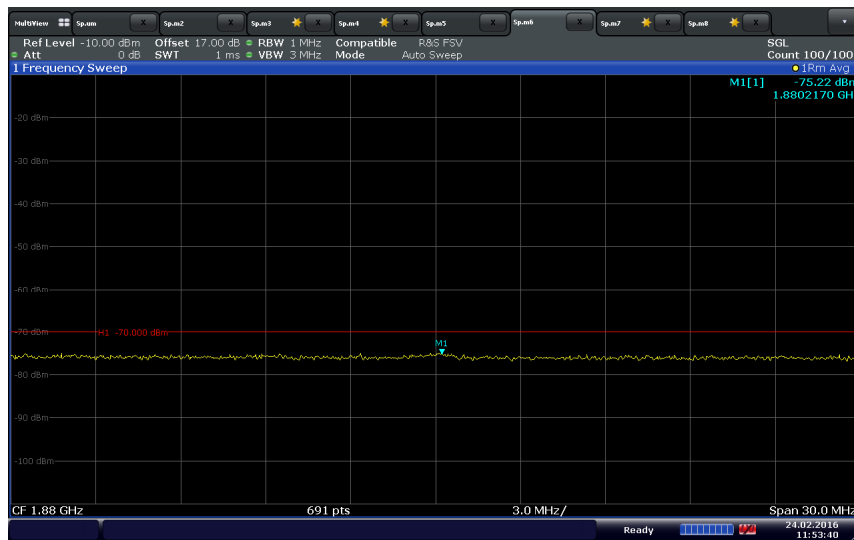

Date: 24 FEB.2016 11:53:41



**LTE Band 2 Uplink Authorized Frequency Range (1850 – 1910 MHz)**  
**(MCC/MNC: 310/120)**

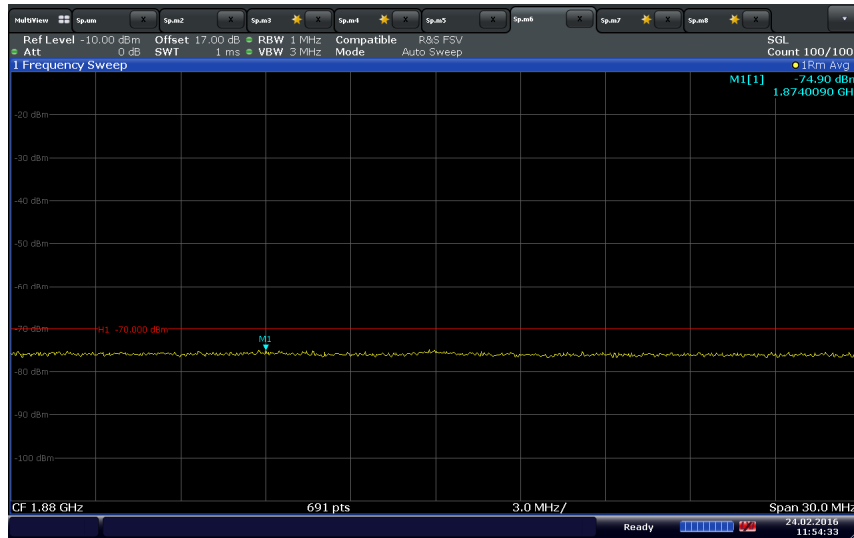

**LTE Band 13 Downlink Authorized Frequency Range (746 – 756 MHz)**  
**(MCC/MNC: 311/480)**

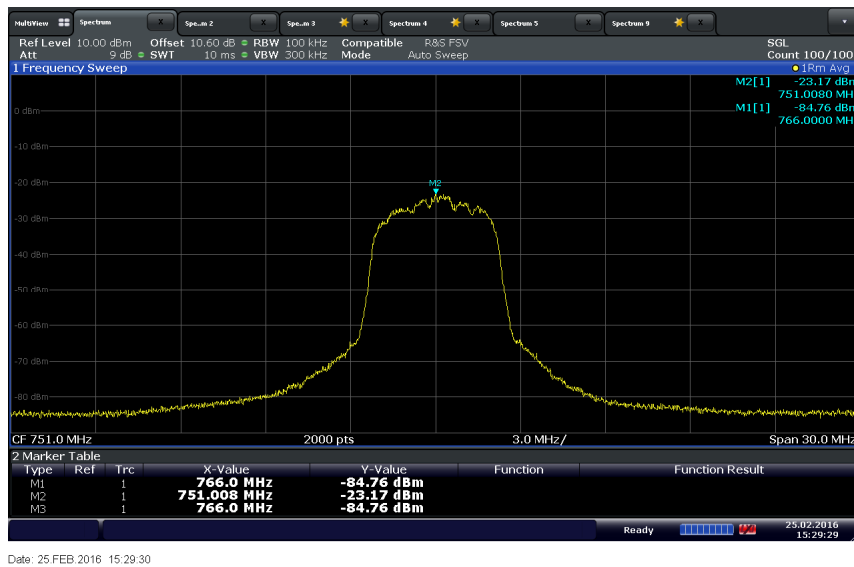



**LTE Band 13 Downlink Authorized Frequency Range (746 – 756 MHz)**  
**(MCC/MNC: 310/070)**

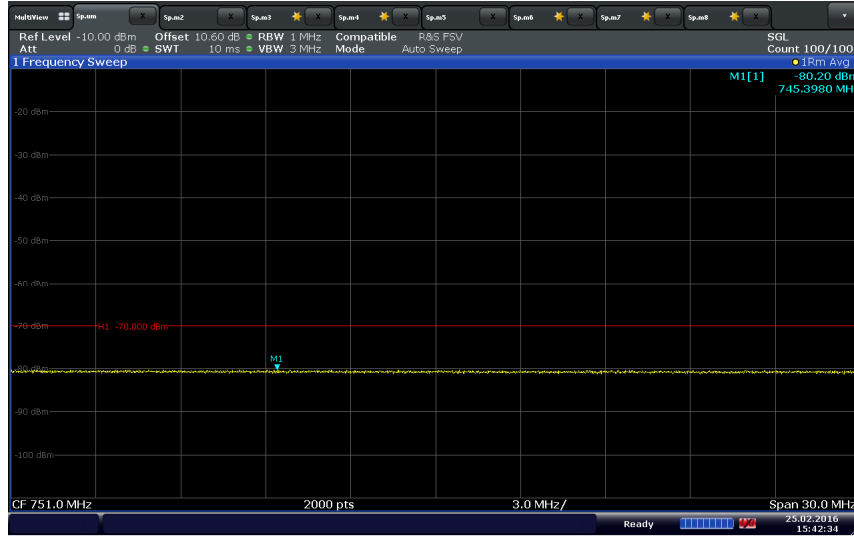

**LTE Band 13 Downlink Authorized Frequency Range (746 – 756 MHz)**  
**(MCC/MNC: 310/120)**

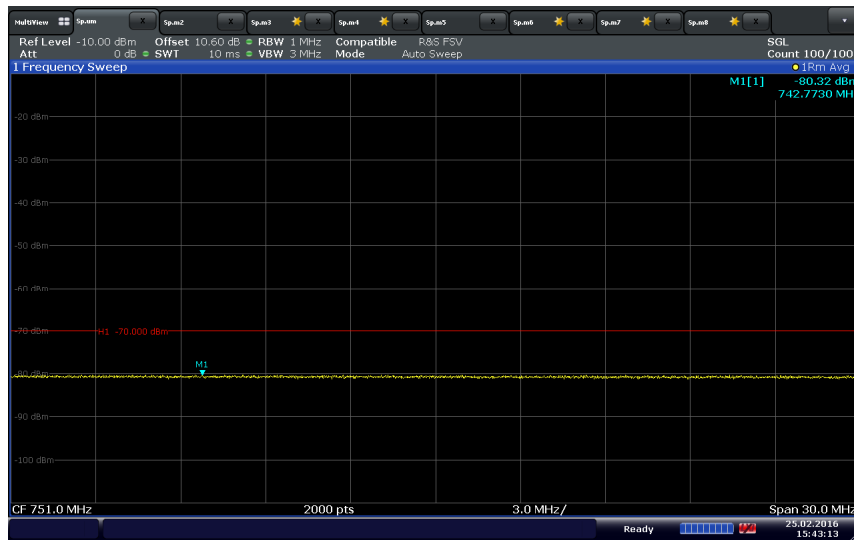



**LTE Band 13 Uplink Authorized Frequency Range (777 – 787 MHz)  
(MCC/MNC: 311/480)**

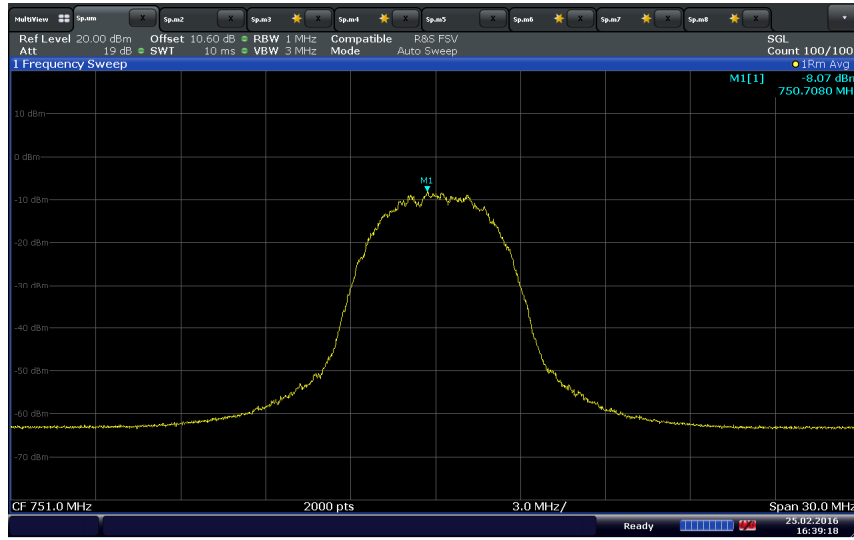

**LTE Band 13 Uplink Authorized Frequency Range (777 – 787 MHz)  
(MCC/MNC: 310/070)**





**LTE Band 13 Uplink Authorized Frequency Range (777 – 787 MHz)**  
**(MCC/MNC: 310/120)**

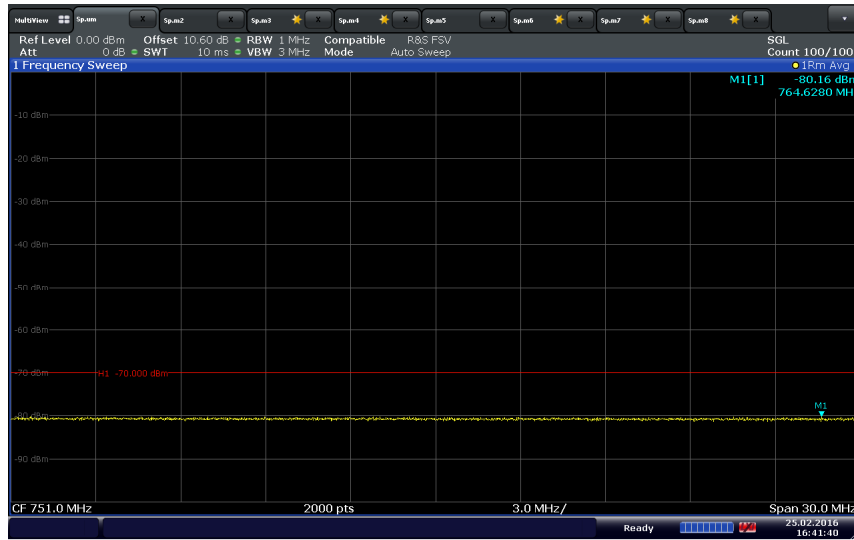

Date: 25.FEB.2016 16:41:41

**LTE Band 66 Downlink Authorized Frequency Range (2110 – 2180 MHz)**  
**(MCC/MNC: 311/480)**

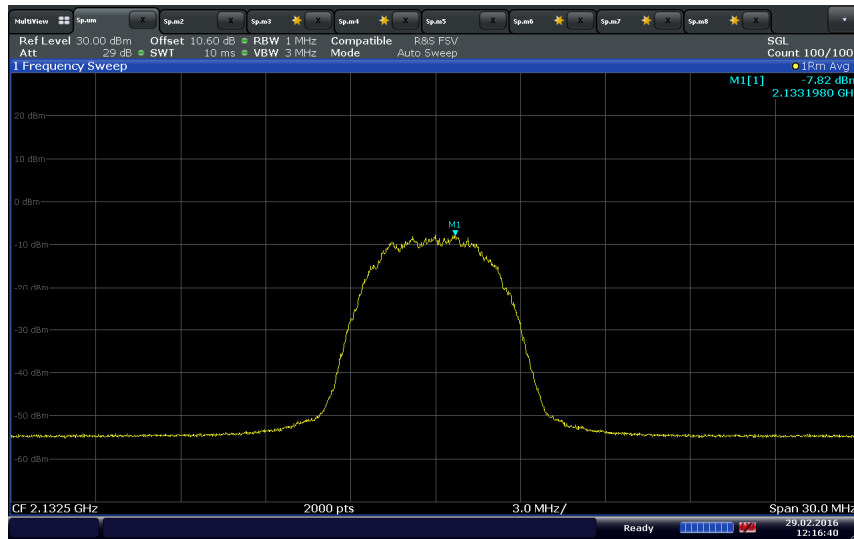

Date: 29.FEB.2016 12:16:40



**LTE Band 66 Downlink Authorized Frequency Range (2110 – 2180 MHz)**  
**(MCC/MNC: 310/070)**

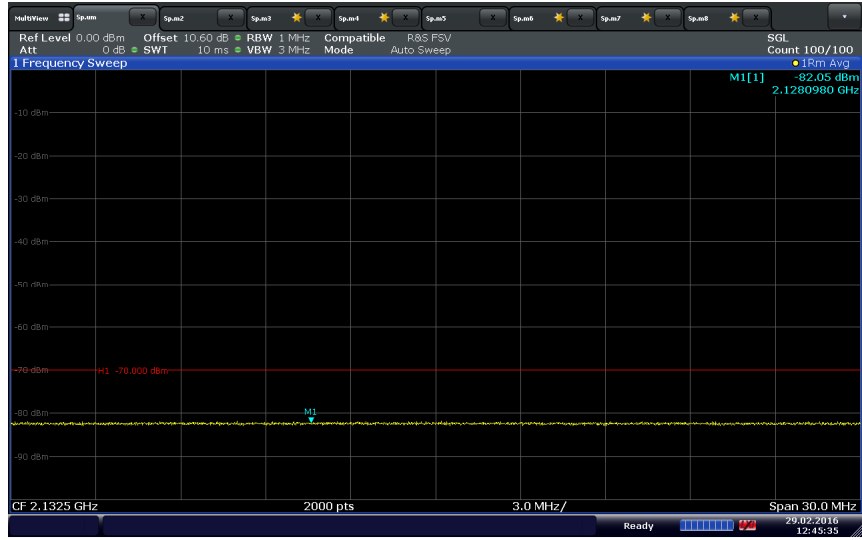

Date: 29 FEB. 2016 12:45:35

**LTE Band 66 Downlink Authorized Frequency Range (2110 – 2180 MHz)**  
**(MCC/MNC: 310/120)**

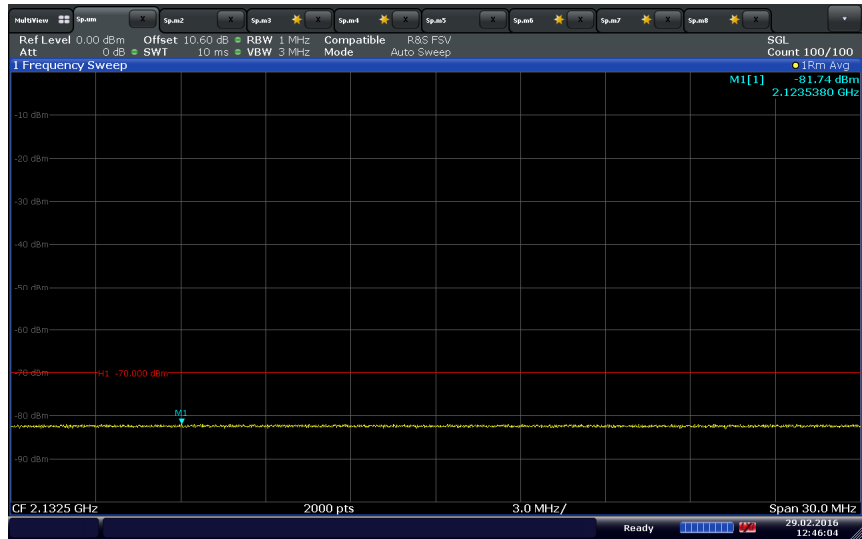

Date: 29 FEB. 2016 12:46:04





LTE Band 66 Uplink Authorized Frequency Range (1710 – 1780 MHz)  
(MCC/MNC: 311/480)

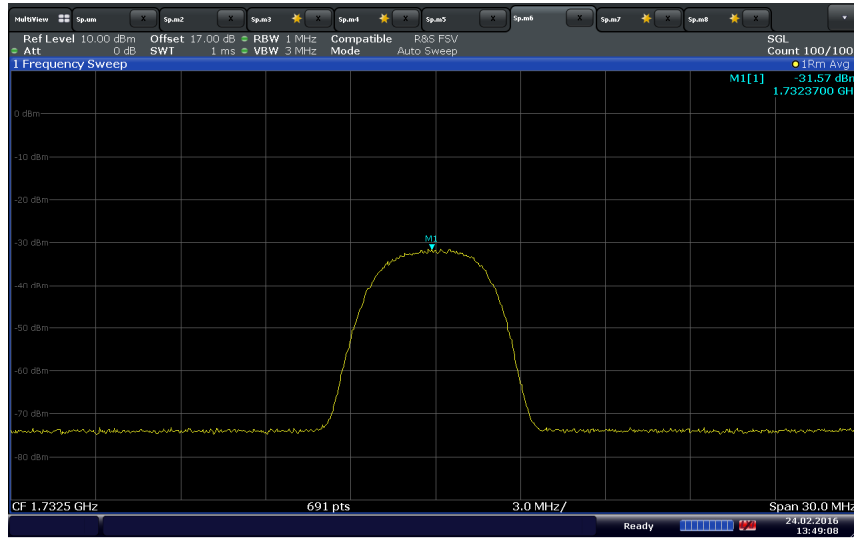

LTE Band 66 Uplink Authorized Frequency Range (1710 – 1780 MHz)  
(MCC/MNC: 310/070)

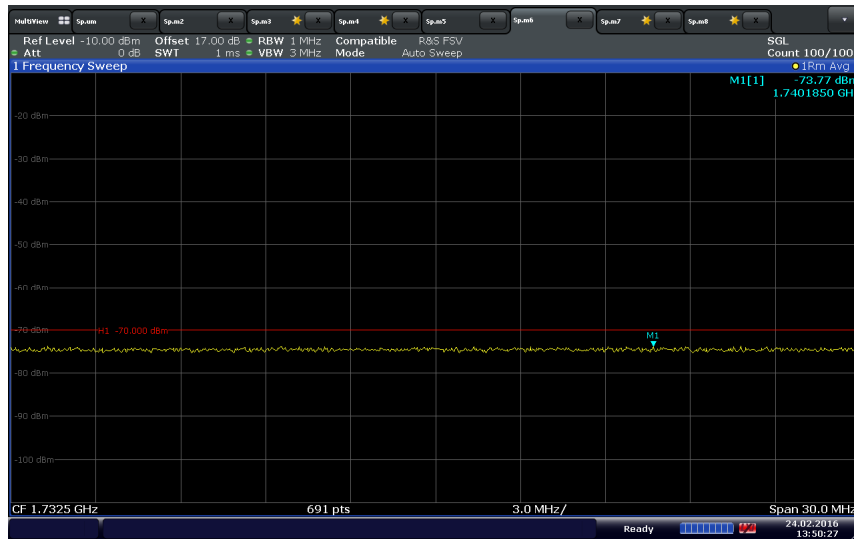



**LTE Band 66 Uplink Authorized Frequency Range (1710 – 1780 MHz)  
(MCC/MNC: 310/120)**

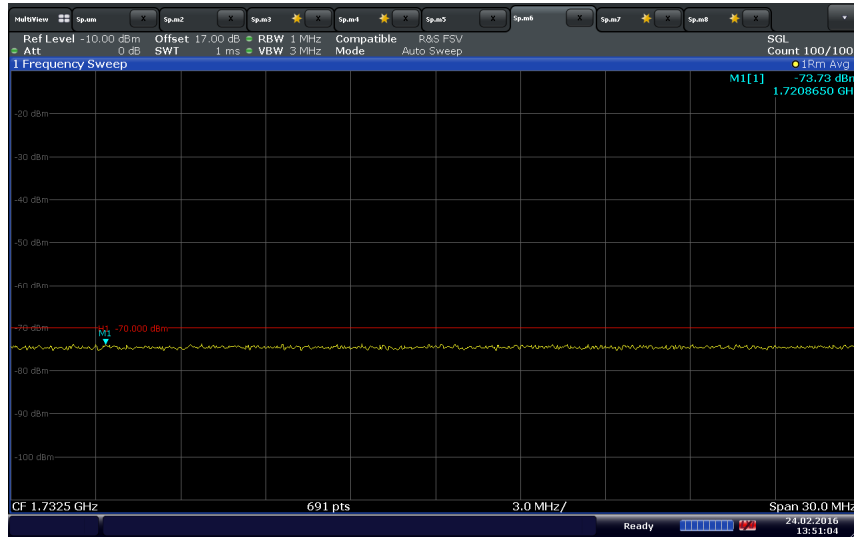

Date: 24 FEB 2016 13:51:04

**LTE Band 2 Downlink Inactive time after reset (>30s)**



Date: 10 FEB 2016 15:28:59



America

### LTE Band 2 Uplink Inactive time after reset

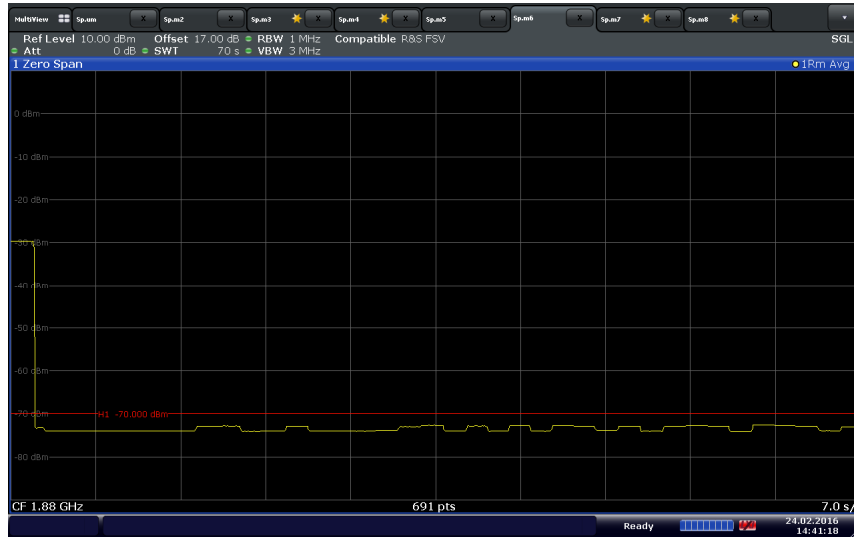

Date: 24 FEB 2016 14:41:18

### LTE Band 13 Downlink Inactive time after reset

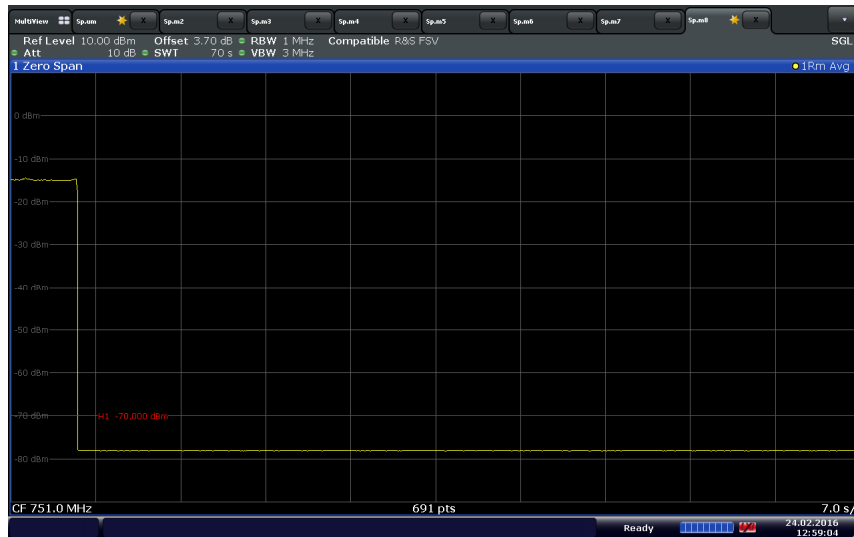

Date: 24 FEB 2016 12:59:04



America

### LTE Band 13 Uplink Inactive time after reset

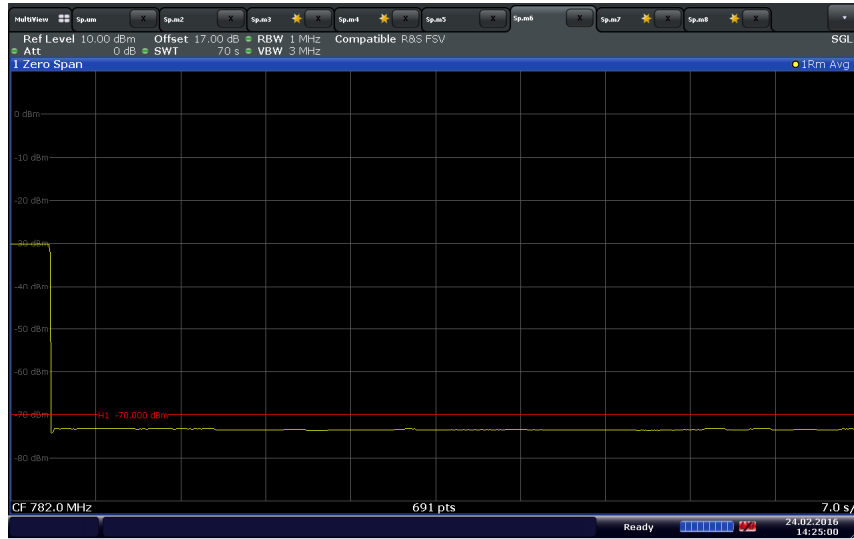

Date: 24 FEB.2016 14:25:01

### LTE Band 66 Downlink Inactive time after reset

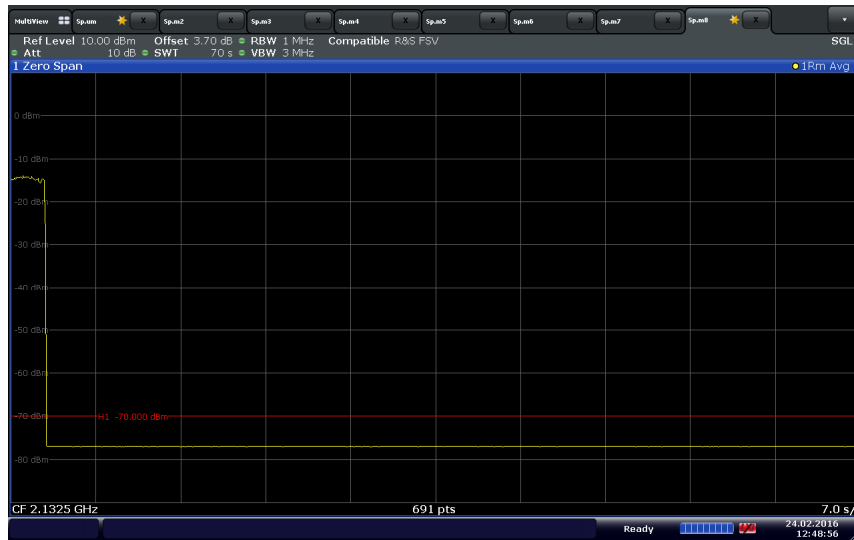

Date: 24 FEB.2016 12:48:56



America

### LTE Band 66 Uplink Inactive time after reset

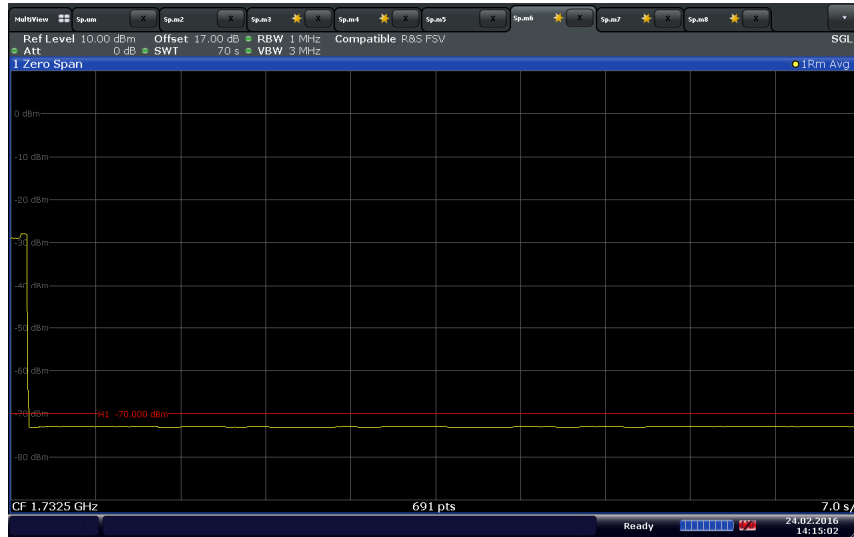

Date: 24 FEB.2016 14:15:02



## **2.3 MAXIMUM POWER MEASUREMENT AND BOOSTER GAIN COMPUTATION**

### **2.3.1 Specification Reference**

FCC 47 CFR Part 20, Clause 20.21(e)(9)(i)(D)  
FCC 47 CFR Part 20, Clause 20.21(e)(9)(i)(B)  
FCC 47 CFR Part 20, Clause 20.21(e)(9)(i)(C)(1) and (2)  
KDB935210 D04, Clause 7.2  
KDB935210 D04, Clause 7.3

### **2.3.2 Standard Applicable**

FCC 47 CFR Part 20, Clause 20.21(e)(9)(i)(B) Bidirectional Capability:  
Consumer Boosters must be able to provide equivalent (within 9dB as per ANSI ASC C63) uplink and downlink gain and conducted uplink power output that is at least 0.05 watts. One-way consumer boosters (i.e., uplink only, downlink only, uplink impaired, downlink impaired) are prohibited. Spectrum block filtering used must provide uplink filter attenuation not less than the downlink filter attenuation, and where RSSI is measured after spectrum block filtering is applied referenced to the booster's input port for each band of operation.

FCC 47 CFR Part 20, Clause 20.21(e)(9)(i)(D) Power Limits:  
A booster's uplink power must not exceed 1 watt composite conducted power and equivalent isotropic radiated power (EIRP) for each band of operation. Downlink power shall not exceed 0.05 watt (17dBm) composite and 10 dBm per channel conducted and EIRP for each band of operation. Compliance with power limits will use instrumentation calibrated in terms of RMS equivalent voltage.

FCC 47 CFR Part 20, Clause 20.21(e)(9)(i)(C) Booster Gain Limits.  
The gain of the frequency selective consumer booster shall meet the limits below.  
(1) The uplink and downlink gain in dB of a frequency selective consumer booster referenced to its input and output ports shall not exceed BSCL - 28 dB - (40 dB - MSCL).  
(2) The uplink and downlink maximum gain of a frequency selective consumer booster referenced to its input and output ports shall not exceed 19.5 dB + 20 Log (Frequency), or 100 dB for systems having automatic gain adjustment based on isolation measurements between booster donor and server antennas.  
Where, Frequency is the uplink midband frequency of the supported spectrum bands in MHz.

### **2.3.3 Equipment Under Test and Modification State**

Serial No: 951550000015 (NU and CU)/ Test Configuration A and B

### **2.3.4 Date of Test/Initial of test personnel who performed the test**

January 25 and February 22, 2016/XYZ

### **2.3.5 Test Equipment Used**

The major items of test equipment used for the above tests are identified in Section 3.1.



### 2.3.6 Environmental Conditions

Test performed at TÜV SÜD America Inc. Rancho Bernardo facility.

Ambient Temperature 22.5 - 25.3 °C  
 Relative Humidity 34.6 – 39.9 %  
 ATM Pressure 99.1 – 99.5 kPa

### 2.3.7 Additional Observations

- 1) This is conducted Test. Test procedure is per Section 7.2.2 of KDB935210 (D04 Provider Specific Booster Measurements v01r01). Appropriate offset (line losses) applied.
- 2) The EUT operated in Test Mode, with the gain manually set to the maximum gain and a minimum bandwidth setting (5MHz).
- 3) Setup the EUT according to Figure 2 or 3 of Section 6.3.3 of KDB935210 (D04 Provider Specific Booster Measurements v01r01) as appropriate.
- 4) Evaluations are conducted at CU antenna ports B2/13 and B66, and NU antenna ports B2/13 and B66.
- 5) Maximum Gain of the booster was calculated.
- 6) The Gain with Maximum Transmitter Input Level (-20dBm for Downlink and 0dBm for Uplink) injected was also calculated.
- 7) Operational uplink and downlink bands for LTE Band 2, 13 and 66 were tested.
- 8) The signal generator was set to transmit a 4.1MHz AWGN signal.

### 2.3.8 Test Results

Maximum Gain/Maximum Power										
Band	Frequency Range (MHz)	Input Power (dBm)	Output Power (dBm)	Antenna Gain (dB)	EIRP (dBm)	EIRP Limit (dBm)	Gain (dB)	Gain Limit (dB)	UL vs DL Gain	UL vs DL Gain Limit
Band 2 Downlink	1930 - 1990	-87.12	7.85	2	10.85	<17	94.97	100	1.09	9
Band 2 Uplink	1850 - 1910	-76.12	19.94	2	21.94	17-30	96.06	100		
Band 13 Downlink	746 - 756	-82.6	8.21	0	8.21	<17	90.81	100	6.29	9
Band 13 Uplink	777 - 787	-77.1	20.90	0	20.90	17-30	97.10	100		
Band 66 Downlink	2110 - 2200	-88.38	10.59	2	12.59	<17	98.47	100	0.67	9
Band 66 Uplink	1710 - 1780	-76.31	21.09	2	23.09	17-30	97.8	100		



America

Maximum Gain/Maximum Power with Maximum Transmitter Input Level								
Band	Frequency Range (MHz)	Input Power (dBm)	Output Power (dBm)	Antenna Gain (dB)	EIRP (dBm)	EIRP Limit (dBm)	Gain (dB)	Gain Limit (dB)
Band 2 Downlink	1930 - 1990	-20	8.14	2	10.14	<17	28.14	100
Band 2 Uplink	1850 - 1910	0	19.87	2	21.87	17-30	19.87	100
Band 13 Downlink	746 - 756	-20	8.32	0	8.32	<17	28.32	100
Band 13 Uplink	777 - 787	0	20.46	0	20.46	17-30	20.46	100
Band 66 Downlink	2110 - 2180	-20	10.56	2	12.56	<17	30.56	100
Band 66 Uplink	1710 - 1780	0	20.95	2	22.95	17-30	20.95	100





## **2.4 INTERMODULATION PRODUCT**

### **2.4.1 Specification Reference**

FCC 47 CFR Part 20. Clause 20.21(e)(9)(i)(G)  
KDB935210 D04, Clause 7.4

### **2.4.2 Standard Applicable**

FCC 47 CFR Part 20. Clause 20.21(e)(9)(i)(G) Intermodulation Limits:  
The transmitted intermodulation products of a consumer booster at its uplink and downlink ports shall not exceed the power level of -19 dBm for the supported bands of operation. Compliance with intermodulation limits will use boosters operating at maximum gain and maximum rated output power, with two continuous wave (CW) input signals spaced 600 kHz apart and centered in the pass band of the booster, and with a 3 kHz measurement bandwidth.

### **2.4.3 Equipment Under Test and Modification State**

Serial No: 951550000015 (NU and CU) / Test Configuration E

### **2.4.4 Date of Test/Initial of test personnel who performed the test**

January 27 and February 23, 2016/XYZ

### **2.4.5 Test Equipment Used**

The major items of test equipment used for the above tests are identified in Section 3.1.

### **2.4.6 Environmental Conditions**

Test performed at TÜV SÜD America Inc. Rancho Bernardo facility.

Ambient Temperature	24.8 - 26.1 °C
Relative Humidity	20.1 - 29.0 %
ATM Pressure	99.1 - 99.9 kPa

### **2.4.7 Additional Observations**

- 1) This is conducted Test. Test procedure is per Section 7.4 of KDB935210 (D04 Provider Specific Booster Measurements v01r01). Appropriate offset (line losses) applied.
- 2) The EUT operated in Test Mode with the gain manually set to the maximum gain and a minimum bandwidth setting (5MHz).
- 3) Setup the EUT according to Figure 4 of Section 7.4 of KDB935210 (D04 Provider Specific Booster Measurements v01r01).
- 4) Evaluations are conducted at CU antenna ports B2/13 and B66, and NU antenna ports B2/13 and B66.
- 5) Operational uplink and downlink bands for LTE Band 2, 13 and 66 were tested.



6) Signal: 4.1MHz AWGN.

### 2.4.8 Test Results

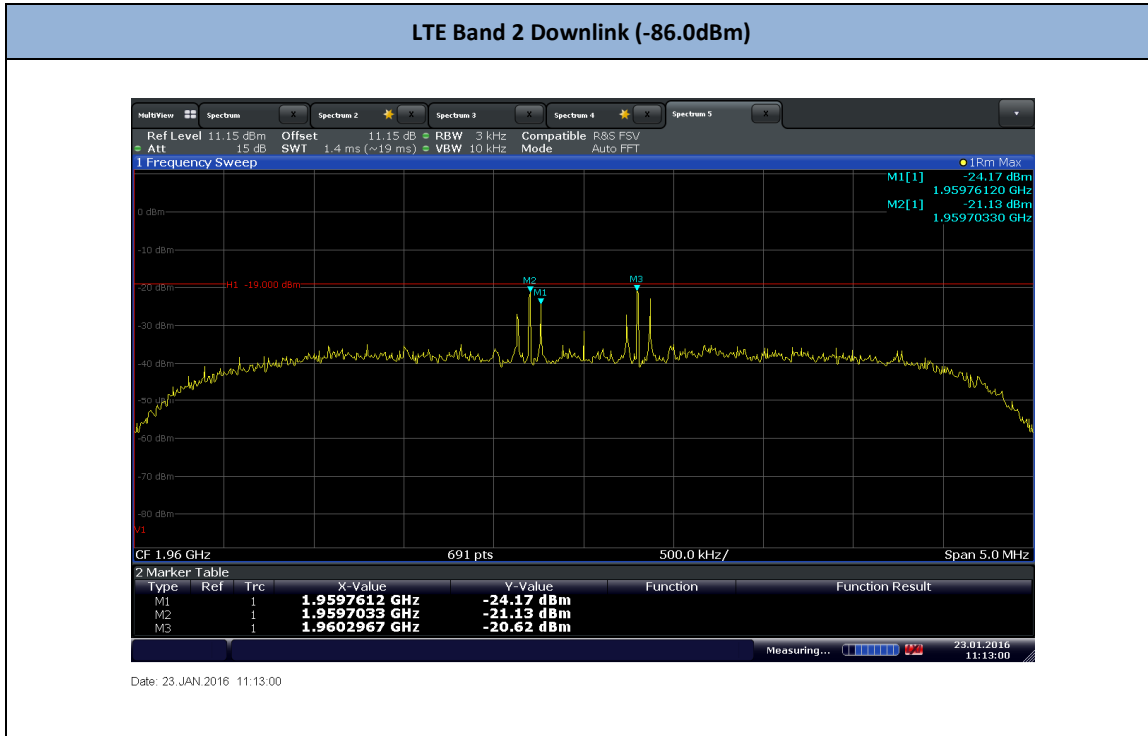



America

### LTE Band 2 Downlink (-76.0dBm)

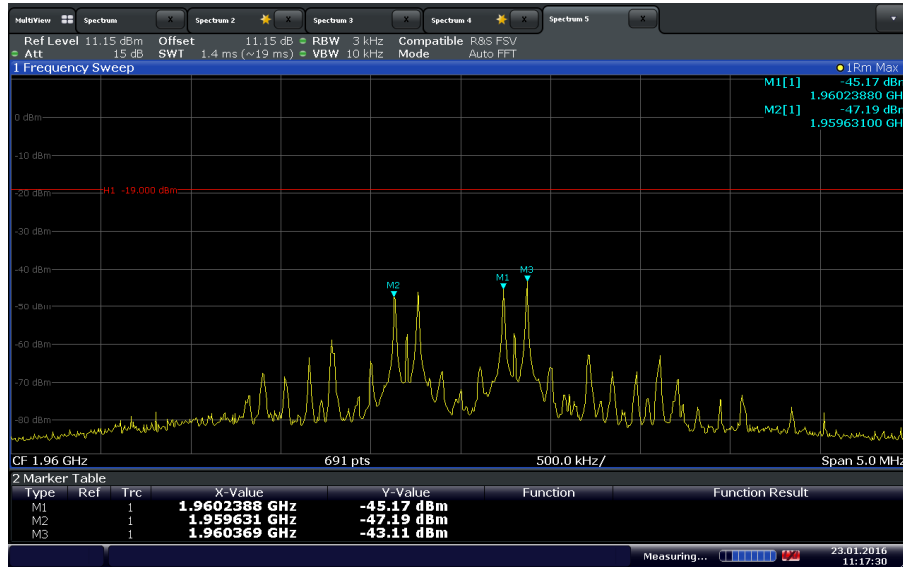

Date: 23. JAN.2016 11:17:31

### LTE Band 2 Uplink (-75.0dBm)

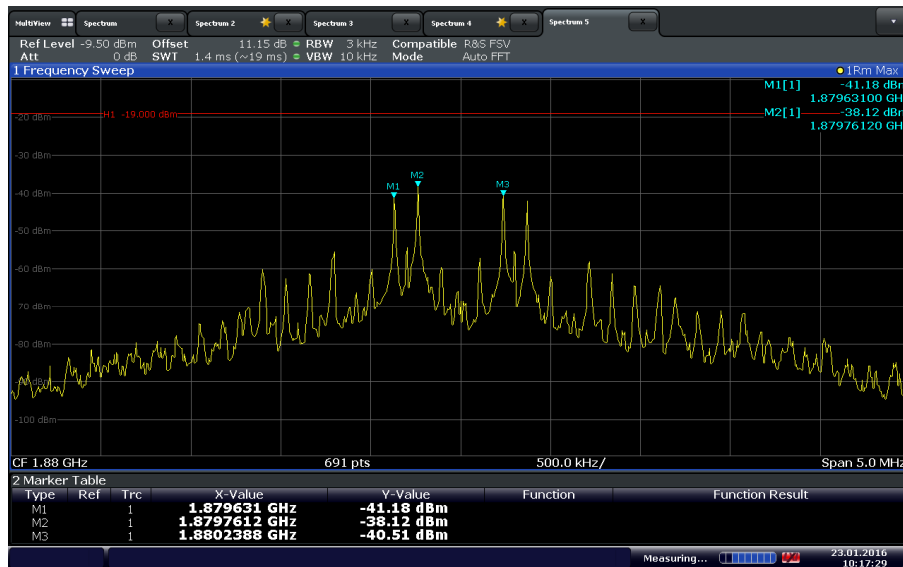

Date: 23. JAN.2016 10:17:29



### LTE Band 2 Uplink (-65.0dBm)

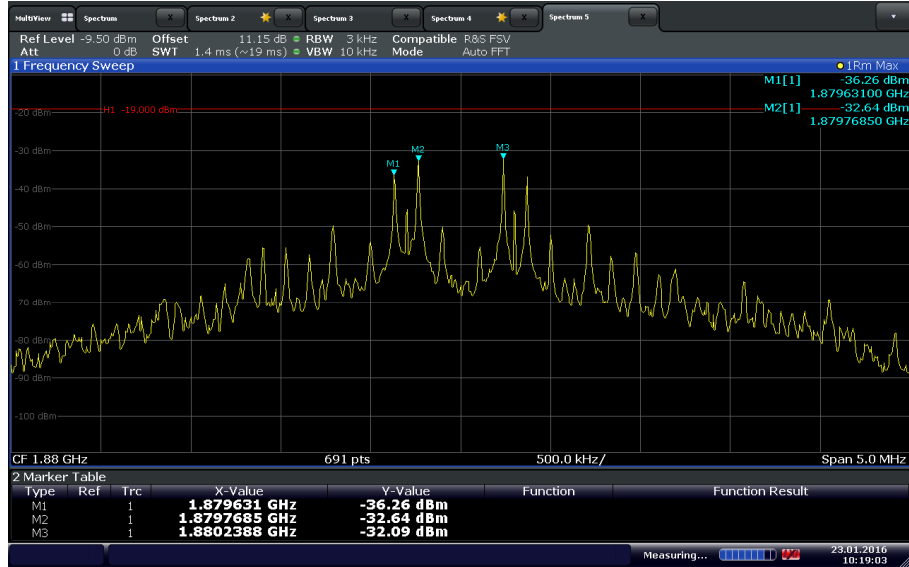

Date: 23 JAN 2016 10:19:03

### LTE Band 13 Downlink (-82.0dBm)

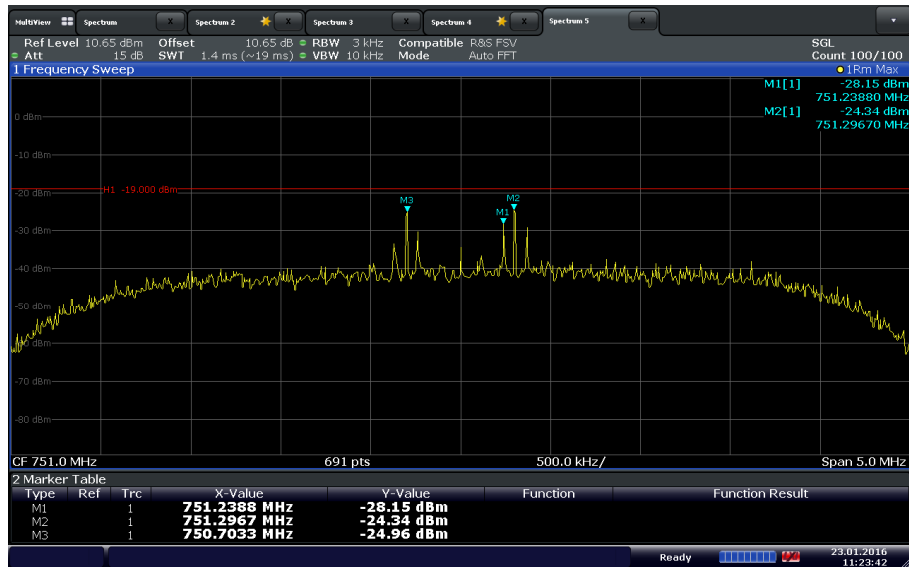

Date: 23 JAN 2016 11:23:41



### LTE Band 13 Downlink (-72.0dBm)

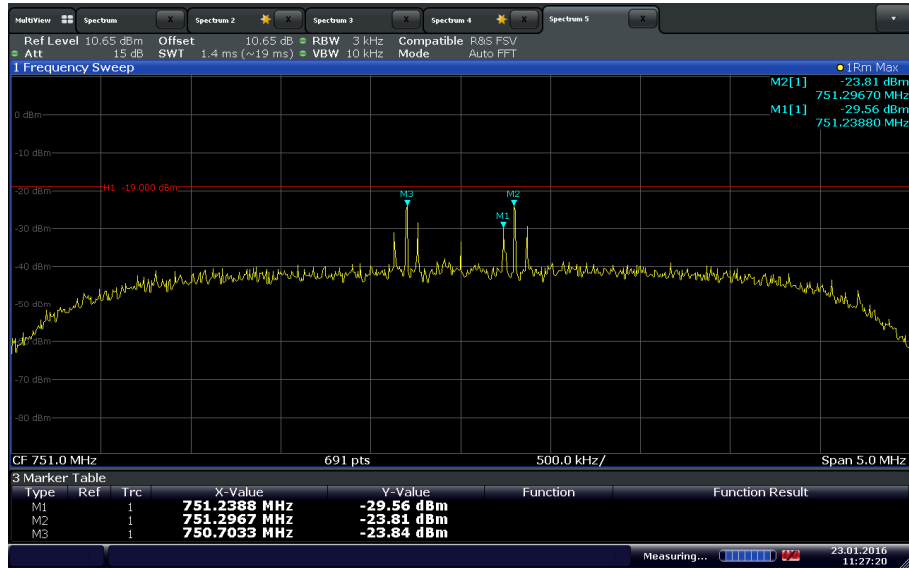

Date: 23.JAN.2016 11:27:20

### LTE Band 13 Uplink (-76.5dBm)

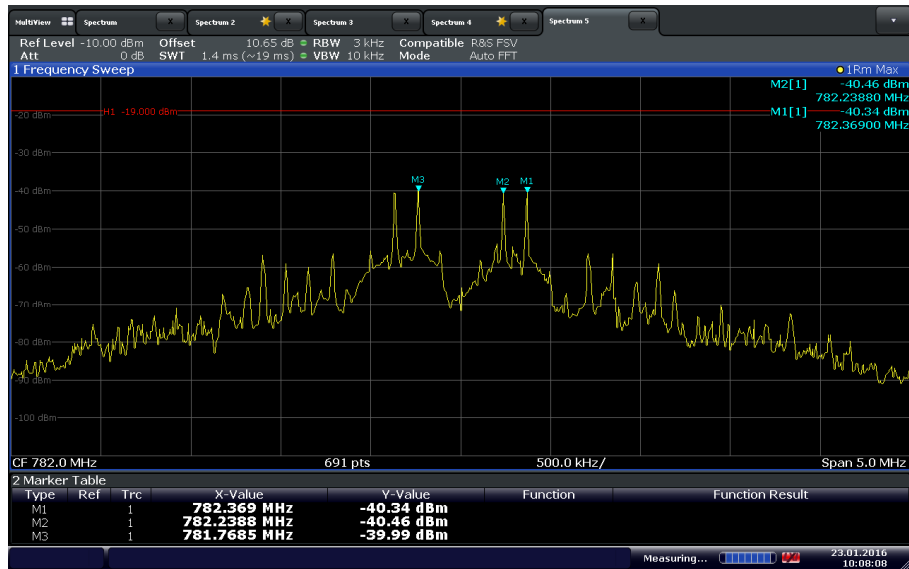

Date: 23.JAN.2016 10:08:08



### LTE Band 13 Uplink (-66.5dBm)

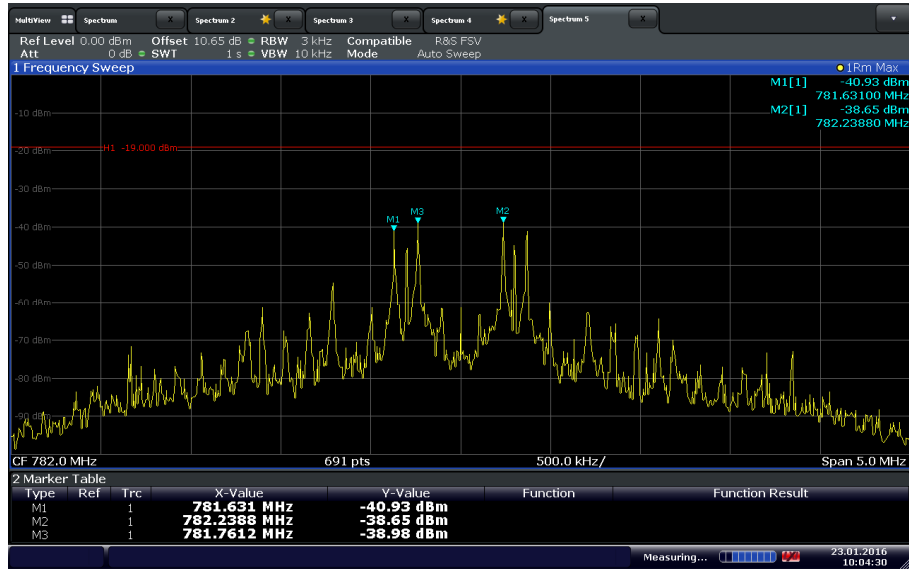

Date: 23.JAN.2016 10:04:30

### LTE Band 66 Downlink (-88.0 dBm)

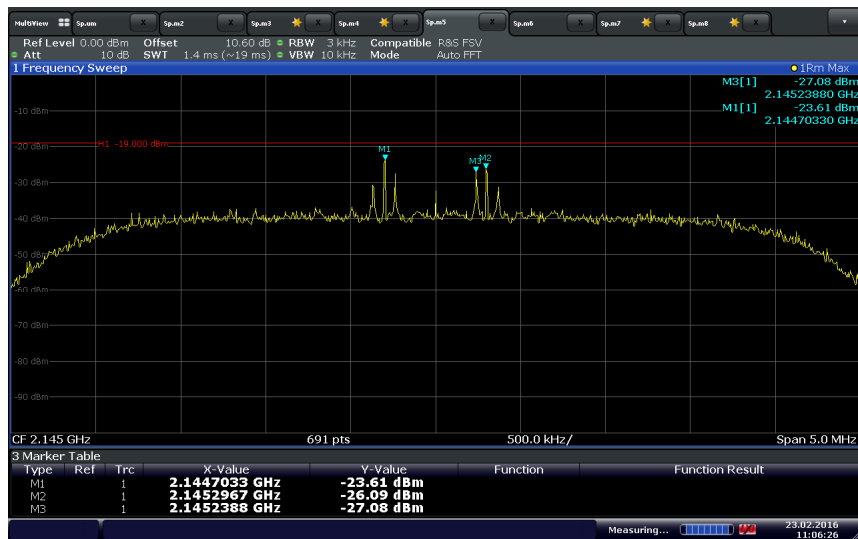

Date: 23.FEB.2016 11:06:26



### LTE Band 66 Downlink (-78.0 dBm)

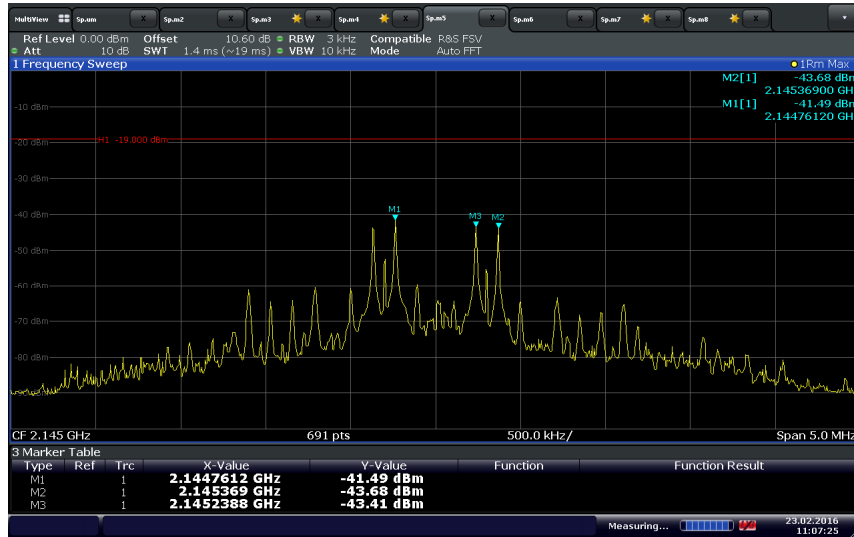

Date: 23.FEB.2016 11:07:25

### LTE Band 66 Uplink (-76.0 dBm)

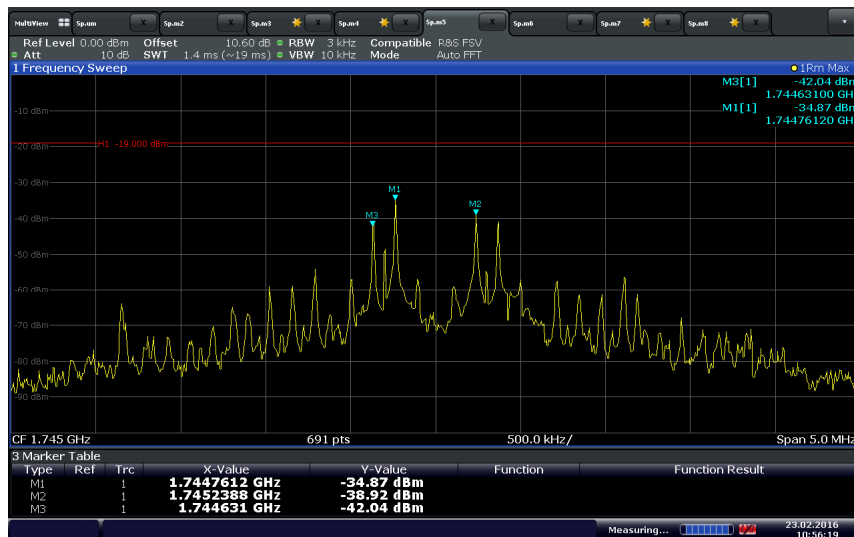

Date: 23.FEB.2016 10:56:18



LTE Band 66 Uplink (-66.0dBm)

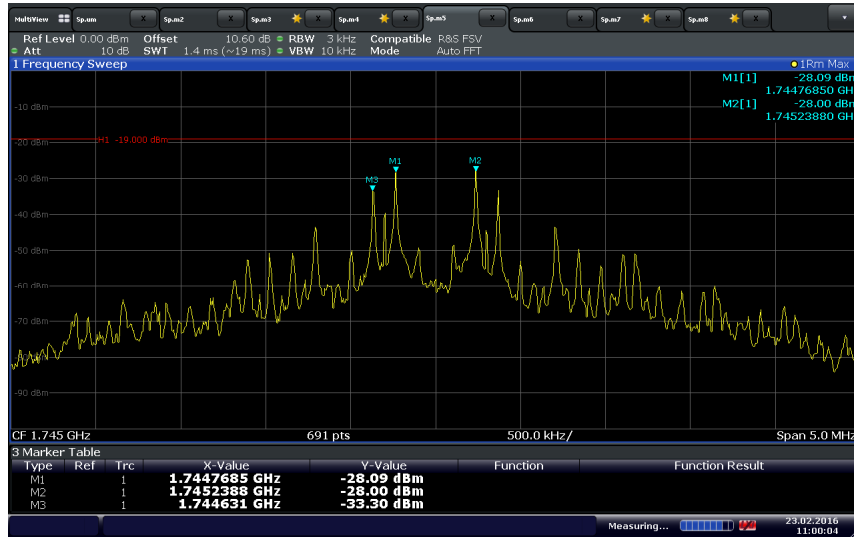

Date: 23 FEB 2016 11:00:03





## **2.5 OUT OF BAND EMISSIONS**

### **2.5.1 Specification Reference**

FCC 47 CFR Part 20. Clause 20.21(e)(9)(i)(F)  
KDB935210 D04, Clause 7.5

### **2.5.2 Standard Applicable**

FCC 47 CFR Part 20. Clause 20.21(e)(9)(i)(F) Out of Band Emissions Limits:  
Booster out of band emissions (OOBE) shall meet the FCC's mobile emission limits for the supported bands of operation. Compliance to OOBE limits will utilize high peak-to-average CMRS signal types..

### **2.5.3 Equipment Under Test and Modification State**

Serial No: 951550000015 (NU and CU) / Test Configuration A

### **2.5.4 Date of Test/Initial of test personnel who performed the test**

January 26 and February 23, 2016/XYZ

### **2.5.5 Test Equipment Used**

The major items of test equipment used for the above tests are identified in Section 3.1.

### **2.5.6 Environmental Conditions**

Test performed at TÜV SÜD America Inc. Rancho Bernardo facility.

Ambient Temperature	22.7 - 26.1 °C
Relative Humidity	28.4 - 29.0 %
ATM Pressure	99.1 - 99.9kPa

### **2.5.7 Additional Observations**

- 1) This is conducted Test. Test procedure is per Section 7.5 of KDB935210 (D04 Provider Specific Booster Measurements v01r01). Appropriate offset (line losses) applied.
- 2) The EUT operated in Test Mode, with the gain manually set to the maximum gain and a minimum bandwidth setting (5MHz).
- 3) Evaluations are conducted at CU antenna ports B2/13 and B66, and NU antenna ports B2/13 and B66.
- 4) Operational uplink and downlink bands for LTE Band 2, 13 and 66 were tested.
- 5) Signal: 4.1MHz AWGN.



### 2.5.8 Test Results

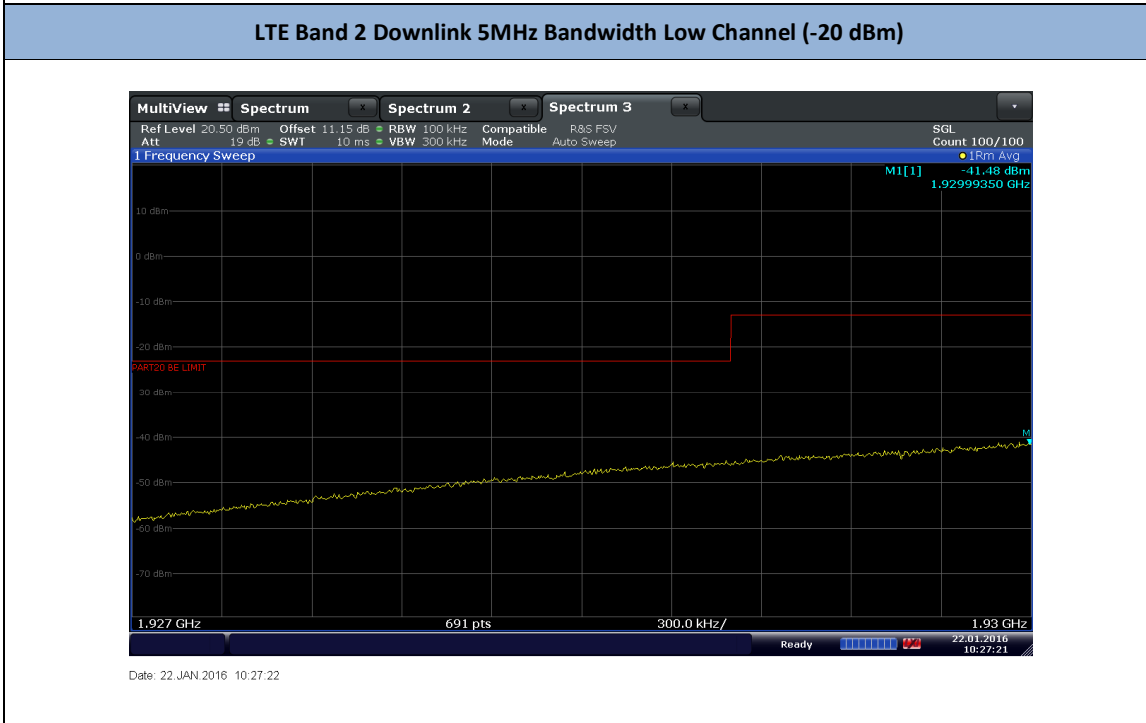
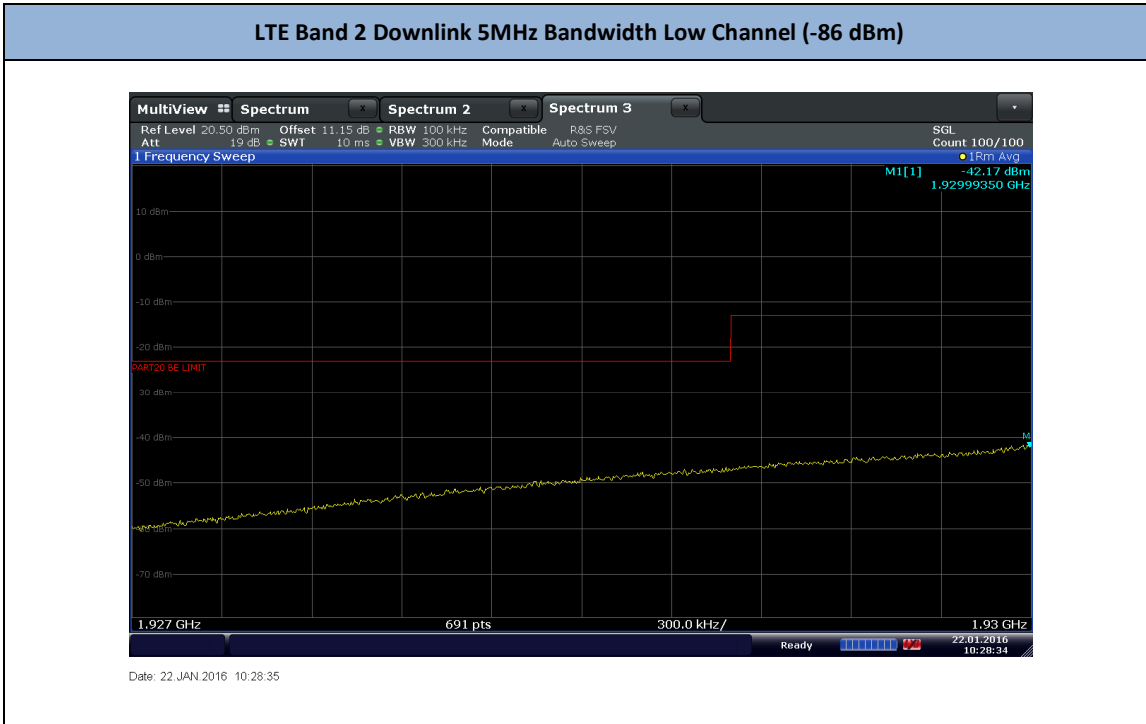



### LTE Band 2 Downlink 5MHz Bandwidth High Channel (-86 dBm)

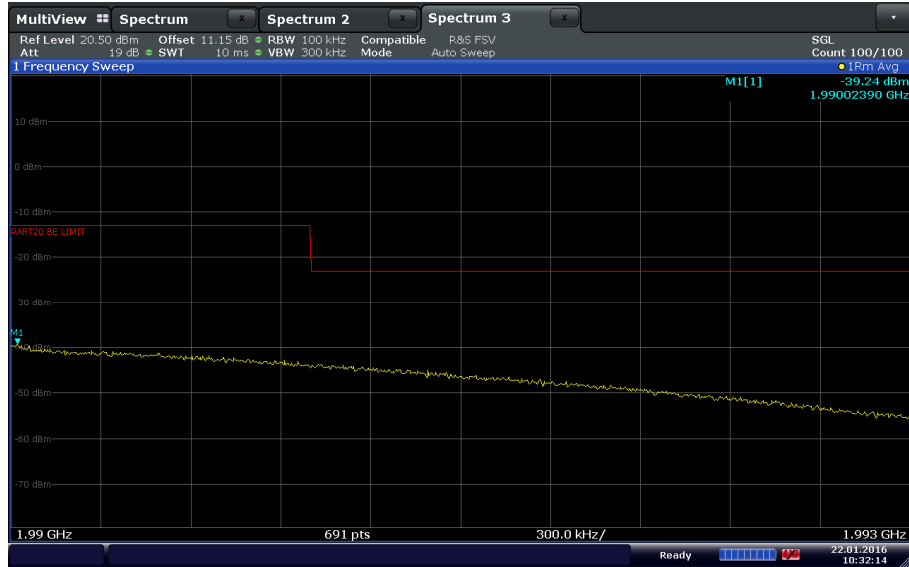

Date: 22.JAN.2016 10:32:15

### LTE Band 2 Downlink 5MHz Bandwidth High Channel (-20 dBm)

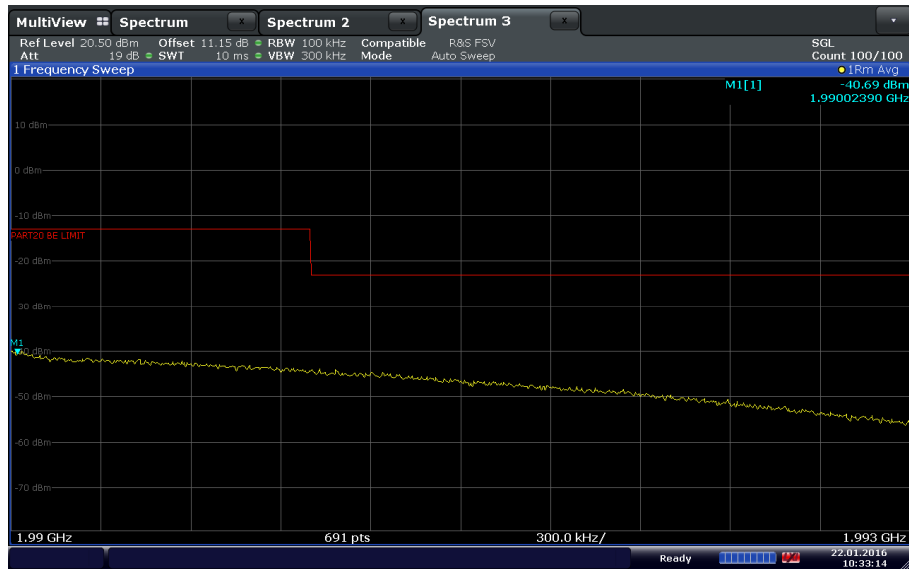

Date: 22.JAN.2016 10:33:14



America

### LTE Band 13 Downlink 5MHz Bandwidth Low Channel (-82 dBm)

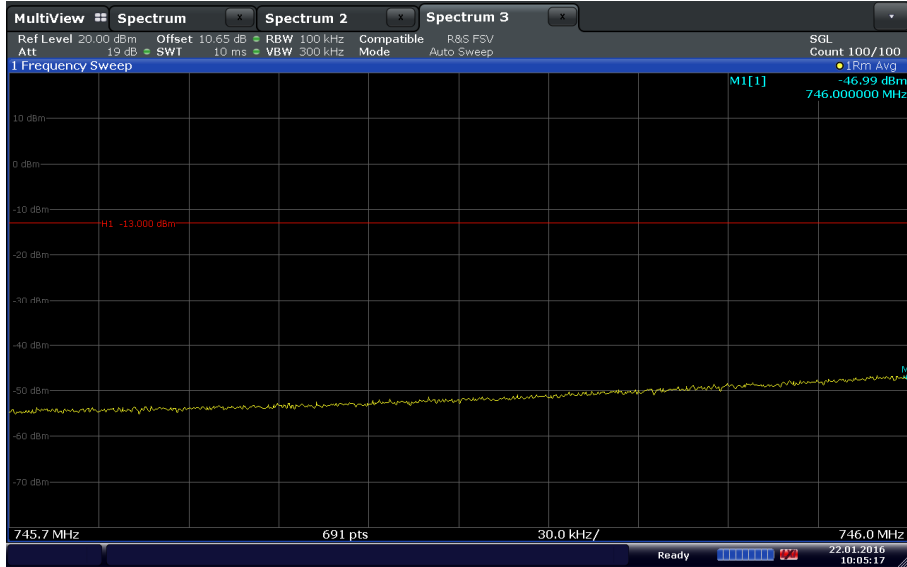

Date: 22.JAN.2016 10:05:17

### LTE Band 13 Downlink 5MHz Bandwidth Low Channel (-20 dBm)

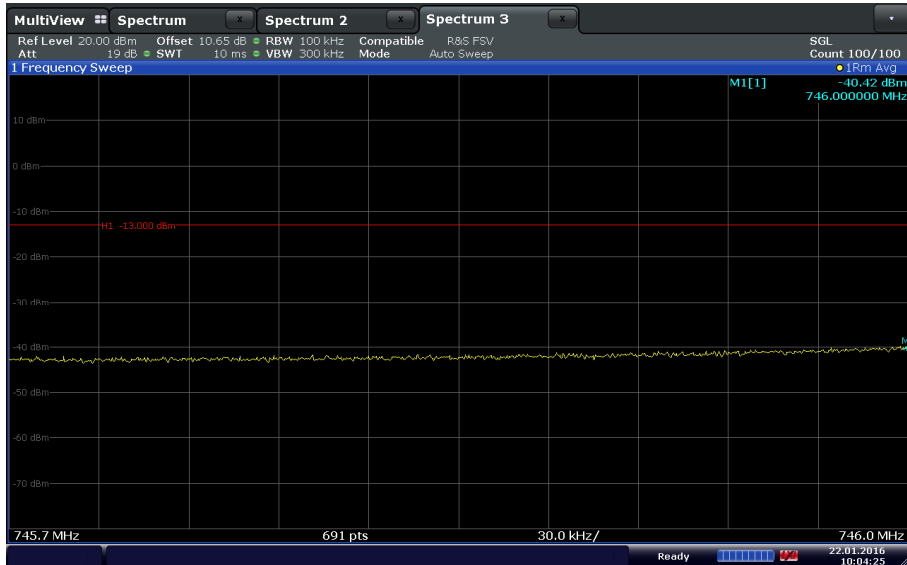

Date: 22.JAN.2016 10:04:25



America

### LTE Band 13 Downlink 5MHz Bandwidth High Channel (-82 dBm)

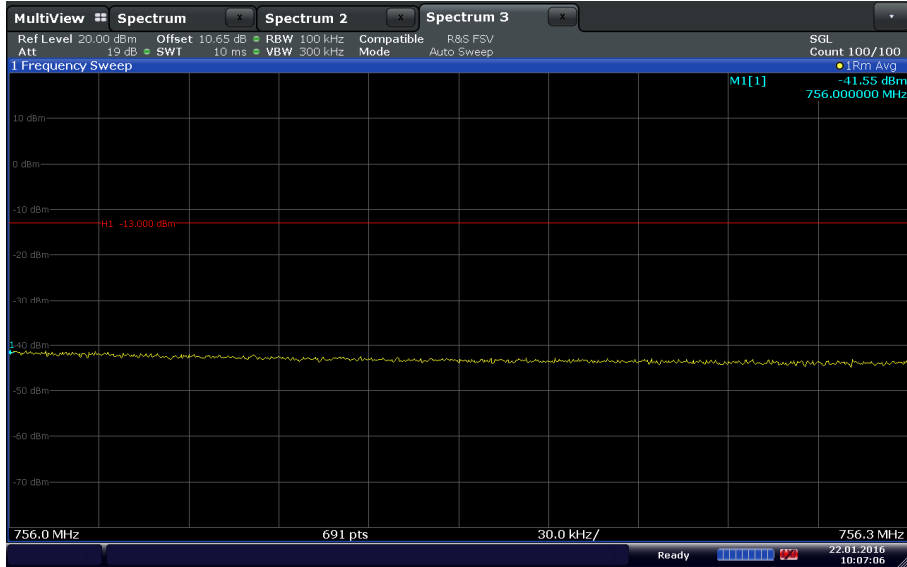

Date: 22.JAN.2016 10:07:05

### LTE Band 13 Downlink 5MHz Bandwidth High Channel (-20 dBm)

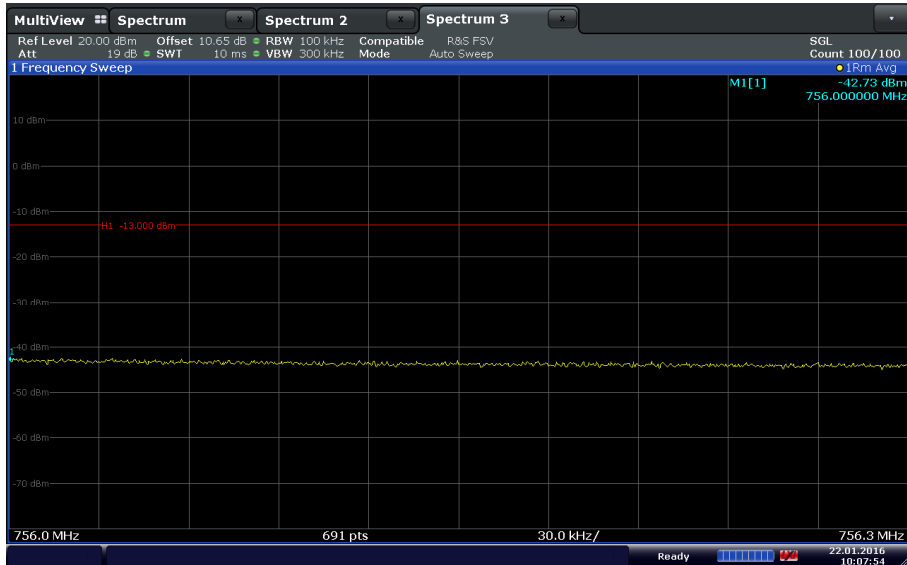

Date: 22.JAN.2016 10:07:54



### LTE Band 66 Downlink 5MHz Bandwidth Low Channel (-88 dBm)

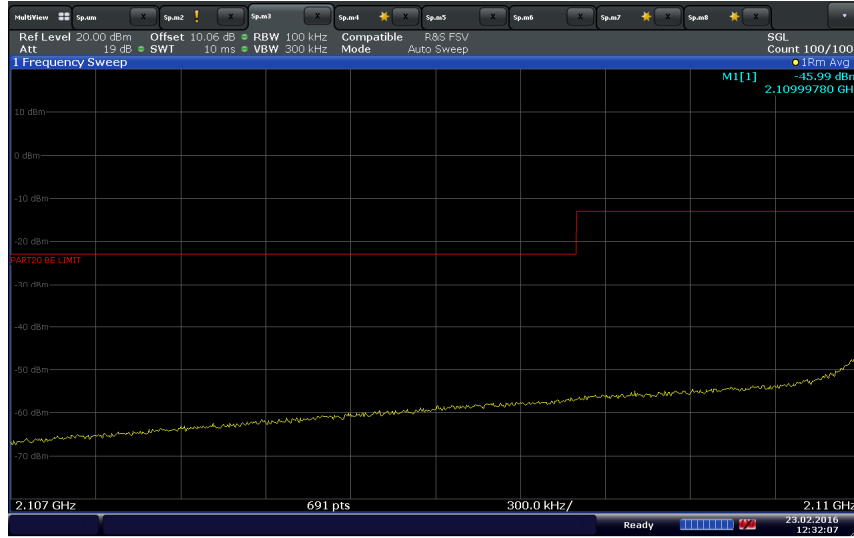

Date: 23 FEB.2016 12:32:07

### LTE Band 66 Downlink 5MHz Bandwidth Low Channel (-20 dBm)

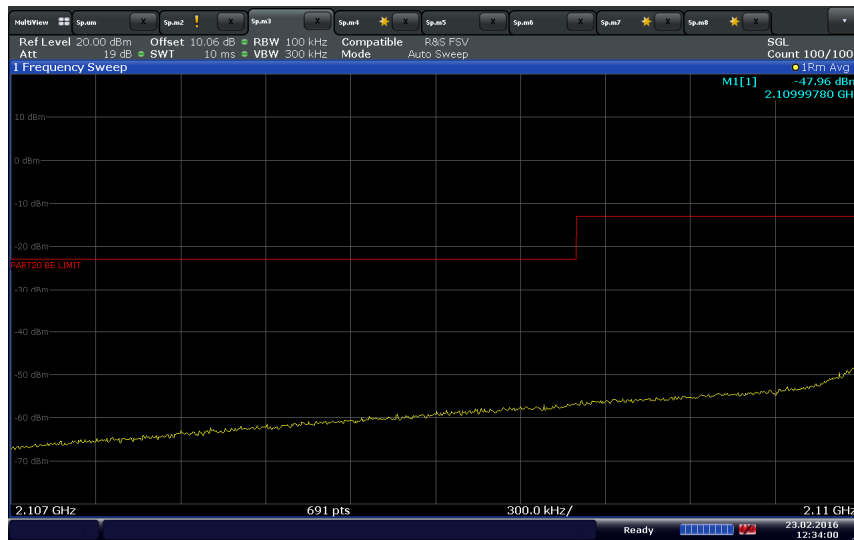

Date: 23 FEB.2016 12:34:00



### LTE Band 66 Downlink 5MHz Bandwidth High Channel (-88 dBm)

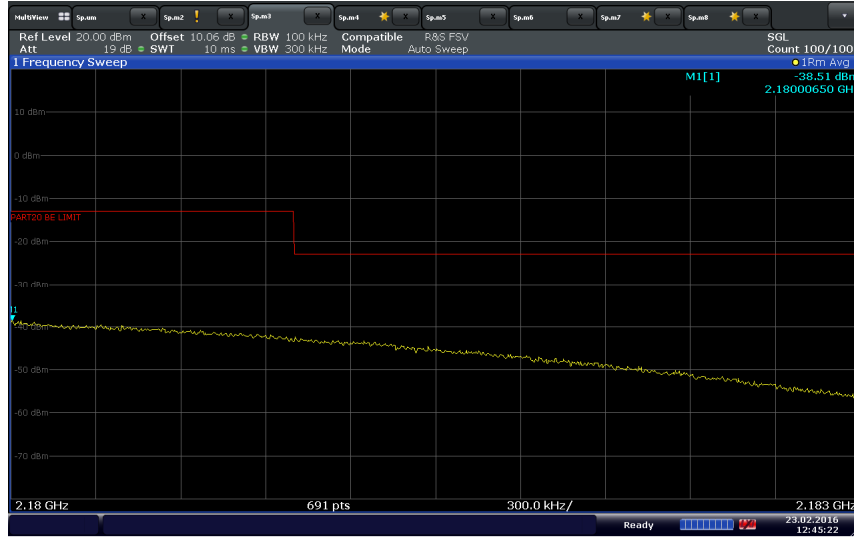

### LTE Band 66 Downlink 5MHz Bandwidth High Channel (-20 dBm)

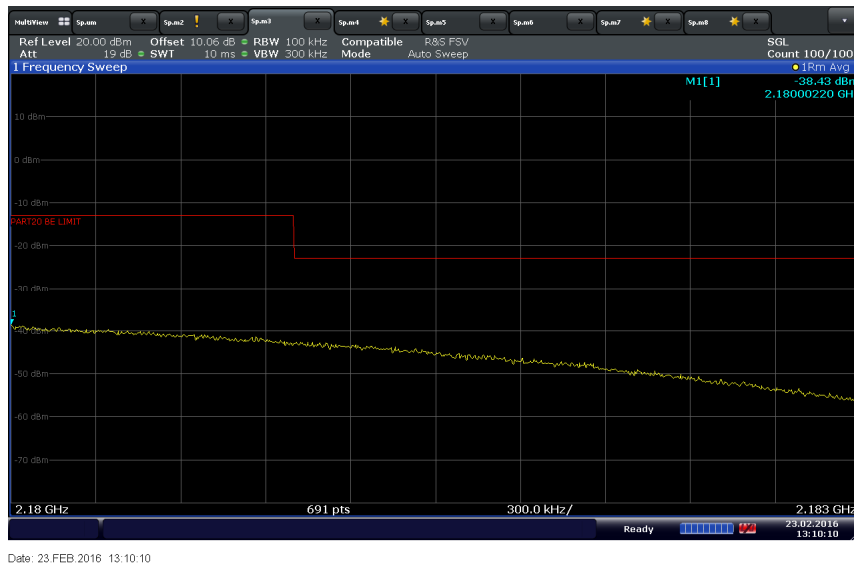



### LTE Band 2 Uplink 5MHz Bandwidth Low Channel (-75 dBm)

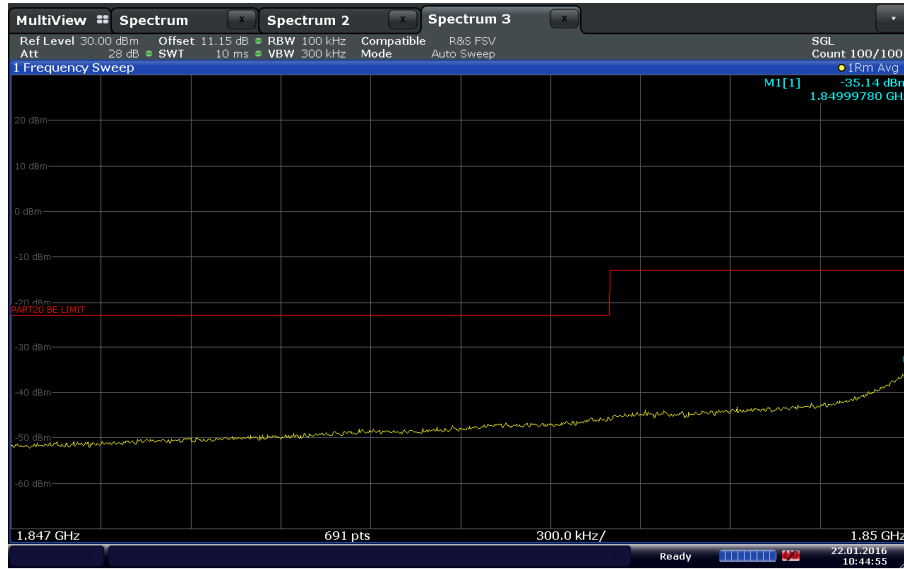

### LTE Band 2 Uplink 5MHz Bandwidth Low Channel (0 dBm)

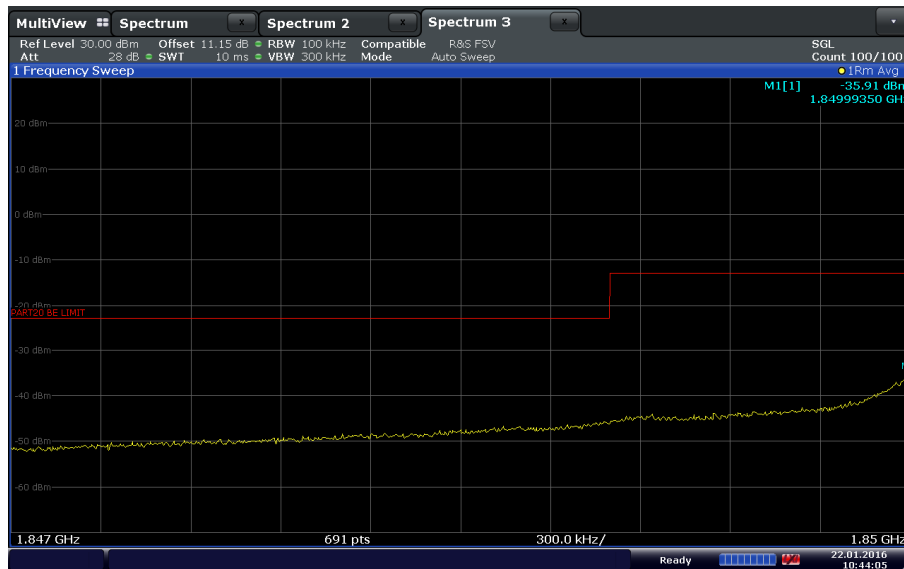





### LTE Band 2 Uplink 5MHz Bandwidth High Channel (-75 dBm)

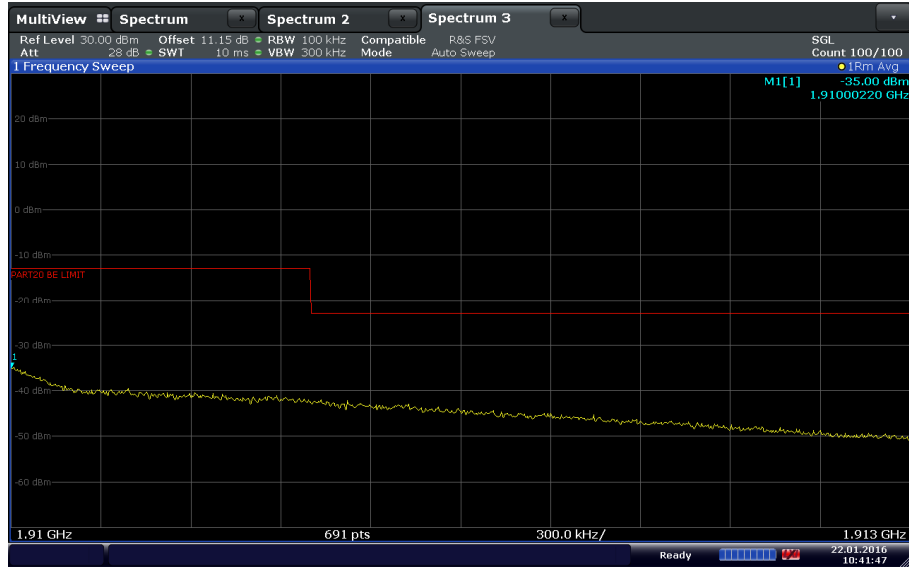

Date: 22.JAN.2016 10:41:47

### LTE Band 2 Uplink 5MHz Bandwidth High Channel (0 dBm)

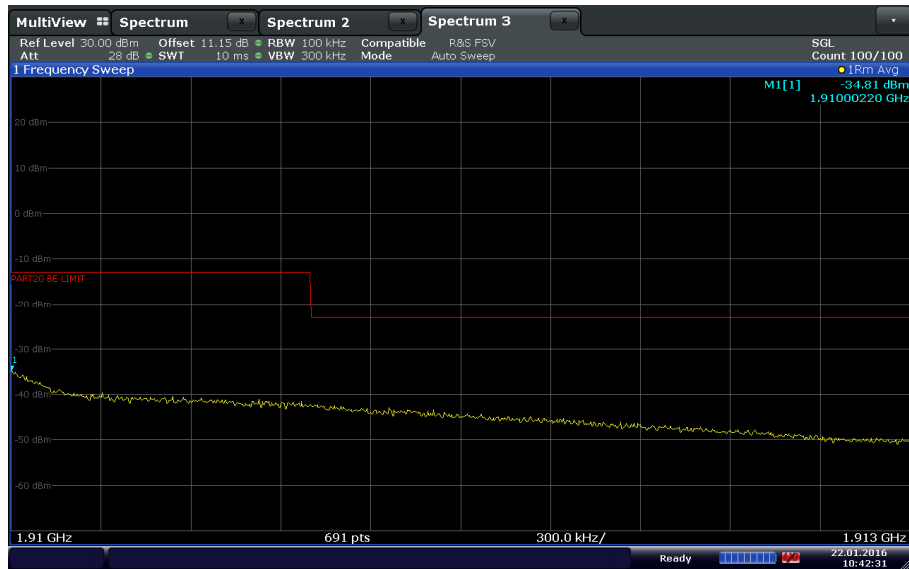

Date: 22.JAN.2016 10:42:31



America

### LTE Band 13 Uplink 5MHz Bandwidth Low Channel (-76.5 dBm)

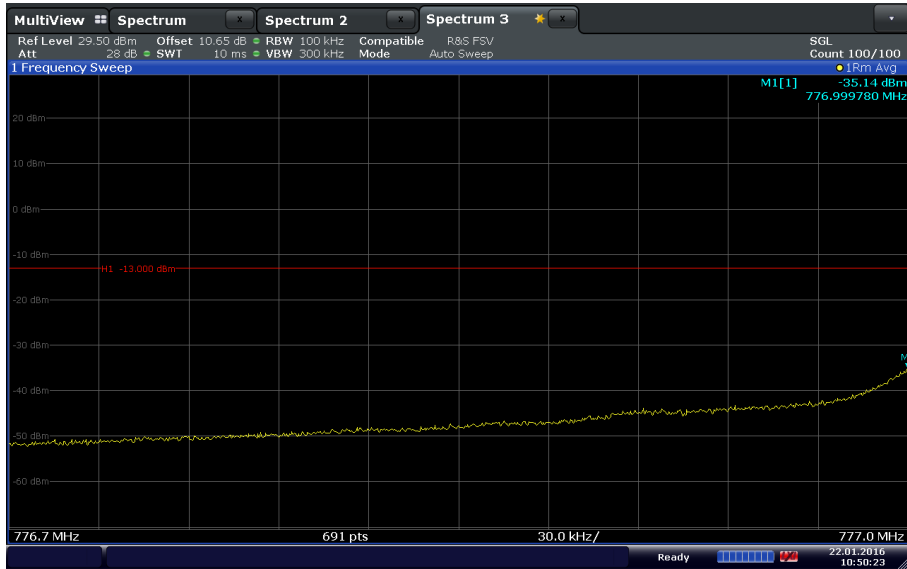

Date: 22.JAN.2016 10:50:24

### LTE Band 13 Uplink 5MHz Bandwidth Low Channel (0 dBm)

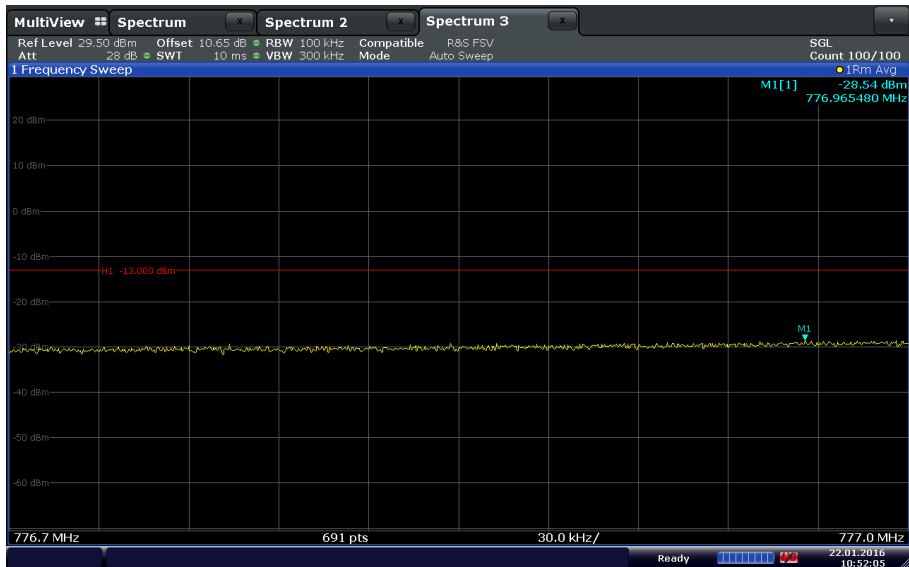

Date: 22.JAN.2016 10:52:05



America

### LTE Band 13 Uplink 5MHz Bandwidth High Channel (-76.5 dBm)

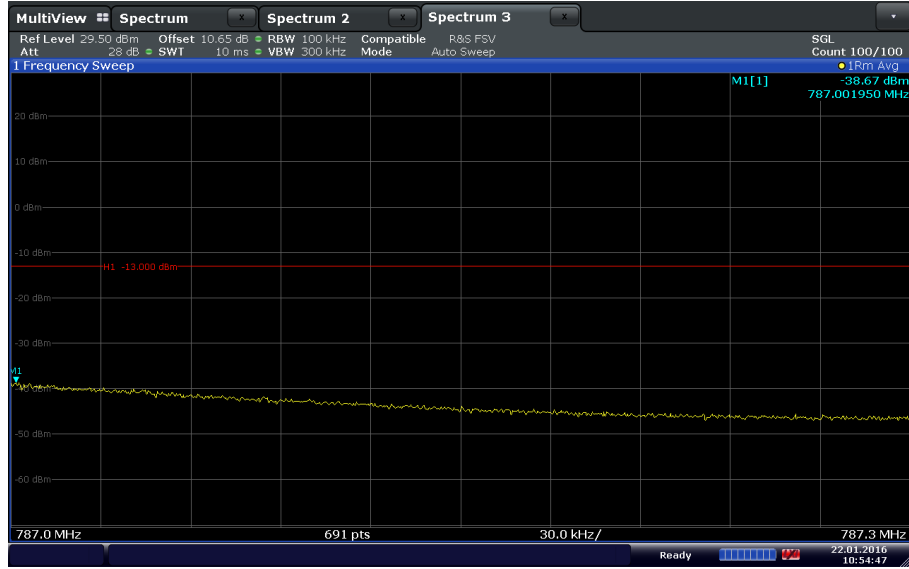

Date: 22.JAN.2016 10:54:47

### LTE Band 13 Uplink 5MHz Bandwidth High Channel (0 dBm)

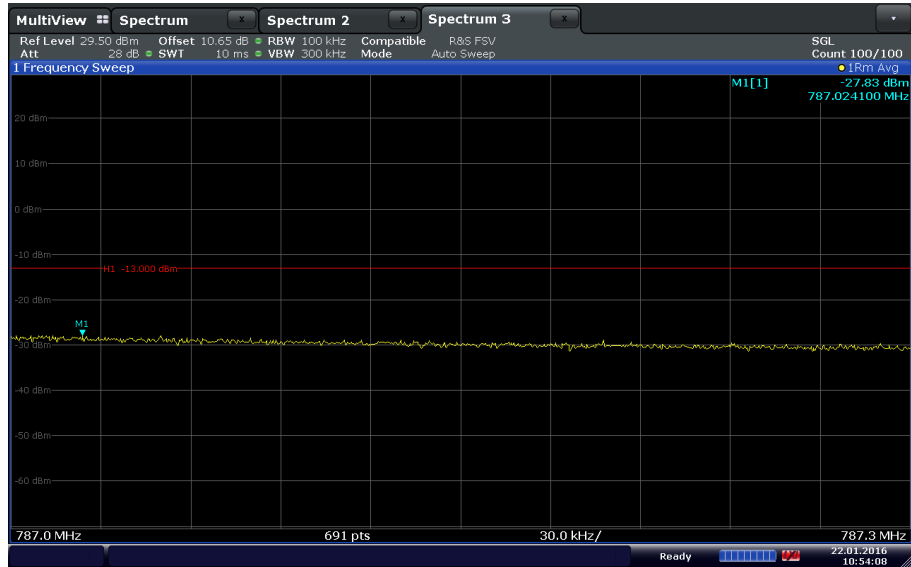

Date: 22.JAN.2016 10:54:08



### LTE Band 66 Uplink 5MHz Bandwidth Low Channel (-76 dBm)

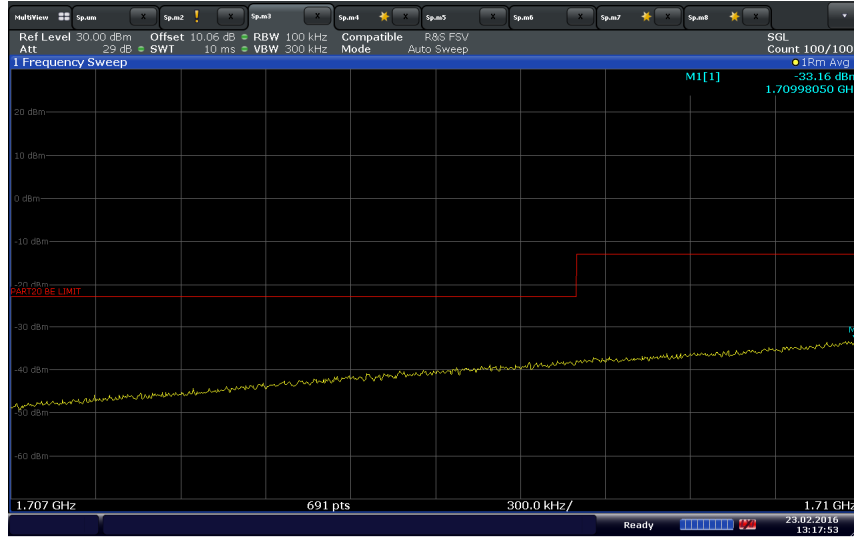

Date: 23 FEB.2016 13:17:53

### LTE Band 66 Uplink 5MHz Bandwidth Low Channel (0 dBm)

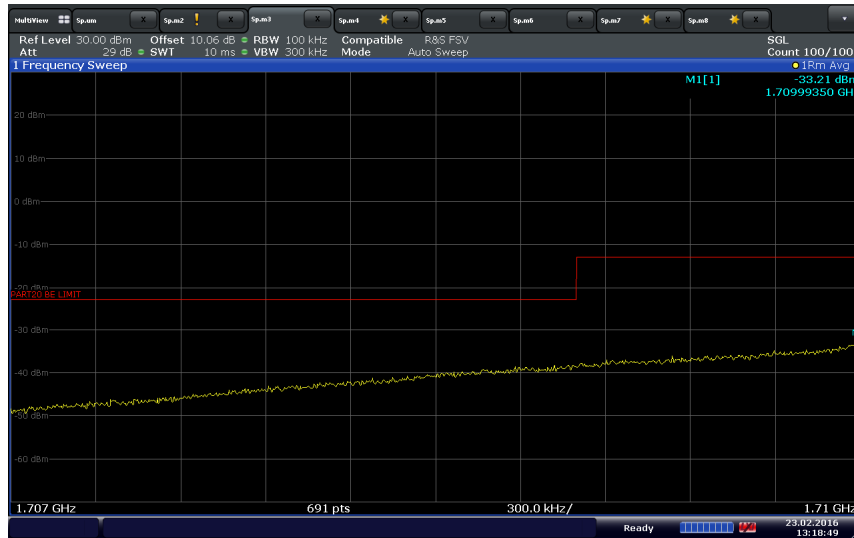

Date: 23 FEB.2016 13:18:49



America

### LTE Band 66 Uplink 5MHz Bandwidth High Channel (-76 dBm)

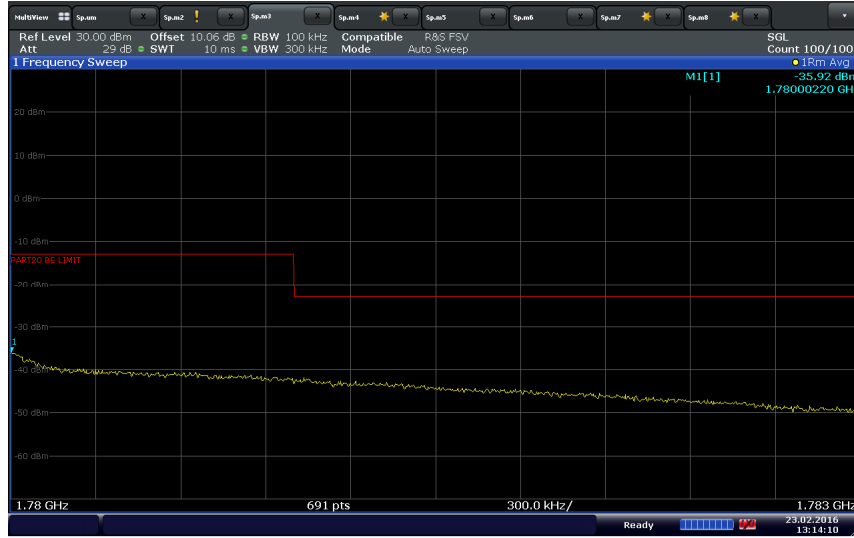

Date: 23 FEB.2016 13:14:10

### LTE Band 66 Uplink 5MHz Bandwidth High Channel (0 dBm)

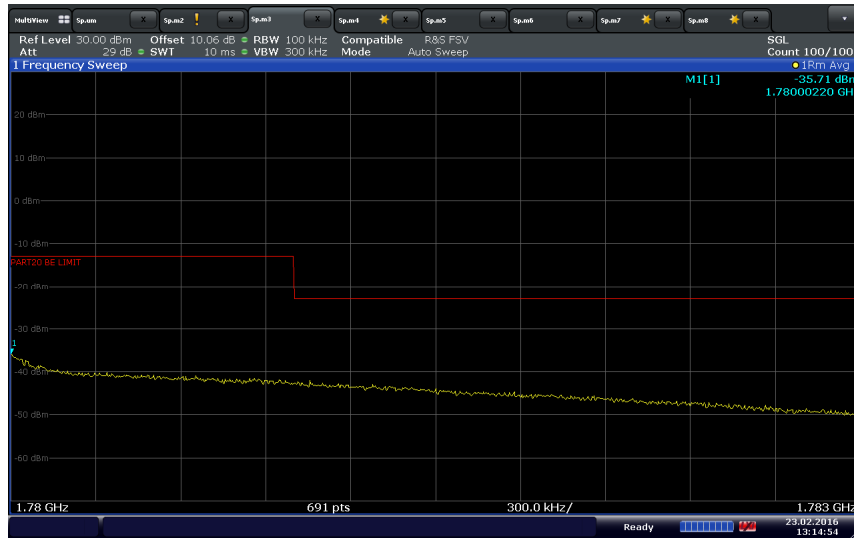

Date: 23 FEB.2016 13:14:55



## 2.6 NOISE LIMIT

### 2.6.1 Specification Reference

FCC 47 CFR Part 20. Clause 20.21(e)(9)(i)(A)  
FCC 47 CFR Part 20. Clause 20.21(e)(9)(i)(I)  
KDB935210 D04, Clause 7.7

### 2.6.2 Standard Applicable

FCC 47 CFR Part 20. Clause 20.21(e)(9)(i)(A) Noise Limits.:

The transmitted noise power in dBm/MHz of frequency selective consumer boosters outside the licensee's spectrum blocks at their uplink and downlink ports shall not exceed the following limits:

(1) -103 dBm/MHz - RSSI

(i) Where RSSI is the downlink composite signal power received in dBm for frequencies in the band of operation outside the licensee's spectrum block as measured after spectrum block filtering is applied and is referenced to the booster's donor port for each band of operation. RSSI is expressed in negative dB units relative to 1 mW.

(ii) Boosters with MSCL less than 40 dB, shall reduce the Noise output in (A) by 40 dB - MSCL, where MSCL is the minimum coupling loss in dB between the wireless device and booster's server port. MSCL must be calculated or measured for each band of operation and provided in compliance test reports.

(2)(i) Maximum downlink noise power shall not exceed  $-102.5 \text{ dBm/MHz} + 20 \text{ Log}_{10}(\text{Frequency})$ , where Frequency is the uplink mid-band frequency of the supported spectrum bands in MHz.

(ii) Compliance with Noise limits will use instrumentation calibrated in terms of RMS equivalent voltage, and with booster input ports terminated or without input signals applied within the band of measurement.

FCC 47 CFR Part 20. Clause 20.21(e)(9)(i)(I) Transmit Power Off Mode.

When the consumer booster cannot otherwise meet the noise and gain limits defined herein it must operate in "Transmit Power OFF Mode." In this mode of operation, the uplink and downlink noise power shall not exceed -70 dBm/MHz and uplink gain shall not exceed the lesser of 23 dB or MSCL.

### 2.6.3 Equipment Under Test and Modification State

Serial No: 95155000015 (NU and CU) / Test Configuration E, F and G

### 2.6.4 Date of Test/Initial of test personnel who performed the test

January 27, February 23 and April 3, 2016/XYZ

### 2.6.5 Test Equipment Used

The major items of test equipment used for the above tests are identified in Section 3.1.



**2.6.6 Environmental Conditions/ Test Location**

Test performed at TÜV SÜD America Inc. Rancho Bernardo facility

Ambient Temperature 24.8-26.1°C  
 Relative Humidity 20.1-29.0%  
 ATM Pressure 99.1-99.9kPa

**2.6.7 Additional Observations**

- 1) This is conducted Test. Test procedure is per Section 7.7 of KDB935210 (D04 Provider Specific Booster Measurements v01r01). Appropriate offset (line losses) applied.
- 2) The EUT operated in Test Mode with the gain manually set to the maximum gain and a minimum bandwidth setting (5MHz).
- 3) For Maximum Noise (frequency Dependent) testing, setup the EUT according to Figure 5 of Section 7.7 of KDB935210 (D04 Provider Specific Booster Measurements v01r01).
- 4) Maximum Noise (frequency Dependent) evaluations are conducted at CU antenna ports B2/13 and B66. Operational downlink bands for LTE Band 2, 13 and 66 were tested.
- 5) For Maximum Noise (RSSI Dependent and Transmit Power off mode) and Noise Response Time tests, setup the EUT according to Figure 5 of Figure 6 or 7 of Section 7.7 of KDB935210 (D04 Provider Specific Booster Measurements v01r01) as appropriate.
- 6) Maximum Noise (RSSI Dependent and Transmit Power off mode) and Noise Response Time evaluations are conducted at CU antenna ports B2/13 and B66, and NU antenna ports B2/13 and B66. Operational uplink and downlink bands for LTE Band 2, 13 and 66 were tested.
- 7) Signal generator was configured to transmit: 200 kHz AWGN.

**2.6.8 Test Results**

Maximum Noise (Frequency Dependent)				
Band	Frequency Range (MHz)	Max Noise (dBm/MHz)	Limit* (dBm/MHz)	Margin (dB)
Band 2 Downlink	1930 - 1990	-66.67	-37.0	-29.67
Band 13 Downlink	746 - 756	-61.77	-44.6	-17.17
Band 66 Downlink	2110 - 2180	-72.79	-37.7	-36.09

\*:  $-102.5 \text{ dBm/MHz} + 20 \text{ Log}_{10}(\text{Frequency})$ , where Frequency is the uplink mid-band frequency of the supported spectrum bands in MHz. (Downlink only)



Maximum Noise (RSSI Dependent and Transmit Power off mode)					
Band	Frequency (MHz)	Signal Generator Output Level (dBm)	Max Noise (dBm/MHz)	Limit (dBm/MHz)	Margin (dB)
Band 2 Downlink	1930 - 1990	-50	-76.35	-58.0	-18.35
		-49	-75.06	-59.0	-16.06
		-48	-75.2	-60.0	-15.2
		-47	-76.33	-61.0	-15.33
		-46	-81.1	-62.0	-19.1
		-20**	-81.18	-70.0	-11.18
Band 2 Uplink	1850 - 1910	-48	-66.93	-60.0	-6.93
		-47	-66.39	-61.0	-5.39
		-46	-64.49	-62.0	-2.49
		-45	-65.4	-63.0	-2.4
		-44	-79.34	-64.0	-15.34
		-28**	-79.73	-70.0	-9.73
Band 13 Downlink	746 - 756	-43	-70.72	-65.0	-5.72
		-42	-70.38	-66.0	-4.38
		-41	-70.12	-67.0	-3.12
		-40	-70.93	-68.0	-2.93
		-39	-78.12	-69.0	-9.12
		-28**	-80.37	-70.0	-10.37
Band 13 Uplink	777 - 787	-42	-72.61	-66.0	-6.61
		-41	-72.8	-67.0	-5.8
		-40	-72.56	-68.0	-4.56
		-39	-72.96	-69.0	-3.96
		-38	-79.81	-70.0	-9.81
		-28**	-80.37	-70.0	-10.37
Band 66 Downlink	2110 - 2180	-51	-67.98	-57.0	-10.98
		-50	-68.47	-58.0	-10.47
		-49	-68.31	-59.0	-9.31
		-48	-68.19	-60.0	-8.19
		-47	-68.18	-61.0	-7.18
		-46**	-75.1	-62.0	-13.1
Band 66 Uplink	1710 - 1780	-43	-72.37	-56.0	-16.37
		-40	-72.83	-59.0	-13.83
		-33	-72.39	-66.0	-6.39
		-32	-72.51	-67.0	-5.51
		-30	-72.29	-68.0	-4.39
		-29*	-78.72	-70.0	-8.72

\*\* : Transmit Power off mode





<b>Noise Response Time</b>				
<b>Band</b>	<b>Frequency (MHz)</b>	<b>Noise Response Time (Sec)</b>	<b>Limit (Sec)</b>	<b>Margin (Sec)</b>
Band 2 Downlink	1930 - 1990	0.12	3	-2.88
Band 2 Uplink	1850 - 1910	1.33	3	-1.67
Band 13 Downlink	746 - 756	0.17	3	-2.83
Band 13 Uplink	777 - 787	1.79	3	-1.21
Band 66 Downlink	2110 - 2180	0.55	3	2.45
Band 66 Uplink	1710 - 1780	1.93	3	-1.07



## **2.7 UPLINK INACTIVITY**

### **2.7.1 Specification Reference**

FCC 47 CFR Part 20. Clause 20.21(e)(9)(i)(J)  
KDB935210 D04, Clause 7.8

### **2.7.2 Standard Applicable**

FCC 47 CFR Part 20. Clause 20.21(e)(9)(i)(J) Uplink Inactivity:  
Uplink Inactivity. When a consumer booster is not serving an active device connection after 5 seconds the uplink noise power shall not exceed -70 dBm/MHz.

### **2.7.3 Equipment Under Test and Modification State**

Serial No: 296546000592 (NU) and 297546000384 (CU) / Test Configuration C and D

### **2.7.4 Date of Test/Initial of test personnel who performed the test**

February 24, 2016/XYZ

### **2.7.5 Test Equipment Used**

The major items of test equipment used for the above tests are identified in Section 3.1.

### **2.7.6 Environmental Conditions**

Test performed at TÜV SÜD America Inc. Rancho Bernardo facility.

Ambient Temperature	27.5°C
Relative Humidity	21.3%
ATM Pressure	99.2kPa



### 2.7.7 Additional Observations

- 1) This is conducted Test.
- 2) Test procedure is per Section 7.8 of KDB935210 (D04 Provider Specific Booster Measurements v01r01). Appropriate offset (line losses) applied.
- 3) The EUT operated in Normal Mode with a minimum bandwidth setting (5MHz).
- 4) Setup the EUT according to Figure 1 of Section 6.3.2 of KDB935210 (D04 Provider Specific Booster Measurements v01r01).
- 5) Evaluations are conducted at NU antenna ports B2/13 and B66.
- 6) Operational uplink bands for LTE Band 2, 13 and 66 were tested.
- 7) Signal: 5MHz LTE.

### 2.7.8 Test Results

Uplink Inactivity				
Band	Frequency (MHz)	UL Inactive Time (Sec)	Limit (Sec)	Margin (Sec)
Band 2 Uplink	1880	2.0	5.0	3.0
Band 13 Uplink	782	1.48	5.0	3.52
Band 66 Uplink	1755	1.87	5.0	3.13

### LTE Band 2 Uplink 5MHz Bandwidth Mid Channel



Date: 24 FEB 2016 15:00:33

### LTE Band 13 Uplink 5MHz Bandwidth Mid Channel



Date: 24 FEB 2016 15:06:41



LTE Band 66 Uplink 5MHz Bandwidth Mid Channel



Date: 24 FEB.2016 15:13:17



## **2.8 VARIABLE BOOSTER GAIN**

### **2.8.1 Specification Reference**

FCC 47 CFR Part 20. Clause 20.21(e)(9)(i)(C)(1)  
FCC 47 CFR Part 20. Clause 20.21(e)(9)(i)(I)  
KDB935210 D04, Clause 7.9

### **2.8.2 Standard Applicable**

FCC 47 CFR Part 20. Clause 20.21(e)(9)(i)(C)(1) Booster Gain Limits:  
The gain of the frequency selective consumer booster shall meet the limits below.

- 1) The uplink and downlink gain in dB of a frequency selective consumer booster referenced to its input and output ports shall not exceed BSCL - 28dB - (40 dB - MSCL).  
(i) Where BSCL is the coupling loss between the booster's donor port and the base station's input port, and MSCL is the minimum coupling loss in dB between the wireless device and the booster's server port. MSCL must be calculated or measured for each band of operation and provided in compliance test reports.  
(ii) In order of preference, BSCL is determined as follows: determine path loss between the base station and the booster; such measurement shall be based on measuring the received forward pilot/control channel power at the booster and reading the pilot/control channel transmit power from the base station as defined in the system information messages sent by the base station; estimate BSCL by assuming that the base station is transmitting at a level of +25 dBm per channel (assume a small, lightly loaded cell) and measuring the total received signal power level within the channel in dBm (RPCH) received at the booster input port. BSCL is then calculated as 25- RPCH; or assume that the BSCL is 70dB without performing any measurement.

FCC 47 CFR Part 20. Clause 20.21(e)(9)(i)(I) Transmit Power Off Mode.  
When the consumer booster cannot otherwise meet the noise and gain limits defined herein it must operate in "Transmit Power OFF Mode." In this mode of operation, the uplink and downlink noise power shall not exceed -70 dBm/MHz and uplink gain shall not exceed the lesser of 23 dB or MSCL.

### **2.8.3 Equipment Under Test and Modification State**

Serial No: 296546000592 (NU) and 297546000384 (CU) / Test Configuration C and D

### **2.8.4 Date of Test/Initial of test personnel who performed the test**

February 24, 25 and 29, 2016/XYZ

### **2.8.5 Test Equipment Used**

The major items of test equipment used for the above tests are identified in Section 3.1.



**2.8.6 Environmental Conditions**

Test performed at TÜV SÜD America Inc. Rancho Bernardo facility.

Ambient Temperature 27.1 - 27.5°C  
 Relative Humidity 21.3 - 21.8%  
 ATM Pressure 99.2kPa

**2.8.7 Additional Observations**

- 1) This is conducted Test.
- 2) Test procedure is per Section 7.9 of KDB935210 (D04 Provider Specific Booster Measurements v01r01). Appropriate offset (line losses) applied.
- 3) The EUT operated in Normal Mode;
- 4) Setup the EUT according to Figure 1 of Section 6.3.2 of KDB935210 (D04 Provider Specific Booster Measurements v01r01).
- 5) Evaluations are conducted at CU antenna ports B2/13 and B66, and NU antenna ports B2/13 and B66.
- 6) Variable Gain: Operational uplink and downlink bands for LTE Band 2, 13 and 66 were tested.
- 7) Uplink Gain Timing: Operational uplink bands for LTE Band 2, 13 and 66 were tested.
- 8) Signal: 5MHz LTE.
- 9) MSCL:  
 $L_p = 20\log f + 20\log d - 27.5$   
 $L_p$  = Basic free space path loss,  
 $f$  = frequency in MHz,  
 $d$  = separation distance in meters (2m)  
 lowest MSCL value was utilized.
- 10) BSCL:  
 The coupling loss (in dB) between the donor port (NU) of the Consumer Booster and the input port of the Base Station

**2.8.8 Test Results**

B2 Downlink Gain vs RPCH and BSCL - Middle Channel					
RPCH Power (dBm)	BSCL (dB)	Measured Power (dBm)	Gain (dB)	Limit (dB)	Margin (dB)
-80.54	105.5	-9.09	71.45	74.54	-3.09
-77.13	102.1	-8.58	65.55	71.13	-5.58
-74.5	99.5	-7.83	66.67	68.5	-1.83
-68.5	93.5	-7.75	60.75	62.5	-1.75
-66.54	91.5	-7.95	58.59	60.54	-1.95
-60.84	85.8	-7.22	53.62	54.84	-1.22



<b>B13 Downlink Gain vs RPCH and BSCL - Middle Channel</b>					
<b>RPCH Power (dBm)</b>	<b>BSCL (dB)</b>	<b>Measured Power (dBm)</b>	<b>Gain (dB)</b>	<b>Limit (dB)</b>	<b>Margin (dB)</b>
-75.88	101	-9.38	68.5	69.88	-1.38
-72.76	98	-8.92	63.84	66.76	-2.92
-70.98	96	-7.71	63.27	64.98	-1.71
-65.81	91	-7.83	57.98	59.81	-1.83
-60.48	86	-7.72	52.76	54.48	-1.72
-50.55	76	-7.58	42.97	44.55	-1.58

<b>B66 Downlink Gain vs RPCH and BSCL - Middle Channel</b>					
<b>RPCH Power (dBm)</b>	<b>BSCL (dB)</b>	<b>Measured Power (dBm)</b>	<b>Gain (dB)</b>	<b>Limit (dB)</b>	<b>Margin (dB)</b>
-79.1	104	-7.96	71.14	73.1	-1.96
-78.23	103	-7.52	70.71	72.23	-1.52
-74.15	99	-7.22	66.93	68.15	-1.22
-69.07	94	-6.72	62.35	63.07	-0.72
-64.55	89	-6.95	57.6	58.55	-0.95
-58.35	84	-7.23	51.03	52.35	-1.32





<b>B2 Uplink Gain vs RPCH and BSCL - Middle Channel</b>					
<b>RPCH Power (dBm)</b>	<b>BSCL (dB)</b>	<b>Measured Power (dBm)</b>	<b>Gain (dB)</b>	<b>Limit (dB)</b>	<b>Margin (dB)</b>
-83.89	104	-24.62	52.23	77.89	-25.66
-73.96	94	-33.73	43.12	67.96	-24.84
-63.78	84	-44.02	32.83	57.78	-24.95
-62.01	83	-45.18	31.67	56.01	-24.34
-53.90	74	-54.00	22.85	47.9	-25.05
-44.05	64	-58.72	18.13	38.05	-19.92

<b>B13 Uplink Gain vs RPCH and BSCL - Middle Channel</b>					
<b>RPCH Power (dBm)</b>	<b>BSCL (dB)</b>	<b>Measured Power (dBm)</b>	<b>Gain (dB)</b>	<b>Limit (dB)</b>	<b>Margin (dB)</b>
-86.17	106	-22.23	55.52	80.17	-24.65
-75.45	96	-23.24	54.51	69.45	-14.94
-71.88	95	-31.20	46.55	65.88	-19.33
-70.95	86	-31.96	45.79	64.95	-19.16
-66.24	85	-42.09	35.66	60.24	-24.58
-57.28	77	-51.76	25.99	51.28	-25.29



B66 Uplink Gain vs RPCH and BSCL - Middle Channel					
RPCH Power (dBm)	BSCL (dB)	Measured Power (dBm)	Gain (dB)	Limit (dB)	Margin (dB)
-92.13	112.0	-8.72	73.94	88.13	-14.19
-82.01	102.0	19.42	65.05	76.01	-10.96
-72.21	92.0	-24.85	53.48	66.21	-12.73
-49.34	76.0	-39.27	39.16	43.34	-4.18
-41.23	70.0	45.28	33.15	35.23	-2.08
-40.4	69.0	-45.66	32.77	34.4	-1.63

Uplink Gain Timing				
Band	Frequency (MHz)	UL Gain Timing (Sec)	Limit (Sec)	Margin (Sec)
Band 2 Uplink	1880.0	2.82	3	0.18
Band 13 Uplink	782.0	1.06	3	1.94
Band 66 Uplink	1732.5	1.07	3	1.93



### 2.8.9 Test Results

#### LTE Band 2 Uplink 5MHz Bandwidth Mid Channel

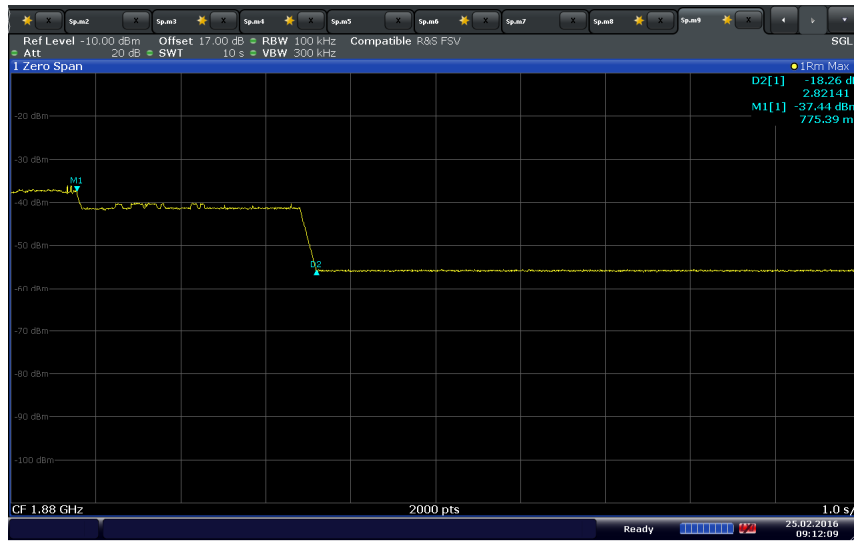

#### LTE Band 13 Uplink 5MHz Bandwidth Mid Channel

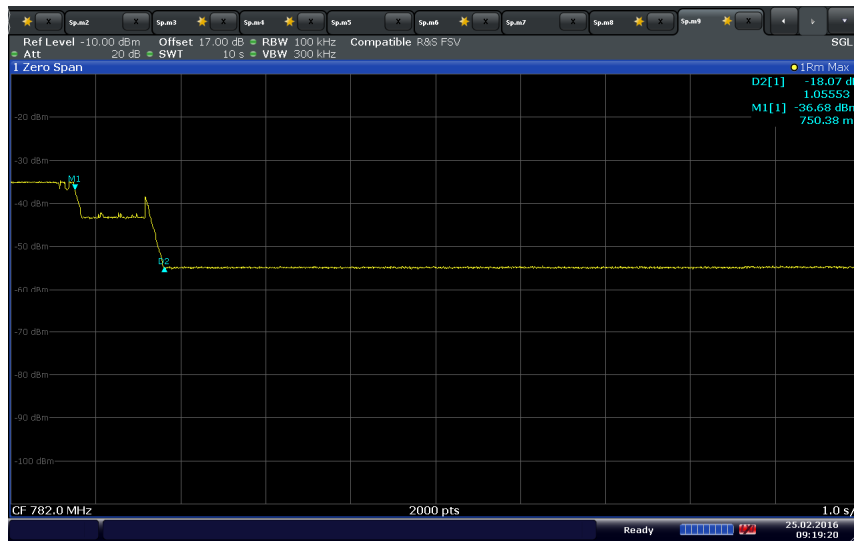



America

### LTE Band 66 Uplink 5MHz Bandwidth Mid Channel



Date: 24 FEB 2016 17:24:40



## **2.9 OSCILLATION DETECTION**

### **2.9.1 Specification Reference**

FCC 47 CFR Part 20. Clause 20.21(e)(9)(ii)(A)  
KDB935210 D04, Clause 7.11

### **2.9.2 Standard Applicable**

FCC 47 CFR Part 20. Clause 20.21(e)(9)(ii)(A) Anti-Oscillation:  
Consumer boosters must be able to detect and mitigate (i.e., by automatic gain reduction or shut down), any oscillations in uplink and downlink bands. Oscillation detection and mitigation must occur automatically within 0.3 seconds in the uplink band and within 1 second in the downlink band. In cases where oscillation is detected, the booster must continue mitigation for at least one minute before restarting. After five such restarts, the booster must not resume operation until manually reset.

### **2.9.3 Equipment Under Test and Modification State**

Serial No: 296546000592 (NU) and 297546000384 (CU) / Test Configuration C and D

### **2.9.4 Date of Test/Initial of test personnel who performed the test**

February 25, 2016/XYZ

### **2.9.5 Test Equipment Used**

The major items of test equipment used for the above tests are identified in Section 3.1.

### **2.9.6 Environmental Conditions**

Test performed at TÜV SÜD America Inc. Rancho Bernardo facility.

Ambient Temperature	27.1°C
Relative Humidity	21.8%
ATM Pressure	99.2kPa

### **2.9.7 Additional Observations**

- 1) This is conducted Test.
- 2) Test procedure is per Section 7.11 of KDB935210 (D04 Provider Specific Booster Measurements v01r01). Appropriate offset (line losses) applied.
- 3) The EUT operated in Normal Mode when testing Oscillation Mitigation Time;
- 4) Setup the EUT according to Figure 1 of Section 6.3.2 of KDB935210 (D04 Provider Specific Booster Measurements v01r01) for Normal Mode.
- 5) The EUT operated in Test Mode when testing Re-Try event;



- 6) Setup the EUT according to Figure 2 and Figure 3 of Section 6.3.3 of KDB935210 (D04 Provider Specific Booster Measurements v01r01) for Test Mode.
- 7) Evaluations are conducted at CU antenna ports B2/13 and B66, and NU antenna ports B2/13 and B66.
- 8) Signal: 5MHz LTE.

### 2.9.8 Test Results Summary

Band	Frequency (MHz)	Mitigation Time (Sec)	Limit (Sec)	Margin (Sec)
Band 2 Downlink	1960	0.045	0.3	-0.255
Band 2 Uplink	1880	0.02	0.3	-0.28
Band 13 Downlink	751	0.035	0.3	-0.265
Band 13 Uplink	782	0.015	0.3	-0.285
Band 66 Downlink	2132.5	0.005	0.3	-0.295
Band 66 Uplink	1732.5	0.005	0.3	-0.295

Band	Frequency (MHz)	Re-Try Event	Limit Event	Margin (dB)
Band 2 Downlink	1960	0	5	-5
Band 2 Uplink	1880	0	5	-5
Band 13 Downlink	751	0	5	-5
Band 13 Uplink	782	0	5	-5
Band 66 Downlink	2132.5	0	5	-5
Band 66 Uplink	1732.5	0	5	-5



### 2.9.9 Test Plots

#### LTE Band 2 Downlink 5MHz Bandwidth Mid Channel

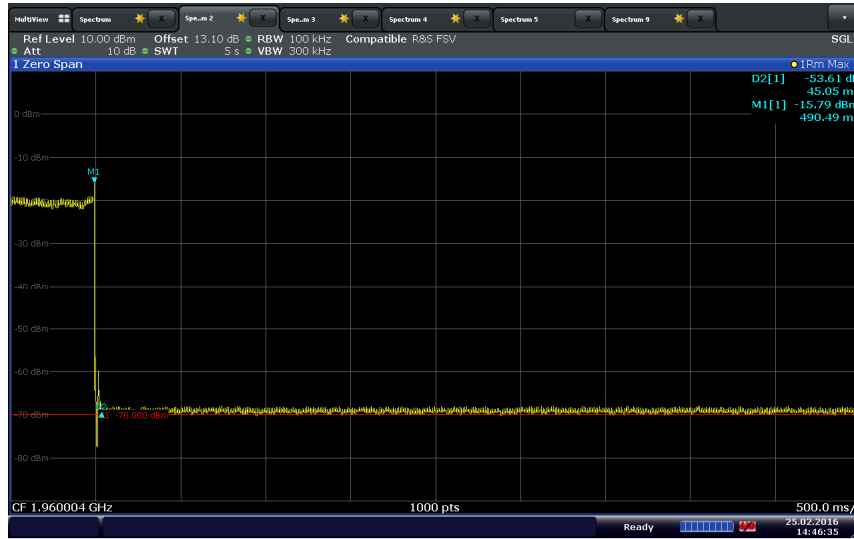

#### LTE Band 13 Downlink 5MHz Bandwidth Mid Channel

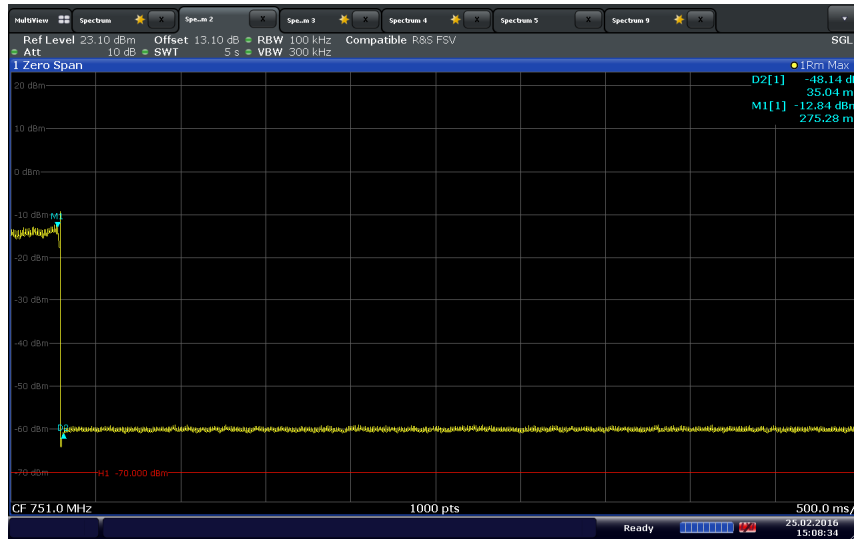



### LTE Band 66 Downlink 5MHz Bandwidth Mid Channel

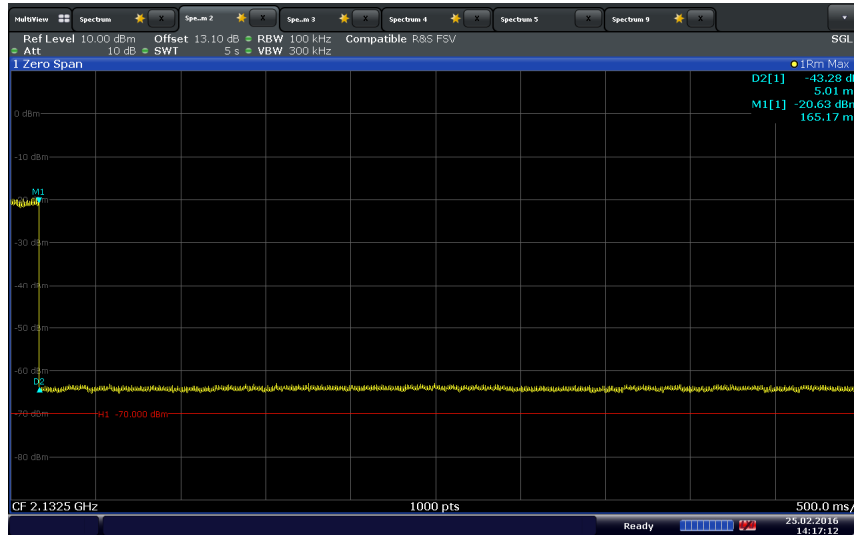

Date: 25 FEB 2016 14:17:13

### LTE Band 2 Uplink 5MHz Bandwidth Mid Channel

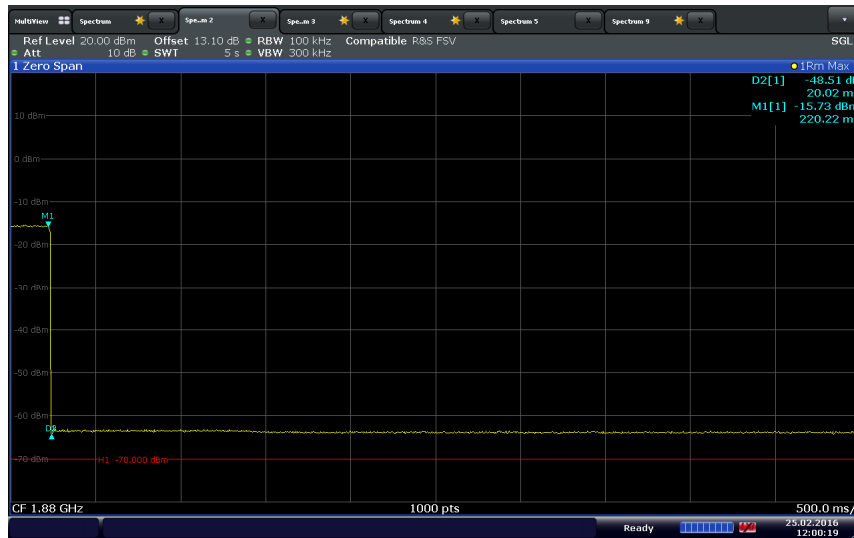

Date: 25 FEB 2016 12:00:19





### LTE Band 13 Uplink 5MHz Bandwidth Mid Channel

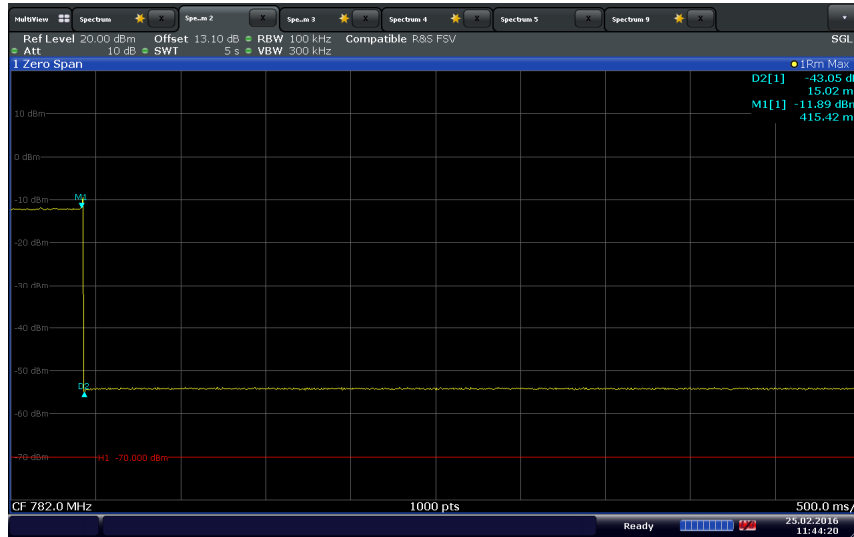

Date: 25 FEB 2016 11:44:20

### LTE Band 66 Uplink 5MHz Bandwidth Mid Channel

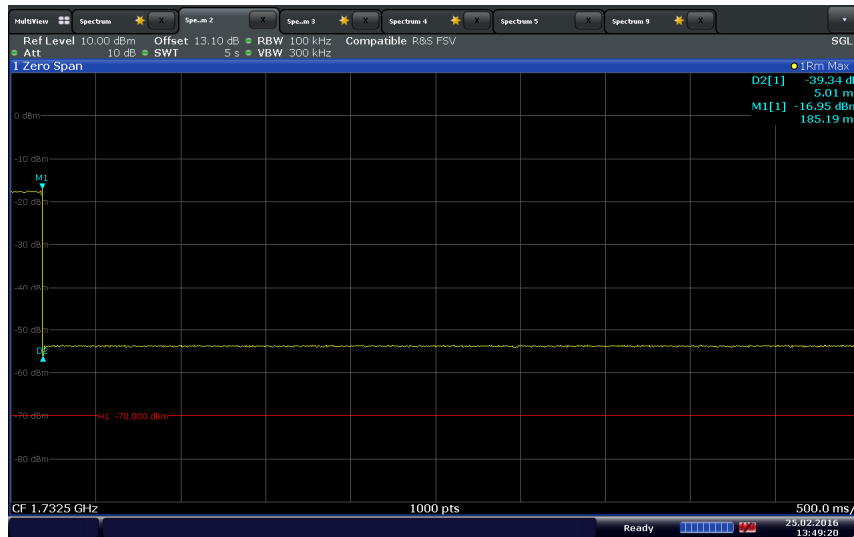

Date: 25 FEB 2016 13:49:21



## **2.10 OUT OF BAND GAIN LIMIT**

### **2.10.1 Specification Reference**

FCC 47 CFR Part 20. Clause 20.21(e)(9)(i)(E)  
KDB935210 D04, Clause 7.14

### **2.10.2 Standard Applicable**

FCC 47 CFR Part 20. Clause 20.21(e)(9)(i)(E) Out of Band Gain Limits.:

(1) A frequency selective booster shall have the following minimum attenuation referenced to the gain in the center of the pass band of the booster:

- (i) -20 dB at the band edge, where band edge is the end of the licensee's allocated spectrum,
- (ii) -30 dB at 1 MHz offset from band edge,
- (iii) -40 dB at 5 MHz offset from band edge.

(2) A frequency selective booster having maximum gain greater than 80 dB (referenced to the center of the pass band) shall limit the out of band gain to 60 dB at 0.2 MHz offset from the band edge, and 45 dB at 1 MHz offset from the band edge, where band edge is the end of the licensee's allocated spectrum.

### **2.10.3 Equipment Under Test and Modification State**

Serial No: 951550000015 (NU and CU) / Test Configuration A and B

### **2.10.4 Date of Test/Initial of test personnel who performed the test**

January 26 and February 23, 2016 /XYZ

### **2.10.5 Test Equipment Used**

The major items of test equipment used for the above tests are identified in Section 3.1.

### **2.10.6 Environmental Conditions/ Test Location**

Test performed at TÜV SÜD America Inc. Rancho Bernardo facility

Ambient Temperature	22.7 – 26.1 °C
Relative Humidity	28.4 - 29.0 %
ATM Pressure	99.1 - 99.9 kPa



**2.10.7 Additional Observations**

- 1) This is conducted Test. Test procedure is per Section 7.14 of KDB935210 (D04 Provider Specific Booster Measurements v01r01). Appropriate offset (line losses) applied.
- 2) The EUT operated in Test Mode with the gain manually set to the maximum gain and a minimum bandwidth setting (5MHz).
- 3) Setup the EUT according to Figure 2 or 3 of Section 6.3.3 of KDB935210 (D04 Provider Specific Booster Measurements v01r01) as appropriate.
- 4) Evaluations are conducted at CU antenna ports B2/13 and B66, and NU antenna ports B2/13 and B66.
- 5) Operational uplink and downlink bands for LTE Band 2, 13 and 66 were tested.
- 6) The signal generator was set to transmit a CW signal with output power level set to that as determined in clause 7.1.2 of KDB935210 (D04 Provider Specific Booster Measurements v01r01).

**2.10.8 Test Results**

Out of Band Gain Limit Band 2 Downlink (1930 – 1990MHz)				
Offset (MHz)	Input Power (dBm)	Output Power (dBm)	Gain (dB)	Gain Limit (dB)
Centre Frequency	-84.36	4.47	88.83	-
0 (Low Band Edge)	-83.78	-67.46	16.32	68.83
-0.2	-83.8	-67.61	16.19	60
-1	-83.73	-67.57	16.16	45
-5	-83.65	-68.17	15.48	48.83
0 (High Band Edge)	-83.71	-66.54	17.17	68.83
+0.2	-83.66	-66.57	17.09	60
+1	-83.59	-66.47	17.12	45
+5	-84.26	-64.72	19.54	48.83



Out of Band Gain Limit Band 2 Uplink (1850 – 1910MHz)				
Offset (MHz)	Input Power (dBm)	Output Power (dBm)	Gain (dB)	Gain Limit (dB)
Centre Frequency	-75.80	12.72	92.09	-
0 (Low Band Edge)	-76.0	-69.91	6.09	72.09
-0.2	-76.32	-69.34	6.98	60
-1	-76.43	-68.75	7.68	45
-5	-76.33	-70.97	5.36	52.09
0 (High Band Edge)	-75.89	-72.31	3.58	72.09
+0.2	-75.64	-72.78	2.86	60
+1	-76.02	-73.08	2.94	45
+5	-75.88	-72.79	3.09	52.09

Out of Band Gain Limit Band 13 Downlink (746 – 756MHz)				
Offset (MHz)	Input Power (dBm)	Output Power (dBm)	Gain (dB)	Gain Limit (dB)
Centre Frequency	-80.45	5.38	85.83	-
0 (Low Band Edge)	-80.40	-70.85	9.55	65.83
-0.2	-80.43	-70.56	9.87	60
-1	-80.31	-70.21	10.1	45
-5	-80.29	-72.69	7.6	45.83
0 (High Band Edge)	-80.48	-67.94	12.54	65.83
+0.2	-80.44	-68.02	12.42	60
+1	-80.40	-70.22	10.18	45
+5	-80.49	-73.32	7.17	45.83



Out of Band Gain Limit Band 13 Uplink (777 – 787MHz)				
Offset (MHz)	Input Power (dBm)	Output Power (dBm)	Gain (dB)	Gain Limit (dB)
Centre Frequency	-75.48	12.64	88.12	-
0 (Low Band Edge)	-75.61	-66.19	9.42	68.12
-0.2	-75.70	-67.82	7.88	60
-1	-75.53	-74.38	1.15	45
-5	-75.63	-72.89	2.74	48.12
0 (High Band Edge)	-75.87	-68.55	7.32	68.12
+0.2	-75.67	-69.02	6.65	60
+1	-75.47	-70.57	4.9	45
+5	-75.56	-73.18	2.38	48.12

Out of Band Gain Limit Band 66 Downlink (2110 – 2180MHz)				
Offset (MHz)	Input Power (dBm)	Output Power (dBm)	Gain (dB)	Gain Limit (dB)
Centre Frequency	-89.06	-6.67	82.39	-
0 (Low Band Edge)	-89.17	-80.78	8.39	62.39
-0.2	-89.14	-80.76	8.38	60
-1	-89.18	-80.84	8.34	45
-5	-89.16	-80.95	8.21	42.39
0 (High Band Edge)	-89.27	-81.70	7.57	62.39
+0.2	-89.18	-81.75	7.43	60
+1	-89.06	-81.94	7.12	45
+5	-89.01	-82.05	6.96	42.39



America

Out of Band Gain Limit Band 66 Uplink (1710 – 1780MHz)				
Offset (MHz)	Input Power (dBm)	Output Power (dBm)	Gain (dB)	Gain Limit (dB)
Centre Frequency	-77.85	12.97	90.82	-
0 (Low Band Edge)	-78.04	-76.71	1.33	70.82
-0.2	-78.07	-76.79	1.28	60
-1	-78.08	-76.11	1.97	45
-5	-78.01	-76.64	1.37	50.82
0 (High Band Edge)	-77.89	-76.72	1.17	70.82
+0.2	-77.95	-76.65	1.3	60
+1	-77.87	-76.47	1.4	45
+5	-77.86	-77.25	0.61	50.82

FCC ID: NU: YETD32-21366NU  
CU: YETD32-21366CU  
IC: N/A  
Report No. SD72112724-0116E



### **SECTION 3**

#### **TEST EQUIPMENT USED**



### 3.1 TEST EQUIPMENT USED

List of absolute measuring and other principal items of test equipment.

ID Number (SDGE/SDRB)	Test Equipment	Type	Serial Number	Manufacturer	Cal Date	Cal Due Date
Antenna Conducted Port Setup						
7604	P-Series Power Meter	N1912A	SG45100273	Agilent	05/27/15	05/27/16
7605	50MHz-18GHz Wideband Power Sensor	N1921A	MY51100054	Agilent	04/10/15	04/10/16
7582	Signal/Spectrum Analyzer	FSW26	101614	Rhode & Schwarz	10/05/15	10/05/16
7608	Vector Signal Generator	SMBV100A	259021	Rhode & Schwarz	07/29/15	07/29/16
9063	Universal Radio Communication	CMW200	1400-38269	Rhode & Schwarz	For Signal Only	
7562	Wideband Radio Communication Tester	CMW 500	1201.0002k50 /103829	Rhode & Schwarz	For Signal Only	
-	11dB Step Attenuator	8494B	2812A17193	Agilent	Verified by 7582 and 7608	
-	110 dB Step Attenuator	8496B	MY42143874	Agilent	Verified by 7582 and 7608	
8825	20dB Attenuator	46-20-34	BK5773	Weinschel Corp.	Verified by 7582 and 7608	
-	10dB Attenuator	PE7010-10	-	Pasternack	Verified by 7582 and 7608	
-	3dB Attenuator	PE7010-6	-	Pasternack	Verified by 7582 and 7608	
Miscellaneous						
6792	Multimeter	3478A	2911A70964	Hewlett Packard	08/14/15	08/14/16
11312	Mini Environmental Quality Meter	850027	CF099-56010-340	Sper Scientific	04/09/15	04/09/16
	Test Software	EMC32	V8.53	Rhode & Schwarz	N/A	





### 3.2 MEASUREMENT UNCERTAINTY

For a 95% confidence level, the measurement uncertainties for defined systems are:

#### 3.2.1 General Direct Conducted Antenna Port Measurement

Contribution		Probability Distribution Type	Probability Distribution $x_i$	Standard Uncertainty $u(x_i)$	$[u(x_i)]^2$
1	Receiver/Spectrum Analyzer	Rectangular	0.57	0.33	0.11
2	Cables	Rectangular	0.50	0.29	0.08
3	EUT Setup	Rectangular	1.00	0.58	0.33
Combined Uncertainty ( $u_c$ ):					0.72
Coverage Factor (k):					2
Expanded Uncertainty:					1.45

FCC ID: NU: YETD32-21366NU  
CU: YETD32-21366CU  
IC: N/A  
Report No. SD72112724-0116E



## SECTION 4

### DIAGRAM OF TEST SETUP

#### 4.1 TEST SETUP DIAGRAM

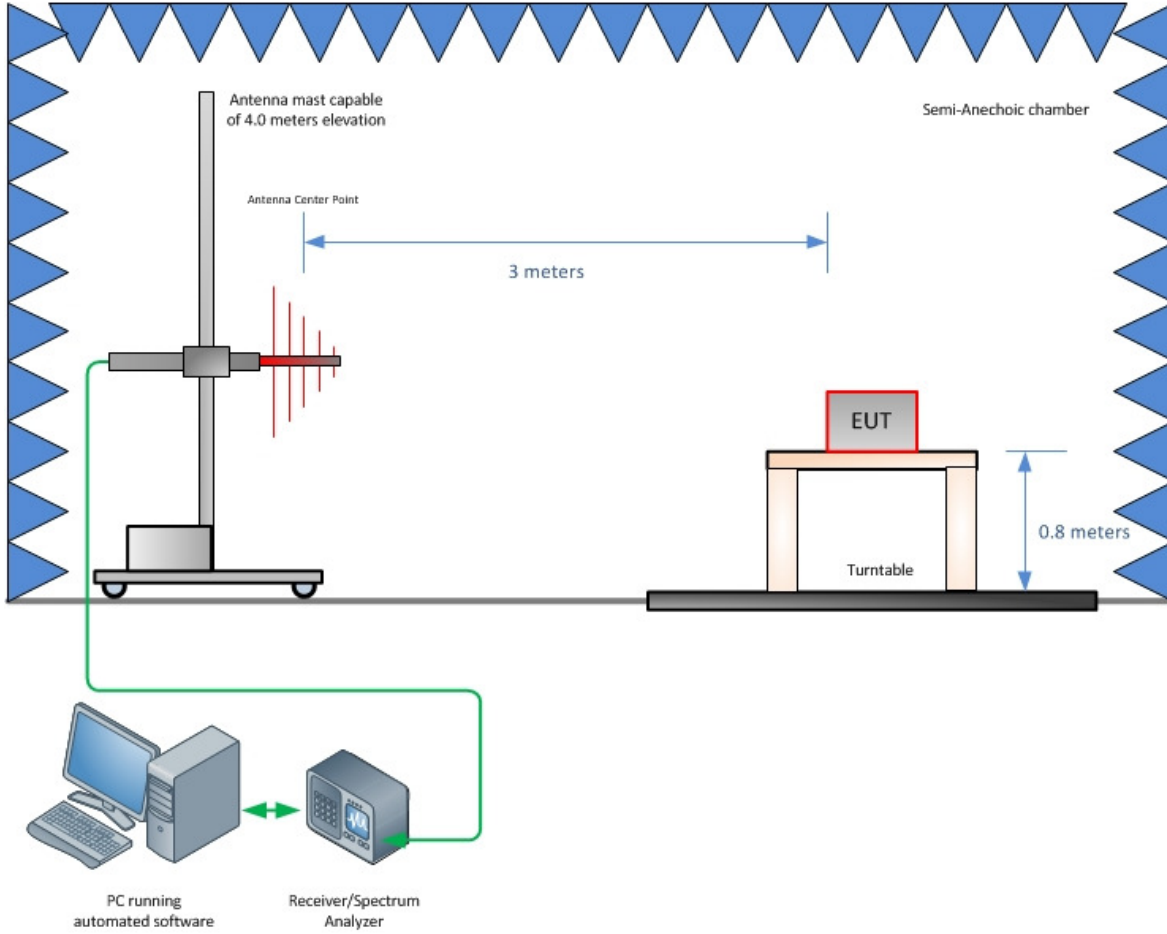

**Radiated Emission Test Setup (Below 1GHz)**

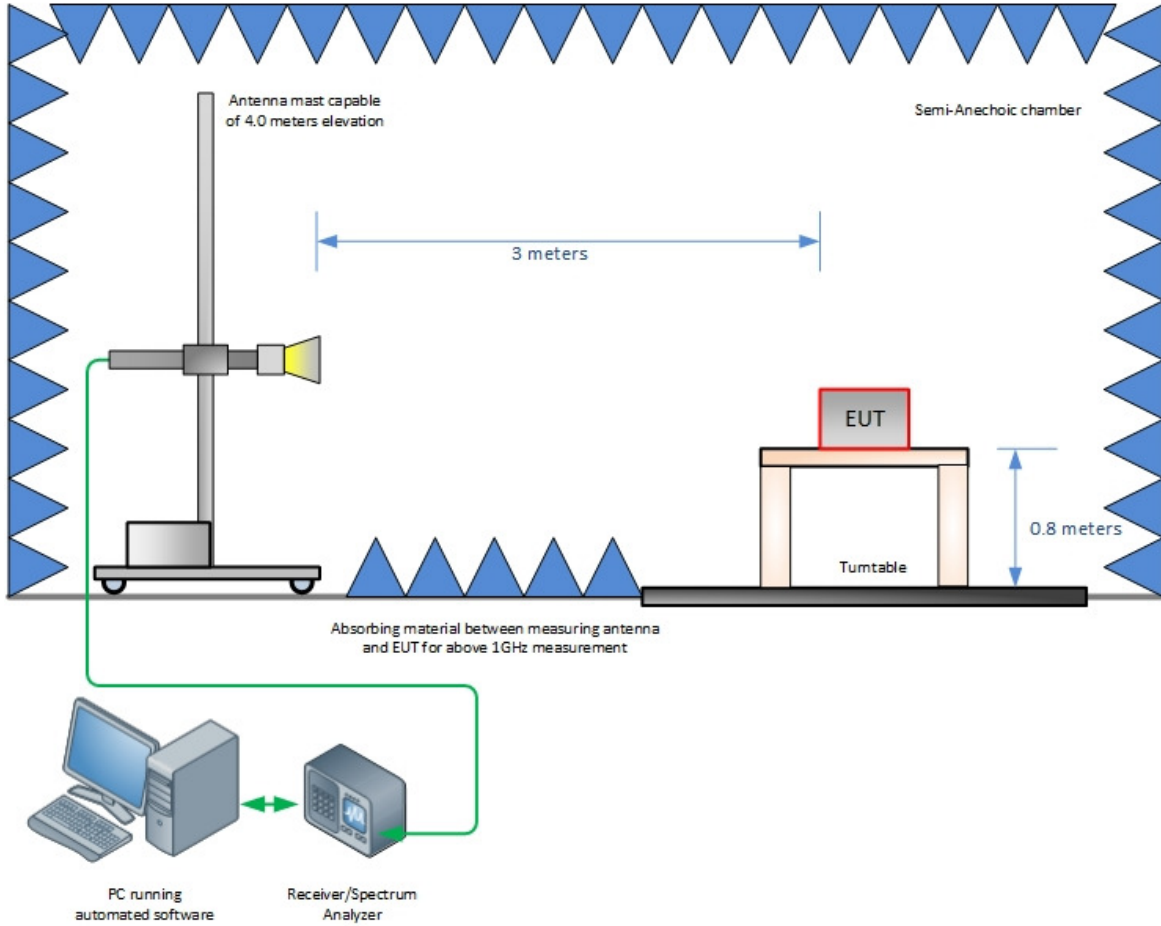

**Radiated Emission Test Setup (Above 1GHz)**

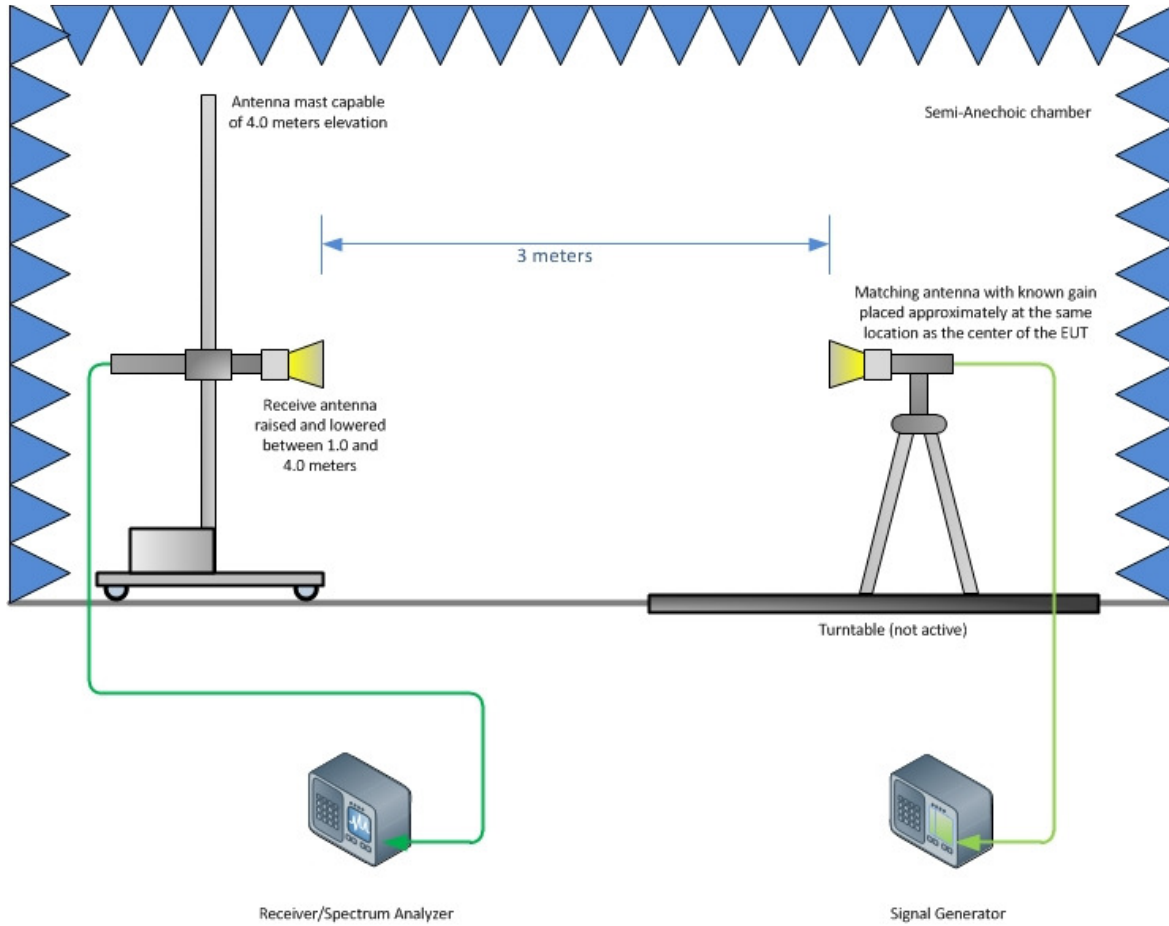

**Substitution Test Method (Above 1GHz, if applicable)**

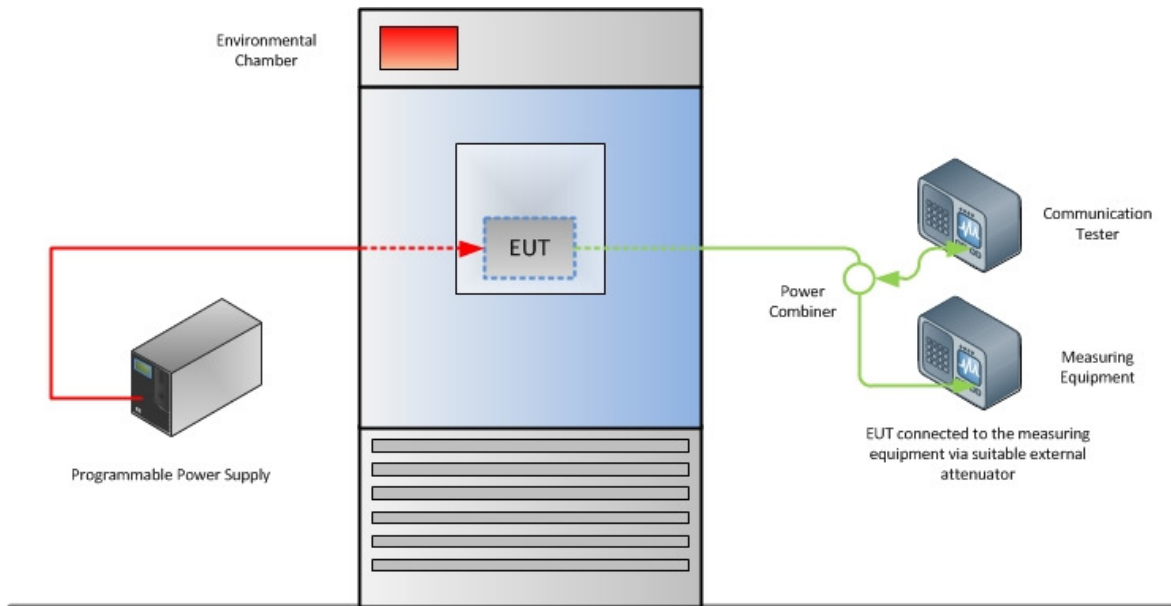

**Frequency Stability Test Configuration**

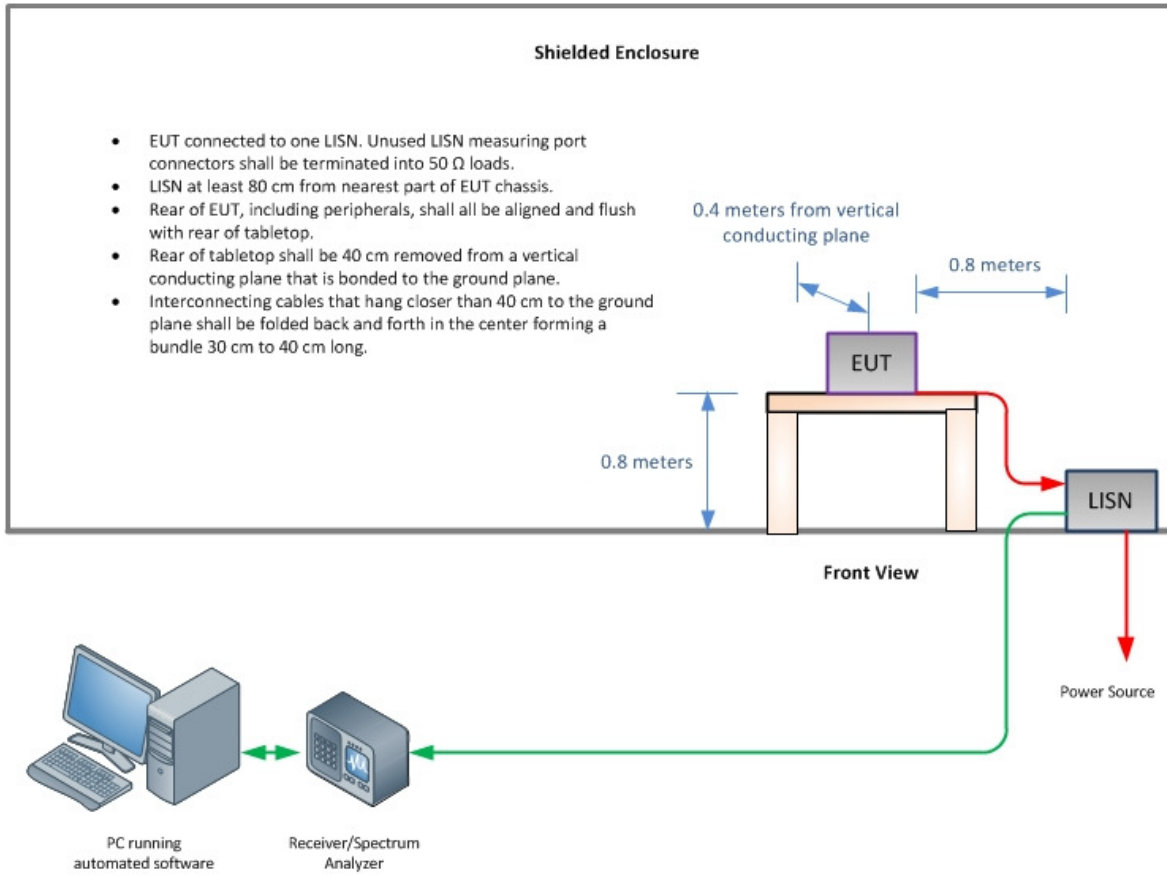

**Conducted Emissions Test Configuration (if applicable)**

FCC ID: NU: YETD32-21366NU  
CU: YETD32-21366CU  
IC: N/A  
Report No. SD72112724-0116E



## SECTION 5

### ACCREDITATION, DISCLAIMERS AND COPYRIGHT





## 5.1 ACCREDITATION, DISCLAIMERS AND COPYRIGHT

TÜV SÜD America Inc.'s reports apply only to the specific sample tested under stated test conditions. It is the manufacturer's responsibility to assure the continued compliance of production units of this model. TÜV SÜD America, Inc. shall have no liability for any deductions, inferences or generalizations drawn by the client or others from TÜV SÜD America, Inc.'s issued reports.

This report is the confidential property of the client. As a mutual protection to our clients, the public and TÜV SÜD America, Inc., extracts from the test report shall not be reproduced, except in full without TÜV SÜD America, Inc.'s written approval.

This report must not be used to claim product certification, approval, or endorsement by A2LA, NIST, or any agency of the federal government.

TÜV SÜD America, Inc. and its professional staff hold government and professional organization certifications for AAMI, ACIL, AEA, ANSI, IEEE, A2LA, NIST and VCCI.



A2LA Cert. No. 2955.13

