



America

---

**Choose certainty.  
Add value.**

# Report On

DFS (Dynamic Frequency Selection) testing of the  
Nextivity Inc.

Cel-Fi DUO Smart Cellular Signal Booster

FCC Part 15 Subpart E §15.407 (h)

Report No. SD72112724-0116G

February 2016





**REPORT ON** DFS Testing of the  
Nextivity Inc.  
Smart Cellular Signal Booster

**TEST REPORT NUMBER** SD72112724-0116G

**PREPARED FOR** Nextivity Inc.  
12230 World Trade Drive, Suite 250  
San Diego, CA 92128

**CONTACT PERSON** CK Li  
Sr. Principal Engineer, Regulatory  
(858) 829-1692  
CLi@NextivityInc.com

**PREPARED BY**   
Ferdinand S. Custodio  
Name  
Authorized Signatory  
Title: EMC/Senior Wireless Test Engineer

**APPROVED BY**   
Chip R. Fleury  
Name  
Authorized Signatory  
Title: West Coast EMC Manager

**DATED** March 21, 2016



**Revision History**

SD72112724-0116G Nextivity Inc. Cel-Fi DUO Smart Cellular Signal Booster					
DATE	OLD REVISION	NEW REVISION	REASON	PAGES AFFECTED	APPROVED BY
03/21/16	Initial Release				Chip R. Fleury



**CONTENTS**

<b>Section</b>	<b>Page No</b>
<b>1</b>	<b>REPORT SUMMARY ..... 5</b>
1.1	Introduction ..... 6
1.2	Brief Summary Of Results (Master Device) ..... 7
1.3	Product Information ..... 8
1.4	EUT Test Configuration ..... 11
1.5	Deviations From The Standard ..... 15
1.6	Modification Record ..... 15
1.7	Test Methodology ..... 15
1.8	Test Facility Location ..... 15
1.9	Test Facility Registration ..... 16
1.10	DFS Test System ..... 17
<b>2</b>	<b>CALIBRATION AND TEST DETAILS ..... 19</b>
2.1	Radar Waveform Calibration ..... 20
2.2	Channel Loading ..... 30
2.3	U-NII Detection Bandwidth ..... 35
2.4	Initial Channel Availability Check Time ..... 39
2.5	Radar Burst At The Beginning Of The Channel Availability Check Time ..... 42
2.6	Radar Burst At The End Of The Channel Availability Check Time ..... 45
2.7	In-Service Monitoring For Channel Move Time And Channel Closing Transmission Time ..... 47
2.8	Non-Occupancy Period ..... 53
2.9	Statistical Performance Check ..... 56
<b>3</b>	<b>TEST EQUIPMENT USED ..... 83</b>
3.1	Test Equipment Used ..... 84
3.2	Measurement Uncertainty ..... 85
<b>4</b>	<b>ACCREDITATION, DISCLAIMERS AND COPYRIGHT ..... 86</b>
4.1	Accreditation, Disclaimers and Copyright ..... 87



## **SECTION 1**

### **REPORT SUMMARY**

DFS Testing of the  
Nextivity Inc.  
Smart Cellular Signal Booster



## 1.1 INTRODUCTION

The information contained in this report is intended to show verification of the Nextivity Inc. Smart Cellular Signal Booster to the requirements of FCC Part 15 Subpart E §15.407 (h).

Objective	To perform DFS Testing to determine the Equipment Under Test's (EUT's) compliance with the Test Specification, for the series of tests carried out.
Manufacturer	Nextivity Inc.
Model Number(s)	D32-2/13/66
FCC ID Number	YETD32-21366NU (NU); YETD32-21366CU (CU)
Serial Number(s)	296546000608 (NU) 297546000537 (CU)
Number of Samples Tested	2
Test Specification/Issue/Date	<ul style="list-style-type: none"><li>• FCC Part 15 Subpart E §15.407 (h) (October 1, 2015).</li><li>• KDB905462 D02 UNII DFS Compliance Procedures New Rules v01r02. Compliance Measurement Procedures For Unlicensed-National Information Infrastructure Devices Operating In The 5250-5350 Mhz And 5470-5725 Mhz Bands Incorporating Dynamic Frequency Selection (May 15, 2015).</li></ul>
Start of Test	January 26, 2016
Finish of Test	February 23, 2016
Name of Engineer(s)	Ferdinand Custodio Xiaoying Zhang
Related Document(s)	Test Report No. SD72112724-0116F FCC Part 15.407 Subpart E RSS247 Test Report.docx.(issued by TÜV SÜD America, February 2016)



**1.2 BRIEF SUMMARY OF RESULTS (MASTER DEVICE)**

DFS requirement prior to use of a channel					
Section	Test Description	Radar Type	EUT Frequency	Requirement	Compliance
2.8	Non-Occupancy Period	Type 0	5280MHz and 5630 MHz	>30 minutes	Complies
2.9	DFS Detection Threshold	Type 1,2,3,4,5 and 6	5280MHz	-60 dBm	Complies
2.4, 2.5 and 2.6	Channel Availability Check Time	Type 0	5280MHz and 5540MHz	60 seconds	Complies
2.3	U-NII Detection Bandwidth	Type 0	5280MHz and 5630 MHz	Min. 100% of the U-NII 99% transmission power bandwidth	Complies
DFS requirements during normal operation					
Section	Test Description	Radar Type	EUT Frequency	Requirement	Compliance
2.9	DFS Detection Threshold	Type 1,2,3,4,5 and 6	5280MHz	-60 dBm	Complies
2.7	Channel Closing Transmission Time	Type 0	5280MHz and 5630 MHz	≤ 260 ms	Complies
2.7	Channel Move Time	Type 0	5280MHz and 5630 MHz	10 seconds	Complies
2.3	U-NII Detection Bandwidth	Type 0	5280MHz and 5630 MHz	Min. 100% of the U-NII 99% transmission power bandwidth	Complies

### 1.3 PRODUCT INFORMATION

#### 1.3.1 Technical Description

The Equipment Under Test (EUT) was a Nextivity Inc. Cel-Fi DUO Smart Cellular Signal Booster as shown in the photograph below. The EUT is a signal booster for indoor residential, small business and small enterprise use. It consists of two units: the Network Unit (NU), and the Coverage Unit (CU). NU and CU are shipped and sold as one unit. The NU transmits and receives Cellular signals from the base station and operates similar to a cellular handset. The CU transmits and receives signals with the cellular handset and operates on frequencies similar to the cellular base station. The NU and CU are connected wirelessly over a full-duplex wireless link in the UNII band using a mixed OFDM and muxed cellular signal over a 30 or 40 MHz channel in each direction. The CU also includes Bluetooth LE connectivity. With the use of smartphone application, it allows user to register the product, update software, capture/display details metrics of the system. The 5 GHz UNII band DFS functions of the EUT were verified in this test report.

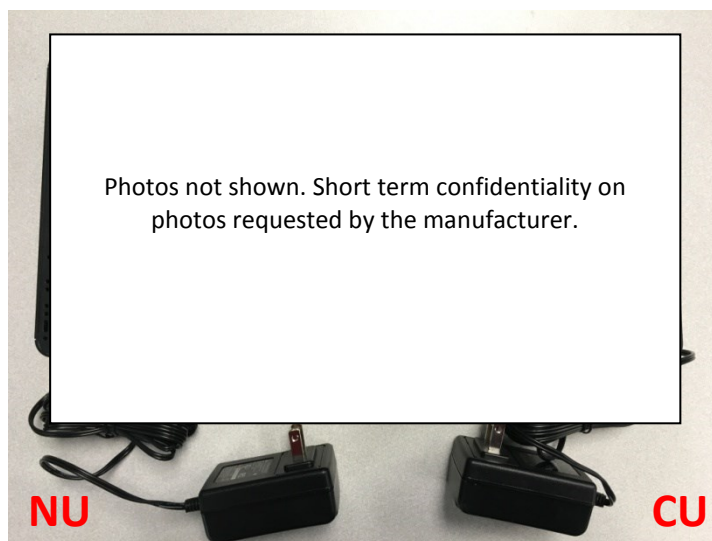

**Equipment Under Test**





**1.3.2 EUT General Description**

EUT Description Smart Cellular Signal Booster

Model Name Cel-Fi DUO

Model Number(s) D32-2/13/66

Rated Voltage 12V DC  $\pm$ 20% via external AC/DC adapter.

Frequency Range 5150 to 5350 MHz (NU)  
 5470 to 5725 MHz (CU)

Operating Mode Network Unit (NU) as a Master  
 Coverage Unit (CU) as a Master

Bridge Mode Support  Yes  No

MESH Mode Support  Yes  No

	<i>Lowest</i>	<i>Highest</i>
EUT EIRP (dBm)	See TPC below	23.68 dBm

Antenna	<i>NU</i>	<i>CU</i>
Type	PIFA	PIFA
Gain	1 dBi	0 dBi

Test Configuration Conducted. Manufacturer provided samples with a temporary antenna test port (50Ω impedance).

Transmit Power Control (TPC) The output power level on the uplink of the system is monitored and if it crosses the maximum specified output power, the system will automatically back off the transmit power levels to ensure that no noise is sent into the network. The system is also calibrated to ensure that this condition should never be met.

System Architecture  IP Based  Frame Based

U-NII Channel Bandwidths 30MHz and 40MHz

Modulation Used Proprietary Digitally Modulated OFDM



### 1.3.3 Product Security (from the Manufacturer Operational Description)

The Cel-Fi system is built with a number of security features to make sure that it only operates as intended by the operator deploying it while maintaining complete integrity of all traffic going through it. Specifically:

- 1) The system can operate only on operator approved frequency channels – and these channels are factory loaded in an encrypted fashion and cannot be tampered with.
- 2) Even on these frequencies the Cel-Fi system checks to see if the over-the-air (OTA) public land mobile network identifier (PLMNID) matches the PLMNID of the carrier. If it does not the system does not operate and never transmits. The PLMNID are also encrypted and factory loaded and cannot be tampered with.
- 3) The Cel-Fi system does not demodulate and re-modulate user cell signals and, in fact, cannot do so. It only digitizes the cellular RF signal, transports it from the NU to the CU (and vice-versa) over the UNII link and converts the digital signal back to analog and subsequently RF signal and puts it back on air. As such it completely preserves all the WCDMA/LTE call security features exactly as done by the NodeB or the UE and only the intended recipient can demodulate the signal. In other words, a WCDMA/LTE signal going through Cel-Fi has the same level of security of a WCDMA/LTE call not going through Cel-Fi.
- 4) The UNII link is a proprietary waveform and it is not possible to demodulate the signal without being aware of the exact waveform details.
- 5) By design of the UNII link - one NU can only connect with one CU. It is strictly a point-to-point link and cannot operate in any other way and particularly one NU cannot connect with multiple CU's.
- 6) Furthermore, a given NU can in fact only connect to its factory-mated CU. The factory mating is done by generating a pair identifier using a hash function that uses a NU serial number and its mate CU's serial number. This pair identifier is used in all transmissions in a way that cannot be spoofed. Also, the unit serial numbers are protected through use of public and private keys while writing to flash in the factory.
- 7) The fact that the UNII link is proprietary (and details unknown to the public), that it is point-to-point by design and can mate with only one factory mated NU or CU implies that it is not possible for another device to spoof a CU (or NU) and carry the digitized cell data to an unintended location (and the cell signal is secure in any case as discussed above).
- 8) Also, it is not possible to build only a receiver (NU or CU) to snoop on the UNII data. To demodulate data on the UNII link would require frame and packet synchronization with the transmitter – which is an explicit hand shake that requires exchange of scrambling codes etc. and, therefore, is not possible for a snooping device.

What these features provide is complete security so that cellular calls through Cel-Fi reach only the intended parties both in the downlink and the uplink.

The subsequent section will also highlight the fact that the end user does not have any access or control over the system – and hence cannot change any parameters or settings or otherwise impact security.



**1.4 EUT TEST CONFIGURATION**

**1.4.1 Test Configuration Description**

Test Configuration	Description
A	Fast and Freeze Up mode. Short CAC and then froze to selected channel. Channel will not be changed when radar detected. Radar detection monitored through “Radar Events” window of the DFS Conformance Testing application. Radar injected to NU (Test Configuration Diagram A).
B	Fast and Freeze Up mode. Short CAC and then froze to selected channel. Channel will not be changed when radar detected. Radar detection monitored through “Radar Events” window of the DFS Conformance Testing application. Radar injected to CU (Test Configuration Diagram B).
C	Fast UP mode. Short CAC and then lock to selected channel initially. Channel will be changed when radar detected. Radar injected to NU (Test Configuration Diagram A).
D	Fast UP mode. Short CAC and then lock to selected channel initially. Channel will be changed when radar detected. Radar injected to CU (Test Configuration Diagram B).
E	Auto Channel Select. Normal CAC, auto selects a free channel. Channel will be changed when Radar is detected. Output of CU (HB) monitored (Test Configuration Diagram A).
F	Auto Channel Select. Normal CAC, auto selects a free channel. Channel will be changed when Radar is detected. Output of NU (LB) monitored (Test Configuration Diagram B).
G	Auto Channel Select. Normal CAC, auto selects a free channel. Channel will be changed when Radar is detected. Radar injected to TX Output port of NU. NU is the Master for both LB and HB before CU comes on-line. NU will do HB ISM and detect all Radars. Output of CU (HB) monitored (Test Configuration Diagram C).

**1.4.2 EUT Exercise Software**

Manufacturer provided a configuration software (ConformanceTest.exe) running from a support laptop where both EUT are connected via USB.

**1.4.1 Support Equipment and I/O cables**

Manufacturer	Equipment/Cable	Description
Lenovo	Support Laptop (T410S)	P/N 0A31972 S/N R9-92MH0 10/11

*Laptop used during programming is generic and can be different brand and model.*

### 1.4.2 Simplified Test Configuration Diagram

#### Test Configuration "A"

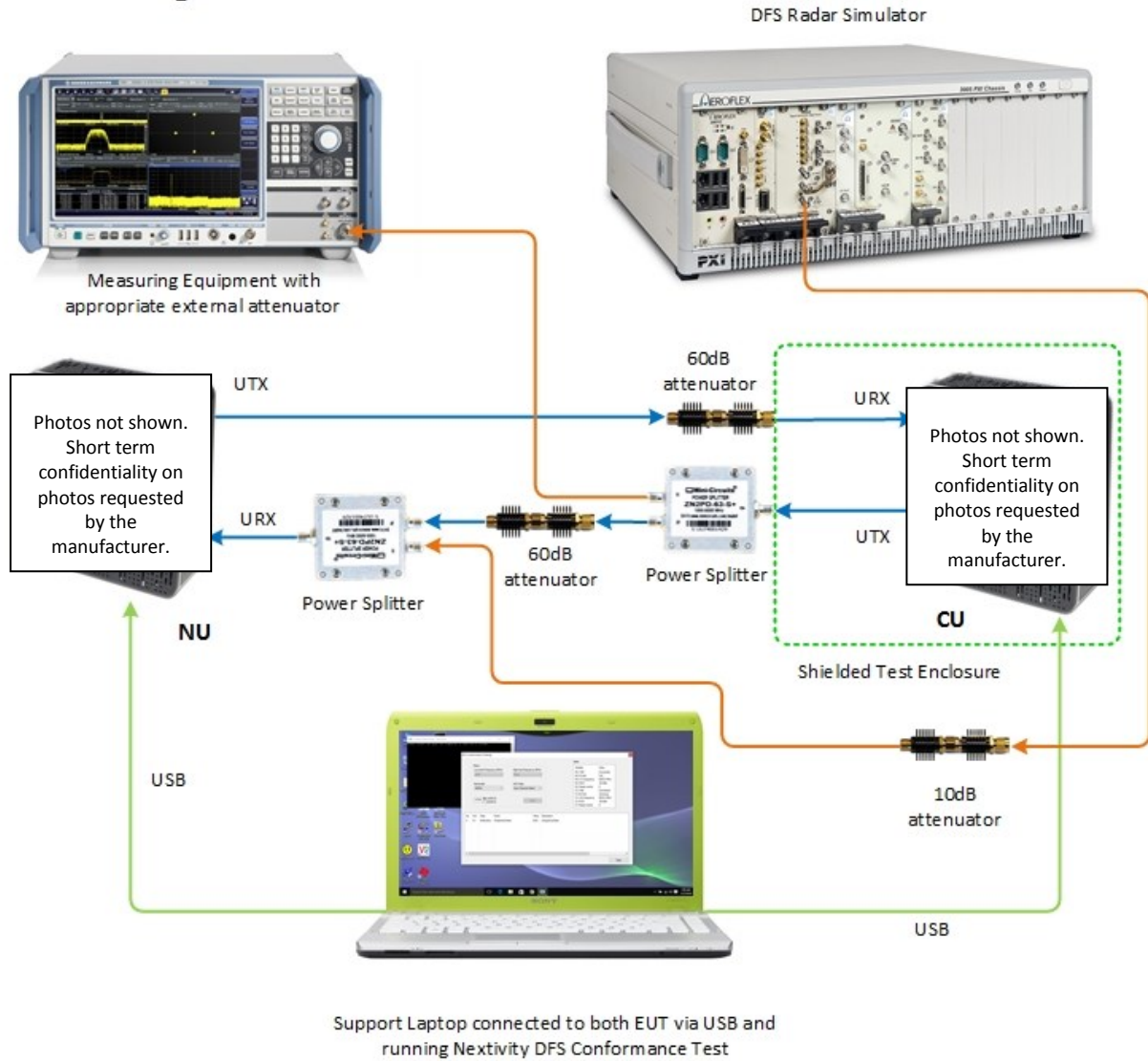

### Test Configuration "B"

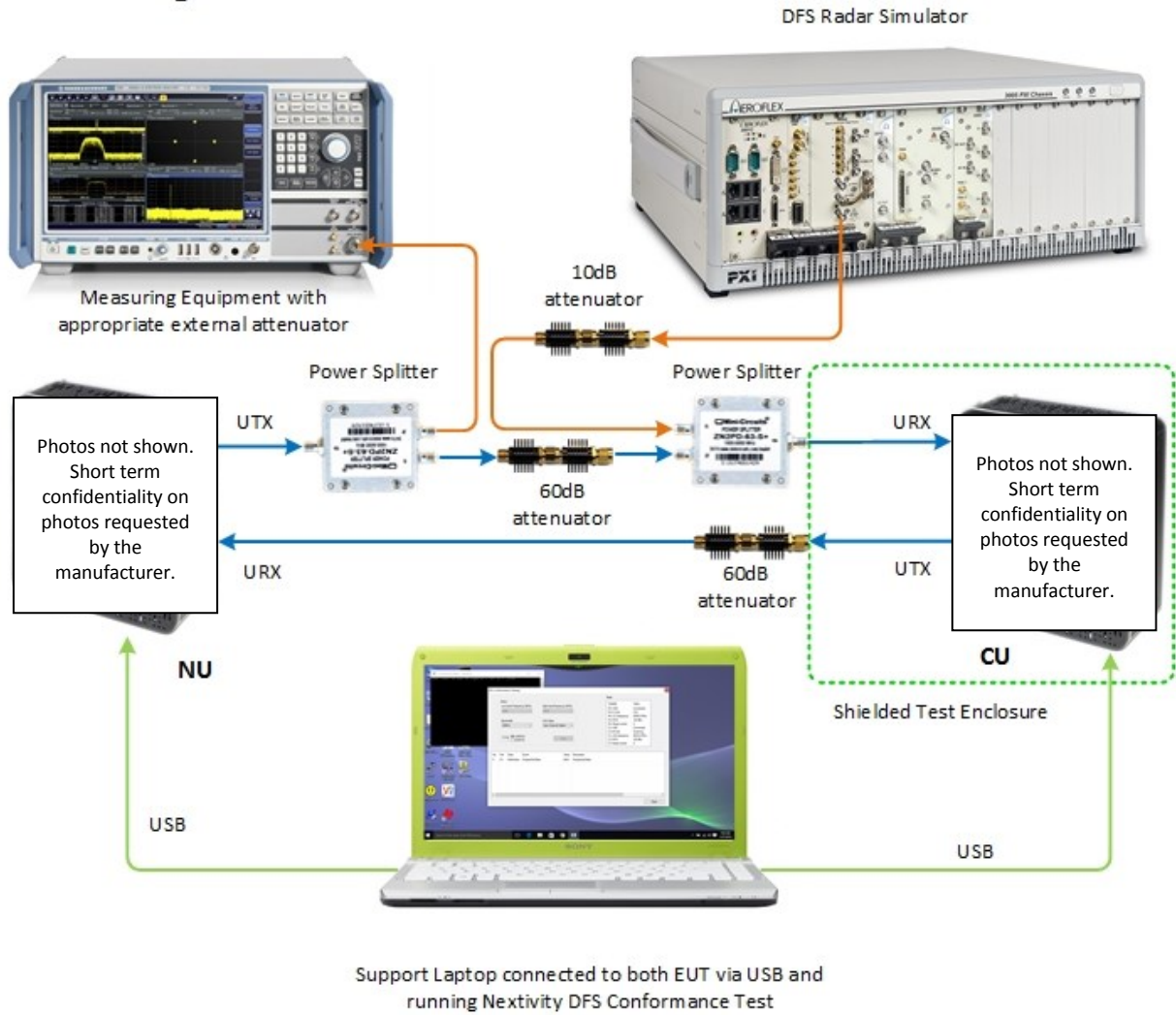

### Test Configuration "C"

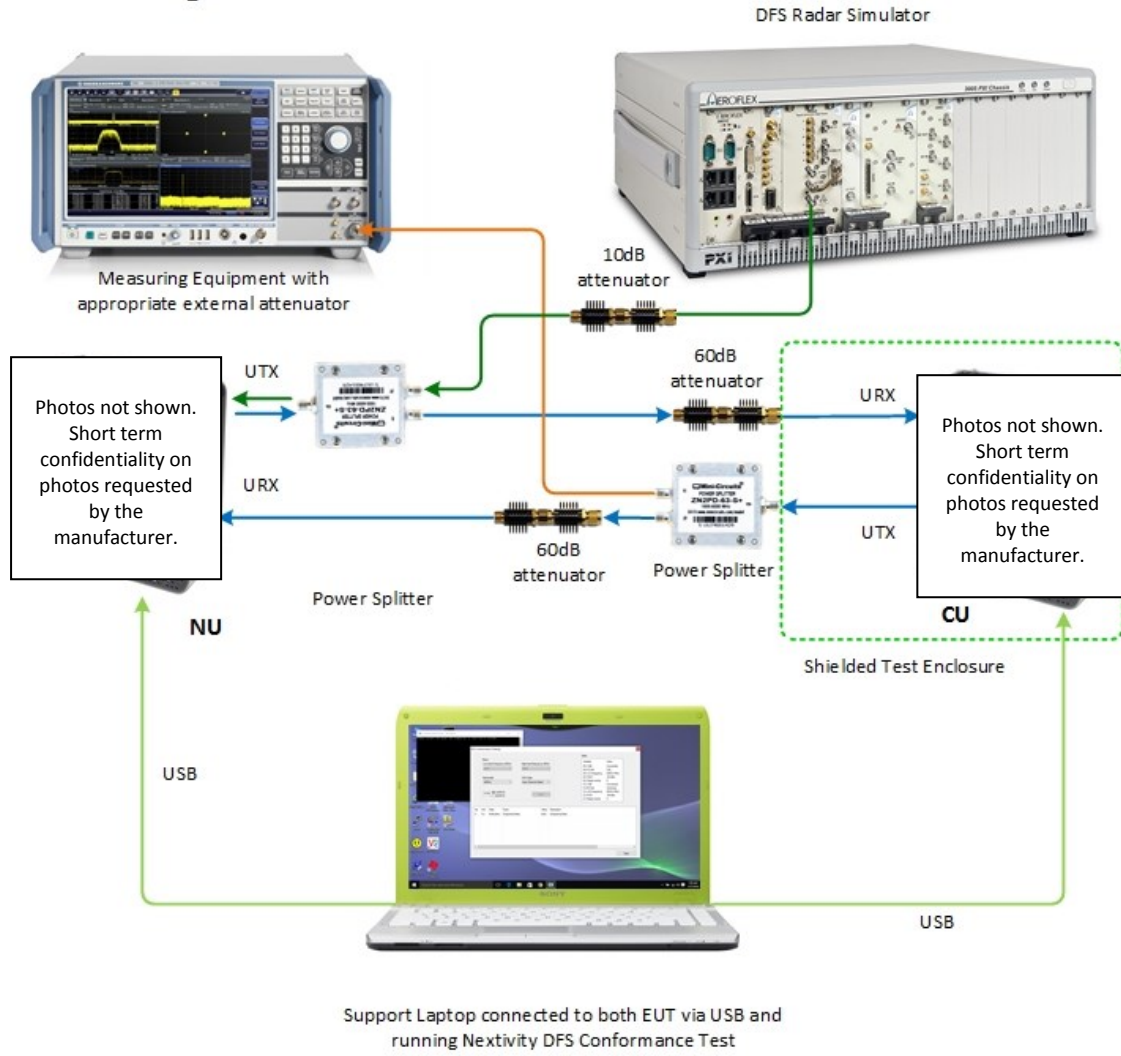



**1.5 DEVIATIONS FROM THE STANDARD**

At the time of verification, the DFS Radar Simulator and Analyzer does not have the latest updates according to “Bin 5 Radar Chirp – Proposed Solution’ as discussed during the October 2015 TCB Workshop. The procedure was followed but instead of using single pulse width for each trial on the edges, random pulse widths were used as generated by the simulator. The test frequency was adjusted to cover the minimum chirp width (5MHz) up to the maximum chirp width (20MHz). For example with  $F_L$  of 5261 MHz (Center frequency of 5280 MHz with Radar Detection BW of 38 MHz), the first test frequency will be  $F_L + 0.4$  (5MHz) while the last one for the Subset will be  $F_L + 0.4$  (20MHz). Since each trial has randomized chirp width from 5MHz up to 20MHz, the test frequency used during testing ensures that the Chirp will be inside the channel radar detection BW for each trial performed. See sample test frequencies below for  $F_L$  of 5261 MHz:

Test Frequencies for $F_L$ of 5261 MHz (Subset for Low Edge)			
Trial 1	5263 MHz	Trial 6	5266 MHz
Trial 2	5264 MHz	Trial 7	5267 MHz
Trial 3	5264 MHz	Trial 8	5268 MHz
Trial 4	5265 MHz	Trial 9	5268 MHz
Trial 5	5266 MHz	Trial 10	5269 MHz

**1.6 MODIFICATION RECORD**

Description of Modification	Modification Fitted By	Date Modification Fitted
296546000608 (NU) and 297546000537 (CU)		
N/A		

The table above details modifications made to the EUT during the test programme. The modifications incorporated during each test (if relevant) are recorded on the appropriate test pages.

**1.7 TEST METHODOLOGY**

All measurements contained in this report were conducted in accordance with KDB905462 D02 UNII DFS Compliance Procedures New Rules v01r02. Compliance Measurement Procedures For Unlicensed-National Information Infrastructure Devices Operating In The 5250-5350 Mhz And 5470-5725 Mhz Bands Incorporating Dynamic Frequency Selection (May 15, 2015).

**1.8 TEST FACILITY LOCATION**

**1.8.1 TÜV SÜD America Inc. (Mira Mesa)**

10040 Mesa Rim Road, San Diego, CA 92121-2912 (32.901268,-117.177681). Phone: 858 678 1400 FAX: 858-546 0364



**1.8.2 TÜV SÜD America Inc. (Rancho Bernardo)**

16530 Via Esprillo, San Diego, CA 92127-1708 (33.018644,-117.092409). Phone: 858 678 1466 FAX: 858-546 0364

**1.9 TEST FACILITY REGISTRATION**

**1.9.1 FCC – Registration No.: US1146**

TUV SUD America Inc. (San Diego), is an accredited test facility with the site description report on file and has met all the requirements specified in §2.948 of the FCC rules. The acceptance letter from the FCC is maintained in our files and the Registration is US1146.

**1.9.2 Industry Canada (IC) Registration No.: 3067A**

The 10m Semi-anechoic chamber of TUV SUD America Inc. (San Diego) has been registered by Certification and Engineering Bureau of Industry Canada for radio equipment testing with Registration No. 3067A.





**1.10 DFS TEST SYSTEM**

The DFS system consists of hardware and software. The Hardware uses a PXI chassis with PXI instruments populating the chassis. The instruments used are a Vector Signal Generator, a Digitiser, Frequency References and a Dual Core PC (Windows 7 Professional). The Measurement and Analysis software runs on the PC and controls the instruments within the mainframe via commands on the PXI bus. Various markers are contained within the generated waveforms. The markers are used to trigger the measurement system at the appropriate points. An external trigger is also provided at the SMB output on the Vector Signal Generator which is employed where a Spectrum Analyzer is used in place of the Aeroflex Digitiser. These are described within the test procedure for the applicable test.

The Aeroflex DFS software generates the pulses in accordance with KDB905462.

**1.10.1 Short Pulse Radar Test Waveforms (Types 0-4)**

The short pulse radar simulation is a conventional amplitude pulse with varying pulse widths, pulse rate intervals (PRI) and number of pulses. General characteristics for these types and number of repetitions required by the standard are as follows:

Radar Type	Pulse Width (µsec)	PRI (µsec)	Number of Pulses
0	1	1428	18
1	1	Test A: 15 unique PRI values randomly selected	Roundup((1/360)x(19x10 <sup>6</sup> /PRI <sub>µsec</sub> ))
		Test B: 15 unique PRI values randomly selected within the range of 518-3066 µsec, with a minimum increment of 1 µsec, excluding PRI values selected in Test A	
2	1-5	150-230	23-29
3	6-10	200-500	16-18
4	11-20	200-500	12-16

**1.10.2 Long Pulse Radar Test Waveforms (Types 5)**

The long pulse radar simulation is a 12 second concatenated series of chirps, chosen randomly. The general characteristics for Type 5 and number of repetitions required by the standard are as follows:

Radar Type	Pulse Width (µsec)	Chirp Width (MHz)	PRI (µsec)	Number of Pulses/Burst	Number of Burst
5	50-100	5-20	1000-2000	1-3	8-20



The parameters for this waveform are randomly chosen. Thirty unique waveforms are required for the Long Pulse Radar Type waveforms. If more than 30 waveforms are used for the Long Pulse Radar Type waveforms, then each additional waveform must also be unique and not repeated from the previous waveforms. Each waveform is defined as follows:

- 1) The transmission period for the Long Pulse Radar test signal is 12 seconds.
- 2) There are a total of 8 to 20 Bursts in the 12 second period, with the number of Bursts being randomly chosen. This number is Burst\_Count.
- 3) Each Burst consists of 1 to 3 pulses, with the number of pulses being randomly chosen. Each Burst within the 12 second sequence may have a different number of pulses.
- 4) The pulse width is between 50 and 100 microseconds, with the pulse width being randomly chosen. Each pulse within a Burst will have the same pulse width. Pulses in different Bursts may have different pulse widths.
- 5) Each pulse has a linear frequency modulated chirp between 5 and 20 MHz, with the chirp width being randomly chosen. Each pulse within a Burst will have the same chirp width. Pulses in different Bursts may have different chirp widths. The chirp is centered on the pulse. For example, with a radar frequency of 5300 MHz and a 20 MHz chirped signal, the chirp starts at 5290 MHz and ends at 5310 MHz.
- 6) If more than one pulse is present in a Burst, the time between the pulses will be between 1000 and 2000 microseconds, with the time being randomly chosen. If three pulses are present in a Burst, the random time interval between the first and second pulses is chosen independently of the random time interval between the second and third pulses.
- 7) The 12 second transmission period is divided into even intervals. The number of intervals is equal to Burst\_Count. Each interval is of length  $(12,000,000 / \text{Burst\_Count})$  microseconds. Each interval contains one Burst. The start time for the Burst, relative to the beginning of the interval, is between 1 and  $[(12,000,000 / \text{Burst\_Count}) - (\text{Total Burst Length}) + (\text{One Random PRI Interval})]$  microseconds, with the start time being randomly chosen. The step interval for the start time is 1 microsecond. The start time for each Burst is chosen randomly.

**1.10.3 Frequency Hopping Radar Test Waveform (Types 6)**

Radar Type	Pulse Width (µsec)	PRI (µsec)	Pulse per Hop	Hopping Rate (kHz)	Hopping Sequence Length (msec)
6	1	333	9	5-20	300

For the Frequency Hopping Radar Type, the same Burst parameters are used for each waveform. The hopping sequence is different for each waveform and a 100-length segment is selected from the hopping sequence defined by the following algorithm:

The first frequency in a hopping sequence is selected randomly from the group of 475 integer frequencies from 5250 – 5724 MHz. Next, the frequency that was just chosen is removed from the group and a frequency is randomly selected from the remaining 474 frequencies in the group. This process continues until all 475 frequencies are chosen for the set. For selection of a random frequency, the frequencies remaining within the group are always treated as equally likely.



## SECTION 2

### CALIBRATION AND TEST DETAILS

DFS Testing of the  
Nextivity Inc.  
Smart Cellular Signal Booster

**2.1 RADAR WAVEFORM CALIBRATION**

**2.1.1 Requirement**

Clause 8.2 of KDB905462 D02 UNII DFS Compliance Procedures New Rules v01r02

**2.1.2 Description of Calibration Setup**

Conducted method was used. Test Configurations “A” and “B” (Section 1.4.2) were modified so that the Master RX input (NU for Test Configuration “A” and CU for Test Configuration “B”) was replaced by a spectrum analyzer:

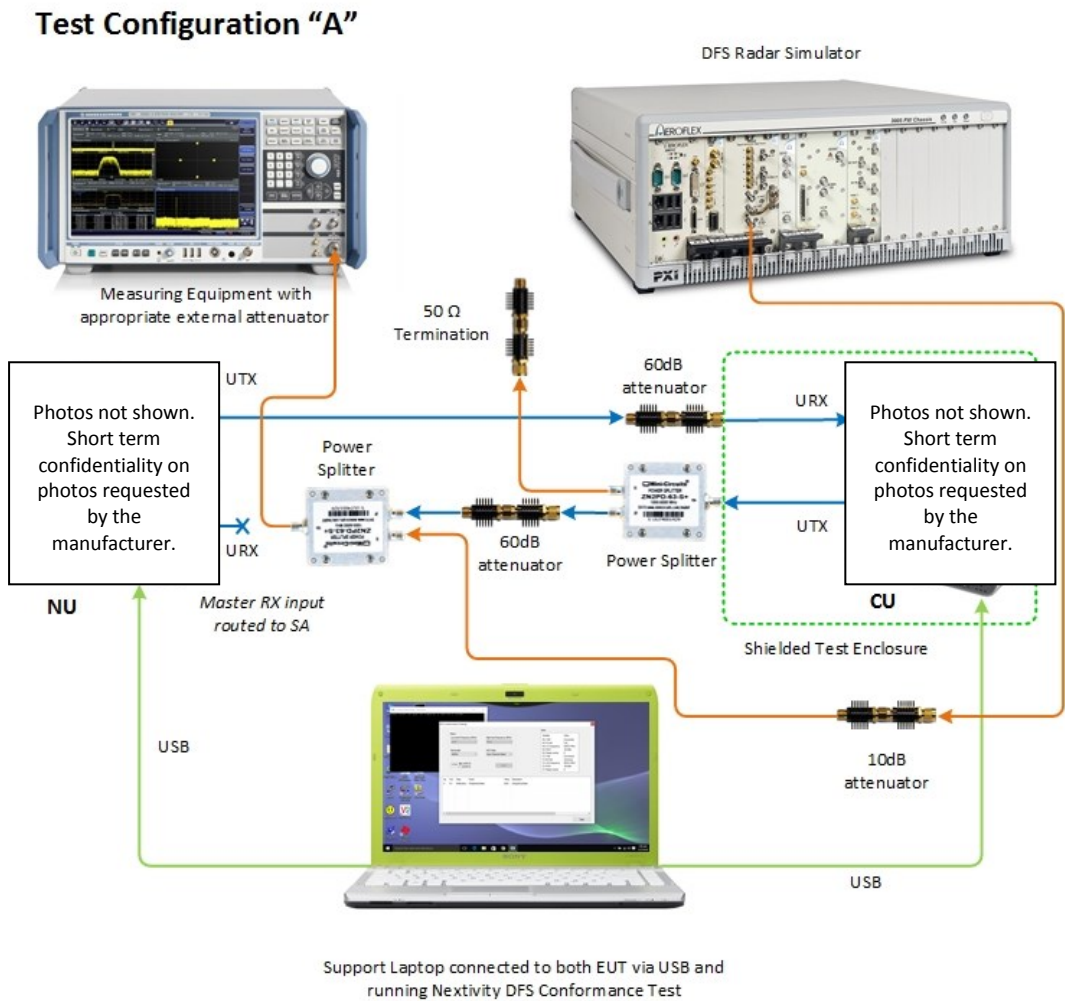

Calibration for CU RX input will be identical since the setup will be reversed when verifying CU as a Master (Test Configuration “B”). Both EUTs (NU and CU) were “off” during calibration.

**2.1.3 DFS Detection Threshold**

Reported EIRP using the highest antenna gain (1 dBi) is 22 dBm or 158.5 mW. Highest reported power spectral density is 9.62 dBm/MHz (from test report no. SD72112724-0116F FCC Part 15.407 Subpart E RSS247 Test Report.docx (issued by TÜV SÜD America, February 2016). Therefore the DFS Detection Threshold is -61 dBm (-62 dBm + 1 dB).



**2.1.4 Date of Test/Initial of test personnel who performed the test**

February 4 and 5, 2016/FSC

**2.1.5 Test Equipment Used**

The major items of test equipment used for the above tests are identified in Section 3.1.

**2.1.6 Environmental Conditions**

Calibration performed at TÜV SÜD America Inc. Rancho Bernardo facility

Ambient Temperature      22.0°C  
 Relative Humidity          18.0%  
 ATM Pressure                100.1 kPa

**2.1.7 Additional Observations**

- Two frequencies were verified: 5280 MHz for Low Band and 5630 MHz for High Band.
- RBW and VBW were set to 3MHz.
- Sweep time was adjusted to show one complete burst.
- Trigger offset was -3ms to show start of the burst.
- The -2dB offset accounts for the connectors and insertion loss of the SMA pigtail at 5GHz.

**2.1.8 Calibration Level Results**

These settings will be used during actual verification:

Frequency	Radar Type	Radar Simulator Level Setting (dBm)	Radar Simulator Path Loss (dB)
5280 MHz	0 to 5	-61.00	17
5630 MHz	0 to 5	-61.00	17
5280 MHz	6	-55.50*	17
5630 MHz	6	-59.50*	17

*\*This is the Radar generator level setting necessary to produce -61.0 dBm Radar at the RX input of both NU and CU when configured as a Master device when using radar Type 6.*



### 2.1.9 Calibration Plots

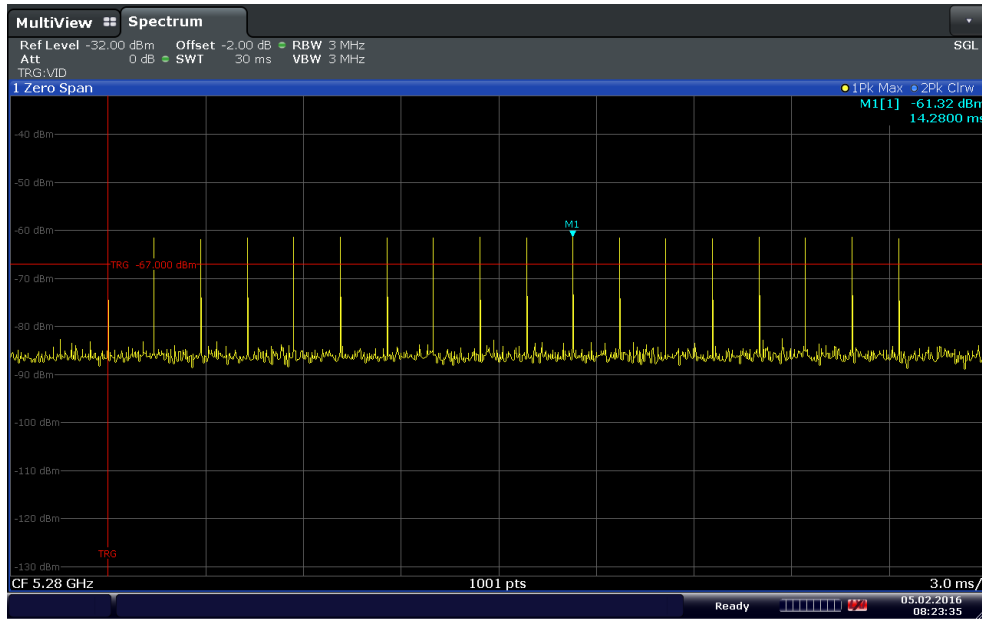

Date: 5.FEB.2016 08:23:35

**Radar Type 0 @ 5280 MHz**

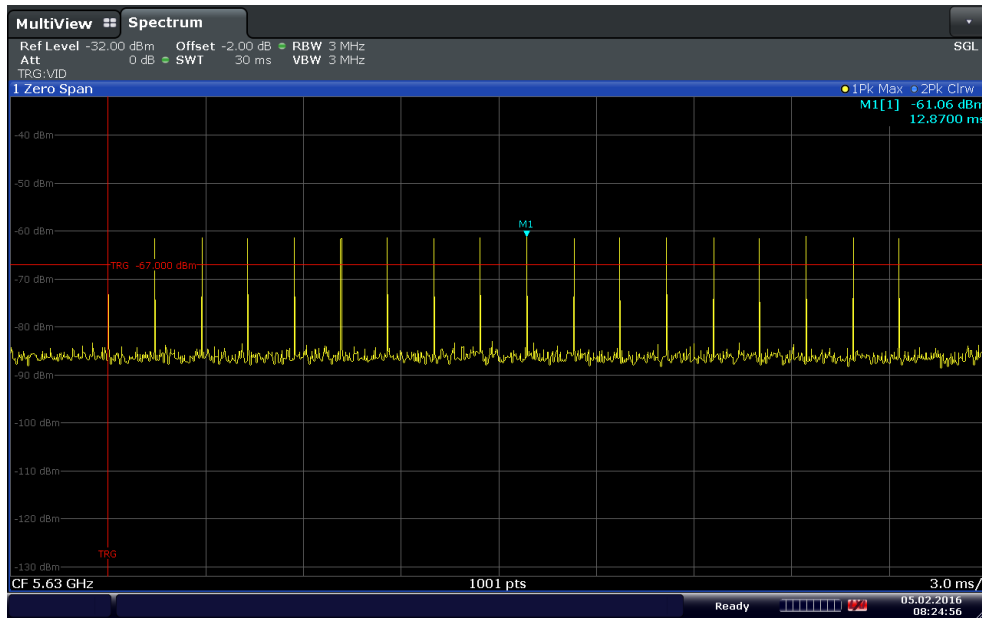

Date: 5.FEB.2016 08:24:56

**Radar Type 0 @ 5630 MHz**

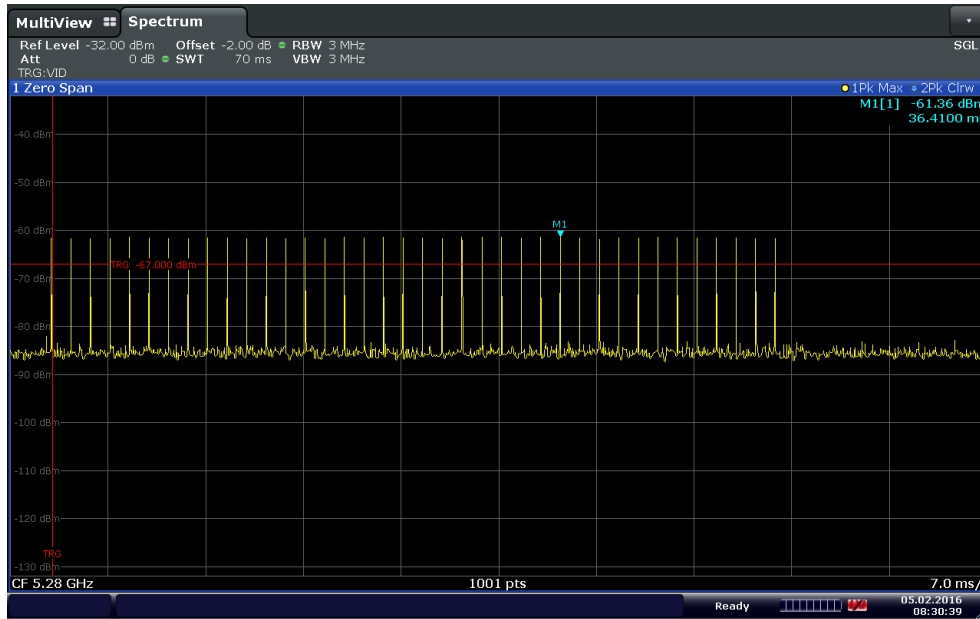

Date: 5.FEB.2016 08:30:39

**Radar Type 1 @ 5280 MHz**

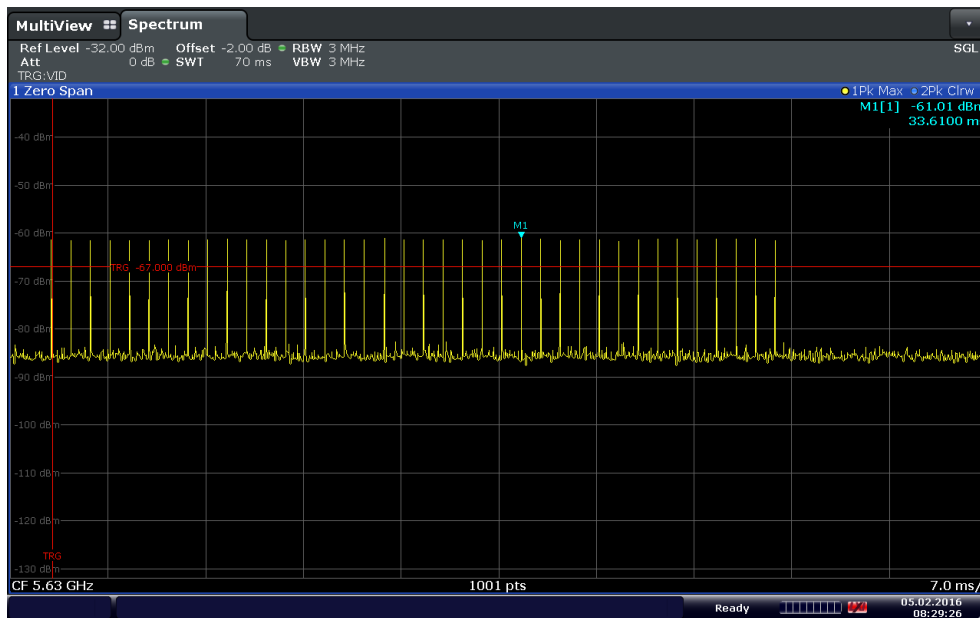

Date: 5.FEB.2016 08:29:26

**Radar Type 1 @ 5630 MHz**

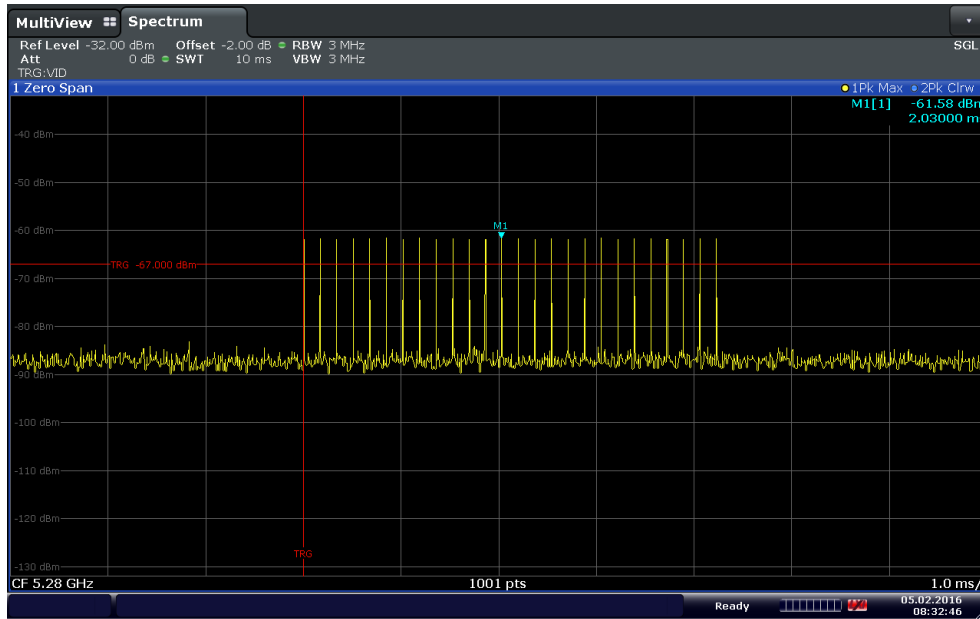

Date: 5.FEB.2016 08:32:46

### Radar Type 2 @ 5280 MHz

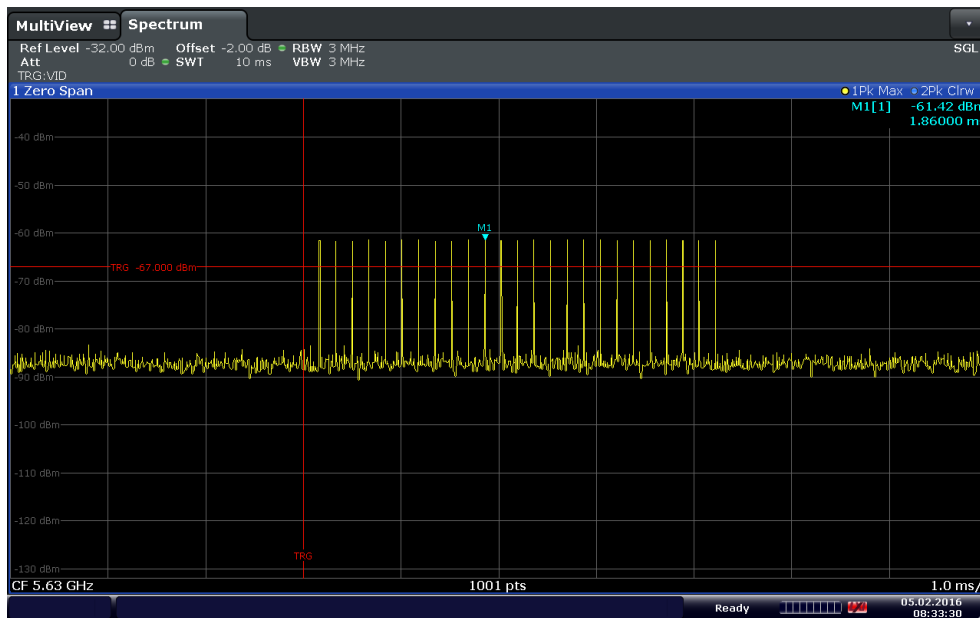

Date: 5.FEB.2016 08:33:30

### Radar Type 2 @ 5630 MHz



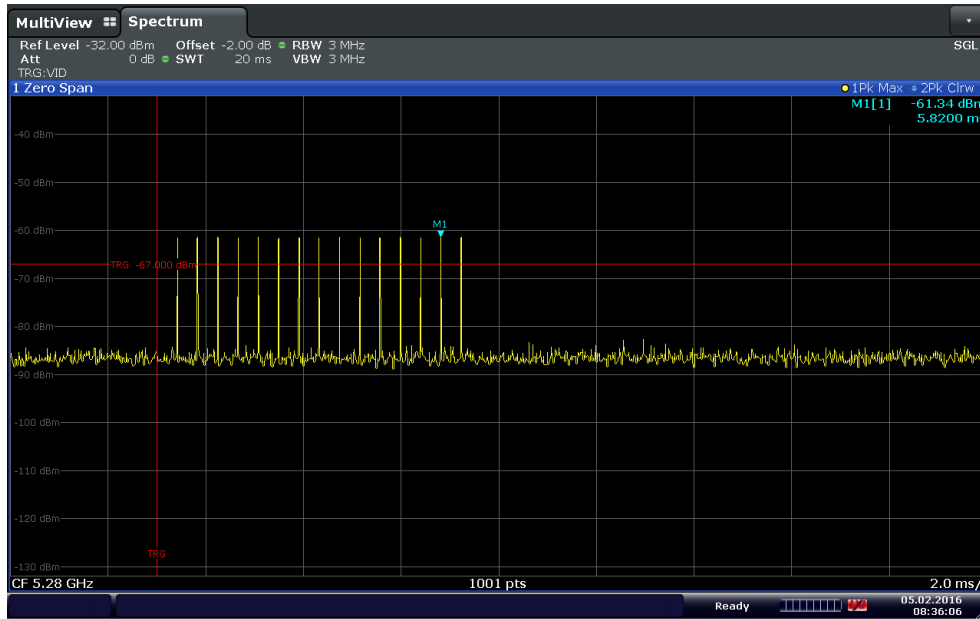

Date: 5.FEB.2016 08:36:06

**Radar Type 3 @ 5280 MHz**

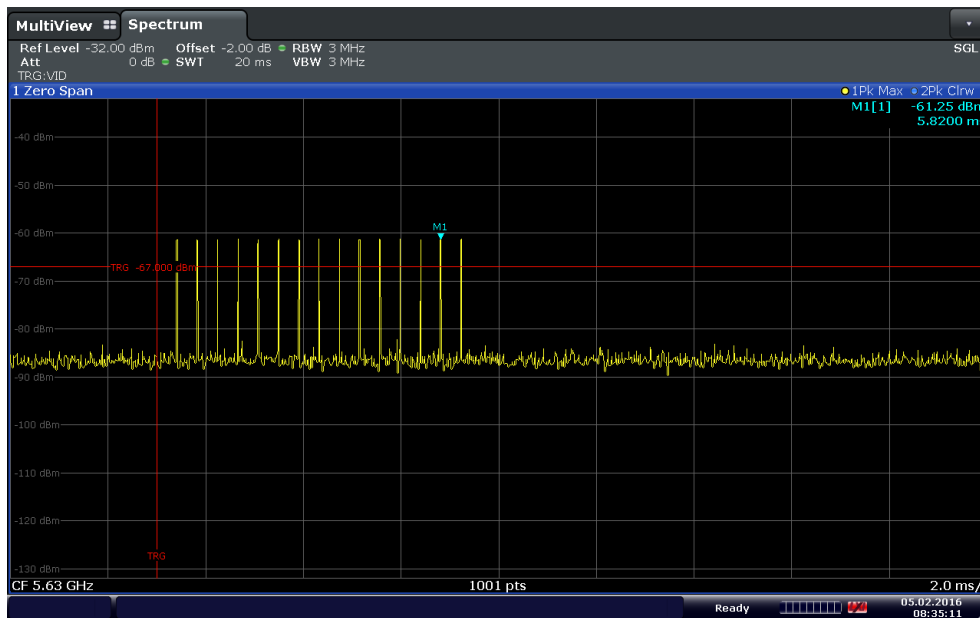

Date: 5.FEB.2016 08:35:11

**Radar Type 3 @ 5630 MHz**

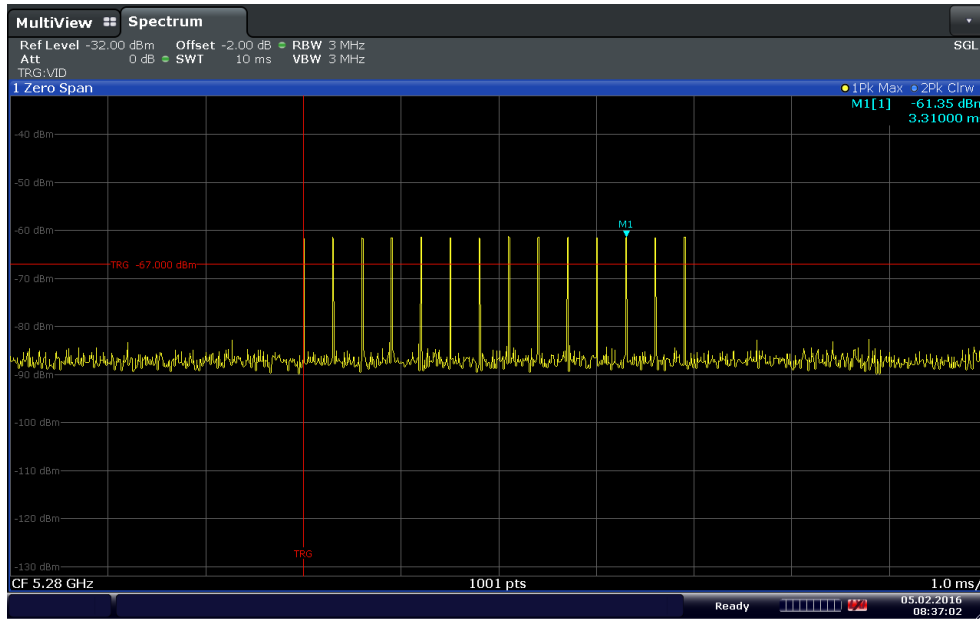

Date: 5.FEB.2016 08:37:02

**Radar Type 4 @ 5280 MHz**

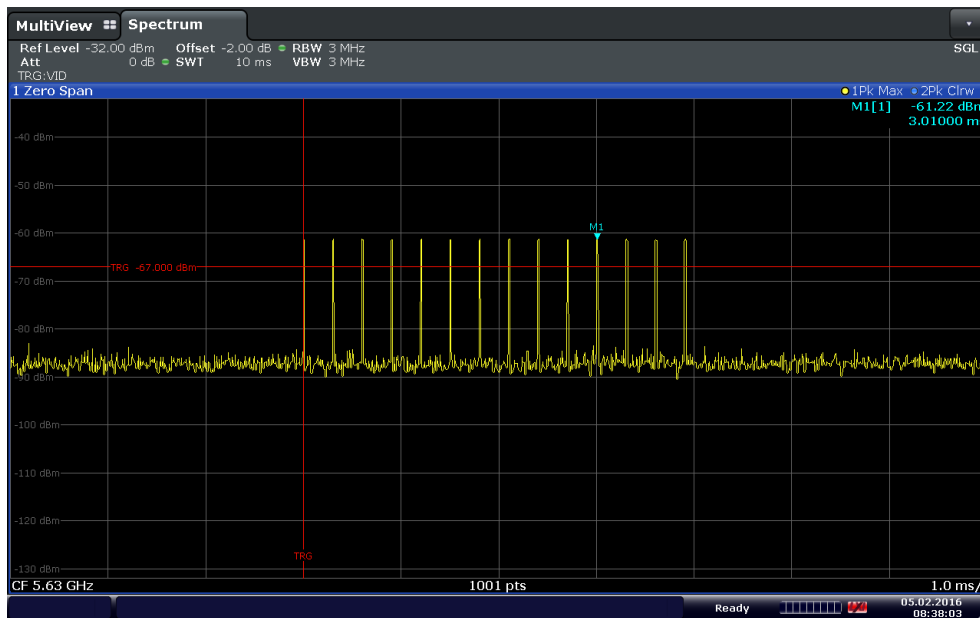

Date: 5.FEB.2016 08:38:04

**Radar Type 4 @ 5630 MHz**

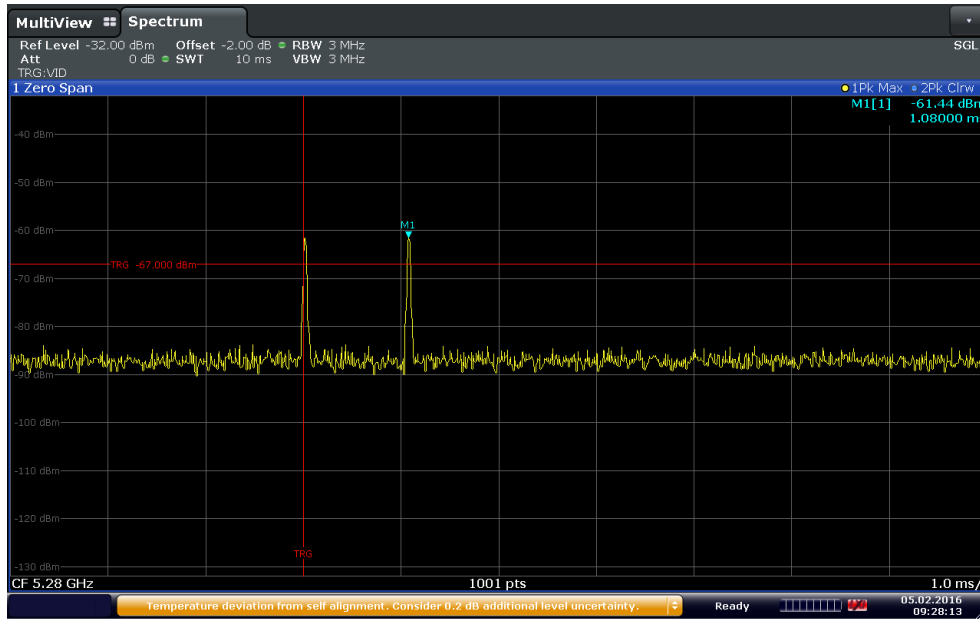

Date: 5.FEB.2016 09:28:12

**Radar Type 5 @ 5280 MHz (showing single burst with 1-3 pulses)**

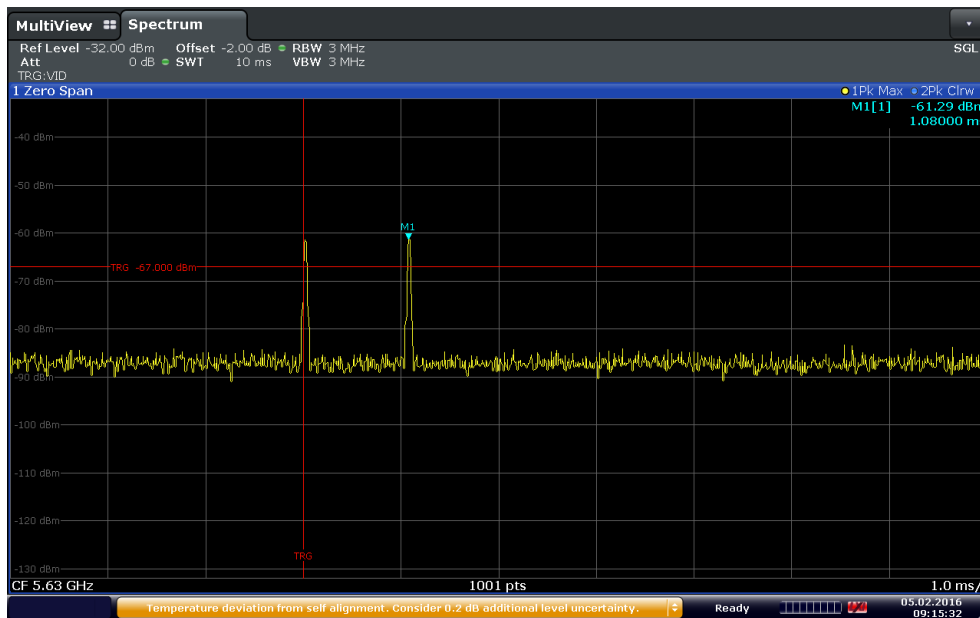

Date: 5.FEB.2016 09:15:33

**Radar Type 5 @ 5630 MHz (showing single burst with 1-3 pulses)**

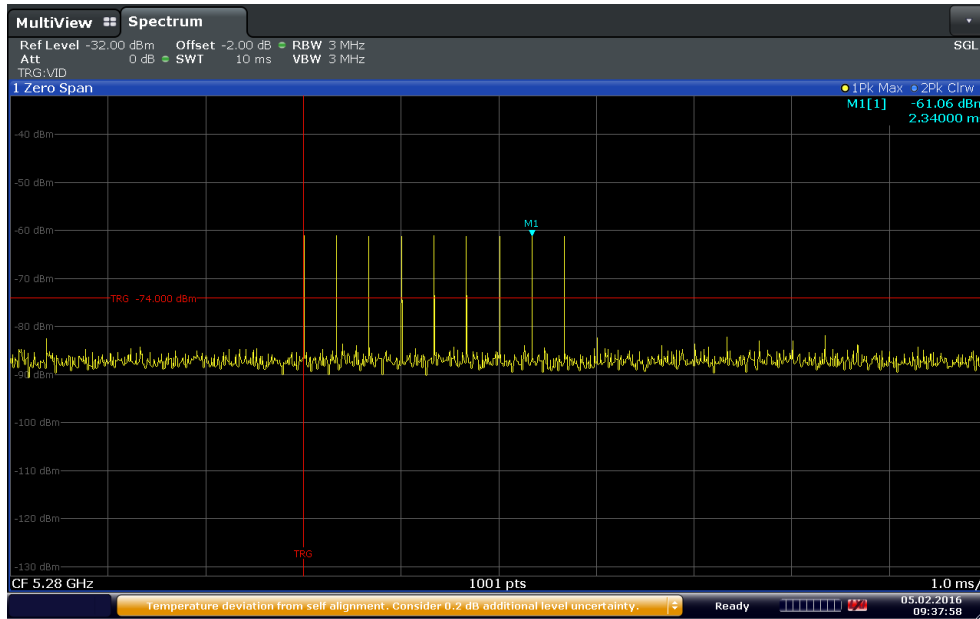

Date: 5.FEB.2016 09:37:58

**Radar Type 6 @ 5280 MHz (showing 9 pulses within the U-NII Detection Bandwidth)**

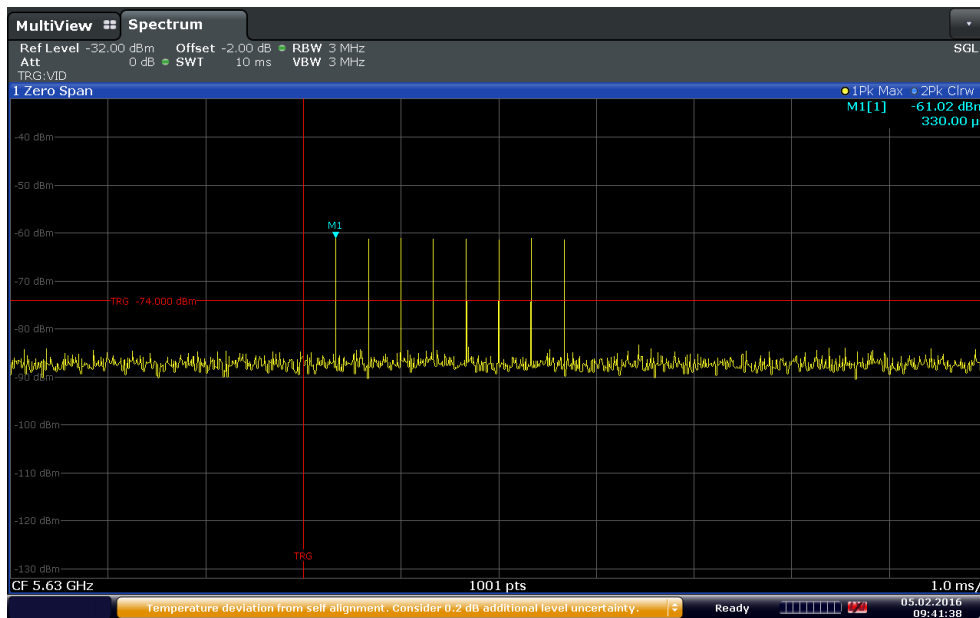

Date: 5.FEB.2016 09:41:38

**Radar Type 6 @ 5630 MHz (showing 9 pulses within the U-NII Detection Bandwidth)**

2.1.10 Calibration Setup Photo

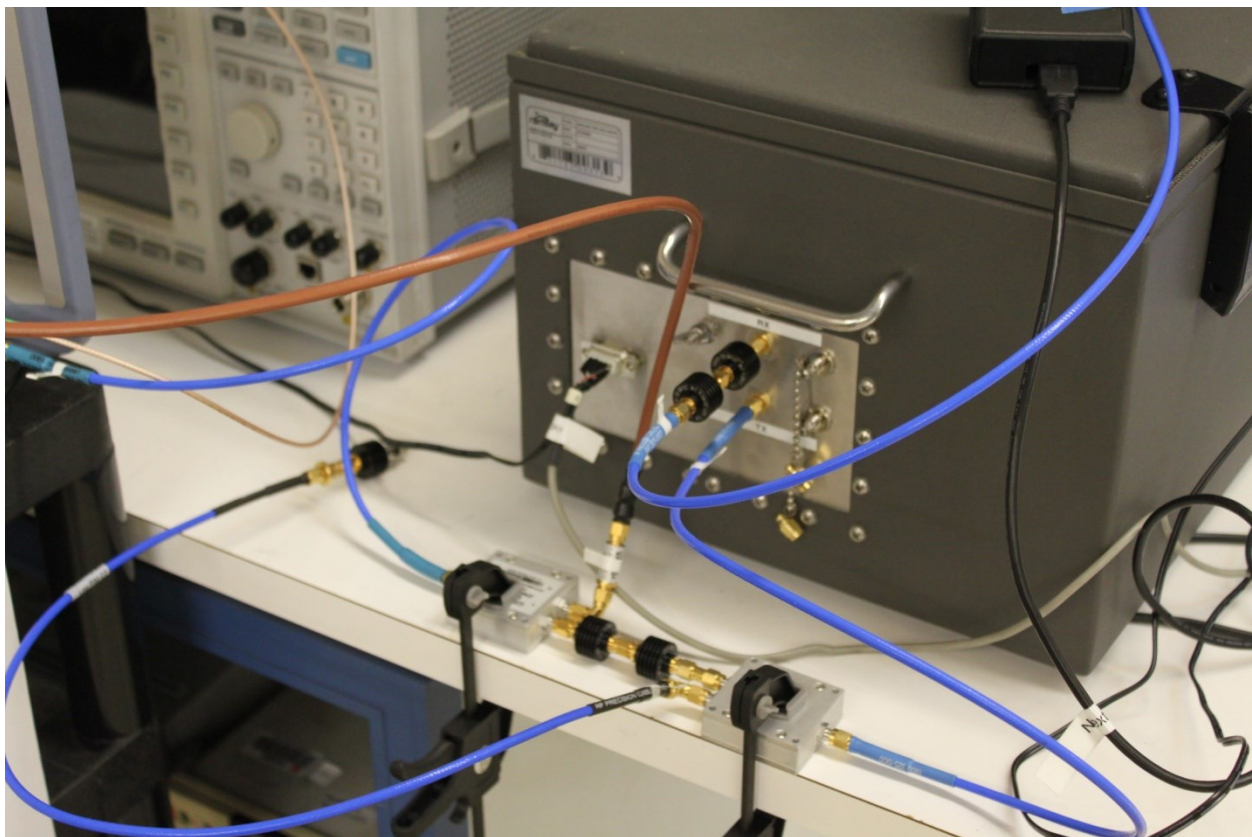
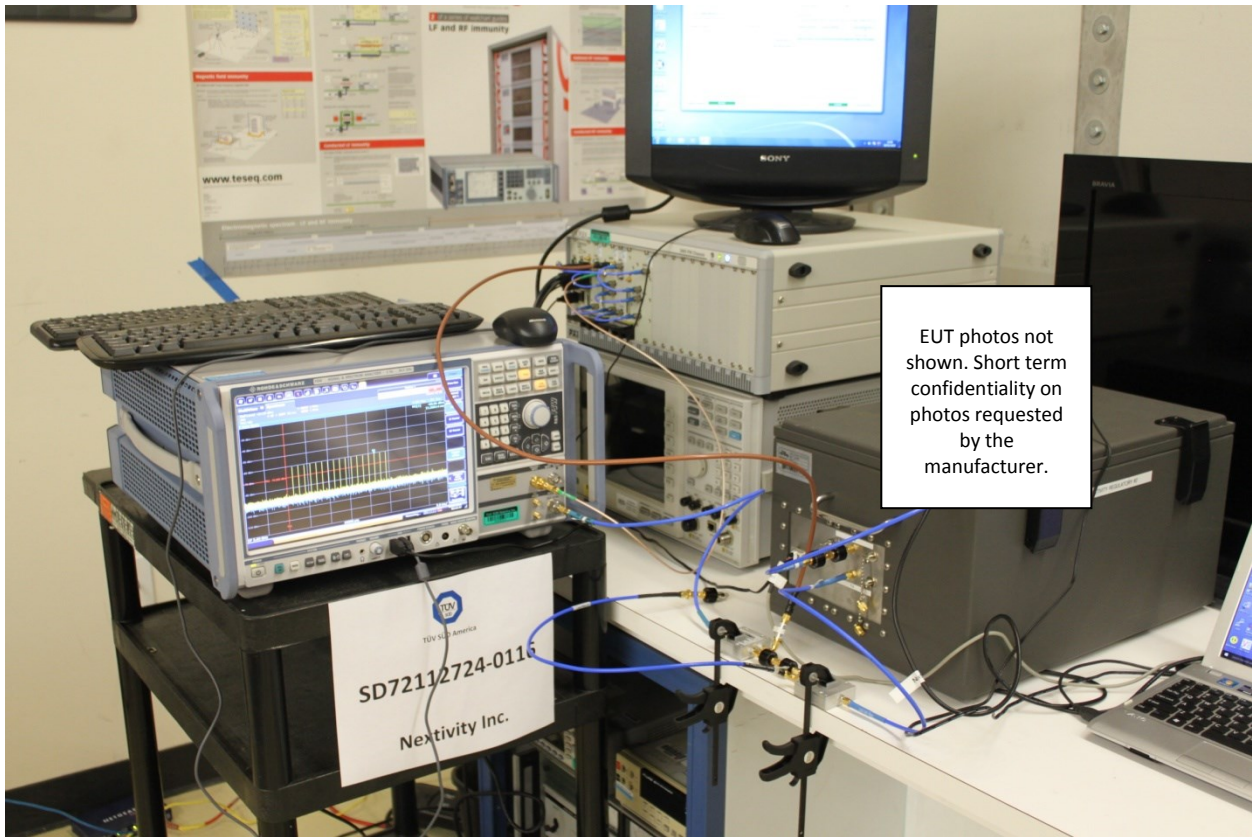



**2.2 CHANNEL LOADING**

**2.2.1 Requirement**

Clause 8.3 (f) of KDB905462 D02 UNII DFS Compliance Procedures New Rules v01r02

**2.2.2 Equipment Under Test and Modification State**

Serial No: 296546000608 (NU) and 297546000537 (CU) / Test Configuration A and B

**2.2.3 Date of Test/Initial of test personnel who performed the test**

February 05, 2016 / FSC

**2.2.4 Test Equipment Used**

The major items of test equipment used for the above tests are identified in Section 3.1.

**2.2.5 Environmental Conditions**

Test performed at TÜV SÜD America Inc. Rancho Bernardo facility

Ambient Temperature      22.0 °C  
 Relative Humidity          18.0 %  
 ATM Pressure                100.1 kPa

**2.2.6 Channel Loading Verification**

Channel Loading Description	Test Mode. NU and CU are connected over a full-duplex link. The manufacturer provided a test mode wherein a 100% duty cycle signal are transmitted on both the Low Band (NU) and High Band (CU).
Data Type	Mixed OFDM and muxed cellular signal
Timing Plots	See attached Channel Loading plots
Channel Loading Percentage	100%
Protocol	Proprietary communication protocol design



### 2.2.7 Channel Loading Plots

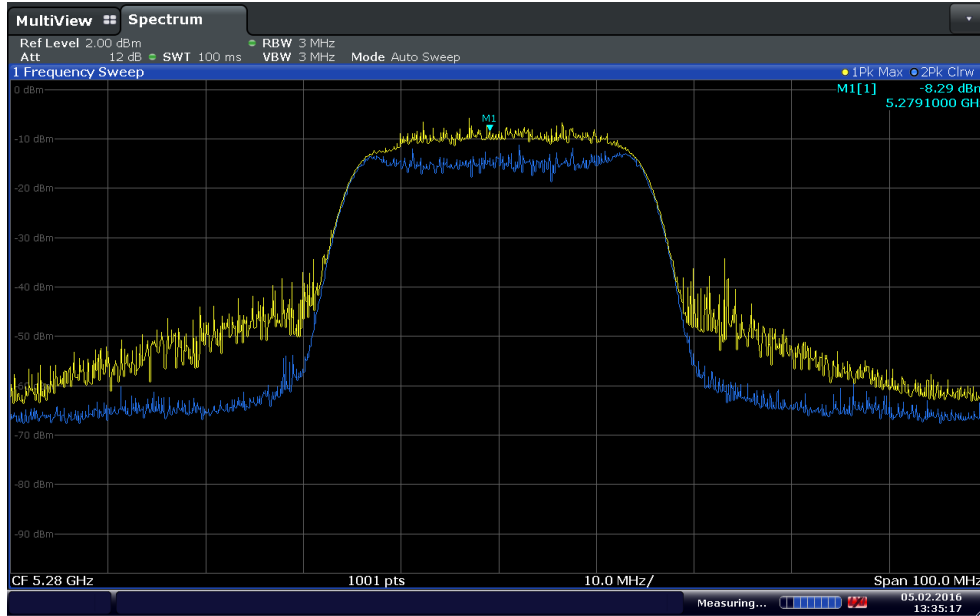

Date: 5.FEB.2016 13:35:17

30 MHz BW 5280 MHz

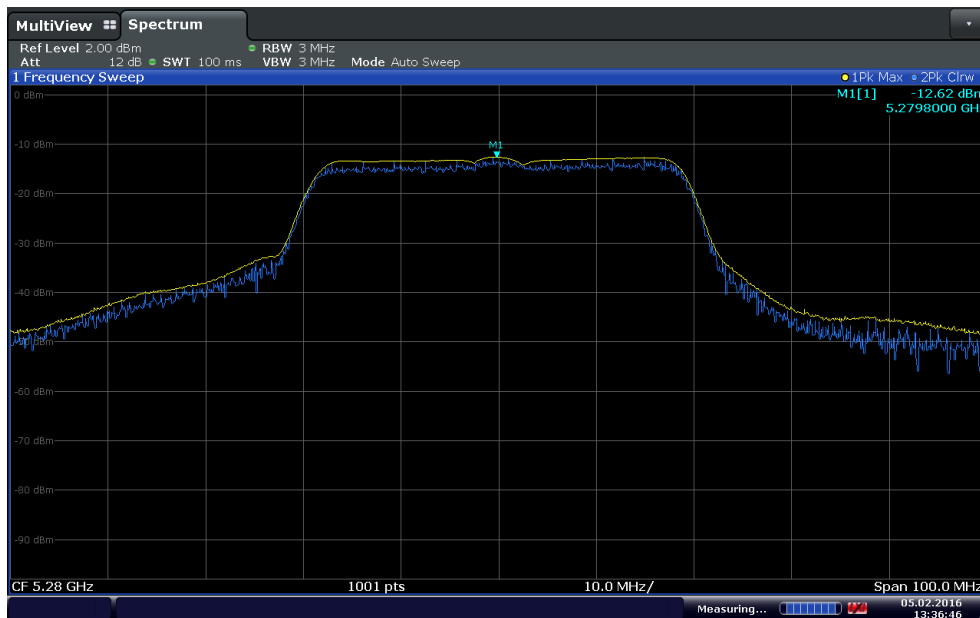

Date: 5.FEB.2016 13:36:46

40 MHz BW 5280 MHz

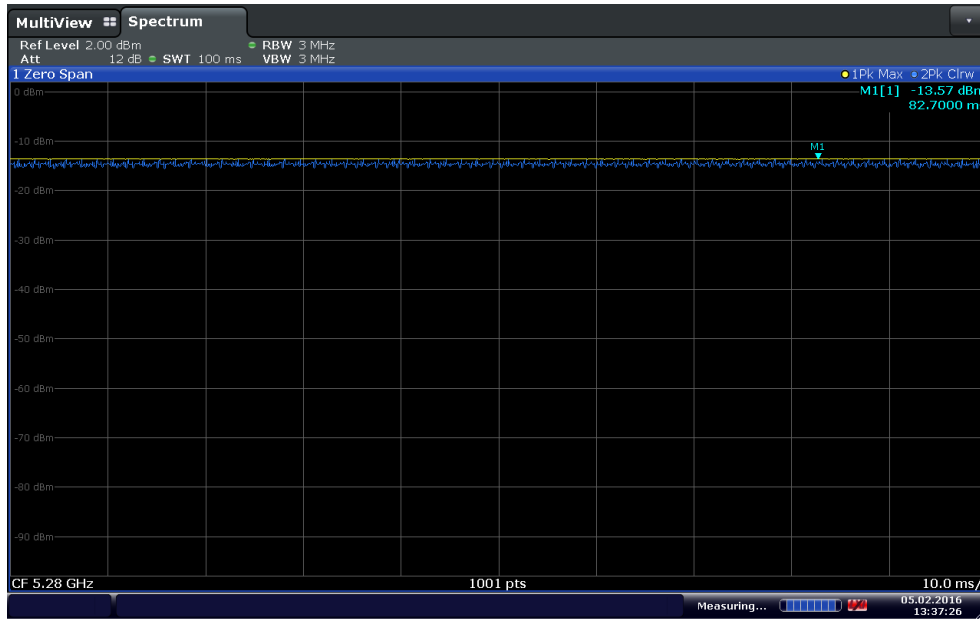

Date: 5.FEB.2016 13:37:27

**40 MHz BW 5280 MHz showing 100% loading (Channel loading is the same between 30 MHz and 40MHz BW)**

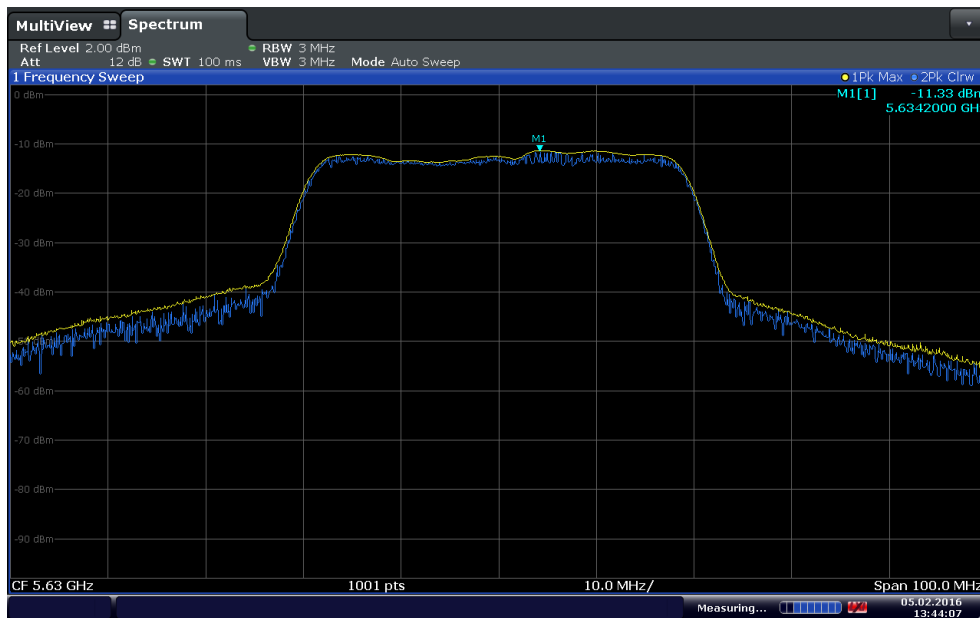

Date: 5.FEB.2016 13:44:07

**40 MHz BW 5630 MHz**



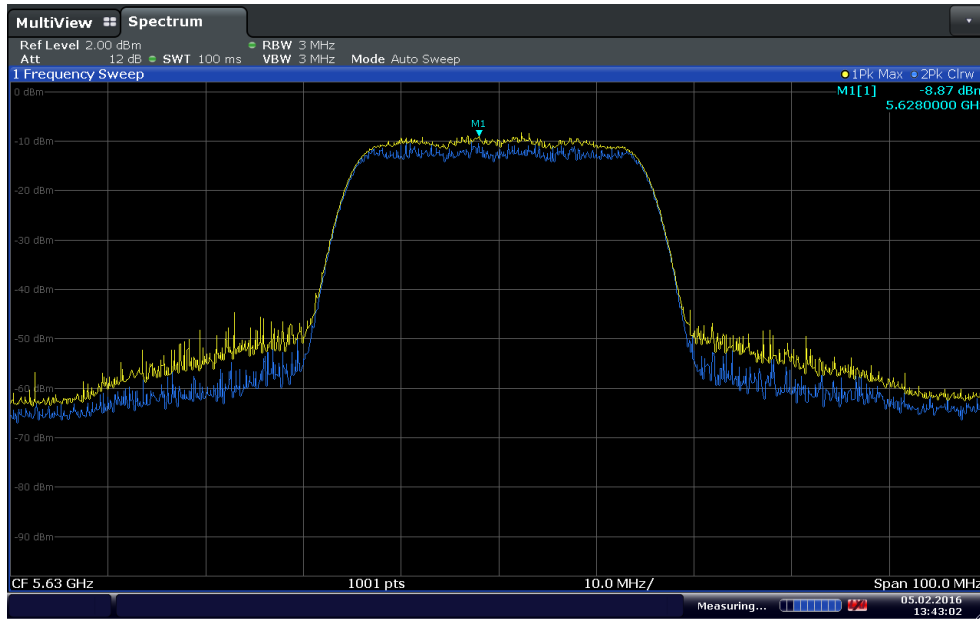

Date: 5.FEB.2016 13:43:02

30 MHz BW 5630 MHz

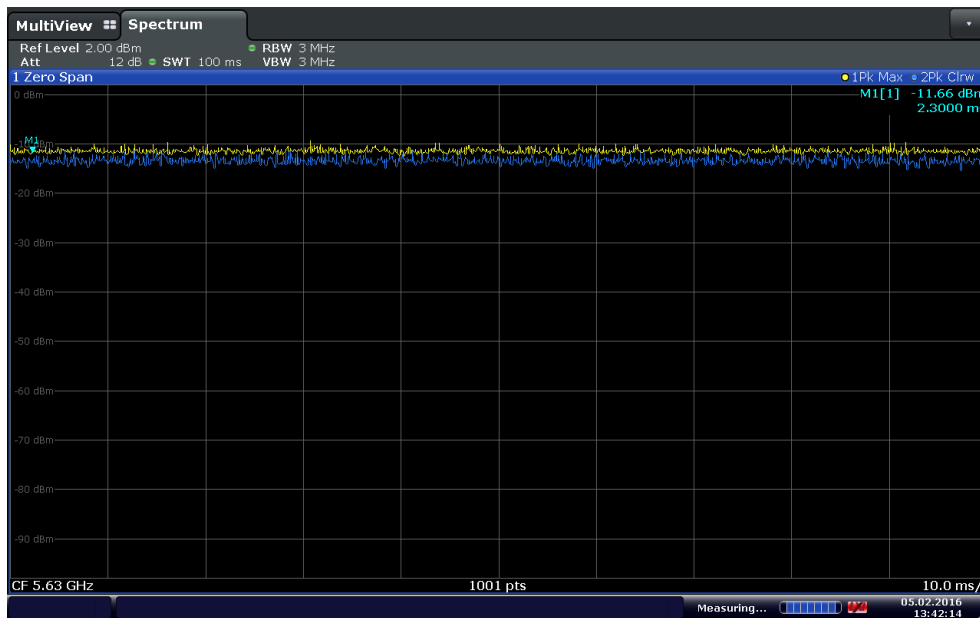

Date: 5.FEB.2016 13:42:14

30 MHz BW 5630 MHz showing 100% loading (Channel loading is the same between 30 MHz and 40MHz BW)

### 2.2.8 Test Setup Photo

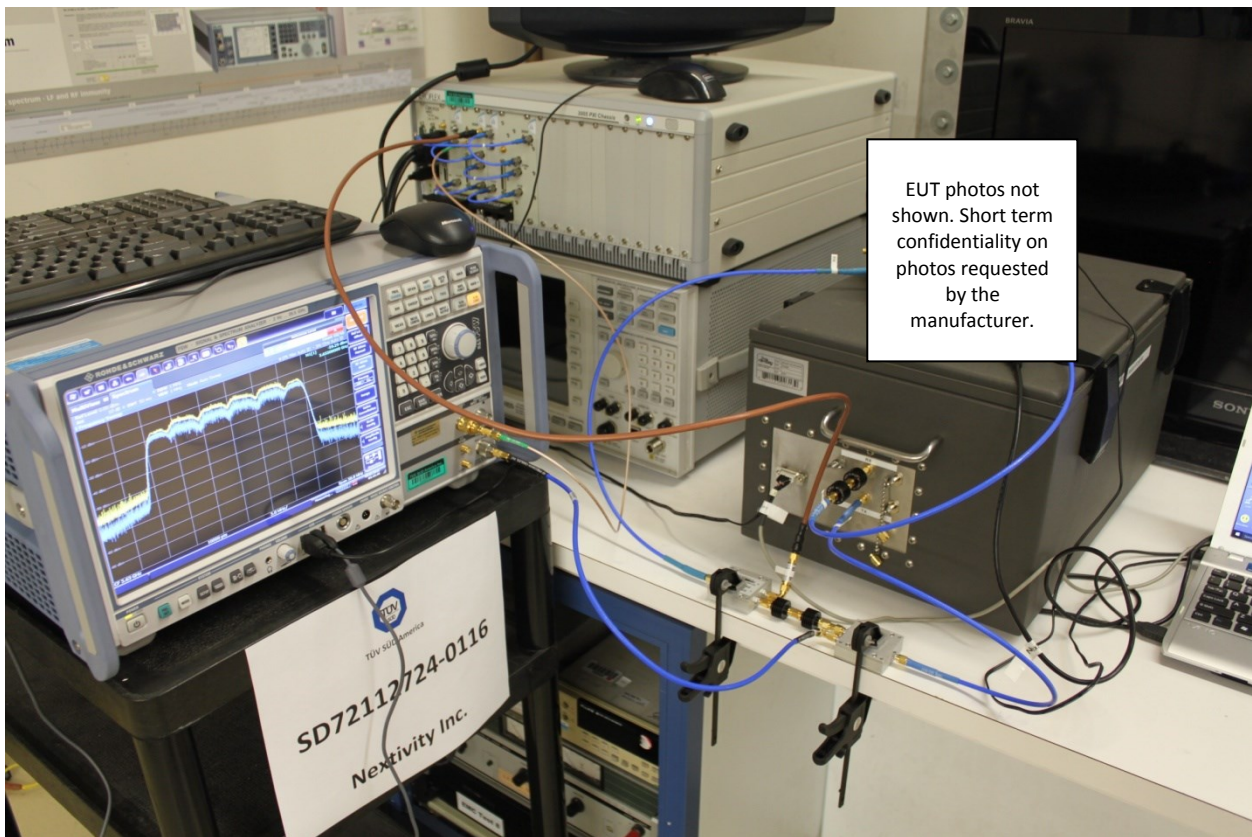
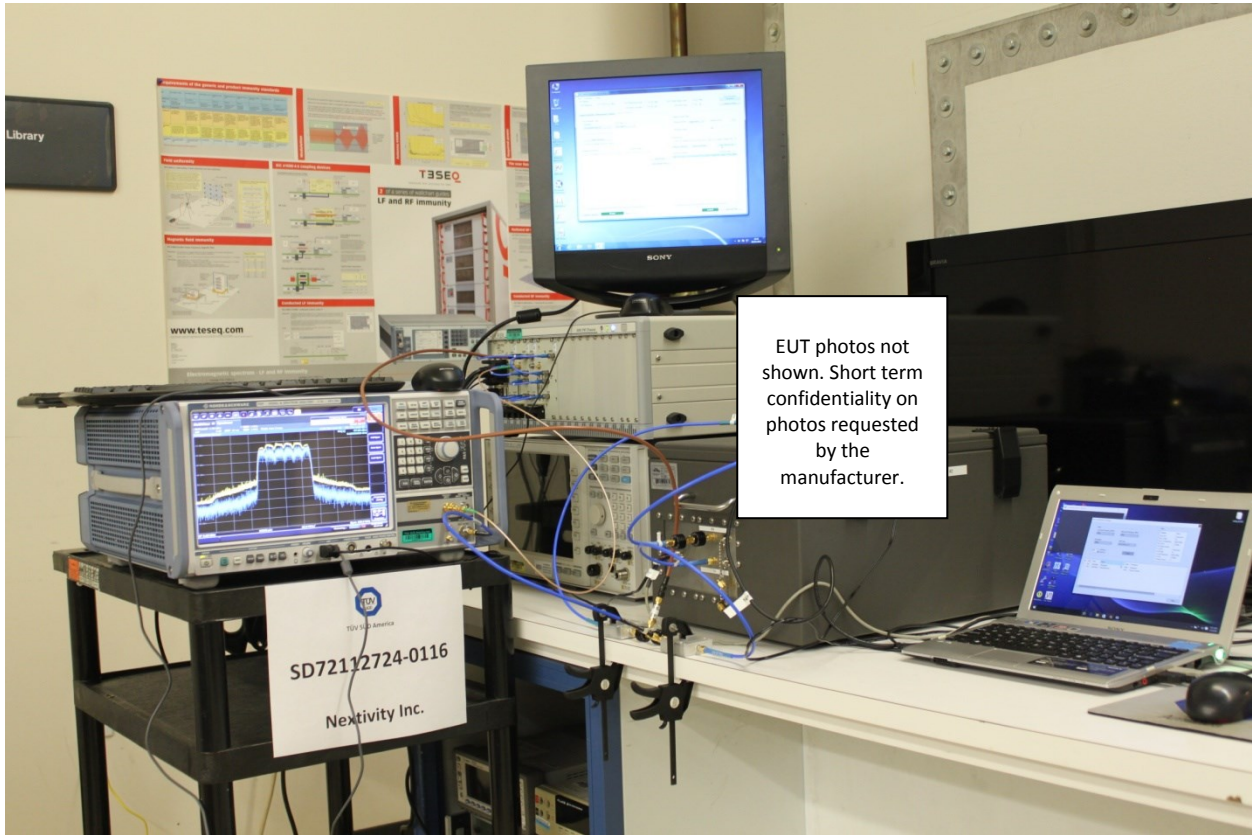



**2.3 U-NII DETECTION BANDWIDTH**

**2.3.1 Test Methodology**

Clause 7.8.1 of KDB905462 D02 UNII DFS Compliance Procedures New Rules v01r02

**2.3.2 Requirement**

U-NII Detection Bandwidth	Minimum 100% of the U-NII 99% transmission bandwidth
Minimum percentage of detection per trial	90%
BW modes to be tested	All supported

**2.3.3 Equipment Under Test and Modification State**

Serial No: 296546000608 (NU) and 297546000537 (CU) / Test Configuration A and B

**2.3.4 Environmental Conditions**

Test performed at TÜV SÜD America Inc. Rancho Bernardo facility

Ambient Temperature      25.2 °C  
 Relative Humidity          25.2 %  
 ATM Pressure                99.8 kPa

**2.3.5 Additional Observations**

- Once systems are synchronized, both NU and CU are Master Devices. Test Configuration A and B were used to verify U-NII detection bandwidth of both units.
- Frequencies verified were 5280 MHz for NU and 5630 MHz for CU.
- Both 30MHz and 40MHz BW modes were verified, however the detection bandwidth is identical for both modes.
- Fast and Freeze Up Mode was used for this test. This allows monitoring of Radar events while staying on the same channel. Radar events were observed using the DFS Conformance Testing application provided by the manufacturer.
- Radar Type 0 was used for this test with calibration level as per Section 2.1.8 of this test report.
- Test setup photos are identical with Section 2.2.8 of this test report.

**2.3.6 Test Results**

CU 30MHz BW (5280 MHz RX 5630MHz TX)											
Radar Frequency (MHz)	DFS Detection Trials (1 = Detection, 0 = No Detection)										Detection Rate in % (Limit is 90%)
	1	2	3	4	5	6	7	8	9	10	
5261 (F <sub>L</sub> )	1	1	1	1	1	1	1	1	1	1	100



5260	0	0	0	0	0	0	0	0	0	0	0
5265	1	1	1	1	1	1	1	1	1	1	100
5270	1	1	1	1	1	1	1	1	1	1	100
5275	1	1	1	1	1	1	1	1	1	1	100
5280	1	1	1	1	1	1	1	1	1	1	100
5285	1	1	1	1	1	1	1	1	1	1	100
5290	1	1	1	1	1	1	1	1	1	1	100
5295	1	1	1	1	1	1	1	1	1	1	100
5300	0	0	0	0	0	0	0	0	0	0	0
5299 (F <sub>H</sub> )	1	1	1	1	1	1	1	1	1	1	100
U-NII Detection Bandwidth = F <sub>H</sub> – F <sub>L</sub> = 5299MHz – 5261MHz = 38 MHz											
EUT 30MHz 99% Bandwidth = 29.09MHz (worst case from SD72112724-0116F FCC Part 15.407 Subpart E RSS247 Test Report)											
U-NII Detection Bandwidth Min. Limit (MHz): Minimum 100% of the U-NII 99% transmission power bandwidth. Since 29.09 MHz < 38 MHz, <b>EUT complies.</b>											

CU 40MHz BW (5280 MHz RX 5630MHz TX)											
Radar Frequency (MHz)	DFS Detection Trials (1 = Detection, 0 = No Detection)										Detection Rate in % (Limit is 90%)
	1	2	3	4	5	6	7	8	9	10	
5261 (F <sub>L</sub> )	1	1	1	1	1	1	1	1	1	1	100
5260	0	0	0	0	0	0	0	0	0	0	0
5265	1	1	1	1	1	1	1	1	1	1	100
5270	1	1	1	1	1	1	1	1	1	1	100
5275	1	1	1	1	1	1	1	1	1	1	100
5280	1	1	1	1	1	1	1	1	1	1	100
5285	1	1	1	1	1	1	1	1	1	1	100
5290	1	1	1	1	1	1	1	1	1	1	100
5295	1	1	1	1	1	1	1	1	1	1	100
5300	0	0	0	0	0	0	0	0	0	0	0
5299 (F <sub>H</sub> )	1	1	1	1	1	1	1	1	1	1	100
U-NII Detection Bandwidth = F <sub>H</sub> – F <sub>L</sub> = 5299MHz – 5261MHz = 38 MHz											
EUT 40MHz 99% Bandwidth = 36.47 MHz (worst case 99% EBW for U-NII-2A and 2C Band from SD72112724-0116F FCC Part 15.407 Subpart E RSS247 Test Report)											
U-NII Detection Bandwidth Min. Limit (MHz): Minimum 100% of the U-NII 99% transmission power bandwidth. Since 36.47 MHz < 38 MHz, <b>EUT complies.</b>											



NU 30MHz BW (5630 MHz RX 5280MHz TX)												
Radar Frequency (MHz)	DFS Detection Trials (1 = Detection, 0 = No Detection)										Detection Rate in % (Limit is 90%)	
	1	2	3	4	5	6	7	8	9	10		
5611 (F <sub>L</sub> )	1	1	1	1	1	1	1	1	1	1	1	100
5610	0	0	0	0	0	0	0	0	0	0	0	0
5615	1	1	1	1	1	1	1	1	1	1	1	100
5620	1	1	1	1	1	1	1	1	1	1	1	100
5625	1	1	1	1	1	1	1	1	1	1	1	100
5630	1	1	1	1	1	1	1	1	1	1	1	100
5635	1	1	1	1	1	1	1	1	1	1	1	100
5640	1	1	1	1	1	1	1	1	1	1	1	100
5645	1	1	1	1	1	1	1	1	1	1	1	100
5650	0	0	0	0	0	0	0	0	0	0	0	0
5649 (F <sub>H</sub> )	1	1	1	1	1	1	1	1	1	1	1	100
U-NII Detection Bandwidth = F <sub>H</sub> – F <sub>L</sub> = 5649MHz – 5611MHz = 38 MHz												
EUT 30MHz 99% Bandwidth = 29.09 MHz (worst case from SD72112724-0116F FCC Part 15.407 Subpart E RSS247 Test Report)												
U-NII Detection Bandwidth Min. Limit (MHz): Minimum 100% of the U-NII 99% transmission power bandwidth. Since 29.09 MHz < 38 MHz, <b>EUT complies.</b>												

NU 40MHz BW (5630 MHz RX 5280MHz TX)												
Radar Frequency (MHz)	DFS Detection Trials (1 = Detection, 0 = No Detection)										Detection Rate in % (Limit is 90%)	
	1	2	3	4	5	6	7	8	9	10		
5611 (F <sub>L</sub> )	1	1	1	1	1	1	1	1	1	1	1	100
5610	0	0	0	0	0	0	0	0	0	0	0	0
5615	1	1	1	1	1	1	1	1	1	1	1	100
5620	1	1	1	1	1	1	1	1	1	1	1	100
5625	1	1	1	1	1	1	1	1	1	1	1	100
5630	1	1	1	1	1	1	1	1	1	1	1	100
5635	1	1	1	1	1	1	1	1	1	1	1	100
5640	1	1	1	1	1	1	1	1	1	1	1	100
5645	1	1	1	1	1	1	1	1	1	1	1	100



5650	0	0	0	0	0	0	0	0	0	0	0
5649 (F <sub>H</sub> )	1	1	1	1	1	1	1	1	1	1	100
U-NII Detection Bandwidth = F <sub>H</sub> – F <sub>L</sub> = 5649MHz – 5611MHz = 38 MHz											
EUT 40MHz 99% Bandwidth = 36.47 MHz (worst case 99% EBW for U-NII-2A and 2C Band from SD72112724-0116F FCC Part 15.407 Subpart E RSS247 Test Report)											
U-NII Detection Bandwidth Min. Limit (MHz): Minimum 100% of the U-NII 99% transmission power bandwidth. Since 36.47 MHz < 38 MHz, <b>EUT complies.</b>											

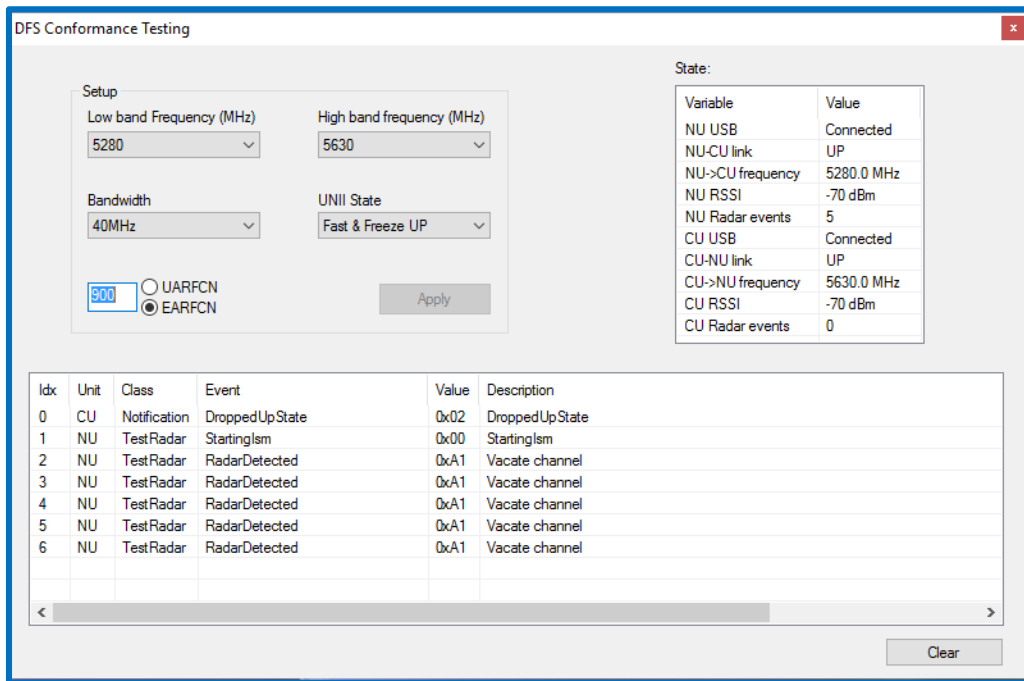

Sample window of DFS Conformance Testing application showing detected Radar events on NU (5280 MHz)



## **2.4 INITIAL CHANNEL AVAILABILITY CHECK TIME**

### **2.4.1 Specification Reference**

Part 15 Subpart E §15.407(h)(2)(ii)

### **2.4.2 Standard Applicable**

(ii) Channel Availability Check Time. A U-NII device shall check if there is a radar system already operating on the channel before it can initiate a transmission on a channel and when it has to move to a new channel. The U-NII device may start using the channel if no radar signal with a power level greater than the interference threshold values listed in paragraph (h)(2) of this section, is detected within 60 seconds.

### **2.4.3 Test Methodology**

Clause 7.8.2.1 of 905462 D02 UNII DFS Compliance Procedures New Rules v01r02

### **2.4.4 Equipment Under Test and Modification State**

Serial No: 296546000608 (NU) and 297546000537 (CU) / Test Configuration E and F

### **2.4.5 Date of Test/Initial of test personnel who performed the test**

February 15, 2016 / FSC

### **2.4.6 Test Equipment Used**

The major items of test equipment used for the above tests are identified in Section 3.1.

### **2.4.7 Environmental Conditions**

Test performed at TÜV SÜD America Inc. Rancho Bernardo facility

Ambient Temperature	25.2 °C
Relative Humidity	24.4 %
ATM Pressure	99.1 kPa

### **2.4.8 Additional Observations**

- 5280 MHz (NU) and 5540 MHz (CU) verified.
- EUT in Auto Channel Select Mode. This allows normal CAC and normal operation while using DFS test mode.
- RBW and VBW set to 3MHz while sweep time was set to 150 seconds.
- In DFS test mode, the EUT normally retains the last setting. In order to accurately measure the initial channel availability time, the EUT was initially set to Fast Up mode on a channel adjacent to 5280 MHz and 5540 MHz. Once Auto Channel Select mode is initiated on these wanted frequencies, normal CAC should commence with noticeable dip on the spectrum. This is the start of CAC and will be marked as M1.
- D1 on the test plots is the time the EUT started transmitting on the channel. The delta between M1 and D1 should be greater than 60 seconds.



### 2.4.9 Test Results Plots

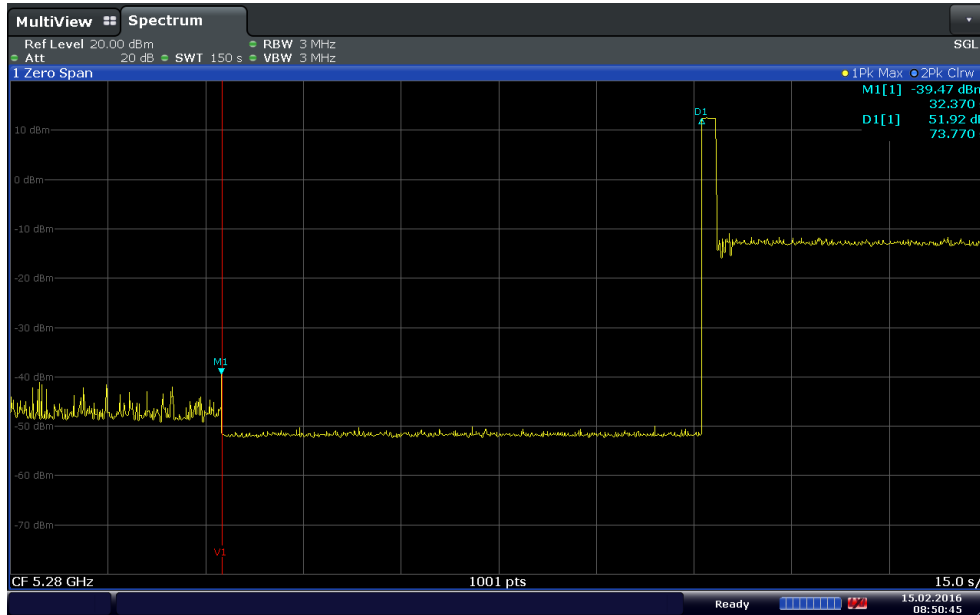

Date: 15.FEB.2016 08:50:46

Initial Channel Availability Check Time of 73.77 seconds for Low Band. EUT complies.

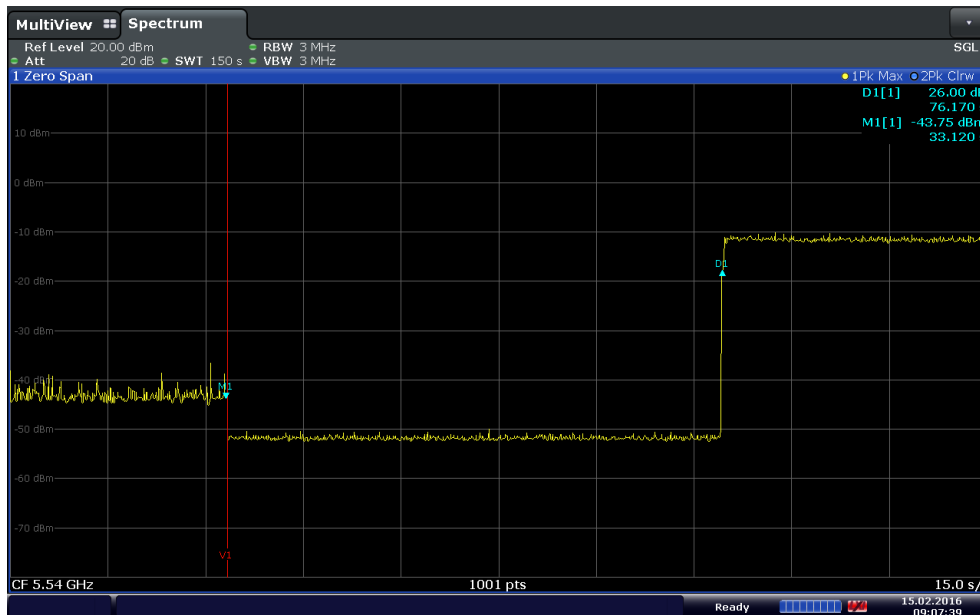

Date: 15.FEB.2016 09:07:39

Initial Channel Availability Check Time of 76.17 seconds for High Band. EUT complies.



### 2.4.10 Test Setup Photo

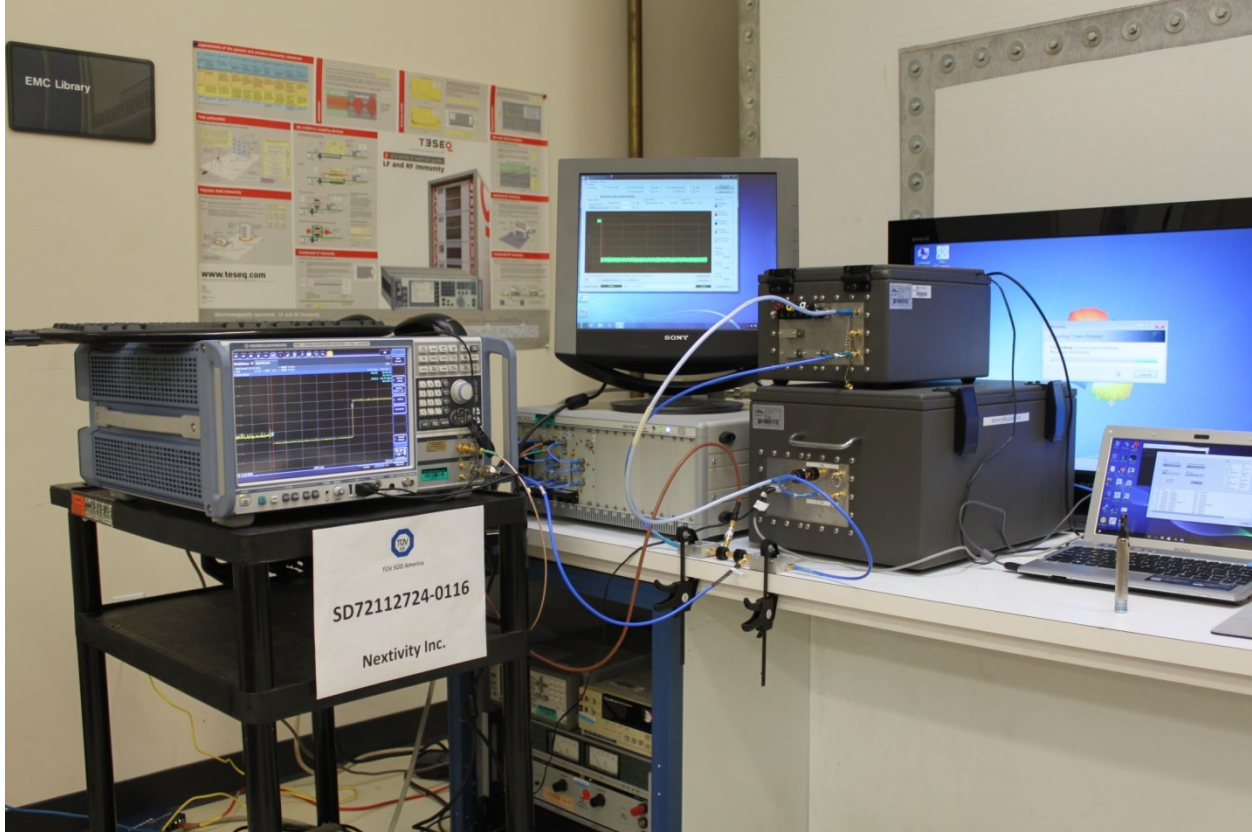



## **2.5 RADAR BURST AT THE BEGINNING OF THE CHANNEL AVAILABILITY CHECK TIME**

### **2.5.1 Specification Reference**

Part 15 Subpart E §15.407(h)(2)(ii)

### **2.5.2 Standard Applicable**

(ii) Channel Availability Check Time. A U-NII device shall check if there is a radar system already operating on the channel before it can initiate a transmission on a channel and when it has to move to a new channel. The U-NII device may start using the channel if no radar signal with a power level greater than the interference threshold values listed in paragraph (h)(2) of this section, is detected within 60 seconds.

### **2.5.3 Test Methodology**

Clause 7.8.2.2 of 905462 D02 UNII DFS Compliance Procedures New Rules v01r02

### **2.5.4 Equipment Under Test and Modification State**

Serial No: 296546000608 (NU) and 297546000537 (CU) / Test Configuration G

### **2.5.5 Date of Test/Initial of test personnel who performed the test**

February 15, 2016 / FSC

### **2.5.6 Test Equipment Used**

The major items of test equipment used for the above tests are identified in Section 3.1.

### **2.5.7 Environmental Conditions**

Test performed at TÜV SÜD America Inc. Rancho Bernardo facility

Ambient Temperature	25.2 °C
Relative Humidity	24.4 %
ATM Pressure	99.1 kPa

### **2.5.8 Additional Observations**

- Test mode allows injection of Low Band (LB) Radar signal to the TX RF port of NU during normal CAC (Test Configuration Diagram C Section 1.4.2 of this test report).
- NU is the Master for both LB and HB before CU comes on-line. NU will do HB ISM and detect all Radars.
- A Type 0 Radar was injected in the TX port of NU at the beginning of CAC time (within a 6 seconds window).
- V1 on the test plots indicates when Auto Channel Select Mode was activated.
- V2 and M1 correspond to when CAC started and the Radar burst injected ("State" window on DFS Conformance Testing application started to populate with information, from blank screen).
- No activity was observed on the original channel. The EUT was still doing CAC on the new channel (where it moved) when the 2.5 minutes sweep time expired.



2.5.9 Test Results Plots

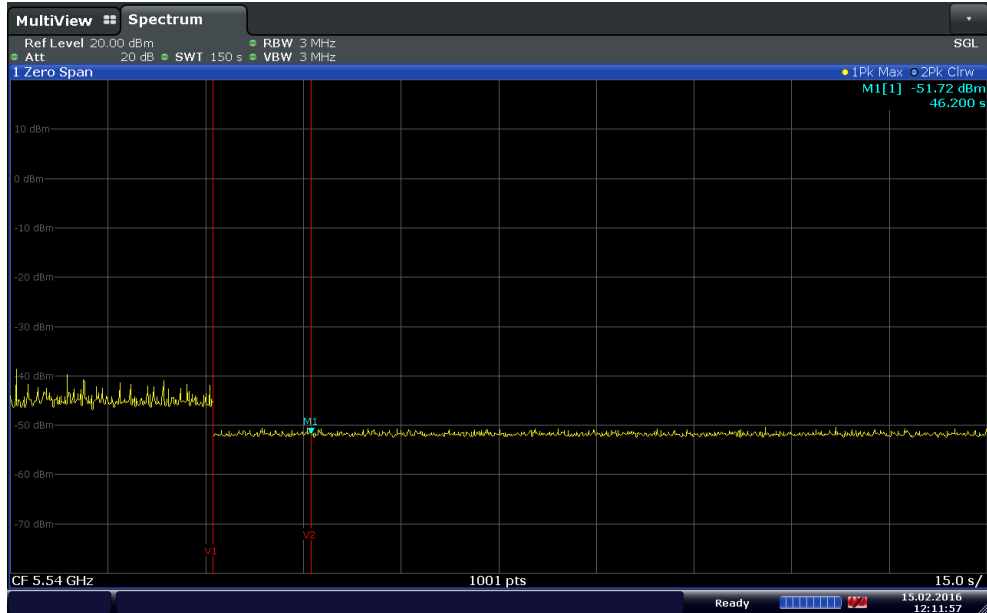

Date: 15.FEB.2016 12:11:57

Plot showing channel activity at CU TX port while a Low Band Radar burst was injected at NU TX port at the beginning of CAC time

DFS Conformance Testing

Setup

Low band Frequency (MHz): 5280

High band frequency (MHz): 5540

Bandwidth: 30MHz

UNII State: Auto Channel Select

900  UARFCN  EARFCN

Apply

State:

Variable	Value
NU USB	Connected
NU-CU link	Scanning
NU->CU frequency	5240.0 MHz
NU RSSI	-95 dBm
NU Radar events	1
CU USB	Connected
CU-NU link	Scanning
CU->NU frequency	5660.0 MHz
CU RSSI	-90 dBm
CU Radar events	0

Idx	Unit	Class	Event	Value	Description
0	NU	TestRadar	StartingISM	0x00	StartingISM
1	NU	TestRadar	RadarDetected	0xB1	Vacate channel

Clear

Configuration window showing original channels and Radar detection during CAC time

### 2.5.10 Test Setup Photo

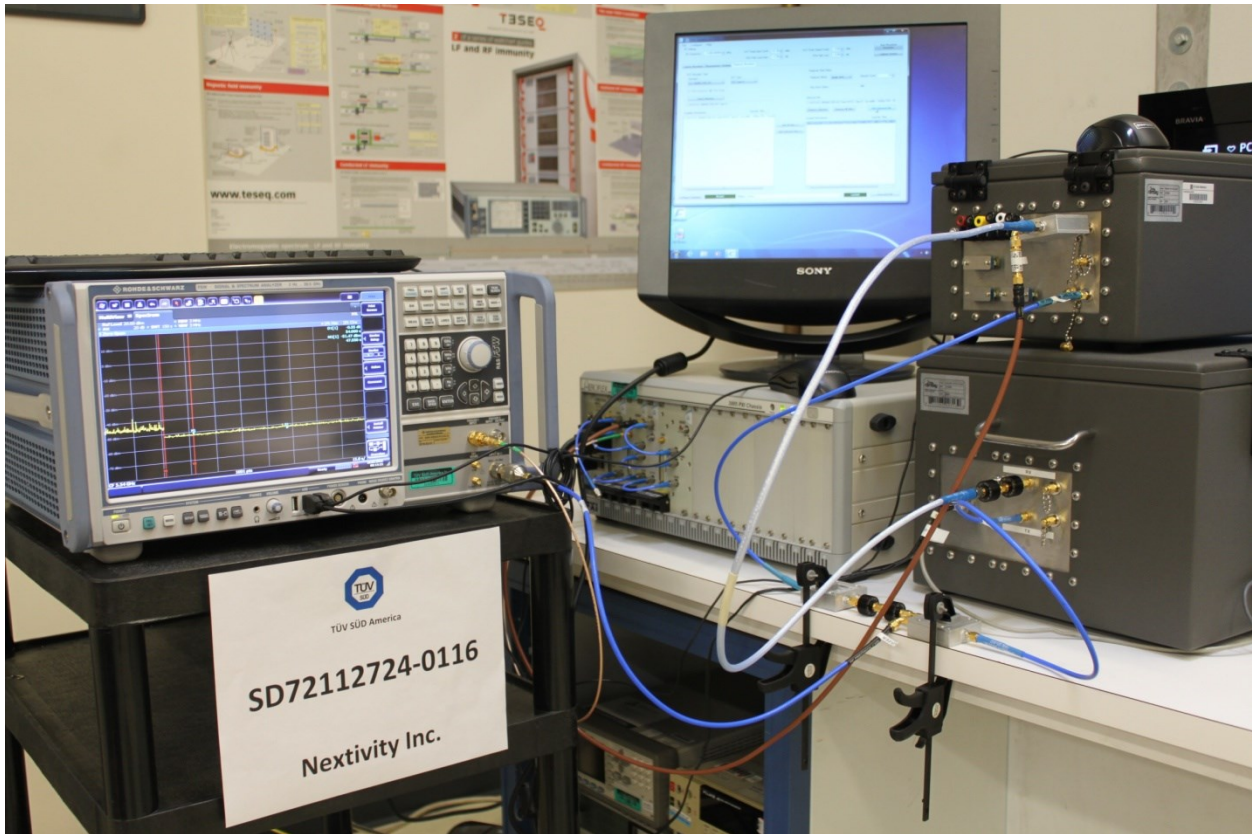



## **2.6 RADAR BURST AT THE END OF THE CHANNEL AVAILABILITY CHECK TIME**

### **2.6.1 Specification Reference**

Part 15 Subpart E §15.407(h)(2)(ii)

### **2.6.2 Standard Applicable**

(ii) Channel Availability Check Time. A U-NII device shall check if there is a radar system already operating on the channel before it can initiate a transmission on a channel and when it has to move to a new channel. The U-NII device may start using the channel if no radar signal with a power level greater than the interference threshold values listed in paragraph (h)(2) of this section, is detected within 60 seconds.

### **2.6.3 Test Methodology**

Clause 7.8.2.3 of 905462 D02 UNII DFS Compliance Procedures New Rules v01r02

### **2.6.4 Equipment Under Test and Modification State**

Serial No: 296546000608 (NU) and 297546000537 (CU) / Test Configuration G

### **2.6.5 Date of Test/Initial of test personnel who performed the test**

February 16, 2016 / FSC

### **2.6.6 Test Equipment Used**

The major items of test equipment used for the above tests are identified in Section 3.1.

### **2.6.7 Environmental Conditions**

Test performed at TÜV SÜD America Inc. Rancho Bernardo facility

Ambient Temperature	26.0 °C
Relative Humidity	25.6 %
ATM Pressure	98.9 kPa

### **2.6.8 Additional Observations**

- Identical configuration as Section 2.5 of this test report. The difference is that a Type 0 Radar was injected at the end of CAC time (54 seconds after the start of CAC).
- V1 on the test plots indicates when Auto Channel Select Mode was activated.
- V2 and M1 correspond to when CAC started ("State" window on DFS Conformance Testing application started to populate with information, from blank screen).
- D1 corresponds to the time when Radar burst was injected (54 seconds after V2 and M1).
- No activity was recorded since the EUT was still performing CAC on the channel it moved to when the 2.5 minutes sweep time expired.
- Test setup photo is identical with Section 2.5.10 of this test report.



**2.6.9 Test Results Plots**

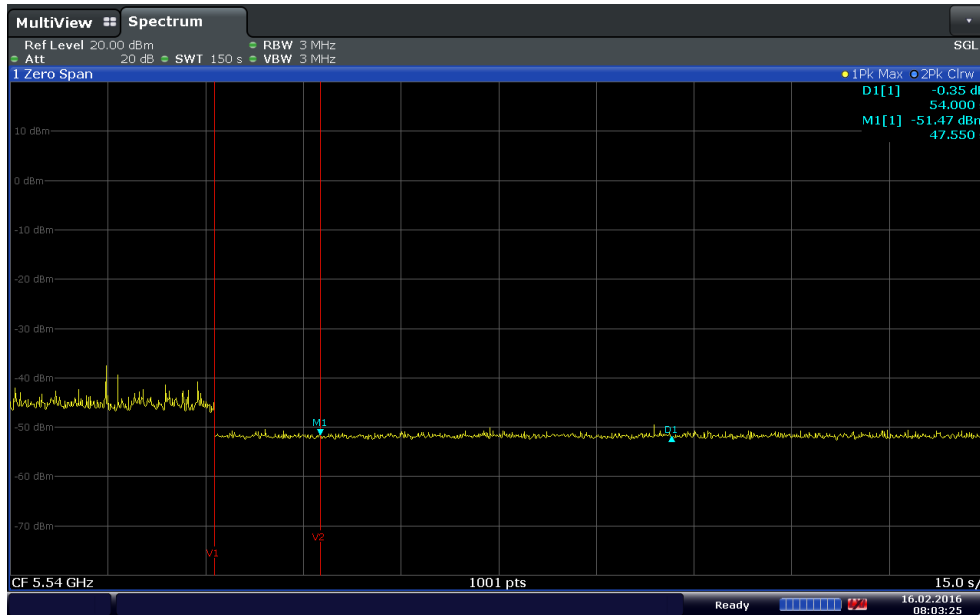

Date: 16.FEB.2016 08:03:25

**Plot showing channel activity at CU TX port while a Low Band Radar burst was injected at NU TX port at the end of CAC time**

DFS Conformance Testing

**Setup**

Low band Frequency (MHz): 5280  
 High band frequency (MHz): 5540  
 Bandwidth: 30MHz  
 UNII State: Auto Channel Select  
 900  UARFCN  EARFCN

Apply

**State:**

Variable	Value
NU USB	Connected
NU-CU link	Scanning
NU->CU frequency	5240.0 MHz
NU RSSI	-92 dBm
NU Radar events	1
CU USB	Connected
CU->NU link	Scanning
CU->NU frequency	5825.0 MHz
CU RSSI	-89 dBm
CU Radar events	0

Idx	Unit	Class	Event	Value	Description
0	NU	TestRadar	RadarDetected	0xB1	Vacate channel

Clear

**Configuration window showing original channels and Radar detection during CAC time**



**2.7 IN-SERVICE MONITORING FOR CHANNEL MOVE TIME AND CHANNEL CLOSING TRANSMISSION TIME**

**2.7.1 Specification Reference**

Part 15 Subpart E §15.407(h)(2)(iii)

**2.7.2 Standard Applicable**

(iii) Channel Move Time. After a radar's presence is detected, all transmissions shall cease on the operating channel within 10 seconds. Transmissions during this period shall consist of normal traffic for a maximum of 200 ms after detection of the radar signal. In addition, intermittent management and control signals can be sent during the remaining time to facilitate vacating the operating channel.

**2.7.3 Limits**

Channel Closing Transmission Time	200 ms
Channel Move Time	within 10 seconds

**2.7.4 Test Methodology**

Clause 7.8.3 of 905462 D02 UNII DFS Compliance Procedures New Rules v01r02

**2.7.5 Equipment Under Test and Modification State**

Serial No: 296546000608 (NU) and 297546000537 (CU) / Test Configuration C and D

**2.7.6 Date of Test/Initial of test personnel who performed the test**

February 09, 2016 / FSC

**2.7.7 Test Equipment Used**

The major items of test equipment used for the above tests are identified in Section 3.1.

**2.7.8 Environmental Conditions**

Test performed at TÜV SÜD America Inc. Rancho Bernardo facility

Ambient Temperature	27.9 °C
Relative Humidity	21.4 %
ATM Pressure	99.4 kPa

**2.7.9 Additional Observations**

- Test procedure is per Section 7.8.3 of KDB905462 D02 UNII DFS Compliance Procedures New Rules v01r02.
- All requirements from Section 2.1 (Radar Type 0 calibration) and Section 2.2 (Channel Loading) of this test report were met.



- Using Test Configuration C, the NU will be the Master and CU is the Slave device. Test Configuration D on the other hand will be the opposite wherein the CU is the Master while NU is the Slave.
- Using the Aeroflex DFS test system signal generator, a radar type 0 test signal was injected into the configured Master device antenna port on the operating channel. The Aeroflex DFS test system signal analyser measurement sweep was triggered upon the radar injection to the configured Master device and the resultant data from the Master device and Slave device was collected (response to radar burst injection).
- A level detection threshold was set on the Aeroflex DFS test system signal analyzer, such that all signals from the EUT were assessed using the Aeroflex DFS test system and both the channel closing transmission time and channel move time were measured and recorded.
- The markers on the captured trace data correspond to the following time periods:
  - Red** - End of the injected radar burst: Time T1
  - Purple** - End of the Channel Closing Transmission Time: Time T1 + 200 ms
  - Yellow** - End of the Channel Move Time: T1 + 10 seconds
- Only the widest BW mode (40MHz) tested.
- Since >60dB of attenuation needs to be in between the two units, the injected Radar and the channel activity can't be shown on the same plot (separate injection and measurement points).

**2.7.10 Test Results**

<b>NU as the Master (40MHz BW @ 5280MHz) Complies</b>	
Channel Move Time	17.732 ms
Channel Closing Time (Aggregate Time During 200ms)	No activity from end of radar burst to 200ms
Channel Closing Time (Aggregate Time +200ms to 10s)	No activity from 200ms to 10s
Channel Closing Time (Aggregate Time During 10s)	Not applicable since no activity from end of radar burst to 10s
<b>CU as the Master (40MHz BW @ 5630 MHz) Complies</b>	
Channel Move Time	180.736 ms
Channel Closing Time (Aggregate Time During 200ms)	155.030 ms
Channel Closing Time (Aggregate Time +200ms to 10s)	No activity from 200ms to 10s
Channel Closing Time (Aggregate Time During 10s)	155.030 ms





### 2.7.11 Test Results Plots



5280 MHz Overall Power vs Time Display, showing 10 seconds observation time

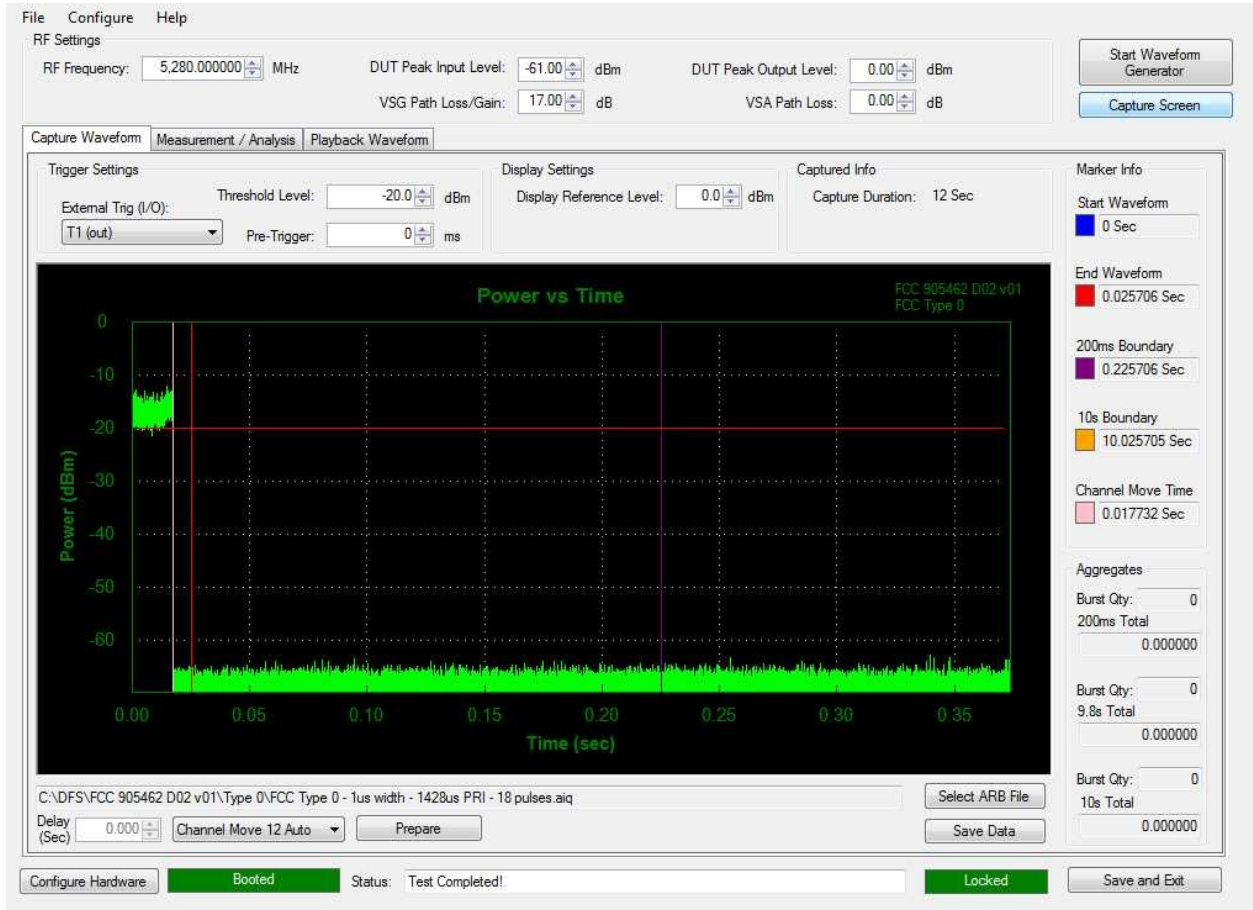

5280 MHz Zoomed In Overall Power vs Time Display, showing Channel Move Time (Pink), end of Radar Burst (Red) and the 200 ms boundary (Purple)



5630 MHz Overall Power vs Time Display, showing 10 seconds observation time

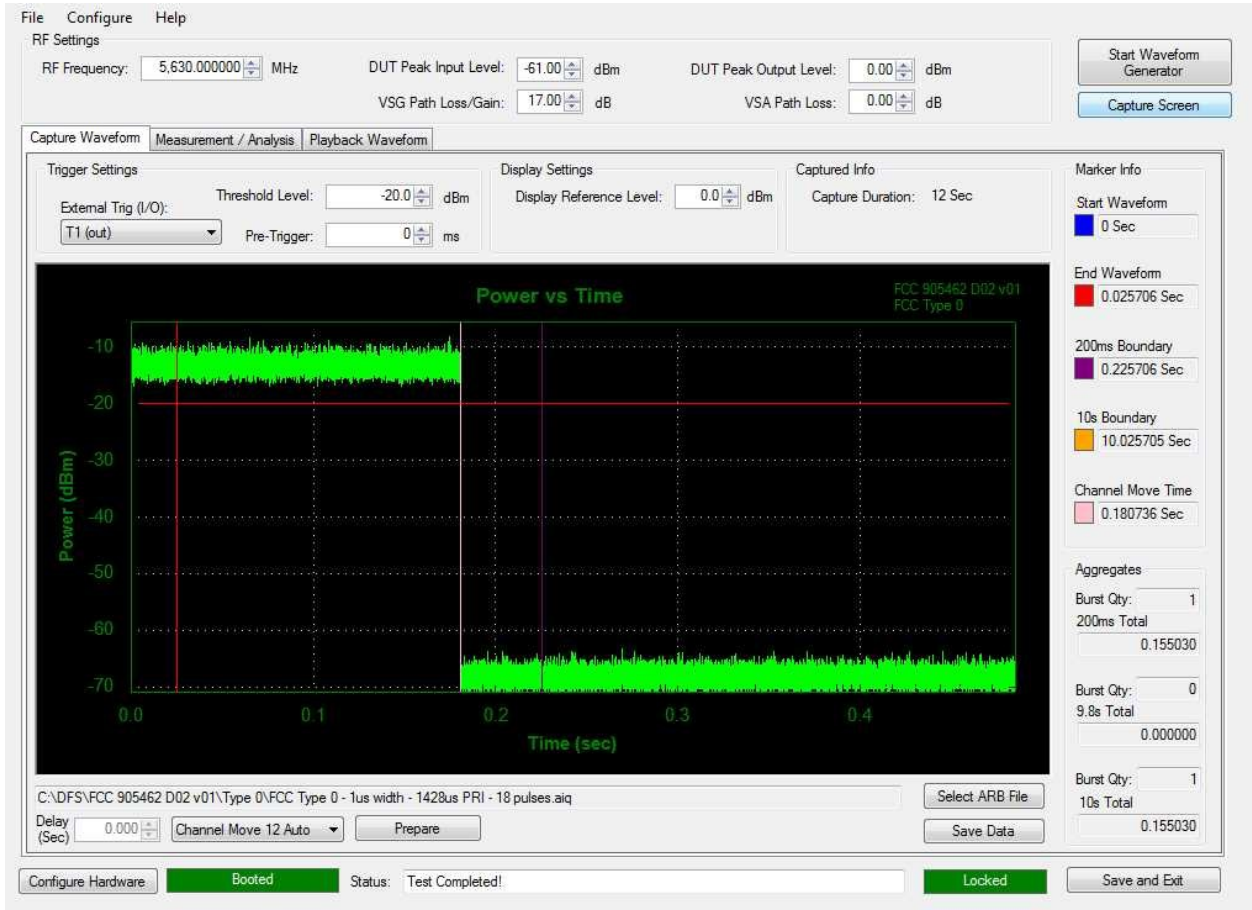

5630 MHz Zoomed In Overall Power vs Time Display, showing Channel Move Time (Pink), end of Radar Burst (Red) and the 200 ms boundary (Purple)



## 2.8 NON-OCCUPANCY PERIOD

### 2.8.1 Specification Reference

Part 15 Subpart E §15.407(h)(2)(iv)

### 2.8.2 Standard Applicable

(iv) Non-occupancy Period. A channel that has been flagged as containing a radar system, either by a channel availability check or in-service monitoring, is subject to a non-occupancy period of at least 30 minutes. The non-occupancy period starts at the time when the radar system is detected.

### 2.8.3 Test Methodology

Clause 7.8.3 of 905462 D02 UNII DFS Compliance Procedures New Rules v01r02

### 2.8.4 Equipment Under Test and Modification State

Serial No: 296546000608 (NU) and 297546000537 (CU) / Test Configuration A and B

### 2.8.5 Date of Test/Initial of test personnel who performed the test

February 05 and 08, 2016 / FSC

### 2.8.6 Test Equipment Used

The major items of test equipment used for the above tests are identified in Section 3.1.

### 2.8.7 Environmental Conditions

Test performed at TÜV SÜD America Inc. Rancho Bernardo facility

Ambient Temperature	22.0 – 25.4 °C
Relative Humidity	16.0 -18.0 %
ATM Pressure	99.5 - 100.1 kPa

### 2.8.8 Additional Observations

- Both High Band (CU @ 5630 MHz) and Low Band (NU @ 5280 MHz) frequencies verified.
- Only 40MHz BW verified.
- The spectrum analyzer was triggered at  $T_1$  (end of injected radar burst) instead of  $T_2$  (end of channel move time). Since channel move time is <10 seconds, the difference in results between the two trigger points is negligible with a sweep time of 32 minutes.
- Trigger offset was set to -60 seconds in order to show initial data traffic on the original channel.
- Noise floor to signal ratio plots were provided as per Clause 8.3 (4) (iii) of KDB905462 D02 UNII DFS Compliance Procedures New Rules v01r02.
- There was no activity observed on the original channel during the 30 minutes observation period after the channel was vacated due to the injected radar burst (Type 0). **EUT complies.**
- Test setup photo is identical to Section 2.3.7 of this test report.



### 2.8.9 Test Results Plots

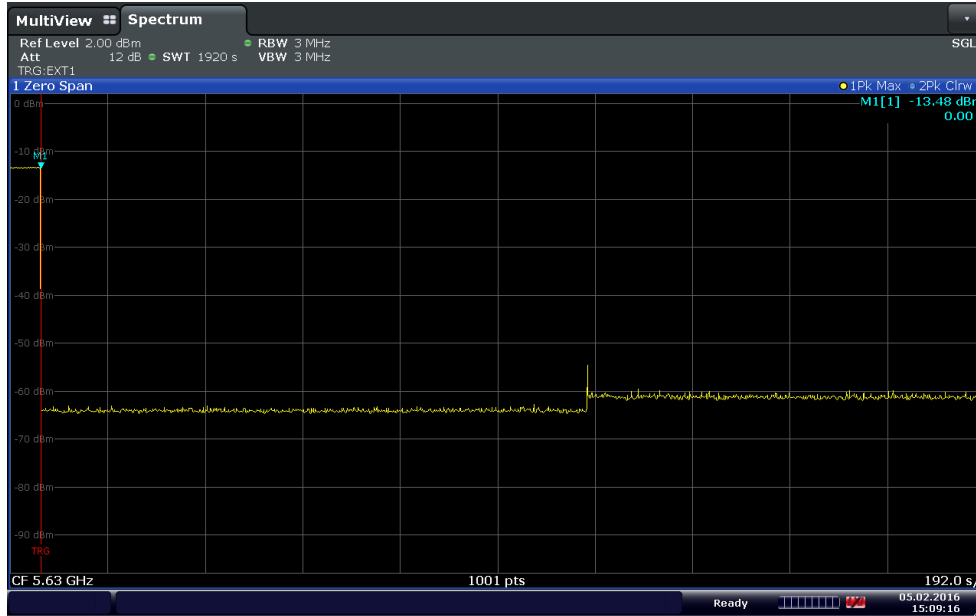

Date: 5.FEB.2016 15:09:17

High Band (CU) 32 minutes sweep showing no activity on the original channel after it was vacated when Radar was detected

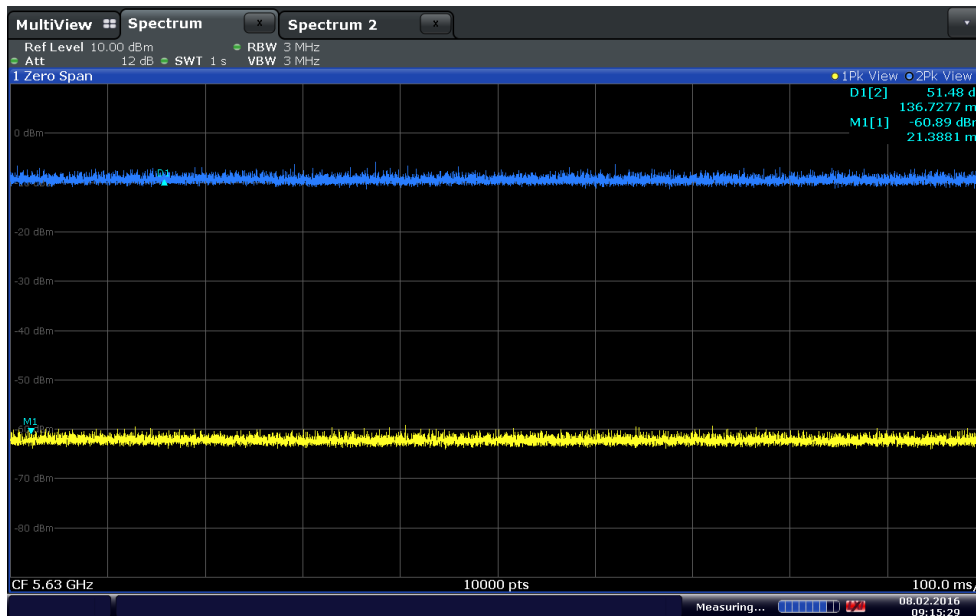

Date: 8.FEB.2016 09:15:29

Noise Floor to Signal Ratio during verification (5630 MHz)

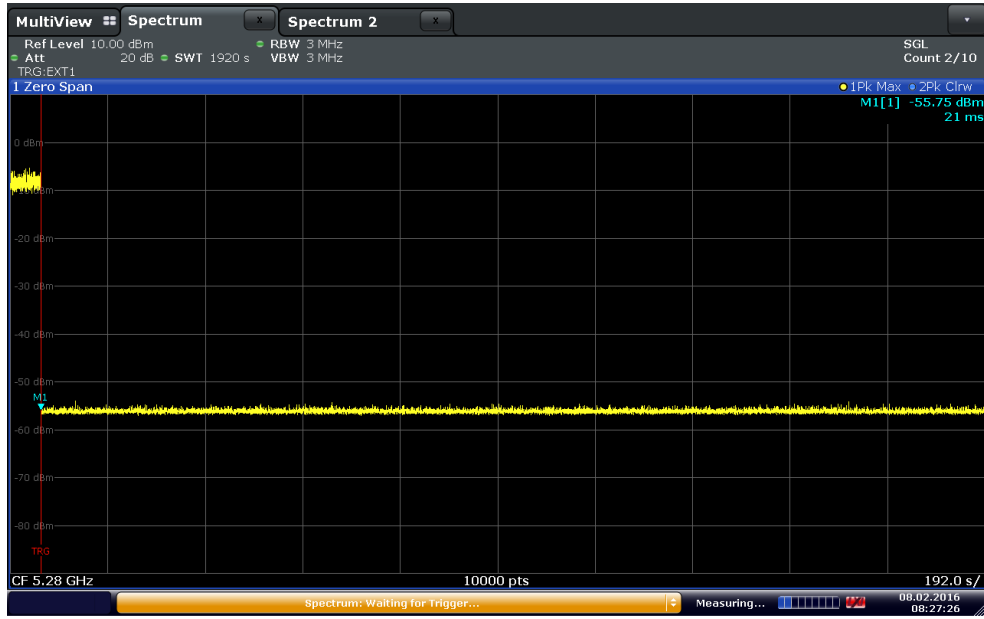

Date: 8.FEB.2016 08:27:27

**Low Band (NU) 32 minutes sweep showing no activity on the original channel after it was vacated when Radar was detected**

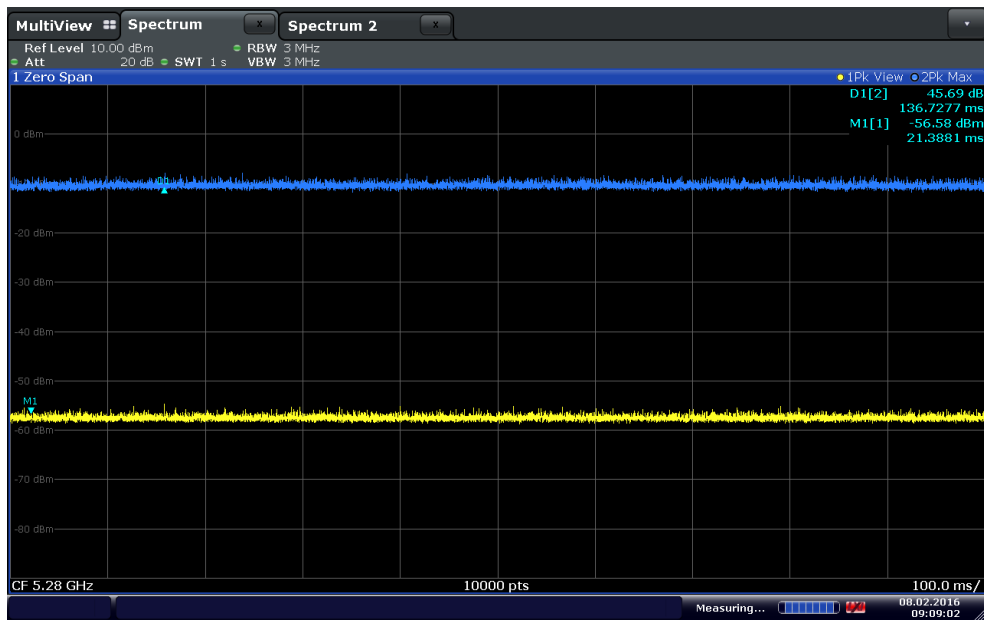

Date: 8.FEB.2016 09:09:03

**Noise Floor to Signal Ratio during verification (5280 MHz)**



**2.9 STATISTICAL PERFORMANCE CHECK**

**2.9.1 Standard Applicable**

To determine the minimum percentage of successful detection requirements found in Tables 5-7 of KDB905462 D02 UNII DFS Compliance Procedures New Rules v01r02 when a radar burst with a level equal to the DFS Detection Threshold + 1dB is generated on the Operating Channel of the U-NII device (In- Service Monitoring).

**2.9.2 Test Methodology**

Clause 7.8.4 of 905462 D02 UNII DFS Compliance Procedures New Rules v01r02

**2.9.3 Limits**

Radar Type	Number of Trials	Number of Successful Detections	Minimum Percentage of Successful Detection
1	35	29	82.9%
2	30	18	60.0%
3	30	27	90.0%
4	50	44	88.0%
5	30	24	80.0%
6	30	21	70.0%

**2.9.4 Equipment Under Test and Modification State**

Serial No: 296546000608 (NU) and 297546000537 (CU) / Test Configuration B

**2.9.5 Date of Test/Initial of test personnel who performed the test**

February 22, 2016 / FSC

**2.9.6 Test Equipment Used**

The major items of test equipment used for the above tests are identified in Section 3.1.

**2.9.7 Environmental Conditions**

Test performed at TÜV SÜD America Inc. Rancho Bernardo facility

Ambient Temperature      23.1 °C  
 Relative Humidity          38.8 %  
 ATM Pressure                99.1 kPa

**2.9.8 Additional Observations**

- Verification performed on 5280 MHz since the requirement is one frequency from the operating channels on either Low Band or High Band.





- Test Configuration B used. Radar was injected to the RX port of CU (5280 MHz) while in Fast and Freeze Up mode.
- Radar detection was monitored on the DFS Conformance Testing application window:

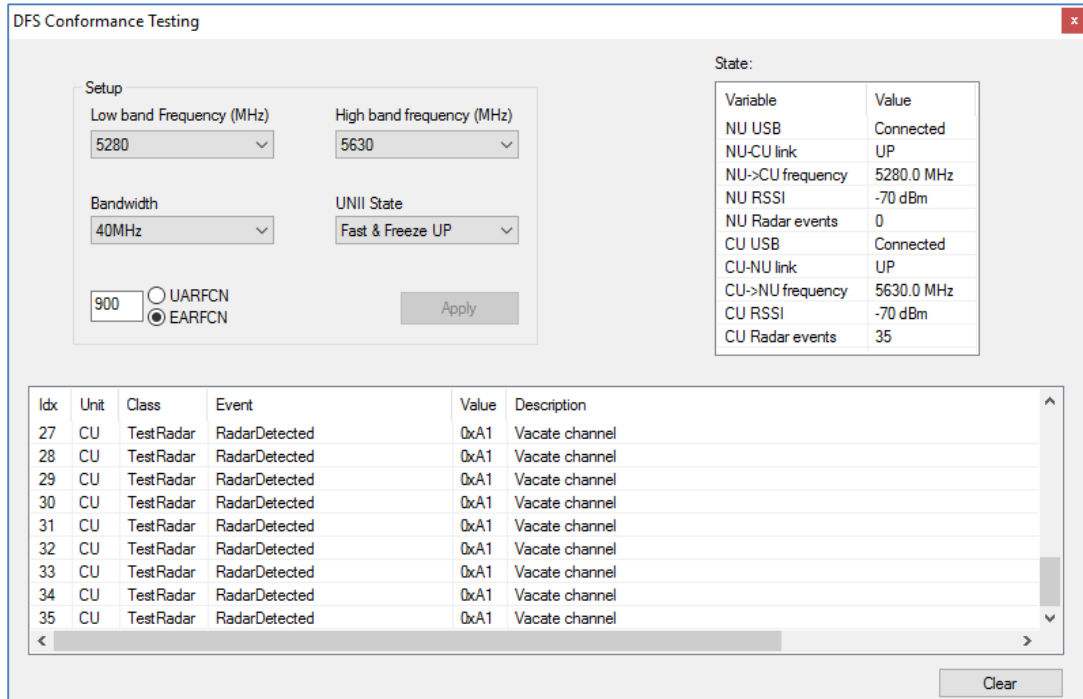

- Only 40MHz BW presented since Radar Detection Bandwidth of the EUT is identical for both 30MHz and 40MHz (Radar Detection Bandwidth is 38MHz for both 30MHz and 40MHz BW setting). Radar detection for 30MHz BW setting with detection BW of 38 MHz was 100%.
- See Section 1.5 of this test report for more details regarding Bin 5 Radar Chirp testing.
- Test setup photo is identical to Section 2.3.7 of this test report.

**2.9.9 Summary of Test Results**

Radar Type	Number of Trials	Number of Successful Detection	Percentage of Successful Detection
1	35	35	100%
2	30	30	100%
3	30	29	96.7%
4	50	50	100%
Limit for Aggregate = 80 %			
Aggregate (100% + 100% + 96.7% + 100%) / 4 = 99.175% (EUT Complies)			



Radar Type	Number of Trials	Number of Successful Detection	Percentage of Successful Detection	Minimum Percentage of Successful Detection	Compliance
5	30	24	80%	80%	Complies
6	30	30	100%	70%	Complies

**2.9.10 Radar Parameters**

Radar Type 1			
Trial#	Pulse Repetition Frequency Number (1 to 23 for Test A)	Pulse Repetition Frequency (Pulse per Second)	Pulse Repetition Interval (Microseconds)
1	15	1253	798
2	17	1193	838
3	22	1066	938
4	3	1792	558
5	13	1319	758
6	8	1520	658
7	18	1166	858
8	5	1672	598
9	9	1475	678
10	20	1114	898
11	7	1567	638
12	10	1433	698
13	2	1859	538
14	11	1393	718
15	4	1730	578
16	Test B	366	2734
17		432	2313
18		1919	521
19		608	1646
20		616	1623
21		337	2967
22		1789	559
23		342	2920
24		338	2960
25		485	2062
26		1062	942
27		714	1401
28		642	1558



29		384	2602
30		353	2834
31		1253	798
32		1193	838
33		1066	938
34		1792	558
35		1319	758

Radar Type 2			
Trial#	Number of Pulses per Burst	Pulse Width (μs)	PRI (μs)
1	24	3.8	190
2	24	3.8	154
3	23	3.5	165
4	28	1.6	206
5	27	3.5	208
6	27	4.3	181
7	29	4.9	161
8	26	3.5	170
9	25	1.5	194
10	24	4.3	196
11	26	2.9	227
12	23	2.9	153
13	25	1.1	178
14	26	1	169
15	28	4.7	172
16	24	1.4	181
17	28	2.1	214
18	27	3.9	185
19	24	4.9	156
20	26	4.2	195
21	27	4	216
22	28	4.7	204
23	27	2.6	162
24	23	3.5	212
25	29	1.9	227
26	29	2.7	208
27	24	4.1	151
28	28	1.7	193
29	26	2.6	211
30	29	4.1	192



Radar Type 3			
Trial#	Number of Pulses per Burst	Pulse Width (μs)	PRI (μs)
1	18	9.3	277
2	17	9.6	278
3	17	9.7	498
4	16	10	415
5	16	8.1	398
6	17	9	344
7	17	9.1	361
8	17	7	209
9	16	7.3	371
10	18	9.4	355
11	17	6.9	388
12	17	8.9	441
13	18	6.9	308
14	18	7.9	357
15	16	7.5	430
16	18	9.8	394
17	16	9	393
18	18	6	500
19	16	8.4	366
20	18	7	362
21	17	6.5	218
22	16	8.8	427
23	18	8.4	445
24	16	8.1	357
25	16	9.2	287
26	16	8.5	470
27	18	6.9	324
28	18	7.6	228
29	17	8.5	264
30	16	8.6	235

Radar Type 4			
Trial#	Number of Pulses per Burst	Pulse Width (μs)	PRI (μs)
1	16	13.5	493
2	14	11	300
3	12	13.2	401
4	16	12.9	296
5	12	11.2	268
6	15	12.5	268



America

7	15	19.8	493
8	12	19.7	208
9	16	17.9	425
10	14	16.5	220
11	15	15.1	490
12	14	16.5	271
13	16	13.6	438
14	13	16	314
15	12	13.2	203
16	16	11.8	312
17	16	17.8	338
18	12	19.3	401
19	16	16.3	294
20	14	17.3	270
21	15	15.4	394
22	13	15.2	428
23	16	12.2	323
24	14	16.2	462
25	14	17.8	326
26	12	14.8	415
27	13	11.3	404
28	15	11.9	457
29	13	16	363
30	16	16	205
31	16	13.5	493
32	14	11	300
33	12	13.2	401
34	16	12.9	296
35	12	11.2	268
36	15	12.5	268
37	15	19.8	493
38	12	19.7	208
39	16	17.9	425
40	14	16.5	220
41	15	15.1	490
42	14	16.5	271
43	16	13.6	438
44	13	16	314
45	12	13.2	203
46	16	11.8	312
47	16	17.8	338
48	12	19.3	401
49	16	16.3	294
50	14	17.3	270



Radar Type 5						
Trial Number: 1 Subset 1 (Center Frequency)						
Number of Bursts in Trial: 15						
Chirp Center Frequency: 5280 MHz						
Burst	Number of Pulses	Pulse Width (μs)	Chirp Width (μsec)	Pulse 1 to 2 Spacing (μsec)	Pulse 2 to 3 Spacing (μsec)	Starting Location Within Interval (μsec)
1	2	78	0.100	984.0	0.0	586060.0
2	2	89	0.111	1649.0	0.0	763310.0
3	3	94	0.143	1496.0	1457.0	132961.0
4	1	77	0.143	0.0	0.0	480837.0
5	3	83	0.077	1124.0	1304.0	630955.0
6	3	96	0.125	961.0	1484.0	314098.0
7	1	99	0.111	0.0	0.0	703207.0
8	2	68	0.056	1734.0	0.0	747473.0
9	3	65	0.063	1350.0	1163.0	540500.0
10	1	50	0.091	0.0	0.0	36571.0
11	1	93	0.100	0.0	0.0	535528.0
12	3	50	0.143	1625.0	1893.0	502286.0
13	3	51	0.067	1325.0	1517.0	646617.0
14	1	66	0.067	0.0	0.0	628379.0
15	3	85	0.100	1580.0	1083.0	291496.0

Radar Type 5						
Trial Number: 2 Subset 1 (Center Frequency)						
Number of Bursts in Trial: 18						
Chirp Center Frequency: 5280 MHz						
Burst	Number of Pulses	Pulse Width (μs)	Chirp Width (μsec)	Pulse 1 to 2 Spacing (μsec)	Pulse 2 to 3 Spacing (μsec)	Starting Location Within Interval (μsec)
1	3	58	0.167	1920.0	1857.0	557951.0
2	1	79	0.077	0.0	0.0	495014.0
3	1	67	0.053	0.0	0.0	145453.0
4	3	96	0.143	980.0	1633.0	408900.0
5	2	93	0.091	1379.0	0.0	465786.0
6	1	80	0.143	0.0	0.0	211077.0
7	2	83	0.077	1488.0	0.0	111272.0
8	2	76	0.056	1578.0	0.0	628439.0
9	1	84	0.059	0.0	0.0	17236.0
10	1	96	0.050	0.0	0.0	528872.0



America

11	2	60	0.059	1133.0	0.0	391129.0
12	2	88	0.083	1857.0	0.0	493448.0
13	2	64	0.071	1188.0	0.0	572348.0
14	1	52	0.167	0.0	0.0	533579.0
15	3	86	0.056	1079.0	1003.0	343738.0
16	1	77	0.050	0.0	0.0	363494.0
17	3	67	0.071	1653.0	1472.0	14679.0
18	3	77	0.111	993.0	984.0	545633.0

Radar Type 5						
Trial Number: 3 Subset 1 (Center Frequency)						
Number of Bursts in Trial: 16						
Chirp Center Frequency: 5280 MHz						
Burst	Number of Pulses	Pulse Width (μs)	Chirp Width (μsec)	Pulse 1 to 2 Spacing (μsec)	Pulse 2 to 3 Spacing (μsec)	Starting Location Within Interval (μsec)
1	2	89	0.125	1287.0	0.0	271342.0
2	3	91	0.077	1882.0	1894.0	77236.0
3	1	54	0.063	0.0	0.0	35648.0
4	3	84	0.083	1821.0	1719.0	703168.0
5	1	70	0.167	0.0	0.0	418138.0
6	1	61	0.053	0.0	0.0	534129.0
7	3	50	0.063	1895.0	981.0	314340.0
8	2	95	0.143	1674.0	0.0	444645.0
9	1	50	0.056	0.0	0.0	272782.0
10	2	75	0.083	1227.0	0.0	667245.0
11	3	81	0.071	1076.0	937.0	551370.0
12	1	69	0.167	0.0	0.0	614166.0
13	1	86	0.053	0.0	0.0	622453.0
14	1	99	0.100	0.0	0.0	203513.0
15	1	65	0.067	0.0	0.0	584437.0
16	1	77	0.050	0.0	0.0	363494.0

Radar Type 5						
Trial Number: 4 Subset 1 (Center Frequency)						
Number of Bursts in Trial: 11						
Chirp Center Frequency: 5280 MHz						
Burst	Number of Pulses	Pulse Width (μs)	Chirp Width (μsec)	Pulse 1 to 2 Spacing (μsec)	Pulse 2 to 3 Spacing (μsec)	Starting Location Within Interval (μsec)
1	1	81	0.200	0.0	0.0	641482.0



2	3	51	0.056	1088.0	1349.0	632803.0
3	3	64	0.167	947.0	1724.0	350274.0
4	2	95	0.111	1078.0	0.0	693368.0
5	2	55	0.125	1349.0	0.0	3117.0
6	1	54	0.167	0.0	0.0	1011290.0
7	3	68	0.059	963.0	1280.0	550735.0
8	3	87	0.059	1770.0	1897.0	80664.0
9	2	89	0.100	1669.0	0.0	198643.0
10	2	100	0.125	1136.0	0.0	464504.0
11	3	81	0.071	1076.0	937.0	551370.0

Radar Type 5						
Trial Number: 5 Subset 1 (Center Frequency)						
Number of Bursts in Trial: 18						
Chirp Center Frequency: 5280 MHz						
Burst	Number of Pulses	Pulse Width (μs)	Chirp Width (μsec)	Pulse 1 to 2 Spacing (μsec)	Pulse 2 to 3 Spacing (μsec)	Starting Location Within Interval (μsec)
1	1	97	0.059	0.0	0.0	507286.0
2	1	74	0.063	0.0	0.0	379805.0
3	2	54	0.067	1227.0	0.0	370415.0
4	3	55	0.091	1135.0	1507.0	547715.0
5	1	95	0.067	0.0	0.0	546897.0
6	2	54	0.056	1637.0	0.0	279795.0
7	3	51	0.091	1661.0	1947.0	625673.0
8	2	93	0.200	1129.0	0.0	13020.0
9	1	52	0.059	0.0	0.0	174885.0
10	1	100	0.063	0.0	0.0	437335.0
11	2	66	0.200	1510.0	0.0	49372.0
12	3	59	0.053	1478.0	1046.0	135734.0
13	3	59	0.059	1254.0	1567.0	307773.0
14	3	98	0.111	1515.0	1075.0	162392.0
15	1	99	0.077	0.0	0.0	486144.0
16	1	55	0.091	0.0	0.0	482352.0
17	2	69	0.125	1105.0	0.0	63897.0
18	3	73	0.100	1827.0	1732.0	5846.0





Radar Type 5						
Trial Number: 6 Subset 1 (Center Frequency)						
Number of Bursts in Trial: 8						
Chirp Center Frequency: 5280 MHz						
Burst	Number of Pulses	Pulse Width (μs)	Chirp Width (μsec)	Pulse 1 to 2 Spacing (μsec)	Pulse 2 to 3 Spacing (μsec)	Starting Location Within Interval (μsec)
1	3	93	0.077	1744.0	1220.0	1100871.0
2	1	90	0.091	0.0	0.0	43039.0
3	2	52	0.100	1028.0	0.0	1024182.0
4	2	77	0.167	1848.0	0.0	1235807.0
5	1	69	0.071	0.0	0.0	425976.0
6	3	81	0.125	1617.0	927.0	553763.0
7	1	74	0.071	0.0	0.0	246325.0
8	2	74	0.091	1632.0	0.0	623594.0

Radar Type 5						
Trial Number: 7 Subset 1 (Center Frequency)						
Number of Bursts in Trial: 14						
Chirp Center Frequency: 5280 MHz						
Burst	Number of Pulses	Pulse Width (μs)	Chirp Width (μsec)	Pulse 1 to 2 Spacing (μsec)	Pulse 2 to 3 Spacing (μsec)	Starting Location Within Interval (μsec)
1	3	79	0.100	1502.0	1878.0	147225.0
2	3	50	0.125	1798.0	1739.0	697705.0
3	3	59	0.056	1312.0	1204.0	231448.0
4	3	85	0.077	1368.0	1706.0	31115.0
5	3	98	0.083	1080.0	1490.0	177332.0
6	1	92	0.067	0.0	0.0	336899.0
7	3	78	0.167	935.0	1249.0	679224.0
8	3	60	0.083	1101.0	1521.0	200448.0
9	2	71	0.111	1051.0	0.0	182129.0
10	1	92	0.063	0.0	0.0	11885.0
11	2	90	0.111	1515.0	0.0	7452.0
12	3	83	0.091	953.0	1569.0	822896.0
13	1	74	0.100	0.0	0.0	247051.0
14	1	62	0.050	0.0	0.0	64186.0



Radar Type 5						
Trial Number: 8 Subset 1 (Center Frequency)						
Number of Bursts in Trial: 20						
Chirp Center Frequency: 5280 MHz						
Burst	Number of Pulses	Pulse Width (μs)	Chirp Width (μsec)	Pulse 1 to 2 Spacing (μsec)	Pulse 2 to 3 Spacing (μsec)	Starting Location Within Interval (μsec)
1	1	100	0.067	0.0	0.0	273314.0
2	3	67	0.200	1803.0	1398.0	593496.0
3	1	100	0.050	0.0	0.0	227497.0
4	2	89	0.059	1319.0	0.0	190844.0
5	1	56	0.059	0.0	0.0	250041.0
6	2	81	0.167	1031.0	0.0	61063.0
7	1	91	0.050	0.0	0.0	119325.0
8	3	89	0.063	1419.0	1076.0	492866.0
9	3	83	0.063	1701.0	1880.0	25041.0
10	2	99	0.125	1008.0	0.0	574469.0
11	2	76	0.056	1549.0	0.0	8134.0
12	3	77	0.071	1043.0	1761.0	393201.0
13	1	96	0.056	0.0	0.0	390000.0
14	1	93	0.125	0.0	0.0	104259.0
15	3	93	0.071	1865.0	1453.0	392967.0
16	2	67	0.059	1308.0	0.0	544941.0
17	2	95	0.200	1047.0	0.0	302018.0
18	1	56	0.071	0.0	0.0	448633.0
19	3	57	0.053	988.0	1931.0	121823.0
20	2	90	0.053	1223.0	0.0	6135.0

Radar Type 5						
Trial Number: 9 Subset 1 (Center Frequency)						
Number of Bursts in Trial: 17						
Chirp Center Frequency: 5280 MHz						
Burst	Number of Pulses	Pulse Width (μs)	Chirp Width (μsec)	Pulse 1 to 2 Spacing (μsec)	Pulse 2 to 3 Spacing (μsec)	Starting Location Within Interval (μsec)
1	3	51	0.091	1057.0	1858.0	397414.0
2	1	99	0.067	0.0	0.0	332100.0
3	3	60	0.125	1133.0	1712.0	163382.0
4	3	67	0.100	1843.0	1212.0	337551.0



5	1	76	0.053	0.0	0.0	396246.0
6	3	67	0.125	1482.0	1337.0	349583.0
7	2	58	0.053	1807.0	0.0	407066.0
8	1	80	0.063	0.0	0.0	583245.0
9	2	54	0.077	1367.0	0.0	505524.0
10	3	90	0.091	1100.0	933.0	413715.0
11	3	55	0.083	1210.0	1767.0	631512.0
12	1	67	0.071	0.0	0.0	673205.0
13	3	55	0.167	1180.0	1788.0	30827.0
14	1	96	0.067	0.0	0.0	522123.0
15	3	82	0.167	1589.0	1317.0	490358.0
16	1	60	0.063	0.0	0.0	125007.0
17	2	95	0.200	1047.0	0.0	302018.0

Radar Type 5						
Trial Number: 10 Subset 1 (Center Frequency)						
Number of Bursts in Trial: 17						
Chirp Center Frequency: 5280 MHz						
Burst	Number of Pulses	Pulse Width (µs)	Chirp Width (µsec)	Pulse 1 to 2 Spacing (µsec)	Pulse 2 to 3 Spacing (µsec)	Starting Location Within Interval (µsec)
1	2	52	0.067	1801.0	0.0	175182.0
2	1	94	0.053	0.0	0.0	679953.0
3	2	59	0.056	1733.0	0.0	350936.0
4	2	77	0.111	1761.0	0.0	227413.0
5	1	90	0.056	0.0	0.0	87578.0
6	3	99	0.071	1319.0	945.0	481800.0
7	2	62	0.063	1517.0	0.0	241473.0
8	2	94	0.050	1794.0	0.0	352664.0
9	2	60	0.059	1376.0	0.0	184435.0
10	3	67	0.053	1612.0	1316.0	357181.0
11	1	99	0.125	0.0	0.0	174653.0
12	3	89	0.053	1798.0	1790.0	440373.0
13	3	92	0.125	1280.0	1093.0	346630.0
14	1	72	0.056	0.0	0.0	466955.0
15	2	70	0.100	1753.0	0.0	567226.0
16	1	71	0.056	0.0	0.0	615811.0
17	2	85	0.063	1576.0	0.0	124474.0



Radar Type 5						
Trial Number: 11 Subset 2 (90% of the Radar Type 5 frequency modulation is within the low edge of the UUT Occupied BW)						
Number of Bursts in Trial: 12						
Chirp Center Frequency: 5263 MHz (Minimum with 5MHz Chirp width)						
Burst	Number of Pulses	Pulse Width (μs)	Chirp Width (μsec)	Pulse 1 to 2 Spacing (μsec)	Pulse 2 to 3 Spacing (μsec)	Starting Location Within Interval (μsec)
1	1	74	0.100	0.0	0.0	435965.0
2	3	98	0.167	910.0	1776.0	783712.0
3	2	80	0.167	996.0	0.0	426767.0
4	1	74	0.056	0.0	0.0	721875.0
5	3	93	0.067	1303.0	1349.0	901842.0
6	2	52	0.200	1187.0	0.0	938004.0
7	3	58	0.200	964.0	1854.0	19559.0
8	3	50	0.050	1666.0	1424.0	386764.0
9	2	51	0.091	1354.0	0.0	364659.0
10	3	72	0.071	1131.0	1826.0	936221.0
11	1	75	0.067	0.0	0.0	76714.0
12	3	89	0.053	1798.0	1790.0	440373.0

Radar Type 5						
Trial Number: 12 Subset 2 (90% of the Radar Type 5 frequency modulation is within the low edge of the UUT Occupied BW)						
Number of Bursts in Trial: 20						
Chirp Center Frequency: 5264 MHz						
Burst	Number of Pulses	Pulse Width (μs)	Chirp Width (μsec)	Pulse 1 to 2 Spacing (μsec)	Pulse 2 to 3 Spacing (μsec)	Starting Location Within Interval (μsec)
1	3	61	0.071	980.0	1104.0	243663.0
2	1	74	0.053	0.0	0.0	3392.0
3	2	73	0.143	1286.0	0.0	11429.0
4	2	99	0.111	1470.0	0.0	381453.0
5	3	53	0.125	1734.0	1466.0	166165.0
6	3	53	0.083	1337.0	1775.0	239400.0
7	2	76	0.125	1130.0	0.0	493520.0
8	1	81	0.200	0.0	0.0	316756.0
9	3	50	0.053	1709.0	995.0	272270.0
10	3	94	0.200	1487.0	1524.0	300700.0
11	1	60	0.063	0.0	0.0	593172.0
12	3	76	0.053	1389.0	1923.0	590229.0



13	2	59	0.167	1780.0	0.0	387648.0
14	1	91	0.067	0.0	0.0	390102.0
15	2	77	0.167	925.0	0.0	46034.0
16	1	51	0.083	0.0	0.0	493488.0
17	1	60	0.083	0.0	0.0	485470.0
18	1	95	0.083	0.0	0.0	197900.0
19	2	61	0.200	1740.0	0.0	438424.0
20	2	76	0.063	1417.0	0.0	452025.0

Radar Type 5						
Trial Number: 13 Subset 2 (90% of the Radar Type 5 frequency modulation is within the low edge of the UUT Occupied BW)						
Number of Bursts in Trial: 16						
Chirp Center Frequency: 5264 MHz						
Burst	Number of Pulses	Pulse Width (μs)	Chirp Width (μsec)	Pulse 1 to 2 Spacing (μsec)	Pulse 2 to 3 Spacing (μsec)	Starting Location Within Interval (μsec)
1	1	91	0.071	0.0	0.0	43349.0
2	2	97	0.050	1876.0	0.0	16443.0
3	1	83	0.063	0.0	0.0	574107.0
4	1	53	0.125	0.0	0.0	596104.0
5	2	85	0.050	1088.0	0.0	263296.0
6	1	82	0.071	0.0	0.0	483602.0
7	3	96	0.050	1485.0	1164.0	436168.0
8	2	67	0.111	947.0	0.0	481099.0
9	1	54	0.053	0.0	0.0	182521.0
10	3	73	0.143	1762.0	1450.0	197877.0
11	3	84	0.100	1650.0	1119.0	593747.0
12	3	76	0.056	1414.0	1866.0	345366.0
13	3	54	0.200	959.0	1387.0	699717.0
14	1	57	0.091	0.0	0.0	585190.0
15	1	80	0.067	0.0	0.0	334447.0
16	3	86	0.125	1801.0	1098.0	602836.0



Radar Type 5						
Trial Number: 14 Subset 2 (90% of the Radar Type 5 frequency modulation is within the low edge of the UUT Occupied BW)						
Number of Bursts in Trial: 8						
Chirp Center Frequency: 5265 MHz						
Burst	Number of Pulses	Pulse Width (μs)	Chirp Width (μsec)	Pulse 1 to 2 Spacing (μsec)	Pulse 2 to 3 Spacing (μsec)	Starting Location Within Interval (μsec)
1	2	54	0.125	1571.0	0.0	1268156.0
2	1	90	0.059	0.0	0.0	1238624.0
3	2	76	0.063	1608.0	0.0	572755.0
4	3	59	0.053	965.0	1138.0	1140508.0
5	2	92	0.050	1527.0	0.0	1104608.0
6	1	88	0.050	0.0	0.0	92860.0
7	1	99	0.111	0.0	0.0	201376.0
8	2	66	0.050	1733.0	0.0	581974.0

Radar Type 5						
Trial Number: 15 Subset 2 (90% of the Radar Type 5 frequency modulation is within the low edge of the UUT Occupied BW)						
Number of Bursts in Trial: 15						
Chirp Center Frequency: 5266 MHz						
Burst	Number of Pulses	Pulse Width (μs)	Chirp Width (μsec)	Pulse 1 to 2 Spacing (μsec)	Pulse 2 to 3 Spacing (μsec)	Starting Location Within Interval (μsec)
1	3	64	0.091	1536.0	1302.0	418016.0
2	3	99	0.167	922.0	1431.0	268661.0
3	3	100	0.200	1605.0	1440.0	100148.0
4	2	95	0.059	1204.0	0.0	649681.0
5	3	78	0.083	1142.0	1489.0	233759.0
6	1	91	0.091	0.0	0.0	418411.0
7	2	66	0.083	1897.0	0.0	191663.0
8	2	54	0.056	1066.0	0.0	554122.0
9	3	77	0.053	1029.0	1241.0	70640.0
10	3	90	0.056	1077.0	1411.0	665140.0
11	2	74	0.063	965.0	0.0	735542.0
12	1	66	0.067	0.0	0.0	10369.0
13	1	56	0.056	0.0	0.0	346535.0
14	3	78	0.063	1222.0	1442.0	427467.0
15	1	80	0.067	0.0	0.0	334447.0



Radar Type 5						
<b>Trial Number: 16 Subset 2 (90% of the Radar Type 5 frequency modulation is within the low edge of the UUT Occupied BW)</b>						
<b>Number of Bursts in Trial: 10</b>						
<b>Chirp Center Frequency: 5266 MHz</b>						
Burst	Number of Pulses	Pulse Width (μs)	Chirp Width (μsec)	Pulse 1 to 2 Spacing (μsec)	Pulse 2 to 3 Spacing (μsec)	Starting Location Within Interval (μsec)
1	2	67	0.053	1411.0	0.0	728775.0
2	1	98	0.125	0.0	0.0	26809.0
3	2	87	0.200	1161.0	0.0	240333.0
4	3	90	0.077	1359.0	1591.0	894254.0
5	2	55	0.067	1595.0	0.0	623252.0
6	3	75	0.100	1557.0	1380.0	232525.0
7	3	81	0.077	1328.0	1500.0	482345.0
8	3	53	0.059	1196.0	1851.0	947294.0
9	3	97	0.077	1397.0	1002.0	1000559.0
10	3	90	0.056	1077.0	1411.0	665140.0

Radar Type 5						
<b>Trial Number: 17 Subset 2 (90% of the Radar Type 5 frequency modulation is within the low edge of the UUT Occupied BW)</b>						
<b>Number of Bursts in Trial: 14</b>						
<b>Chirp Center Frequency: 5267 MHz</b>						
Burst	Number of Pulses	Pulse Width (μs)	Chirp Width (μsec)	Pulse 1 to 2 Spacing (μsec)	Pulse 2 to 3 Spacing (μsec)	Starting Location Within Interval (μsec)
1	3	62	0.050	1604.0	1706.0	529138.0
2	2	78	0.091	1686.0	0.0	338034.0
3	3	90	0.167	1297.0	1572.0	329337.0
4	3	75	0.083	1248.0	1760.0	614636.0
5	3	72	0.091	1430.0	1814.0	786337.0
6	1	52	0.083	0.0	0.0	683972.0
7	3	96	0.143	1797.0	1302.0	841739.0
8	2	65	0.125	1373.0	0.0	142645.0
9	1	90	0.111	0.0	0.0	627351.0
10	2	94	0.059	1904.0	0.0	525666.0
11	1	59	0.056	0.0	0.0	455688.0
12	3	61	0.091	1057.0	1652.0	552387.0
13	2	86	0.053	1808.0	0.0	768350.0
14	3	78	0.063	1222.0	1442.0	427467.0



Radar Type 5						
Trial Number: 18 Subset 2 (90% of the Radar Type 5 frequency modulation is within the low edge of the UUT Occupied BW)						
Number of Bursts in Trial: 20						
Chirp Center Frequency: 5268 MHz						
Burst	Number of Pulses	Pulse Width (μs)	Chirp Width (μsec)	Pulse 1 to 2 Spacing (μsec)	Pulse 2 to 3 Spacing (μsec)	Starting Location Within Interval (μsec)
1	3	59	0.167	1337.0	1494.0	472427.0
2	2	54	0.059	1472.0	0.0	29588.0
3	1	52	0.053	0.0	0.0	320616.0
4	3	54	0.071	1839.0	1127.0	364261.0
5	2	80	0.071	961.0	0.0	271177.0
6	1	96	0.091	0.0	0.0	325358.0
7	1	55	0.056	0.0	0.0	34056.0
8	3	53	0.167	1384.0	1926.0	124400.0
9	2	64	0.100	1122.0	0.0	357569.0
10	1	83	0.200	0.0	0.0	215509.0
11	1	55	0.071	0.0	0.0	525575.0
12	3	66	0.100	1528.0	1457.0	211770.0
13	1	76	0.063	0.0	0.0	404981.0
14	1	70	0.050	0.0	0.0	228329.0
15	3	56	0.083	1553.0	1589.0	382632.0
16	3	81	0.100	1081.0	1326.0	585378.0
17	3	90	0.111	1460.0	1122.0	259212.0
18	2	61	0.200	1665.0	0.0	233884.0
19	2	79	0.167	1800.0	0.0	411270.0
20	3	81	0.167	1704.0	1570.0	488027.0

Radar Type 5						
Trial Number: 19 Subset 2 (90% of the Radar Type 5 frequency modulation is within the low edge of the UUT Occupied BW)						
Number of Bursts in Trial: 16						
Chirp Center Frequency: 5268 MHz						
Burst	Number of Pulses	Pulse Width (μs)	Chirp Width (μsec)	Pulse 1 to 2 Spacing (μsec)	Pulse 2 to 3 Spacing (μsec)	Starting Location Within Interval (μsec)
1	3	95	0.071	1368.0	1880.0	143046.0
2	1	50	0.125	0.0	0.0	140187.0





America

3	2	76	0.111	1186.0	0.0	140046.0
4	2	90	0.053	1630.0	0.0	276672.0
5	1	88	0.050	0.0	0.0	29477.0
6	2	88	0.050	1687.0	0.0	525737.0
7	1	81	0.100	0.0	0.0	18221.0
8	1	69	0.067	0.0	0.0	467473.0
9	3	77	0.200	1737.0	1637.0	147544.0
10	1	51	0.071	0.0	0.0	426528.0
11	2	83	0.143	1245.0	0.0	667408.0
12	3	72	0.091	1057.0	1850.0	410210.0
13	3	60	0.125	1362.0	1249.0	113538.0
14	2	60	0.083	1126.0	0.0	658216.0
15	2	92	0.056	1267.0	0.0	512829.0
16	2	78	0.077	1607.0	0.0	9345.0

Radar Type 5						
Trial Number: 20 Subset 2 (90% of the Radar Type 5 frequency modulation is within the low edge of the UUT Occupied BW)						
Number of Bursts in Trial: 20						
Chirp Center Frequency: 5269 MHz (Maximum with 20MHz Chirp width)						
Burst	Number of Pulses	Pulse Width (µs)	Chirp Width (µsec)	Pulse 1 to 2 Spacing (µsec)	Pulse 2 to 3 Spacing (µsec)	Starting Location Within Interval (µsec)
1	1	79	0.143	0.0	0.0	329738.0
2	3	87	0.091	1489.0	1639.0	151800.0
3	3	53	0.167	1270.0	1787.0	233278.0
4	2	52	0.063	1762.0	0.0	48662.0
5	2	77	0.167	1236.0	0.0	302756.0
6	2	62	0.053	1781.0	0.0	347196.0
7	1	77	0.053	0.0	0.0	10314.0
8	2	65	0.059	1374.0	0.0	498750.0
9	3	96	0.083	1529.0	1713.0	456707.0
10	3	51	0.056	1114.0	1099.0	300431.0
11	3	60	0.053	1752.0	965.0	10109.0
12	1	60	0.125	0.0	0.0	92380.0
13	3	95	0.067	1397.0	1442.0	97318.0
14	1	61	0.167	0.0	0.0	387261.0
15	2	95	0.050	1074.0	0.0	552264.0
16	3	65	0.077	1688.0	1431.0	238810.0
17	3	85	0.167	1196.0	1253.0	594185.0
18	1	80	0.111	0.0	0.0	313840.0
19	1	82	0.067	0.0	0.0	136951.0
20	2	98	0.100	1130.0	0.0	352919.0



Radar Type 5						
<b>Trial Number: 21 Subset 3 (90% of the Radar Type 5 frequency modulation is within the high edge of the UUT Occupied BW)</b>						
<b>Number of Bursts in Trial: 17</b>						
<b>Chirp Center Frequency: 5297 MHz (Minimum with 5MHz Chirp width)</b>						
Burst	Number of Pulses	Pulse Width (μs)	Chirp Width (μsec)	Pulse 1 to 2 Spacing (μsec)	Pulse 2 to 3 Spacing (μsec)	Starting Location Within Interval (μsec)
1	2	53	0.077	1843.0	0.0	41821.0
2	1	87	0.053	0.0	0.0	73254.0
3	3	85	0.083	1618.0	1669.0	672339.0
4	1	80	0.125	0.0	0.0	140816.0
5	1	55	0.071	0.0	0.0	576808.0
6	1	69	0.111	0.0	0.0	239686.0
7	3	67	0.050	1919.0	1252.0	115015.0
8	3	89	0.067	1099.0	1093.0	155819.0
9	1	62	0.100	0.0	0.0	348921.0
10	2	92	0.059	1840.0	0.0	637883.0
11	1	69	0.100	0.0	0.0	74346.0
12	1	71	0.067	0.0	0.0	6930.0
13	1	69	0.077	0.0	0.0	563212.0
14	3	90	0.077	1043.0	1640.0	259691.0
15	1	97	0.050	0.0	0.0	212134.0
16	1	71	0.050	0.0	0.0	42994.0
17	3	89	0.167	1165.0	1199.0	420127.0

Radar Type 5						
<b>Trial Number: 22 Subset 3 (90% of the Radar Type 5 frequency modulation is within the high edge of the UUT Occupied BW)</b>						
<b>Number of Bursts in Trial: 12</b>						
<b>Chirp Center Frequency: 5296 MHz</b>						
Burst	Number of Pulses	Pulse Width (μs)	Chirp Width (μsec)	Pulse 1 to 2 Spacing (μsec)	Pulse 2 to 3 Spacing (μsec)	Starting Location Within Interval (μsec)
1	2	84	0.050	1532.0	0.0	878237.0
2	1	87	0.143	0.0	0.0	762006.0
3	2	91	0.067	1332.0	0.0	278494.0
4	2	89	0.100	1744.0	0.0	464061.0
5	2	100	0.053	1871.0	0.0	386401.0
6	3	55	0.050	1450.0	1794.0	882625.0
7	3	54	0.053	1414.0	1372.0	131766.0
8	2	76	0.056	1003.0	0.0	547196.0



9	3	61	0.053	1133.0	1692.0	564451.0
10	3	73	0.200	1690.0	1348.0	820334.0
11	1	67	0.077	0.0	0.0	699439.0
12	2	84	0.059	1238.0	0.0	237349.0

Radar Type 5						
Trial Number: 23 Subset 3 (90% of the Radar Type 5 frequency modulation is within the high edge of the UUT Occupied BW)						
Number of Bursts in Trial: 11						
Chirp Center Frequency: 5296 MHz						
Burst	Number of Pulses	Pulse Width (μs)	Chirp Width (μsec)	Pulse 1 to 2 Spacing (μsec)	Pulse 2 to 3 Spacing (μsec)	Starting Location Within Interval (μsec)
1	3	70	0.063	1668.0	1886.0	926854.0
2	1	59	0.056	0.0	0.0	1071552.0
3	2	97	0.125	1608.0	0.0	80516.0
4	1	59	0.077	0.0	0.0	202770.0
5	1	92	0.167	0.0	0.0	629624.0
6	1	91	0.143	0.0	0.0	1000757.0
7	2	50	0.056	1036.0	0.0	824207.0
8	1	76	0.100	0.0	0.0	535568.0
9	2	50	0.071	1880.0	0.0	162434.0
10	3	96	0.083	1341.0	1074.0	160928.0
11	3	81	0.091	1408.0	1133.0	148795.0

Radar Type 5						
Trial Number: 24 Subset 3 (90% of the Radar Type 5 frequency modulation is within the high edge of the UUT Occupied BW)						
Number of Bursts in Trial: 10						
Chirp Center Frequency: 5295 MHz						
Burst	Number of Pulses	Pulse Width (μs)	Chirp Width (μsec)	Pulse 1 to 2 Spacing (μsec)	Pulse 2 to 3 Spacing (μsec)	Starting Location Within Interval (μsec)
1	3	70	0.063	1668.0	1886.0	926854.0
2	1	59	0.056	0.0	0.0	1071552.0
3	2	97	0.125	1608.0	0.0	80516.0
4	1	59	0.077	0.0	0.0	202770.0
5	1	92	0.167	0.0	0.0	629624.0
6	1	91	0.143	0.0	0.0	1000757.0
7	2	50	0.056	1036.0	0.0	824207.0
8	1	76	0.100	0.0	0.0	535568.0



America

9	2	50	0.071	1880.0	0.0	162434.0
10	3	96	0.083	1341.0	1074.0	160928.0

Radar Type 5						
<b>Trial Number: 25 Subset 3 (90% of the Radar Type 5 frequency modulation is within the high edge of the UUT Occupied BW)</b>						
<b>Number of Bursts in Trial: 12</b>						
<b>Chirp Center Frequency: 5294 MHz</b>						
Burst	Number of Pulses	Pulse Width (μs)	Chirp Width (μsec)	Pulse 1 to 2 Spacing (μsec)	Pulse 2 to 3 Spacing (μsec)	Starting Location Within Interval (μsec)
1	1	94	0.111	0.0	0.0	436867.0
2	2	85	0.071	1196.0	0.0	838684.0
3	3	53	0.077	1599.0	971.0	10115.0
4	2	80	0.059	1841.0	0.0	667275.0
5	1	57	0.111	0.0	0.0	624580.0
6	2	64	0.071	962.0	0.0	101729.0
7	2	84	0.059	1892.0	0.0	34876.0
8	2	87	0.059	1548.0	0.0	40746.0
9	3	72	0.059	1876.0	1100.0	185895.0
10	1	63	0.077	0.0	0.0	797095.0
11	1	94	0.067	0.0	0.0	122271.0
12	2	84	0.059	1238.0	0.0	237349.0

Radar Type 5						
<b>Trial Number: 26 Subset 3 (90% of the Radar Type 5 frequency modulation is within the high edge of the UUT Occupied BW)</b>						
<b>Number of Bursts in Trial: 11</b>						
<b>Chirp Center Frequency: 5294 MHz</b>						
Burst	Number of Pulses	Pulse Width (μs)	Chirp Width (μsec)	Pulse 1 to 2 Spacing (μsec)	Pulse 2 to 3 Spacing (μsec)	Starting Location Within Interval (μsec)
1	1	79	0.143	0.0	0.0	365403.0
2	1	65	0.077	0.0	0.0	672702.0
3	2	63	0.063	1899.0	0.0	795596.0
4	3	61	0.111	1143.0	1028.0	476924.0
5	1	51	0.167	0.0	0.0	250606.0
6	1	81	0.050	0.0	0.0	700564.0
7	3	90	0.083	1031.0	1023.0	595851.0
8	3	94	0.056	1537.0	1518.0	22158.0
9	3	80	0.067	1010.0	1446.0	329826.0



10	3	97	0.143	1667.0	1870.0	1000007.0
11	2	62	0.053	1169.0	0.0	20639.0

Radar Type 5						
Trial Number: 27 Subset 3 (90% of the Radar Type 5 frequency modulation is within the high edge of the UUT Occupied BW)						
Number of Bursts in Trial: 12						
Chirp Center Frequency: 5293 MHz						
Burst	Number of Pulses	Pulse Width (μs)	Chirp Width (μsec)	Pulse 1 to 2 Spacing (μsec)	Pulse 2 to 3 Spacing (μsec)	Starting Location Within Interval (μsec)
1	1	86	0.143	0.0	0.0	670981.0
2	2	91	0.050	1058.0	0.0	604702.0
3	2	98	0.167	1281.0	0.0	638714.0
4	2	53	0.071	1565.0	0.0	380572.0
5	3	85	0.059	1618.0	972.0	466434.0
6	1	92	0.077	0.0	0.0	592642.0
7	3	84	0.077	1775.0	1420.0	528899.0
8	3	94	0.125	929.0	1734.0	133626.0
9	2	85	0.077	1908.0	0.0	103890.0
10	2	66	0.100	1393.0	0.0	682053.0
11	1	93	0.200	0.0	0.0	646740.0
12	1	50	0.167	0.0	0.0	203265.0

Radar Type 5						
Trial Number: 28 Subset 3 (90% of the Radar Type 5 frequency modulation is within the high edge of the UUT Occupied BW)						
Number of Bursts in Trial: 12						
Chirp Center Frequency: 5292 MHz						
Burst	Number of Pulses	Pulse Width (μs)	Chirp Width (μsec)	Pulse 1 to 2 Spacing (μsec)	Pulse 2 to 3 Spacing (μsec)	Starting Location Within Interval (μsec)
1	3	70	0.077	1670.0	1675.0	396578.0
2	1	94	0.167	0.0	0.0	691924.0
3	1	68	0.071	0.0	0.0	553686.0
4	3	66	0.167	1131.0	999.0	362812.0
5	3	75	0.125	1058.0	1107.0	410027.0
6	3	92	0.056	1115.0	1799.0	768387.0
7	3	84	0.056	1645.0	1736.0	954357.0
8	3	80	0.053	1429.0	1138.0	634021.0
9	1	66	0.067	0.0	0.0	296470.0



America

10	1	66	0.125	0.0	0.0	812245.0
11	1	92	0.077	0.0	0.0	483065.0
12	1	71	0.077	0.0	0.0	333483.0

Radar Type 5						
Trial Number: 29 Subset 3 (90% of the Radar Type 5 frequency modulation is within the high edge of the UUT Occupied BW)						
Number of Bursts in Trial: 17						
Chirp Center Frequency: 5292 MHz						
Burst	Number of Pulses	Pulse Width (μs)	Chirp Width (μsec)	Pulse 1 to 2 Spacing (μsec)	Pulse 2 to 3 Spacing (μsec)	Starting Location Within Interval (μsec)
1	2	50	0.053	1752.0	0.0	303939.0
2	2	97	0.063	1025.0	0.0	357703.0
3	1	72	0.083	0.0	0.0	332720.0
4	1	64	0.071	0.0	0.0	619237.0
5	3	88	0.091	1555.0	1450.0	676688.0
6	1	87	0.143	0.0	0.0	101027.0
7	2	77	0.091	1323.0	0.0	301157.0
8	3	75	0.083	1241.0	1760.0	579475.0
9	3	87	0.071	972.0	1725.0	86651.0
10	2	78	0.100	1127.0	0.0	138798.0
11	2	77	0.063	1510.0	0.0	206804.0
12	3	74	0.050	1649.0	1618.0	143659.0
13	3	68	0.071	1043.0	1653.0	6032.0
14	2	99	0.056	1871.0	0.0	530388.0
15	1	96	0.200	0.0	0.0	579468.0
16	2	87	0.056	1615.0	0.0	126665.0
17	3	97	0.143	1858.0	1753.0	495275.0

Radar Type 5						
Trial Number: 30 Subset 3 (90% of the Radar Type 5 frequency modulation is within the high edge of the UUT Occupied BW)						
Number of Bursts in Trial: 18						
Chirp Center Frequency: 5291 MHz (Maximum with 20MHz Chirp width)						
Burst	Number of Pulses	Pulse Width (μs)	Chirp Width (μsec)	Pulse 1 to 2 Spacing (μsec)	Pulse 2 to 3 Spacing (μsec)	Starting Location Within Interval (μsec)
1	2	88	0.200	1290.0	0.0	74193.0
2	1	88	0.050	0.0	0.0	150862.0
3	2	85	0.091	1282.0	0.0	655931.0
4	2	69	0.125	1771.0	0.0	327987.0



5	3	79	0.083	1082.0	1676.0	65401.0
6	1	76	0.091	0.0	0.0	563462.0
7	1	81	0.111	0.0	0.0	9964.0
8	1	99	0.125	0.0	0.0	544744.0
9	2	82	0.053	1071.0	0.0	37503.0
10	2	54	0.200	1383.0	0.0	222553.0
11	1	69	0.077	0.0	0.0	621612.0
12	1	68	0.053	0.0	0.0	176373.0
13	1	80	0.111	0.0	0.0	186469.0
14	1	81	0.100	0.0	0.0	72165.0
15	1	94	0.083	0.0	0.0	258522.0
16	1	50	0.125	0.0	0.0	372463.0
17	2	60	0.071	1576.0	0.0	345893.0
18	3	53	0.063	1609.0	1633.0	210912.0

**2.9.11 Test Results (40 MHz BW)**

Radar Type	Trial #	Detection		Trial #	Detection	
		Yes	No		Yes	No
1	1	✓		19	✓	
	2	✓		20	✓	
	3	✓		21	✓	
	4	✓		22	✓	
	5	✓		23	✓	
	6	✓		24	✓	
	7	✓		25	✓	
	8	✓		26	✓	
	9	✓		27	✓	
	10	✓		28	✓	
	11	✓		29	✓	
	12	✓		30	✓	
	13	✓		31	✓	
	14	✓		32	✓	
	15	✓		33	✓	
	16	✓		34	✓	
	17	✓		35	✓	
	18	✓				

Percentage of Successful detection = **100%**



Radar Type	Trial #	Detection		Trial #	Detection	
		Yes	No		Yes	No
2	1	✓		19	✓	
	2	✓		20	✓	
	3	✓		21	✓	
	4	✓		22	✓	
	5	✓		23	✓	
	6	✓		24	✓	
	7	✓		25	✓	
	8	✓		26	✓	
	9	✓		27	✓	
	10	✓		28	✓	
	11	✓		29	✓	
	12	✓		30	✓	
	13	✓				
	14	✓				
	15	✓				
	16	✓				
	17	✓				
	18	✓				

Percentage of Successful detection = **100%**

Radar Type	Trial #	Detection		Trial #	Detection	
		Yes	No		Yes	No
3	1		✓	19	✓	
	2	✓		20	✓	
	3	✓		21	✓	
	4	✓		22	✓	
	5	✓		23	✓	
	6	✓		24	✓	
	7	✓		25	✓	
	8	✓		26	✓	
	9	✓		27	✓	
	10	✓		28	✓	
	11	✓		29	✓	
	12	✓		30	✓	
	13	✓				
	14	✓				
	15	✓				
	16	✓				
	17	✓				
	18	✓				

Percentage of Successful detection = (Total Waveform Detections/Total Waveform Trials) x 100  
 = (29/30) x 100  
 = **96.7%** (Radar injected at 5280MHz only)





Radar Type	Trial #	Detection		Trial #	Detection	
		Yes	No		Yes	No
4	1	✓		26	✓	
	2	✓		27	✓	
	3	✓		28	✓	
	4	✓		29	✓	
	5	✓		30	✓	
	6	✓		31	✓	
	7	✓		32	✓	
	8	✓		33	✓	
	9	✓		34	✓	
	10	✓		35	✓	
	11	✓		36	✓	
	12	✓		37	✓	
	13	✓		38	✓	
	14	✓		39	✓	
	15	✓		40	✓	
	16	✓		41	✓	
	17	✓		42	✓	
	18	✓		43	✓	
	19	✓		44	✓	
	20	✓		45	✓	
	21	✓		46	✓	
	22	✓		47	✓	
	23	✓		48	✓	
	24	✓		49	✓	
	25	✓		50	✓	

Percentage of Successful detection = **100%** (Radar injected on 5280 MHz and 5281 MHz. When Radar was not detected on the center frequency, the Radar frequency was increased by 1MHz which always results on Radar detection. This is due to Zero IF (ZIF) receiver architecture of the EUT. In a randomly placed system, the radar signal has equal probability to appear anywhere within the detection bandwidth. The probability that the radar signal lands on or near (e.g. within the DC cancelation bandwidth) the carrier frequency is almost negligible).

Radar Type	Trial #	Detection		Trial #	Detection	
		Yes	No		Yes	No
5	1	✓		19	✓	
	2	✓		20	✓	
	3	✓		21	✓	
	4	✓		22		✓
	5	✓		23		✓
	6	✓		24		✓
	7	✓		25	✓	
	8	✓		26	✓	



	9	✓		27	✓	
	10	✓		28	✓	
	11		✓	29	✓	
	12	✓		30	✓	
	13	✓				
	14		✓			
	15	✓				
	16		✓			
	17	✓				
	18	✓				
Trial 1-10 (Center Frequency Subset 1) Trial 11-20 (FL + 0.4*Chirp Width (MHz)) Subset 2 Trial 21-30 (FL + 0.4*Chirp Width (MHz)) Subset 3 Percentage of Successful detection = (Total Waveform Detections/Total Waveform Trials) x 100 = (24/30) x 100 = <b>80.0%</b>						

Radar Type	Trial #	Detection		Trial #	Detection	
		Yes	No		Yes	No
6	1	✓		19	✓	
	2	✓		20	✓	
	3	✓		21	✓	
	4	✓		22	✓	
	5	✓		23	✓	
	6	✓		24	✓	
	7	✓		25	✓	
	8	✓		26	✓	
	9	✓		27	✓	
	10	✓		28	✓	
	11	✓		29	✓	
	12	✓		30	✓	
	13	✓				
	14	✓				
	15	✓				
	16	✓				
	17	✓				
	18	✓				
Percentage of Successful detection = <b>100%</b> (Radar injected at 5280MHz only)						



### **SECTION 3**

#### **TEST EQUIPMENT USED**



### 3.1 TEST EQUIPMENT USED

List of absolute measuring and other principal items of test equipment.

ID Number (SDGE/SDRB)	Test Equipment	Type	Serial Number	Manufacturer	Cal Date	Cal Due Date
Radiated Test Setup						
-	Coaxial SMA Fixed Attenuator (x2)	VAT-30W2	N/A	MCL	Verified by 7608 and 7582	
-	Coaxial SMA Fixed Attenuator	VAT-10W2	N/A	MCL	Verified by 7608 and 7582	
-	Coaxial SMA Fixed Attenuator	VAT-10+	N/A	Mini-Circuits	Verified by 7608 and 7582	
-	Power Splitter (2x)	ZN2PD-63-S+	N/A	Mini-Circuits	Verified by 7608 and 7582	
-	Low loss RF cable (x2)	JX50172-24	N/A	RF Precision Cables, Inc.	Verified by 7608 and 7582	
	Low loss RF cable (x2)	70032199	N/A	Allied Electronics	Verified by 7608 and 7582	
7610	DFS Radar Simulator and Analyzer	Aeroflex 3005	30050A/09L	Aeroflex international LTD. UK	03/04/15	03/04/16
7608	Vector Signal Generator	SMBV100A	259021	Rhode & Schwarz	07/29/15	07/29/16
7582	Signal/Spectrum Analyzer	FSW26	101614	Rhode & Schwarz	10/05/15	10/05/16
7620	EMI Test Receiver	ESU40	100399	Rhode & Schwarz	09/03/15	09/03/16
Miscellaneous						
6792	Multimeter	3478A	2911A70964	Hewlett Packard	08/14/15	08/14/16
7560	Barometer/Temperature/Humidity Transmitter	iBTHX-W	1240476	Omega	10/19/15	10/19/16
	Test Software	DFS Radar Simulator and Analyzer	V2.6.0	Cobham	N/A	



### 3.2 MEASUREMENT UNCERTAINTY

For a 95% confidence level, the measurement uncertainties for defined systems are:

#### 3.2.1 DFS

Contribution		Probability Distribution Type	Probability Distribution $x_i$	Standard Uncertainty $u(x_i)$	$[u(x_i)]^2$
1	Receiver/Spectrum Analyzer	Rectangular	0.08	0.05	0.00
2	Cables	Rectangular	0.30	0.17	0.03
3	Combiners	Rectangular	1.20	0.69	0.48
4	Attenuators	Rectangular	0.80	0.46	0.21
5	EUT Setup	Rectangular	0.50	0.29	0.08
Combined Uncertainty ( $u_c$ ):					0.90
Coverage Factor (k):					1.96
Expanded Uncertainty:					1.76



## **SECTION 4**

### **ACCREDITATION, DISCLAIMERS AND COPYRIGHT**



#### 4.1 ACCREDITATION, DISCLAIMERS AND COPYRIGHT

TÜV SÜD America Inc.'s reports apply only to the specific sample tested under stated test conditions. It is the manufacturer's responsibility to assure the continued compliance of production units of this model. TÜV SÜD America, Inc. shall have no liability for any deductions, inferences or generalizations drawn by the client or others from TÜV SÜD America, Inc.'s issued reports.

This report is the confidential property of the client. As a mutual protection to our clients, the public and TÜV SÜD America, Inc., extracts from the test report shall not be reproduced, except in full without TÜV SÜD America, Inc.'s written approval.

This report must not be used to claim product certification, approval, or endorsement by A2LA, NIST, or any agency of the federal government.

TÜV SÜD America, Inc. and its professional staff hold government and professional organization certifications for AAMI, ACIL, AEA, ANSI, IEEE, A2LA, NIST and VCCI.



A2LA Cert. No. 2955.13