



**DFS PORTION of FCC 47 CFR PART 15 SUBPART E  
DFS PORTION of INDUSTRY CANADA RSS-247 ISSUE 1**

**CERTIFICATION TEST REPORT**

**FOR**

**CEL-FI DUO SMART CELLULAR SIGNAL BOOSTER**

**MODEL NUMBER: D32-2/4NU**

**FCC ID: YETD24NU**

**REPORT NUMBER: 11440089-E2V2**

**ISSUE DATE: OCTOBER 27, 2016**

*Prepared for*  
**NEXTIVITY, INC.**  
**12230 WORLD TRADE DRIVE, SUITE 250**  
**SAN DIEGO**  
**CA., 92128, U.S.A.**

*Prepared by*  
**UL VERIFICATION SERVICES INC.**  
**47173 BENICIA STREET**  
**FREMONT, CA 94538, U.S.A.**  
**TEL: (510) 771-1000**  
**FAX: (510) 661-0888**



**NVLAP LAB CODE 200065-0**

Revision History

<u>Rev.</u>	<u>Issue Date</u>	<u>Revisions</u>	<u>Revised By</u>
V1	09/29/16	Initial Issue	Conan Cheung
V2	10/27/16	Update Antenna Parameter Information	Conan Cheung

## TABLE OF CONTENTS

<b>1. ATTESTATION OF TEST RESULTS .....</b>	<b>4</b>
<b>2. TEST METHODOLOGY .....</b>	<b>5</b>
<b>3. FACILITIES AND ACCREDITATION .....</b>	<b>5</b>
<b>4. CALIBRATION AND UNCERTAINTY .....</b>	<b>5</b>
4.1. <i>MEASURING INSTRUMENT CALIBRATION .....</i>	<i>5</i>
4.2. <i>SAMPLE CALCULATION .....</i>	<i>5</i>
4.3. <i>MEASUREMENT UNCERTAINTY.....</i>	<i>5</i>
<b>5. DYNAMIC FREQUENCY SELECTION.....</b>	<b>6</b>
5.1. <i>OVERVIEW .....</i>	<i>6</i>
5.1.1. <i>LIMITS.....</i>	<i>6</i>
5.1.2. <i>TEST AND MEASUREMENT SYSTEM.....</i>	<i>10</i>
5.1.3. <i>TEST AND MEASUREMENT SOFTWARE .....</i>	<i>12</i>
5.1.4. <i>SETUP OF EUT.....</i>	<i>13</i>
5.1.5. <i>DESCRIPTION OF EUT .....</i>	<i>14</i>
5.2. <i>THEORY OF OPERATION.....</i>	<i>16</i>
5.2.1. <i>TECHNICAL DESCRIPTION .....</i>	<i>16</i>
5.2.2. <i>CHANNEL MAPPING .....</i>	<i>16</i>
5.3. <i>TEST CHANNEL .....</i>	<i>18</i>
5.4. <i>RADAR WAVEFORMS.....</i>	<i>18</i>
5.5. <i>RESULTS FOR 30 MHz BANDWIDTH.....</i>	<i>25</i>
5.5.1. <i>TRAFFIC AND CHANNEL LOADING .....</i>	<i>25</i>
5.5.2. <i>CHANNEL AVAILABILITY CHECK TIME.....</i>	<i>27</i>
5.5.3. <i>OVERLAPPING CHANNEL TESTS.....</i>	<i>32</i>
5.5.4. <i>MOVE AND CLOSING TIME .....</i>	<i>32</i>
5.5.5. <i>DETECTION BANDWIDTH.....</i>	<i>37</i>
5.5.6. <i>IN-SERVICE MONITORING .....</i>	<i>39</i>
5.6. <i>RESULTS FOR 40 MHz BANDWIDTH.....</i>	<i>46</i>
5.6.1. <i>TRAFFIC AND CHANNEL LOADING .....</i>	<i>46</i>
5.6.2. <i>CHANNEL AVAILABILITY CHECK TIME.....</i>	<i>48</i>
5.6.1. <i>OVERLAPPING CHANNEL TESTS.....</i>	<i>53</i>
5.6.2. <i>MOVE AND CLOSING TIME .....</i>	<i>53</i>
5.6.1. <i>NON-OCCUPANCY PERIOD .....</i>	<i>58</i>
5.6.2. <i>DETECTION BANDWIDTH.....</i>	<i>59</i>
5.6.3. <i>IN-SERVICE MONITORING .....</i>	<i>61</i>
5.7. <i>BRIDGE MODE RESULTS.....</i>	<i>68</i>
<b>6. SETUP PHOTOS.....</b>	<b>69</b>

# 1. ATTESTATION OF TEST RESULTS

**COMPANY NAME:** NEXTIVITY, INC.  
12230 WORLD TRADE DRIVE, SUITE 250  
SAN DIEGO, CA., 92128, U.S.A.

**EUT DESCRIPTION:** CEL-FI DUO SMART CELLULAR SIGNAL BOOSTER

**MODEL:** D32-2/4NU

**SERIAL NUMBER:** 192428015602

**DATE TESTED:** SEPTEMBER 12, 2016

APPLICABLE STANDARDS	
STANDARD	TEST RESULTS
DFS Portion of CFR 47 Part 15 Subpart E	Pass
INDUSTRY CANADA RSS-247 Issue 1	Pass

UL Verification Services Inc. tested the above equipment in accordance with the requirements set forth in the above standards. All indications of Pass/Fail in this report are opinions expressed by UL Verification Services Inc. based on interpretations and/or observations of test results. Measurement Uncertainties were not taken into account and are published for informational purposes only. The test results show that the equipment tested is capable of demonstrating compliance with the requirements as documented in this report.

**Note:** The results documented in this report apply only to the tested sample, under the conditions and modes of operation as described herein. This document may not be altered or revised in any way unless done so by UL Verification Services Inc. and all revisions are duly noted in the revisions section. Any alteration of this document not carried out by UL Verification Services Inc. will constitute fraud and shall nullify the document. This report must not be used by the client to claim product certification, approval, or endorsement by NVLAP, NIST, any agency of the Federal Government, or any agency of any government.

Approved & Released For  
UL Verification Services Inc. By:



CONAN CHEUNG  
PROJECT LEAD  
UL Verification Services Inc.

Tested By:



HENRY LAU  
EMC ENGINEER  
UL Verification Services Inc.

## 2. TEST METHODOLOGY

The tests documented in this report were performed in accordance with the DFS portion of FCC CFR 47 Part 2, FCC CFR 47 Part 15, FCC 06-96, FCC KDB 789033, KDB 905462 D02 and D03, RSS-247 Issue 1.

## 3. FACILITIES AND ACCREDITATION

The test sites and measurement facilities used to collect data are located at 47173 Benicia Street, Fremont, California, USA.

UL Verification Services, Inc. is accredited by NVLAP, Laboratory Code 200065-0. The full scope of accreditation can be viewed at <http://ts.nist.gov/standards/scopes/2000650.htm>.

## 4. CALIBRATION AND UNCERTAINTY

### 4.1. MEASURING INSTRUMENT CALIBRATION

The measuring equipment utilized to perform the tests documented in this report has been calibrated in accordance with the manufacturer's recommendations, and is traceable to recognized national standards.

### 4.2. SAMPLE CALCULATION

Where relevant, the following sample calculation is provided:

$$\begin{aligned} \text{Field Strength (dBuV/m)} &= \text{Measured Voltage (dBuV)} + \text{Antenna Factor (dB/m)} + \\ &\text{Cable Loss (dB)} - \text{Preamp Gain (dB)} \\ 36.5 \text{ dBuV} + 18.7 \text{ dB/m} + 0.6 \text{ dB} - 26.9 \text{ dB} &= 28.9 \text{ dBuV/m} \end{aligned}$$

### 4.3. MEASUREMENT UNCERTAINTY

Where relevant, the following measurement uncertainty levels have been estimated for tests performed on the apparatus:

PARAMETER	UNCERTAINTY
Conducted Disturbance, 0.15 to 30 MHz	± 3.52 dB
Radiated Disturbance, 30 to 1000 MHz	± 4.94 dB
Radiated Disturbance, 1 to 6 GHz	± 3.86 dB
Radiated Disturbance, 6 to 18 GHz	± 4.23 dB
Radiated Disturbance, 18 to 26 GHz	± 5.30 dB
Radiated Disturbance, 26 to 40 GHz	± 5.23 dB

Uncertainty figures are valid to a confidence level of 95%.

## 5. DYNAMIC FREQUENCY SELECTION

### 5.1. OVERVIEW

#### 5.1.1. LIMITS

#### INDUSTRY CANADA

IC RSS-247 is closely harmonized with FCC Part 15 DFS rules. The deviations are as follows:

RSS-247 Issue 1

**Note:** For the band 5600–5650 MHz, no operation is permitted.

Until further notice, devices subject to this annex shall not be capable of transmitting in the band 5600–5650 MHz. This restriction is for the protection of Environment Canada weather radars operating in this band.

#### FCC

§15.407 (h), FCC KDB 905462 D02 “COMPLIANCE MEASUREMENT PROCEDURES FOR UNLICENSED-NATIONAL INFORMATION INFRASTRUCTURE DEVICES OPERATING IN THE 5250-5350 MHz AND 5470-5725 MHz BANDS INCORPORATING DYNAMIC FREQUENCY SELECTION” and KDB 905462 D03 “U-NII CLIENT DEVICES WITHOUT RADAR DETECTION CAPABILITY”.

**Table 1: Applicability of DFS requirements prior to use of a channel**

Requirement	Operational Mode		
	Master	Client (without radar detection)	Client (with radar detection)
Non-Occupancy Period	Yes	Not required	Yes
DFS Detection Threshold	Yes	Not required	Yes
Channel Availability Check Time	Yes	Not required	Not required
U-NII Detection Bandwidth	Yes	Not required	Yes

**Table 2: Applicability of DFS requirements during normal operation**

Requirement	Operational Mode		
	Master	Client (without DFS)	Client (with DFS)
DFS Detection Threshold	Yes	Not required	Yes
Channel Closing Transmission Time	Yes	Yes	Yes
Channel Move Time	Yes	Yes	Yes
U-NII Detection Bandwidth	Yes	Not required	Yes

Additional requirements for devices with multiple bandwidth modes	Master Device or Client with Radar DFS	Client (without DFS)
<i>U-NII Detection Bandwidth and Statistical Performance Check</i>	All BW modes must be tested	Not required
<i>Channel Move Time and Channel Closing Transmission Time</i>	Test using widest BW mode available	Test using the widest BW mode available for the link
<i>All other tests</i>	Any single BW mode	Not required
<b>Note:</b> Frequencies selected for statistical performance check (Section 7.8.4) should include several frequencies within the radar detection bandwidth and frequencies near the edge of the radar detection bandwidth. For 802.11 devices it is suggested to select frequencies in all 20 MHz channel blocks and a null frequency between the bonded 20 MHz channel blocks.		

**Table 3: Interference Threshold values, Master or Client incorporating In-Service Monitoring**

Maximum Transmit Power	Value (see notes)
E.I.R.P. $\geq$ 200 mill watt	-64 dBm
E.I.R.P. < 200 mill watt and power spectral density < 10 dBm/MHz	-62 dBm
E.I.R.P. < 200 mill watt that do not meet power spectral density requirement	-64 dBm
<p><b>Note 1:</b> This is the level at the input of the receiver assuming a 0 dBi receive antenna  <b>Note 2:</b> Throughout these test procedures an additional 1 dB has been added to the amplitude of the test transmission waveforms to account for variations in measurement equipment. This will ensure that the test signal is at or above the detection threshold level to trigger a DFS response.  <b>Note 3:</b> E.I.R.P. is based on the highest antenna gain. For MIMO devices refer to KDB publication 662911 D01.</p>	

**Table 4: DFS Response requirement values**

Parameter	Value
<i>Non-occupancy period</i>	30 minutes
<i>Channel Availability Check Time</i>	60 seconds
<i>Channel Move Time</i>	10 seconds (See Note 1)
<i>Channel Closing Transmission Time</i>	200 milliseconds + approx. 60 milliseconds over remaining 10 second period. (See Notes 1 and 2)
<i>U-NII Detection Bandwidth</i>	Minimum 100% of the U-NII 99% transmission power bandwidth. (See Note 3)
<p><b>Note 1:</b> <i>Channel Move Time</i> and the <i>Channel Closing Transmission Time</i> should be performed with Radar Type 0. The measurement timing begins at the end of the Radar Type 0 burst.  <b>Note 2:</b> The <i>Channel Closing Transmission Time</i> is comprised of 200 milliseconds starting at the beginning of the <i>Channel Move Time</i> plus any additional intermittent control signals required to facilitate a <i>Channel</i> move (an aggregate of 60 milliseconds) during the remainder of the 10 second period. The aggregate duration of control signals will not count quiet periods in between transmissions.  <b>Note 3:</b> During the <i>U-NII Detection Bandwidth</i> detection test, radar type 0 should be used. For each frequency step the minimum percentage of detection is 90 percent. Measurements are performed with no data traffic.</p>	



**Table 5 – Short Pulse Radar Test Waveforms**

Radar Type	Pulse Width (usec)	PRI (usec)	Pulses	Minimum Percentage of Successful Detection	Minimum Trials
0	1	1428	18	See Note 1	See Note 1
1	1	Test A: 15 unique PRI values randomly selected from the list of 23 PRI values in table 5a	Roundup: $\{(1/360) \times (19 \times 10^6 \text{ PRI}_{\text{usec}})\}$	60%	30
		Test B: 15 unique PRI values randomly selected within the range of 518-3066 usec. With a minimum increment of 1 usec, excluding PRI values selected in Test A			
2	1-5	150-230	23-29	60%	30
3	6-10	200-500	16-18	60%	30
4	11-20	200-500	12-16	60%	30
Aggregate (Radar Types 1-4)				80%	120
<b>Note 1:</b> Short Pulse Radar Type 0 should be used for the <i>Detection Bandwidth</i> test, <i>Channel Move Time</i> , and <i>Channel Closing Time</i> tests.					

**Table 6 – Long Pulse Radar Test Signal**

Radar Waveform Type	Pulse Width (µsec)	Chirp Width (MHz)	PRI (µsec)	Pulses per Burst	Number of Bursts	Minimum Percentage of Successful Detection	Minimum Trials
5	50-100	5-20	1000-2000	1-3	8-20	80%	30

**Table 7 – Frequency Hopping Radar Test Signal**

Radar Waveform Type	Pulse Width (µsec)	PRI (µsec)	Pulses per Hop	Hopping Rate (kHz)	Hopping Sequence Length (msec)	Minimum Percentage of Successful Detection	Minimum Trials
6	1	333	9	0.333	300	70%	30

### 5.1.2. TEST AND MEASUREMENT SYSTEM

#### CONDUCTED METHOD SYSTEM BLOCK DIAGRAM

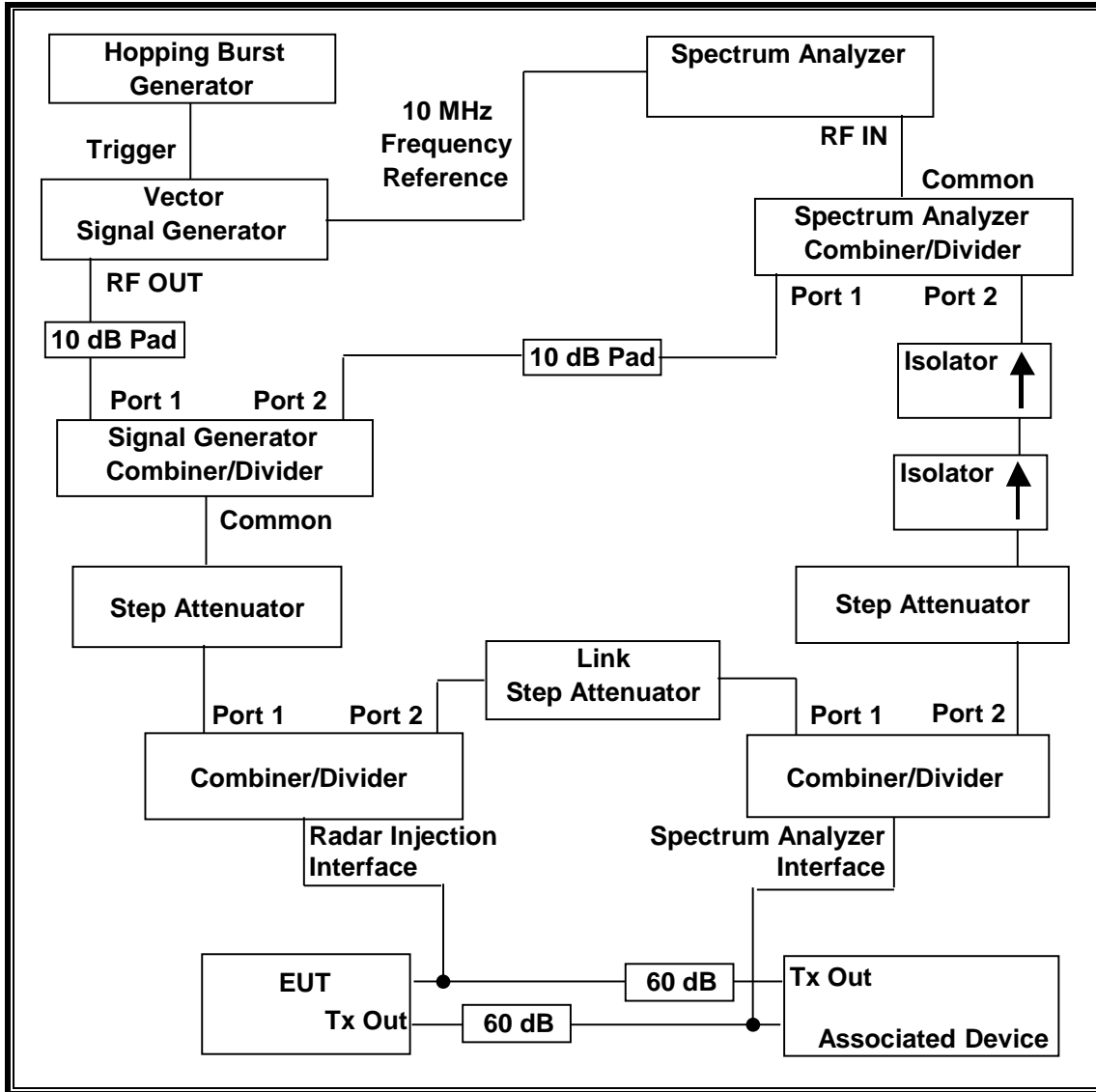

## **SYSTEM OVERVIEW**

The short pulse and long pulse signal generating system utilizes the NTIA software. The Vector Signal Generator has been validated by the NTIA. The hopping signal generating system utilizes the CCS simulated hopping method and system, which has been validated by the DoD, FCC and NTIA. The software selects waveform parameters from within the bounds of the signal type on a random basis using uniform distribution.

The short pulse types 1, 2, 3 and 4, and the long pulse type 5 parameters are randomized at run-time.

The hopping type 6 pulse parameters are fixed while the hopping sequence is based on the August 2005 NTIA Hopping Frequency List. The initial starting point randomized at run-time and each subsequent starting point is incremented by 475. Each frequency in the 100-length segment is compared to the boundaries of the EUT Detection Bandwidth and the software creates a hopping burst pattern in accordance with Section 7.4.1.3 Method #2 Simulated Frequency Hopping Radar Waveform Generating Subsystem of KDB 905462 D02. The frequency of the signal generator is incremented in 1 MHz steps from  $F_L$  to  $F_H$  for each successive trial. This incremental sequence is repeated as required to generate a minimum of 30 total trials and to maintain a uniform frequency distribution over the entire Detection Bandwidth.

The signal monitoring equipment consists of a spectrum analyzer. The aggregate ON time is calculated by multiplying the number of bins above a threshold during a particular observation period by the dwell time per bin, with the analyzer set to peak detection and max hold.

Should multiple RF ports be utilized for the Master and/or Slave devices (for example, for diversity or MIMO implementations), additional combiner/dividers are inserted between the Master Combiner/Divider and the pad connected to the Master Device (and/or between the Slave Combiner/Divider and the pad connected to the Slave Device). Additional pads may be utilized such that there is one pad at each RF port on each EUT.

## **SYSTEM CALIBRATION**

A 50-ohm load is connected in place of the spectrum analyzer, and the spectrum analyzer is connected in place of the master device. The signal generator is set to CW mode. The amplitude of the signal generator is adjusted to yield a level of  $-64$  dBm as measured on the spectrum analyzer.

Without changing any of the instrument settings, the spectrum analyzer is reconnected to the Common port of the Spectrum Analyzer Combiner/Divider. The Reference Level Offset of the spectrum analyzer is adjusted so that the displayed amplitude of the signal is  $-64$  dBm.

The spectrum analyzer displays the level of the signal generator as received at the antenna ports of the Master Device. The interference detection threshold may be varied from the calibrated value of  $-64$  dBm and the spectrum analyzer will still indicate the level as received by the Master Device.

**ADJUSTMENT OF DISPLAYED TRAFFIC LEVEL**

A link is established between the Master and Slave and the Link Step Attenuator between the units is adjusted as needed to provide a suitable received level at the Master and Slave devices. The video test file is streamed to generate WLAN traffic. The WLAN traffic level, as displayed on the spectrum analyzer, is confirmed to be at lower amplitude than the radar detection threshold and is confirmed to be the Radar Detection Device rather than the associated device. If a different setting of the Master Step Attenuator is required to meet the above conditions, a new System Calibration is performed for the new Master Step Attenuator setting.

**TEST AND MEASUREMENT EQUIPMENT**

The following test and measurement equipment was utilized for the DFS tests documented in this report:

<b>TEST EQUIPMENT LIST</b>				
<b>Description</b>	<b>Manufacturer</b>	<b>Model</b>	<b>Serial Number</b>	<b>Cal Due</b>
Spectrum Analyzer, PXA, 3Hz to 44GHz	Keysight	N9030A	US51350187	06/13/17
Signal Generator, MXG X-Series RF Vector	Agilent	N5182B	MY51350337	03/11/17
Arbitrary Waveform Generator	Agilent / HP	33220A	MY44037572	04/11/17

**5.1.3. TEST AND MEASUREMENT SOFTWARE**

The following test and measurement software was utilized for the tests documented in this report:

<b>TEST SOFTWARE LIST</b>		
<b>Name</b>	<b>Version</b>	<b>Test / Function</b>
Aggregate Time-PXA	3.0	Channel Loading and Aggregate Closing Time
FCC 2014 Detection Bandwidth-PXA	3.0	Detection Bandwidth in 5 MHz Steps
In Service Monitoring-PXA	3.0	In-Service Monitoring (Probability of Detection)
PXA Read	3.0.0.9	Signal Generator Screen Capture
SGXProject.exe	1.7	Radar Waveform Generation and Download

### 5.1.4. SETUP OF EUT

#### CONDUCTED METHOD EUT TEST SETUP

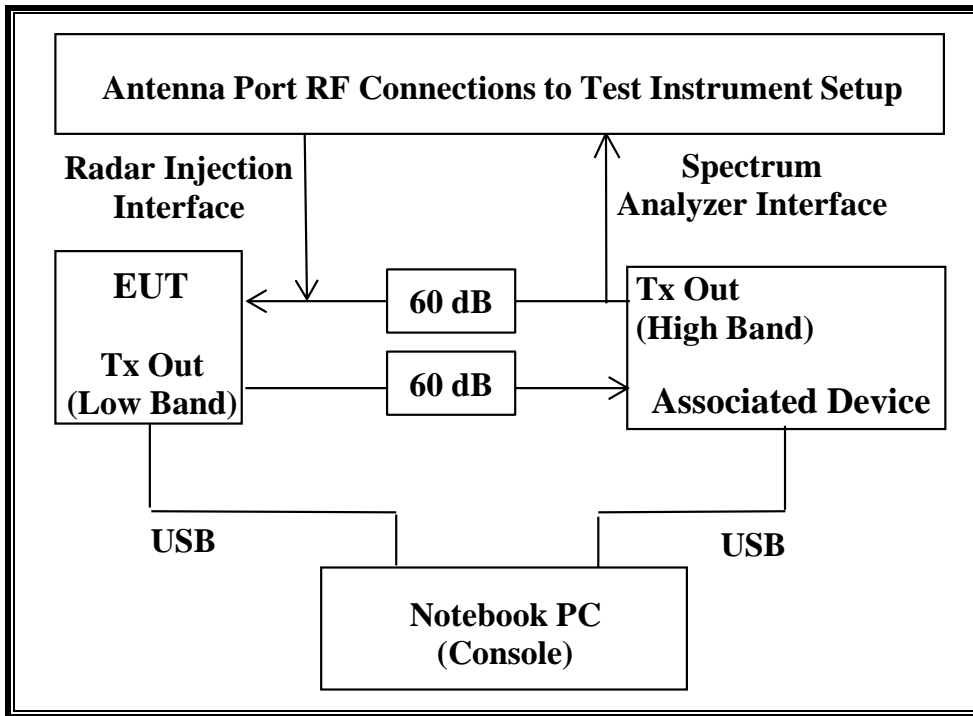

#### SUPPORT EQUIPMENT

The following support equipment was utilized for the DFS tests documented in this report:

PERIPHERAL SUPPORT EQUIPMENT LIST				
Description	Manufacturer	Model	Serial Number	FCC ID
AC Adapter (EUT)	Hon-Kwang	HK-AX-120A250-US	E70023138	DoC
Cel-Fi DUO Smart Cellular Signal Booster (Associated Device)	Nextivity	D32-2/4CU	9.05432E+11	YETD24CU
AC Adapter (Associated Device)	Hon-Kwang	HK-AB-120A250-US	E50006725	Doc
Notebook PC (Console)	Dell	PP18L	7F7CDF1	Doc
AC Adapter (Notebook PC)	Lite On Technology	PA-1900-02D	CN-09T215-71615-4CB-7655	Doc

### 5.1.5. DESCRIPTION OF EUT

For FCC DFS bands, the EUT operates over the 5250-5350 MHz and 5470-5725 MHz ranges, excluding the 5600-5650 MHz range. However, the EUT only transmits over the 5250-5350 MHz range. The EUT also support other non-DFS frequency bands, and those bands are listed in the RF reports.

The EUT is a Master Device.

The highest power level within these bands is less than 23 dBm EIRP in the 5470-5725 MHz band per EMC report (dated April 22, 2014) of the original grant.

The highest gain antenna assembly utilized with the EUT has a gain of 2 dBi in the 5250-5350 MHz band and 2 dBi in the 5470-5725 MHz band. The lowest gain antenna assembly utilized with the EUT has a gain of 2 dBi in the 5250-5350 MHz band and 2 dBi in the 5470-5725 MHz band.

The EUT was tested with a client declared minimum gain of 2 dBi in the 5250-5350 MHz band and 2 dBi the 5470-5725 MHz band.

The rated output power of the Master unit is < 23dBm (EIRP). Therefore the required interference threshold level is -62 dBm. After correction for antenna gain and procedural adjustments, the required conducted threshold at the antenna port is  $-62 + 2 + 1 = -59$  dBm.

The calibrated conducted DFS Detection Threshold level is set to -60 dBm. The tested level is lower than the required level hence it provides a margin to the limit.

During normal operation after a successful CAC has been performed the EUT uses one transmitter chain in the 5250-5350 MHz band and one receive chain in the 5470-5725 MHz band, each connected to a 50-ohm coaxial antenna port. All antenna ports are connected to the test system via a power divider to perform conducted tests.

The secondary Master device associated with the EUT during these tests has radar detection capability.

The EUT is a proprietary frame-based system. EUT system traffic was tested while running at a channel loading rate of 100%.

TPC is not required since the maximum EIRP is less than 500 mW (27 dBm).

The EUT utilizes a proprietary frame-based architecture. Two nominal channel bandwidths are implemented: 30 MHz and 40 MHz.

The software installed in the EUT is revision 5.1.130.

### **UNIFORM CHANNEL SPREADING**

This function is not required per KDB 905462.

### **OVERVIEW OF MASTER DEVICE WITH RESPECT TO §15.407 (h) REQUIREMENTS**

The Master Device is a Nextivity Access Point, FCC ID: YETD24NU. The minimum antenna gain for the Master Device is 2 dBi.

The rated output power of the Master unit is < 23dBm (EIRP). Therefore the required interference threshold level is -62 dBm. After correction for antenna gain and procedural adjustments, the required conducted threshold at the antenna port is  $-62 + 2 + 1 = -59$  dBm.

The calibrated conducted DFS Detection Threshold level is set to -60 dBm. The tested level is lower than the required level hence it provides a margin to the limit.

## 5.2. THEORY OF OPERATION

### 5.2.1. TECHNICAL DESCRIPTION

The Equipment Under Test (EUT) was a Nextivity Inc. Cel-Fi DUO Smart Cellular Signal Booster. The EUT is a signal booster for indoor residential, small business and small enterprise use. It consists of two units: the D32-2/4NU Network Unit (NU), and the D32-2/4CU Coverage Unit (CU). The NU and CU are shipped and sold as one unit. The NU is the primary Master device for the system and performs all CAC functions for both units. The CU does not perform a CAC and relies on the NU for authorization to commence transmissions. Both devices are programmed to only operate and connect to its factory-mated counterpart. The NU transmits and receives Cellular signals from the base station and operates similar to a cellular handset. The CU transmits and receives signals with the cellular handset and operates on frequencies similar to the cellular base station. The NU and CU are connected wirelessly over a full-duplex wireless link in the UNII band using a mixed OFDM and muxed cellular signal over a 30 or 40 MHz channel in each direction. The CU also includes Bluetooth LE connectivity.

### 5.2.2. CHANNEL MAPPING

During normal operation the NU and CU transmit signals on one UNII sub-band and receive signals on the other UNII sub-band. Therefore compliance to CAC, Channel Move/Closing Time, Occupied Bandwidth and Non-Occupancy tests are shown through indirect monitoring of the associated factory-mated counterpart device.

#### NETWORK UNIT

The NU is only capable of transmitting on the following frequencies and therefore the CU is only capable of receiving on the same frequencies during normal operation:

Device	Bands (MHz)	TX Frequency (MHz)	Output Power (dBm)	DFS
NU	5150-5250 [UNII 1]	5210	21	Support (not required by the FCC)
		5220		
		5230		
		5240		
		5250		
	5250-5350 [UNII 2A]	5260	21	Yes
		5270		
		5280		
		5290		



**COVERAGE UNIT**

The CU is only capable of transmitting on the following frequencies and therefore the NU is only capable of receiving on the same frequencies during normal operation:

CU	5470-5725 [UNII 2C]	5520	21	Yes
		5530		
		5540		
		5550		
		5560		
		5570		
		5580		
		5590		
		5600		
		5610		
		5620		
		5630		
		5640		
		5650		
	5660			
	5725-5850 [UNII 3]	5715	21	Support (not required by the FCC)
		5725		
		5735		
		5745		
		5755		
		5765		
5775				
5785				
5795				
5805				
5815				
5825				

**Note:** Frequencies that overlap or reside within the 5600-5650 MHz TDWR weather band are not supported and shown in red.

### 5.3. TEST CHANNEL

All tests were performed at a channel center frequency of 5540 MHz.

### 5.4. RADAR WAVEFORMS

#### RADAR WAVEFORMS

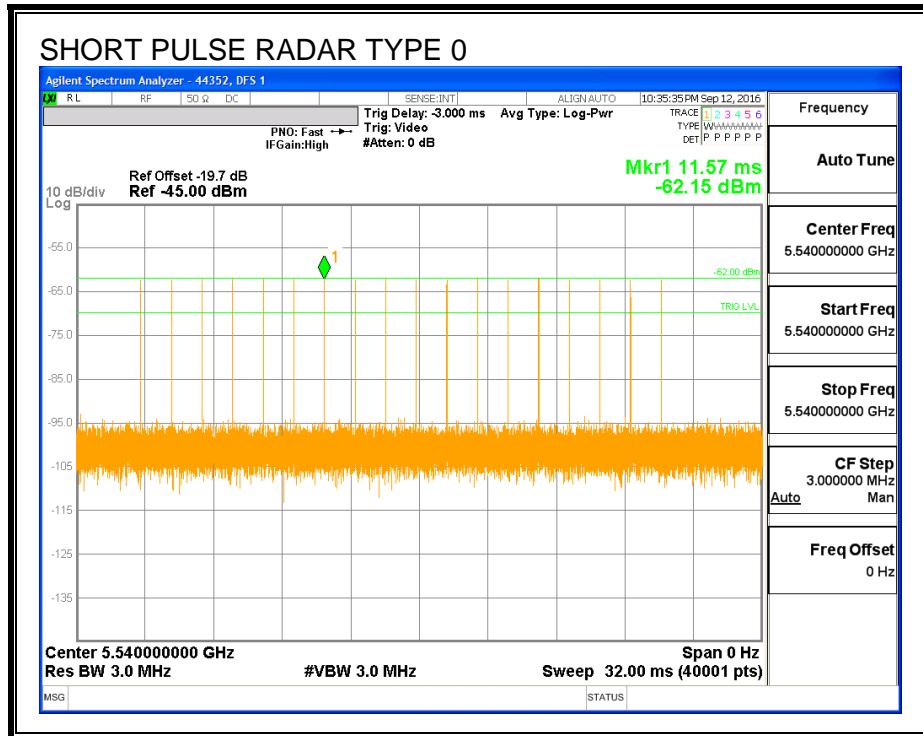

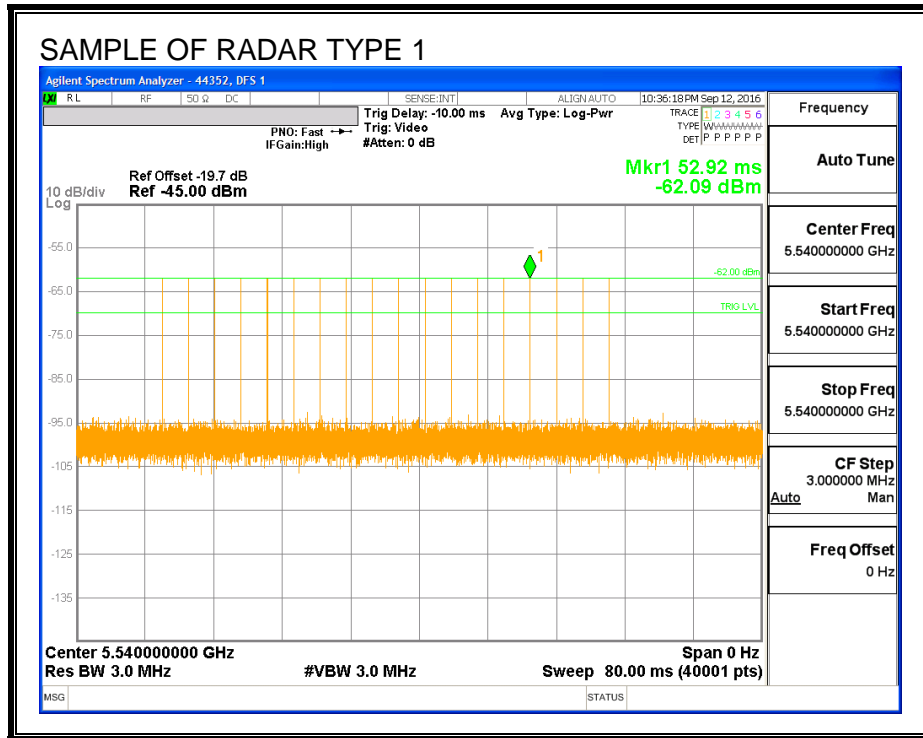

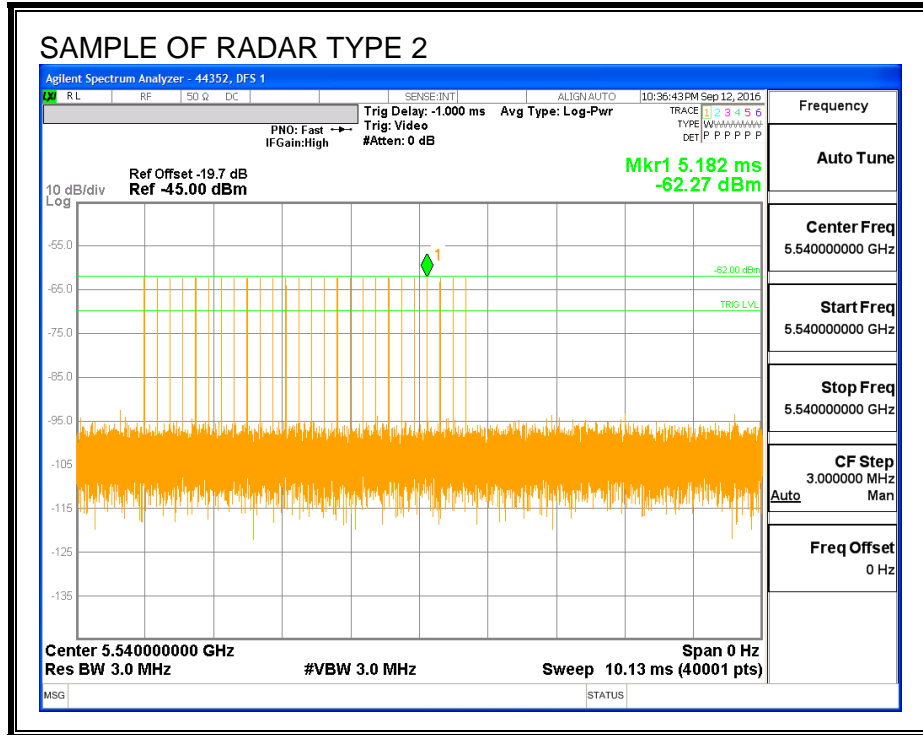

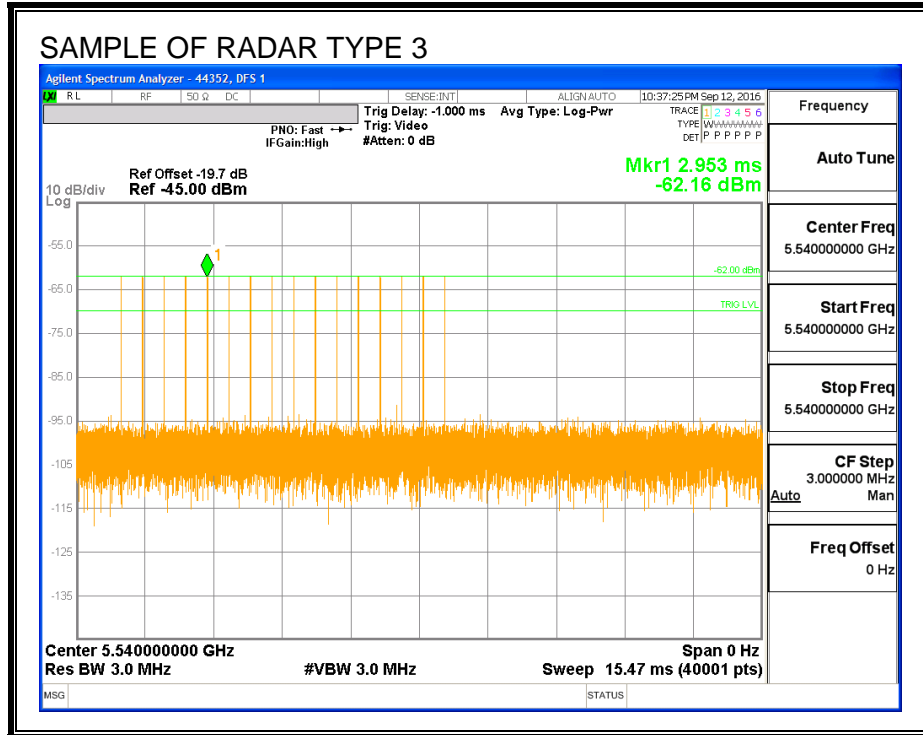

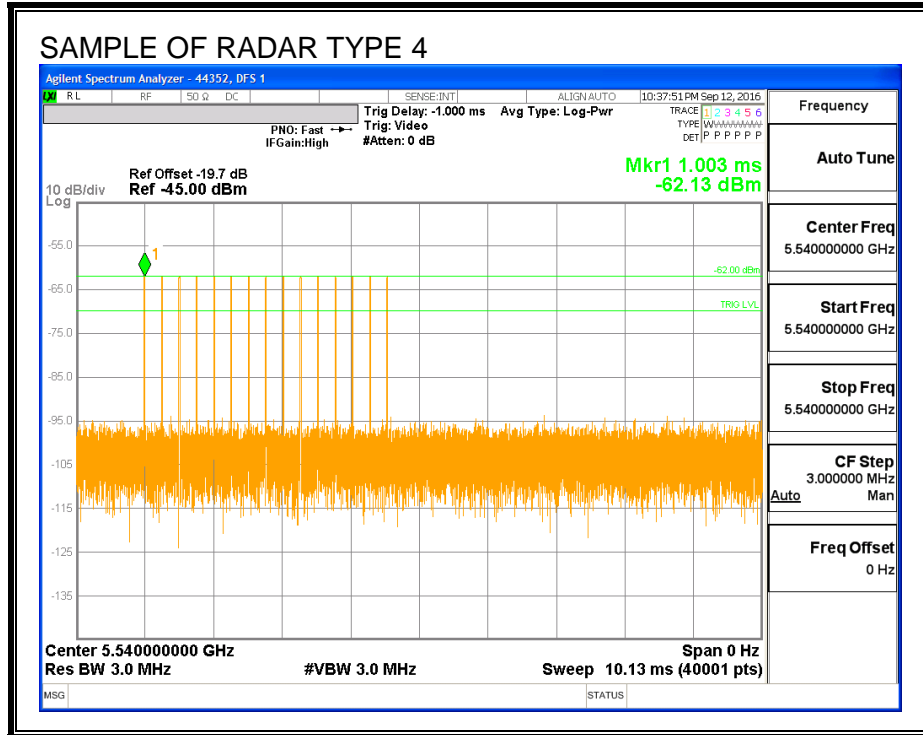

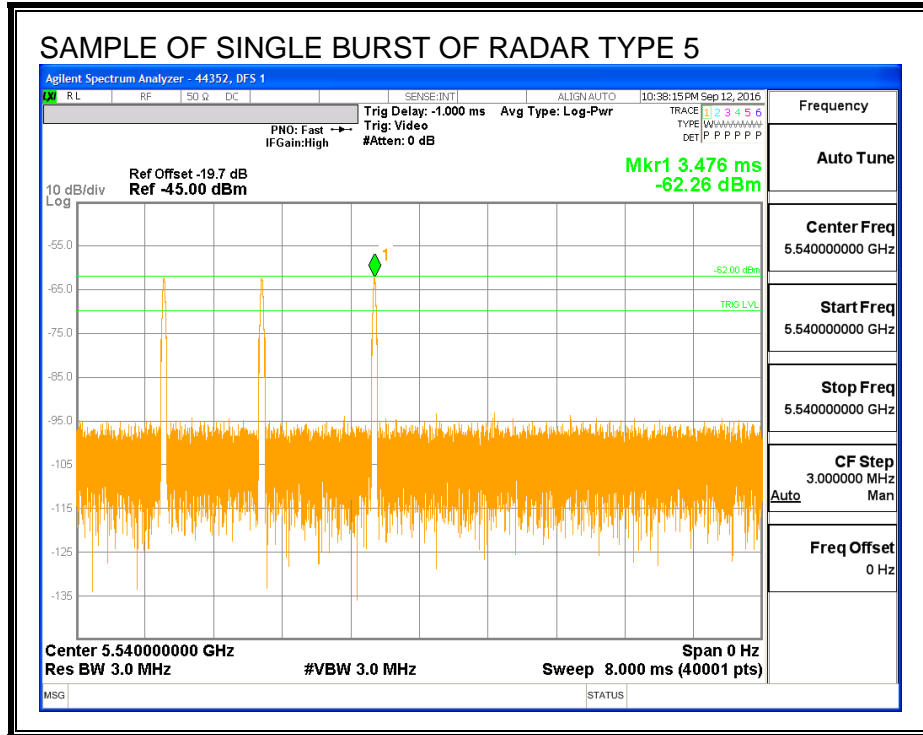

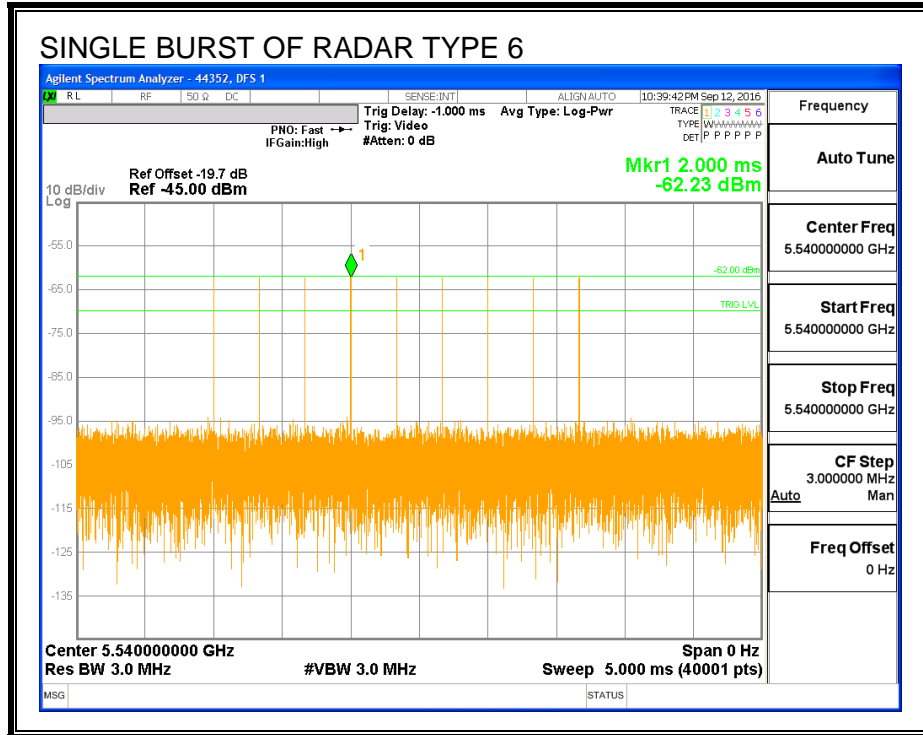



## 5.5. RESULTS FOR 30 MHz BANDWIDTH

### 5.5.1. TRAFFIC AND CHANNEL LOADING

#### TRAFFIC

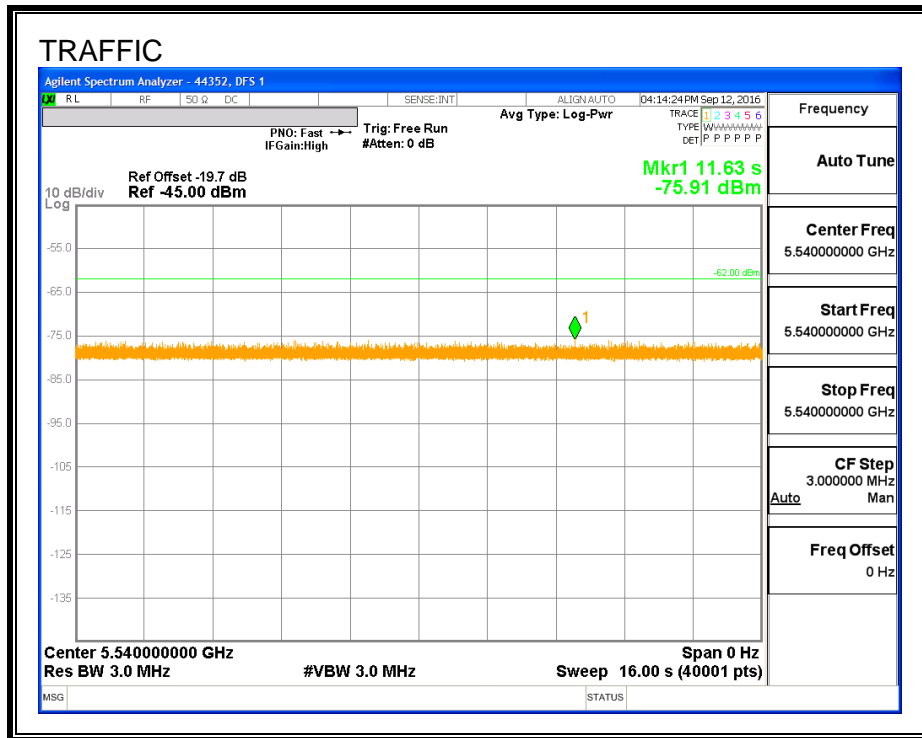

**CHANNEL LOADING**

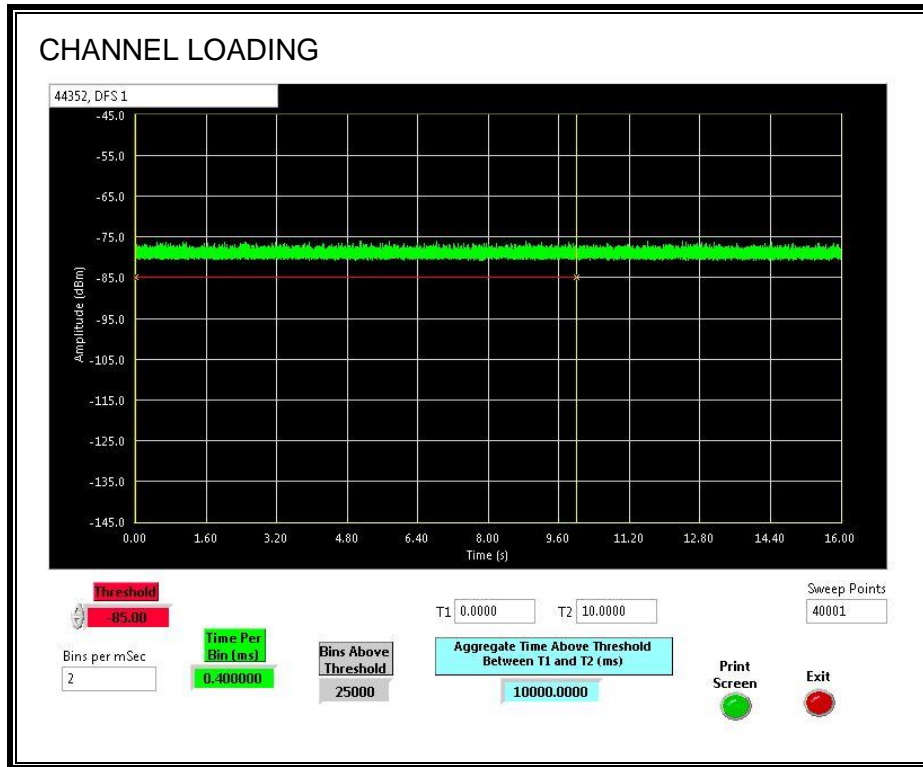

The level of traffic loading on the channel by the EUT is 100%

## **5.5.2. CHANNEL AVAILABILITY CHECK TIME**

### **PROCEDURE TO DETERMINE INITIAL POWER-UP CYCLE TIME**

A link was established on channel then a software command was issued to the EUT to generate a CAC period on the channel. The time from the cessation of traffic to the re-initialization of traffic was measured as the time required for the EUT to complete the total cycle. The time to complete the initial processing period is 60 seconds less than this total time.

### **PROCEDURE FOR TIMING OF RADAR BURST**

With a link established on channel, a software command was issued to the EUT to generate a CAC period on the channel. A radar signal was triggered within 0 to 6 seconds after the initial processing period, and transmissions on the channel were monitored on the spectrum analyzer.

The Non-Occupancy list was cleared. With a link established on channel, a software command was issued to the EUT to generate a CAC period on the channel. A radar signal was triggered within 54 to 60 seconds after the initial processing period, and transmissions on the channel were monitored on the spectrum analyzer.

**QUANTITATIVE RESULTS**

**No Radar Triggered**

Timing of S/W Command (sec)	Timing of Start of Traffic (sec)	Total Cycle Time (sec)	Processing Period Time (sec)
31.04	103.2	72.2	12.2

**Radar Near Beginning of CAC**

Timing of S/W Command (sec)	Timing of Radar Burst (sec)	Radar Relative to Command (sec)	Radar Relative to Start of CAC (sec)
30.96	44.7	13.8	1.6

**Radar Near End of CAC**

Timing of S/W Command (sec)	Timing of Radar Burst (sec)	Radar Relative to Command (sec)	Radar Relative to Start of CAC (sec)
30.92	102.4	71.5	59.3

**QUALITATIVE RESULTS**

Timing of Radar Burst	Display on Control Computer	Spectrum Analyzer Display
No Radar Triggered	EUT marks Channel as active	Transmissions begin on channel after completion of the initial processing period and the CAC
Within 0 to 6 second window	EUT indicates radar detected	No transmissions on channel
Within 54 to 60 second window	EUT indicates radar detected	No transmissions on channel

**TIMING WITHOUT RADAR DURING CAC**

Issue Software Command  
 Traffic ceases  
 Begin Processing Period

End of Processing Period  
 Start of CAC

End of CAC  
 Traffic is Initiated

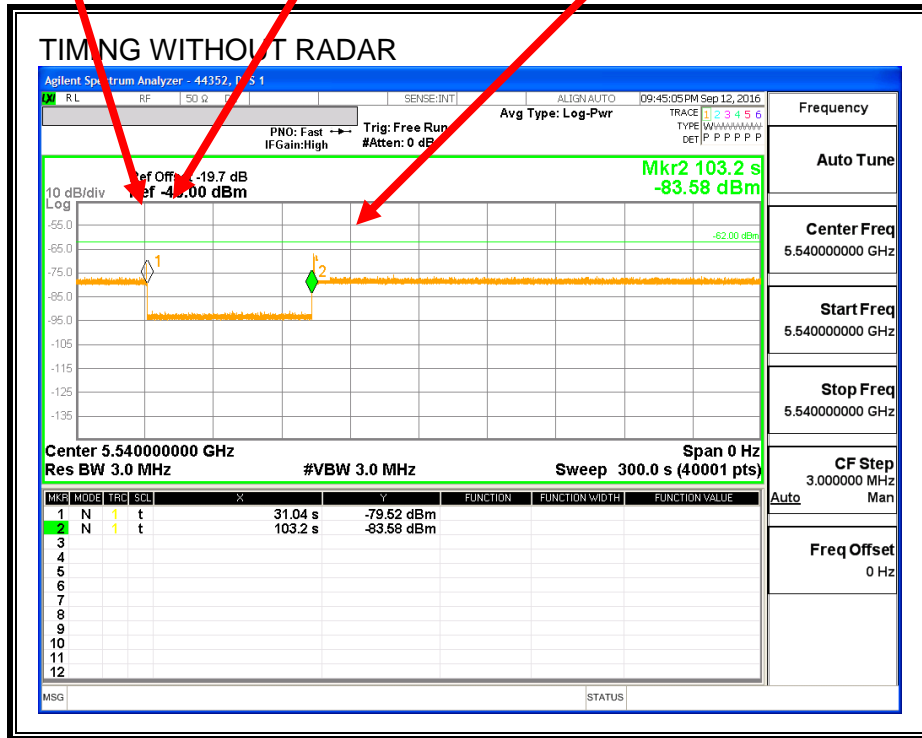

Transmissions begin on channel after completion of the initial processing period and CAC.

**TIMING WITH RADAR NEAR BEGINNING OF CAC**

Issue Software Command  
 Traffic ceases  
 Begin Processing Period

End of Processing Period  
 Start of CAC

Radar Signal Applied

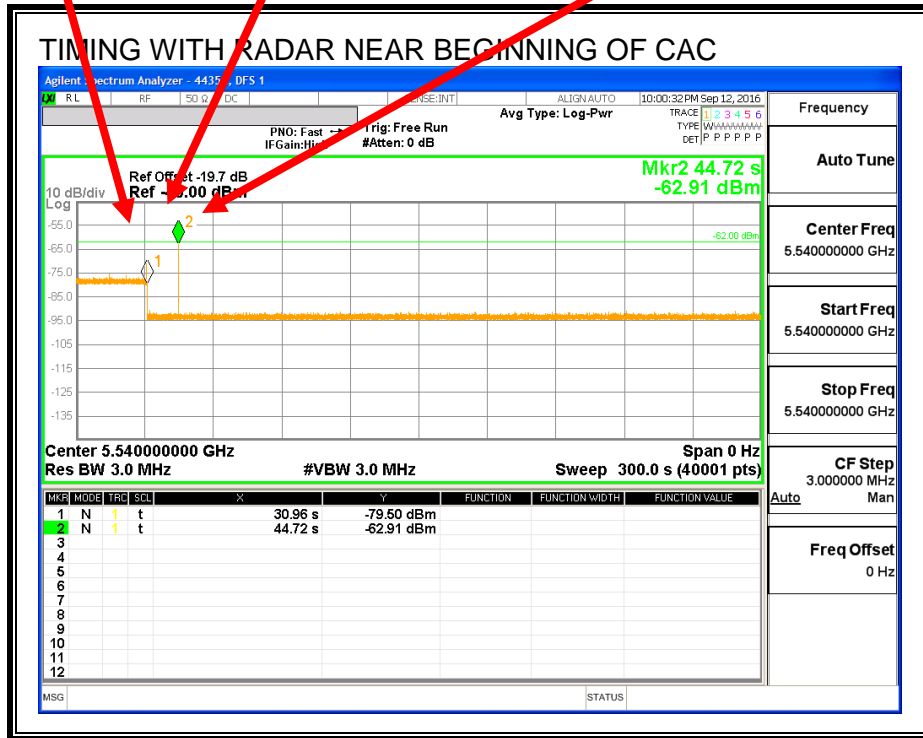

No EUT transmissions were observed after the radar signal.

**TIMING WITH RADAR NEAR END OF CAC**

Issue Software Command  
 Traffic ceases  
 Begin Processing Period

End of Processing Period  
 Start of CAC

Radar Signal Applied

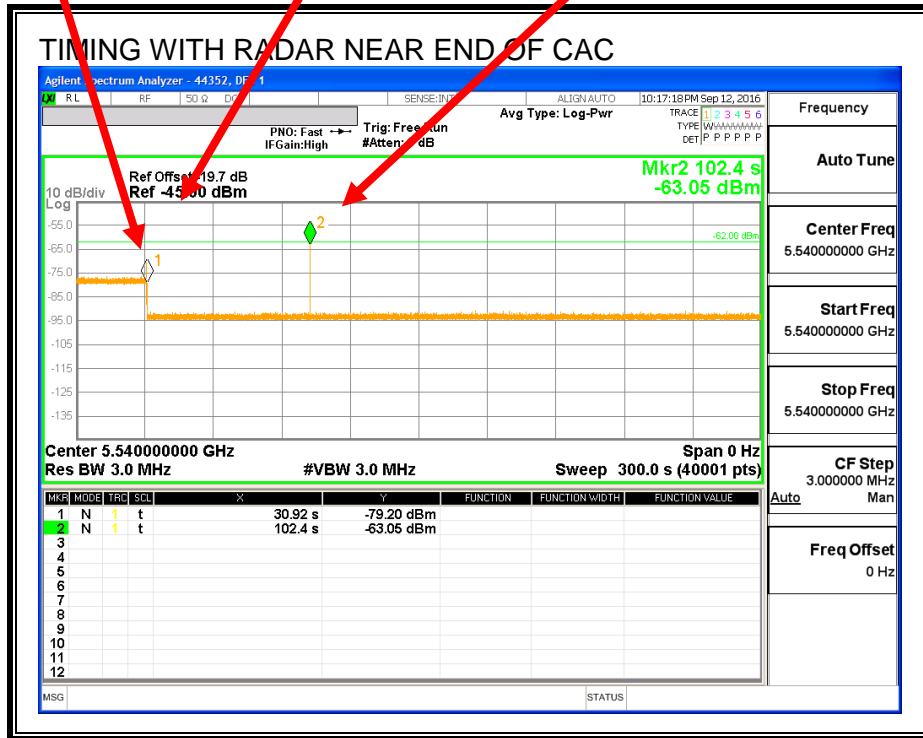

No EUT transmissions were observed after the radar signal.

### 5.5.3. OVERLAPPING CHANNEL TESTS

#### RESULTS

##### **Per Manufacture's Declaration:**

To eliminate the possibility of overlapping channels, the EUT software automatically restricts access to a block of 30 MHz on either side of the center of the operating channel when radar is detected.

### 5.5.4. MOVE AND CLOSING TIME

#### REPORTING NOTES

The reference marker is set at the end of last radar pulse.

The delta marker is set at the end of the last WLAN transmission following the radar pulse. This delta is the channel move time.

The aggregate channel closing transmission time is calculated as follows:

Aggregate Transmission Time =  
(Number of analyzer bins showing transmission) \* (dwell time per bin)

The observation period over which the aggregate time is calculated begins at (Reference Marker + 200 msec) and ends no earlier than (Reference Marker + 10 sec).

#### RESULTS

<b>Channel Move Time (sec)</b>	<b>Limit (sec)</b>
<b>0.154</b>	<b>10</b>

<b>Aggregate Channel Closing Transmission Time (msec)</b>	<b>Limit (msec)</b>
<b>0.0</b>	<b>60</b>



**MOVE TIME**

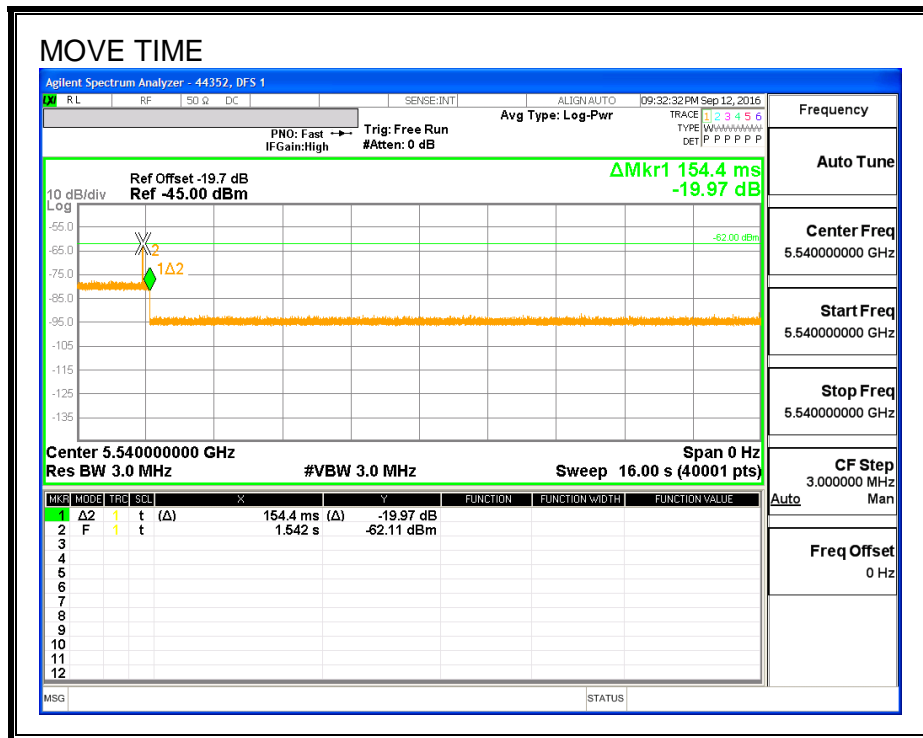

**CHANNEL CLOSING TIME**

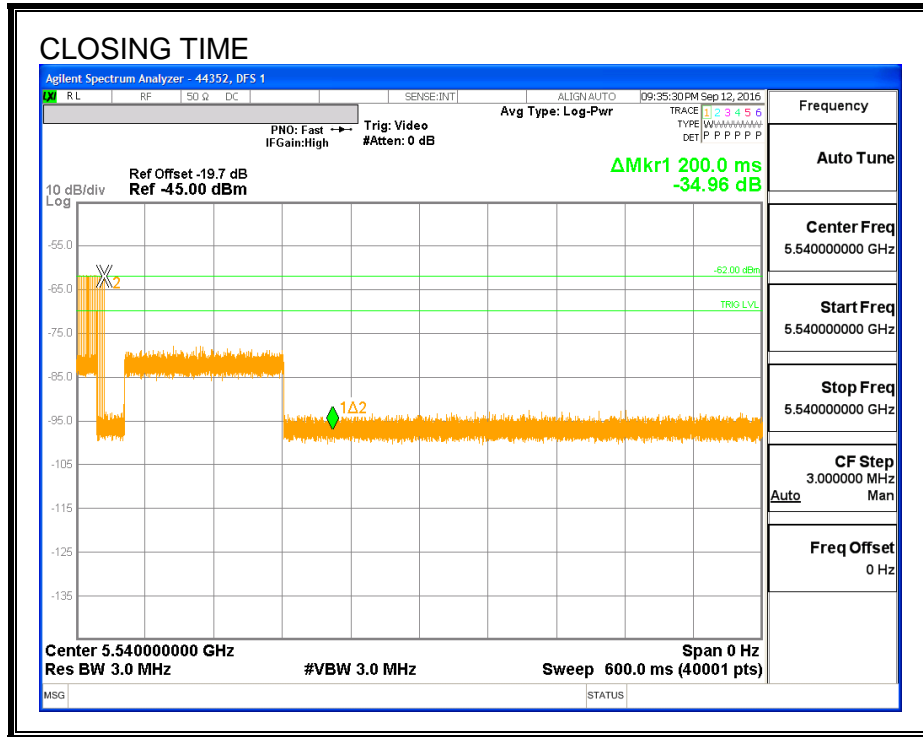

**AGGREGATE CHANNEL CLOSING TRANSMISSION TIME**

No transmissions are observed during the aggregate monitoring period.

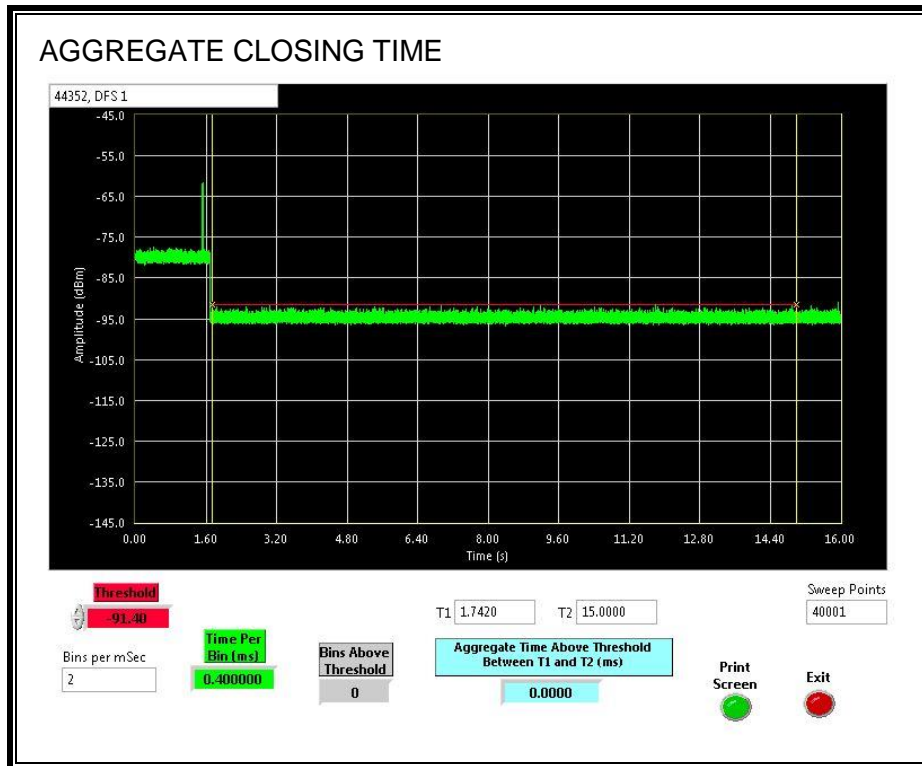

**LONG PULSE CHANNEL MOVE TIME**

The traffic ceases prior to 10 seconds after the end of the radar waveform.

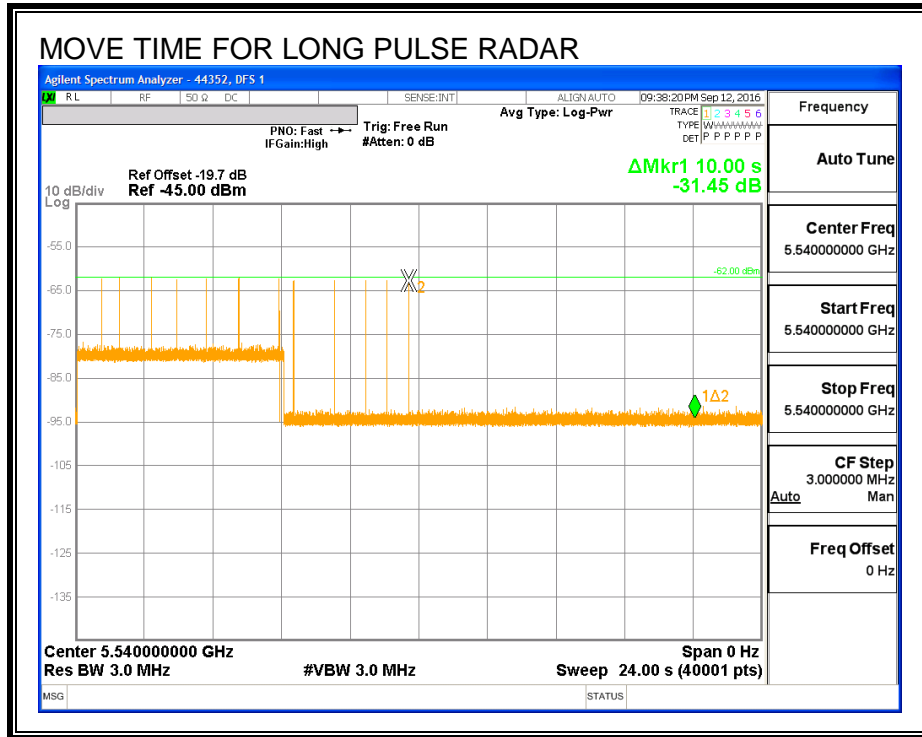

### 5.5.5. DETECTION BANDWIDTH

#### REFERENCE PLOT OF 99% POWER BANDWIDTH

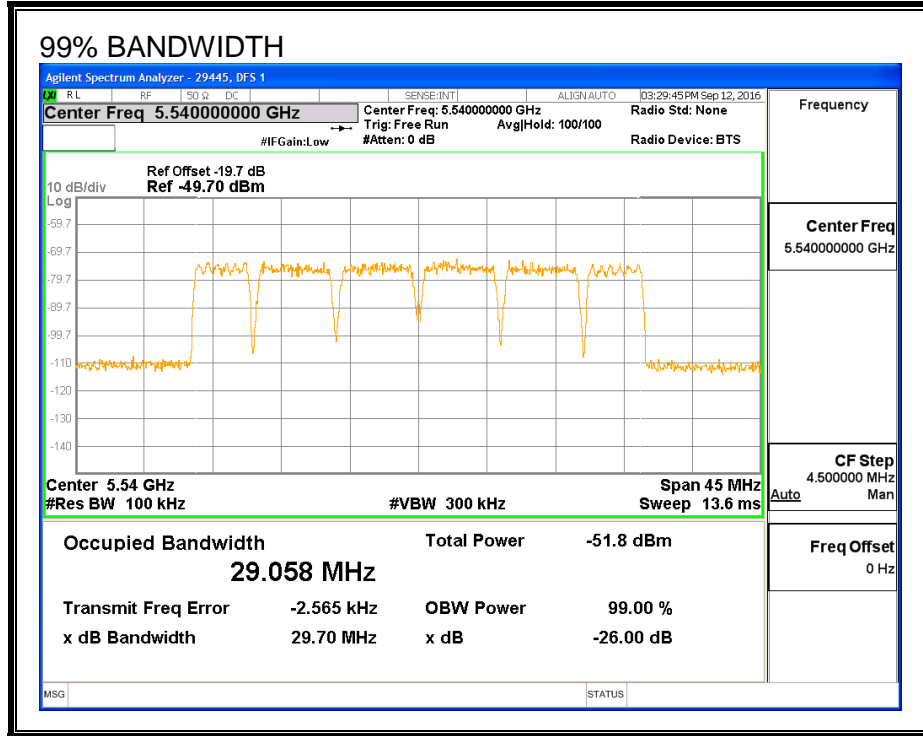

#### RESULTS

FL	FH	Detection Bandwidth	99% Power Bandwidth	Ratio of Detection BW to 99% Power BW	Minimum Limit
(MHz)	(MHz)	(MHz)	(MHz)	(%)	(%)
5525	5555	30	29.058	103.2	100

**DETECTION BANDWIDTH PROBABILITY**

<b>DETECTION BANDWIDTH PROBABILITY RESULTS</b>				
<b>Detection Bandwidth Test Results</b>		<b>29445</b>	<b>DFS 1</b>	
<b>FCC Type 0 Waveform: 1 us Pulse Width, 1428 us PRI, 18 Pulses per Burst</b>				
<b>Frequency (MHz)</b>	<b>Number of Trials</b>	<b>Number Detected</b>	<b>Detection (%)</b>	<b>Mark</b>
5525	10	10	100	FL
5530	10	10	100	
5535	10	9	90	
5540	10	10	100	
5545	10	10	100	
5550	10	10	100	
5555	10	10	100	FH

### 5.5.6. IN-SERVICE MONITORING

#### RESULTS

FCC Radar Test Summary												
Signal Type	Number of Trials	Detection (%)	Limit (%)	Pass/Fail	Detection Bandwidth		80% of Det BW		OBW	Test Location	Employee Number	In-Service Monitoring Version
					FL	FH	FL5	FH5				
FCC Short Pulse Type 1	30	100.00	60	Pass	5525	5555			29.06	DFS 1	44352	Version 3.0
FCC Short Pulse Type 2	30	100.00	60	Pass	5525	5555			29.06	DFS 1	44352	Version 3.0
FCC Short Pulse Type 3	30	100.00	60	Pass	5525	5555			29.06	DFS 1	44352	Version 3.0
FCC Short Pulse Type 4	30	80.00	60	Pass	5525	5555			29.06	DFS 1	44352	Version 3.0
Aggregate		95.00	80	Pass								
FCC Long Pulse Type 5	30	90.00	80	Pass	5525	5555	5528	5552	29.06	DFS 1	44352	Version 3.0
FCC Hopping Type 6	31	100.00	70	Pass	5525	5555				DFS 1	44352	Version 3.0

**TYPE 1 DETECTION PROBABILITY**

Data Sheet for FCC Short Pulse Radar Type 1						
Waveform	Pulse Width (us)	PRI (us)	Pulses Per Burst	Test (A/B)	Frequency (MHz)	Successful Detection (Yes/No)
1001	1	3066	18	A	5540	Yes
1002	1	718	74	A	5540	Yes
1003	1	818	65	A	5540	Yes
1004	1	518	102	A	5540	Yes
1005	1	638	83	A	5540	Yes
1006	1	618	86	A	5540	Yes
1007	1	758	70	A	5540	Yes
1008	1	698	76	A	5540	Yes
1009	1	538	99	A	5540	Yes
1010	1	778	68	A	5540	Yes
1011	1	878	61	A	5540	Yes
1012	1	838	63	A	5540	Yes
1013	1	678	78	A	5540	Yes
1014	1	558	95	A	5540	Yes
1015	1	738	72	A	5540	Yes
1016	1	706	75	B	5540	Yes
1017	1	597	89	B	5540	Yes
1018	1	2165	25	B	5540	Yes
1019	1	2186	25	B	5540	Yes
1020	1	1335	40	B	5540	Yes
1021	1	2839	19	B	5540	Yes
1022	1	923	58	B	5540	Yes
1023	1	2556	21	B	5540	Yes
1024	1	771	69	B	5540	Yes
1025	1	2533	21	B	5540	Yes
1026	1	2230	24	B	5540	Yes
1027	1	1733	31	B	5540	Yes
1028	1	1559	34	B	5540	Yes
1029	1	2386	23	B	5540	Yes
1030	1	2342	23	B	5540	Yes



**TYPE 2 DETECTION PROBABILITY**

Data Sheet for FCC Short Pulse Radar Type 2					
Waveform	Pulse Width (us)	PRI (us)	Pulses Per Burst	Frequency (MHz)	Successful Detection (Yes/No)
2001	2.9	190	26	5540	Yes
2002	1.3	156	24	5540	Yes
2003	4.5	197	24	5540	Yes
2004	3.1	210	23	5540	Yes
2005	4.7	217	24	5540	Yes
2006	1.5	154	27	5540	Yes
2007	3.3	203	24	5540	Yes
2008	4.5	186	27	5540	Yes
2009	2.3	201	25	5540	Yes
2010	1.8	189	29	5540	Yes
2011	4	208	23	5540	Yes
2012	3.7	200	24	5540	Yes
2013	2	185	26	5540	Yes
2014	4	181	27	5540	Yes
2015	4.7	171	26	5540	Yes
2016	2.9	214	28	5540	Yes
2017	3.7	208	27	5540	Yes
2018	2.1	217	26	5540	Yes
2019	1.3	214	26	5540	Yes
2020	4	228	25	5540	Yes
2021	3.4	192	28	5540	Yes
2022	2.4	209	25	5540	Yes
2023	2	220	29	5540	Yes
2024	3.2	160	25	5540	Yes
2025	1.1	176	23	5540	Yes
2026	4.6	163	26	5540	Yes
2027	2.7	183	25	5540	Yes
2028	2.4	174	29	5540	Yes
2029	4.8	160	24	5540	Yes
2030	2.7	156	25	5540	Yes

**TYPE 3 DETECTION PROBABILITY**

Data Sheet for FCC Short Pulse Radar Type 3					
Waveform	Pulse Width (us)	PRI (us)	Pulses Per Burst	Frequency (MHz)	Successful Detection (Yes/No)
3001	8	487	16	5540	Yes
3002	5.7	369	17	5540	Yes
3003	6.8	350	17	5540	Yes
3004	9.9	378	16	5540	Yes
3005	8.9	371	17	5540	Yes
3006	9.8	412	17	5540	Yes
3007	6.3	301	17	5540	Yes
3008	5.2	354	18	5540	Yes
3009	9.7	389	17	5540	Yes
3010	6.1	455	16	5540	Yes
3011	8.6	251	18	5540	Yes
3012	7.9	464	18	5540	Yes
3013	5.5	273	18	5540	Yes
3014	5.1	498	17	5540	Yes
3015	8.1	453	17	5540	Yes
3016	5.6	440	16	5540	Yes
3017	6.4	408	18	5540	Yes
3018	9.2	290	16	5540	Yes
3019	5.2	404	17	5540	Yes
3020	8.3	299	18	5540	Yes
3021	7.3	425	17	5540	Yes
3022	8.2	333	16	5540	Yes
3023	7.4	472	18	5540	Yes
3024	8.6	275	17	5540	Yes
3025	8.1	309	18	5540	Yes
3026	9.9	258	16	5540	Yes
3027	9.7	305	17	5540	Yes
3028	9	267	16	5540	Yes
3029	6.6	327	16	5540	Yes
3030	6.2	301	18	5540	Yes

**TYPE 4 DETECTION PROBABILITY**

Data Sheet for FCC Short Pulse Radar Type 4					
Waveform	Pulse Width (us)	PRI (us)	Pulses Per Burst	Frequency (MHz)	Successful Detection (Yes/No)
4001	13.6	256	15	5540	No
4002	13.3	494	13	5540	Yes
4003	15	462	12	5540	Yes
4004	10.5	344	16	5540	Yes
4005	12.6	458	15	5540	Yes
4006	14	352	12	5540	No
4007	16.7	479	14	5540	Yes
4008	18.6	387	14	5540	No
4009	17	275	16	5540	Yes
4010	19.4	462	16	5540	No
4011	18.4	363	14	5540	Yes
4012	16.6	430	16	5540	Yes
4013	16.1	477	12	5540	Yes
4014	14.8	438	15	5540	Yes
4015	10	498	16	5540	Yes
4016	19.4	472	14	5540	Yes
4017	10.4	428	13	5540	Yes
4018	10.1	297	14	5540	Yes
4019	11.8	265	16	5540	Yes
4020	17.4	264	14	5540	Yes
4021	19.5	378	14	5540	Yes
4022	10.8	273	15	5540	Yes
4023	13.5	400	13	5540	Yes
4024	15.4	307	12	5540	No
4025	13.8	329	15	5540	Yes
4026	16.3	383	14	5540	Yes
4027	15.2	284	12	5540	No
4028	13.4	483	15	5540	Yes
4029	12.9	397	16	5540	Yes
4030	11.6	359	13	5540	Yes

**TYPE 5 DETECTION PROBABILITY**

<b>Data Sheet for FCC Long Pulse Radar Type 5</b>		
<b>Trial</b>	<b>Frequency (MHz)</b>	<b>Successful Detection (Yes/No)</b>
1	5540	Yes
2	5540	Yes
3	5540	Yes
4	5540	Yes
5	5540	Yes
6	5540	Yes
7	5540	Yes
8	5540	Yes
9	5540	Yes
10	5540	Yes
11	5528	No
12	5529	Yes
13	5531	Yes
14	5532	Yes
15	5530	Yes
16	5528	No
17	5529	Yes
18	5533	Yes
19	5529	Yes
20	5531	Yes
21	5548	Yes
22	5549	Yes
23	5546	Yes
24	5551	Yes
25	5552	No
26	5551	Yes
27	5549	Yes
28	5552	Yes
29	5546	Yes
30	5547	Yes

Note: The Type 5 randomized parameters tested are shown in a separate document.

**TYPE 6 DETECTION PROBABILITY**

Data Sheet for FCC Hopping Radar Type 6				
1 us Pulse Width, 333 us PRI, 9 Pulses per Burst, 1 Burst per Hop				
NTIA August 2005 Hopping Sequence				
Trial	Starting Index Within Sequence	Signal Generator Frequency (MHz)	Hops within Detection BW	Successful Detection (Yes/No)
1	55	5525	7	Yes
2	530	5526	9	Yes
3	1005	5527	8	Yes
4	1480	5528	5	Yes
5	1955	5529	6	Yes
6	2430	5530	7	Yes
7	2905	5531	7	Yes
8	3380	5532	9	Yes
9	3855	5533	8	Yes
10	4330	5534	4	Yes
11	4805	5535	4	Yes
12	5280	5536	5	Yes
13	5755	5537	9	Yes
14	6230	5538	7	Yes
15	6705	5539	3	Yes
16	7180	5540	6	Yes
17	7655	5541	5	Yes
18	8130	5542	5	Yes
19	8605	5543	5	Yes
20	9080	5544	3	Yes
21	9555	5545	9	Yes
22	10030	5546	8	Yes
23	10505	5547	4	Yes
24	10980	5548	6	Yes
25	11455	5549	6	Yes
26	11930	5550	2	Yes
27	12405	5551	5	Yes
28	12880	5552	8	Yes
29	13355	5553	5	Yes
30	13830	5554	8	Yes
31	14305	5555	5	Yes

## 5.6. RESULTS FOR 40 MHz BANDWIDTH

### 5.6.1. TRAFFIC AND CHANNEL LOADING

#### TRAFFIC

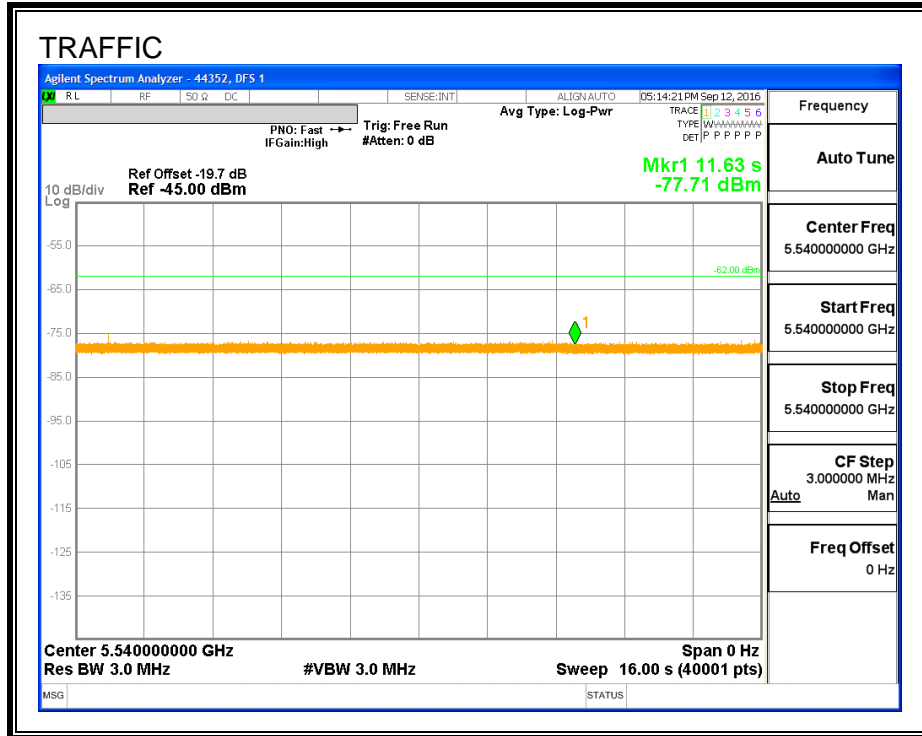

**CHANNEL LOADING**

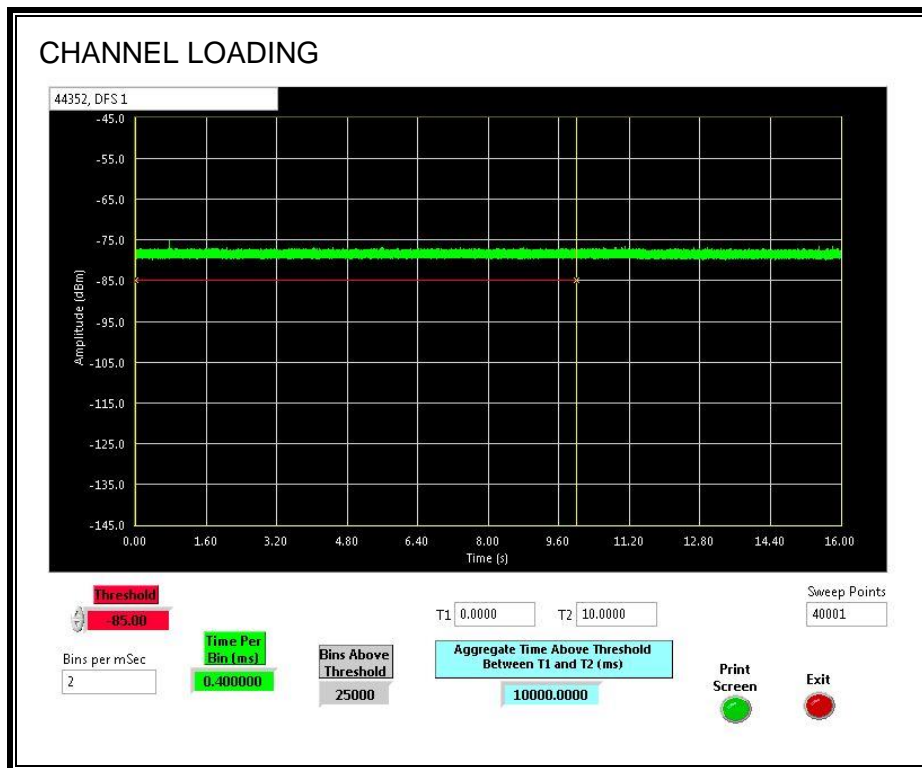

The level of traffic loading on the channel by the EUT is 100%

## **5.6.2. CHANNEL AVAILABILITY CHECK TIME**

### **PROCEDURE TO DETERMINE INITIAL POWER-UP CYCLE TIME**

A link was established on channel then a software command was issued to the EUT to generate a CAC period on the channel. The time from the cessation of traffic to the re-initialization of traffic was measured as the time required for the EUT to complete the total cycle. The time to complete the initial processing period is 60 seconds less than this total time.

### **PROCEDURE FOR TIMING OF RADAR BURST**

With a link established on channel, a software command was issued to the EUT to generate a CAC period on the channel. A radar signal was triggered within 0 to 6 seconds after the initial processing period, and transmissions on the channel were monitored on the spectrum analyzer.

The Non-Occupancy list was cleared. With a link established on channel, a software command was issued to the EUT to generate a CAC period on the channel. A radar signal was triggered within 54 to 60 seconds after the initial processing period, and transmissions on the channel were monitored on the spectrum analyzer.



**QUANTITATIVE RESULTS**

**No Radar Triggered**

Timing of S/W Command (sec)	Timing of Start of Traffic (sec)	Total Cycle Time (sec)	Processing Period Time (sec)
31.31	103.5	72.2	12.2

**Radar Near Beginning of CAC**

Timing of S/W Command (sec)	Timing of Radar Burst (sec)	Radar Relative to Command (sec)	Radar Relative to Start of CAC (sec)
31.37	44.7	13.4	1.2

**Radar Near End of CAC**

Timing of S/W Command (sec)	Timing of Radar Burst (sec)	Radar Relative to Command (sec)	Radar Relative to Start of CAC (sec)
30.95	101.9	71.0	58.8

**QUALITATIVE RESULTS**

Timing of Radar Burst	Display on Control Computer	Spectrum Analyzer Display
No Radar Triggered	EUT marks Channel as active	Transmissions begin on channel after completion of the initial processing period and the CAC
Within 0 to 6 second window	EUT indicates radar detected	No transmissions on channel
Within 54 to 60 second window	EUT indicates radar detected	No transmissions on channel

**TIMING WITHOUT RADAR DURING CAC**

Issue Software Command  
 Traffic ceases  
 Begin Processing Period

End of Processing Period  
 Start of CAC

End of CAC  
 Traffic is Initiated

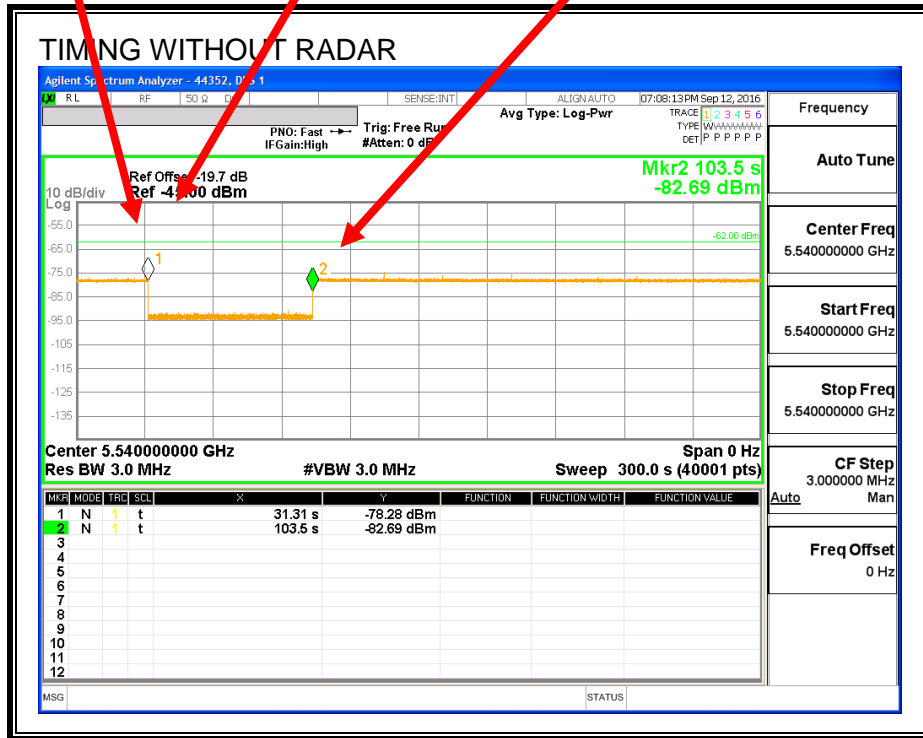

Transmissions begin on channel after completion of the initial processing period and CAC.

**TIMING WITH RADAR NEAR BEGINNING OF CAC**

Issue Software Command  
 Traffic ceases  
 Start of Initial Processing Period

End of Processing Period  
 Start of CAC

Radar Signal Applied

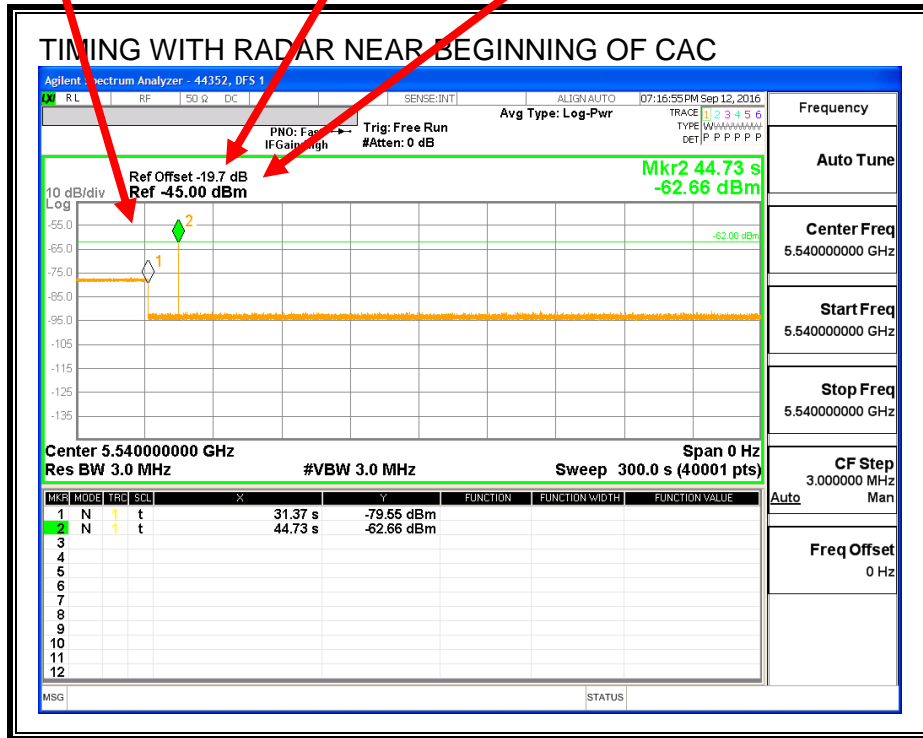

No EUT transmissions were observed after the radar signal.

**TIMING WITH RADAR NEAR END OF CAC**

Issue Software Command  
 Traffic ceases  
 Start of Initial Processing Period

End of Processing Period  
 Start of CAC

Radar Signal Applied

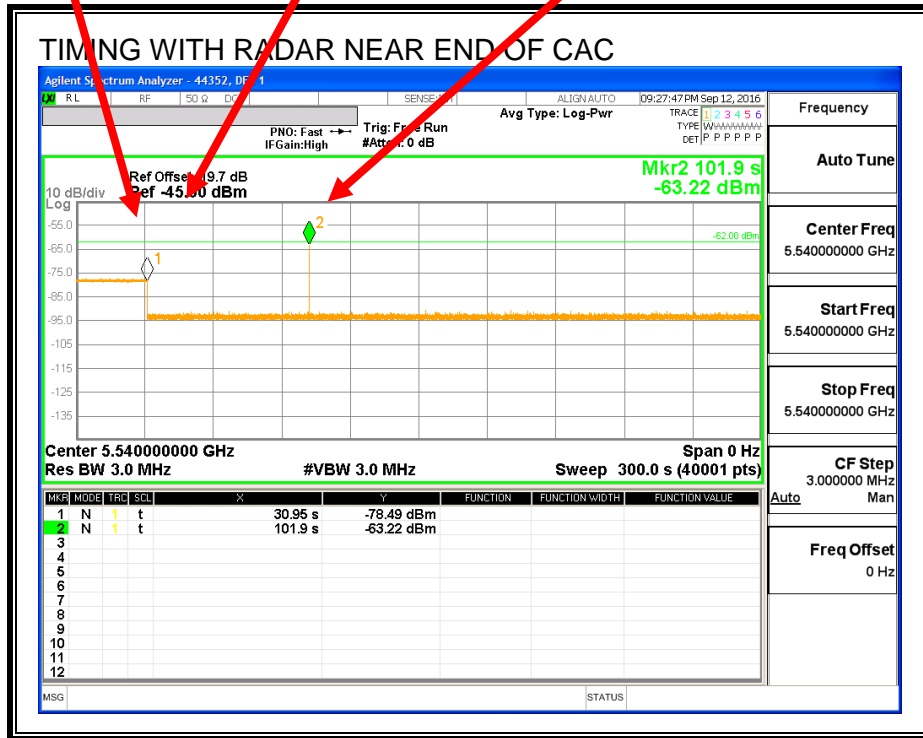

No EUT transmissions were observed after the radar signal.

### 5.6.1. OVERLAPPING CHANNEL TESTS

#### RESULTS

##### **Per Manufacture's Declaration:**

To eliminate the possibility of overlapping channels, the EUT software automatically restricts access to a block of 30 MHz on either side of the center of the operating channel when radar is detected.

### 5.6.2. MOVE AND CLOSING TIME

#### REPORTING NOTES

The reference marker is set at the end of last radar pulse.

The delta marker is set at the end of the last WLAN transmission following the radar pulse. This delta is the channel move time.

The aggregate channel closing transmission time is calculated as follows:

Aggregate Transmission Time =  
(Number of analyzer bins showing transmission) \* (dwell time per bin)

The observation period over which the aggregate time is calculated begins at (Reference Marker + 200 msec) and ends no earlier than (Reference Marker + 10 sec).

#### RESULTS

<b>Channel Move Time (sec)</b>	<b>Limit (sec)</b>
<b>0.156</b>	<b>10</b>

<b>Aggregate Channel Closing Transmission Time (msec)</b>	<b>Limit (msec)</b>
<b>0.0</b>	<b>60</b>

**MOVE TIME**

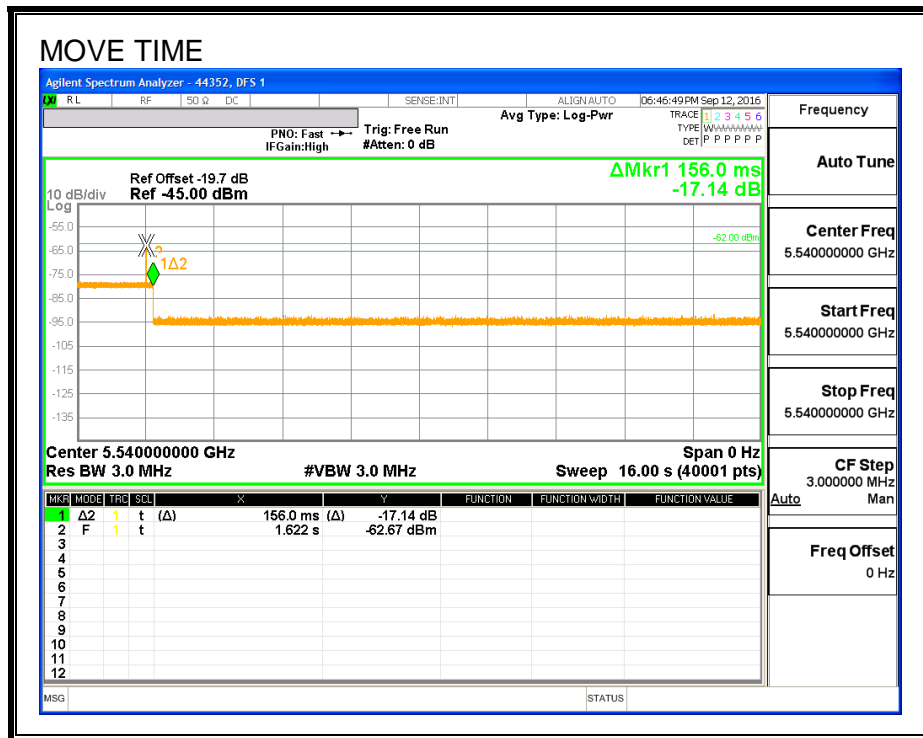

**CHANNEL CLOSING TIME**

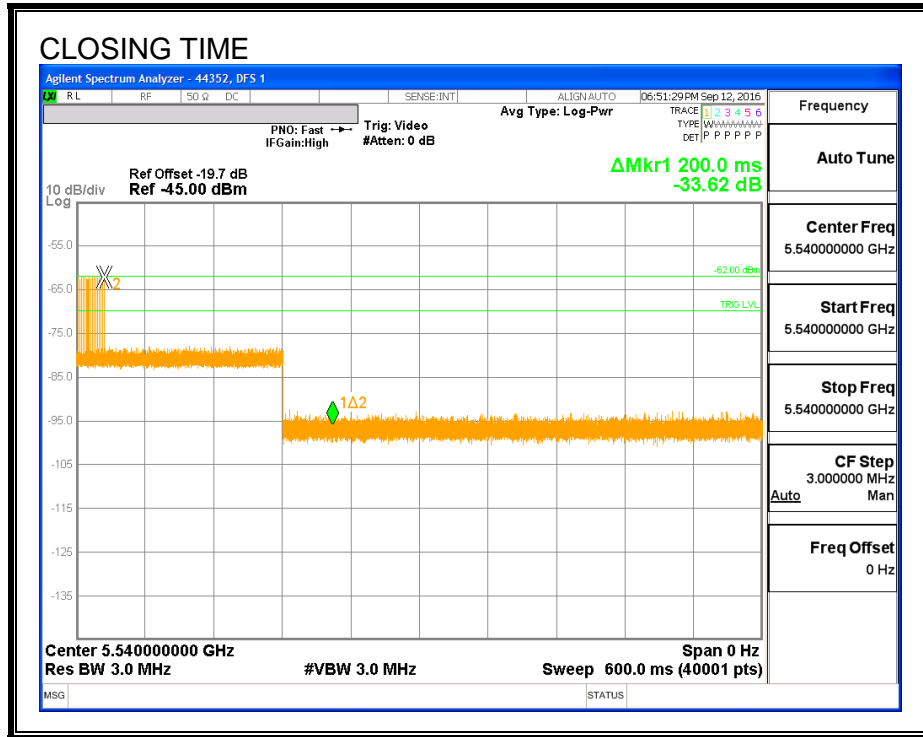

**AGGREGATE CHANNEL CLOSING TRANSMISSION TIME**

No transmissions are observed during the aggregate monitoring period.

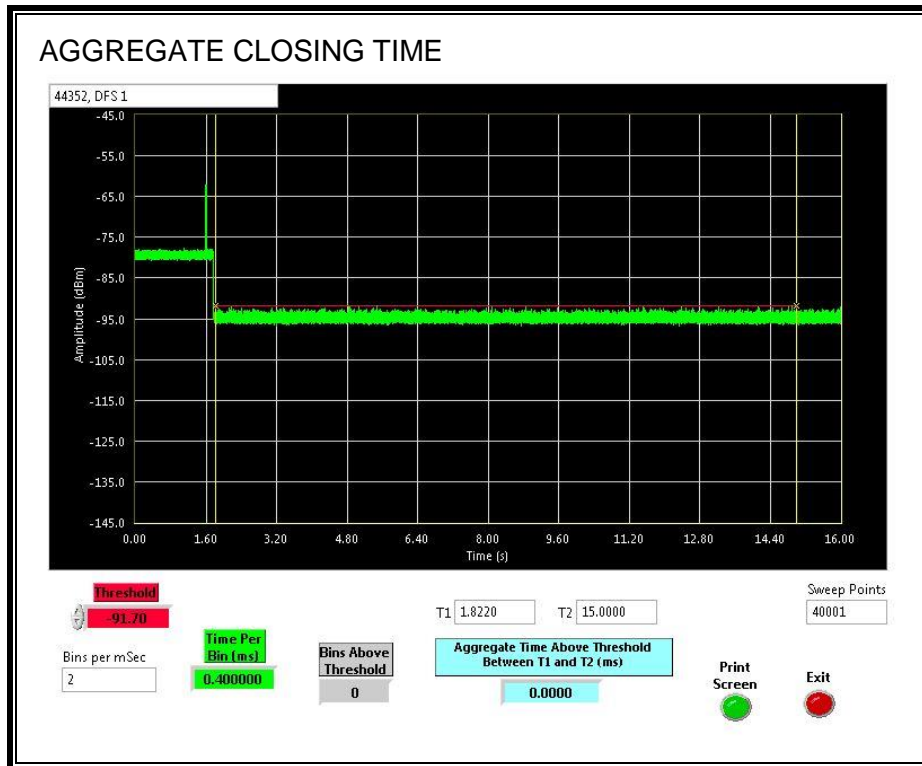



**LONG PULSE CHANNEL MOVE TIME**

The traffic ceases prior to 10 seconds after the end of the radar waveform.

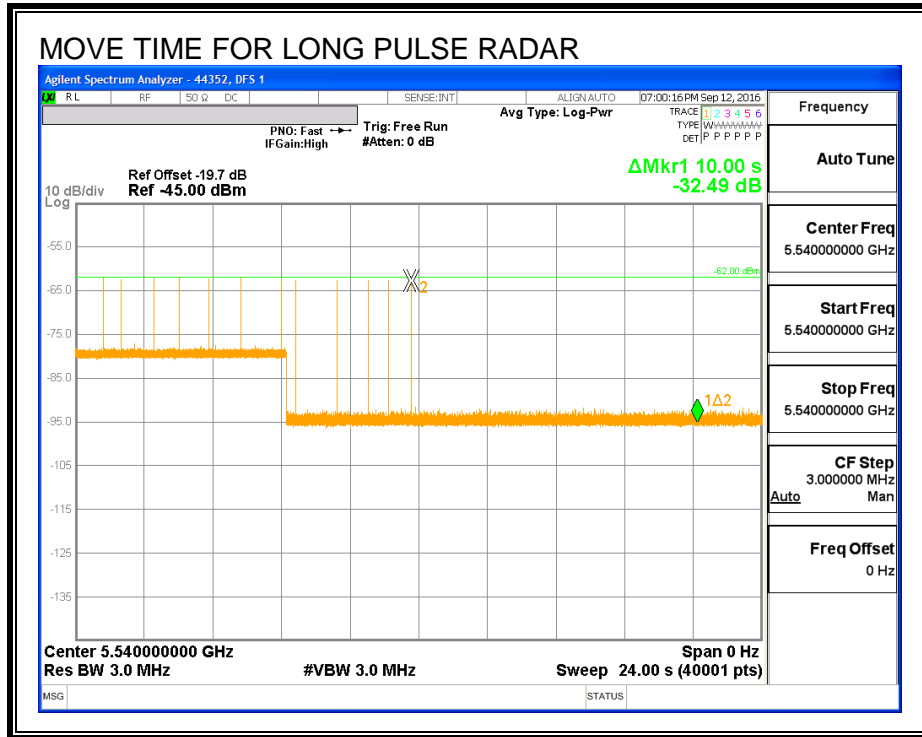

### 5.6.1. NON-OCCUPANCY PERIOD

#### RESULTS

No EUT transmissions were observed on the test channel during the 30-minute observation time.

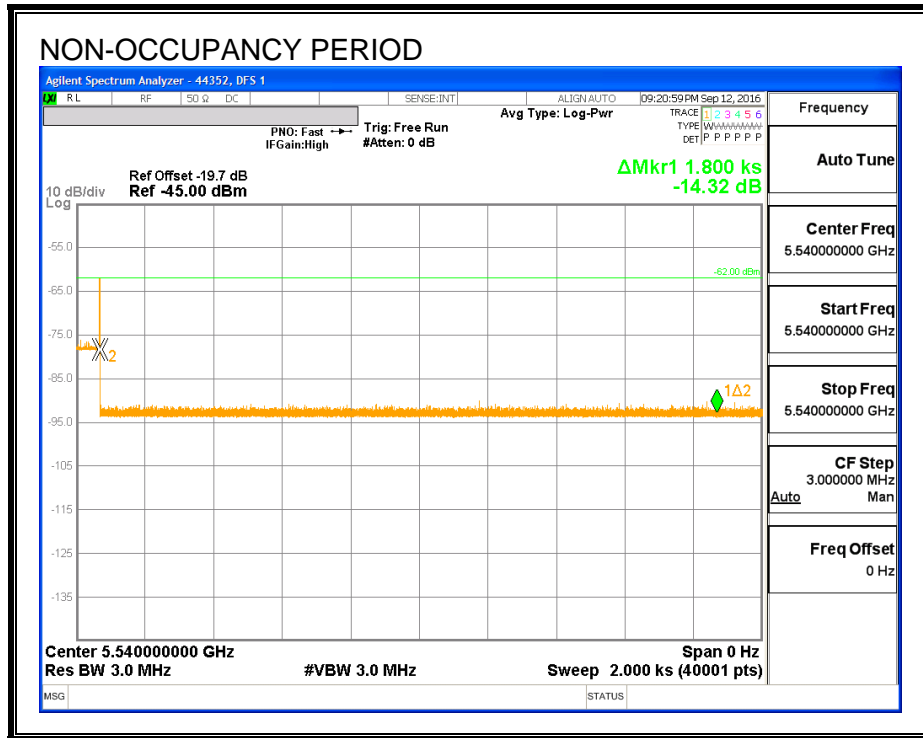

## 5.6.2. DETECTION BANDWIDTH

### REFERENCE PLOT OF 99% POWER BANDWIDTH

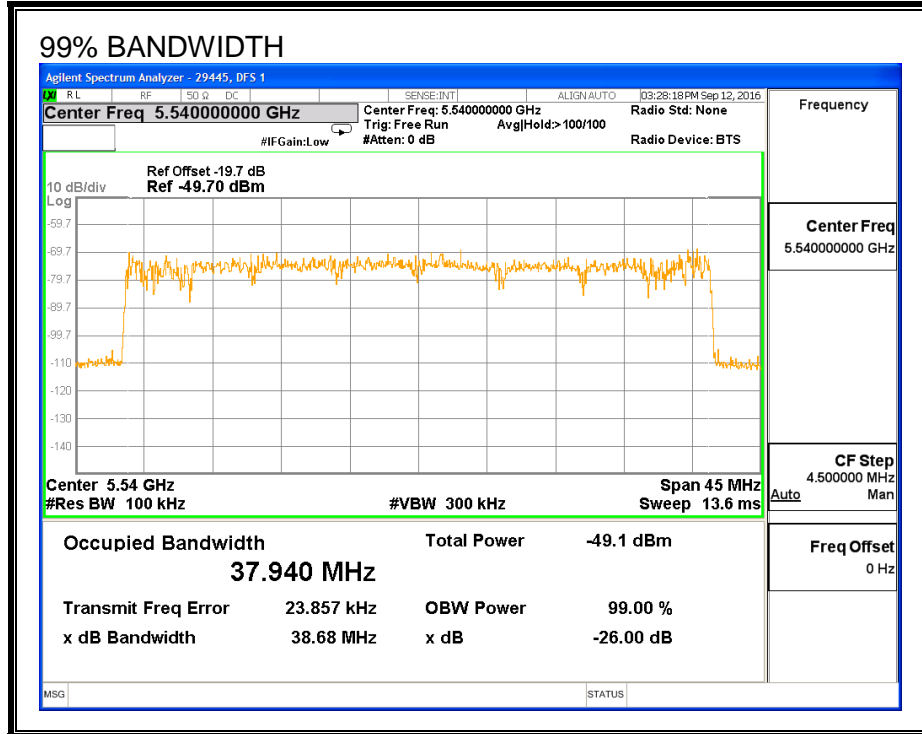

### RESULTS

FL	FH	Detection Bandwidth	99% Power Bandwidth	Ratio of Detection BW to 99% Power BW	Minimum Limit
(MHz)	(MHz)	(MHz)	(MHz)	(%)	(%)
5521	5559	38	37.940	100.2	100

**DETECTION BANDWIDTH PROBABILITY**

<b>DETECTION BANDWIDTH PROBABILITY RESULTS</b>				
<b>Detection Bandwidth Test Results</b>		<b>29445</b>	<b>DFS 1</b>	
<b>FCC Type 0 Waveform: 1 us Pulse Width, 1428 us PRI, 18 Pulses per Burst</b>				
<b>Frequency (MHz)</b>	<b>Number of Trials</b>	<b>Number Detected</b>	<b>Detection (%)</b>	<b>Mark</b>
5521	10	10	100	FL
5522	10	10	100	
5523	10	10	100	
5524	10	10	100	
5525	10	10	100	
5530	10	10	100	
5535	10	10	100	
5540	10	10	100	
5545	10	10	100	
5550	10	10	100	
5555	10	10	100	
5556	10	10	100	
5557	10	10	100	
5558	10	10	100	
5559	10	10	100	FH

### 5.6.3. IN-SERVICE MONITORING

#### RESULTS

FCC Radar Test Summary												
Signal Type	Number of Trials	Detection (%)	Limit (%)	Pass/Fail	Detection Bandwidth		80% of Det BW		OBW	Test Location	Employee Number	In-Service Monitoring Version
					FL	FH	FL5	FH5				
FCC Short Pulse Type 1	30	96.67	60	Pass	5521	5559			37.94	DFS 1	44352	Version 3.0
FCC Short Pulse Type 2	30	100.00	60	Pass	5521	5559			37.94	DFS 1	44352	Version 3.0
FCC Short Pulse Type 3	30	100.00	60	Pass	5521	5559			37.94	DFS 1	44352	Version 3.0
FCC Short Pulse Type 4	30	96.67	60	Pass	5521	5559			37.94	DFS 1	44352	Version 3.0
Aggregate		98.33	80	Pass								
FCC Long Pulse Type 5	30	90.00	80	Pass	5521	5559	5525	5555	37.94	DFS 1	44352	Version 3.0
FCC Hopping Type 6	39	94.87	70	Pass	5521	5559				DFS 1	44352	Version 3.0

**TYPE 1 DETECTION PROBABILITY**

Data Sheet for FCC Short Pulse Radar Type 1						
Waveform	Pulse Width (us)	PRI (us)	Pulses Per Burst	Test (A/B)	Frequency (MHz)	Successful Detection (Yes/No)
1001	1	3066	18	A	5540	Yes
1002	1	718	74	A	5540	Yes
1003	1	818	65	A	5540	Yes
1004	1	518	102	A	5540	Yes
1005	1	638	83	A	5540	Yes
1006	1	618	86	A	5540	Yes
1007	1	758	70	A	5540	Yes
1008	1	698	76	A	5540	Yes
1009	1	538	99	A	5540	Yes
1010	1	778	68	A	5540	Yes
1011	1	878	61	A	5540	Yes
1012	1	838	63	A	5540	Yes
1013	1	678	78	A	5540	Yes
1014	1	558	95	A	5540	Yes
1015	1	738	72	A	5540	Yes
1016	1	706	75	B	5540	Yes
1017	1	597	89	B	5540	Yes
1018	1	2165	25	B	5540	Yes
1019	1	2186	25	B	5540	Yes
1020	1	1335	40	B	5540	Yes
1021	1	2839	19	B	5540	No
1022	1	923	58	B	5540	Yes
1023	1	2556	21	B	5540	Yes
1024	1	771	69	B	5540	Yes
1025	1	2533	21	B	5540	Yes
1026	1	2230	24	B	5540	Yes
1027	1	1733	31	B	5540	Yes
1028	1	1559	34	B	5540	Yes
1029	1	2386	23	B	5540	Yes
1030	1	2342	23	B	5540	Yes

**TYPE 2 DETECTION PROBABILITY**

Data Sheet for FCC Short Pulse Radar Type 2					
Waveform	Pulse Width (us)	PRI (us)	Pulses Per Burst	Frequency (MHz)	Successful Detection (Yes/No)
2001	2.9	190	26	5540	Yes
2002	1.3	156	24	5540	Yes
2003	4.5	197	24	5540	Yes
2004	3.1	210	23	5540	Yes
2005	4.7	217	24	5540	Yes
2006	1.5	154	27	5540	Yes
2007	3.3	203	24	5540	Yes
2008	4.5	186	27	5540	Yes
2009	2.3	201	25	5540	Yes
2010	1.8	189	29	5540	Yes
2011	4	208	23	5540	Yes
2012	3.7	200	24	5540	Yes
2013	2	185	26	5540	Yes
2014	4	181	27	5540	Yes
2015	4.7	171	26	5540	Yes
2016	2.9	214	28	5540	Yes
2017	3.7	208	27	5540	Yes
2018	2.1	217	26	5540	Yes
2019	1.3	214	26	5540	Yes
2020	4	228	25	5540	Yes
2021	3.4	192	28	5540	Yes
2022	2.4	209	25	5540	Yes
2023	2	220	29	5540	Yes
2024	3.2	160	25	5540	Yes
2025	1.1	176	23	5540	Yes
2026	4.6	163	26	5540	Yes
2027	2.7	183	25	5540	Yes
2028	2.4	174	29	5540	Yes
2029	4.8	160	24	5540	Yes
2030	2.7	156	25	5540	Yes

**TYPE 3 DETECTION PROBABILITY**

Data Sheet for FCC Short Pulse Radar Type 3					
Waveform	Pulse Width (us)	PRI (us)	Pulses Per Burst	Frequency (MHz)	Successful Detection (Yes/No)
3001	8	487	16	5540	Yes
3002	5.7	369	17	5540	Yes
3003	6.8	350	17	5540	Yes
3004	9.9	378	16	5540	Yes
3005	8.9	371	17	5540	Yes
3006	9.8	412	17	5540	Yes
3007	6.3	301	17	5540	Yes
3008	5.2	354	18	5540	Yes
3009	9.7	389	17	5540	Yes
3010	6.1	455	16	5540	Yes
3011	8.6	251	18	5540	Yes
3012	7.9	464	18	5540	Yes
3013	5.5	273	18	5540	Yes
3014	5.1	498	17	5540	Yes
3015	8.1	453	17	5540	Yes
3016	5.6	440	16	5540	Yes
3017	6.4	408	18	5540	Yes
3018	9.2	290	16	5540	Yes
3019	5.2	404	17	5540	Yes
3020	8.3	299	18	5540	Yes
3021	7.3	425	17	5540	Yes
3022	8.2	333	16	5540	Yes
3023	7.4	472	18	5540	Yes
3024	8.6	275	17	5540	Yes
3025	8.1	309	18	5540	Yes
3026	9.9	258	16	5540	Yes
3027	9.7	305	17	5540	Yes
3028	9	267	16	5540	Yes
3029	6.6	327	16	5540	Yes
3030	6.2	301	18	5540	Yes



**TYPE 4 DETECTION PROBABILITY**

Data Sheet for FCC Short Pulse Radar Type 4					
Waveform	Pulse Width (us)	PRI (us)	Pulses Per Burst	Frequency (MHz)	Successful Detection (Yes/No)
4001	13.6	256	15	5540	Yes
4002	13.3	494	13	5540	Yes
4003	15	462	12	5540	No
4004	10.5	344	16	5540	Yes
4005	12.6	458	15	5540	Yes
4006	14	352	12	5540	Yes
4007	16.7	479	14	5540	Yes
4008	18.6	387	14	5540	Yes
4009	17	275	16	5540	Yes
4010	19.4	462	16	5540	Yes
4011	18.4	363	14	5540	Yes
4012	16.6	430	16	5540	Yes
4013	16.1	477	12	5540	Yes
4014	14.8	438	15	5540	Yes
4015	10	498	16	5540	Yes
4016	19.4	472	14	5540	Yes
4017	10.4	428	13	5540	Yes
4018	10.1	297	14	5540	Yes
4019	11.8	265	16	5540	Yes
4020	17.4	264	14	5540	Yes
4021	19.5	378	14	5540	Yes
4022	10.8	273	15	5540	Yes
4023	13.5	400	13	5540	Yes
4024	15.4	307	12	5540	Yes
4025	13.8	329	15	5540	Yes
4026	16.3	383	14	5540	Yes
4027	15.2	284	12	5540	Yes
4028	13.4	483	15	5540	Yes
4029	12.9	397	16	5540	Yes
4030	11.6	359	13	5540	Yes

**TYPE 5 DETECTION PROBABILITY**

Data Sheet for FCC Long Pulse Radar Type 5		
Trial	Frequency (MHz)	Successful Detection (Yes/No)
1	5540	Yes
2	5540	Yes
3	5540	Yes
4	5540	Yes
5	5540	Yes
6	5540	Yes
7	5540	Yes
8	5540	Yes
9	5540	Yes
10	5540	Yes
11	5524	Yes
12	5525	No
13	5526	Yes
14	5528	Yes
15	5525	Yes
16	5524	Yes
17	5525	Yes
18	5529	Yes
19	5524	No
20	5526	Yes
21	5552	Yes
22	5553	Yes
23	5551	Yes
24	5555	Yes
25	5557	No
26	5555	Yes
27	5554	Yes
28	5556	Yes
29	5551	Yes
30	5552	Yes

Note: The Type 5 randomized parameters tested are shown in a separate document.

**TYPE 6 DETECTION PROBABILITY**

Data Sheet for FCC Hopping Radar Type 6				
1 us Pulse Width, 333 us PRI, 9 Pulses per Burst, 1 Burst per Hop				
NTIA August 2005 Hopping Sequence				
Trial	Starting Index Within Sequence	Signal Generator Frequency (MHz)	Hops within Detection BW	Successful Detection (Yes/No)
1	363	5521	7	No
2	838	5522	10	Yes
3	1313	5523	7	Yes
4	1788	5524	9	Yes
5	2263	5525	10	Yes
6	2738	5526	8	Yes
7	3213	5527	9	Yes
8	3688	5528	2	Yes
9	4163	5529	9	Yes
10	4638	5530	10	Yes
11	5113	5531	8	Yes
12	5588	5532	12	Yes
13	6063	5533	8	Yes
14	6538	5534	9	Yes
15	7013	5535	7	Yes
16	7488	5536	9	Yes
17	7963	5537	9	Yes
18	8438	5538	12	Yes
19	8913	5539	10	Yes
20	9388	5540	3	Yes
21	9863	5541	5	Yes
22	10338	5542	11	Yes
23	10813	5543	13	Yes
24	11288	5544	4	Yes
25	11763	5545	7	Yes
26	12238	5546	12	Yes
27	12713	5547	10	Yes
28	13188	5548	7	Yes
29	13663	5549	4	Yes
30	14138	5550	14	Yes
31	14613	5551	9	Yes
32	15088	5552	3	Yes
33	15563	5553	12	Yes
34	16038	5554	10	Yes
35	16513	5555	6	Yes
36	16988	5556	6	Yes
37	17463	5557	10	Yes
38	17938	5558	12	Yes
39	18413	5559	9	No

## **5.7. BRIDGE MODE RESULTS**

Per KDB 905462, Section 5.1 (footnote 1):

Networks Access Points with Bridge and/or MESH modes of operation are permitted to operate in the DFS bands but must employ a DFS function. The functionality of the Bridge mode as specified in §15.403(a) must be validated in the DFS test report. Devices operating as relays must also employ DFS function. The method used to validate the functionality must be documented and validation data must be documented. Bridge mode can be validated by performing a test statistical performance check (Section 7.8.4) on any one of the radar types. This is an abbreviated test to verify DFS functionality. MESH mode operational methodology must be submitted in the application for certification for evaluation by the FCC.

This device does not support Bridge Mode therefore this test was not performed.