



CIIPC TEST REPORT

Report Number : 11460774-E1V1

Applicant : NEXTIVITY INC.
12230 WORLD TRADE DRIVE SUITE 250
SAN DIEGO, CA 92128, U.S.A

Model : D32-2/4CU

FCC ID : YETD24CU

EUT Description : CEL-FI DUO SMART CELLULAR SIGNAL BOOSTER

Test Standard(s) : PORTION OF FCC 47 CFR PART 15 SUBPART E
PORTION OF INDUSTRY CANADA RSS-247 ISSUE 1
INDUSTRY CANADA RSS-GEN Issue 4

Date of Issue:
10/10/2016

Prepared by:
UL Verification Services Inc.
47173 Benicia Street
Fremont, CA 94538, U.S.A.
TEL: (510) 771-1000
FAX: (510) 661-0888



NVLAP LAB CODE 200065-0

Revision History

<u>Rev.</u>	<u>Issue Date</u>	<u>Revisions</u>	<u>Revised By</u>
V1	10/10/16	Initial Issue	D. CORONIA

TABLE OF CONTENTS

1. ATTESTATION OF TEST RESULTS	4
2. SUMMARY OF TESTING	5
2.1. FACILITIES AND ACCREDITATION	5
2.2. SUMMARY TABLE	5
2.3. TEST METHODOLOGY.....	5
2.4. CALIBRATION AND UNCERTAINTY	6
2.5. MEASUREMENT METHOD.....	7
2.6. TEST AND MEASUREMENT EQUIPMENT.....	8
3. EQUIPMENT UNDER TEST	9
3.1. DESCRIPTION OF EUT	9
3.2. MAXIMUM OUTPUT POWER.....	9
3.3. DESCRIPTION OF AVAILABLE ANTENNAS	9
3.4. SOFTWARE AND FIRMWARE.....	9
3.5. WORST-CASE CONFIGURATION AND MODE.....	10
3.6. DESCRIPTION OF CLASS II PERMISSIVE CHANGE	10
3.7. DESCRIPTION OF TEST SETUP.....	11
4. ANTENNA PORT TEST RESULTS	13
4.1. ON TIME AND DUTY CYCLE	13
4.2. 30MHz MODE IN THE 5.8 GHz BAND	15
4.2.1. OUTPUT POWER	15
4.2.2. Maximum Power Spectral Density (PSD).....	16
4.3. 40MHz MODE IN THE 5.8 GHz BAND	18
4.3.1. OUTPUT POWER	18
4.3.2. Maximum Power Spectral Density (PSD).....	19
5. RADIATED TEST RESULTS.....	21
5.1. LIMITS AND PROCEDURE.....	21
5.2. TRANSMITTER ABOVE 1 GHz.....	22
5.2.1. TX ABOVE 1 GHz; 30MHz MODE IN THE 5.8 GHz BAND	22
5.2.2. TX ABOVE 1 GHz; 40MHz MODE IN THE 5.8 GHz BAND	28
5.3. WORST-CASE 18 GHz – 26 GHz.....	32
5.4. WORST-CASE 26 GHz – 40 GHz.....	34
5.5. WORST-CASE BELOW 1 GHz.....	36
5.6. WORST-CASE BELOW 30 MHz.....	38
6. SETUP PHOTOS.....	39

1. ATTESTATION OF TEST RESULTS

COMPANY NAME: NEXTIVITY INC.
EUT DESCRIPTION: CEL-FI DUO SMART CELLULAR SIGNAL BOOSTER
MODEL: D32-2/4CU
SERIAL NUMBER: CU: 905432026621
DATE TESTED: SEPTEMBER 29 – OCTOBER 3, 2016

APPLICABLE STANDARDS	
STANDARD	TEST RESULTS
CFR 47 Part 15 Subpart E	Pass
INDUSTRY CANADA RSS-247 Issue 1	Pass
INDUSTRY CANADA RSS-GEN Issue 4	Pass

UL Verification Services Inc. tested the above equipment in accordance with the requirements set forth in the above standards. All indications of Pass/Fail in this report are opinions expressed by UL Verification Services Inc. based on interpretations and/or observations of test results. Measurement Uncertainties were not taken into account and are published for informational purposes only. The test results show that the equipment tested is capable of demonstrating compliance with the requirements as documented in this report.

Note: The results documented in this report apply only to the tested sample, under the conditions and modes of operation as described herein. This document may not be altered or revised in any way unless done so by UL Verification Services Inc. and all revisions are duly noted in the revisions section. Any alteration of this document not carried out by UL Verification Services Inc. will constitute fraud and shall nullify the document. This report must not be used by the client to claim product certification, approval, or endorsement by NVLAP, NIST, any agency of the Federal Government, or any agency of any government.

Approved & Released For
UL Verification Services Inc. By:



DAN CORONIA
CONSUMER TECHNOLOGY DIVISION
WISE PROJECT LEAD
UL Verification Services Inc.

Prepared By:



ROY ZHENG
CONSUMER TECHNOLOGY DIVISION
WISE LAB ENGINEER
UL Verification Services Inc.

2. SUMMARY OF TESTING

2.1. FACILITIES AND ACCREDITATION

The test sites and measurement facilities used to collect data are located at 47173 and 47266 Benicia Street, Fremont, California, USA. Line conducted emissions are measured only at the 47173 address. The following table identifies which facilities were utilized for radiated emission measurements documented in this report. Specific facilities are also identified in the test results sections.

47173 Benicia Street	47266 Benicia Street
<input type="checkbox"/> Chamber A(IC: 2324B-1)	<input type="checkbox"/> Chamber D(IC: 2324B-4)
<input type="checkbox"/> Chamber B(IC: 2324B-2)	<input type="checkbox"/> Chamber E(IC: 2324B-5)
<input checked="" type="checkbox"/> Chamber C(IC: 2324B-3)	<input type="checkbox"/> Chamber F(IC: 2324B-6)
	<input type="checkbox"/> Chamber G(IC: 2324B-7)
	<input type="checkbox"/> Chamber H(IC: 2324B-8)

The above test sites and facilities are covered under FCC Test Firm Registration # 208313. Chambers A through H are covered under Industry Canada company address code 2324B with site numbers 2324B -1 through 2324B-8, respectively.

UL Verification Services Inc. is accredited by NVLAP, Laboratory Code 200065-0. The full scope of accreditation can be viewed at <http://ts.nist.gov/standards/scopes/2000650.htm>.

2.2. SUMMARY TABLE

FCC Part Section	RSS Section	Test Description	Test Limit	Test Condition	Test Result
§15.407 (a)	RSS-247	Occupied Band width (99%)	N/A	Conducted	Refer to Nextivity Report by NTS(R94998)
§15.407	RSS-247 6.2.4	6dB Band width (5.8Ghz)	>500KHz		Refer to Nextivity Report by NTS(R94998)
§15.407 (a)(3)	RSS-247 6.2.4	TX Cond. Power 5.725-5.850 GHz	<30dBm		Pass
§15.407 (a)(3)	RSS-247 6.2.4	PSD (5.8GHz)	<30dBm per 500kHz		Pass
§15.207 (a) §15.407(b) (6)	RSS-GEN 8.8	AC Power Line conducted emissions	Section 10		Refer to Nextivity Report by NTS(R94998)
§15.407 (b) & 15.209	RSS-GEN 8.9/7	Radiated Spurious Emission	<54dBuV/m	Radiated	Pass

NOTE:

1. Occupied Bandwidth 99%, 6dB Bandwidth, Bandedge and AC line conducted test data please refer to Nextivity report by NTS File R94998.
2. Per FCC Part 15.407 (b) (4) (II) Bandedge data from Nextivity report by NTS File R94998 still in compliance in §15. 247 (d), until before March 2, 2020.

2.3. TEST METHODOLOGY

The tests documented in this report were performed in accordance with FCC CFR 47 Part 2, FCC CFR 47 Part 15, KDB 789033 D02 v01r03, KDB 662911, ANSI C63.10-2013, RSS-GEN Issue 4, and RSS-247 Issue 1.

2.4. CALIBRATION AND UNCERTAINTY

MEASURING INSTRUMENT CALIBRATION

The measuring equipment utilized to perform the tests documented in this report has been calibrated in accordance with the manufacturer's recommendations, and is traceable to recognized national standards.

SAMPLE CALCULATION

Where relevant, the following sample calculation is provided:

$$\begin{aligned} \text{Field Strength (dBuV/m)} &= \text{Measured Voltage (dBuV)} + \text{Antenna Factor (dB/m)} + \\ &\text{Cable Loss (dB)} - \text{Preamp Gain (dB)} \\ 36.5 \text{ dBuV} + 18.7 \text{ dB/m} + 0.6 \text{ dB} - 26.9 \text{ dB} &= 28.9 \text{ dBuV/m} \end{aligned}$$

MEASUREMENT UNCERTAINTY

Where relevant, the following measurement uncertainty levels have been estimated for tests performed on the apparatus:

PARAMETER	UNCERTAINTY
Conducted Disturbance, 0.15 to 30 MHz	3.84 dB
Radiated Disturbance, 9KHz to 30 MHz	2.14 dB
Radiated Disturbance, 30 to 1000 MHz	4.98 dB
Radiated Disturbance, 1000 to 6000 MHz	3.86 dB
Radiated Disturbance, 6000 to 18000 MHz	4.23 dB
Radiated Disturbance, 18000 to 26000 MHz	5.30 dB
Radiated Disturbance, 26000 to 40000 MHz	5.23 dB

Uncertainty figures are valid to a confidence level of 95%.

2.5. MEASUREMENT METHOD

On Time and Duty Cycle: KDB 789033 D02 v01r03, Section B.

Conducted Output Power: KDB 789033 D02 v01r03, Section E.3.b (Method PM-G), and KDB 662911 D01 v02r01

Power Spectral Density: KDB 789033 D02 v01r03, Section F, and KDB 662911 D01 v02r01

Unwanted emissions in restricted bands: KDB 789033 D02 v01r03, Sections G.3, G.4, G.5, and G.6.

Unwanted emissions in non-restricted bands: KDB 789033 D02 v01r03, Sections G.3, G.4, and G.5.

2.6. TEST AND MEASUREMENT EQUIPMENT

The following test and measurement equipment was utilized for the tests documented in this report:

Test Equipment List					
Description	Manufacturer	Model	T No.	Cal Date	Cal Due
Antenna, Broadband Hybrid 30MHz to 2000MHz	Sunol Science	JB1	T122	01/29/16	01/29/17
Antenna, Horn 18-26.5GHz	Seavey Division	MWH-1826/B	T449	05/26/16	05/26/17
Antenna, Horn 26.5-40GHz	Seavey Division	MWH-2640/B	T446	05/26/16	05/26/17
Antenna, Horn, 18GHz	ETS Lindgren	3117	119	02/04/16	2/4/2017
Antenna, Biconolog, 30MHz-1 GHz	Sunol Sciences	JB3	122	05/26/16	05/26/17
Loop Antenna, 10KHz-30MHz	EMCO	6502	35	03/24/16	03/24/17
Power Meter, P-series single channel	Keysight	N1911A	T1262	07/08/16	07/08/17
Power Sensor, P - series, 50MHz to 18GHz, Wideband	Agilent	N1921A	T750	09/17/16	09/17/17
PSA Spectrum Analyzer 40GHz	Agilent	E4440A	T199	07/22/16	07/22/17
Spectrum Analyzer, PXA, 3Hz to 44GHz	Agilent	N9030A	T907	01/06/16	01/06/17
RF Preamplifier, 30MHz - 1GHz	Sonoma	310N	173	06/17/16	06/17/17
Amplifier 10kHz to 1GHz, 32dB	HP	8447D	10	02/01/16	02/01/17
Amplifier, 1-18GHz	Miteq	AFS42	931	04/30/16	04/30/17
Amplifier, 1 - 26.5GHz, 23.5dB	Agilent	8449B	404	07/05/16	07/05/17
Amplifier, 26 - 40GHz	Miteq	AFS42	493	03/09/16	03/09/17

Test Software List			
Description	Manufacturer	Model	Version
Radiated Software	UL	UL EMC	Ver 9.5, Apr 26, 2016
Conducted Software	UL	UL EMC	Ver 9.5, May 26, 2015
Antenna Port Software	UL	UL RF	Ver 5.1.1, July 15, 2016

3. EQUIPMENT UNDER TEST

3.1. DESCRIPTION OF EUT

The EUT is CEL-FI Duo Smart Cellular Signal Booster.

3.2. MAXIMUM OUTPUT POWER

The transmitter has a maximum conducted peak output power as follows:

Frequency Range (MHz)	Mode	Output Power (dBm)	Output Power (mW)
5745-5825	30MHz	20.70	117.49
5755-5795	40MHz	20.53	112.98

3.3. DESCRIPTION OF AVAILABLE ANTENNAS

The radio utilizes a PCB Monopole antenna, with a maximum gain as below:

Frequency (MHz)	Max. Peak Gain (dBi)
5725 - 5850	2

3.4. SOFTWARE AND FIRMWARE

The firmware installed in the EUT during testing was 5.1.1.130.

The test utility software used during testing was ConformanceTest.exe.

3.5. WORST-CASE CONFIGURATION AND MODE

Radiated emission was performed with the EUT set to transmit at the channel with highest output power as worst-case scenario.

The EUT can be set only in portrait orientation; therefore, all final testing was performed with the EUT in the portrait orientation.

3.6. DESCRIPTION OF CLASS II PERMISSIVE CHANGE

1. The purpose of this C2PC is to upgrade the device described under section 5.1 of this report to the new rules per KDB 789033 D02 v01r03.
2. The antenna gain listed of this C2PC test report is 2dBi.
2. For UNII-3 bands, compliance with the new rules per KDB 789033 D02 v01r03 is demonstrated by data covered under this report.

3.7. DESCRIPTION OF TEST SETUP

SUPPORT EQUIPMENT

Support Equipment List				
Description	Manufacturer	Model	Serial Number	FCC ID
Support Laptop	Dell	PP18L	N/A	N/A
AC/DC Adapter	Dell	PA-1900-02D	N/A	N/A

I/O CABLES

I/O Cable List						
Cable No	Port	# of identical ports	Connector Type	Cable Type	Cable Length (m)	Remarks
1	DC	1	DC PLUG	Unshielded	2	Power for CU
2	DC	1	DC PLUG	Unshielded	2	Power for NU

TEST SETUP

The EUT is connected to a Laptop for configuration only; it was not connected during the tests.

SETUP DIAGRAM FOR TESTS

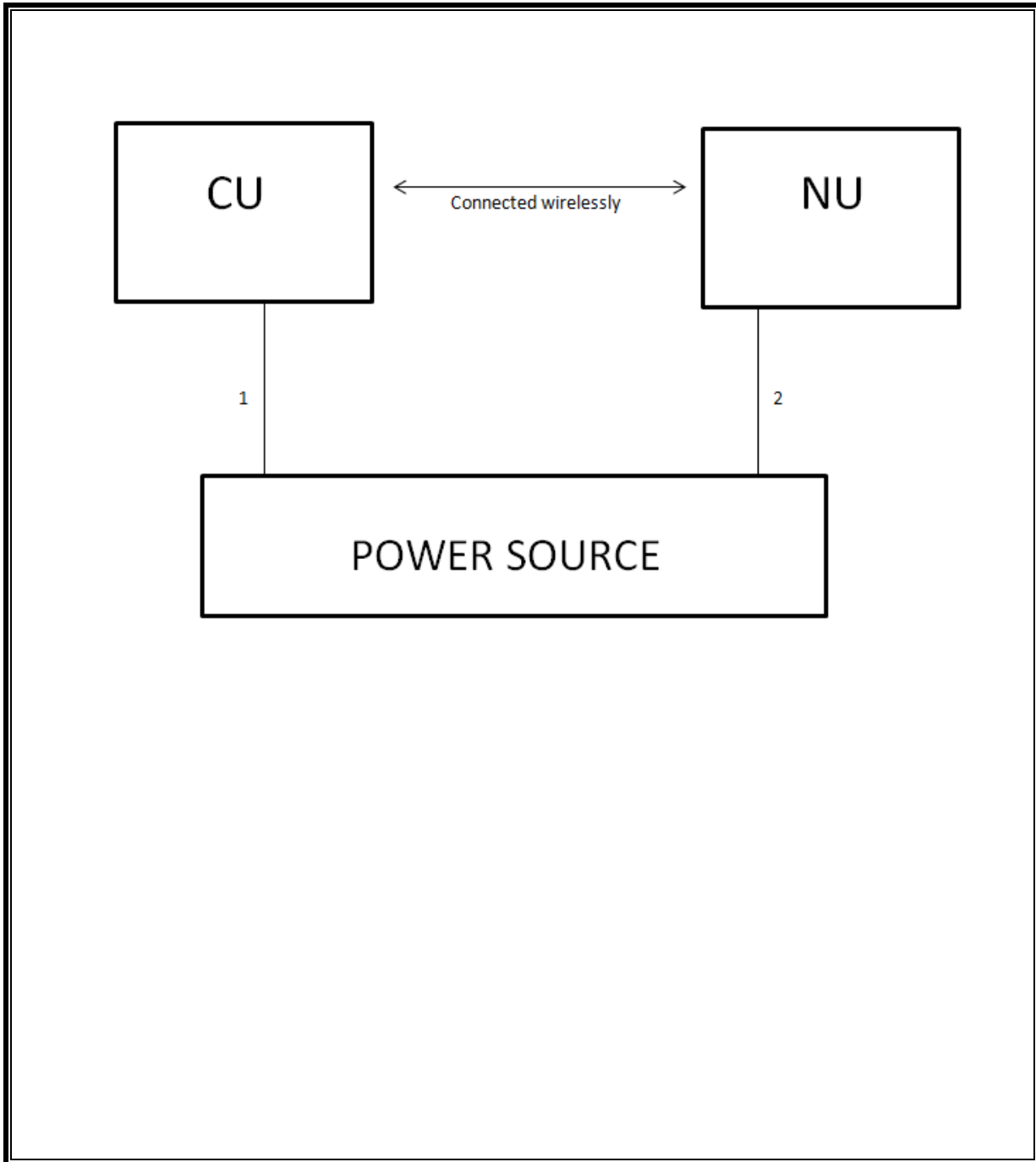

4. ANTENNA PORT TEST RESULTS

4.1. ON TIME AND DUTY CYCLE

LIMITS

None; for reporting purposes only.

PROCEDURE

KDB 789033 Zero-Span Spectrum Analyzer Method.

ON TIME AND DUTY CYCLE RESULTS

Mode	ON Time B (msec)	Period (msec)	Duty Cycle x (linear)	Duty Cycle (%)	Duty Cycle Correction Factor (dB)	1/B Minimum VBW (kHz)
30MHz	0.809	0.809	1.000	100.00%	0.00	0.010
40MHz	0.4530	0.4530	1.000	100.00%	0.00	0.010

DUTY CYCLE PLOTS

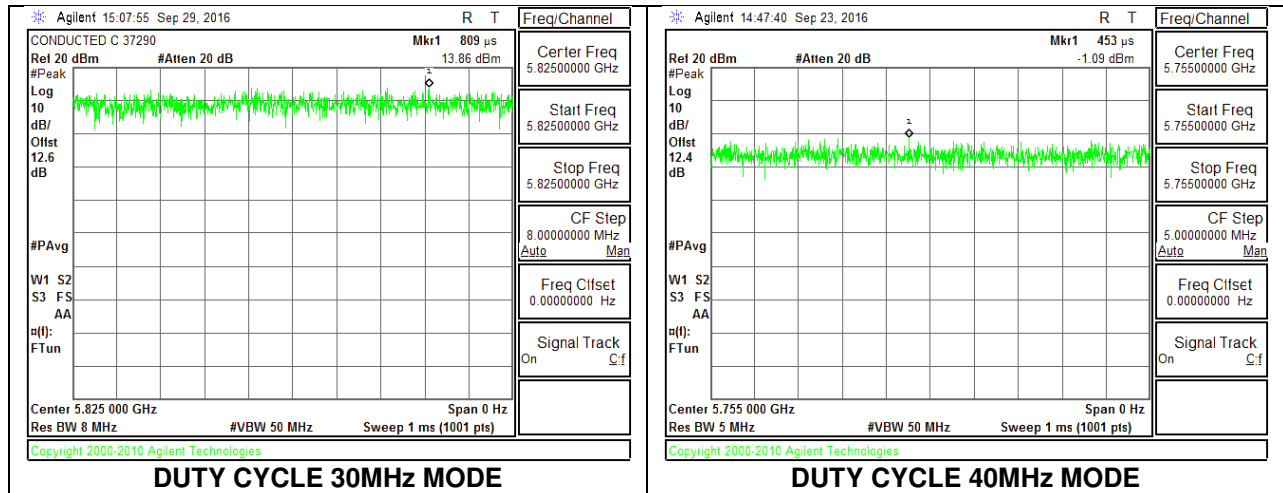

4.2. 30MHz MODE IN THE 5.8 GHz BAND

4.2.1. OUTPUT POWER

LIMITS

FCC §15.407 (a) (3), IC RSS-247 6.2.4 (1)

For the band 5.725-5.85 GHz, the maximum conducted output power over the frequency band of operation shall not exceed 1 W. In addition, the maximum power spectral density shall not exceed 30 dBm in any 500-kHz band. If transmitting antennas of directional gain greater than 6 dBi are used, both the maximum conducted output power and the maximum power spectral density shall be reduced by the amount in dB that the directional gain of the antenna exceeds 6 dBi.

DIRECTIONAL ANTENNA GAIN

There is only one transmitter output therefore the directional gain is equal to the antenna gain.

RESULTS

5725 - 5850MHz Band, 30MHz

Antenna Gain and Limit

Channel	Frequency (MHz)	Directional Gain for Power (dBi)	Power Limit (dBm)
Low	5765	2.00	30.00
Mid	5785	2.00	30.00
High	5825	2.00	30.00

Output Power Results

Channel	Frequency (MHz)	Meas Power (dBm)	Total Corr'd Power (dBm)	Power Limit (dBm)	Power Margin (dB)
Low	5765	20.45	20.45	30.00	-9.55
Mid	5785	20.36	20.36	30.00	-9.64
High	5825	20.70	20.70	30.00	-9.30

Note: the power readings above were measured with gated method, and the measurement was taken only during the ON time. No duty cycle correction was necessary.

ID:	37290	Date:	9/29/2016
------------	-------	--------------	-----------

4.2.2. Maximum Power Spectral Density (PSD)

LIMITS

FCC §15.407 (a) (3)

For the band 5.725-5.85 GHz, the maximum conducted output power over the frequency band of operation shall not exceed 1 W. In addition, the maximum power spectral density shall not exceed 30 dBm in any 500-kHz band. If transmitting antennas of directional gain greater than 6 dBi are used, both the maximum conducted output power and the maximum power spectral density shall be reduced by the amount in dB that the directional gain of the antenna exceeds 6 dBi.

DIRECTIONAL ANTENNA GAIN

There is only one transmitter output therefore the directional gain is equal to the antenna gain.

RESULTS

5725 - 5850MHz Band, 30MHz

Antenna Gain and Limits

Channel	Frequency (MHz)	Directional Gain (dBi)	PSD Limit (dBm)
Low	5765	2.00	30.00
Mid	5785	2.00	30.00
High	5825	2.00	30.00

Duty Cycle CF (dB)	0.00	Included in Calculations of Corr'd PSD
---------------------------	------	---

PSD Results

Channel	Frequency (MHz)	Meas PSD (dBm)	Total Corr'd PSD (dBm)	PSD Limit (dBm)	PSD Margin (dB)
Low	5765	-5.481	-5.481	30.00	-35.48
Mid	5785	-6.299	-6.299	30.00	-36.30
High	5825	-5.821	-5.821	30.00	-35.82

ID:	37290	Date:	9/29/2016
------------	-------	--------------	-----------

5725 - 5850MHz Band, 30MHz

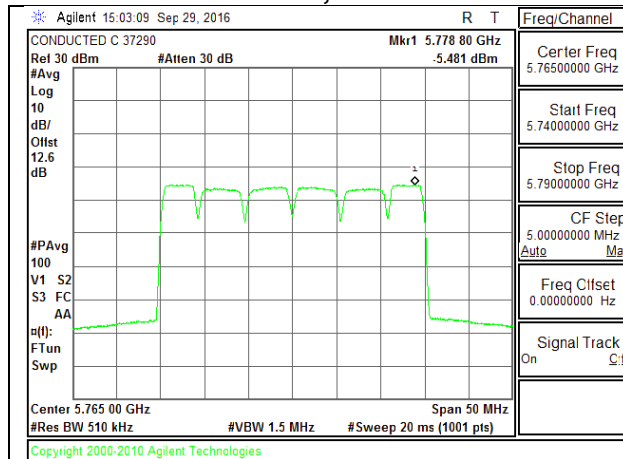

LOW CHANNEL

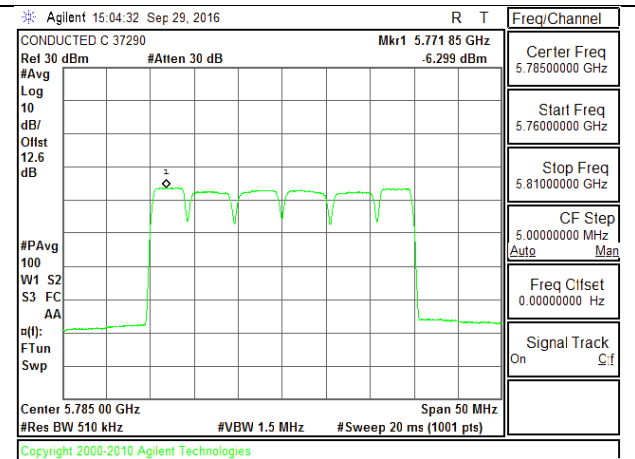

MID CHANNEL

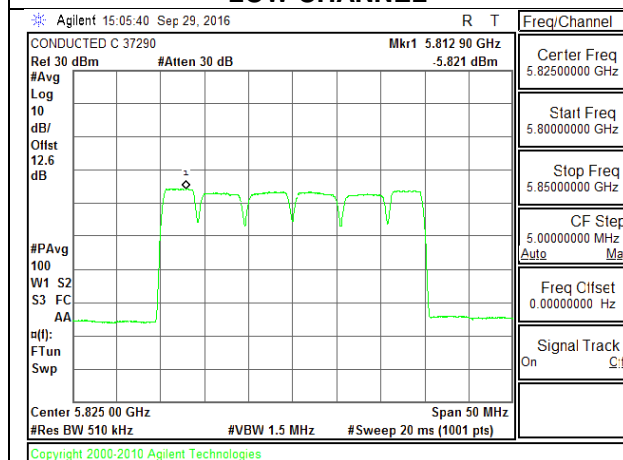

HIGH CHANNEL

4.3. 40MHz MODE IN THE 5.8 GHz BAND

4.3.1. OUTPUT POWER

LIMITS

FCC §15.407 (a) (3), IC RSS-247 6.2.4 (1)

For the band 5.725-5.85 GHz, the maximum conducted output power over the frequency band of operation shall not exceed 1 W. In addition, the maximum power spectral density shall not exceed 30 dBm in any 500-kHz band. If transmitting antennas of directional gain greater than 6 dBi are used, both the maximum conducted output power and the maximum power spectral density shall be reduced by the amount in dB that the directional gain of the antenna exceeds 6 dBi.

DIRECTIONAL ANTENNA GAIN

There is only one transmitter output therefore the directional gain is equal to the antenna gain.

RESULTS

5725 - 5850MHz Band, 40MHz

Antenna Gain and Limit

Channel	Frequency (MHz)	Directional Gain for Power (dBi)	Power Limit (dBm)
Low	5755	2.00	30.00
High	5795	2.00	30.00

Output Power Results

Channel	Frequency (MHz)	Meas Power (dBm)	Total Corr'd Power (dBm)	Power Limit (dBm)	Power Margin (dB)
Low	5755	20.53	20.53	30.00	-9.47
High	5795	20.32	20.32	30.00	-9.68

Note: the power readings above were measured with gated method, and the measurement was taken only during the ON time. No duty cycle correction was necessary.

ID:	37290	Date:	9/29/2016
------------	-------	--------------	-----------

4.3.2. Maximum Power Spectral Density (PSD)

LIMITS

FCC §15.407 (a) (3)

For the band 5.725-5.85 GHz, the maximum conducted output power over the frequency band of operation shall not exceed 1 W. In addition, the maximum power spectral density shall not exceed 30 dBm in any 500-kHz band. If transmitting antennas of directional gain greater than 6 dBi are used, both the maximum conducted output power and the maximum power spectral density shall be reduced by the amount in dB that the directional gain of the antenna exceeds 6 dBi.

DIRECTIONAL ANTENNA GAIN

There is only one transmitter output therefore the directional gain is equal to the antenna gain.

RESULTS

5725 - 5850MHz Band, 40MHz

Antenna Gain and Limits

Channel	Frequency (MHz)	Directional Gain (dBi)	PSD Limit (dBm)
Low	5755	2.00	30.00
High	5795	2.00	30.00

Duty Cycle CF (dB)	0.00	Included in Calculations of Corr'd PSD
--------------------	------	--

PSD Results

Channel	Frequency (MHz)	Meas PSD (dBm)	Total Corr'd PSD (dBm)	PSD Limit (dBm)	PSD Margin (dB)
Low	5755	-6.414	-6.414	30.00	-36.41
High	5795	-6.880	-6.880	30.00	-36.88

ID:	37290	Date:	9/29/2016
-----	-------	-------	-----------

5725 - 5850MHz Band, 40MHz

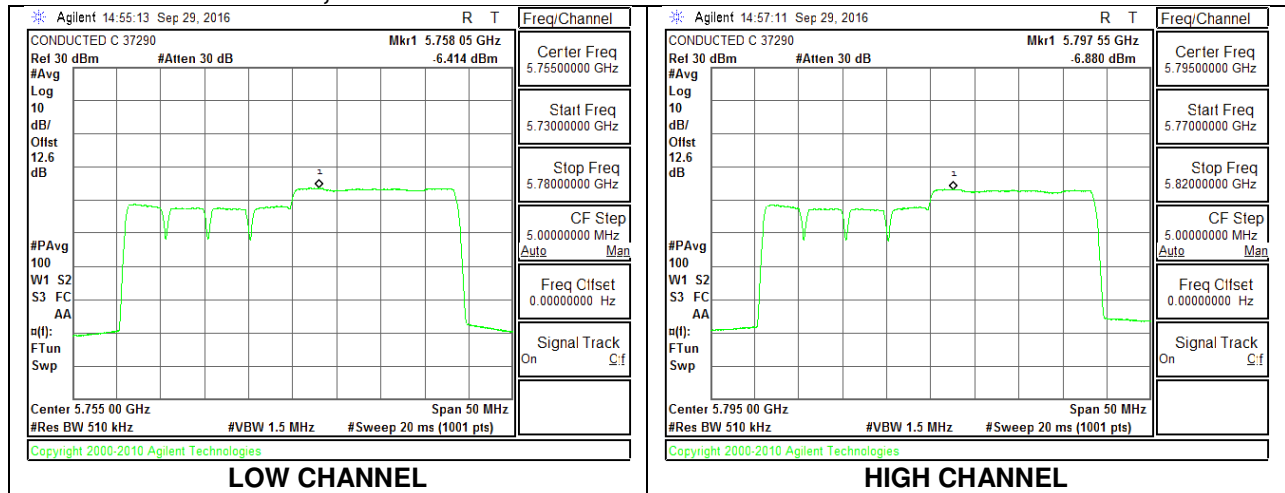

5. RADIATED TEST RESULTS

5.1. LIMITS AND PROCEDURE

LIMITS

FCC §15.205 and §15.209
 RSS Gen

Frequency Range (MHz)	Field Strength Limit (uV/m) at 3 m	Field Strength Limit (dBuV/m) at 3 m
0.009-0.490	2400/F(kHz) @ 300m	2400/F(kHz) @ 300m
0.490-1.705	24000/F(kHz) @ 30m	24000/F(kHz) @ 30m
1.705-30.0	30 @ 30m	30 @ 30m
30 - 88	100	40
88 - 216	150	43.5
216 - 960	200	46
Above 960	500	54

NOTE: KDB 937606 OATS and Chamber Correlation Justification

- Based on FCC 15.31 (f) (2): measurements may be performed at a distance closer than that specified in the regulations; however, an attempt should be made to avoid making measurements in the near field.
- OATs and chamber correlation testing had been performed and chamber measured test result is the worst case test result.

TEST PROCEDURE

The EUT is placed on a non-conducting table 80 cm above the ground plane for measurement below 1GHz; 1.5 m above the ground plane for measurement above 1GHz. The antenna to EUT distance is 3 meters. The EUT is configured in accordance with ANSI C63.10. The EUT is set to transmit in a continuous mode.

For measurements below 1 GHz the resolution bandwidth is set to 100 kHz for peak detection measurements or 120 kHz for quasi-peak detection measurements. Peak detection is used unless otherwise noted as quasi-peak.

For measurements above 1 GHz the resolution bandwidth is set to 1 MHz; the video bandwidth is set to 3 MHz for peak measurements and add duty cycle factor for average measurements. Please refer to test report section 4.1 for duty cycle factor information.

Note: The pre-scan measurements above 1GHz the VBW is set to 30 kHz.

The spectrum from 9 kHz to 40 GHz is investigated with the transmitter set to the lowest, middle, and highest channels in each applicable band.

The frequency range of interest is monitored at a fixed antenna height and EUT azimuth. The EUT is rotated through 360 degrees to maximize emissions received. The antenna is scanned from 1 to 4 meters above the ground plane to further maximize the emission. Measurements are made with the antenna polarized in both the vertical and the horizontal positions.

5.2. TRANSMITTER ABOVE 1 GHz

5.2.1. TX ABOVE 1 GHz; 30MHz MODE IN THE 5.8 GHz BAND

HARMONICS AND SPURIOUS EMISSIONS

LOW CHANNEL RESULTS

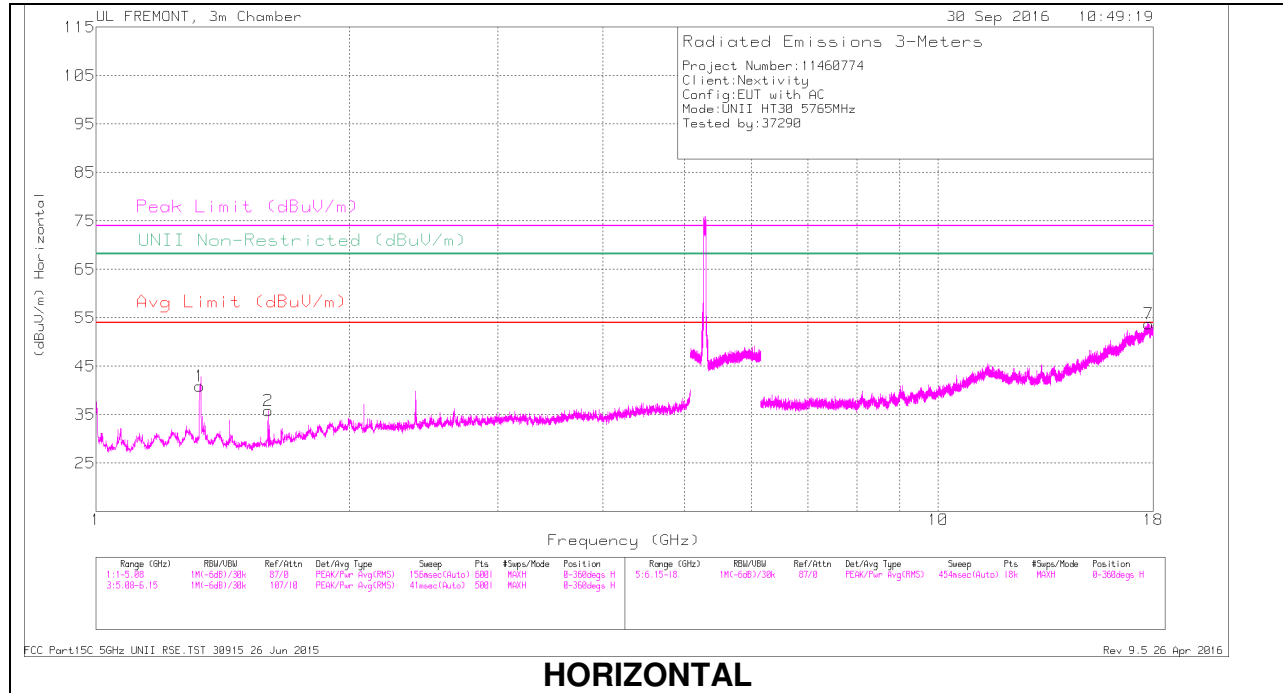

HORIZONTAL

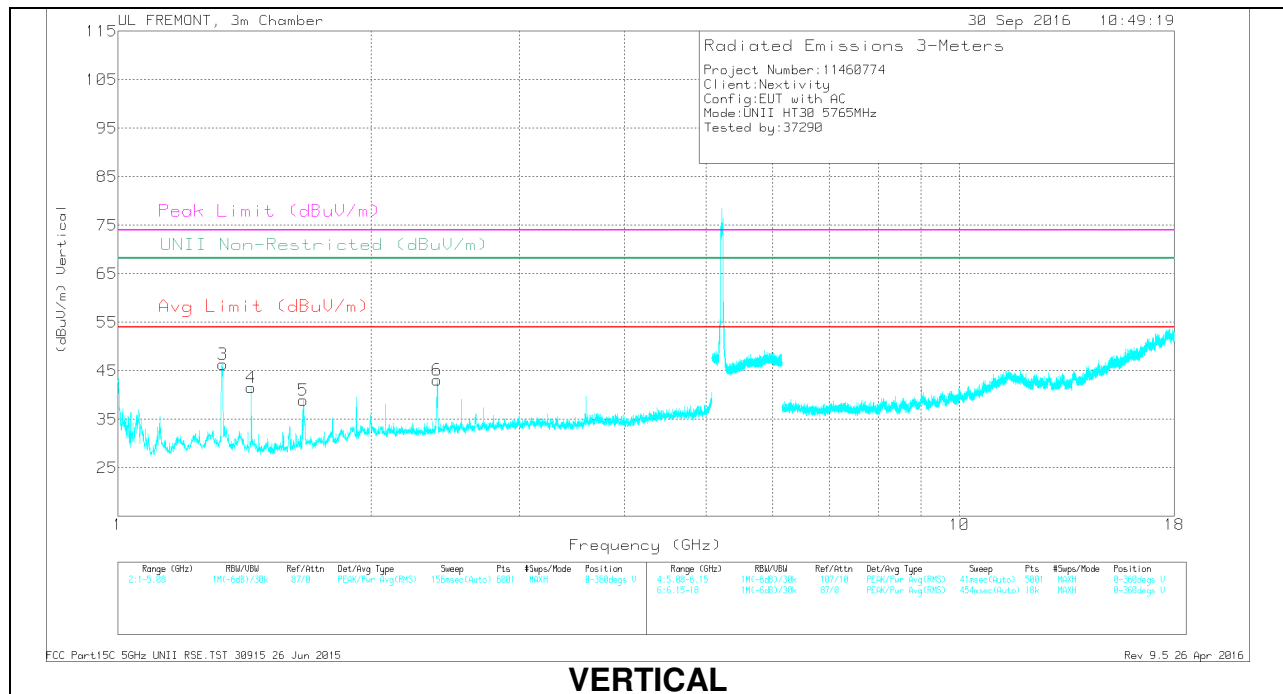

VERTICAL

LOW CHANNEL DATA

Marker	Frequenc y (GHz)	Meter Reading (dBuV)	Det	AF T119 (dB-m)	Amp/Cbl/Ftr/Pad (dB)	Correcte d Reading (dBuV/m)	Avg Limit (dBuV/m)	Margin (dB)	Peak Limit (dBuV/m)	PK Margin (dB)	UNII Non-Restricted (dBuV/m)	PK Margin (dB)	Azimuth (Degs)	Height (cm)	Polarity
1	1.331	38.63	ADR	29.6	-31.1	37.13	54	-16.87	-	-	-	-	201	288	H
	1.331	54.37	PK-U	29.6	-31.1	52.87	-	-	74	-21.13	-	-	44	200	V
3	1.332	48.27	PK-U	29.6	-31	46.87	-	-	74	-27.13	-	-	201	288	H
	1.333	44.41	ADR	29.6	-31	43.01	54	-10.99	-	-	-	-	44	200	V
4	1.44	47.88	PK-U	28.4	-31.5	44.79	-	-	74	-29.21	-	-	135	174	V
	1.44	31.77	ADR	28.4	-31.5	28.67	54	-25.33	-	-	-	-	135	174	V
2	1.6	40.09	PK-U	28	-30.7	37.39	-	-	74	-36.61	-	-	201	109	H
	1.6	28.03	ADR	28	-30.7	25.33	54	-28.67	-	-	-	-	201	109	H
5	1.661	50.49	PK-U	28.6	-30.8	48.29	-	-	74	-25.71	-	-	6	100	V
	1.663	32.85	ADR	28.6	-30.7	30.75	54	-23.25	-	-	-	-	6	100	V
6	2.396	51.68	PK-U	32.1	-30.2	53.58	-	-	-	-	68.2	-14.62	326	103	V
	2.397	31.02	ADR	32.1	-30.2	32.92	-	-	-	-	-	-	326	103	V
7	17.783	28.2	PK-U	41.5	-11.3	58.4	-	-	74	-15.6	-	-	9	229	H
	17.784	18.5	ADR	41.5	-11.3	48.7	54	-5.3	-	-	-	-	9	229	H

PK-U - U-NII: Maximum Peak
 ADR - U-NII AD primary method, RMS average

MID CHANNEL RESULTS

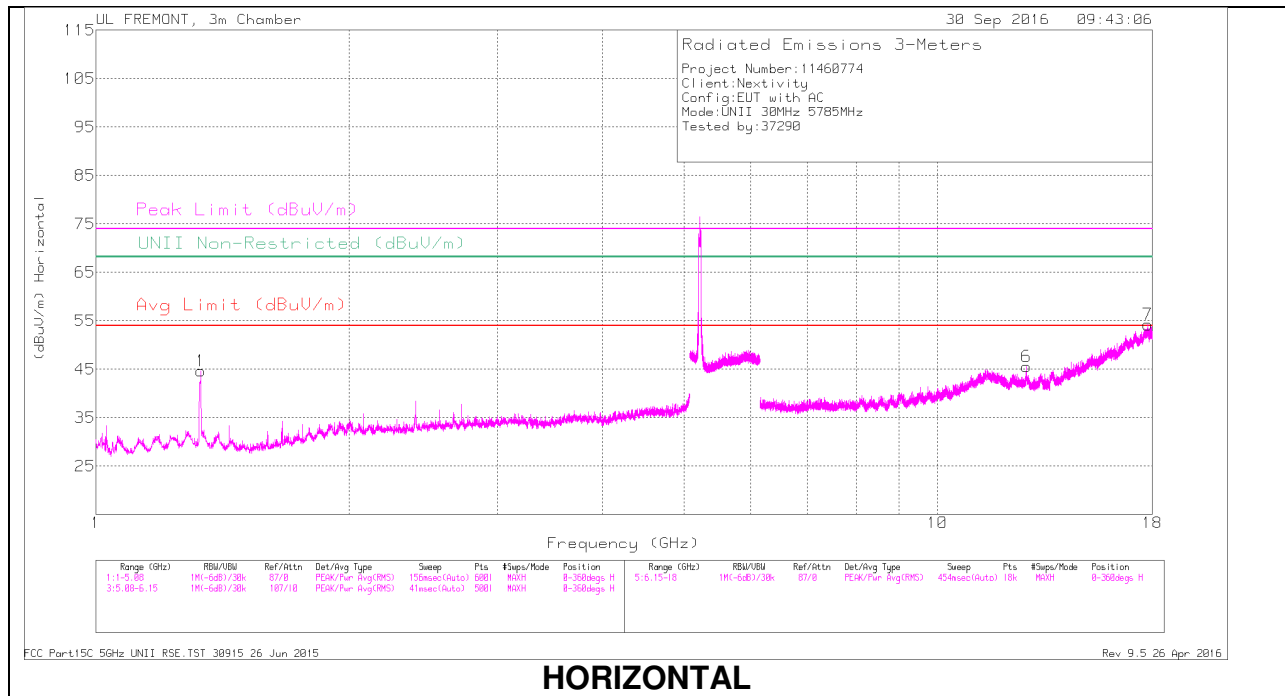

HORIZONTAL

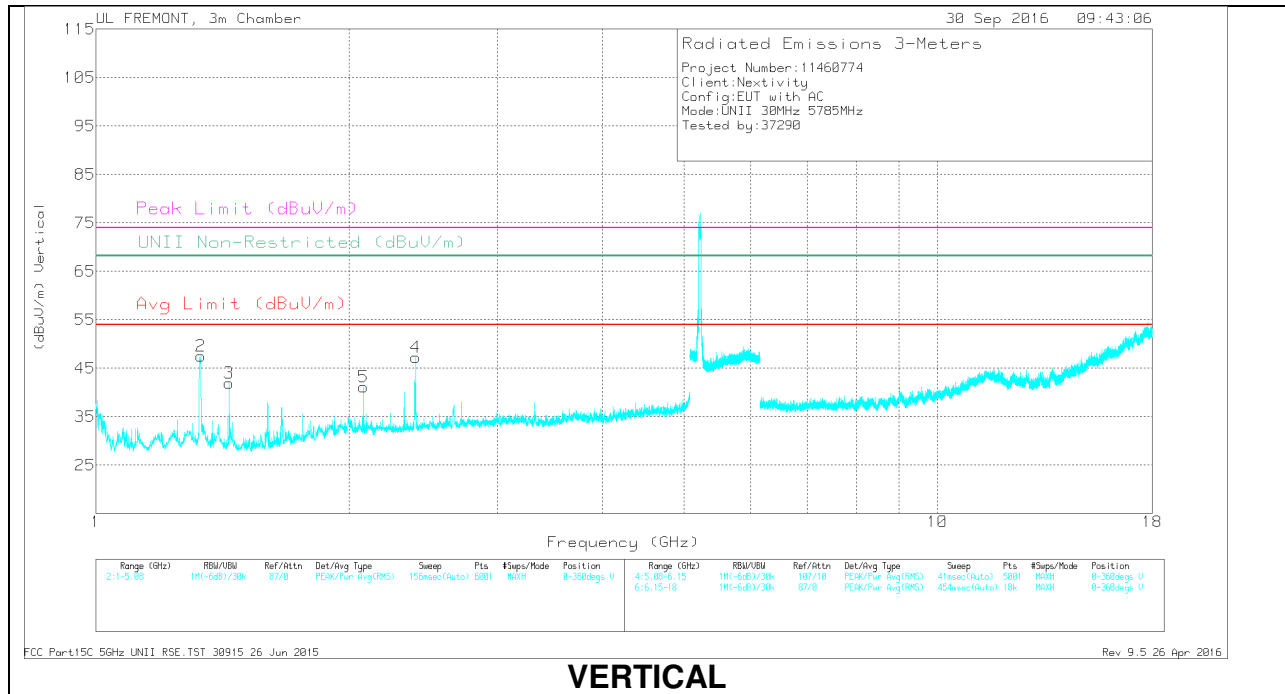

VERTICAL

MID CHANNEL DATA

Marker	Frequency (GHz)	Meter Reading (dBuV)	Det	AF 1119 (dB-m)	Amp-Cbl/Ftr/Pad (dB)	Corrected Reading (dBuV/m)	Avg Limit (dBuV/m)	Margin (dB)	Peak Limit (dBuV/m)	PK Margin (dB)	UNII Non-Restricted (dBuV/m)	PK Margin (dB)	Azimuth (Degs)	Height (cm)	Polarity
1	1.332	50.23	PK-U	29.6	-31.1	48.73	-	-	74	-25.27	-	-	164	396	H
	1.332	39.95	ADR	29.6	-31	38.55	54	-15.45	-	-	-	-	164	396	H
	1.332	54.17	PK-U	29.6	-31	52.77	-	-	74	-21.23	-	-	84	177	V
2	1.332	42.48	ADR	29.6	-31	41.08	-	-12.92	-	-	-	-	84	177	V
	1.44	51.63	PK-U	28.4	-31.5	48.53	-	-	74	-25.47	-	-	355	133	V
	1.44	36.81	ADR	28.4	-31.5	33.71	54	-20.29	-	-	-	-	355	133	V
5	2.08	44.42	PK-U	31.6	-30.5	45.52	-	-	-	-	68.2	-22.68	353	101	V
	2.08	30.93	ADR	31.6	-30.5	32.03	-	-	-	-	-	-	353	101	V
4	2.397	32.01	ADR	32.1	-30.2	33.91	-	-	-	-	-	-	336	384	V
	2.399	51.83	PK-U	32.1	-30.2	53.73	-	-	-	-	68.2	-14.47	336	384	V
6	12.758	19.07	ADR	39.4	-17.1	41.37	-	-	-	-	-	-	272	319	H
	12.759	29.4	PK-U	39.4	-17.1	51.7	-	-	-	-	68.2	-16.5	272	319	H
7	17.771	18.5	ADR	41.5	-10.9	49.1	54	-4.9	-	-	-	-	96	363	H
	17.773	28.21	PK-U	41.5	-10.9	58.81	-	-	74	-15.19	-	-	96	363	H

PK-U - U-NII: Maximum Peak
 ADR - U-NII AD primary method, RMS average

HIGH CHANNEL RESULTS

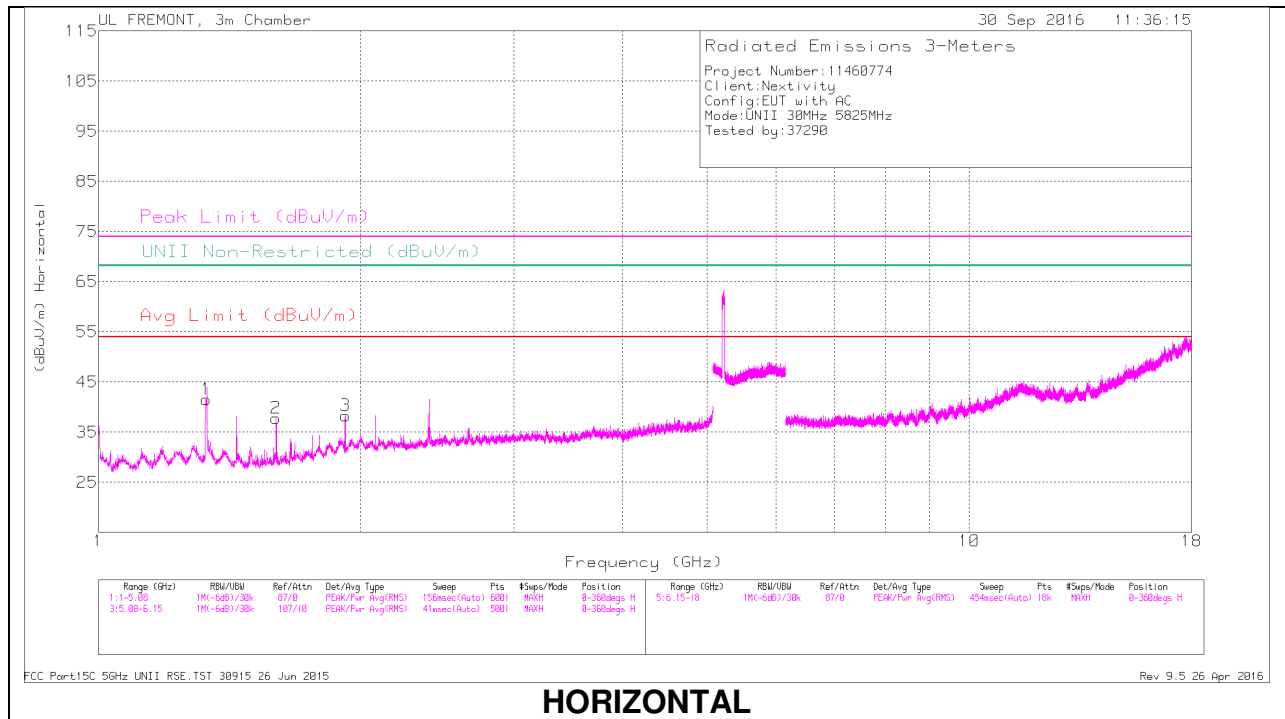

HORIZONTAL

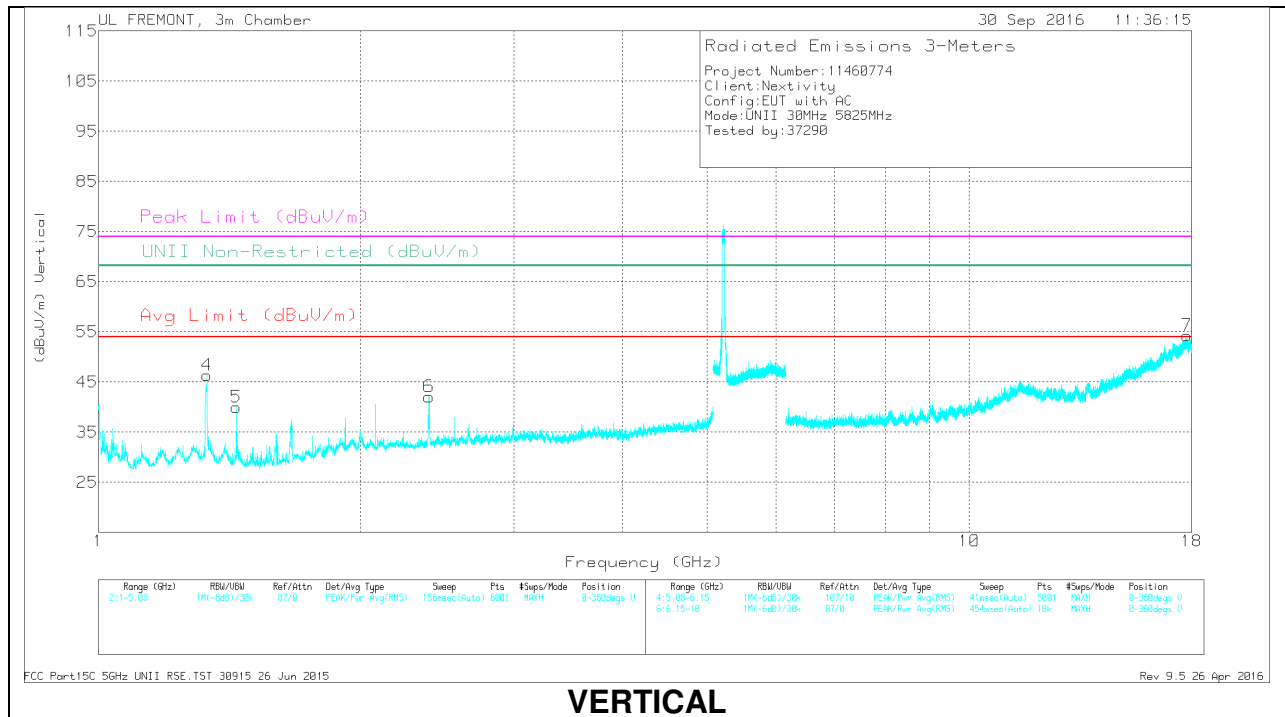

VERTICAL

HIGH CHANNEL DATA

Marker	Frequenc y (GHz)	Master Reading (dBuV)	Det	AF 1119 (dB-m)	Amp-Cbl/Filt/Pad (dB)	Correcte d Reading (dBuV/m)	Avg Limit (dBuV/m)	Margin (dB)	Peak Limit (dBuV/m)	PK Margin (dB)	UNI Non-Restricted (dBuV/m)	PK Margin (dB)	Azimuth (Degs)	Height (cm)	Polarity
1	1.33	40.19	ADR	29.6	-31.1	38.69	54	-15.31	-	-	-	-	131	234	H
	1.331	51.74	PK-U	29.6	-31.1	50.24	-	-	74	-23.76	-	-	131	234	H
4	1.332	44.19	ADR	29.6	-31	42.79	54	-11.21	-	-	-	-	89	161	V
	1.333	53.56	PK-U	29.6	-31	52.16	-	-	74	-21.84	-	-	89	161	V
5	1.44	50.35	PK-U	28.4	-31.5	47.25	-	-	74	-26.75	-	-	343	294	V
	1.44	32.88	ADR	28.4	-31.5	29.78	54	-24.22	-	-	-	-	343	294	V
2	1.6	48.66	PK-U	28	-30.7	45.96	-	-	74	-28.04	-	-	350	274	H
	1.6	31.43	ADR	28	-30.7	28.73	54	-25.27	-	-	-	-	350	274	H
3	1.92	44.54	PK-U	31.4	-30.6	45.34	-	-	-	-	68.2	-22.86	356	141	H
	1.92	30.6	ADR	31.4	-30.6	31.4	-	-	-	-	-	-	356	141	H
6	2.397	30.76	ADR	32.1	-30.2	32.66	-	-	-	-	-	-	340	155	V
	2.398	49.95	PK-U	32.1	-30.2	51.85	-	-	-	-	68.2	-16.35	340	155	V
7	17.772	28.97	PK-U	41.5	-10.9	59.57	-	-	74	-14.43	-	-	340	100	V
	17.772	18.93	ADR	41.5	-10.9	49.53	54	-4.47	-	-	-	-	340	100	V

PK-U - U-NII: Maximum Peak

ADR - U-NII AD primary method, RMS average

5.2.2. TX ABOVE 1 GHz; 40MHz MODE IN THE 5.8 GHz BAND

HARMONICS AND SPURIOUS EMISSIONS

LOW CHANNEL RESULTS

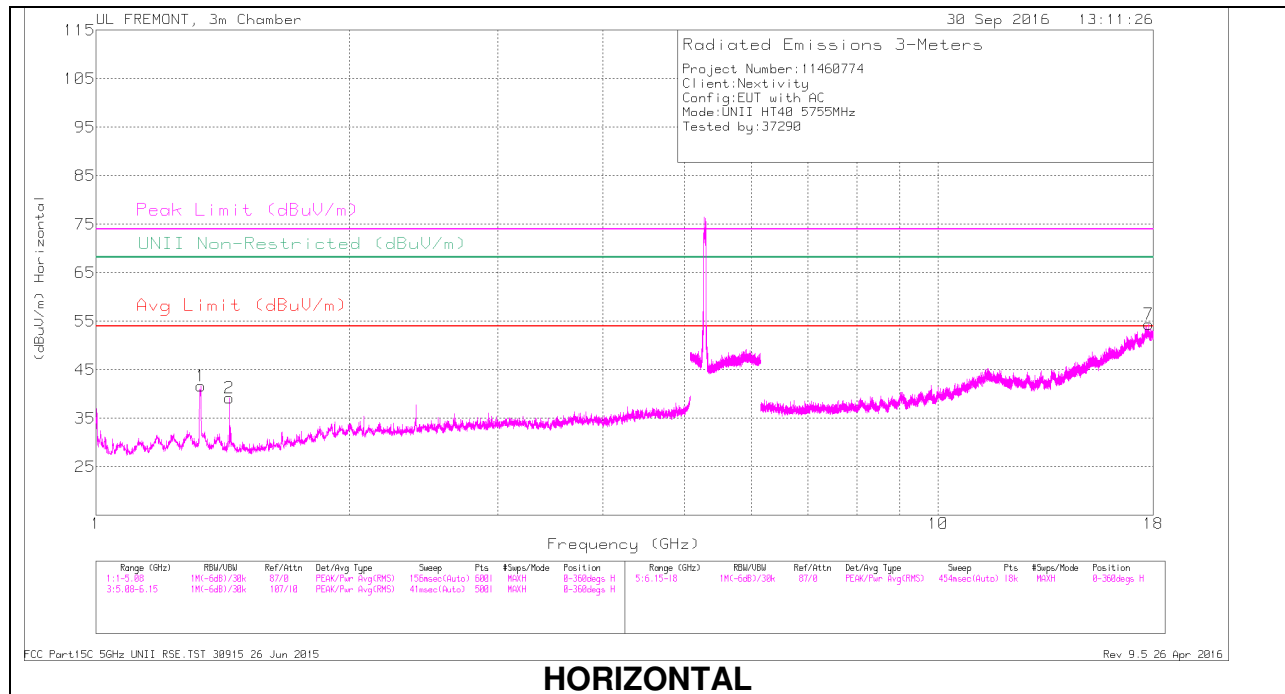

HORIZONTAL

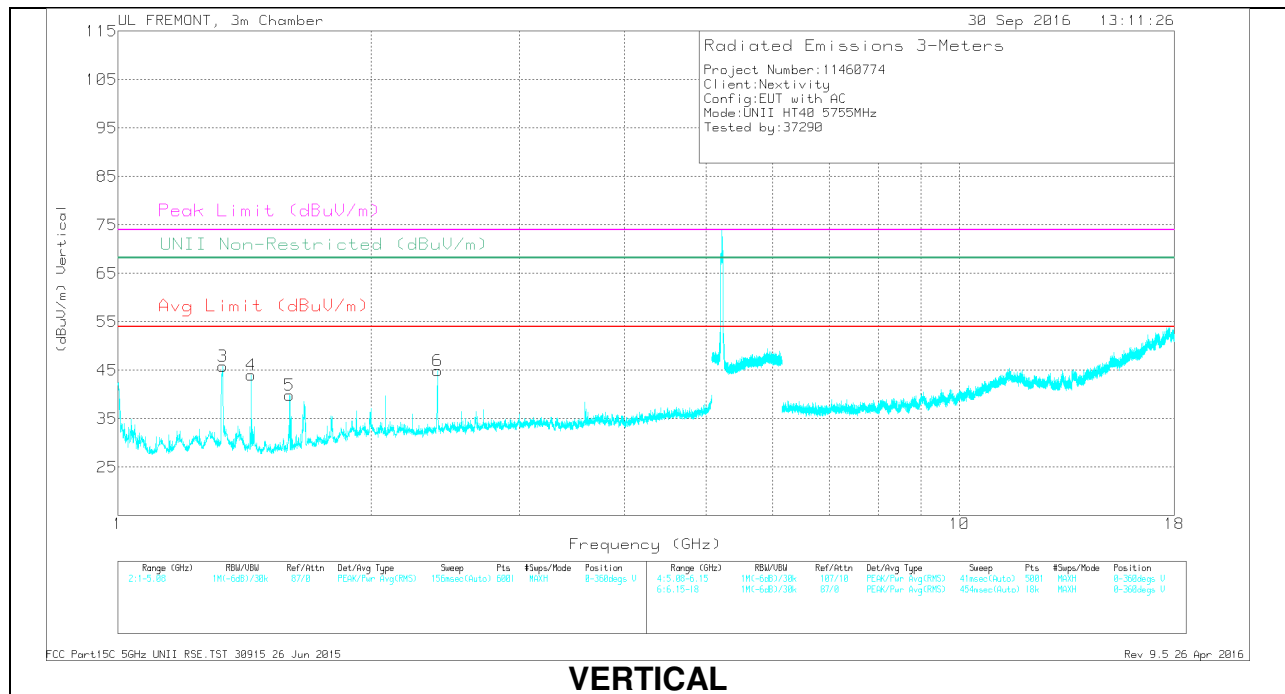

VERTICAL

LOW CHANNEL DATA

Marker	Frequenc y (GHz)	Master Reading (dBuV)	Det	AF T119 (dB-m)	Amp-Cbl/Filt/Pad (dB)	Correcte d Reading (dBuV/m)	Avg Limit (dBuV/m)	Margin (dB)	Peak Limit (dBuV/m)	PK Margin (dB)	UNII Non-Restricted (dBuV/m)	PK Margin (dB)	Azimuth (Degs)	Height (cm)	Polarity
3	1.328	48.66	PK-U	29.6	-31.1	47.15	-	-	74	-26.84	-	-	66	199	H
	1.332	37.84	ADR	29.6	-31	36.44	54	-17.56	-	-	-	-	66	199	H
1	1.332	42.92	ADR	29.6	-31	41.52	54	-12.48	-	-	-	-	83	209	V
	1.333	52.82	PK-U	29.6	-31	51.42	-	-	74	-22.58	-	-	83	209	V
2	1.44	49.81	PK-U	28.4	-31.5	46.71	-	-	74	-27.29	-	-	7	127	H
	1.44	34.83	ADR	28.4	-31.5	31.73	54	-22.27	-	-	-	-	7	127	H
4	1.44	49.98	PK-U	28.4	-31.5	46.88	-	-	74	-27.12	-	-	120	182	V
	1.44	29.48	ADR	28.4	-31.5	26.38	54	-27.62	-	-	-	-	120	182	V
5	1.6	45.06	PK-U	28	-30.7	42.36	-	-	74	-31.64	-	-	243	229	V
	1.6	29.23	ADR	28	-30.7	26.53	54	-27.47	-	-	-	-	243	229	V
6	2.399	46.7	PK-U	32.1	-30.2	48.6	-	-	-	-	68.2	-19.6	331	187	V
	2.4	31.42	ADR	32.1	-30.2	33.32	-	-	-	-	-	-	331	187	V
7	17.771	19	ADR	41.5	-10.9	49.6	54	-4.4	-	-	-	-	331	200	H
	17.772	28.73	PK-U	41.5	-10.9	59.33	-	-	74	-14.67	-	-	331	200	H

PK-U - U-NII: Maximum Peak

ADR - U-NII AD primary method, RMS average

HIGH CHANNEL RESULTS

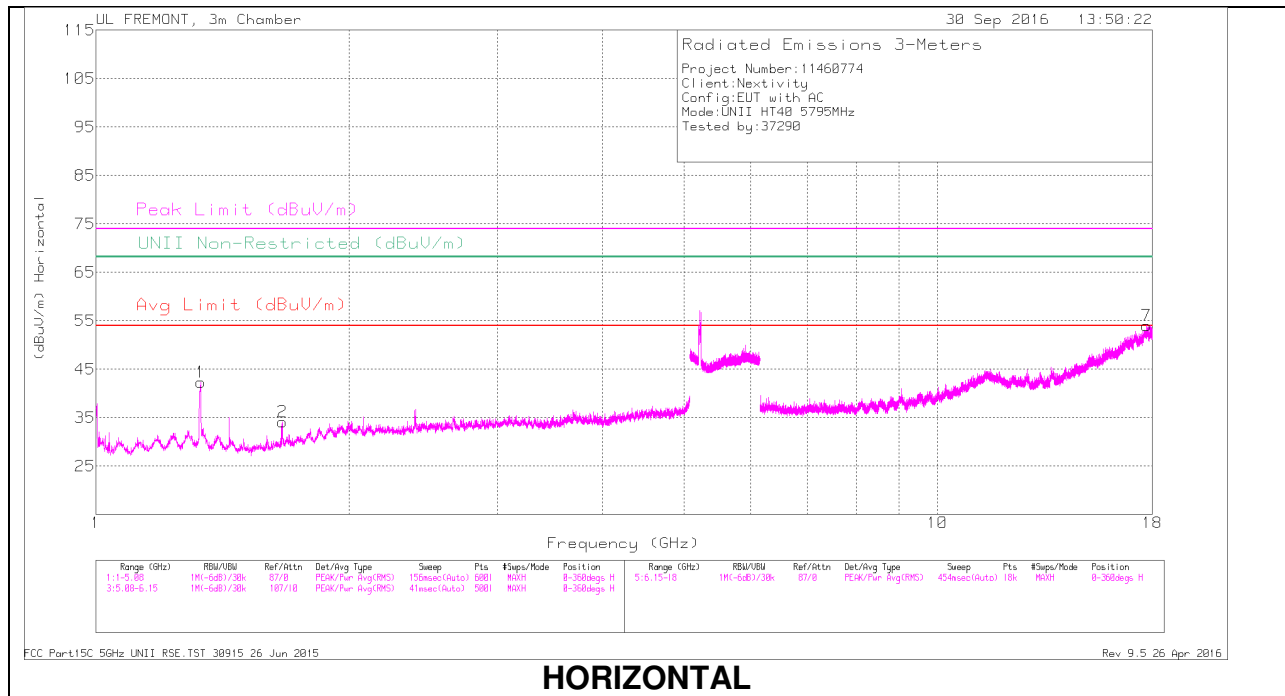

HORIZONTAL

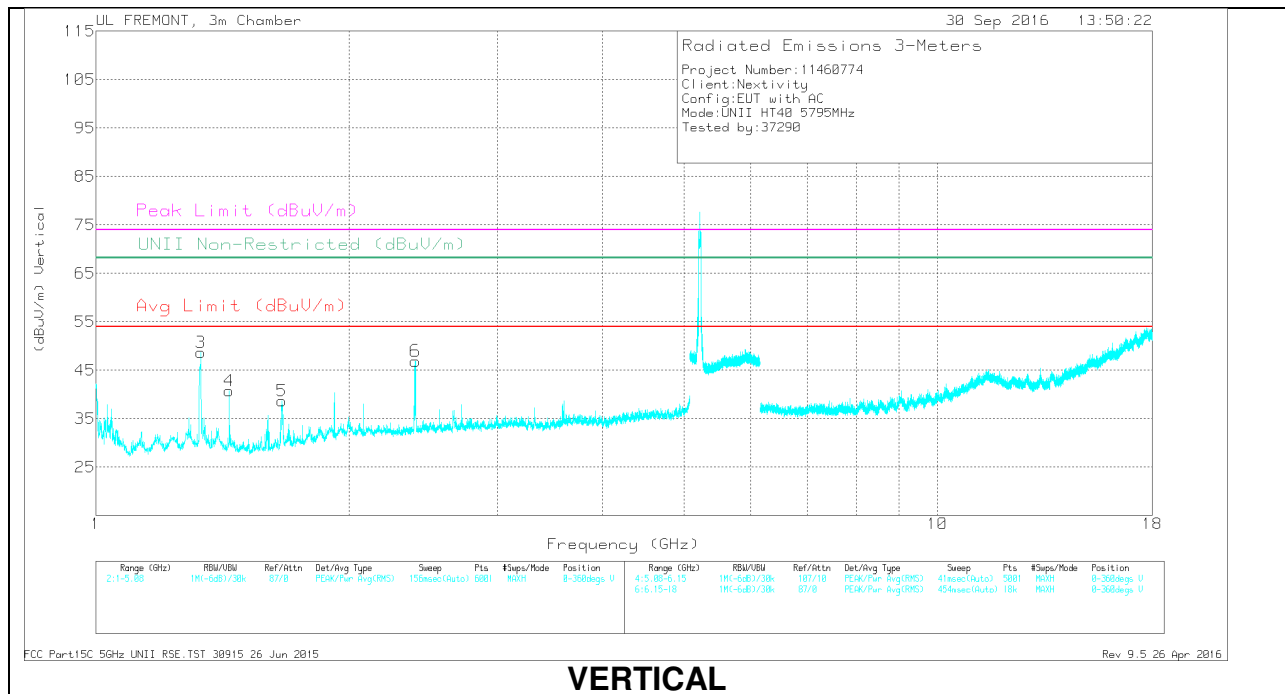

VERTICAL

HIGH CHANNEL DATA

Marker	Frequency (GHz)	Master Reading (dBuV)	Det	AF T119 (dBm)	Amp/Cbl/Filt/Pad (dB)	Corrected Reading (dBuV/m)	Avg Limit (dBuV/m)	Margin (dB)	Peak Limit (dBuV/m)	PK Margin (dB)	UNII Non-Restricted (dBuV/m)	PK Margin (dB)	Azimuth (Degs)	Height (cm)	Polarity
1	1.332	50.74	PK-U	29.6	-31	49.34	-	-	74	-24.66	-	-	51	213	H
	1.332	53.01	PK-U	29.6	-31	51.61	-	-	74	-22.39	-	-	79	204	V
3	1.332	42.58	ADR	29.6	-31	41.18	54	-12.82	-	-	-	-	79	204	V
	1.333	36.04	ADR	29.6	-31	34.64	54	-19.36	-	-	-	-	51	213	H
4	1.44	48.8	PK-U	28.4	-31.5	45.7	-	-	74	-28.3	-	-	122	158	V
	1.44	34.79	ADR	28.4	-31.5	31.69	54	-22.31	-	-	-	-	122	158	V
5	1.662	49.21	PK-U	28.6	-30.7	47.11	-	-	74	-26.89	-	-	7	152	V
	1.663	44.19	PK-U	28.6	-30.7	42.09	-	-	74	-31.91	-	-	171	307	H
2	1.663	28.59	ADR	28.6	-30.7	26.49	54	-27.51	-	-	-	-	171	307	H
	1.664	31.83	ADR	28.6	-30.7	29.73	54	-24.27	-	-	-	-	7	152	V
6	2.397	51.45	PK-U	32.1	-30.2	53.35	-	-	-	-	68.2	-14.85	349	109	V
	2.397	31.75	ADR	32.1	-30.2	33.65	-	-	-	-	-	-	349	109	V
7	17.705	29.61	PK-U	41.4	-11.3	59.71	-	-	74	-14.29	-	-	107	100	H
	17.707	18.32	ADR	41.4	-11.3	48.42	54	-5.58	-	-	-	-	107	100	H

PK-U - U-NII: Maximum Peak

ADR - U-NII AD primary method, RMS average

5.3. WORST-CASE 18 GHz – 26 GHz

SPURIOUS EMISSIONS 18-26 GHz (WORST-CASE CONFIGURATION)

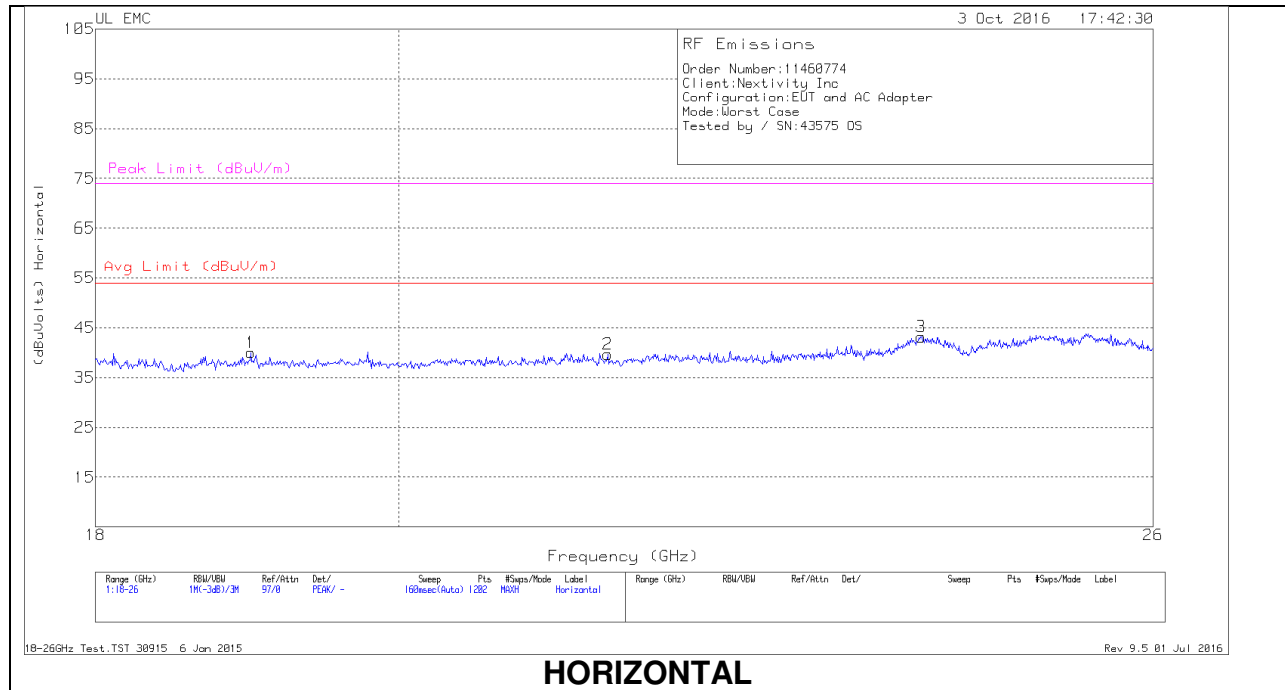

HORIZONTAL

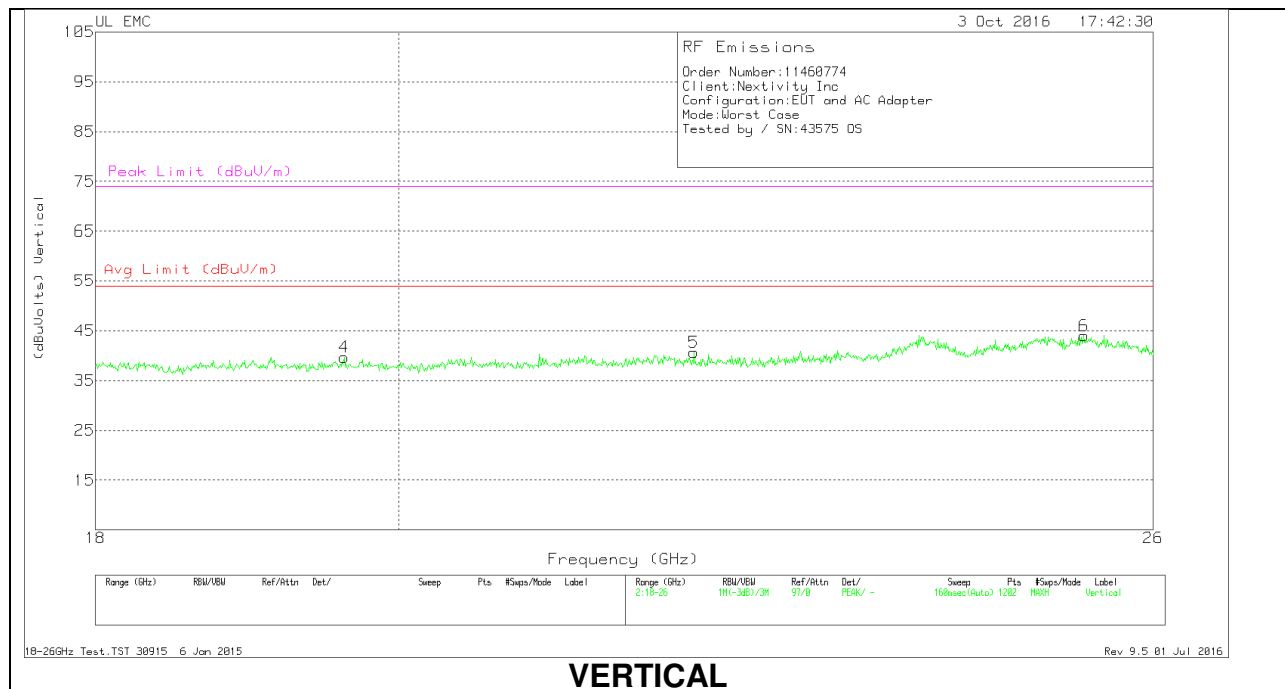

VERTICAL

DATA

Marker	Frequenc y (GHz)	Meter Reading (dBuV)	Det	AF T449 (dB/m)	Amp/Cbl (dB)	Dist Corr (dB)	Corrected Reading (dBuVolts)	Avg Limit (dBuV/m)	Margin (dB)	Peak Limit (dBuV/m)	PK Margin (dB)
1	18.999	41.7	Pk	32.6	-24.8	-9.5	40	54	-14	74	-34
2	21.51	41.37	Pk	33.2	-25.4	-9.5	39.67	54	-14.33	74	-34.33
3	23.985	42.97	Pk	34	-24.3	-9.5	43.17	54	-10.83	74	-30.83
4	19.625	41.37	Pk	32.7	-24.9	-9.5	39.67	54	-14.33	74	-34.33
5	22.163	41.37	Pk	33.5	-24.7	-9.5	40.67	54	-13.33	74	-33.33
6	25.381	43.7	Pk	34.3	-24.5	-9.5	44	54	-10	74	-30

Pk - Peak detector

5.4. WORST-CASE 26 GHz – 40 GHz

SPURIOUS EMISSIONS 26-40 GHz (WORST-CASE CONFIGURATION)

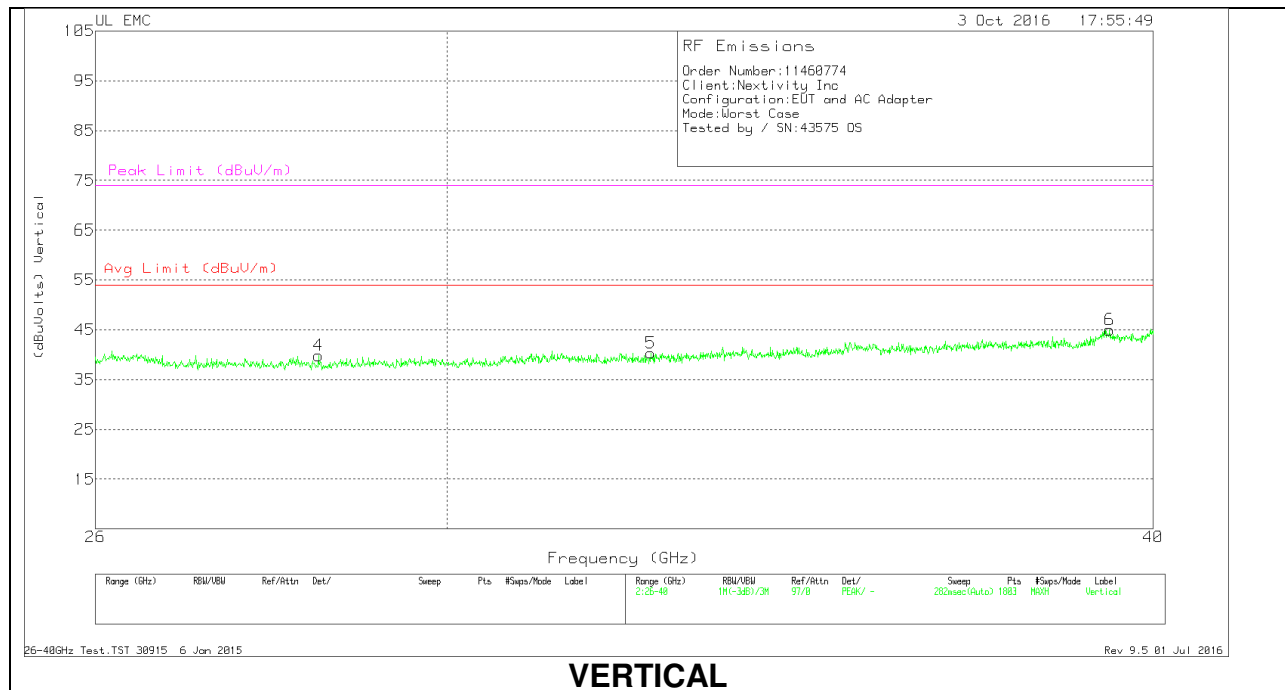
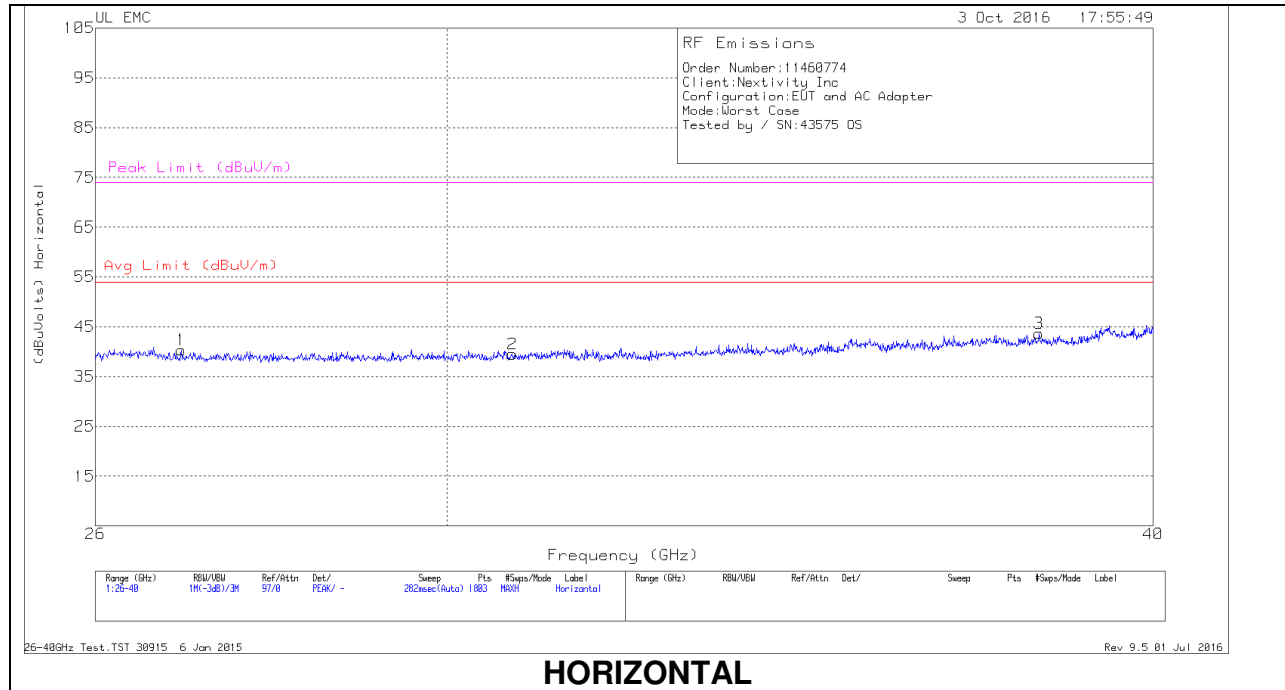

DATA

Marker	Frequenc y (GHz)	Meter Reading (dBuV)	Det	T90 AF (dB/m)	Amp/Cbl (dB)	Dist Corr (dB)	Corrected Reading (dBuVolts)	Avg Limit (dBuV/m)	Margin (dB)	Peak Limit (dBuV/m)	PK Margin (dB)
1	26.925	45.93	Pk	35.4	-31.5	-9.5	40.33	54	-13.67	74	-33.67
2	30.809	46.1	Pk	36	-33.1	-9.5	39.5	54	-14.5	74	-34.5
3	38.182	49.37	Pk	37.2	-33.4	-9.5	43.67	54	-10.33	74	-30.333
4	28.471	45.83	Pk	35.7	-32.2	-9.5	39.83	54	-14.17	74	-34.17
5	32.596	46.83	Pk	36.3	-33.3	-9.5	40.33	54	-13.67	74	-33.67
6	39.293	48.6	Pk	38.4	-32.5	-9.5	45	54	-9	74	-29

Pk - Peak detector

5.5. WORST-CASE BELOW 1 GHz

SPURIOUS EMISSIONS 30 TO 1000 MHz (WORST-CASE CONFIGURATION)

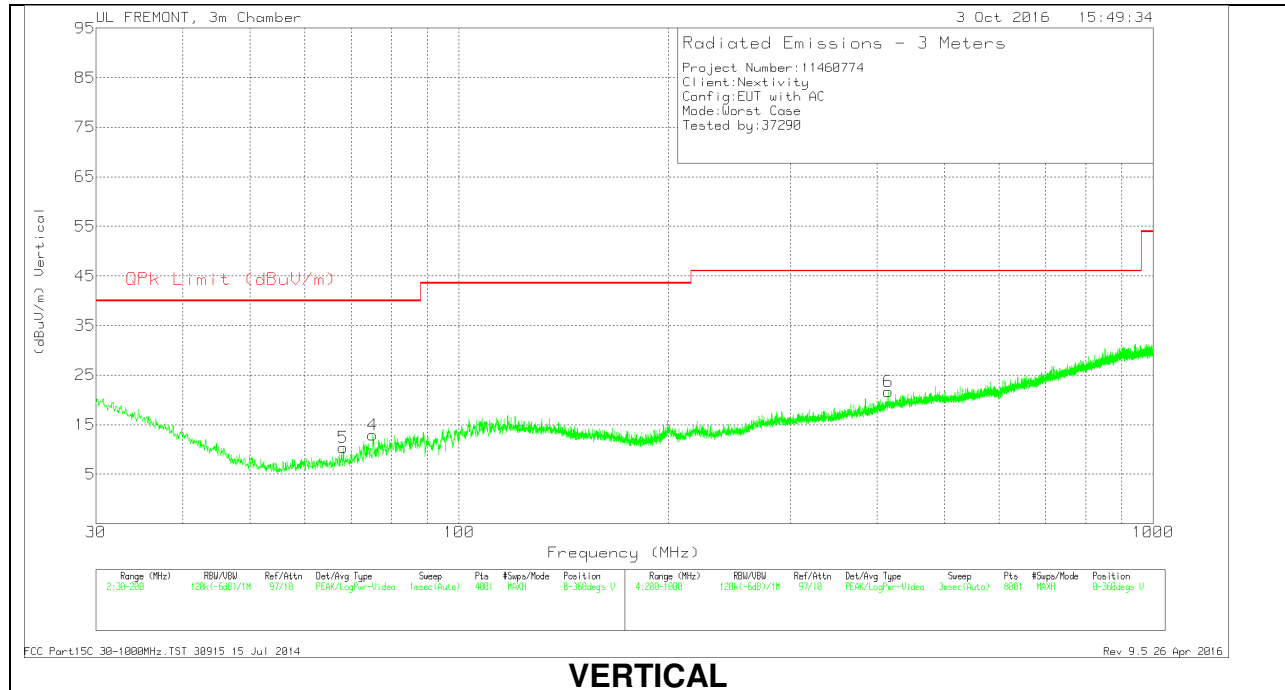
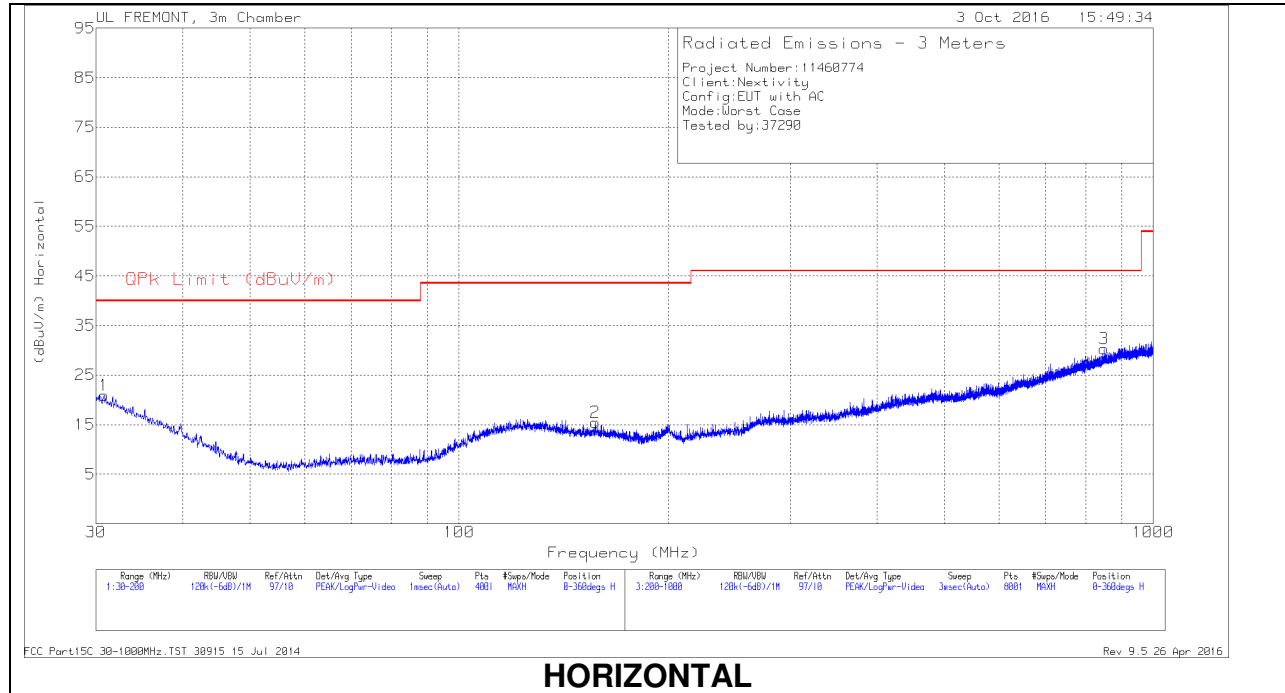

DATA

Marker	Frequency (MHz)	Meter Reading (dBuV)	Det	AF T122 (dB/m)	Amp/Cbl (dB)	Corrected Reading (dBuV/m)	QPk Limit (dBuV/m)	Margin (dB)	Azimuth (Degs)	Height (cm)	Polarity
1	30.8075	23.45	Pk	24.7	-27.2	20.95	40	-19.05	0-360	400	H
5	68.1225	25.17	Pk	11.9	-26.7	10.37	40	-29.63	0-360	100	V
4	75.135	27.55	Pk	11.9	-26.6	12.85	40	-27.15	0-360	100	V
2	157.0325	24.69	Pk	16.3	-25.6	15.39	43.52	-28.13	0-360	100	H
6	415.1	26.12	Pk	20.1	-24.6	21.62	46.02	-24.4	0-360	200	V
3	849.3	26.94	Pk	25.7	-22.4	30.24	46.02	-15.78	0-360	100	H

Pk - Peak detector

5.6. WORST-CASE BELOW 30 MHz

SPURIOUS EMISSIONS 0.001-30 MHz (WORST-CASE CONFIGURATION)

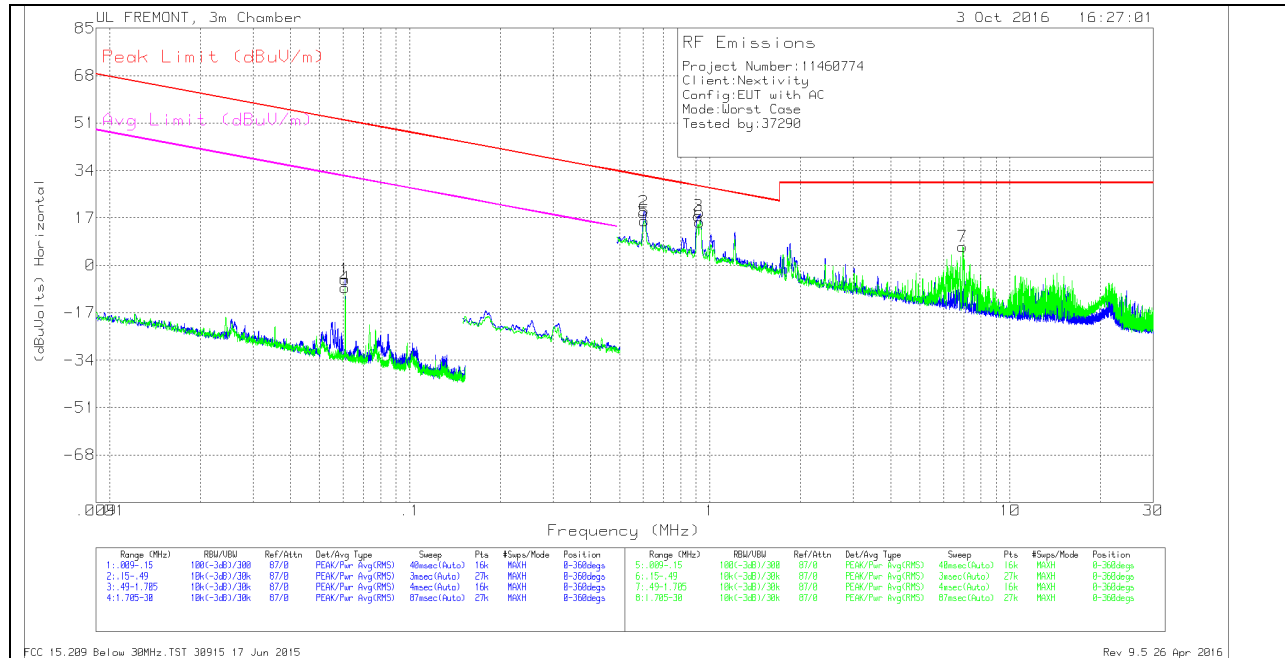

DATA

Marker	Frequency (MHz)	Meter Reading (dBuV)	Det	Loop Antenna (dB/m)	Cbl (dB)	Dist Corr 300m	Corrected Reading (dBuV/m)	Peak Limit (dBuV/m)	Margin (dB)	Avg Limit (dBuV/m)	Margin (dB)	Azimuth (Degs)
1	.06087	62.48	Pk	11.1	1.4	-80	-5.02	51.92	-56.94	31.92	-36.94	0-360
4	.06088	59.55	PK	11.1	1.4	-80	-7.95	51.91	-59.86	31.91	-39.86	0-360
2	.6024	46.89	Pk	10.6	1.5	-40	18.99	32.01	-13.02	-	-	0-360
5	.60487	43.92	PK	10.6	1.5	-40	16.02	31.97	-15.95	-	-	0-360
3	.91492	45.5	PK	10.7	1.5	-40	17.7	28.38	-10.68	-	-	0-360
6	.9248	43.31	PK	10.7	1.5	-40	15.51	28.28	-12.77	-	-	0-360
7	6.95862	34.2	PK	10.9	1.5	-40	6.6	29.54	-22.94	-	-	0-360

Pk - Peak detector