

EMC Test Report

Application for Grant of Equipment Authorization

Industry Canada RSS-Gen Issue 3 / RSS 210 Issue 8 FCC Part 15, Subpart E

Model: D32-2/4NU and D32-2/4CU

FCC ID: YETD24NU and YETD24CU

APPLICANT: Nextivity Inc.
12230 World Trade Drive Suite 250
San Diego, CA 92128

TEST SITE(S): National Technical Systems - Silicon Valley
41039 Boyce Road.
Fremont, CA. 94538-2435

IC SITE REGISTRATION #: 2845B-5 and 2845B-7

REPORT DATE: April 22, 2014

FINAL TEST DATES: March 10, 11, 12, 13, 14, 16, 17 and 24, 2014

TOTAL NUMBER OF PAGES: 108

PROGRAM MGR /
TECHNICAL REVIEWER:

QUALITY ASSURANCE DELEGATE /
FINAL REPORT PREPARER:



Deniz Demirci
Senior Wireless / EMC Engineer

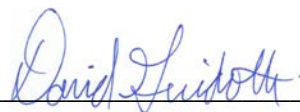

David Guidotti
Senior Technical Writer



National Technical Systems - Silicon Valley is accredited by the A2LA, certificate number 0214.26, to perform the test(s) listed in this report, except where noted otherwise. This report and the information contained herein represent the results of testing test articles identified and selected by the client performed to specifications and/or procedures selected by the client. National Technical Systems (NTS) makes no representations, expressed or implied, that such testing is adequate (or inadequate) to demonstrate efficiency, performance, reliability, or any other characteristic of the articles being tested, or similar products. This report should not be relied upon as an endorsement or certification by NTS of the equipment tested, nor does it represent any statement whatsoever as to its merchantability or fitness of the test article, or similar products, for a particular purpose. This report shall not be reproduced except in full

REVISION HISTORY

Rev#	Date	Comments	Modified By
	April 22, 2014	First release	

TABLE OF CONTENTS

REVISION HISTORY2

TABLE OF CONTENTS3

SCOPE.....4

OBJECTIVE4

STATEMENT OF COMPLIANCE.....5

DEVIATIONS FROM THE STANDARDS.....5

TEST RESULTS SUMMARY6

 UNII / LELAN DEVICES6

 GENERAL REQUIREMENTS APPLICABLE TO ALL BANDS.....8

 MEASUREMENT UNCERTAINTIES.....8

EQUIPMENT UNDER TEST (EUT) DETAILS.....9

 GENERAL.....9

 FREQUENCY LIST OF EUT9

 ANTENNA SYSTEM10

 ENCLOSURE.....10

 MODIFICATIONS.....10

 SUPPORT EQUIPMENT.....10

 EUT INTERFACE PORTS10

 EUT OPERATION10

TEST SITE.....11

 GENERAL INFORMATION.....11

 CONDUCTED EMISSIONS CONSIDERATIONS11

 RADIATED EMISSIONS CONSIDERATIONS11

MEASUREMENT INSTRUMENTATION12

 RECEIVER SYSTEM12

 INSTRUMENT CONTROL COMPUTER12

 LINE IMPEDANCE STABILIZATION NETWORK (LISN).....12

 FILTERS/ATTENUATORS13

 ANTENNAS.....13

 ANTENNA MAST AND EQUIPMENT TURNTABLE.....13

 INSTRUMENT CALIBRATION.....13

TEST PROCEDURES14

 EUT AND CABLE PLACEMENT14

 CONDUCTED EMISSIONS.....14

 RADIATED EMISSIONS15

 CONDUCTED EMISSIONS FROM ANTENNA PORT17

 BANDWIDTH MEASUREMENTS17

 SPECIFICATION LIMITS AND SAMPLE CALCULATIONS18

 CONDUCTED EMISSIONS SPECIFICATION LIMITS: FCC 15.207; FCC 15.107(A), RSS GEN18

 GENERAL TRANSMITTER RADIATED EMISSIONS SPECIFICATION LIMITS19

 RECEIVER RADIATED SPURIOUS EMISSIONS SPECIFICATION LIMITS19

 FCC 15.407 (A) OUTPUT POWER LIMITS19

 OUTPUT POWER LIMITS –LELAN DEVICES.....20

 SPURIOUS EMISSIONS LIMITS –UNII AND LELAN DEVICES20

 SAMPLE CALCULATIONS - CONDUCTED EMISSIONS21

 SAMPLE CALCULATIONS - RADIATED EMISSIONS.....21

 SAMPLE CALCULATIONS - FIELD STRENGTH TO EIRP CONVERSION.....22

APPENDIX A TEST EQUIPMENT CALIBRATION DATA23

APPENDIX B TEST DATA25

END OF REPORT108

SCOPE

An electromagnetic emissions test has been performed on the Nextivity Inc. model D32-2/4NU and D32-2/4CU, pursuant to the following rules:

Industry Canada RSS-Gen Issue 3

RSS 210 Issue 8 “Low-power Licence-exempt Radiocommunication Devices (All Frequency Bands): Category I Equipment”

FCC Part 15, Subpart E requirements for UNII Devices

Conducted and radiated emissions data has been collected, reduced, and analyzed within this report in accordance with measurement guidelines set forth in the following reference standards and as outlined in National Technical Systems - Silicon Valley test procedures:

ANSI C63.10-2009

FCC General UNII Test Procedures KDB789033

The intentional radiator above has been tested in a simulated typical installation to demonstrate compliance with the relevant Industry Canada performance and procedural standards.

Final system data was gathered in a mode that tended to maximize emissions by varying orientation of EUT, orientation of power and I/O cabling, antenna search height, and antenna polarization.

Every practical effort was made to perform an impartial test using appropriate test equipment of known calibration. All pertinent factors have been applied to reach the determination of compliance.

OBJECTIVE

The primary objective of the manufacturer is compliance with the regulations outlined in the previous section.

Prior to marketing in the USA, all unlicensed transmitters and transceivers require certification. Receive-only devices operating between 30 MHz and 960 MHz are subject to either certification or a manufacturer’s declaration of conformity, with all other receive-only devices exempt from the technical requirements.

Prior to marketing in Canada, Class I transmitters, receivers and transceivers require certification. Class II devices are required to meet the appropriate technical requirements but are exempt from certification requirements.

Certification is a procedure where the manufacturer submits test data and technical information to a certification body and receives a certificate or grant of equipment authorization upon successful completion of the certification body’s review of the submitted documents. Once the equipment authorization has been obtained, the label indicating compliance must be attached to all identical units, which are subsequently manufactured.

Maintenance of compliance is the responsibility of the manufacturer. Any modification of the product which may result in increased emissions should be checked to ensure compliance has been maintained (i.e., printed circuit board layout changes, different line filter, different power supply, harnessing or I/O cable changes, etc.).

Testing was performed only on model D32-2/4NU and D32-2/4CU.

STATEMENT OF COMPLIANCE

The tested sample of Nextivity Inc. model D32-2/4NU and D32-2/4CU complied with the requirements of the following regulations:

RSS 210 Issue 8 “Low-power Licence-exempt Radiocommunication Devices (All Frequency Bands): Category I Equipment”
FCC Part 15, Subpart E requirements for UNII Devices

Maintenance of compliance is the responsibility of the manufacturer. Any modifications to the product should be assessed to determine their potential impact on the compliance status of the device with respect to the standards detailed in this test report.

The test results recorded herein are based on a single type test of Nextivity Inc. model D32-2/4NU and D32-2/4CU and therefore apply only to the tested sample. The sample was selected and prepared by Michiel Lotter of Nextivity Inc..

DEVIATIONS FROM THE STANDARDS

No deviations were made from the published requirements listed in the scope of this report.

TEST RESULTS SUMMARY**UNII / LELAN DEVICES****Operation in the 5.15 – 5.25 GHz Band**

FCC Rule Part	RSS Rule Part	Description	Measured Value / Comments	Limit / Requirement	Result
15.407(e)		Indoor operation only	Refer to user's manual	N/A	Complies
15.407(a) (2)		26 dB Bandwidth	NU: 30.6 MHz	N/A – limits output power if < 20 MHz	N/A
15.407 (a) (1)	A9.2(1)	Output Power	NU: 16.0 dBm (Max eirp: 158.5 mW)	17 dBm	Complies
15.407 (a) (1)	-	Power Spectral Density	NU: 2.6 dBm/MHz	4 dBm/MHz	Complies
-	A9.5 (2)			4 dBm/MHz	Complies

Operation in the 5.25 – 5.35 GHz Band

Note: The device is restricted to indoor use only, therefore the spectral density of spurious emissions in the 5.15 – 5.25 GHz band were limited to the power spectral limits for intentional signals detailed in FCC 15.407(a)(1) and RSS 210 6.2.2 q1 (i)

FCC Rule Part	RSS Rule Part	Description	Measured Value / Comments	Limit / Requirement	Result (margin)
15.407(a) (2)		26 dB Bandwidth	NU: 30.9 MHz	N/A – limits output power if < 20 MHz	N/A
15.407(a) (2)	A9.2(2)	Output Power	NU: 15.8 dBm (Max eirp: 152.4 mW)	17dBm (50 mW)	Complies
15.407(a) (2)	-	Power Spectral Density	NU: 1.8 dBm/MHz	11 dBm/MHz	Complies
-	A9.2(2) / A9.5 (2)	Power Spectral Density		11 dBm/MHz	Complies

Operation in the 5.47 – 5.725 GHz Band

FCC Rule Part	RSS Rule Part	Description	Measured Value / Comments	Limit / Requirement	Result (margin)
15.407(a) (2)		26 dB Bandwidth	30.7 MHz	N/A – limits output power if < 20 MHz	N/A
15.407(a) (2)	A9.2(2)	Output Power	16.5 dBm (Max eirp: 44.2 mW)	24 dBm / 250mW (eirp < 30dBm)	Complies
15.407(a) (2))		Power Spectral Density	2.2 dBm/MHz	11 dBm/MHz	Complies
	A9.2(2) / A9.5 (2)	Power Spectral Density		11 dBm/MHz	Complies
KDB 443999	A9	Non-operation in 5600 – 5650 MHz sub band	Device cannot operate in the 5600 – 5650 MHz band –refer to Operational Description		Complies

Operation in the 5.725 – 5.825 GHz Band

FCC Rule Part	RSS Rule Part	Description	Measured Value / Comments	Limit / Requirement	Result (margin)
15.407(a) (2)		26 dB Bandwidth	30.7 MHz	N/A – limits output power if < 20MHz	N/A
15.407(a) (2)	A9.2(2)	Output Power	14.9 dBm (Max eirp: 30.8 mW)	24 dBm / 250mW (eirp < 30dBm)	Complies
15.407(a) (2))		Power Spectral Density	1.2 dBm/MHz	11 dBm/MHz	Complies
	A9.2(2) / A9.5 (2)	Power Spectral Density		11 dBm / MHz	Complies
KDB 443999	A9	Non-operation in 5600 – 5650 MHz sub band	Device cannot operate in the 5600 – 5650 MHz band –refer to Operational Description		Complies

Requirements for all U-NII/LELAN bands

FCC Rule Part	RSS Rule Part	Description	Measured Value / Comments	Limit / Requirement	Result
15.407	A9.5a	Modulation	Digital Modulation	Digital modulation is required	Complies
15.407(b) (5) / 15.209	A9.3	Spurious Emissions below 1GHz	38.0 dB μ V/m	Refer to page 20	Complies (- 2.0 dB)
15.407(b) (5) / 15.209	A9.3	Spurious Emissions above 1GHz	53.3 dB μ V/m		Complies (- 0.7 dB)
15.407(a)(6)	-	Peak Excursion Ratio	11.1 dB	< 13dB	Complies
	A9.5 (3)	Channel Selection	Spurious emissions tested at outermost channels in each band	Device was tested on the top, bottom and center channels in each band	N/A
15			Measurements on three channels in each band		
15.407 (c)	A9.5(4)	Operation in the absence of information to transmit	Operation is discontinued in the absence of information	Device shall automatically discontinue operation in the absence of information to transmit	Complies
15.407 (g)	A9.5 (5)	Frequency Stability	See Operational Description	Signal shall remain within the allocated band	Complies
15.407 (h1)	A9.4	Transmit Power Control	TPC is not required as the device operates at below 500mW eirp	The U-NII device shall have the capability to operate with a mean EIRP value lower than 24 dBm (250 mW)	Complies
15.407 (h2)	A9.4	Dynamic frequency Selection (device with radar detection)	See DFS report	Threshold -62dBm Channel Availability Check > 60s Channel closing transmission time < 260ms Channel move time < 10s Non occupancy period > 30minutes	Complies
	A9.9g	User Manual information	See User Manual	Warning regarding interference from Satellite Systems	N/A

GENERAL REQUIREMENTS APPLICABLE TO ALL BANDS

FCC Rule Part	RSS Rule part	Description	Measured Value / Comments	Limit / Requirement	Result (margin)
15.203	-	RF Connector		Unique or integral antenna required	Complies
15.207	RSS GEN Table 4	AC Conducted Emissions	NU: 37.3 dB μ V @ 0.157 MHz (-18.3 dB) CU: 27.1 dB μ V @ 3.535 MHz (-18.9 dB)	Refer to page 18	Complies (- 18.3 dB)
15.109	RSS GEN 7.2.3 Table 1	Receiver spurious emissions	N/A	Refer to page 19	N/A
15.247 (b) (5) 15.407 (f)	RSS 102	RF Exposure Requirements	Refer to MPE calculations in separate exhibit, RSS 102 declaration and User Manual statements.	Refer to OET 65, FCC Part 1 and RSS 102	Excluded from scope of this report
-	RSP 100 RSS GEN 7.1.3	User Manual		Statement required regarding non-interference	Excluded from scope of this report
-	RSP 100 RSS GEN 7.1.2	User Manual		Statement for products with detachable antenna	Excluded from scope of this report
-	RSP 100 RSS GEN 4.6.1	99% Bandwidth		Information only	N/A

MEASUREMENT UNCERTAINTIES

ISO/IEC 17025 requires that an estimate of the measurement uncertainties associated with the emissions test results be included in the report. The measurement uncertainties given below are based on a 95% confidence level and were calculated in accordance with UKAS document LAB 34.

Measurement Type	Measurement Unit	Frequency Range	Expanded Uncertainty
RF power, conducted (power meter)	dBm	25 to 7000 MHz	± 0.52 dB
RF power, conducted (Spectrum analyzer)	dBm	25 to 7000 MHz	± 0.7 dB
Conducted emission of transmitter	dBm	25 to 26500 MHz	± 0.7 dB
Conducted emission of receiver	dBm	25 to 26500 MHz	± 0.7 dB
Radiated emission (substitution method)	dBm	25 to 26500 MHz	± 2.5 dB
Radiated emission (field strength)	dB μ V/m	25 to 1000 MHz	± 3.6 dB
		1000 to 40000 MHz	± 6.0 dB
Conducted Emissions (AC Power)	dB μ V	0.15 to 30 MHz	± 2.4 dB

EQUIPMENT UNDER TEST (EUT) DETAILS**GENERAL**

The Nextivity Inc. model D32-2/4NU and D32-2/4CU are part of the NU & CU System which is a WCDMA/LTE Cellular Repeater for indoor residential use. The system is composed of two units, the Network Unit (D32-2/4NU) and the Coverage Unit (D32-2/4CU) that connect wirelessly over a full-duplex wireless link in the RLAN band using a mixed OFDM and muxed cellular signal (up to three 5MHz cellular channels) over a 30 MHz and 40 MHz channel in each direction.

The samples were received on March 10, 2014 and tested on March 10, 11, 12, 13, 14, 16, 17 and 24, 2014. The EUT consisted of the following component(s):

Company	Model	Description	Serial Number	FCC ID
Nextivity Inc.	D32-2/4NU	Network Unit	174406000138	-
Nextivity Inc.	D32-2/4CU	Coverage Unit	175406000142	-
Nextivity Inc.	WRG20F-120A	Power Supply	20121024	-
Nextivity Inc.	WRG20F-120A	Power Supply	20120815	-

FREQUENCY LIST OF EUT

EUT	Tx frequency (MHz)	Band	Rule part	DFS flag
NU	5207	5150 to 5250 MHz	U-NII-1	non-DFS
NU	5220	5150 to 5250 MHz	U-NII-1	non-DFS
NU ¹	5240	5150 to 5250 MHz	U-NII-1+ U-NII-2A	DFS
NU ¹	5260	5250 to 5350 MHz	U-NII-1+ U-NII-2A	DFS
NU	5280	5250 to 5350 MHz	U-NII-2A	DFS
NU	5293	5250 to 5350 MHz	U-NII-2A	DFS
CU	5525	5470 to 5725 MHz	U-NII-2C	DFS
CU	5540	5470 to 5725 MHz	U-NII-2C	DFS
CU	5560	5470 to 5725 MHz	U-NII-2C	DFS
CU	5580	5470 to 5725 MHz	U-NII-2C	DFS
CU ²	5600	5470 to 5725 MHz	EUT does not operate. Terminal Doppler Weather Radars (TDWR)	
CU ²	5620	5470 to 5725 MHz		
CU ²	5640	5470 to 5725 MHz		
CU ²	5660	5470 to 5725 MHz		
CU	5680	5470 to 5725 MHz	U-NII 2C	DFS
CU ³	5715	5479 to 5725 MHz	U-NII-2C + U-NII-3	DFS
CU ³	5735	5480 to 5725 MHz	U-NII-2C + U-NII-3	DFS
CU	5765	5725 to 5850 MHz	DTS	non-DFS
CU	5785	5726 to 5850 MHz	DTS	non-DFS
CU	5805	5727 to 5850 MHz	DTS	non-DFS
CU	5825	5728 to 5850 MHz	DTS	non-DFS
Note 1:	Emission Bandwidths of Center frequency of 5240 and 5260 MHz channels extend across 5250 MHz band edge for U-NII-2A, therefore measurements are performed per KDB 644545 D01 v01r02. DFS requirements also apply for these channels			
Note 2:	The operation of this frequency range is blocked per FCC KDB 443999 D01 Approval of DFS UNII Devices v01; Device will not transmit on channels which overlap the 5600 - 5650 MHz band to avoid Terminal Doppler Weather Radars (TDWR)			
Note 3:	Emission Bandwidths of Center frequency of 5715 and 5735 MHz channels extend across 5725 MHz band edge for U-NII 2C, therefore FCC 15.407 U-NII band rules apply for these channels per KDB 644545 D01 v01r02. DFS requirements also apply for these channels			

ANTENNA SYSTEM

The antennas are integral to the device.

ENCLOSURE

The D32-2/4CU and D32-2/4NU enclosures are primarily constructed of plastic. They measure approximately 160 mm H x 150 mm W x 70 mm D.

MODIFICATIONS

No modifications were made to the EUT during the time the product was at NTS Silicon Valley.

SUPPORT EQUIPMENT

No support equipment was used during testing. A DELL Latitude D830 Laptop and Nextivity Chart Interface (V:2.0.0.2) software was used to configure the EUT's. The laptop was not connected during the tests.

EUT INTERFACE PORTS

The I/O cabling configuration during testing was as follows:

Port	Connected To	Description	Cable(s)	
			Shielded or Unshielded	Length(m)
DC Power	External power supply out	2 wire	Unshielded	2
External power supply in	AC Mains	Direct plug-in	NA	NA

EUT OPERATION

The EUT's were configured per the frequency list detailed in the EUT description with maximum rated RF power

TEST SITE**GENERAL INFORMATION**

Final test measurements were taken at the test sites listed below. Pursuant to section 2.948 of the FCC's Rules and section 3.3 of RSP-100, construction, calibration, and equipment data has been filed with the Commission and with industry Canada.

Site	Designation / Registration Numbers		Location
	FCC	Canada	
Chamber 5	US0027	2845B-5	41039 Boyce Road Fremont, CA 94538-2435
Chamber 7	US0027	2845B-7	

ANSI C63.4 recommends that ambient noise at the test site be at least 6 dB below the allowable limits. Ambient levels are below this requirement. The test site(s) contain separate areas for radiated and conducted emissions testing. Considerable engineering effort has been expended to ensure that the facilities conform to all pertinent requirements of ANSI C63.4.

CONDUCTED EMISSIONS CONSIDERATIONS

Conducted emissions testing is performed in conformance with ANSI C63.10. Measurements are made with the EUT connected to the public power network through a nominal standardized RF impedance, which is provided by a line impedance stabilization network, known as a LISN. A LISN is inserted in series with each current-carrying conductor in the EUT power cord.

RADIATED EMISSIONS CONSIDERATIONS

The FCC has determined that radiation measurements made in a shielded enclosure are not suitable for determining levels of radiated emissions. Radiated measurements are performed in an open field environment or in a semi-anechoic chamber. The test sites are maintained free of conductive objects within the CISPR defined elliptical area incorporated in ANSI C63.4 guidelines and meet the Normalized Site Attenuation (NSA) requirements of ANSI C63.4.

MEASUREMENT INSTRUMENTATION

RECEIVER SYSTEM

An EMI receiver as specified in CISPR 16-1-1 is used for emissions measurements. The receivers used can measure over the frequency range of 9 kHz up to 2000 MHz. These receivers allow both ease of measurement and high accuracy to be achieved. The receivers have Peak, Average, and CISPR (Quasi-peak) detectors built into their design so no external adapters are necessary. The receiver automatically sets the required bandwidth for the CISPR detector used during measurements. If the repetition frequency of the signal being measured is below 20Hz, peak measurements are made in lieu of Quasi-Peak measurements.

For measurements above the frequency range of the receivers, a spectrum analyzer is utilized because it provides visibility of the entire spectrum along with the precision and versatility required to support engineering analysis. Average measurements above 1000MHz are performed on the spectrum analyzer using the linear-average method with a resolution bandwidth of 1 MHz and a video bandwidth of 10 Hz, unless the signal is pulsed in which case the average (or video) bandwidth of the measuring instrument is reduced to onset of pulse desensitization and then increased.

INSTRUMENT CONTROL COMPUTER

The receivers utilize either a Rohde & Schwarz EZM Spectrum Monitor/Controller or contain an internal Spectrum Monitor/Controller to view and convert the receiver measurements to the field strength at an antenna or voltage developed at the LISN measurement port, which is then compared directly with the appropriate specification limit. This provides faster, more accurate readings by performing the conversions described under Sample Calculations within the Test Procedures section of this report. Results are printed in a graphic and/or tabular format, as appropriate. A personal computer is used to record all measurements made with the receivers.

The Spectrum Monitor provides a visual display of the signal being measured. In addition, the controller or a personal computer run automated data collection programs which control the receivers. This provides added accuracy since all site correction factors, such as cable loss and antenna factors are added automatically.

LINE IMPEDANCE STABILIZATION NETWORK (LISN)

Line conducted measurements utilize a 50 μ H Line Impedance Stabilization Network as the monitoring point. The LISN used also contains a 250 μ H CISPR adapter. This network provides for calibrated radio frequency noise measurements by the design of the internal low pass and high pass filters on the EUT and measurement ports, respectively.

FILTERS/ATTENUATORS

External filters and precision attenuators are often connected between the receiving antenna or LISN and the receiver. This eliminates saturation effects and non-linear operation due to high amplitude transient events.

ANTENNAS

A loop antenna is used below 30 MHz. For the measurement range 30 MHz to 1000 MHz either a combination of a biconical antenna and a log periodic or a bi-log antenna is used. Above 1000 MHz, horn antennas are used. The antenna calibration factors to convert the received voltage to an electric field strength are included with appropriate cable loss and amplifier gain factors to determine an overall site factor, which is then programmed into the test receivers or incorporated into the test software.

ANTENNA MAST AND EQUIPMENT TURNTABLE

The antennas used to measure the radiated electric field strength are mounted on a non-conductive antenna mast equipped with a motor-drive to vary the antenna height. Measurements below 30 MHz are made with the loop antenna at a fixed height of 1m above the ground plane.

ANSI C63.10 specifies that the test height above ground for table mounted devices shall be 80 centimeters. Floor mounted equipment shall be placed on the ground plane if the device is normally used on a conductive floor or separated from the ground plane by insulating material from 3 to 12 mm if the device is normally used on a non-conductive floor as specified in ANSI C63.4. During radiated measurements, the EUT is positioned on a motorized turntable in conformance with this requirement.

INSTRUMENT CALIBRATION

All test equipment is regularly checked to ensure that performance is maintained in accordance with the manufacturer's specifications. All antennas are calibrated at regular intervals with respect to tuned half-wave dipoles. An exhibit of this report contains the list of test equipment used and calibration information.

TEST PROCEDURES

EUT AND CABLE PLACEMENT

The regulations require that interconnecting cables be connected to the available ports of the unit and that the placement of the unit and the attached cables simulate the worst case orientation that can be expected from a typical installation, so far as practicable. To this end, the position of the unit and associated cabling is varied within the guidelines of ANSI C63.10, and the worst-case orientation is used for final measurements.

CONDUCTED EMISSIONS

Conducted emissions are measured at the plug end of the power cord supplied with the EUT. Excess power cord length is wrapped in a bundle between 30 and 40 centimeters in length near the center of the cord. Preliminary measurements are made to determine the highest amplitude emission relative to the specification limit for all the modes of operation. Placement of system components and varying of cable positions are performed in each mode. A final peak mode scan is then performed in the position and mode for which the highest emission was noted on all current carrying conductors of the power cord.

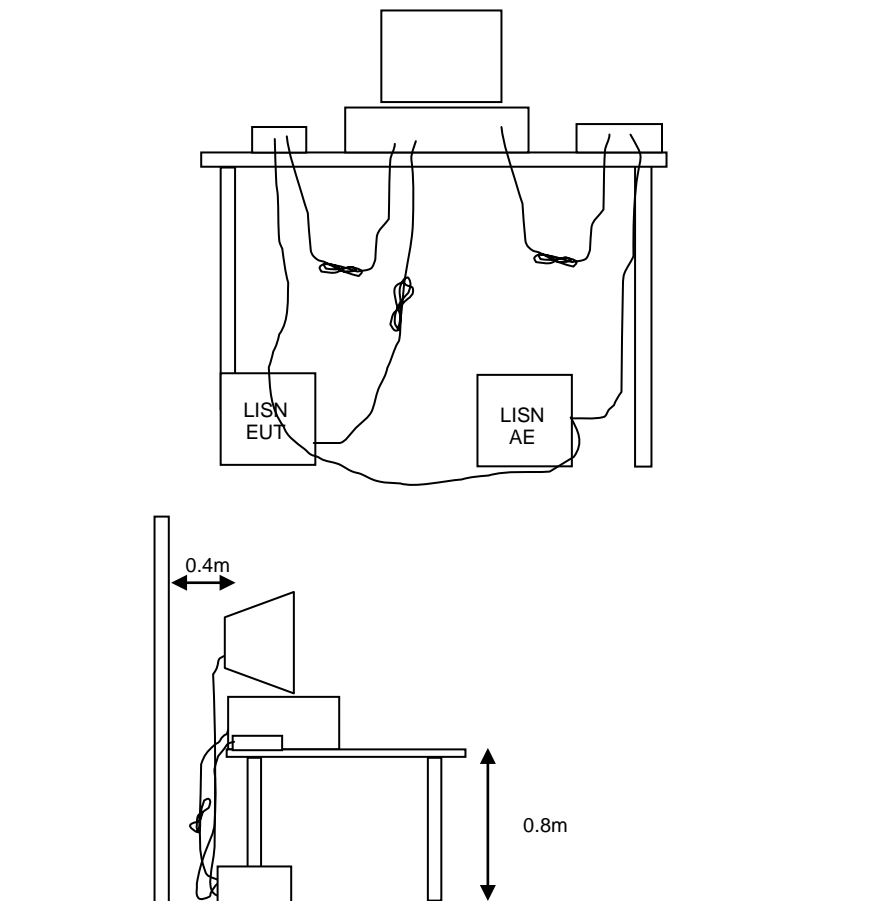

Figure 1 Typical Conducted Emissions Test Configuration

RADIATED EMISSIONS

A preliminary scan of the radiated emissions is performed in which all significant EUT frequencies are identified with the system in a nominal configuration. At least two scans are performed, one scan for each antenna polarization (horizontal and vertical; loop parallel and perpendicular to the EUT). During the preliminary scans, the EUT is rotated through 360°, the antenna height is varied (for measurements above 30 MHz) and cable positions are varied to determine the highest emission relative to the limit. Preliminary scans may be performed in a fully anechoic chamber for the purposes of identifying the frequencies of the highest emissions from the EUT.

A speaker is provided in the receiver to aid in discriminating between EUT and ambient emissions. Other methods used during the preliminary scan for EUT emissions involve scanning with near field magnetic loops, monitoring I/O cables with RF current clamps, and cycling power to the EUT.

Final maximization is a phase in which the highest amplitude emissions identified in the spectral search are viewed while the EUT azimuth angle is varied from 0 to 360 degrees relative to the receiving antenna. The azimuth, which results in the highest emission is then maintained while varying the antenna height from one to four meters (for measurements above 30 MHz, measurements below 30 MHz are made with the loop antenna at a fixed height of 1m). The result is the identification of the highest amplitude for each of the highest peaks. Each recorded level is corrected in the receiver using appropriate factors for cables, connectors, antennas, and preamplifier gain.

When testing above 18 GHz, the receive antenna is located at 1meter from the EUT and the antenna height is restricted to a maximum of 2.5 meters.

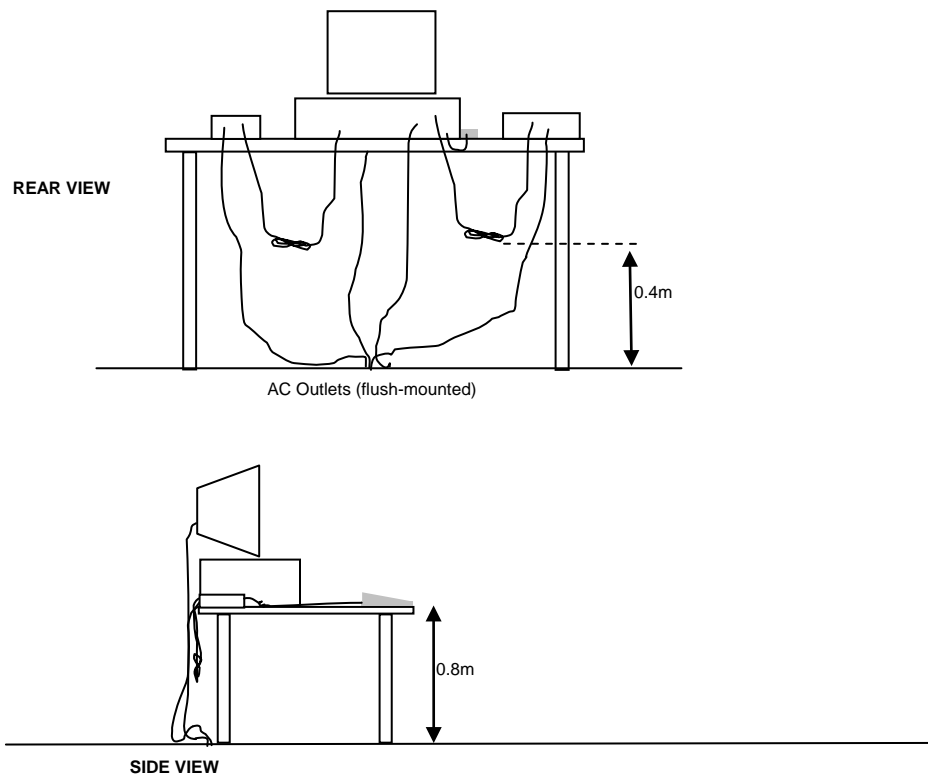

Typical Test Configuration for Radiated Field Strength Measurements

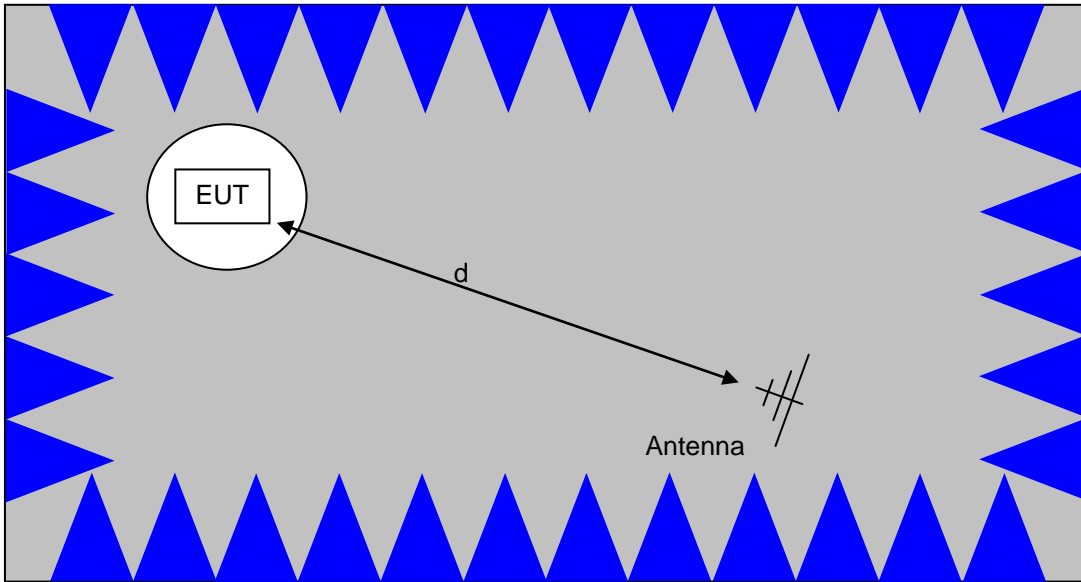

The anechoic materials on the walls and ceiling ensure compliance with the normalized site attenuation requirements of CISPR 16 / CISPR 22 / ANSI C63.4 for an alternate test site at the measurement distances used.

Floor-standing equipment is placed on the floor with insulating supports between the unit and the ground plane.

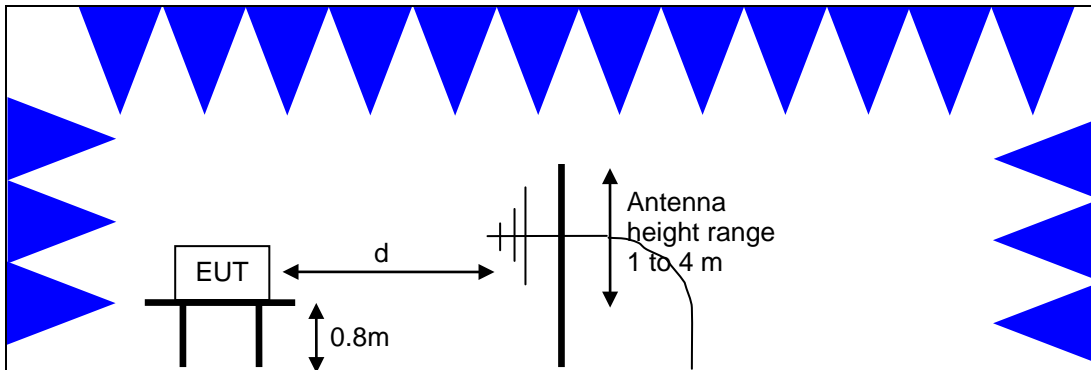

Test Configuration for Radiated Field Strength Measurements
Semi-Anechoic Chamber, Plan and Side Views

CONDUCTED EMISSIONS FROM ANTENNA PORT

Direct measurements of power, bandwidth and power spectral density are performed, where possible, with the antenna port of the EUT connected to either the power meter or spectrum analyzer via a suitable attenuator and/or filter. These are used to ensure that the front end of the measurement instrument is not overloaded by the fundamental transmission.

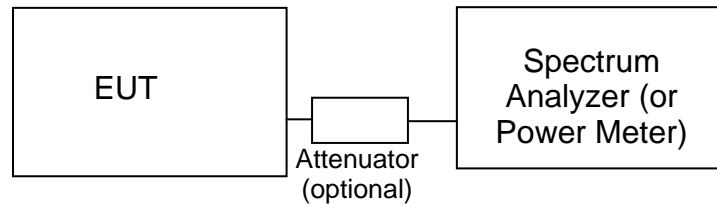
**Test Configuration for Antenna Port Measurements**

Measurement bandwidths (video and resolution) are set in accordance with the relevant standards and NTS Silicon Valley's test procedures for the type of radio being tested. When power measurements are made using a resolution bandwidth less than the signal bandwidth the power is calculated by summing the power across the signal bandwidth using either the analyzer channel power function or by capturing the trace data and calculating the power using software. In both cases the summed power is corrected to account for the equivalent noise bandwidth (ENBW) of the resolution bandwidth used.

If power averaging is used (typically for certain digital modulation techniques), the EUT is configured to transmit continuously. Power averaging is performed using either the built-in function of the analyzer or, if the analyzer does not feature power averaging, using external software. In both cases the average power is calculated over a number of sweeps (typically 100). When the EUT cannot be configured to continuously transmit then either the analyzer is configured to perform a gated sweep to ensure that the power is averaged over periods that the device is transmitting or power averaging is disabled and a max-hold feature is used.

If a power meter is used to make output power measurements the sensor head type (peak or average) is stated in the test data table.

BANDWIDTH MEASUREMENTS

The 6dB, 20dB, 26dB and/or 99% signal bandwidth are measured using the bandwidths recommended by ANSI C63.10 and RSS GEN.

SPECIFICATION LIMITS AND SAMPLE CALCULATIONS

The limits for conducted emissions are given in units of microvolts, and the limits for radiated emissions are given in units of microvolts per meter at a specified test distance. Data is measured in the logarithmic form of decibels relative to one microvolt, or dB microvolts (dB μ V). For radiated emissions, the measured data is converted to the field strength at the antenna in dB microvolts per meter (dB μ V/m). The results are then converted to the linear forms of μ V and μ V/m for comparison to published specifications.

For reference, converting the specification limits from linear to decibel form is accomplished by taking the base ten logarithm, then multiplying by 20. These limits in both linear and logarithmic form are as follows:

CONDUCTED EMISSIONS SPECIFICATION LIMITS: FCC 15.207; FCC 15.107(a), RSS GEN

The table below shows the limits for the emissions on the AC power line from an intentional radiator and a receiver.

Frequency (MHz)	Average Limit (dB μ V)	Quasi Peak Limit (dB μ V)
0.150 to 0.500	Linear decrease on logarithmic frequency axis between 56.0 and 46.0	Linear decrease on logarithmic frequency axis between 66.0 and 56.0
0.500 to 5.000	46.0	56.0
5.000 to 30.000	50.0	60.0

GENERAL TRANSMITTER RADIATED EMISSIONS SPECIFICATION LIMITS

The table below shows the limits for the spurious emissions from transmitters that fall in restricted bands¹ (with the exception of transmitters operating under FCC Part 15 Subpart D and RSS 210 Annex 9), the limits for all emissions from a low power device operating under the general rules of RSS 310 (tables 3 and 4), RSS 210 (table 2) and FCC Part 15 Subpart C section 15.209.

Frequency Range (MHz)	Limit ($\mu\text{V}/\text{m}$)	Limit ($\text{dB}\mu\text{V}/\text{m}$ @ 3m)
0.009-0.490	$2400/F_{\text{KHz}}$ @ 300m	$67.6-20*\log_{10}(F_{\text{KHz}})$ @ 300m
0.490-1.705	$24000/F_{\text{KHz}}$ @ 30m	$87.6-20*\log_{10}(F_{\text{KHz}})$ @ 30m
1.705 to 30	30 @ 30m	29.5 @ 30m
30 to 88	100 @ 3m	40 @ 3m
88 to 216	150 @ 3m	43.5 @ 3m
216 to 960	200 @ 3m	46.0 @ 3m
Above 960	500 @ 3m	54.0 @ 3m

RECEIVER RADIATED SPURIOUS EMISSIONS SPECIFICATION LIMITS

The table below shows the limits for the spurious emissions from receivers as detailed in FCC Part 15.109, RSS 210 Table 2, RSS GEN Table 1 and RSS 310 Table 3. Note that receivers operating outside of the frequency range 30 MHz – 960 MHz are exempt from the requirements of 15.109.

Frequency Range (MHz)	Limit ($\mu\text{V}/\text{m}$ @ 3m)	Limit ($\text{dB}\mu\text{V}/\text{m}$ @ 3m)
30 to 88	100	40
88 to 216	150	43.5
216 to 960	200	46.0
Above 960	500	54.0

FCC 15.407 (a) OUTPUT POWER LIMITS

The table below shows the limits for output power and output power density. Where the signal bandwidth is less than 20 MHz the maximum output power is reduced to the power spectral density limit plus 10 times the log of the bandwidth (in MHz).

Operating Frequency (MHz)	Output Power	Power Spectral Density
5150 – 5250	50 mW (17 dBm)	4 dBm/MHz
5250 – 5350	250 mW (24 dBm)	11 dBm/MHz
5725 – 5825	1 Watt (30 dBm)	17 dBm/MHz

¹ The restricted bands are detailed in FCC 15.203, RSS 210 Table 1 and RSS 310 Table 2

For system using antennas with gains exceeding 6 dBi, the output power and power spectral density limits are reduced by 1 dB for every dB the antenna gain exceeds 6 dBi. Fixed point-to-point applications using the 5725 – 5825 MHz band may use antennas with gains of up to 23 dBi without this limitation. If the gain exceeds 23 dBi then the output power limit of 1 Watt is reduced by 1 dB for every dB the gain exceeds 23 dBi.

The peak excursion envelope is limited to 13 dB.

OUTPUT POWER LIMITS –LELAN DEVICES

The table below shows the limits for output power and output power density defined by RSS 210. Where the signal bandwidth is less than 20 MHz the maximum output power is reduced to the power spectral density limit plus 10 times the log of the bandwidth (in MHz).

Operating Frequency (MHz)	Output Power	Power Spectral Density
5150 – 5250	200 mW (23 dBm) eirp	10 dBm/MHz eirp
5250 – 5350	250 mW (24 dBm) ² 1W (30 dBm) eirp	11 dBm/MHz
5470 – 5725	250 mW (24 dBm) ³ 1W (30 dBm) eirp	11 dBm/MHz
5725 – 5825	1 Watt (30 dBm) 4W eirp	17 dBm/MHz

In addition, the power spectral density limit shall be reduced by 1dB for every dB the highest power spectral density exceeds the “average” power spectral density) by more than 3dB. The “average” power spectral density is determined by dividing the output power by $10\log(\text{EBW})$ where EBW is the 99% power bandwidth.

Fixed point-to-point applications using the 5725 – 5825 MHz band may use antennas with gains of up to 23dBi without this limitation. If the gain exceeds 23dBi then the output power limit of 1 Watt is reduced by 1dB for every dB the gain exceeds 23dBi.

SPURIOUS EMISSIONS LIMITS –UNII and LELAN DEVICES

The spurious emissions limits for signals below 1 GHz are the FCC/RSS-GEN general limits. For emissions above 1 GHz, signals in restricted bands are subject to the FCC/RSS GEN general limits. All other signals have a limit of –27 dBm/MHz, which is a field strength of 68.3 dB μ V/m/MHz at a distance of 3 m. For devices operating in the 5725-5850 MHz bands under the LELAN/UNII rules, the limit within 10 MHz of the allocated band is increased to –17 dBm/MHz.

² If EIRP exceeds 500mW the device must employ TPC

³ If EIRP exceeds 500mW the device must employ TPC

SAMPLE CALCULATIONS - CONDUCTED EMISSIONS

Receiver readings are compared directly to the conducted emissions specification limit (decibel form) as follows:

$$R_r - S = M$$

where:

R_r = Receiver Reading in dB μ V

S = Specification Limit in dB μ V

M = Margin to Specification in +/- dB

SAMPLE CALCULATIONS - RADIATED EMISSIONS

Receiver readings are compared directly to the specification limit (decibel form). The receiver internally corrects for cable loss, preamplifier gain, and antenna factor. The calculations are in the reverse direction of the actual signal flow, thus cable loss is added and the amplifier gain is subtracted. The Antenna Factor converts the voltage at the antenna coaxial connector to the field strength at the antenna elements.

A distance factor, when used for electric field measurements above 30MHz, is calculated by using the following formula:

$$F_d = 20 * \text{LOG}_{10} (D_m/D_s)$$

where:

F_d = Distance Factor in dB

D_m = Measurement Distance in meters

D_s = Specification Distance in meters

For electric field measurements below 30 MHz the extrapolation factor is either determined by making measurements at multiple distances or a theoretical value is calculated using the formula:

$$F_d = 40 * \text{LOG}_{10} (D_m/D_s)$$

Measurement Distance is the distance at which the measurements were taken and Specification Distance is the distance at which the specification limits are based. The antenna factor converts the voltage at the antenna coaxial connector to the field strength at the antenna elements.

The margin of a given emission peak relative to the limit is calculated as follows:

$$R_c = R_r + F_d$$

and

$$M = R_c - L_s$$

where:

R_r = Receiver Reading in dB μ V/m

F_d = Distance Factor in dB

- R_C = Corrected Reading in dB μ V/m
 L_S = Specification Limit in dB μ V/m
 M = Margin in dB Relative to Spec

SAMPLE CALCULATIONS - FIELD STRENGTH TO EIRP CONVERSION

Where the radiated electric field strength is expressed in terms of the equivalent isotropic radiated power (eirp), or where a field strength measurement of output power is made in lieu of a direct measurement, the following formula is used to convert between eirp and field strength at a distance of d (meters) from the equipment under test:

$$E = \frac{1000000 \sqrt{30 P}}{d} \quad \text{microvolts per meter}$$

where P is the eirp (Watts)

For a measurement at 3m the conversion from a logarithmic value for field strength (dB μ V/m) to an eirp power (dBm) is -95.3 dB.

Appendix A Test Equipment Calibration Data

<u>Manufacturer</u>	<u>Description</u>	<u>Model</u>	<u>Asset #</u>	<u>Cal Due</u>
Radiated Emissions, Power, PSD, 99% BW, and Peak Excursion, 10-Mar-14				
EMCO	Antenna, Horn, 1-18GHz	3115	868	6/19/2014
Rohde & Schwarz	EMI Test Receiver, 20 Hz-7 GHz	ESIB7	1538	12/14/2014
Radiated Emissions, Power, PSD, 99% BW, Peak Excursion, 26dB BW, and 20dB BW 11-Mar-14				
EMCO	Antenna, Horn, 1-18GHz	3115	868	6/19/2014
Rohde & Schwarz	EMI Test Receiver, 20 Hz-7 GHz	ESIB7	1538	12/14/2014
Radiated Emissions, Power, PSD, 99% BW, Peak Excursion, 26dB BW, and 20dB BW, 12-Mar-14				
EMCO	Antenna, Horn, 1-18GHz	3115	868	6/19/2014
Rohde & Schwarz	EMI Test Receiver, 20 Hz-7 GHz	ESIB7	1538	12/14/2014
Radiated Emissions, 1000 - 18,000 MHz, 12-Mar-14				
Hewlett Packard	Microwave Preamplifier, 1-26.5GHz	8449B	785	10/31/2014
EMCO	Antenna, Horn, 1-18GHz	3115	868	6/19/2014
Hewlett Packard	SpecAn 30 Hz -40 GHz, SV (SA40) Red	8564E (84125C)	1148	9/14/2014
Rohde & Schwarz	EMI Test Receiver, 20 Hz-7 GHz	ESIB7	1538	12/14/2014
Micro-Tronics	Band Reject Filter, 5150-5350 MHz	BRC50703-02	2239	9/18/2014
Radiated Emissions, 1,000 - 12,000 MHz, 13-Mar-14				
Hewlett Packard	Microwave Preamplifier, 1-26.5GHz	8449B	785	10/31/2014
EMCO	Antenna, Horn, 1-18GHz	3115	868	6/19/2014
Hewlett Packard	SpecAn 30 Hz -40 GHz, SV (SA40) Red	8564E (84125C)	1148	9/14/2014
Micro-Tronics	Band Reject Filter, 5150-5350 MHz	BRC50703-02	2239	9/18/2014
Micro-Tronics	Band Reject Filter, 5470-5725 MHz	BRC50704-02	2240	9/18/2014
Micro-Tronics	Band Reject Filter, 5725-5875 MHz	BRC50705-02	2241	9/18/2014
Radiated Emissions, 1,000 - 18,000 MHz, 14-Mar-14				
EMCO	Antenna, Horn, 1-18GHz	3115	868	6/19/2014
Hewlett Packard	High Pass filter, 8.2 GHz (Blu System)	P/N 84300-80039 (84125C)	1392	5/14/2014
Hewlett Packard	Microwave Preamplifier, 1-26.5GHz	8449B	2199	2/20/2015
Micro-Tronics	Band Reject Filter, 5470-5725 MHz	BRC50704-02	2240	9/18/2014
Micro-Tronics	Band Reject Filter, 5725-5875 MHz	BRC50705-02	2241	9/18/2014
Hewlett Packard	SpecAn 9 kHz - 40 GHz, (SA40) Purple	8564E (84125C)	2415	2/27/2015
Radiated Emissions, 1000 - 40,000 MHz, 14-Mar-14				
EMCO	Antenna, Horn, 1-18GHz	3115	868	6/19/2014
Hewlett Packard	High Pass filter, 8.2 GHz (Blu System)	P/N 84300-80039 (84125C)	1392	5/14/2014
Hewlett Packard	Head (Inc W1-W4, 1946 , 1947) Purple	84125C	1772	6/18/2014
A. H. Systems	Red System Horn, 18-40GHz	SAS-574, p/n: 2581	2161	6/10/2014

<u>Manufacturer</u>	<u>Description</u>	<u>Model</u>	<u>Asset #</u>	<u>Cal Due</u>
Hewlett Packard	Microwave Preamplifier, 1-26.5GHz	8449B	2199	2/20/2015
Hewlett Packard	SpecAn 9 kHz - 40 GHz, (SA40) Purple	8564E (84125C)	2415	2/27/2015
Radiated Emissions, 30 - 1,000 MHz, 16-Mar-14				
Rohde & Schwarz	EMI Test Receiver, 20 Hz-7 GHz	ESIB7	1538	12/14/2014
Sunol Sciences	Biconilog, 30-3000 MHz	JB3	1657	6/4/2014
Com-Power	Preamplifier, 30-1000 MHz	PA-103	2465	9/13/2014
Radiated Emissions, 17-Mar-14				
EMCO	Antenna, Horn, 1-18GHz	3115	868	6/19/2014
Hewlett Packard	High Pass filter, 8.2 GHz (Blue System)	P/N 84300-80039 (84125C)	1392	5/14/2014
Rohde & Schwarz	EMI Test Receiver, 20 Hz-7 GHz	ESIB7	1538	12/14/2014
Hewlett Packard	Head (Inc W1-W4, 1946 , 1947) Purple	84125C	1772	6/18/2014
A. H. Systems	Red System Horn, 18-40GHz	SAS-574, p/n: 2581	2161	6/10/2014
Hewlett Packard	Microwave Preamplifier, 1-26.5GHz	8449B	2199	2/20/2015
Hewlett Packard	SpecAn 9 kHz - 40 GHz, (SA40) Purple	8564E (84125C)	2415	2/27/2015
Radiated Emissions, Power, PSD and BW, 24-Mar-14				
EMCO	Antenna, Horn, 1-18GHz	3115	868	6/19/2014
Rohde & Schwarz	EMI Test Receiver, 20 Hz-40 GHz	ESIB40 (1088.7490.40)	2493	1/11/2015

Appendix B Test Data

T94720 Pages 26 - 107



EMC Test Data

Client:	Nextivity Inc	Job Number:	J94664
Model:	D32-2/4NU and D32-2/4CU	T-Log Number:	T94720
		Account Manager:	Christine Krebill
Contact:	Michiel Lotter		-
Emissions Standard(s):	FCC Part 15.247, Part 15.407 and RSS 210	Class:	-
Immunity Standard(s):	-	Environment:	-

EMC Test Data

For The

Nextivity Inc

Model

D32-2/4NU and D32-2/4CU

Date of Last Test: 3/24/2014

Client: Nextivity Inc	Job Number: J94664
Model: D32-2/4NU and D32-2/4CU	T-Log Number: T94720
	Account Manager: Christine Krebill
Contact: Michiel Lotter	
Standard: FCC Part 15.247, Part 15.407 and RSS 210	Class: N/A

RSS-210 (LE-LAN) and FCC 15.407(U-NII) Power, PSD, Peak Excursion and Bandwidth

Test Specific Details

Objective: The objective of this test session is to perform final qualification testing of the EUT with respect to the specification listed above.

Date of Test: 3/10/2014, 3/17/2014	Config. Used: 1
Test Engineer: R. Varelas / J. Liu / D. Demirci	Config Change: None
Test Location: FT Chamber #7	EUT Voltage: 120V/60Hz

Summary of Results

Run #	Test Performed	Limit	Pass / Fail	Result / Margin
1a	Power, 5150 - 5250MHz	15.407(a) (1), (2)	Pass	16.0 dBm (158.5 mW)
1a	PSD, 5150 - 5250MHz	15.407(a) (1), (2)	Pass	2.6 dBm/MHz
1b	Power, 5250 - 5350MHz	15.407(a) (1), (2)	Pass	15.8 dBm (152.4 mW)
1b	PSD, 5250 - 5350MHz	15.407(a) (1), (2)	Pass	1.8 dBm/MHz
1a/b	26 dB ¹ Bandwidth	15.407	Pass	30.6 MHz
1a/b	99% Bandwidth	RSS 210	Pass	37.3 MHz
2	Peak Excursion Envelope	15.407(a) (6) 13dB	Pass	11.1 dB

Note 1: 26 dB bandwidth measurements of band-crossing channels are excluded in the summary table above.

General Test Configuration

The EUT was located on the turntable for radiated spurious emissions testing. DELL Latitude D830 Laptop and Nextivity Chart Interface (V:2.0.0.2) software was used to configure the EUT. The laptop was not connected during the tests.

The EUT was radiating through its internal antenna. The emission was maximized, & EIRP was measured as described in the notes below.

For radiated emissions testing the measurement antenna was located 3 meters from the EUT.

Ambient Conditions:	Temperature: 21-24 °C
	Rel. Humidity: 30-45 %

Modifications Made During Testing

No modifications were made to the EUT during testing

Deviations From The Standard

No deviations were made from the requirements of the standard.

Client: Nextivity Inc	Job Number: J94664
Model: D32-2/4NU and D32-2/4CU	T-Log Number: T94720
	Account Manager: Christine Krebill
Contact: Michiel Lotter	
Standard: FCC Part 15.247, Part 15.407 and RSS 210	Class: N/A

Run #1: Bandwidth, Output Power and Power Spectral Density - Single Chain Systems

Note 1:	Radiated output power measured using a spectrum analyzer RBW=1 MHz, VB=3 MHz, RMS detector, Sweep Time Auto, 100 sweeps, Trigger, Free run, and power integration over 50 and 60 MHz. EUT is operating at 100% duty cycle. (method SA-1 of KDB 789033 D01 v01r03).
Note 2:	PSD Measured using the same analyzer settings used for output power.
Note 3:	For RSS-210 the limit for the 5150 - 5250 MHz band accounts for the antenna gain as the maximum eirp allowed is 10 dBm/MHz. The limits are also corrected for instances where the highest measured value of the PSD exceeds the average PSD (calculated from the measured power divided by the measured 99% bandwidth) by more than 3dB by the amount that the measured value exceeds the average by more than 3 dB.
Note 4:	99% Bandwidth measured in accordance with RSS GEN - RB > 1% of span and VB >=3xRB
Note 5:	Measurements are performed with radiated emission method. Conducted power and PSD are calculated by subtracting the antenna gain from measured radiated values
Note 6:	Emission Bandwidths of 5240 MHz and 5260 MHz channels intentionally extend into the 5.25-5.35 GHz band, therefore 20 dB down band edge requirement does not apply per KDB 644545 D01 v01r02.
Note 7:	Radiated emission measurements are maximized when receive antenna horizontally and vertically polarized. The highest emission values are presented in the summary tables.

1a Single Chain Operation, 5150-5250MHz Band 30 MHz Bandwidth

Frequency (MHz)	Software Setting	Output Power ¹ dBm EIRP (Measured)	PSD ² dBm / MHz EIRP (Measured)	Antenna polarity	
5207	-	21.0	7.3	Vertical	
5220	-	22.0	7.6	Vertical	
5240	-	21.4	8.6	Vertical	U-NII-1
5240	-	15.0	8.6	Vertical	U-NII-2A

Antenna Gain (dBi): 6 EIRP: 157.4 mW 22.0 dBm

Frequency (MHz)	Software Setting	Bandwidth		Output Power ¹ dBm		Power (Watts)	PSD ² dBm / MHz			Result
		26dB	99% ⁴	Calculated ⁵	Limit		Calculated ⁵	FCC Limit	RSS Limit ³	
5207	-	30.6	28.9	15.0	17.0	0.031	1.3	4.0	4.0	Pass
5220	-	30.9	29.1	16.0	17.0	0.040	1.6	4.0	4.0	Pass
5240	-	25.3	24.3	15.4	17.0	0.035	2.6	4.0	4.0	Pass
5240	-	5.6	5.0	9.0	17.0	0.008	2.6	4.0	4.0	Pass

Client: Nextivity Inc	Job Number: J94664
Model: D32-2/4NU and D32-2/4CU	T-Log Number: T94720
	Account Manager: Christine Krebill
Contact: Michiel Lotter	
Standard: FCC Part 15.247, Part 15.407 and RSS 210	Class: N/A

1b Single Chain Operation, 5250-5350MHz Band 30 MHz Bandwidth

Frequency (MHz)	Software Setting	Output Power ¹ dBm EIRP (Measured)	PSD ² dBm / MHz EIRP (Measured)	Antenna polarity	
5260	-	13.1	6.4	Vertical	U-NII-1
5260	-	20.7	7.2	Vertical	U-NII-2A
5280	-	21.6	7.3	Vertical	
5293	-	21.8	7.8	Vertical	

Antenna Gain (dBi): 6 EIRP: 152.4 mW 21.8 dBm

Frequency (MHz)	Software Setting	Bandwidth		Output Power ¹ dBm		Power (Watts)	PSD ² dBm / MHz			Result
		26dB	99% ⁴	Calculated ⁵	Limit		Calculated ⁵	FCC Limit	RSS Limit ³	
5260	-	5.2	4.6	7.1	11.1	0.005	0.4	4.0	4.0	Pass
5260	-	25.4	24.2	14.7	17.0	0.030	1.2	4.0	4.0	Pass
5280	-	31.2	29.1	15.6	24.0	0.037	1.3	11.0	11.0	Pass
5293	-	30.9	28.9	15.8	24.0	0.038	1.8	11.0	11.0	Pass

1a Single Chain Operation, 5150-5250MHz Band 40 MHz Bandwidth

Frequency (MHz)	Software Setting	Output Power ¹ dBm EIRP (Measured)	PSD ² dBm / MHz EIRP (Measured)	Antenna polarity	
5207	-	21.8	6.9	Vertical	
5220	-	22.0	6.8	Vertical	
5240	-	21.4	7.2	Vertical	U-NII-1
5240	-	16.5	7.6	Vertical	U-NII-2A

Antenna Gain (dBi): 6 EIRP: 158.5 mW 22.0 dBm

Frequency (MHz)	Software Setting	Bandwidth		Output Power ¹ dBm		Power (Watts)	PSD ² dBm / MHz			Result
		26dB	99% ⁴	Calculated ⁵	Limit		Calculated ⁵	FCC Limit	RSS Limit ³	
5207	-	39.1	37.1	15.8	17.0	0.038	0.9	4.0	4.0	Pass
5220	-	39.2	37.1	16.0	17.0	0.040	0.8	4.0	4.0	Pass
5240	-	29.7	28.1	15.4	17.0	0.035	1.2	4.0	4.0	Pass
5240	-	9.5	8.8	10.5	20.8	0.011	1.6	11.0	11.0	Pass

Client: Nextivity Inc	Job Number: J94664
Model: D32-2/4NU and D32-2/4CU	T-Log Number: T94720
	Account Manager: Christine Krebill
Contact: Michiel Lotter	
Standard: FCC Part 15.247, Part 15.407 and RSS 210	Class: N/A

1b Single Chain Operation, 5250-5350MHz Band 40 MHz Bandwidth

Frequency (MHz)	Software Setting	Output Power ¹ dBm EIRP (Measured)	PSD ² dBm / MHz EIRP (Measured)	Antenna polarity	
5260	-	17.4	8.0	Vertical	U-NII-1
5260	-	21.2	6.7	Vertical	U-NII-2A
5280	-	21.8	6.4	Vertical	
5293	-	21.8	6.4	Vertical	

Antenna Gain (dBi): 6

EIRP: 151.0 mW

21.8 dBm

Frequency (MHz)	Software Setting	Bandwidth		Output Power ¹ dBm		Power (Watts)	PSD ² dBm / MHz			Result
		26dB	99% ⁴	Calculated ⁵	Limit		Calculated ⁵	FCC Limit	RSS Limit ³	
5260	-	9.5	8.9	11.4	13.8	0.014	2.0	4.0	4.0	Pass
5260	-	29.5	28.5	15.2	24.0	0.033	0.7	11.0	11.0	Pass
5280	-	39.6	37.3	15.8	24.0	0.038	0.4	11.0	11.0	Pass
5293	-	45.2	37.2	15.8	24.0	0.038	0.4	11.0	11.0	Pass

Client: Nextivity Inc	Job Number: J94664
Model: D32-2/4NU and D32-2/4CU	T-Log Number: T94720
	Account Manager: Christine Krebill
Contact: Michiel Lotter	
Standard: FCC Part 15.247, Part 15.407 and RSS 210	Class: N/A

NU Ch Freq 5207 MHz @ 30 MHz Bandwidth

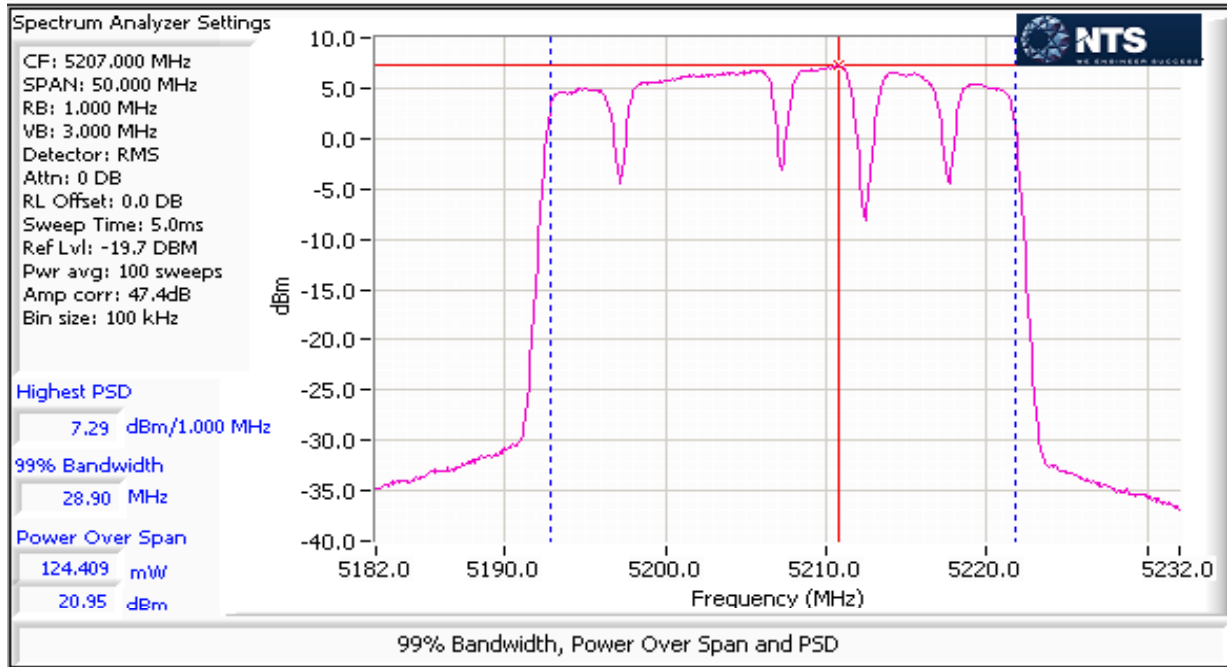

NU Ch Freq 5220 MHz @ 30 MHz Bandwidth

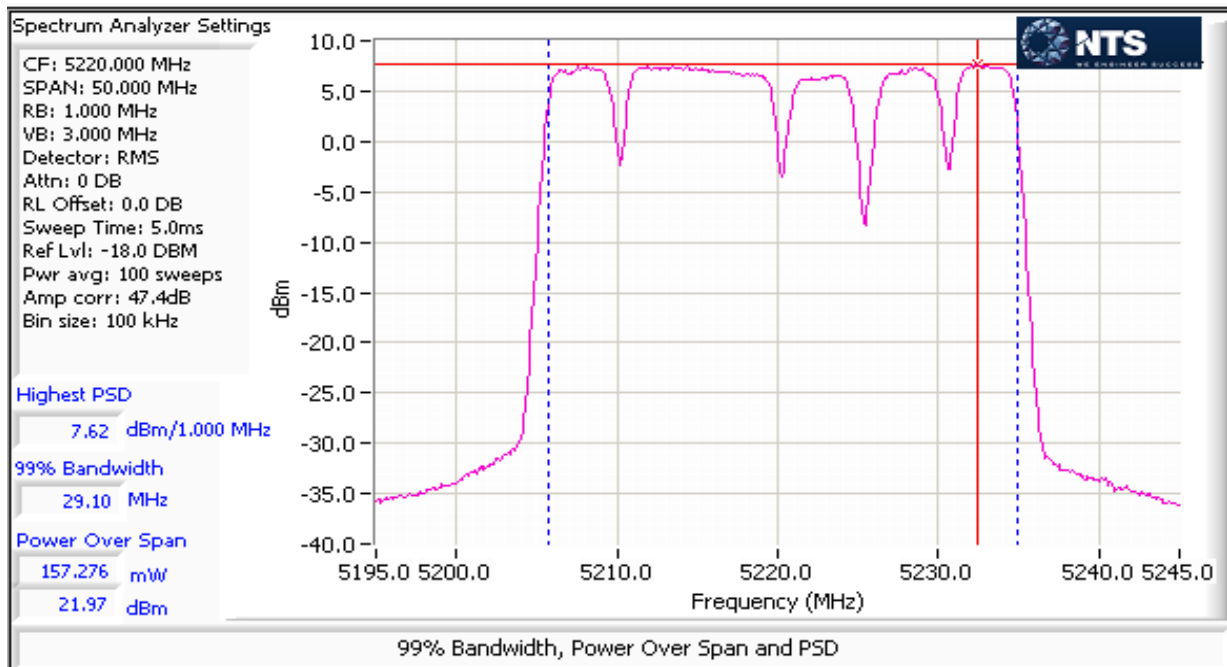

Client: Nextivity Inc	Job Number: J94664
Model: D32-2/4NU and D32-2/4CU	T-Log Number: T94720
	Account Manager: Christine Krebill
Contact: Michiel Lotter	
Standard: FCC Part 15.247, Part 15.407 and RSS 210	Class: N/A

NU Ch Freq 5240 MHz @ 30 MHz Bandwidth (U-NII-1)

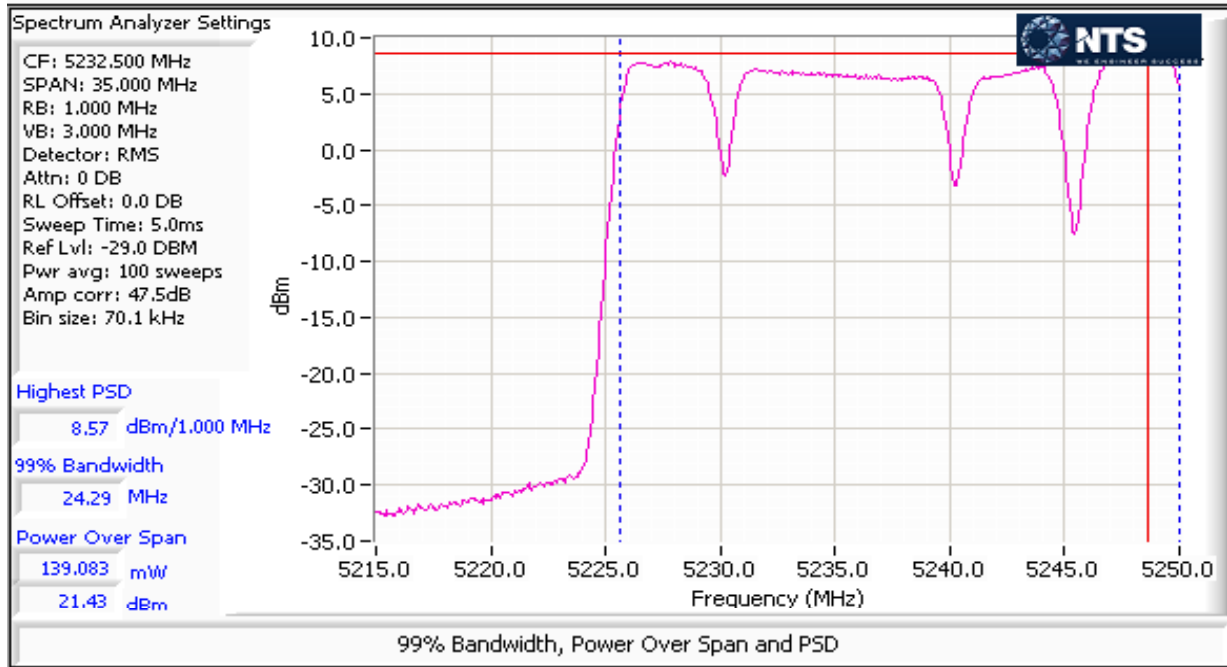

NU Ch Freq 5240 MHz @ 30 MHz Bandwidth (U-NII-2A)

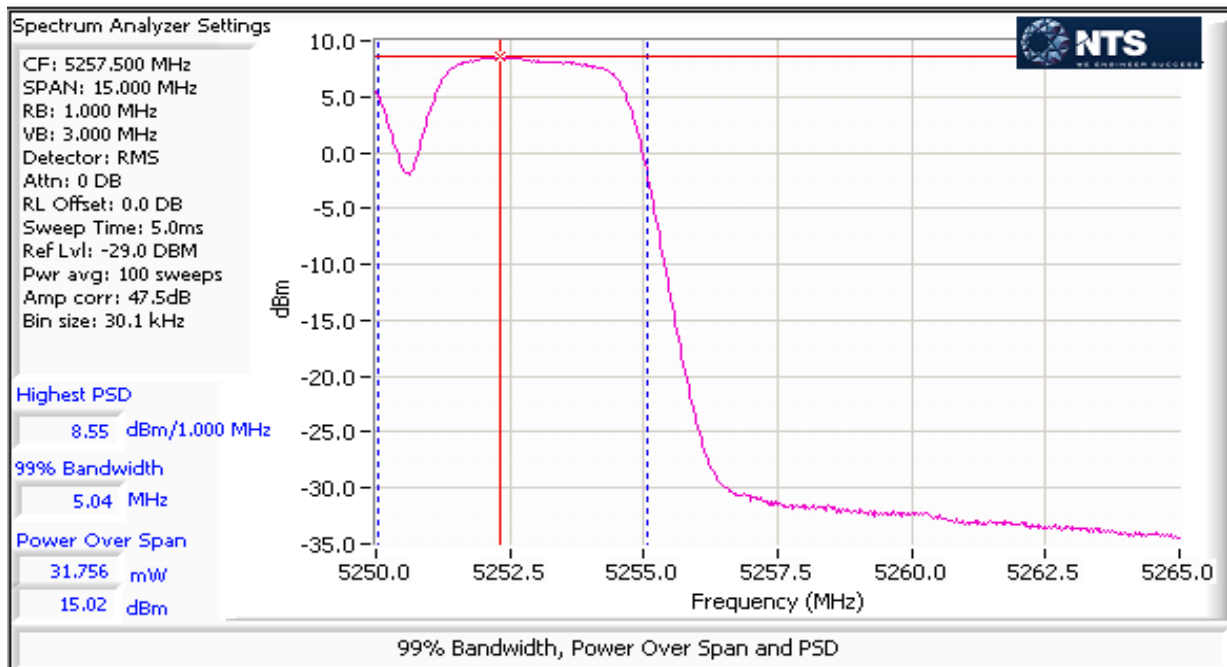

Client: Nextivity Inc	Job Number: J94664
Model: D32-2/4NU and D32-2/4CU	T-Log Number: T94720
	Account Manager: Christine Krebill
Contact: Michiel Lotter	
Standard: FCC Part 15.247, Part 15.407 and RSS 210	Class: N/A

NU Ch Freq 5260 MHz @ 30 MHz Bandwidth (U-NII-1)

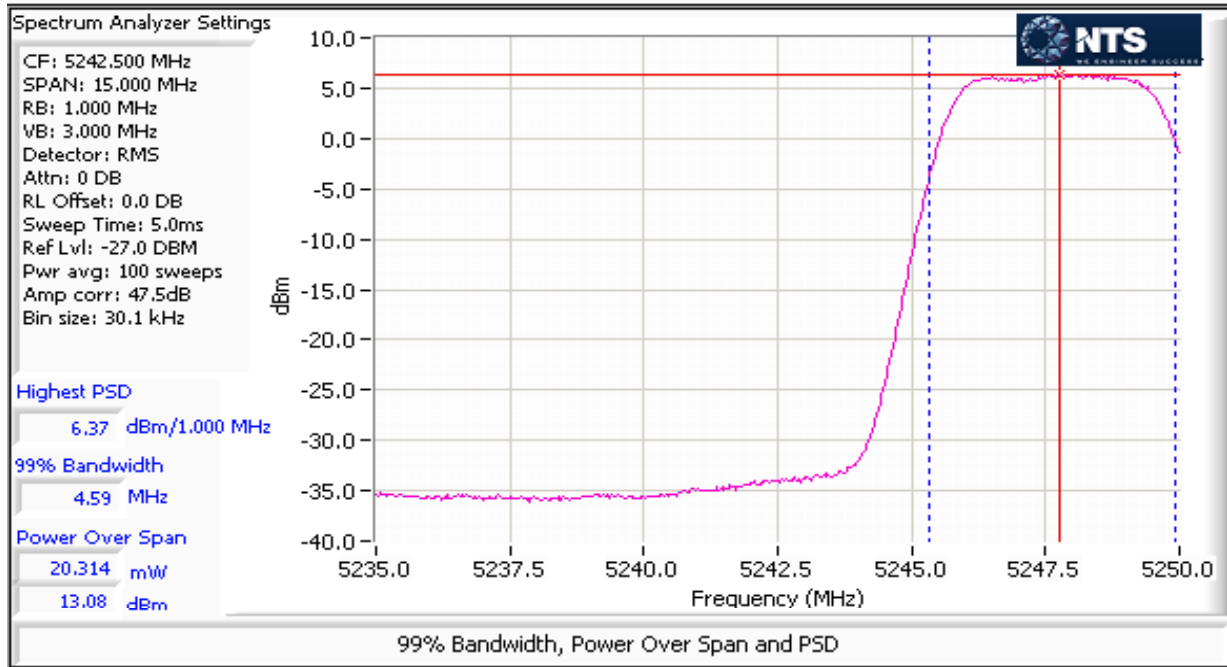

NU Ch Freq 5260 MHz @ 30 MHz Bandwidth (U-NII-2A)

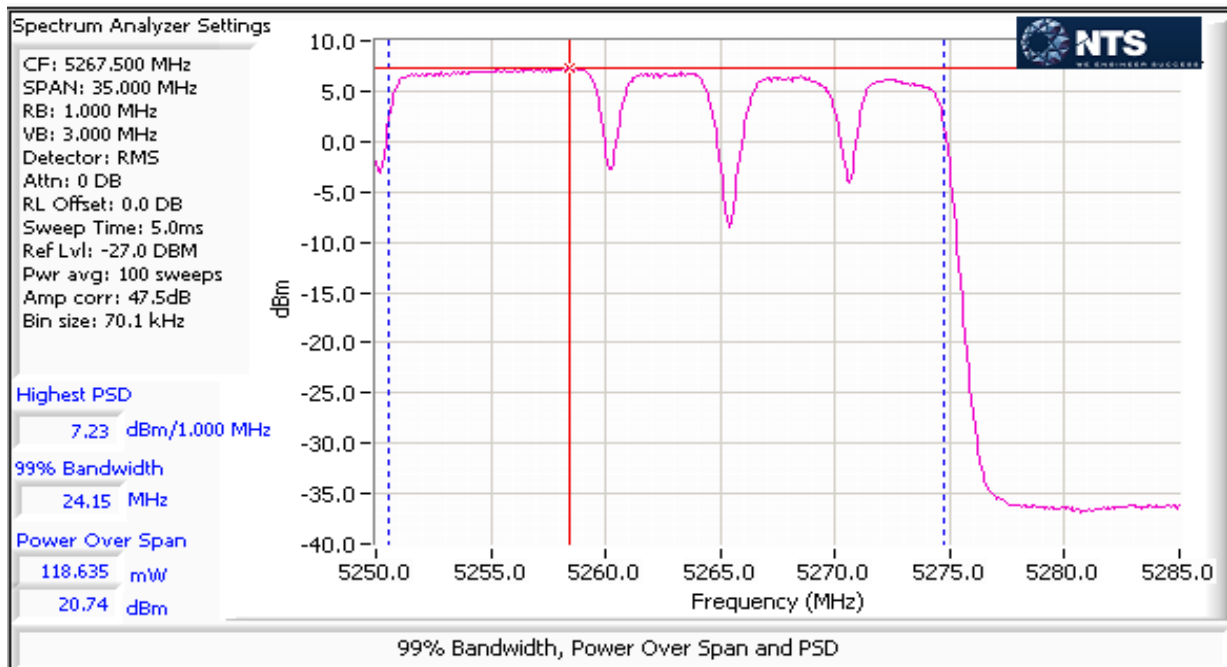

Client: Nextivity Inc	Job Number: J94664
Model: D32-2/4NU and D32-2/4CU	T-Log Number: T94720
	Account Manager: Christine Krebill
Contact: Michiel Lotter	
Standard: FCC Part 15.247, Part 15.407 and RSS 210	Class: N/A

NU Ch Freq 5280 MHz @ 30 MHz Bandwidth

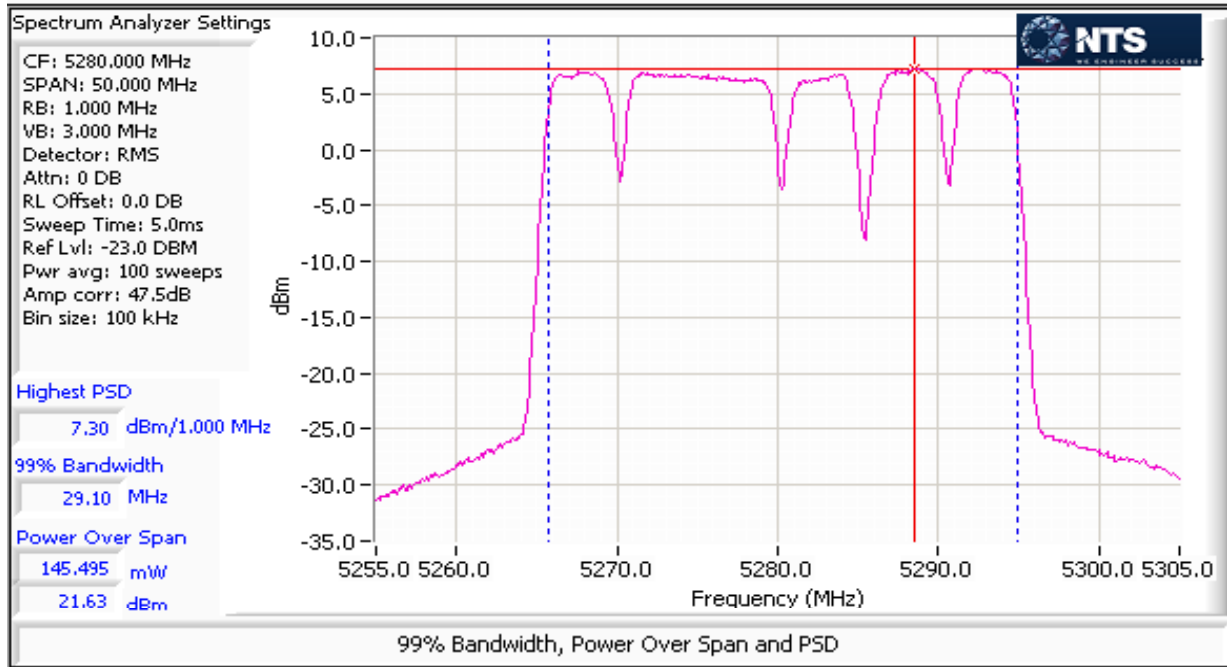

NU Ch Freq 5293 MHz @ 30 MHz Bandwidth

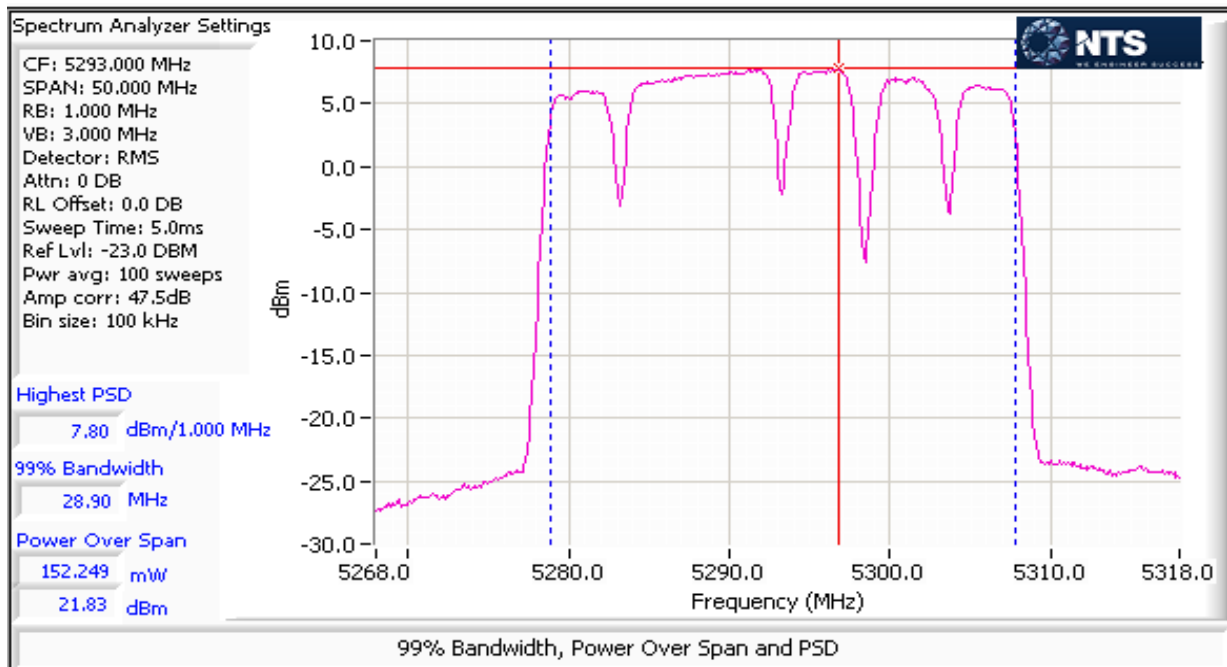

Client: Nextivity Inc	Job Number: J94664
Model: D32-2/4NU and D32-2/4CU	T-Log Number: T94720
	Account Manager: Christine Krebill
Contact: Michiel Lotter	
Standard: FCC Part 15.247, Part 15.407 and RSS 210	Class: N/A

NU Ch Freq 5207 MHz @ 40 MHz Bandwidth

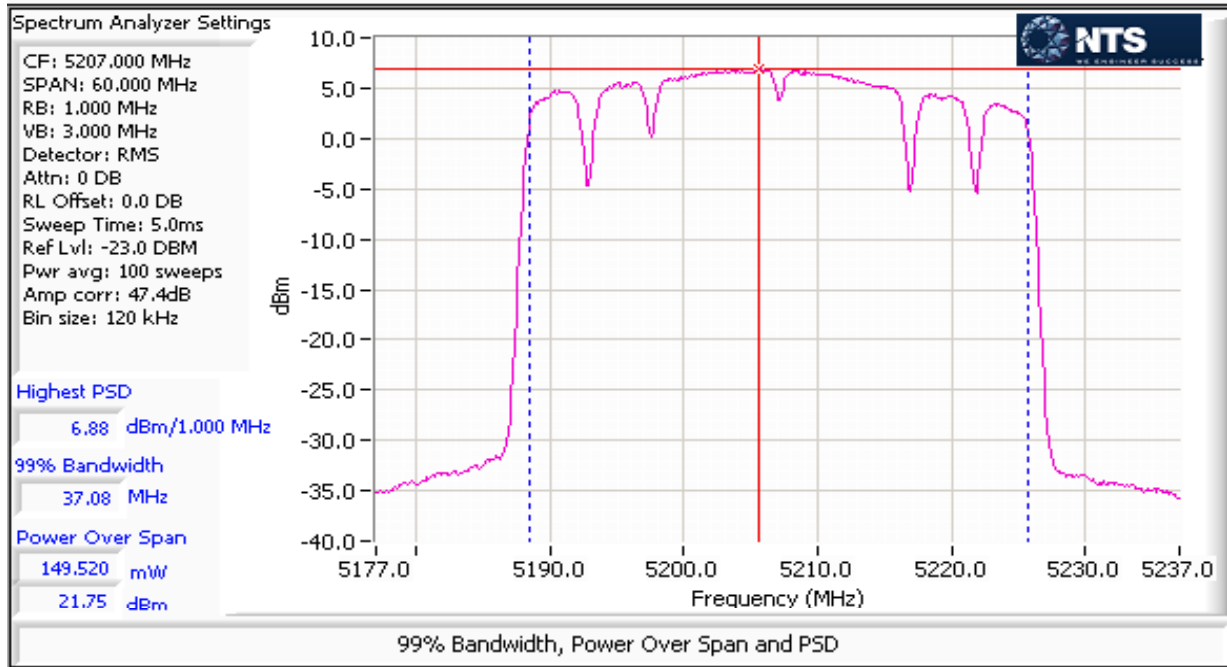

NU Ch Freq 5220 MHz @ 40 MHz Bandwidth

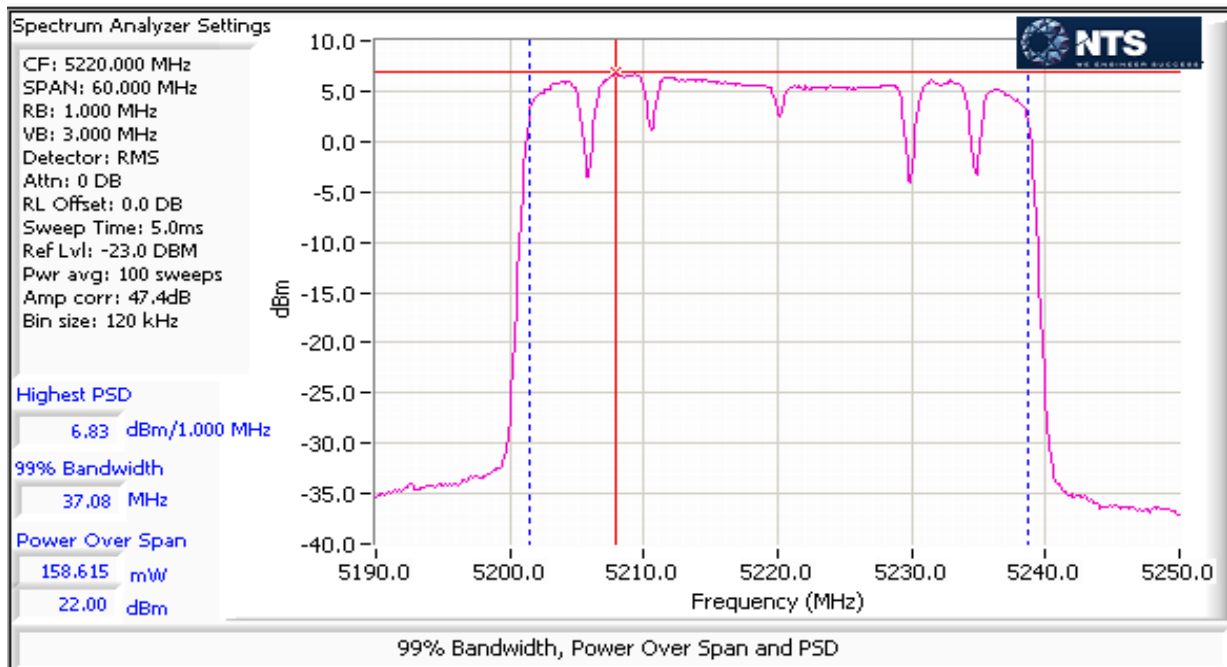

Client: Nextivity Inc	Job Number: J94664
Model: D32-2/4NU and D32-2/4CU	T-Log Number: T94720
Contact: Michiel Lotter	Account Manager: Christine Krebill
Standard: FCC Part 15.247, Part 15.407 and RSS 210	Class: N/A

NU Ch Freq 5240 MHz @ 40 MHz Bandwidth (U-NII-1)

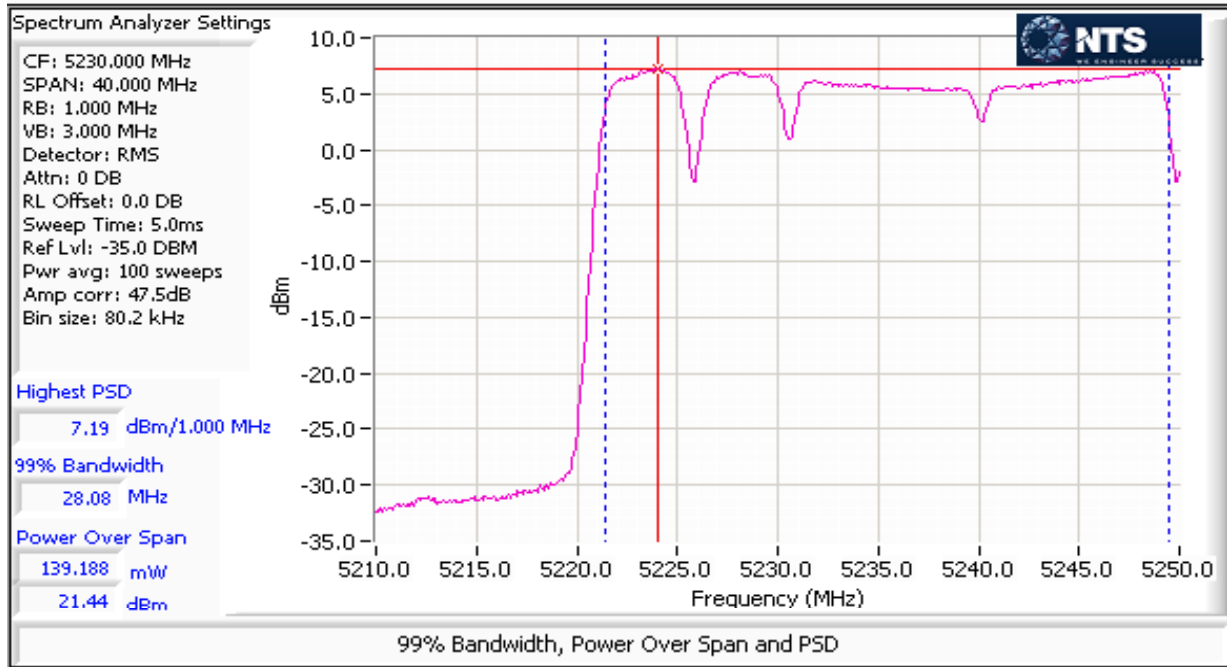

NU Ch Freq 5240 MHz @ 40 MHz Bandwidth (U-NII-2A)

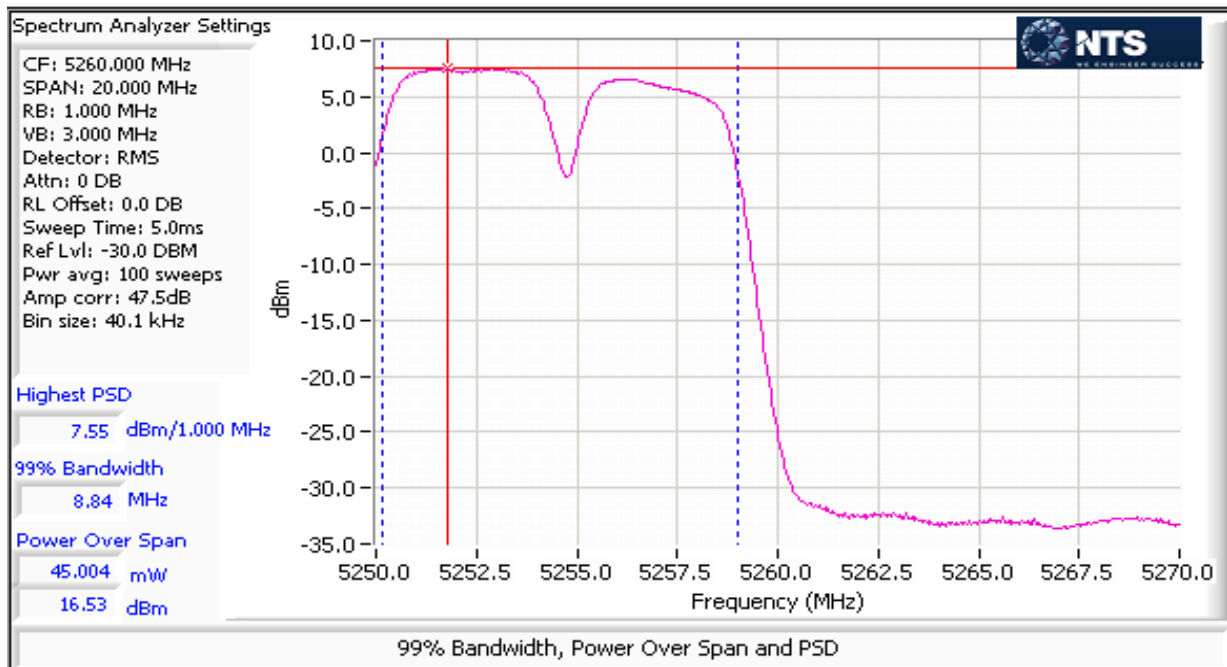

Client: Nextivity Inc	Job Number: J94664
Model: D32-2/4NU and D32-2/4CU	T-Log Number: T94720
	Account Manager: Christine Krebill
Contact: Michiel Lotter	
Standard: FCC Part 15.247, Part 15.407 and RSS 210	Class: N/A

NU Ch Freq 5260 MHz @ 40 MHz Bandwidth (U-NII-1)

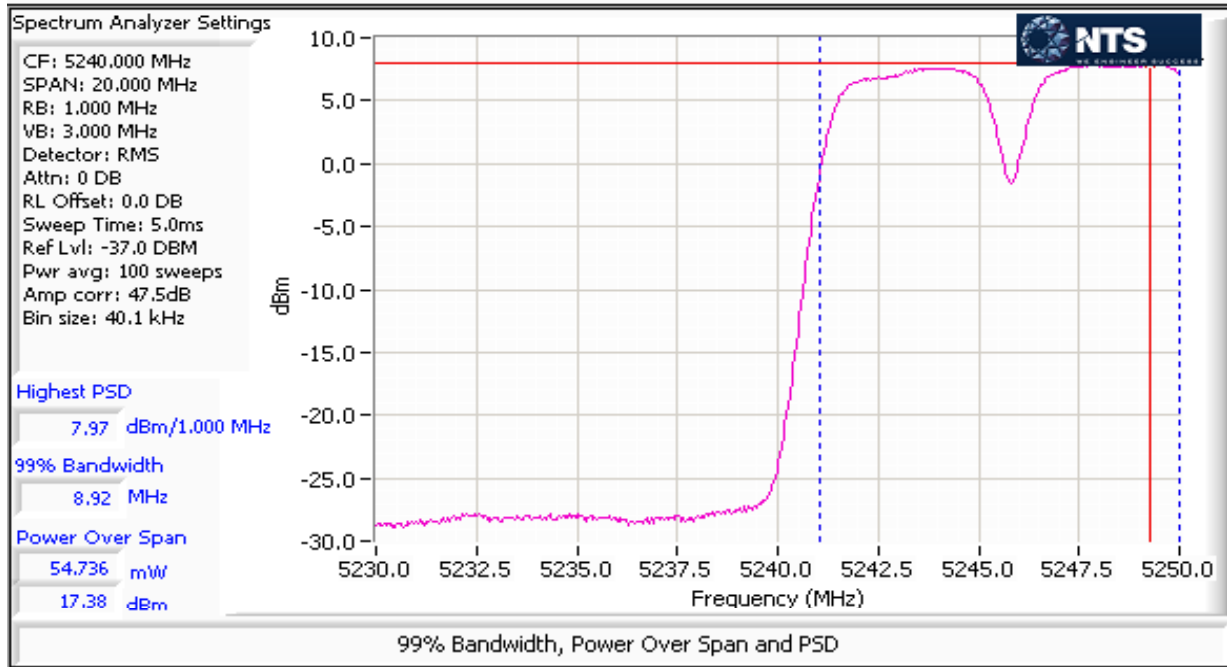

NU Ch Freq 5260 MHz @ 40 MHz Bandwidth (U-NII-2A)

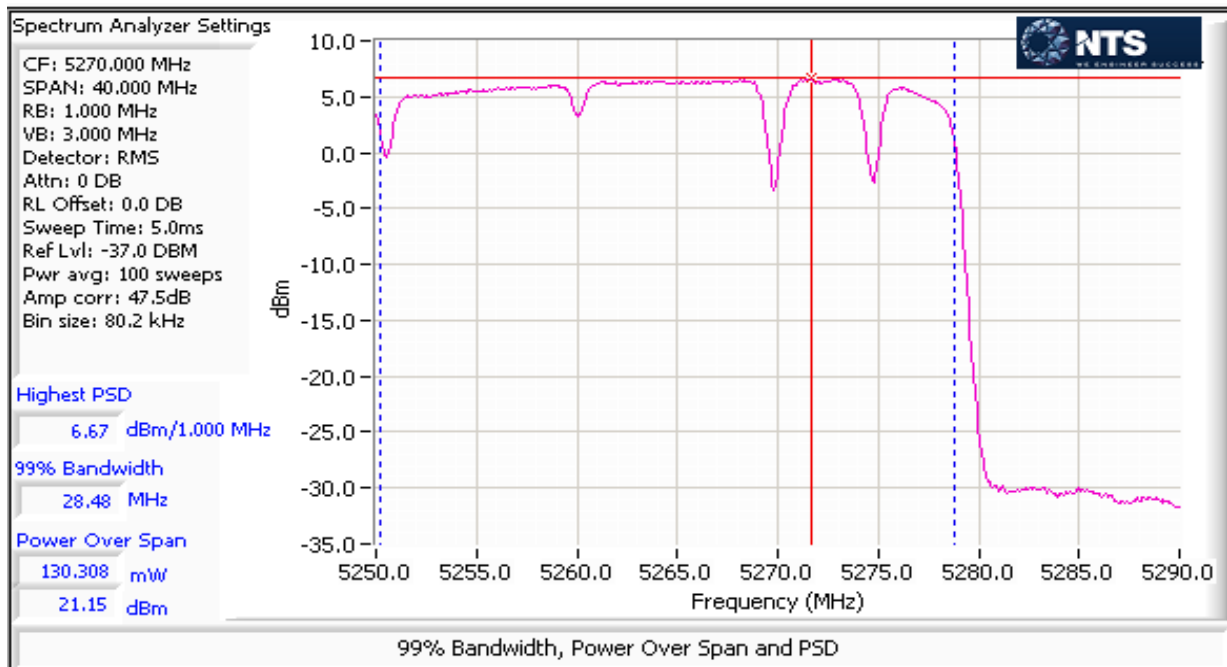

Client: Nextivity Inc	Job Number: J94664
Model: D32-2/4NU and D32-2/4CU	T-Log Number: T94720
	Account Manager: Christine Krebill
Contact: Michiel Lotter	
Standard: FCC Part 15.247, Part 15.407 and RSS 210	Class: N/A

NU Ch Freq 5280 MHz @ 40 MHz Bandwidth

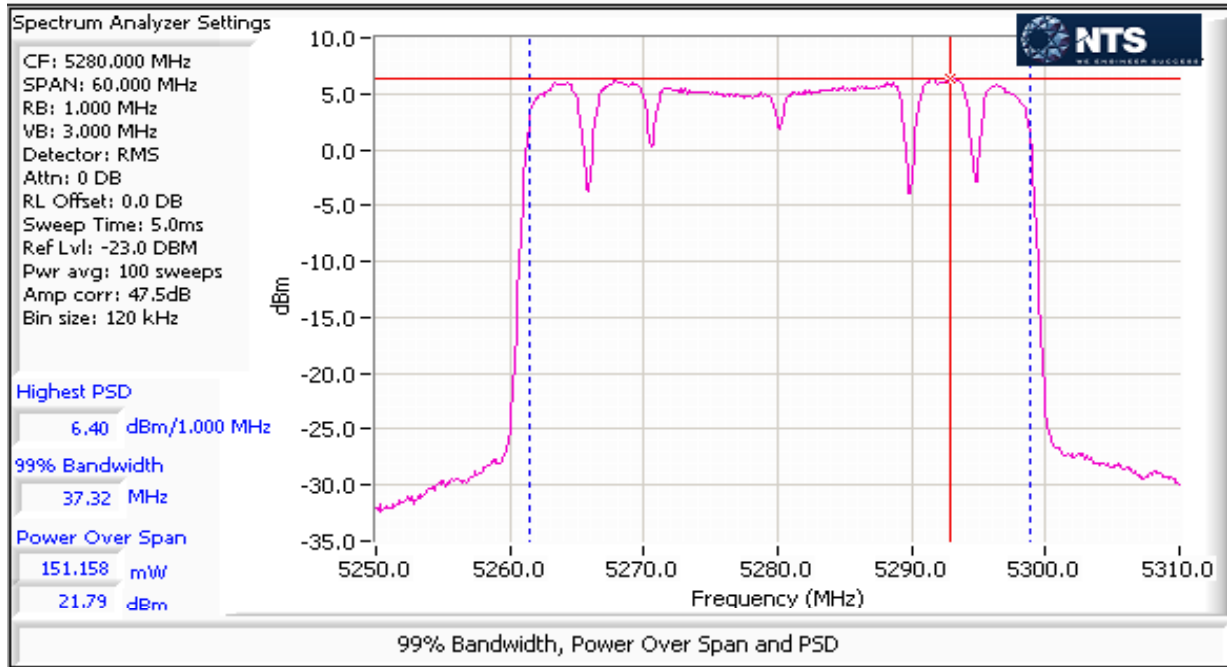

NU Ch Freq 5293 MHz @ 40 MHz Bandwidth

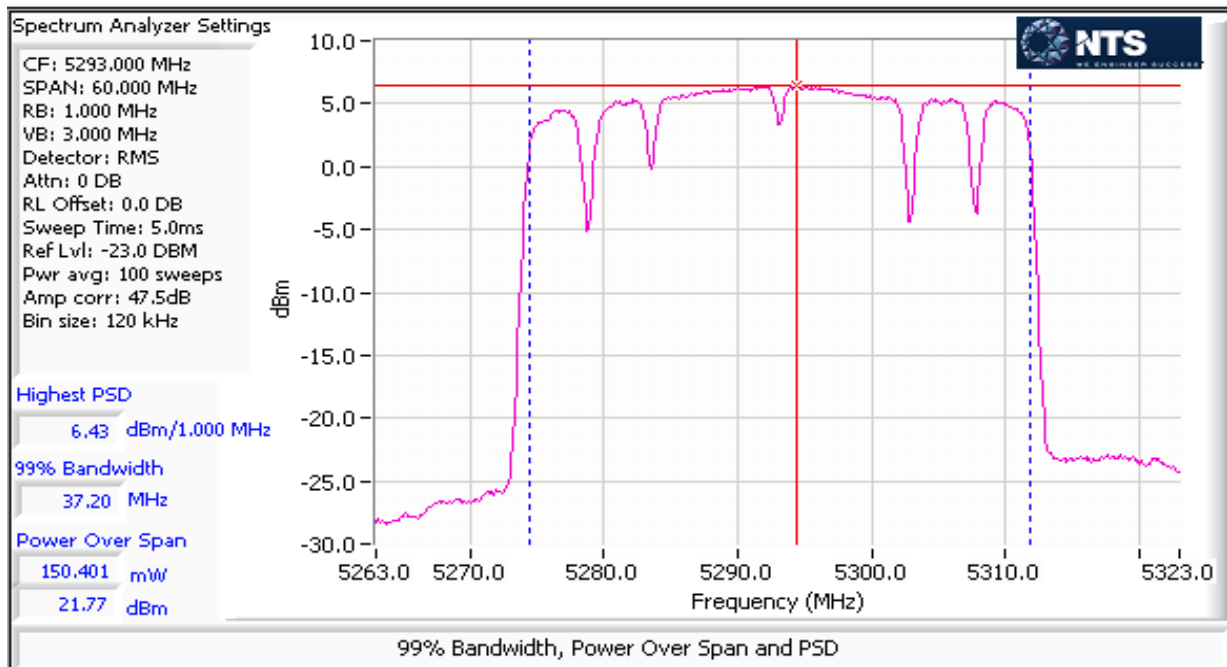

Client: Nextivity Inc	Job Number: J94664
Model: D32-2/4NU and D32-2/4CU	T-Log Number: T94720
	Account Manager: Christine Krebill
Contact: Michiel Lotter	
Standard: FCC Part 15.247, Part 15.407 and RSS 210	Class: N/A

NU Ch Freq 5207 MHz @ 30 MHz Bandwidth

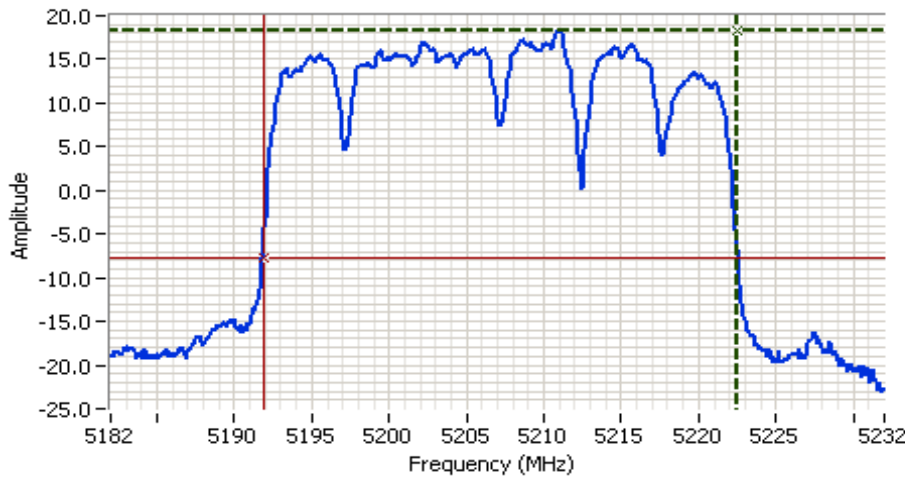

Analyzer Settings

Rohde&Schwarz,ESI
 CF: 5207.000 MHz
 SPAN: 50.000 MHz
 RB: 1.000 MHz
 VB: 3.000 MHz
 Detector: POS
 Attn: 0 DB
 RL Offset: 47.4 DB
 Sweep Time: 5.0ms
 Ref Lvl: 27.4 DBM

Comments

26dB BW: 30.561 MHz
 5207 MHz 30 MHz BW

Cursor 1 5222.4810 18.35
 Cursor 2 5191.9198 -7.65

Delta Freq. 30.561
 Delta Amplitude 26.00



NU Ch Freq 5220 MHz @ 30 MHz Bandwidth

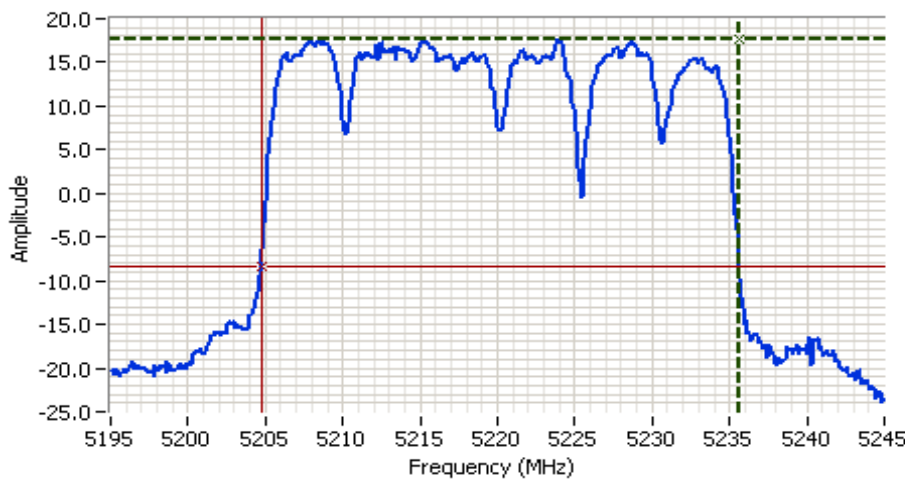

Analyzer Settings

Rohde&Schwarz,ESI
 CF: 5220.000 MHz
 SPAN: 50.000 MHz
 RB: 1.000 MHz
 VB: 3.000 MHz
 Detector: POS
 Attn: 0 DB
 RL Offset: 47.4 DB
 Sweep Time: 5.0ms
 Ref Lvl: 29.4 DBM

Comments

26dB BW: 30.862 MHz
 5220 MHz 30 MHz BW

Cursor 1 5235.5812 17.68
 Cursor 2 5204.7194 -8.32

Delta Freq. 30.862
 Delta Amplitude 26.00



Client: Nextivity Inc	Job Number: J94664
Model: D32-2/4NU and D32-2/4CU	T-Log Number: T94720
Contact: Michiel Lotter	Account Manager: Christine Krebill
Standard: FCC Part 15.247, Part 15.407 and RSS 210	Class: N/A

NU Ch Freq 5240 MHz @ 30 MHz Bandwidth (U-NII-1: 25.281 MHz, U-NII-2A: 5.581 MHz)



Analyzer Settings

Rohde&Schwarz,ESI
 CF: 5240.000 MHz
 SPAN: 50.000 MHz
 RB: 1.000 MHz
 VB: 3.000 MHz
 Detector: POS
 Attn: 0 DB
 RL Offset: 47.5 DB
 Sweep Time: 5.0ms
 Ref Lvl: 18.5 DBM

Comments

Total 26dB BW: 30.862 MHz
 U-NII 1: 25.281 MHz
 UNII 2A: 5.581 MHz
 5240 MHz 30 MHz BW

Cursor 1	5255.5812	18.69	
Cursor 2	5224.7194	-7.31	

Delta Freq. 30.862
 Delta Amplitude 26.00



NU Ch Freq 5260 MHz @ 30 MHz Bandwidth (U-NII-1: 5.180 MHz, U-NII-2A: 25.381 MHz)

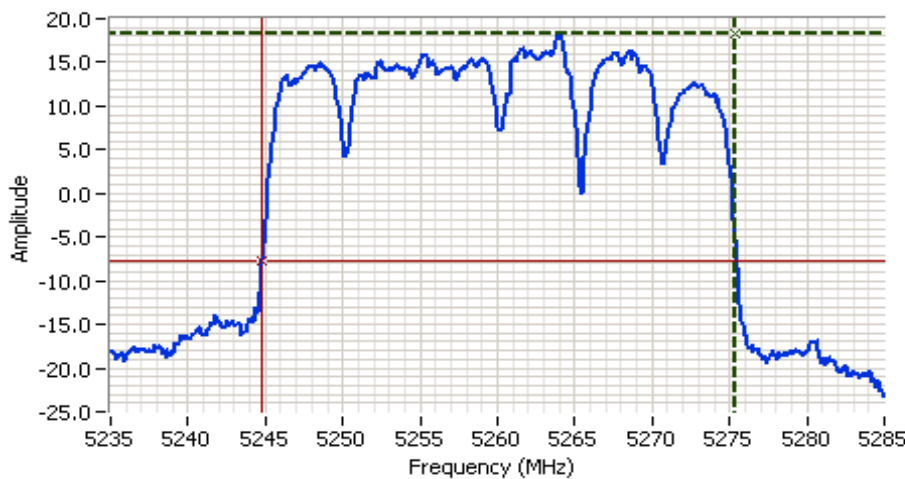

Analyzer Settings

Rohde&Schwarz,ESI
 CF: 5260.000 MHz
 SPAN: 50.000 MHz
 RB: 1.000 MHz
 VB: 3.000 MHz
 Detector: POS
 Attn: 0 DB
 RL Offset: 47.5 DB
 Sweep Time: 5.0ms
 Ref Lvl: 32.5 DBM

Comments

26dB BW: 30.561 MHz
 5260 MHz 30 MHz BW

Cursor 1	5275.3808	18.20	
Cursor 2	5244.8196	-7.80	

Delta Freq. 30.561
 Delta Amplitude 26.00



Client: Nextivity Inc	Job Number: J94664
Model: D32-2/4NU and D32-2/4CU	T-Log Number: T94720
Contact: Michiel Lotter	Account Manager: Christine Krebill
Standard: FCC Part 15.247, Part 15.407 and RSS 210	Class: N/A

NU Ch Freq 5280 MHz @ 30 MHz Bandwidth

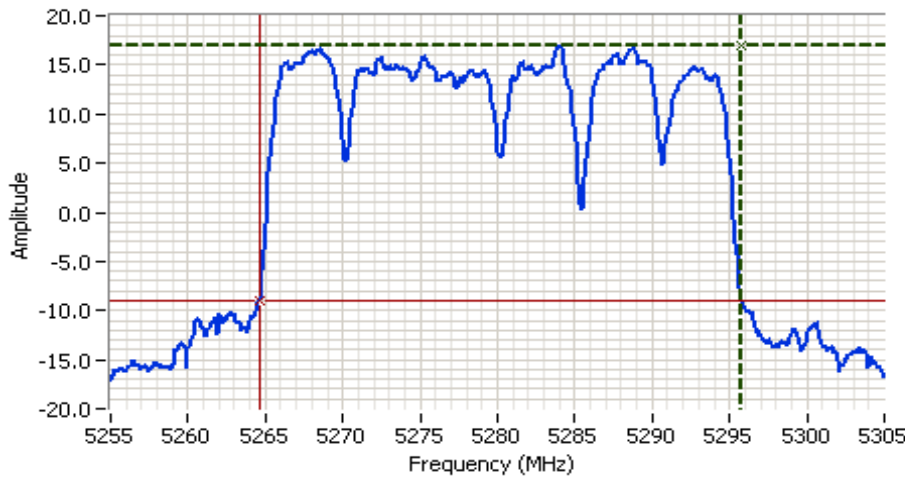

Analyzer Settings

Rohde&Schwarz,ESI
 CF: 5280.000 MHz
 SPAN: 50.000 MHz
 RB: 1.000 MHz
 VB: 3.000 MHz
 Detector: POS
 Attn: 0 DB
 RL Offset: 47.5 DB
 Sweep Time: 5.0ms
 Ref Lvl: 24.5 DBM

Comments

26dB BW: 31.162 MHz
 5280 MHz 30 MHz BW

Cursor 1 5295.7816 16.90
 Cursor 2 5264.6192 -9.10

Delta Freq. 31.162
 Delta Amplitude 26.00



NU Ch Freq 5293 MHz @ 30 MHz Bandwidth

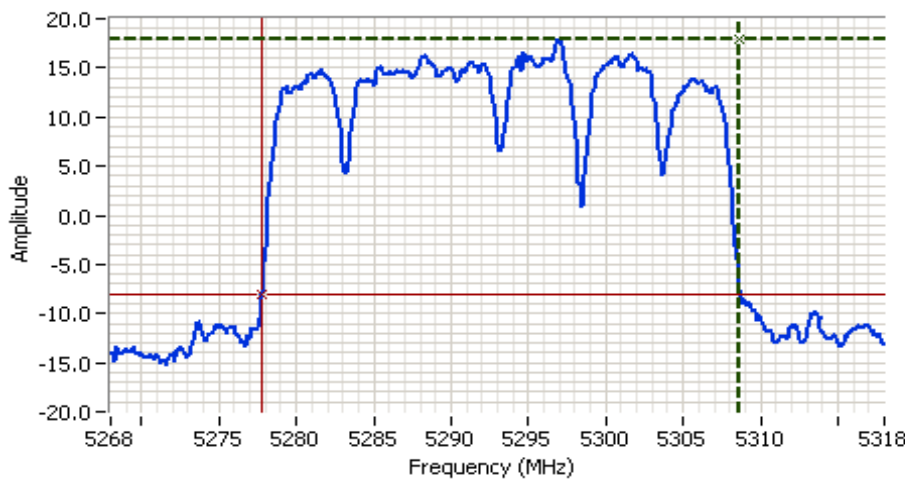

Analyzer Settings

Rohde&Schwarz,ESI
 CF: 5293.000 MHz
 SPAN: 50.000 MHz
 RB: 1.000 MHz
 VB: 3.000 MHz
 Detector: POS
 Attn: 0 DB
 RL Offset: 47.5 DB
 Sweep Time: 5.0ms
 Ref Lvl: 24.5 DBM

Comments

26dB BW: 30.862 MHz
 5293 MHz 30 MHz BW

Cursor 1 5308.6814 17.89
 Cursor 2 5277.8196 -8.11

Delta Freq. 30.862
 Delta Amplitude 26.00



Client: Nextivity Inc	Job Number: J94664
Model: D32-2/4NU and D32-2/4CU	T-Log Number: T94720
	Account Manager: Christine Krebill
Contact: Michiel Lotter	
Standard: FCC Part 15.247, Part 15.407 and RSS 210	Class: N/A

NU Ch Freq 5207 MHz @ 40 MHz Bandwidth

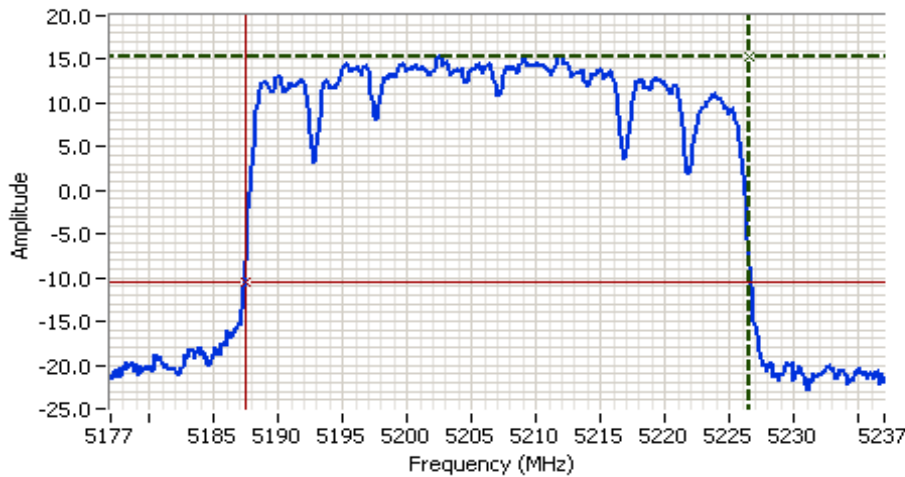

Analyzer Settings

Rohde&Schwarz,ESI
 CF: 5207.000 MHz
 SPAN: 60.000 MHz
 RB: 1.000 MHz
 VB: 3.000 MHz
 Detector: POS
 Attn: 0 DB
 RL Offset: 47.4 DB
 Sweep Time: 5.0ms
 Ref Lvl: 24.4 DBM

Comments

26dB BW: 39.078 MHz
 5207 MHz 40 MHz BW

Cursor 1	5226.5391	15.41	
Cursor 2	5187.4609	-10.59	

Delta Freq. 39.078
 Delta Amplitude 26.00



NU Ch Freq 5220 MHz @ 40 MHz Bandwidth



Analyzer Settings

Rohde&Schwarz,ESI
 CF: 5220.000 MHz
 SPAN: 60.000 MHz
 RB: 1.000 MHz
 VB: 3.000 MHz
 Detector: POS
 Attn: 0 DB
 RL Offset: 47.4 DB
 Sweep Time: 5.0ms
 Ref Lvl: 24.4 DBM

Comments

26dB BW: 39.198 MHz
 5220 MHz 40 MHz BW

Cursor 1	5239.5391	16.88	
Cursor 2	5200.3407	-9.12	

Delta Freq. 39.198
 Delta Amplitude 26.00



Client: Nextivity Inc	Job Number: J94664
Model: D32-2/4NU and D32-2/4CU	T-Log Number: T94720
Contact: Michiel Lotter	Account Manager: Christine Krebill
Standard: FCC Part 15.247, Part 15.407 and RSS 210	Class: N/A

NU Ch Freq 5240 MHz @ 40 MHz Bandwidth

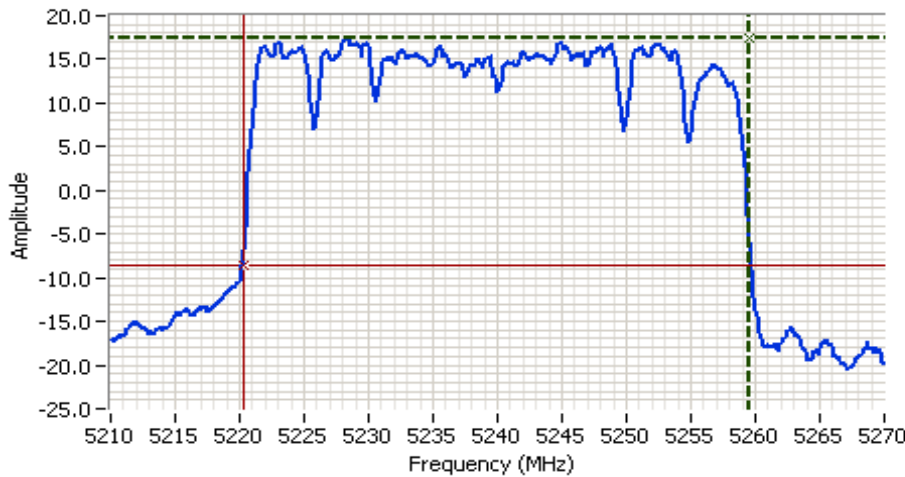

Analyzer Settings

Rohde&Schwarz,ESI
 CF: 5240.000 MHz
 SPAN: 60.000 MHz
 RB: 1.000 MHz
 VB: 3.000 MHz
 Detector: POS
 Attn: 0 DB
 RL Offset: 47.5 DB
 Sweep Time: 5.0ms
 Ref Lvl: 17.5 DBM

Comments

Total 26dB BW: 39.198 MHz
 U-NII 1: 29.659 MHz
 UNII 2A: 9.539 MHz
 5240 MHz 40 MHz BW

Cursor 1 5259.5391 17.44
 Cursor 2 5220.3407 -8.56

Delta Freq. 39.198
 Delta Amplitude 26.00



NU Ch Freq 5260 MHz @ 40 MHz Bandwidth (U-NII-1: 9.539 MHz, U-NII-2A: 29.539 MHz)

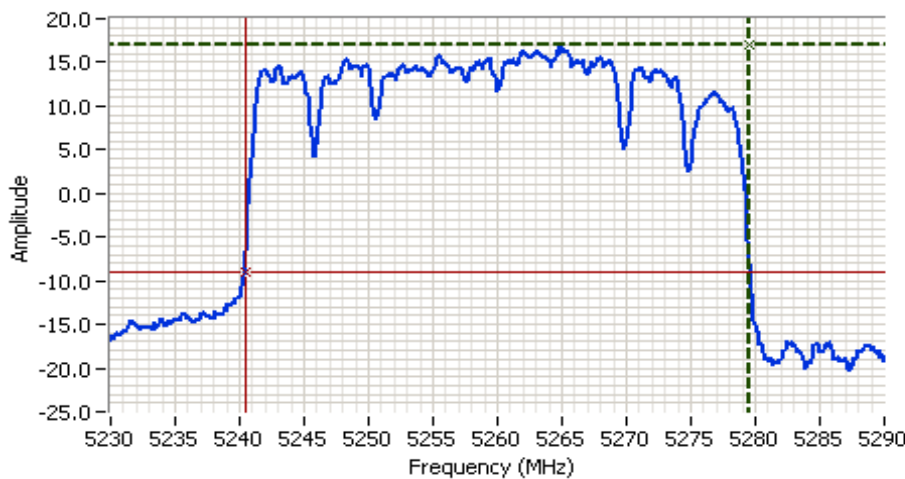

Analyzer Settings

Rohde&Schwarz,ESI
 CF: 5260.000 MHz
 SPAN: 60.000 MHz
 RB: 1.000 MHz
 VB: 3.000 MHz
 Detector: POS
 Attn: 0 DB
 RL Offset: 47.5 DB
 Sweep Time: 5.0ms
 Ref Lvl: 24.5 DBM

Comments

26dB BW: 39.078 MHz
 5260 MHz 40 MHz BW

Cursor 1 5279.5391 16.95
 Cursor 2 5240.4609 -9.05

Delta Freq. 39.078
 Delta Amplitude 26.00



Client: Nextivity Inc	Job Number: J94664
Model: D32-2/4NU and D32-2/4CU	T-Log Number: T94720
Contact: Michiel Lotter	Account Manager: Christine Krebill
Standard: FCC Part 15.247, Part 15.407 and RSS 210	Class: N/A

NU Ch Freq 5280 MHz @ 40 MHz Bandwidth

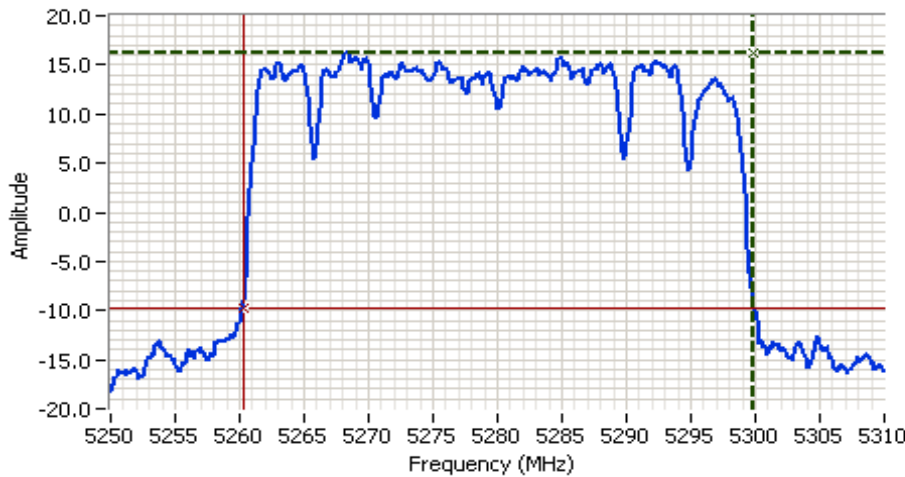

Analyzer Settings

Rohde&Schwarz,ESI
 CF: 5280.000 MHz
 SPAN: 60.000 MHz
 RB: 1.000 MHz
 VB: 3.000 MHz
 Detector: POS
 Attn: 0 DB
 RL Offset: 47.5 DB
 Sweep Time: 5.0ms
 Ref Lvl: 24.5 DBM

Comments

26dB BW: 39.559 MHz
 5280 MHz 40 MHz BW

Cursor 1	5299.8998	16.30	
Cursor 2	5260.3407	-9.70	

Delta Freq. 39.559
 Delta Amplitude 26.00



NU Ch Freq 5293 MHz @ 40 MHz Bandwidth



Analyzer Settings

Rohde&Schwarz,ESI
 CF: 5293.000 MHz
 SPAN: 60.000 MHz
 RB: 1.000 MHz
 VB: 3.000 MHz
 Detector: POS
 Attn: 0 DB
 RL Offset: 47.5 DB
 Sweep Time: 5.0ms
 Ref Lvl: 25.0 DBM

Comments

26dB BW: 45.210 MHz
 5293 MHz 40 MHz BW

Cursor 1	5318.6713	9.33	
Cursor 2	5273.4609	-16.67	

Delta Freq. 45.210
 Delta Amplitude 26.00



Client: Nextivity Inc	Job Number: J94664
Model: D32-2/4NU and D32-2/4CU	T-Log Number: T94720
	Account Manager: Christine Krebill
Contact: Michiel Lotter	
Standard: FCC Part 15.247, Part 15.407 and RSS 210	Class: N/A

Run #2: Peak Excursion Measurement

30MHz: Device meets the requirement for the peak excursion

Peak Excursion(dB)			Peak Excursion(dB)			Peak Excursion(dB)		
Freq (MHz)	Value	Limit	Freq (MHz)	Value	Limit	Freq (MHz)	Value	Limit
5207.0	11.1	13.0	5240.0	10.6	13.0	5280.0	10.4	13.0
5220.0	10.0	13.0	5260.0	10.9	13.0	5293.0	10.9	13.0

40MHz: Device meets the requirement for the peak excursion

Peak Excursion(dB)			Peak Excursion(dB)			Peak Excursion(dB)		
Freq (MHz)	Value	Limit	Freq (MHz)	Value	Limit	Freq (MHz)	Value	Limit
5207.0	10.1	13.0	5240.0	10.3	13.0	5280.0	9.9	13.0
5220.0	10.1	13.0	5260.0	10.2	13.0	5293.0	9.8	13.0

Client: Nextivity Inc	Job Number: J94664
Model: D32-2/4NU and D32-2/4CU	T-Log Number: T94720
	Account Manager: Christine Krebill
Contact: Michiel Lotter	
Standard: FCC Part 15.247, Part 15.407 and RSS 210	Class: N/A

Worst Case Plots Showing Peak Excursion

Trace A: RBW = 1MHz, VBW = 3MHz, Peak hold

Trace B: Same settings as used for power/PSD measurements (RBW = 1 MHz, VBW = 3MHz, Integrated average power)

NU Ch Freq 5207 MHz @ 30 MHz Bandwidth

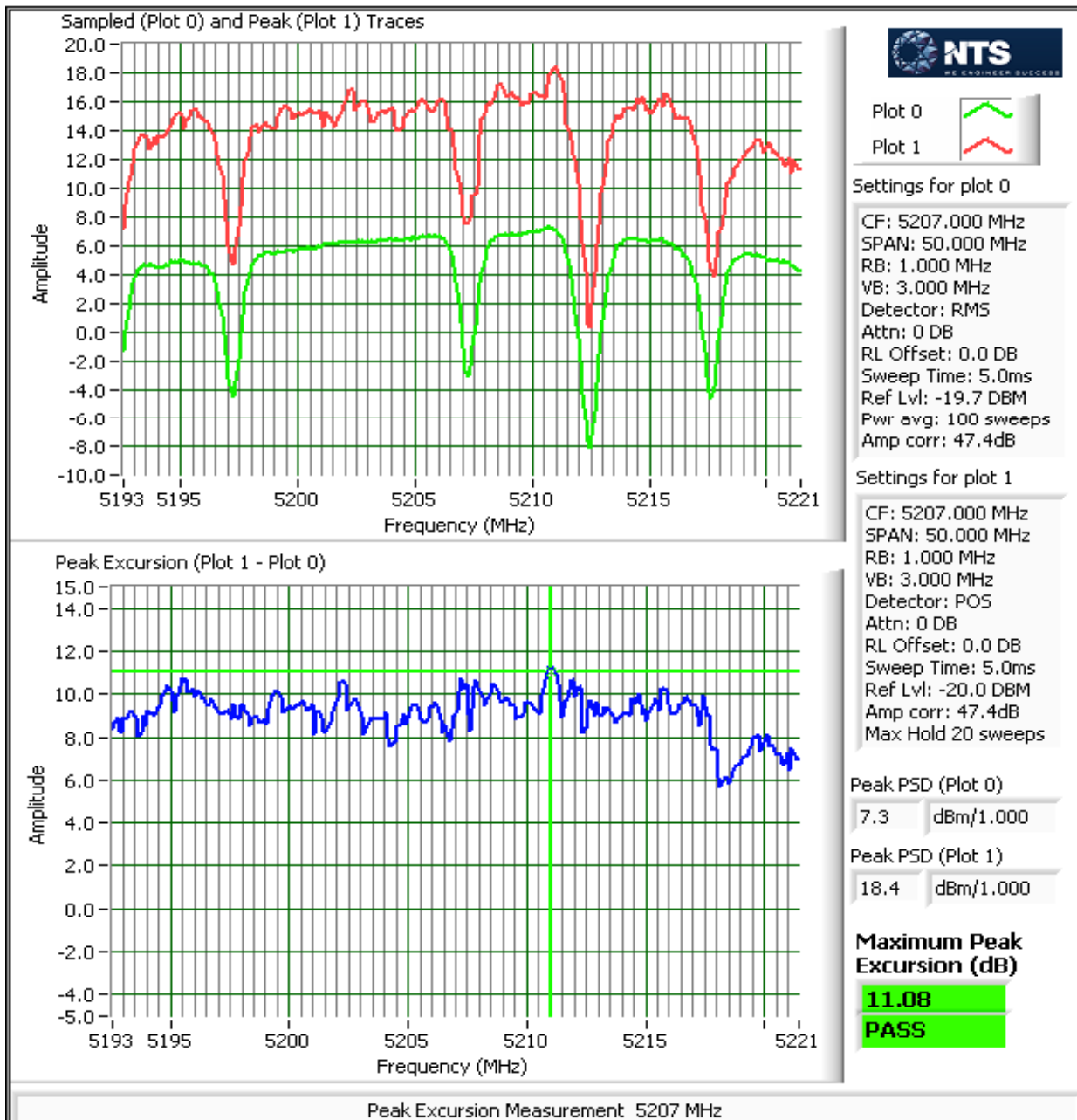

Client: Nextivity Inc	Job Number: J94664
Model: D32-2/4NU and D32-2/4CU	T-Log Number: T94720
	Account Manager: Christine Krebill
Contact: Michiel Lotter	
Standard: FCC Part 15.247, Part 15.407 and RSS 210	Class: N/A

RSS 210 and FCC 15.407 (UNII) Radiated Spurious Emissions

Test Specific Details

Objective: The objective of this test session is to perform final qualification testing of the EUT with respect to the specification listed above.

General Test Configuration

The EUT was located on the turntable for radiated spurious emissions testing.

For radiated emissions testing the measurement antenna was located 3 meters from the EUT.

Ambient Conditions: Temperature: 21-24 °C
Rel. Humidity: 30-45 %

Summary of Results (30 MHz BW)

Run #	Mode	Channel	Power Setting	Measured Power	Test Performed	Limit	Result / Margin
1 U-NII 1 5150-5250	Proprietary 30 MHz BW	Low 5207 MHz	-	-	Restricted Band Edge 5150 MHz	15.209	46.2 dBµV/m @ 5150.0 MHz (-7.8 dB)
		Low 5207 MHz	-	-	Radiated Emissions, 30 MHz - 40 GHz	FCC 15.209 / 15 E	36.3 dBµV/m @ 37.70 MHz (-3.7 dB)
		Center 5220 MHz	-	-	Radiated Emissions, 1 GHz - 40 GHz	FCC 15.209 / 15 E	45.0 dBµV/m @ 5434.4 MHz (-9.0 dB)
		High 5240 MHz	-	-	Radiated Emissions, 1 GHz - 40 GHz	FCC 15.209 / 15 E	44.9 dBµV/m @ 5435.9 MHz (-9.1 dB)
2 U-NII 2A 5250-5350	Proprietary 30 MHz BW	Low 5260 MHz	-	-	Radiated Emissions, 30 MHz - 40 GHz	FCC 15.209 / 15 E	38.0 dBµV/m @ 37.86 MHz (-2.0 dB)
		Center 5280 MHz	-	-	Radiated Emissions, 1 GHz - 40 GHz	FCC 15.209 / 15 E	45.4 dBµV/m @ 5432.0 MHz (-8.6 dB)
		High 5293 MHz	-	-	Radiated Emissions, 1 GHz - 40 GHz	FCC 15.209 / 15 E	45.4 dBµV/m @ 5432.0 MHz (-8.6 dB)
		High 5293 MHz	-	-	Restricted Band Edge 5350 MHz	15.209	52.0 dBµV/m @ 5350.0 MHz (-2.0 dB)



EMC Test Data

Client: Nextivity Inc	Job Number: J94664
Model: D32-2/4NU and D32-2/4CU	T-Log Number: T94720
	Account Manager: Christine Krebill
Contact: Michiel Lotter	
Standard: FCC Part 15.247, Part 15.407 and RSS 210	Class: N/A

Summary of Results (40 MHz BW)

Run #	Mode	Channel	Power Setting	Measured Power	Test Performed	Limit	Result / Margin
3 U-NII 1 5150-5250	Proprietary 40 MHz BW	Low 5207 MHz	-	-	Restricted Band Edge at 5150 MHz	15.209	51.3 dBµV/m @ 5150.0 MHz (-2.7 dB)
		Low 5207 MHz	-	-	Radiated Emissions, 30 MHz - 40 GHz	FCC 15.209 / 15 E	36.3 dBµV/m @ 37.64 MHz (-3.7 dB)
		Center 5220 MHz	-	-	Radiated Emissions, 1 GHz - 40 GHz	FCC 15.209 / 15 E	45.3 dBµV/m @ 5432.7 MHz (-8.7 dB)
		High 5240 MHz	-	-	Radiated Emissions, 1 GHz - 40 GHz	FCC 15.209 / 15 E	45.5 dBµV/m @ 5433.3 MHz (-8.5 dB)
4 U-NII 2A 5250-5350	Proprietary 40 MHz BW	Low 5260 MHz	-	-	Radiated Emissions, 30 MHz - 40 GHz	FCC 15.209 / 15 E	38.0 dBµV/m @ 37.82 MHz (-2.0 dB)
		Center 5280 MHz	-	-	Radiated Emissions, 1 GHz - 40 GHz	FCC 15.209 / 15 E	45.4 dBµV/m @ 5433.1 MHz (-8.6 dB)
		High 5293 MHz	-	-	Radiated Emissions, 1 GHz - 40 GHz	FCC 15.209 / 15 E	45.4 dBµV/m @ 5431.9 MHz (-8.6 dB)
		High 5293 MHz	-	-	Restricted Band Edge at 5350 MHz	15.209	53.3 dBµV/m @ 5351.4 MHz (-0.7 dB)

Modifications Made During Testing

No modifications were made to the EUT during testing

Deviations From The Standard

No deviations were made from the requirements of the standard.

Test Procedure Comments:

U-NII Bands

Unless otherwise noted, average measurements above 1GHz were performed as documented in FCC KDB 789033 D01 v01r03 H) 1) c) and H) 2) c) for U-NII band measurements.

Antenna: Connected. Integral antenna

Duty Cycle: 100%

The EUT was located on the turntable for radiated spurious emissions testing. DELL Latitude D830 Laptop and Nextivity Chart Interface (V:2.0.0.2) software was used to configure the EUT. The laptop was not connected during the tests.



EMC Test Data

Client: Nextivity Inc	Job Number: J94664
Model: D32-2/4NU and D32-2/4CU	T-Log Number: T94720
	Account Manager: Christine Krebill
Contact: Michiel Lotter	
Standard: FCC Part 15.247, Part 15.407 and RSS 210	Class: N/A

Run #1, Radiated Spurious Emissions, 30 - 40,000 MHz. Operation in the 5150-5250 MHz Band

Run #1a: Low Channel @ 5207 MHz 30 MHz Bandwidth

Date of Test: 3/12/2014, 3/17/14

Test Engineer: Rafael Varelas, Deniz Demirci

Test Location: FT Chamber #7

5150 MHz Restricted Band Edge Radiated Field Strength

Frequency MHz	Level dB μ V/m	Pol v/h	FCC 15.209		Detector Pk/QP/Avg	Azimuth degrees	Height meters	Comments
			Limit	Margin				
5150.000	46.2	V	54.0	-7.8	AVG	61	1.0	POS; RB 1 MHz; VB: 10 Hz
5148.560	58.7	V	74.0	-15.3	PK	61	1.0	POS; RB 1 MHz; VB: 3 MHz
5150.000	44.7	H	54.0	-9.3	AVG	300	1.0	POS; RB 1 MHz; VB: 10 Hz
5143.510	58.1	H	74.0	-15.9	PK	300	1.0	POS; RB 1 MHz; VB: 3 MHz

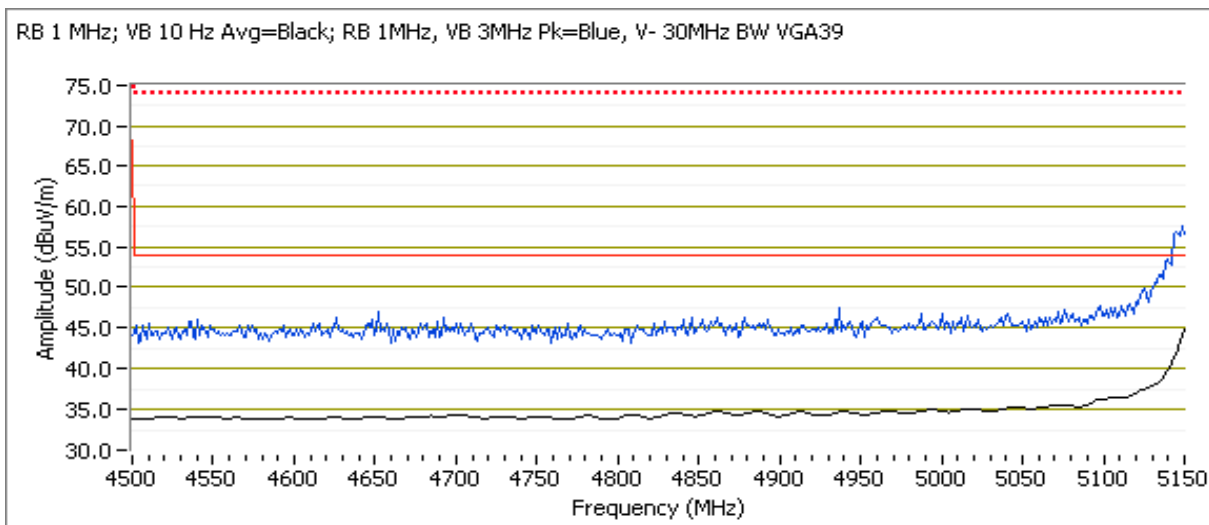

Client: Nextivity Inc	Job Number: J94664
Model: D32-2/4NU and D32-2/4CU	T-Log Number: T94720
	Account Manager: Christine Krebill
Contact: Michiel Lotter	
Standard: FCC Part 15.247, Part 15.407 and RSS 210	Class: N/A

Low Channel @ 5207 MHz 30 MHz Bandwidth

Spurious Radiated Emissions:

Frequency MHz	Level dB μ V/m	Pol v/h	FCC 15.209		Detector Pk/QP/Avg	Azimuth degrees	Height meters	Comments
			Limit	Margin				
37.701	36.3	V	40.0	-3.7	QP	7	1.0	QP (1.00s)
64.052	30.2	V	40.0	-9.8	QP	172	1.1	QP (1.00s)
57.811	27.5	V	40.0	-12.5	QP	218	1.0	QP (1.00s)
127.791	25.8	H	43.5	-17.7	QP	268	2.0	QP (1.00s)
110.488	24.7	V	43.5	-18.8	QP	353	1.0	QP (1.00s)
5430.900	45.2	H	54.0	-8.8	AVG	116	1.0	RB 1 MHz;VB 10 Hz;Peak
5434.280	56.2	H	74.0	-17.8	PK	116	1.0	RB 1 MHz;VB 3 MHz;Peak
5055.170	43.3	H	54.0	-10.7	AVG	102	1.0	RB 1 MHz;VB 10 Hz;Peak
5046.120	55.0	H	74.0	-19.0	PK	102	1.0	RB 1 MHz;VB 3 MHz;Peak
20831.950	21.7	H	54.0	-32.3	AVG	120	1.0	Noise floor reading

- Note 1: For emissions in restricted bands, the limit of 15.209 was used which requires average and peak measurements.
- Note 2: For emissions outside of the restricted bands the limit is -27 dBm/MHz eirp (68.3 dB μ V/m). The measurement method required is a peak measurement (RB=1 MHz, VB \geq 3 MHz, peak detector). Plot shows all three limits below 12 GHz. Above 12 GHz noise floor is lower due to testing at closer distance.
- Note 3: Emissions in the 30-1000 MHz range are not radio related, they are the same regardless of channel.
- Note 4: Scans made between 18 - 40 GHz with the measurement antenna moved around the card and its antennas 20-50 cm from the device indicated there were no significant emissions in this frequency range

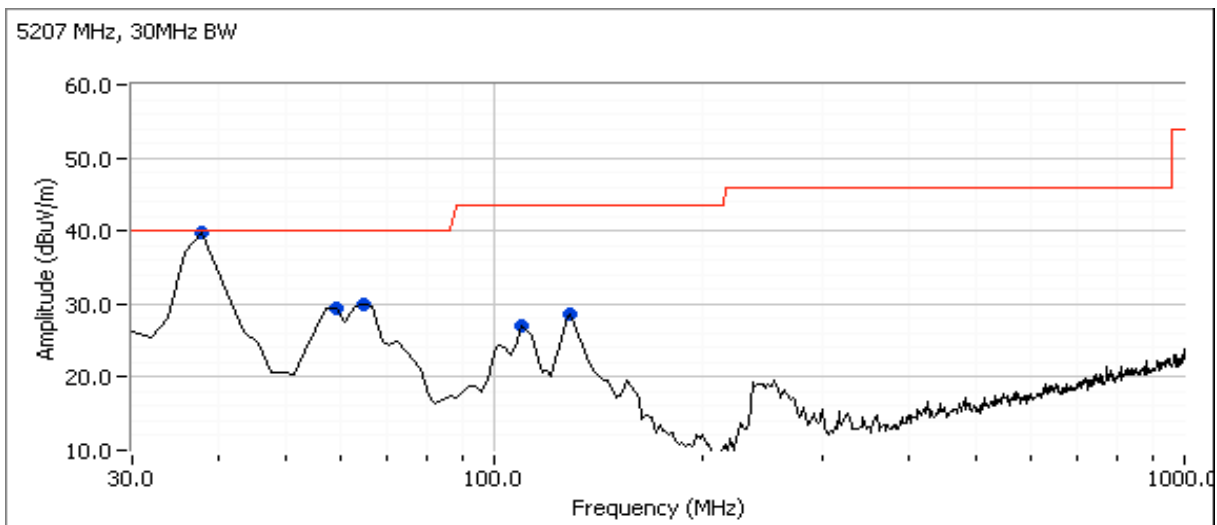

Client: Nextivity Inc	Job Number: J94664
Model: D32-2/4NU and D32-2/4CU	T-Log Number: T94720
	Account Manager: Christine Krebill
Contact: Michiel Lotter	
Standard: FCC Part 15.247, Part 15.407 and RSS 210	Class: N/A

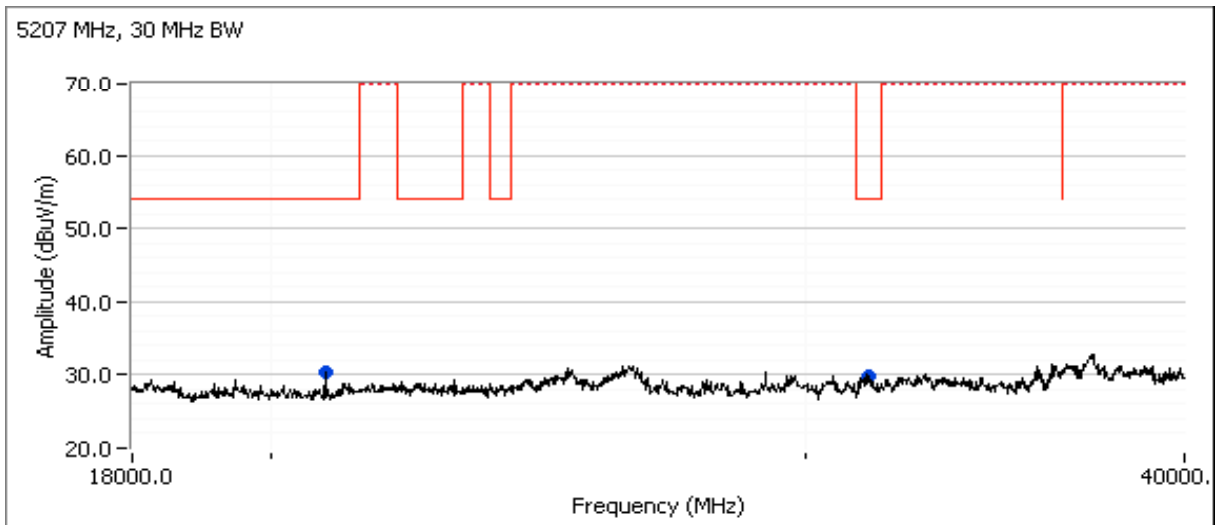
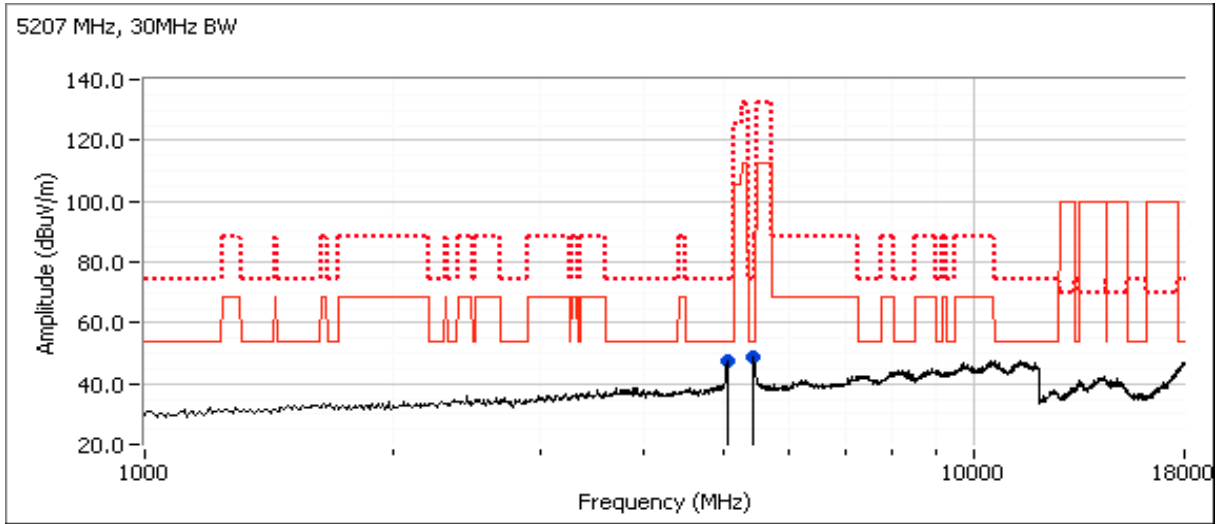

Client: Nextivity Inc	Job Number: J94664
Model: D32-2/4NU and D32-2/4CU	T-Log Number: T94720
	Account Manager: Christine Krebill
Contact: Michiel Lotter	
Standard: FCC Part 15.247, Part 15.407 and RSS 210	Class: N/A

Run #1b, Radiated Spurious Emissions, 30 - 40,000 MHz. Operation in the 5150-5250 MHz Band

Date of Test: 3/12/2014

Test Engineer: Rafael Varelas

Test Location: FT Chamber #7

Center Channel @ 5220 MHz 30 MHz Bandwidth

Spurious Radiated Emissions:

Frequency	Level	Pol	FCC 15.209		Detector	Azimuth	Height	Comments
MHz	dB μ V/m	v/h	Limit	Margin	Pk/QP/Avg	degrees	meters	
5434.370	45.0	H	54.0	-9.0	AVG	116	1.0	RB 1 MHz;VB 10 Hz;Peak
5434.820	56.6	H	74.0	-17.4	PK	116	1.0	RB 1 MHz;VB 3 MHz;Peak
5052.710	43.7	H	54.0	-10.3	AVG	48	1.1	RB 1 MHz;VB 10 Hz;Peak
5050.350	55.0	H	74.0	-19.0	PK	48	1.1	RB 1 MHz;VB 3 MHz;Peak

Note 1: For emissions in restricted bands, the limit of 15.209 was used which requires average and peak measurements.

Note 2: For emissions outside of the restricted bands the limit is -27 dBm/MHz eirp (68.3 dB μ V/m). The measurement method required is a peak measurement (RB=1 MHz, VB \geq 3 MHz, peak detector). Plot shows all three limits below 12 GHz. Above 12 GHz noise floor is lower due to testing at closer distance.

Note 3: Emissions in the 30-1000 MHz range are not radio related, they are the same regardless of channel.

Note 4: Scans made between 18 - 40 GHz with the measurement antenna moved around the card and its antennas 20-50 cm from the device indicated there were no significant emissions in this frequency range

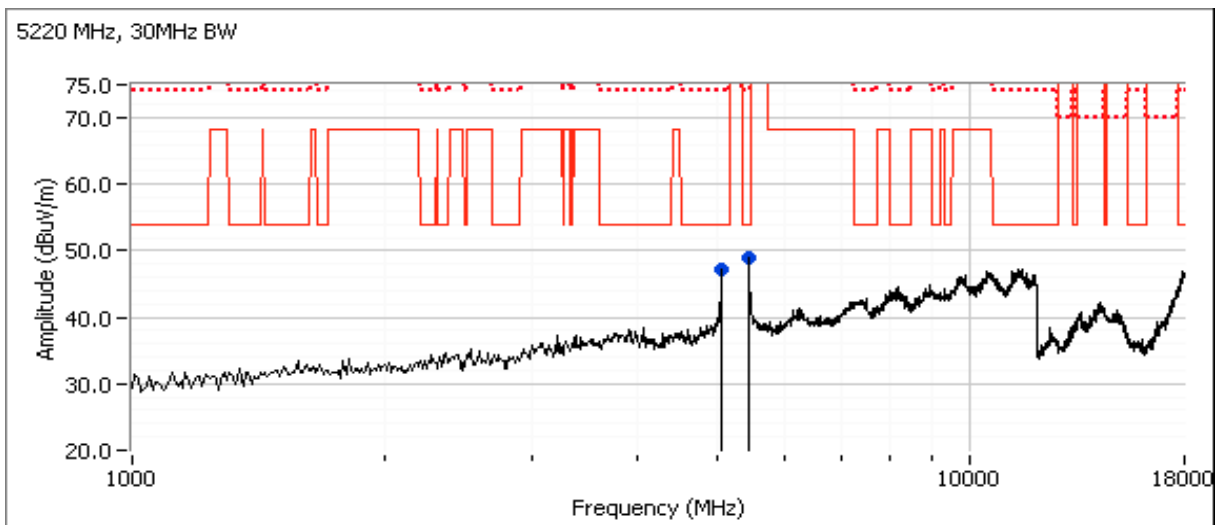

Client: Nextivity Inc	Job Number: J94664
Model: D32-2/4NU and D32-2/4CU	T-Log Number: T94720
	Account Manager: Christine Krebill
Contact: Michiel Lotter	
Standard: FCC Part 15.247, Part 15.407 and RSS 210	Class: N/A

Run #1c, Radiated Spurious Emissions, 30 - 40,000 MHz. Operation in the 5150-5250 MHz Band

Date of Test: 3/12/2014

Test Engineer: Rafael Varelas

Test Location: FT Chamber #7

High Channel @ 5240 MHz 30 MHz Bandwidth

Spurious Radiated Emissions:

Frequency	Level	Pol	FCC 15.209		Detector	Azimuth	Height	Comments
MHz	dB μ V/m	v/h	Limit	Margin	Pk/QP/Avg	degrees	meters	
5435.890	44.9	H	54.0	-9.1	AVG	277	1.7	RB 1 MHz;VB 10 Hz;Peak
5436.390	56.6	H	74.0	-17.4	PK	277	1.7	RB 1 MHz;VB 3 MHz;Peak
5052.400	43.6	H	54.0	-10.4	AVG	268	1.0	RB 1 MHz;VB 10 Hz;Peak
5050.520	55.0	H	74.0	-19.0	PK	268	1.0	RB 1 MHz;VB 3 MHz;Peak

Note 1: For emissions in restricted bands, the limit of 15.209 was used which requires average and peak measurements.

Note 2: For emissions outside of the restricted bands the limit is -27 dBm/MHz eirp (68.3 dB μ V/m). The measurement method required is a peak measurement (RB=1 MHz, VB \geq 3 MHz, peak detector). Plot shows all three limits below 12 GHz. Above 12 GHz noise floor is lower due to testing at closer distance.

Note 3: Emissions in the 30-1000 MHz range are not radio related, they are the same regardless of channel.

Note 4: Scans made between 18 - 40 GHz with the measurement antenna moved around the card and its antennas 20-50 cm from the device indicated there were no significant emissions in this frequency range

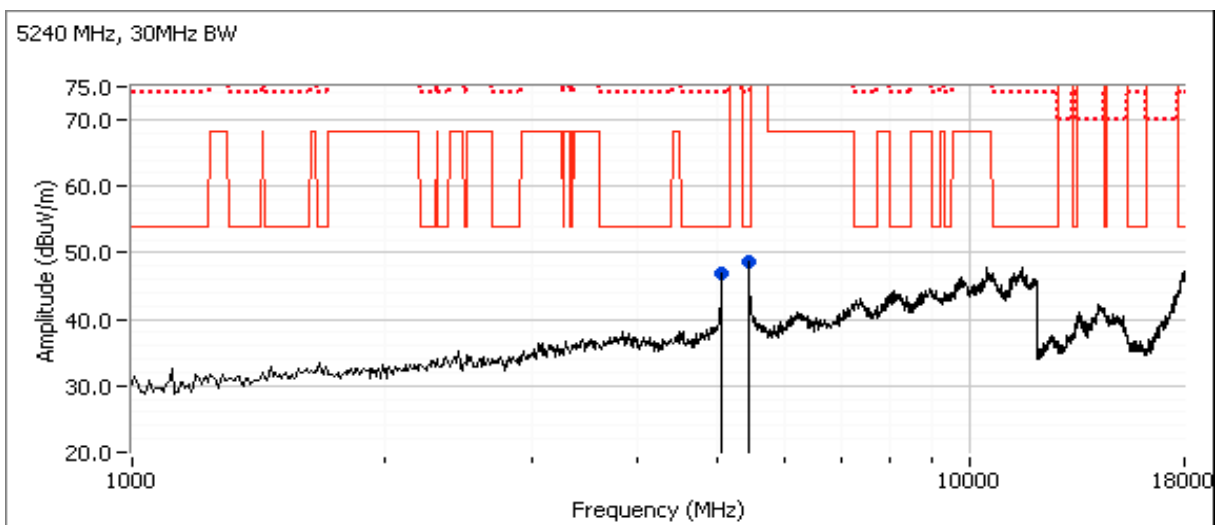

Client: Nextivity Inc	Job Number: J94664
Model: D32-2/4NU and D32-2/4CU	T-Log Number: T94720
	Account Manager: Christine Krebill
Contact: Michiel Lotter	
Standard: FCC Part 15.247, Part 15.407 and RSS 210	Class: N/A

Run #2, Radiated Spurious Emissions, 30 - 40,000 MHz. Operation in the 5250-5350 MHz Band
 Run #2a, Radiated Spurious Emissions, 30 - 40,000 MHz. Operation in the 5250-5350 MHz Band
 Date of Test: 3/12/2014, 3/17/14
 Test Engineer: Rafael Varelas, Deniz Demirci
 Test Location: FT Chamber #7
 Low Channel @ 5260 MHz 30 MHz Bandwidth

Spurious Radiated Emissions:

Frequency	Level	Pol	FCC 15.209		Detector	Azimuth	Height	Comments
MHz	dB μ V/m	v/h	Limit	Margin	Pk/QP/Avg	degrees	meters	
37.864	38.0	V	40.0	-2.0	QP	353	1.0	QP (1.00s)
110.731	25.7	V	43.5	-17.8	QP	360	1.0	QP (1.00s)
132.003	26.0	H	43.5	-17.5	QP	268	2.0	QP (1.00s)
58.003	28.0	V	40.0	-12.0	QP	228	1.0	QP (1.00s)
5433.640	45.3	V	54.0	-8.7	AVG	219	1.0	RB 1 MHz;VB 10 Hz;Peak
5432.810	56.9	V	74.0	-17.1	PK	219	1.0	RB 1 MHz;VB 3 MHz;Peak
5052.460	43.6	V	54.0	-10.4	AVG	58	2.0	RB 1 MHz;VB 10 Hz;Peak
5052.430	54.9	V	74.0	-19.1	PK	58	2.0	RB 1 MHz;VB 3 MHz;Peak

- Note 1: For emissions in restricted bands, the limit of 15.209 was used which requires average and peak measurements.
- Note 2: For emissions outside of the restricted bands the limit is -27 dBm/MHz eirp (68.3 dB μ V/m). The measurement method required is a peak measurement (RB=1 MHz, VB \geq 3 MHz, peak detector). Plot shows all three limits below 12 GHz. Above 12 GHz noise floor is lower due to testing at closer distance.
- Note 3: Emissions in the 30-1000 MHz range are not radio related, they are the same regardless of channel.
- Note 4: Scans made between 18 - 40 GHz with the measurement antenna moved around the card and its antennas 20-50 cm from the device indicated there were no significant emissions in this frequency range

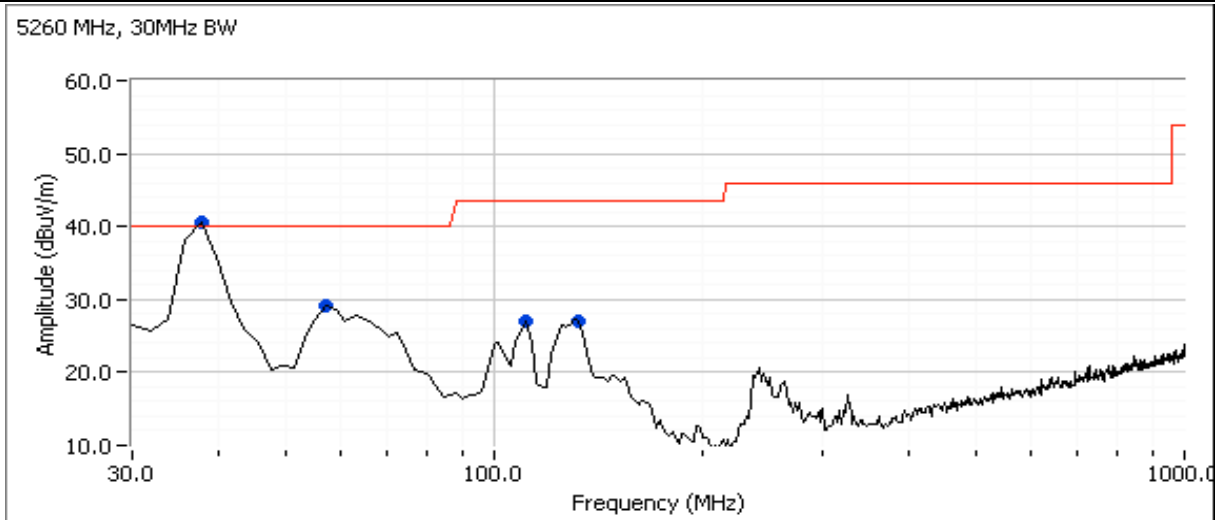

Client: Nextivity Inc	Job Number: J94664
Model: D32-2/4NU and D32-2/4CU	T-Log Number: T94720
	Account Manager: Christine Krebill
Contact: Michiel Lotter	
Standard: FCC Part 15.247, Part 15.407 and RSS 210	Class: N/A

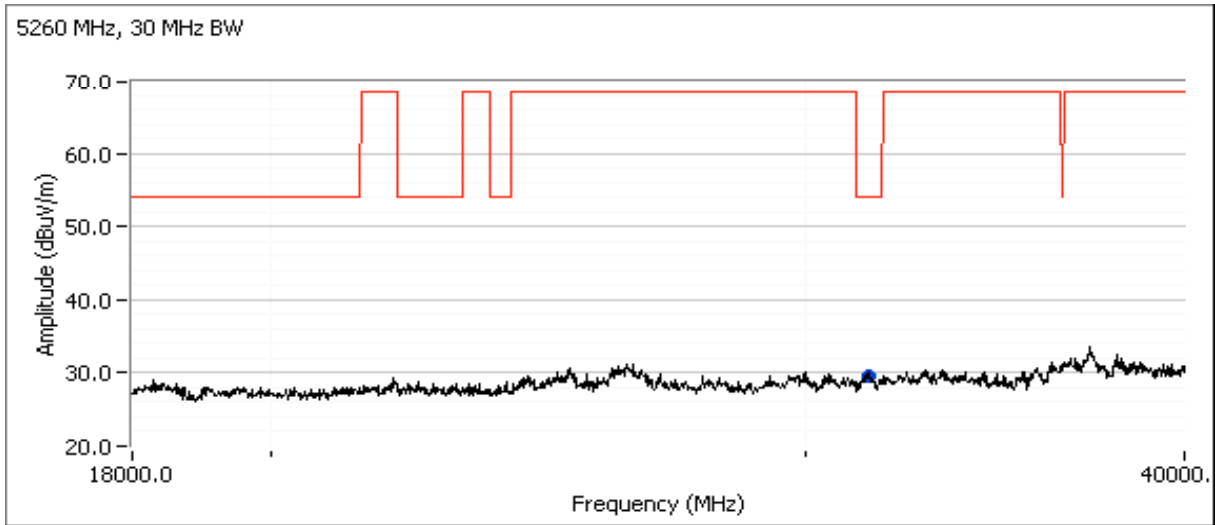
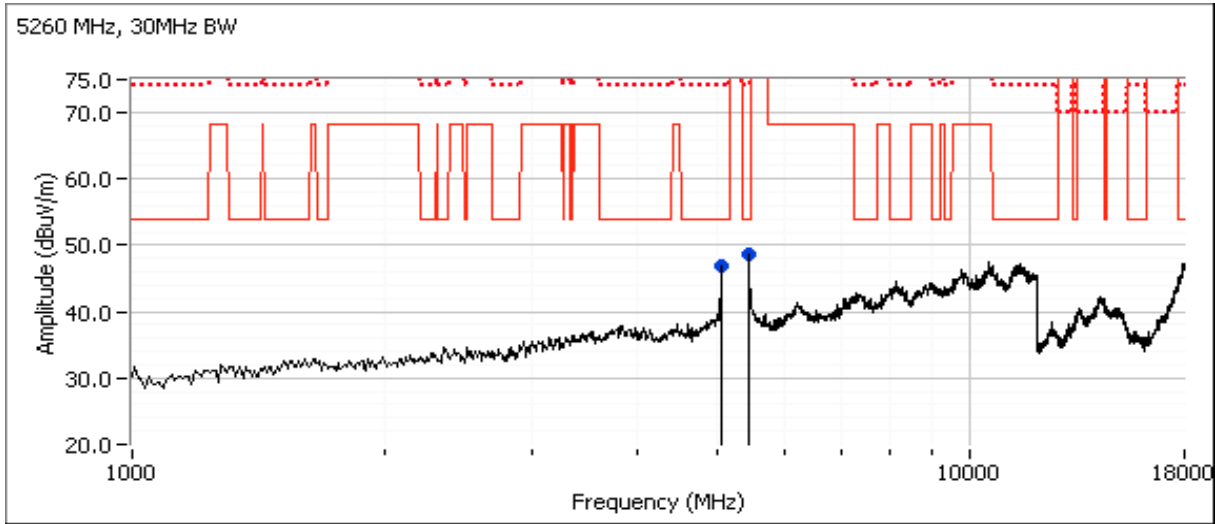

Client: Nextivity Inc	Job Number: J94664
Model: D32-2/4NU and D32-2/4CU	T-Log Number: T94720
	Account Manager: Christine Krebill
Contact: Michiel Lotter	
Standard: FCC Part 15.247, Part 15.407 and RSS 210	Class: N/A

Run #2b, Radiated Spurious Emissions, 30 - 40,000 MHz. Operation in the 5250-5350 MHz Band

Date of Test: 3/12/2014

Test Engineer: Rafael Varelas

Test Location: FT Chamber #7

Center Channel @ 5280 MHz 30 MHz Bandwidth

Spurious Radiated Emissions:

Frequency	Level	Pol	FCC 15.209		Detector	Azimuth	Height	Comments
MHz	dB μ V/m	v/h	Limit	Margin	Pk/QP/Avg	degrees	meters	
5431.990	45.4	H	54.0	-8.6	AVG	37	1.0	RB 1 MHz;VB 10 Hz;Peak
5433.130	56.5	H	74.0	-17.5	PK	37	1.0	RB 1 MHz;VB 3 MHz;Peak
5050.380	43.7	H	54.0	-10.3	AVG	192	1.7	RB 1 MHz;VB 10 Hz;Peak
5050.580	54.7	H	74.0	-19.3	PK	192	1.7	RB 1 MHz;VB 3 MHz;Peak

Note 1: For emissions in restricted bands, the limit of 15.209 was used which requires average and peak measurements.

Note 2: For emissions outside of the restricted bands the limit is -27 dBm/MHz eirp (68.3dBuV/m). The measurement method required is a peak measurement (RB=1 MHz, VB \geq 3 MHz, peak detector). Plot shows all three limits below 12 GHz. Above 12 GHz noise floor is lower due to testing at closer distance.

Note 3: Emissions in the 30-1000 MHz range are not radio related, they are the same regardless of channel.

Note 4: Scans made between 18 - 40 GHz with the measurement antenna moved around the card and its antennas 20-50 cm from the device indicated there were no significant emissions in this frequency range

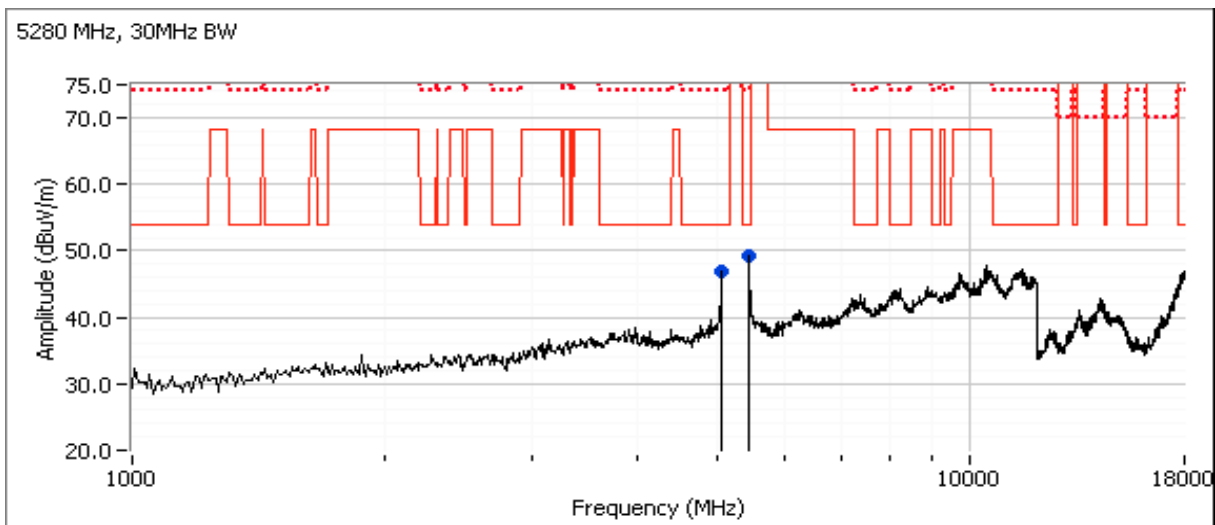

Client: Nextivity Inc	Job Number: J94664
Model: D32-2/4NU and D32-2/4CU	T-Log Number: T94720
	Account Manager: Christine Krebill
Contact: Michiel Lotter	
Standard: FCC Part 15.247, Part 15.407 and RSS 210	Class: N/A

Run #2c, Radiated Spurious Emissions, 30 - 40,000 MHz. Operation in the 5250-5350 MHz Band

Date of Test: 3/12/2014

Test Engineer: Rafael Varelas

Test Location: FT Chamber #7

High Channel @ 5293 MHz 30 MHz Bandwidth

5350 MHz Restricted Band Edge Radiated Field Strength

Frequency	Level	Pol	FCC 15.209		Detector	Azimuth	Height	Comments
MHz	dB μ V/m	v/h	Limit	Margin	Pk/QP/Avg	degrees	meters	
5350.000	52.0	V	54.0	-2.0	AVG	264	1.9	POS; RB 1 MHz; VB: 10 Hz
5351.520	70.8	V	74.0	-3.2	PK	264	1.9	POS; RB 1 MHz; VB: 3 MHz
5350.080	49.6	H	54.0	-4.4	AVG	303	1.1	POS; RB 1 MHz; VB: 10 Hz
5351.840	68.4	H	74.0	-5.6	PK	303	1.1	POS; RB 1 MHz; VB: 3 MHz

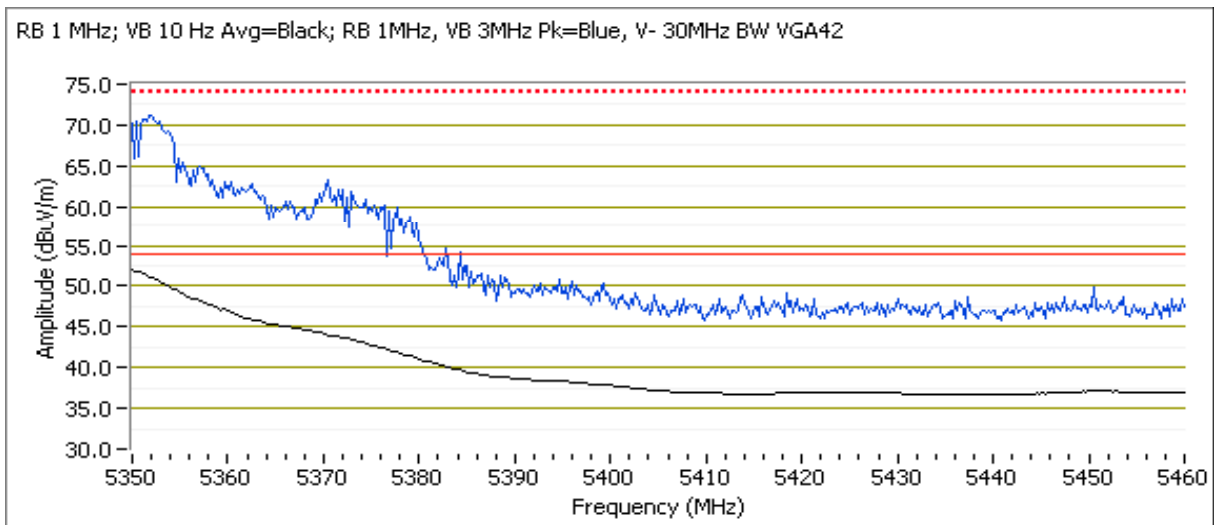

Client: Nextivity Inc	Job Number: J94664
Model: D32-2/4NU and D32-2/4CU	T-Log Number: T94720
	Account Manager: Christine Krebill
Contact: Michiel Lotter	
Standard: FCC Part 15.247, Part 15.407 and RSS 210	Class: N/A

High Channel @ 5293 MHz 30 MHz Bandwidth

Spurious Radiated Emissions:

Frequency MHz	Level dB μ V/m	Pol v/h	FCC 15.209		Detector Pk/QP/Avg	Azimuth degrees	Height meters	Comments
			Limit	Margin				
5432.020	45.4	H	54.0	-8.6	AVG	100	1.0	RB 1 MHz;VB 10 Hz;Peak
5431.750	57.5	H	74.0	-16.5	PK	100	1.0	RB 1 MHz;VB 3 MHz;Peak
5051.560	43.2	V	54.0	-10.8	AVG	28	1.0	RB 1 MHz;VB 10 Hz;Peak
5049.220	54.3	V	74.0	-19.7	PK	28	1.0	RB 1 MHz;VB 3 MHz;Peak

- Note 1: For emissions in restricted bands, the limit of 15.209 was used which requires average and peak measurements.
- Note 2: For emissions outside of the restricted bands the limit is -27 dBm/MHz eirp (68.3 dBuV/m). The measurement method required is a peak measurement (RB=1 MHz, VB \geq 3 MHz, peak detector). Plot shows all three limits below 12 GHz. Above 12 GHz noise floor is lower due to testing at closer distance.
- Note 3: Emissions in the 30-1000 MHz range are not radio related, they are the same regardless of channel.
- Note 4: Scans made between 18 - 40 GHz with the measurement antenna moved around the card and its antennas 20-50 cm from the device indicated there were no significant emissions in this frequency range

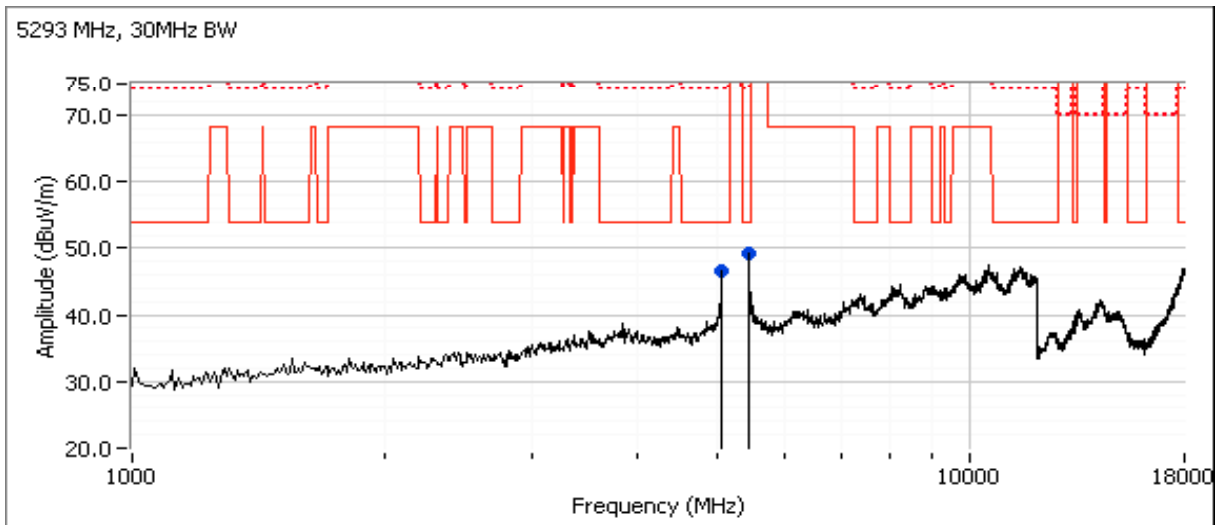

Client: Nextivity Inc	Job Number: J94664
Model: D32-2/4NU and D32-2/4CU	T-Log Number: T94720
	Account Manager: Christine Krebill
Contact: Michiel Lotter	
Standard: FCC Part 15.247, Part 15.407 and RSS 210	Class: N/A

Run #3, Radiated Spurious Emissions, 30 - 40,000 MHz. Operation in the 5150-5250 MHz Band

Run #3a: Low Channel @ 5207 MHz 40 MHz Bandwidth

Date of Test: 3/12/2014, 3/17/14

Test Engineer: Rafael Varelas, Deniz Demirci

Test Location: FT Chamber #7

5150 MHz Restricted Band Edge Radiated Field Strength

Frequency MHz	Level dB μ V/m	Pol v/h	FCC 15.209		Detector Pk/QP/Avg	Azimuth degrees	Height meters	Comments
			Limit	Margin				
5150.000	51.3	V	54.0	-2.7	AVG	62	1.0	POS; RB 1 MHz; VB: 10 Hz
5147.920	64.5	V	74.0	-9.5	PK	62	1.0	POS; RB 1 MHz; VB: 3 MHz
5150.000	49.8	H	54.0	-4.2	AVG	309	1.0	POS; RB 1 MHz; VB: 10 Hz
5148.320	62.9	H	74.0	-11.1	PK	309	1.0	POS; RB 1 MHz; VB: 3 MHz

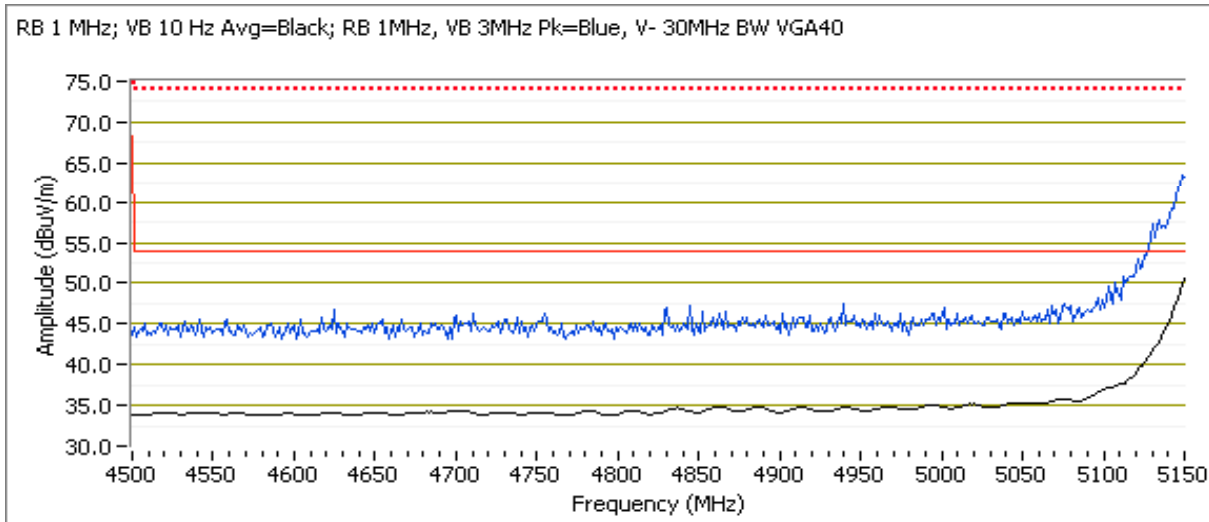

Client: Nextivity Inc	Job Number: J94664
Model: D32-2/4NU and D32-2/4CU	T-Log Number: T94720
	Account Manager: Christine Krebill
Contact: Michiel Lotter	
Standard: FCC Part 15.247, Part 15.407 and RSS 210	Class: N/A

Low Channel @ 5207 MHz 40 MHz Bandwidth

Spurious Radiated Emissions:

Frequency MHz	Level dB μ V/m	Pol v/h	FCC 15.209		Detector Pk/QP/Avg	Azimuth degrees	Height meters	Comments
			Limit	Margin				
37.636	36.3	V	40.0	-3.7	QP	338	1.0	QP (1.00s)
128.141	26.3	H	43.5	-17.2	QP	278	2.0	QP (1.00s)
63.945	29.8	V	40.0	-10.2	QP	208	1.2	QP (1.00s)
111.835	24.4	V	43.5	-19.1	QP	22	1.0	QP (1.00s)
5052.130	43.7	H	54.0	-10.3	AVG	76	1.0	RB 1 MHz;VB 10 Hz;Peak
5050.430	55.1	H	74.0	-18.9	PK	76	1.0	RB 1 MHz;VB 3 MHz;Peak
5435.520	44.8	H	54.0	-9.2	AVG	213	1.1	RB 1 MHz;VB 10 Hz;Peak
5434.310	56.2	H	74.0	-17.8	PK	213	1.1	RB 1 MHz;VB 3 MHz;Peak
31473.830	24.1	H	54.0	-29.9	AVG	152	1.1	Noise floor reading

Note 1: For emissions in restricted bands, the limit of 15.209 was used which requires average and peak measurements.

Note 2: For emissions outside of the restricted bands the limit is -27 dBm/MHz eirp (68.3 dB μ V/m). The measurement method required is a peak measurement (RB=1 MHz, VB \geq 3 MHz, peak detector). Plot shows all three limits below 12 GHz. Above 12 GHz noise floor is lower due to testing at closer distance.

Note 3: Emissions in the 30-1000 MHz range are not radio related, they are the same regardless of channel.

Note 4: Scans made between 18 - 40 GHz with the measurement antenna moved around the card and its antennas 20-50 cm from the device indicated there were no significant emissions in this frequency range

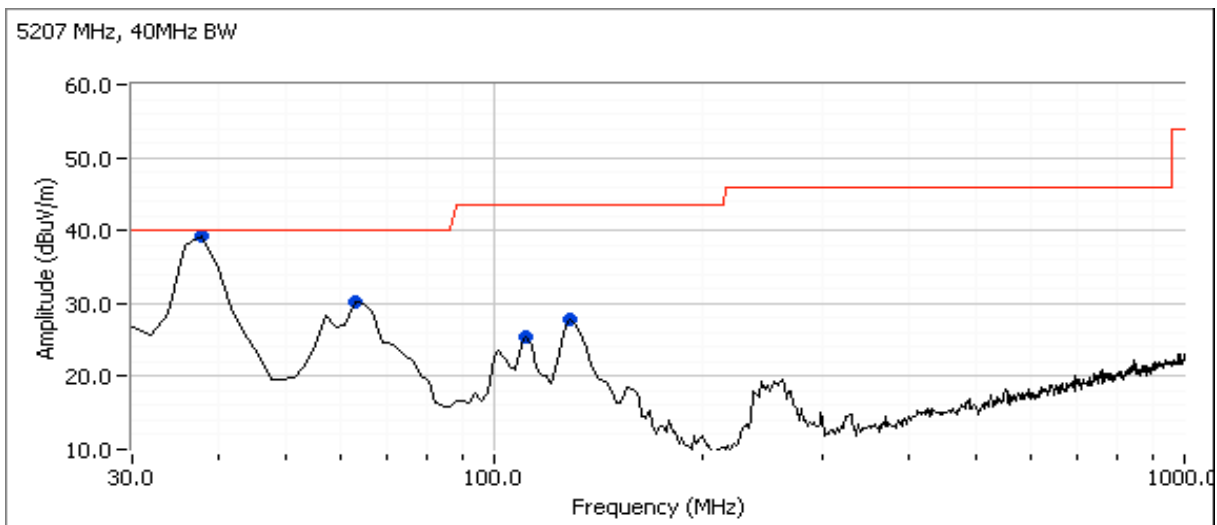

Client: Nextivity Inc	Job Number: J94664
Model: D32-2/4NU and D32-2/4CU	T-Log Number: T94720
	Account Manager: Christine Krebill
Contact: Michiel Lotter	
Standard: FCC Part 15.247, Part 15.407 and RSS 210	Class: N/A

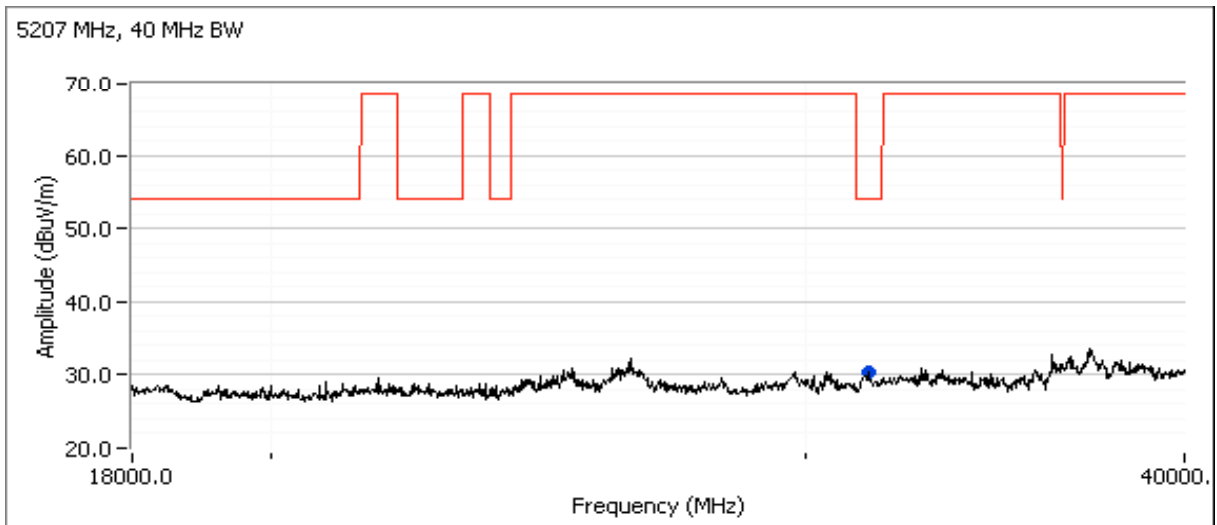
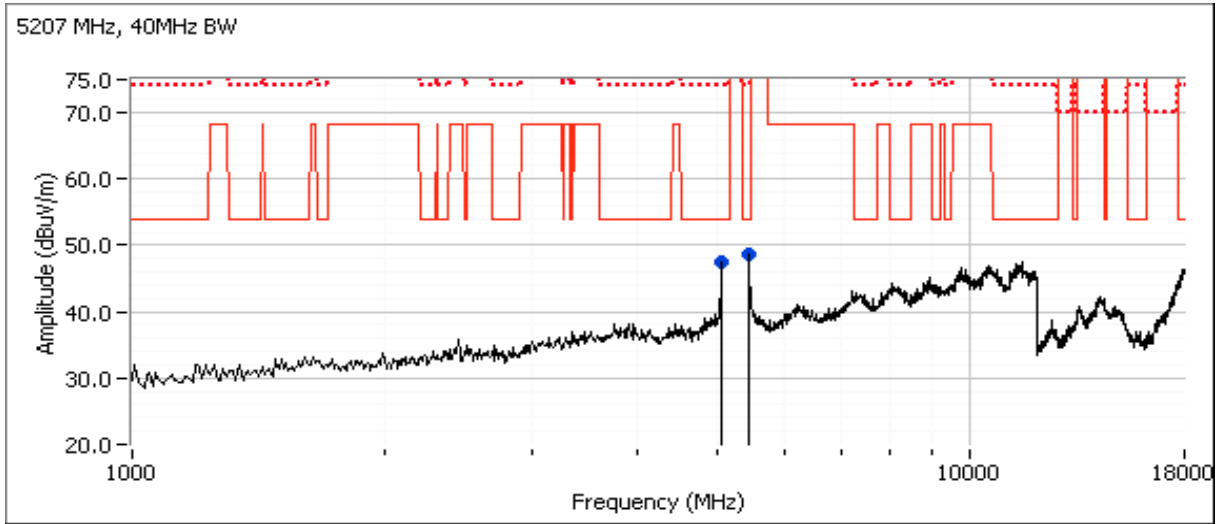

Client: Nextivity Inc	Job Number: J94664
Model: D32-2/4NU and D32-2/4CU	T-Log Number: T94720
	Account Manager: Christine Krebill
Contact: Michiel Lotter	
Standard: FCC Part 15.247, Part 15.407 and RSS 210	Class: N/A

Run #3b, Radiated Spurious Emissions, 30 - 40,000 MHz. Operation in the 5150-5250 MHz Band

Date of Test: 3/13/2014

Test Engineer: Jack Liu / R. Varelas

Test Location: FT Chamber #7

Center Channel @ 5220 MHz 40 MHz Bandwidth

Spurious Radiated Emissions:

Frequency	Level	Pol	FCC 15.209		Detector	Azimuth	Height	Comments
MHz	dB μ V/m	v/h	Limit	Margin	Pk/QP/Avg	degrees	meters	
5432.730	45.3	H	54.0	-8.7	AVG	297	1.0	RB 1 MHz;VB 10 Hz;Peak
5433.920	56.3	H	74.0	-17.7	PK	297	1.0	RB 1 MHz;VB 3 MHz;Peak
5042.040	41.4	V	54.0	-12.6	AVG	165	2.0	RB 1 MHz;VB 10 Hz;Peak
5042.780	52.4	V	74.0	-21.6	PK	165	2.0	RB 1 MHz;VB 3 MHz;Peak

Note 1: For emissions in restricted bands, the limit of 15.209 was used which requires average and peak measurements.

Note 2: For emissions outside of the restricted bands the limit is -27 dBm/MHz eirp (68.3 dB μ V/m). The measurement method required is a peak measurement (RB=1 MHz, VB \geq 3 MHz, peak detector). Plot shows all three limits below 12 GHz. Above 12 GHz noise floor is lower due to testing at closer distance.

Note 3: Emissions in the 30-1000 MHz range are not radio related, they are the same regardless of channel.

Note 4: Scans made between 18 - 40 GHz with the measurement antenna moved around the card and its antennas 20-50 cm from the device indicated there were no significant emissions in this frequency range

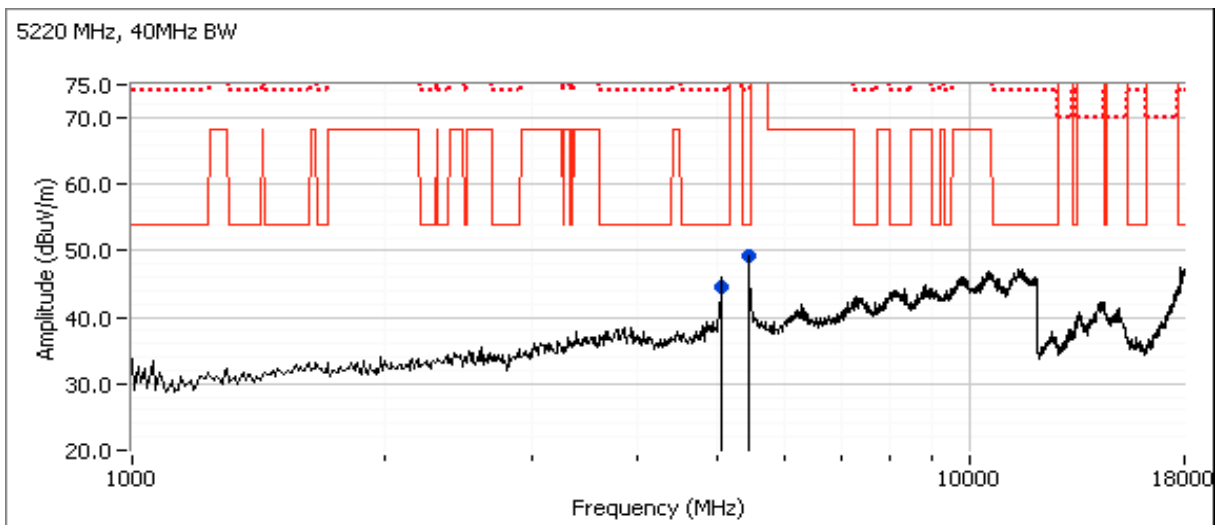

Client: Nextivity Inc	Job Number: J94664
Model: D32-2/4NU and D32-2/4CU	T-Log Number: T94720
	Account Manager: Christine Krebill
Contact: Michiel Lotter	
Standard: FCC Part 15.247, Part 15.407 and RSS 210	Class: N/A

Run #3d, Radiated Spurious Emissions, 30 - 40,000 MHz. Operation in the 5150-5250 MHz Band

Date of Test: 3/13/2014

Test Engineer: Jack Liu / R. Varelas

Test Location: FT Chamber #7

High Channel @ 5240 MHz 40 MHz Bandwidth

Spurious Radiated Emissions:

Frequency MHz	Level dB μ V/m	Pol v/h	FCC 15.209		Detector Pk/QP/Avg	Azimuth degrees	Height meters	Comments
			Limit	Margin				
5433.270	45.5	V	54.0	-8.5	AVG	200	1.0	RB 1 MHz;VB 10 Hz;Peak
5433.580	57.4	V	74.0	-16.6	PK	200	1.0	RB 1 MHz;VB 3 MHz;Peak
5041.840	41.3	V	54.0	-12.7	AVG	310	1.0	RB 1 MHz;VB 10 Hz;Peak
5042.520	52.4	V	74.0	-21.6	PK	310	1.0	RB 1 MHz;VB 3 MHz;Peak

Note 1: For emissions in restricted bands, the limit of 15.209 was used which requires average and peak measurements.

Note 2: For emissions outside of the restricted bands the limit is -27 dBm/MHz eirp (68.3 dB μ V/m). The measurement method required is a peak measurement (RB=1 MHz, VB \geq 3 MHz, peak detector). Plot shows all three limits below 12 GHz. Above 12 GHz noise floor is lower due to testing at closer distance.

Note 3: Emissions in the 30-1000 MHz range are not radio related, they are the same regardless of channel.

Note 4: Scans made between 18 - 40 GHz with the measurement antenna moved around the card and its antennas 20-50 cm from the device indicated there were no significant emissions in this frequency range

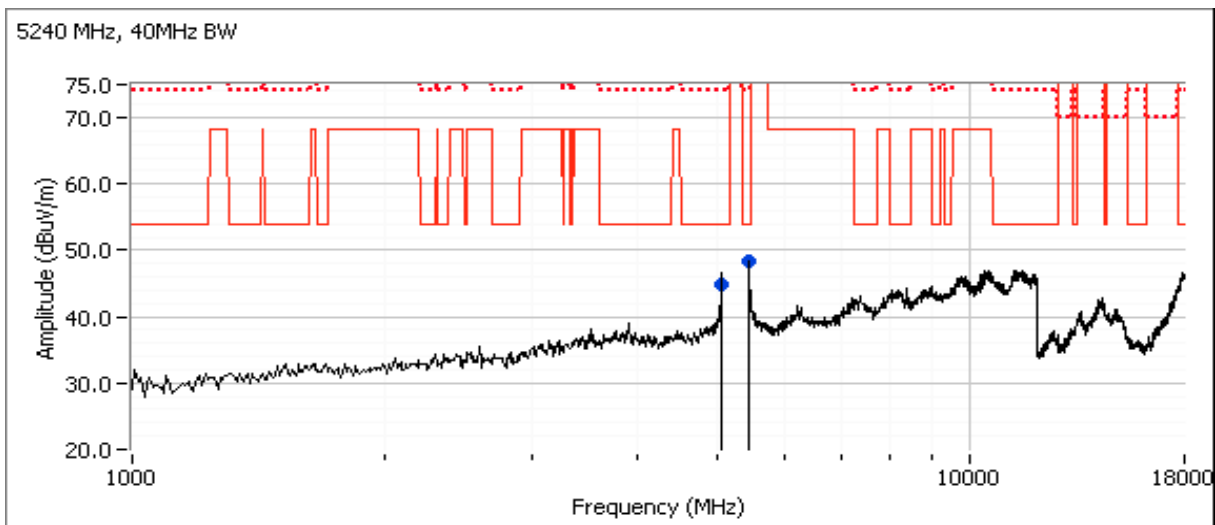

Client: Nextivity Inc	Job Number: J94664
Model: D32-2/4NU and D32-2/4CU	T-Log Number: T94720
	Account Manager: Christine Krebill
Contact: Michiel Lotter	
Standard: FCC Part 15.247, Part 15.407 and RSS 210	Class: N/A

Run #4, Radiated Spurious Emissions, 30 - 40,000 MHz. Operation in the 5250-5350 MHz Band
 Run #4a, Radiated Spurious Emissions, 30 - 40,000 MHz. Operation in the 5250-5350 MHz Band
 Date of Test: 3/13/2014, 3/17/14
 Test Engineer: Jack Liu / R. Varelas, Deniz Demirci
 Test Location: FT Chamber #7

Low Channel @ 5260 MHz 40 MHz Bandwidth

Spurious Radiated Emissions:

Frequency	Level	Pol	FCC 15.209		Detector	Azimuth	Height	Comments
MHz	dB μ V/m	v/h	Limit	Margin	Pk/QP/Avg	degrees	meters	
37.818	38.0	V	40.0	-2.0	QP	12	1.0	QP (1.00s)
110.683	24.6	V	43.5	-18.9	QP	17	1.0	QP (1.00s)
67.522	27.8	V	40.0	-12.2	QP	188	1.0	QP (1.00s)
132.040	26.6	H	43.5	-16.9	QP	268	1.9	QP (1.00s)
5432.330	45.4	V	54.0	-8.6	AVG	272	2.0	RB 1 MHz;VB 10 Hz;Peak
5432.520	57.0	V	74.0	-17.0	PK	272	2.0	RB 1 MHz;VB 3 MHz;Peak
5051.310	43.2	H	54.0	-10.8	AVG	236	2.0	RB 1 MHz;VB 10 Hz;Peak
5048.830	54.6	H	74.0	-19.4	PK	236	2.0	RB 1 MHz;VB 3 MHz;Peak

- Note 1: For emissions in restricted bands, the limit of 15.209 was used which requires average and peak measurements.
- Note 2: For emissions outside of the restricted bands the limit is -27 dBm/MHz eirp (68.3 dBuV/m). The measurement method required is a peak measurement (RB=1 MHz, VB \geq 3 MHz, peak detector). Plot shows all three limits below 12 GHz. Above 12 GHz noise floor is lower due to testing at closer distance.
- Note 3: Emissions in the 30-1000 MHz range are not radio related, they are the same regardless of channel.
- Note 4: Scans made between 18 - 40 GHz with the measurement antenna moved around the card and its antennas 20-50 cm from the device indicated there were no significant emissions in this frequency range

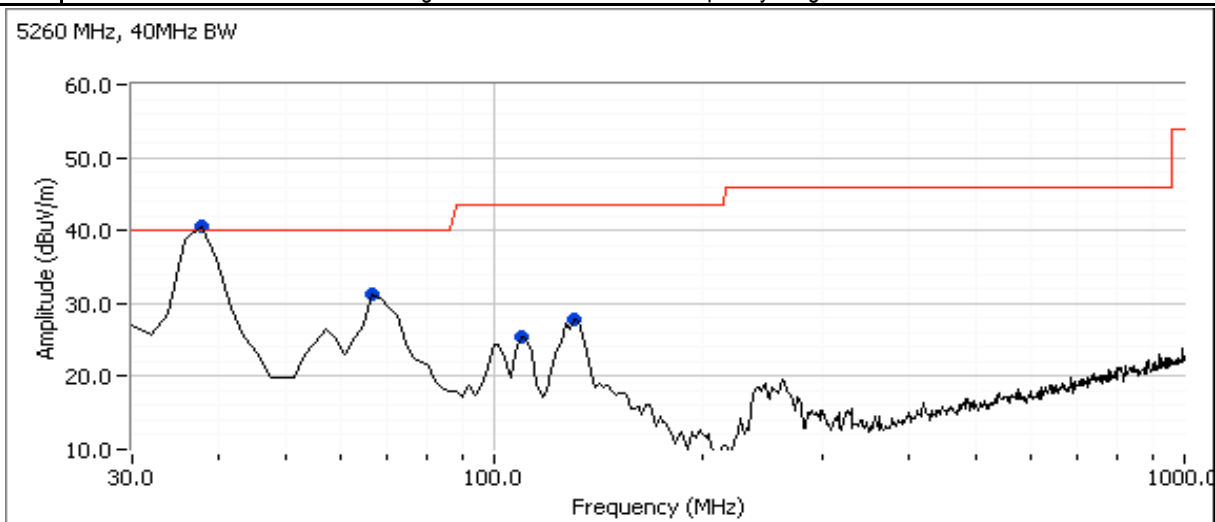

Client: Nextivity Inc	Job Number: J94664
Model: D32-2/4NU and D32-2/4CU	T-Log Number: T94720
	Account Manager: Christine Krebill
Contact: Michiel Lotter	
Standard: FCC Part 15.247, Part 15.407 and RSS 210	Class: N/A

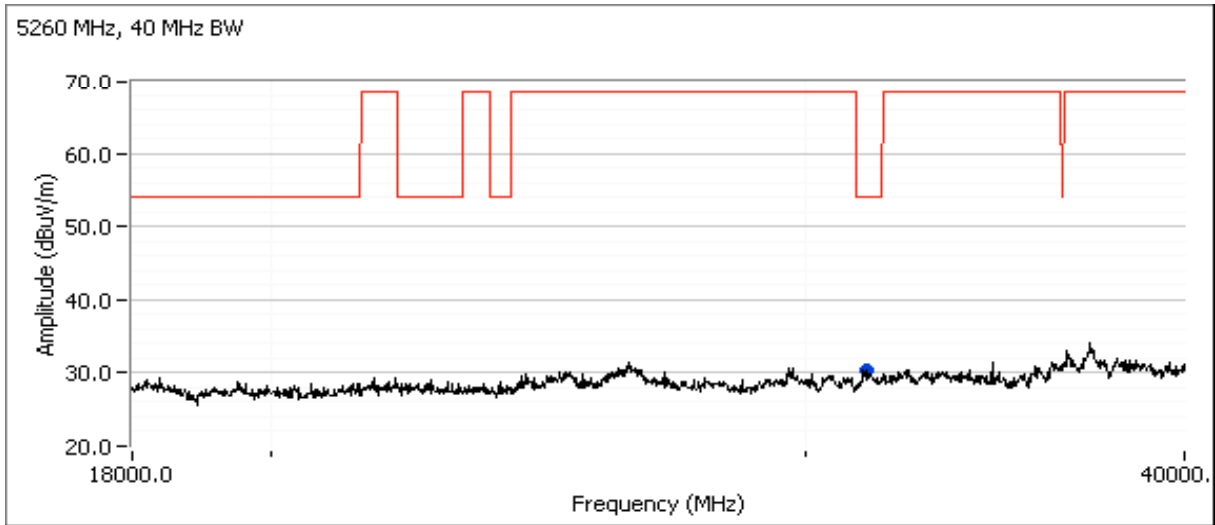
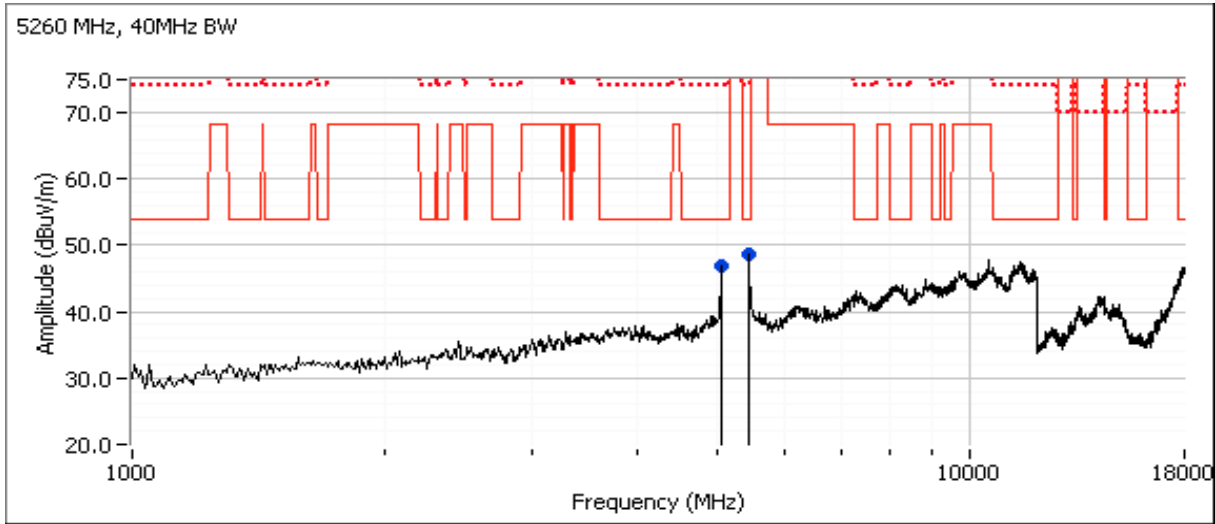

Client: Nextivity Inc	Job Number: J94664
Model: D32-2/4NU and D32-2/4CU	T-Log Number: T94720
	Account Manager: Christine Krebill
Contact: Michiel Lotter	
Standard: FCC Part 15.247, Part 15.407 and RSS 210	Class: N/A

Run #4b, Radiated Spurious Emissions, 30 - 40,000 MHz. Operation in the 5250-5350 MHz Band

Date of Test: 3/13/2014

Test Engineer: Jack Liu / R. Varelas

Test Location: FT Chamber #7

Center Channel @ 5280 MHz 40 MHz Bandwidth

Spurious Radiated Emissions:

Frequency	Level	Pol	FCC 15.209		Detector	Azimuth	Height	Comments
MHz	dB μ V/m	v/h	Limit	Margin	Pk/QP/Avg	degrees	meters	
5433.140	45.4	V	54.0	-8.6	AVG	104	1.0	RB 1 MHz;VB 10 Hz;Peak
5434.120	58.0	V	74.0	-16.0	PK	104	1.0	RB 1 MHz;VB 3 MHz;Peak
5050.870	43.2	V	54.0	-10.8	AVG	302	1.0	RB 1 MHz;VB 10 Hz;Peak
5048.690	55.2	V	74.0	-18.8	PK	302	1.0	RB 1 MHz;VB 3 MHz;Peak

Note 1: For emissions in restricted bands, the limit of 15.209 was used which requires average and peak measurements.

Note 2: For emissions outside of the restricted bands the limit is -27 dBm/MHz eirp (68.3 dB μ V/m). The measurement method required is a peak measurement (RB=1 MHz, VB \geq 3 MHz, peak detector). Plot shows all three limits below 12 GHz. Above 12 GHz noise floor is lower due to testing at closer distance.

Note 3: Emissions in the 30-1000 MHz range are not radio related, they are the same regardless of channel.

Note 4: Scans made between 18 - 40 GHz with the measurement antenna moved around the card and its antennas 20-50 cm from the device indicated there were no significant emissions in this frequency range

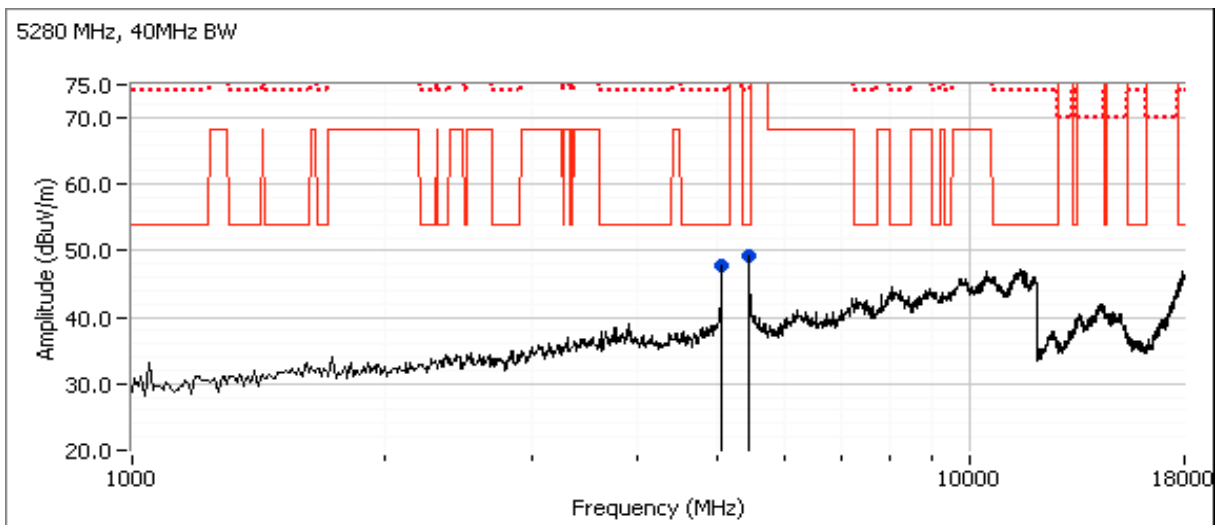

Client: Nextivity Inc	Job Number: J94664
Model: D32-2/4NU and D32-2/4CU	T-Log Number: T94720
	Account Manager: Christine Krebill
Contact: Michiel Lotter	
Standard: FCC Part 15.247, Part 15.407 and RSS 210	Class: N/A

Run #4c, Radiated Spurious Emissions, 30 - 40,000 MHz. Operation in the 5250-5350 MHz Band

Date of Test: 3/13/2014

Test Engineer: Jack Liu

Test Location: FT Chamber #7

High Channel @ 5293 MHz 40 MHz Bandwidth

Spurious Radiated Emissions:

Frequency MHz	Level dB μ V/m	Pol v/h	FCC 15.209		Detector Pk/QP/Avg	Azimuth degrees	Height meters	Comments
			Limit	Margin				
5431.870	45.4	H	54.0	-8.6	AVG	320	2.5	RB 1 MHz;VB 10 Hz;Peak
5432.750	56.7	H	74.0	-17.3	PK	320	2.5	RB 1 MHz;VB 3 MHz;Peak
5049.990	43.3	V	54.0	-10.7	AVG	176	1.5	RB 1 MHz;VB 10 Hz;Peak
5049.840	54.9	V	74.0	-19.1	PK	176	1.5	RB 1 MHz;VB 3 MHz;Peak

Note 1: For emissions in restricted bands, the limit of 15.209 was used which requires average and peak measurements.

Note 2: For emissions outside of the restricted bands the limit is -27 dBm/MHz eirp (68.3 dB μ V/m). The measurement method required is a peak measurement (RB=1 MHz, VB \geq 3 MHz, peak detector). Plot shows all three limits below 12 GHz. Above 12 GHz noise floor is lower due to testing at closer distance.

Note 3: Scans made between 18 - 40 GHz with the measurement antenna moved around the card and its antennas 20-50 cm from the device indicated there were no significant emissions in this frequency range

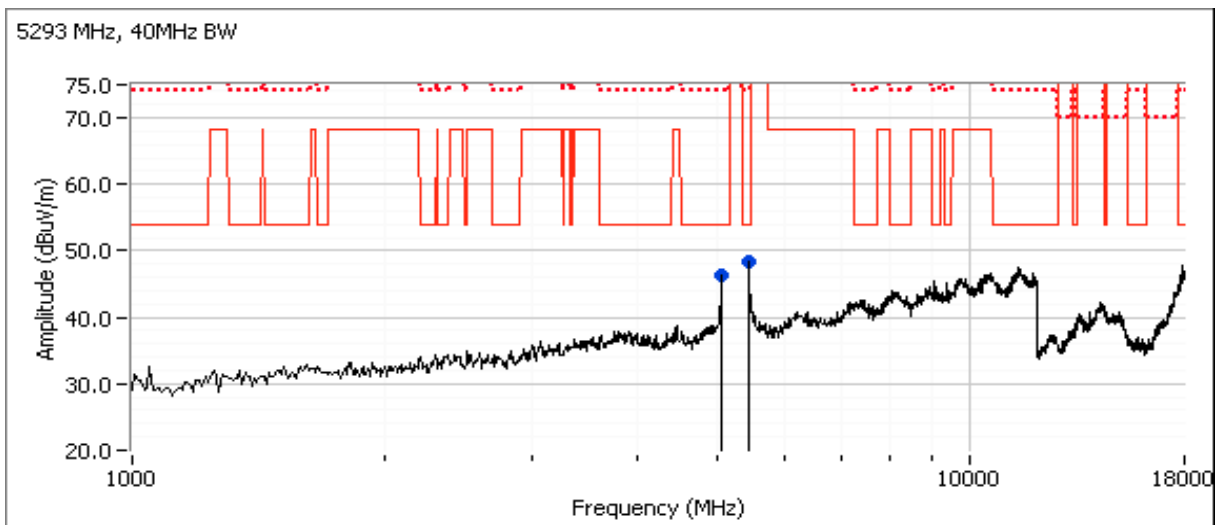



EMC Test Data

Client: Nextivity Inc	Job Number: J94664
Model: D32-2/4NU and D32-2/4CU	T-Log Number: T94720
	Account Manager: Christine Krebill
Contact: Michiel Lotter	
Standard: FCC Part 15.247, Part 15.407 and RSS 210	Class: N/A

Run #4d: High Channel @ 5293 MHz 40 MHz Bandwidth

Date of Test: 3/12/2014

Test Engineer: Rafael Varelas

Test Location: FT Chamber #7

5350 MHz Band Edge Radiated Field Strength

Frequency MHz	Level dB μ V/m	Pol v/h	FCC 15.209		Detector Pk/QP/Avg	Azimuth degrees	Height meters	Comments
			Limit	Margin				
5351.440	53.3	V	54.0	-0.7	AVG	288	1.1	POS; RB 1 MHz; VB: 10 Hz
5352.400	67.9	V	74.0	-6.1	PK	288	1.1	POS; RB 1 MHz; VB: 3 MHz
5351.280	52.4	H	54.0	-1.6	AVG	300	1.0	POS; RB 1 MHz; VB: 10 Hz
5352.160	65.9	H	74.0	-8.1	PK	300	1.0	POS; RB 1 MHz; VB: 3 MHz

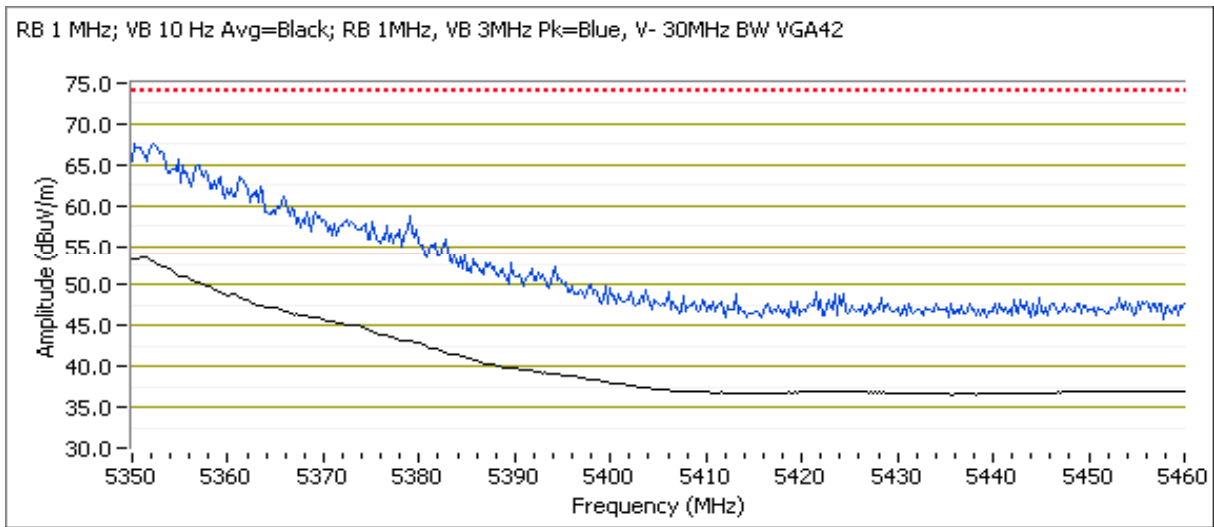

Client: Nextivity Inc	Job Number: J94664
Model: D32-2/4NU and D32-2/4CU	T-Log Number: T94720
	Account Manager: Christine Krebill
Contact: Michiel Lotter	
Standard: FCC Part 15.247, Part 15.407 and RSS 210	Class: N/A

RSS-210 and FCC 15.407(U-II) Power, PSD, Peak Excursion and Bandwidth

Test Specific Details

Objective: The objective of this test session is to perform final qualification testing of the EUT with respect to the specification listed above.

Date of Test: 3/11/2014, 3/12/14, 3/24/2014	Config. Used: 1
Test Engineer: J. Liu/ R. Varelas/ D. Demirci	Config Change: None
Test Location: FT Chamber #7/Chamber #5	EUT Voltage: 120V/60Hz

Summary of Results

Run #	Test Performed	Limit	Pass / Fail	Result / Margin
1a	Power, 5470 - 5725 MHz	15.407(a) (1), (2)	Pass	16.5 dBm (44.2 mW)
1b	Power, 5725 - 5825 MHz	15.407(a) (1), (2)	Pass	14.9 dBm (30.8 mW)
1c	PSD, 5460 - 5725 MHz	15.407(a) (1), (2)	Pass	2.2 dBm/MHz
1d	PSD, 5725 - 5825 MHz	15.407(a) (1), (2)	Pass	1.2 dBm/MHz
1a/b	26 dB ¹ Bandwidth	15.407	N/A	30.7 MHz
1a/b	99% Bandwidth (UNII)	RSS 210	N/A	37.2 MHz
1c	99% Bandwidth (DTS)	RSS 210	N/A	37.2 MHz
2	Peak Excursion Envelope	15.407(a) (6) 13 dB	Pass	10.9 dB
3	TDWR 5600 MHz and 5650 MHz requirement	15.215 (c) 20 dBc	Pass	Within 20 dBc

Note 1: 26 dB bandwidth measurements of band-crossing channels are excluded in the summary table above.

General Test Configuration

The EUT was located on the turntable for radiated spurious emissions testing. DELL Latitude D830 Laptop and Nextivity Chart Interface (V:2.0.0.2) software was used to configure the EUT. The laptop was not connected during the tests.

The EUT was radiating through its internal antenna. The emission was maximized, & EIRP was measured as described in the notes.

For radiated emissions testing the measurement antenna was located 3 meters from the EUT.

Ambient Conditions:

Temperature:	21-24 °C
Rel. Humidity:	30-45 %

Modifications Made During Testing

No modifications were made to the EUT during testing

Deviations From The Standard

No deviations were made from the requirements of the standard.

Client: Nextivity Inc	Job Number: J94664
Model: D32-2/4NU and D32-2/4CU	T-Log Number: T94720
	Account Manager: Christine Krebill
Contact: Michiel Lotter	
Standard: FCC Part 15.247, Part 15.407 and RSS 210	Class: N/A

Run #1: Bandwidth, Output Power and Power Spectral Density - Single Chain Systems

Note 1:	Radiated output power measured using a spectrum analyzer (see plots below). RBW=1 MHz, VB=3 MHz, RMS detector, Sweep Time Auto, 100 sweeps, Trigger, Free run, and power integration over 50 and 60 MHz. EUT is operating at 100% duty cycle. (UNII method SA-1 of KDB 789033 D01 v01r03 and DTS method AVGSA-1 of 558074 D01 v03r01)
Note 2:	U-NII Power Spectral Density measured using the same analyzer settings used for U-NII output power.
Note 3:	DTS Power Spectral Density measured using a spectrum analyzer (see plots below). RBW=100 kHz, VB=300 kHz, RMS detector, Sweep Time Auto, 100 sweeps, Trigger, Free run. EUT is operating at 100% duty cycle. (DTS method AVGPSD-1 of 558074 D01 v03r01)
Note 4:	99% Bandwidth measured in accordance with RSS GEN - RB > 1% of span and VB >=3xRB
Note 5:	Measurements are performed with radiated emission method. Conducted power and PSD are calculated by subtracting the antenna gain from measured radiated values
Note 6:	Emission Bandwidths of 5715 and 5735 MHz channels intentionally extend into the 5.725-5.825 GHz band, therefore FCC 15.407 U-NII band rules apply for these channels per KDB 644545 D01 v01r02.

1a 5470- 5725 MHz Band 30 MHz Bandwidth

Frequency (MHz)	Software Setting	Output Power ¹ dBm EIRP (Measured)	PSD ² dBm / MHz EIRP (Measured)	Antenna polarity	
5525	-	22.1	7.5	Vertical	
5580	-	22.5	8.2	Vertical	
5715	-	21.1	7.9	Vertical	U-NII-2C
5715	-	14.3	7.7	Vertical	U-NII-3

Antenna Gain (dBi): 6

EIRP: 175.8 mW 22.5 dBm

Frequency (MHz)	Software Setting	Bandwidth		Output Power ¹ dBm		Power (Watts)	PSD ² dBm / MHz			Result
		26dB	99% ⁴	Calculated ⁵	Limit		Calculated ⁵	FCC Limit	RSS Limit	
5525	-	30.7	29.0	16.1	24.0	0.041	1.5	11.0	11.0	Pass
5580	-	30.7	29.0	16.5	24.0	0.044	2.2	11.0	11.0	Pass
5715	-	25.3	24.2	15.1	24.0	0.032	1.9	11.0	11.0	Pass
5715	-	5.5	5.0	8.3	24.5	0.007	1.7	17.0	17.0	Pass

Client: Nextivity Inc	Job Number: J94664
Model: D32-2/4NU and D32-2/4CU	T-Log Number: T94720
	Account Manager: Christine Krebill
Contact: Michiel Lotter	
Standard: FCC Part 15.247, Part 15.407 and RSS 210	Class: N/A

1a 5470- 5725 MHz Band 40 MHz Bandwidth

Frequency (MHz)	Software Setting	Output Power ¹ dBm EIRP (Measured)	PSD ² dBm / MHz EIRP (Measured)	Antenna polarity	
5525	-	21.7	5.7	Vertical	
5580	-	22.1	6.3	Vertical	
5715	-	20.8	6.2	Vertical	U-NII-2C
5715	-	14.8	5.6	Vertical	U-NII-3

Antenna Gain (dBi): 6 EIRP: 161.8 mW 22.1 dBm

Frequency (MHz)	Software Setting	Bandwidth		Output Power ¹ dBm		Power (Watts)	PSD ² dBm / MHz			Result
		26dB	99% ⁴	Calculated ⁵	Limit		Calculated ⁵	FCC Limit	RSS Limit	
5525	-	39.2	37.2	15.7	24.0	0.037	-0.4	11.0	11.0	Pass
5580	-	39.3	37.2	16.1	24.0	0.041	0.3	11.0	11.0	Pass
5715	-	29.7	27.9	14.8	24.0	0.030	0.2	11.0	11.0	Pass
5715	-	9.5	8.8	8.8	26.8	0.008	-0.4	17.0	17.0	Pass

1b 5725- 5825 MHz Band 30 MHz Bandwidth

Frequency (MHz)	Software Setting	Output Power ¹ dBm EIRP (Measured)	PSD ² dBm / MHz EIRP (Measured)	Antenna polarity	
5735	-	14.0	7.2	Vertical	U-NII-2C
5735	-	20.9	7.1	Vertical	U-NII-3

Antenna Gain (dBi): 6 EIRP: 121.9 mW 20.86 dBm

Frequency (MHz)	Software Setting	Bandwidth		Output Power ¹ dBm		Power (Watts)	PSD ² dBm / MHz			Result
		26dB	99% ⁴	Calculated ⁵	Limit		Calculated ⁵	FCC Limit	RSS Limit	
5735	-	5.3	4.7	8.0	18.2	0.006	1.2	11.0	11.0	Pass
5735	-	25.5	24.2	14.9	30.0	0.031	1.1	17.0	17.0	Pass

1b 5725- 5825 MHz Band 40 MHz Bandwidth

Frequency (MHz)	Software Setting	Output Power ¹ dBm EIRP (Measured)	PSD ² dBm / MHz EIRP (Measured)	Antenna polarity	
5735	-	15.6	6.5	Vertical	U-NII-2C
5735	-	20.9	6.4	Vertical	U-NII-3

Antenna Gain (dBi): 6 EIRP: 122.7 mW 20.9 dBm

Frequency (MHz)	Software Setting	Bandwidth		Output Power ¹ dBm		Power (Watts)	PSD ² dBm / MHz			Result
		26dB	99% ⁴	Calculated ⁵	Limit		Calculated ⁵	FCC Limit	RSS Limit	
5735	-	9.7	8.9	9.6	20.8	0.009	0.5	11.0	11.0	Pass
5735	-	29.5	28.5	14.9	30.0	0.031	0.4	17.0	17.0	Pass

Client: Nextivity Inc	Job Number: J94664
Model: D32-2/4NU and D32-2/4CU	T-Log Number: T94720
	Account Manager: Christine Krebill
Contact: Michiel Lotter	
Standard: FCC Part 15.247, Part 15.407 and RSS 210	Class: N/A

CU Ch Freq 5525 MHz @ 30 MHz Bandwidth

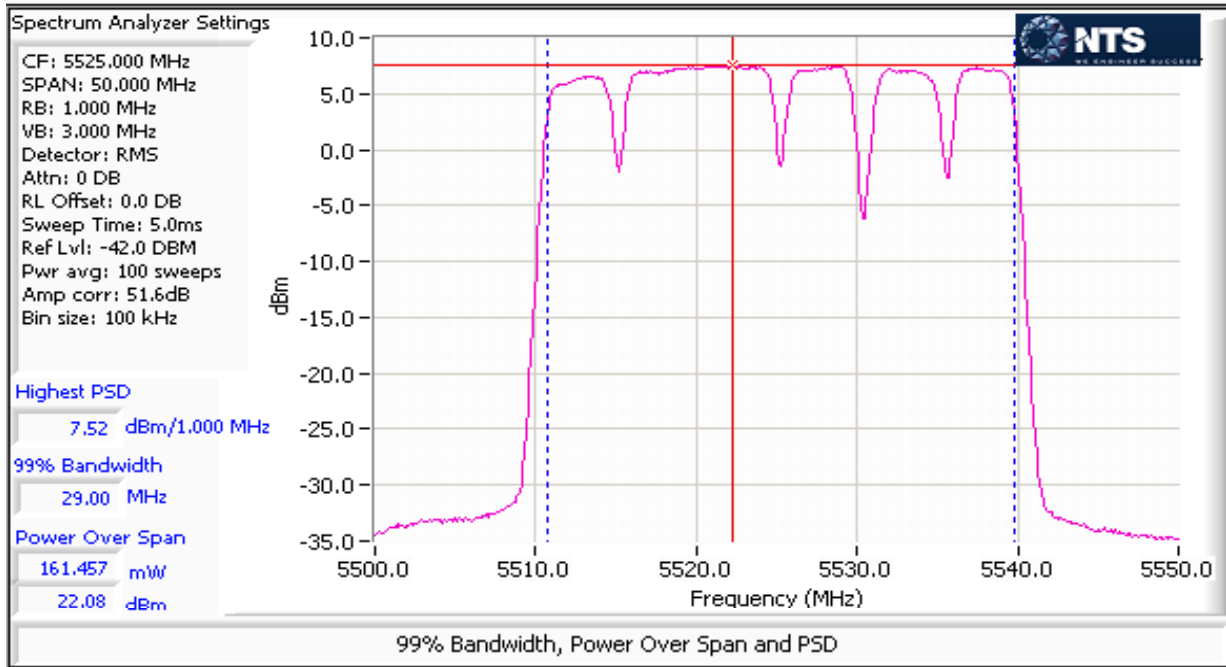

CU Ch Freq 5580 MHz @ 30 MHz Bandwidth

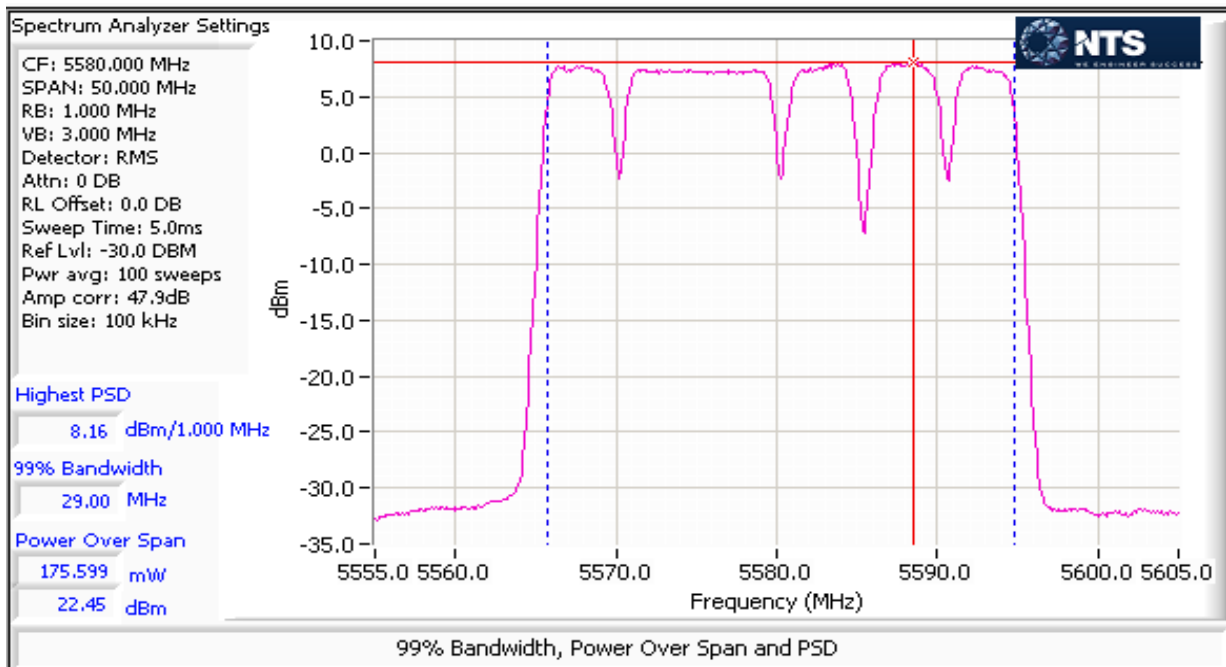

Client: Nextivity Inc	Job Number: J94664
Model: D32-2/4NU and D32-2/4CU	T-Log Number: T94720
	Account Manager: Christine Krebill
Contact: Michiel Lotter	
Standard: FCC Part 15.247, Part 15.407 and RSS 210	Class: N/A

CU Ch Freq 5715 MHz @ 30 MHz Bandwidth (U-NII-2C)

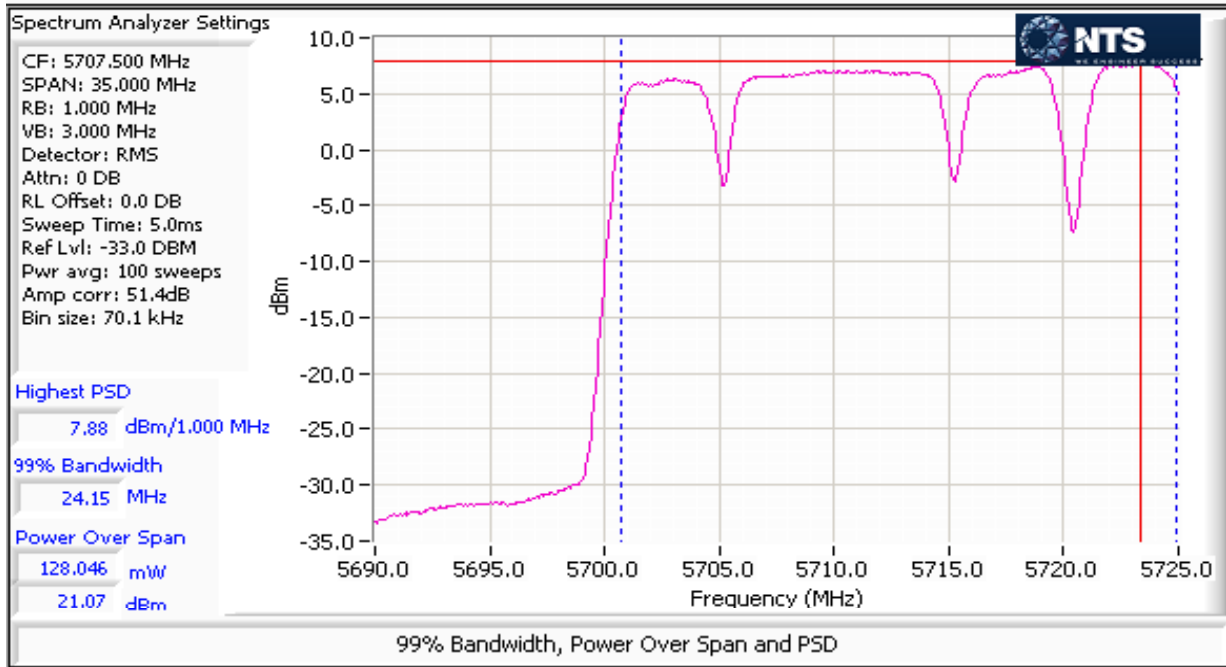

CU Ch Freq 5715 MHz @ 30 MHz Bandwidth (U-NII-3)

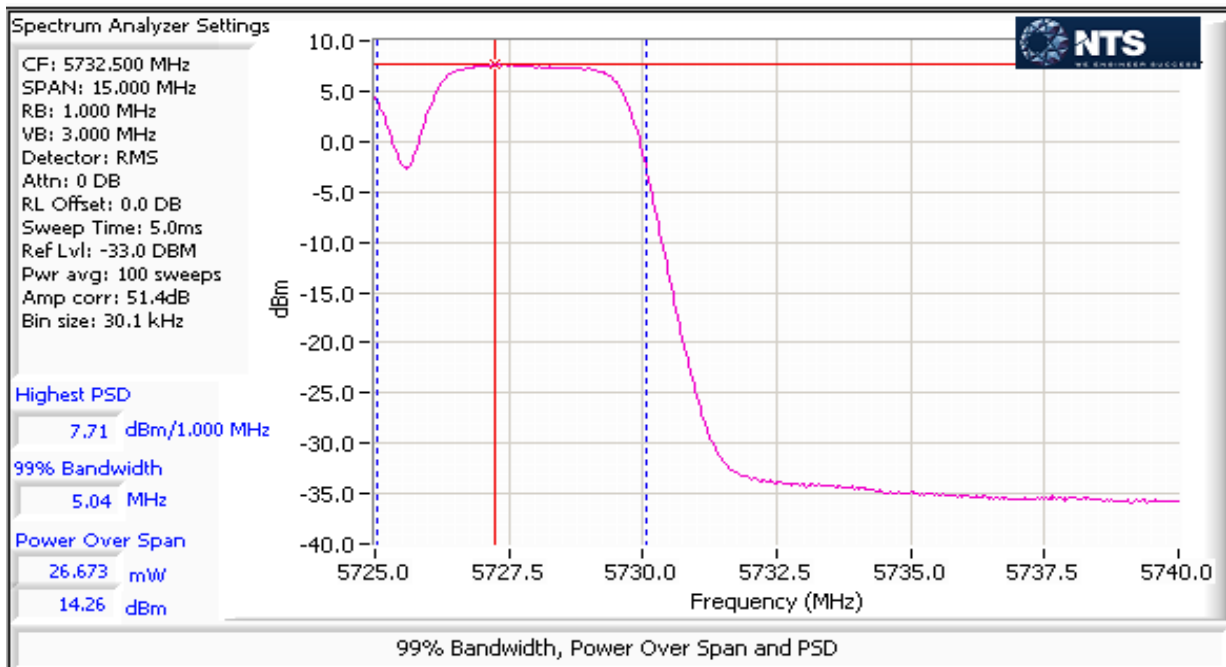

Client: Nextivity Inc	Job Number: J94664
Model: D32-2/4NU and D32-2/4CU	T-Log Number: T94720
Contact: Michiel Lotter	Account Manager: Christine Krebill
Standard: FCC Part 15.247, Part 15.407 and RSS 210	Class: N/A

CU Ch Freq 5525 MHz @ 40 MHz Bandwidth

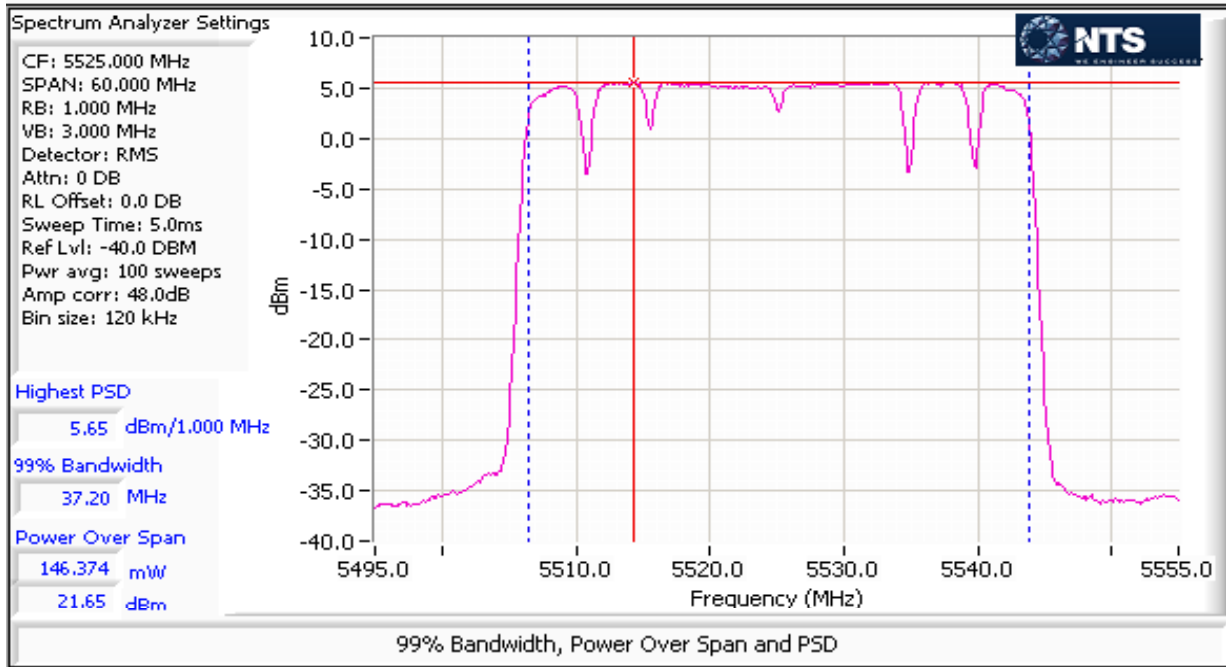

CU Ch Freq 5580 MHz @ 40 MHz Bandwidth

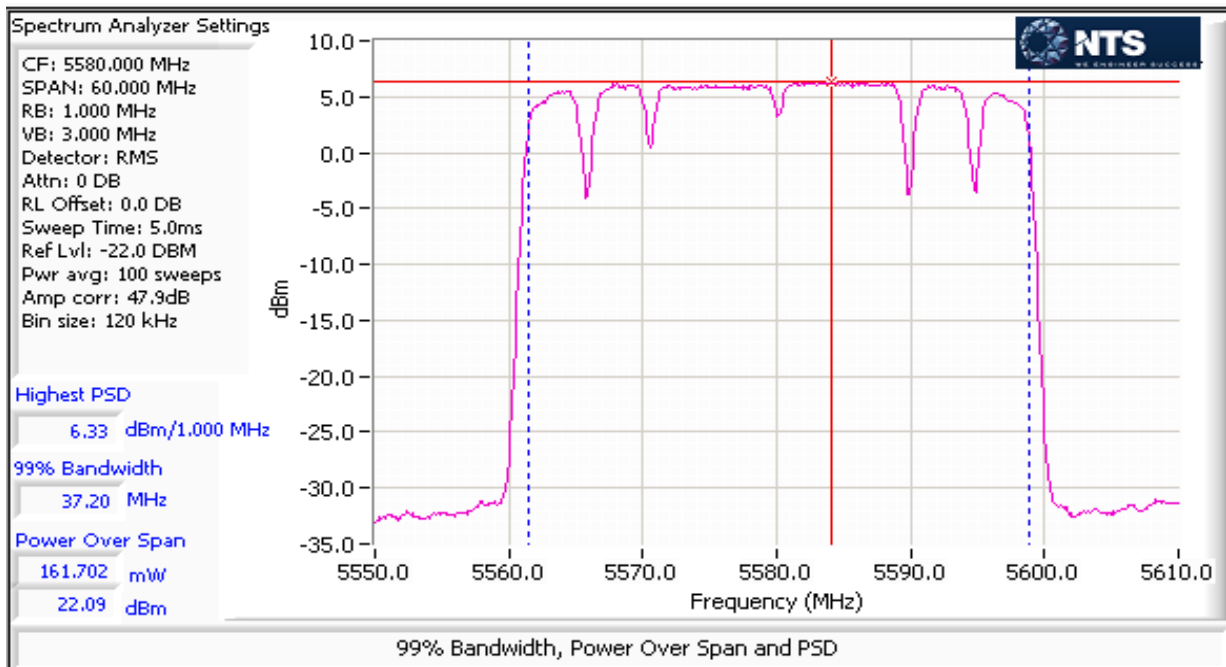

Client: Nextivity Inc	Job Number: J94664
Model: D32-2/4NU and D32-2/4CU	T-Log Number: T94720
	Account Manager: Christine Krebill
Contact: Michiel Lotter	
Standard: FCC Part 15.247, Part 15.407 and RSS 210	Class: N/A

CU Ch Freq 5715 MHz @ 40 MHz Bandwidth (U-NII-2C)

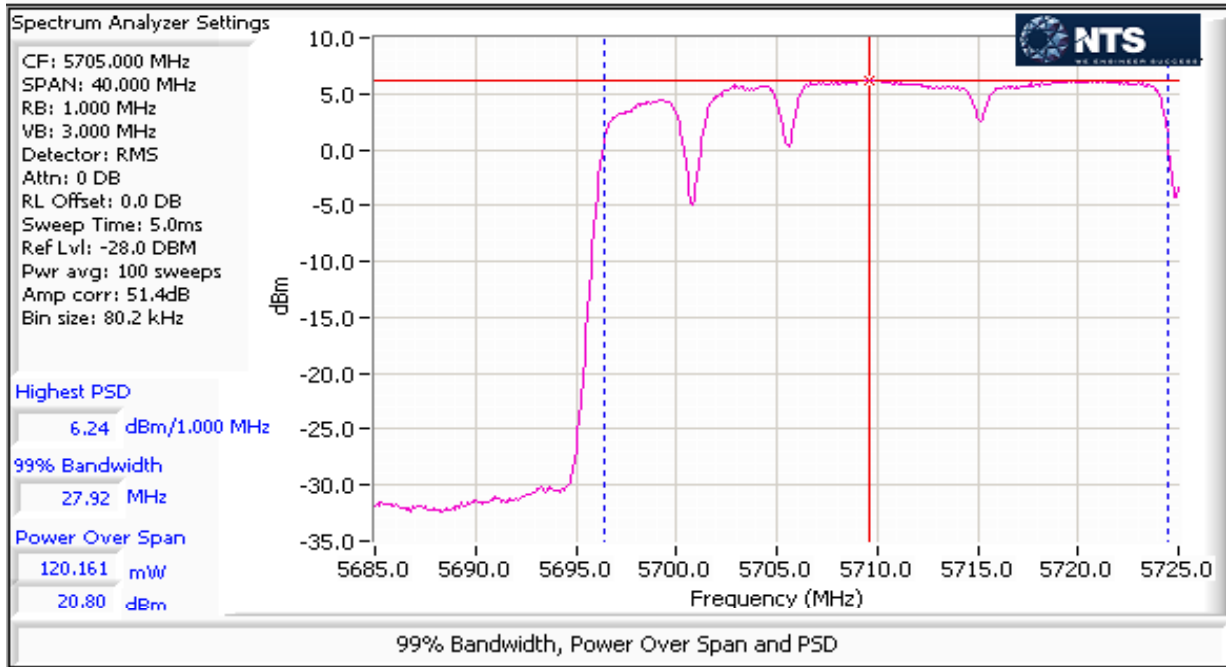

CU Ch Freq 5715 MHz @ 40 MHz Bandwidth (U-NII-3)

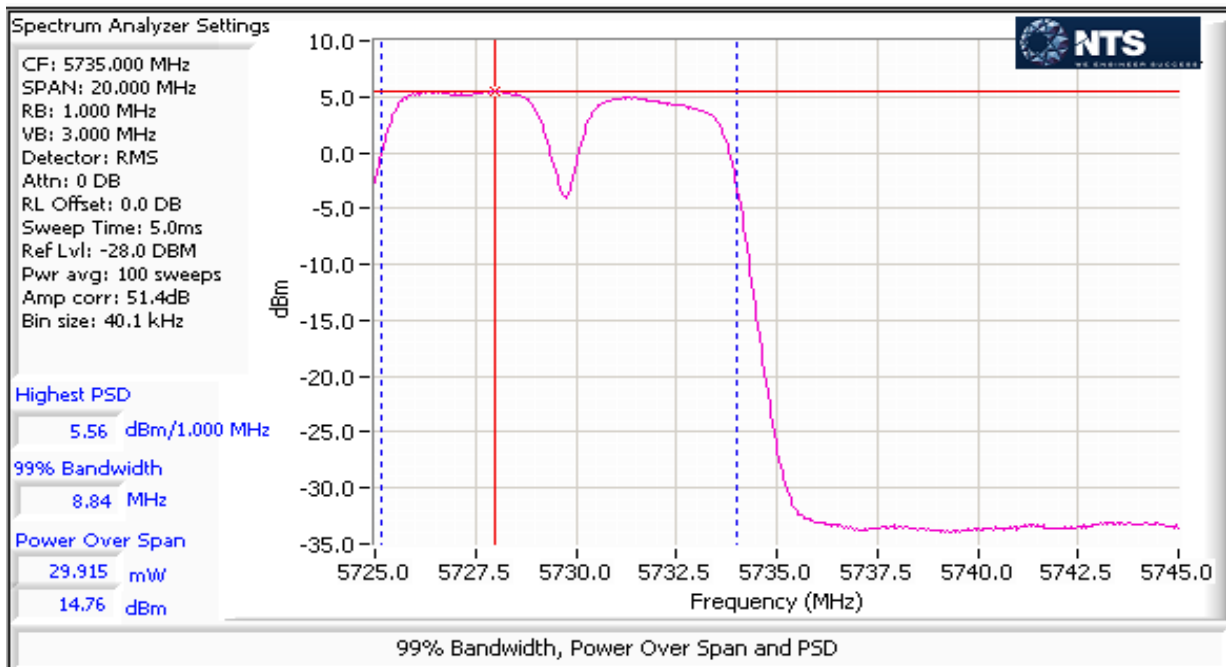

Client: Nextivity Inc	Job Number: J94664
Model: D32-2/4NU and D32-2/4CU	T-Log Number: T94720
	Account Manager: Christine Krebill
Contact: Michiel Lotter	
Standard: FCC Part 15.247, Part 15.407 and RSS 210	Class: N/A

CU Ch Freq 5735 MHz @ 30 MHz Bandwidth (U-NII-2C)

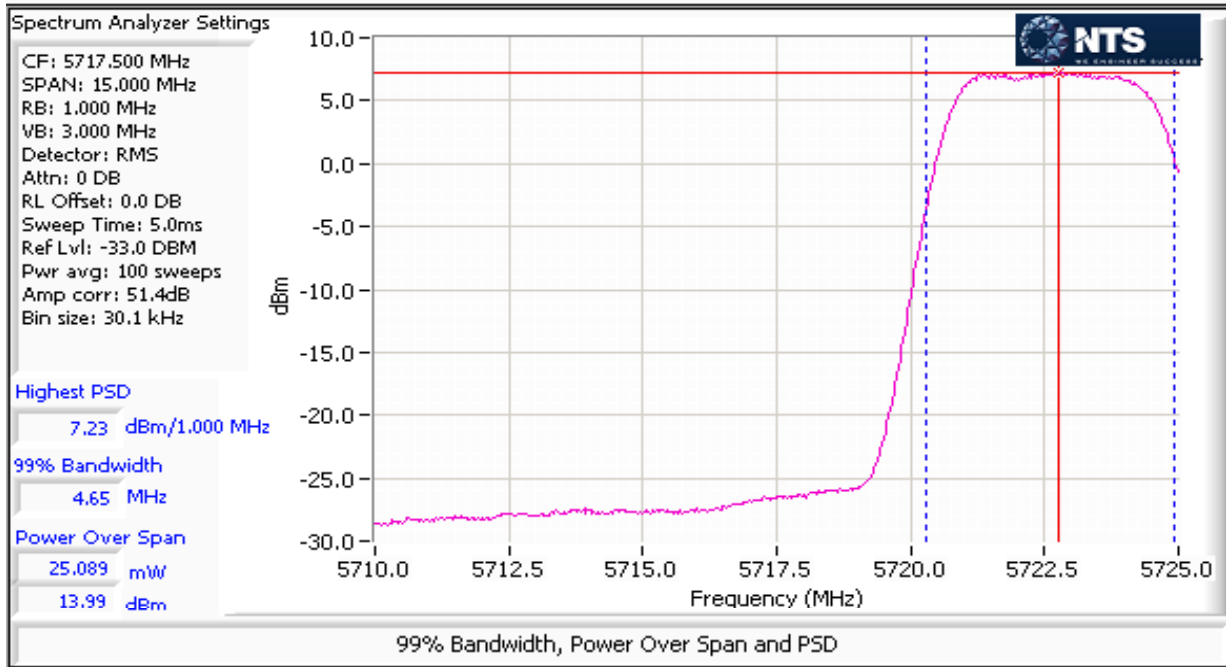

CU Ch Freq 5735 MHz @ 30 MHz Bandwidth (U-NII-3)

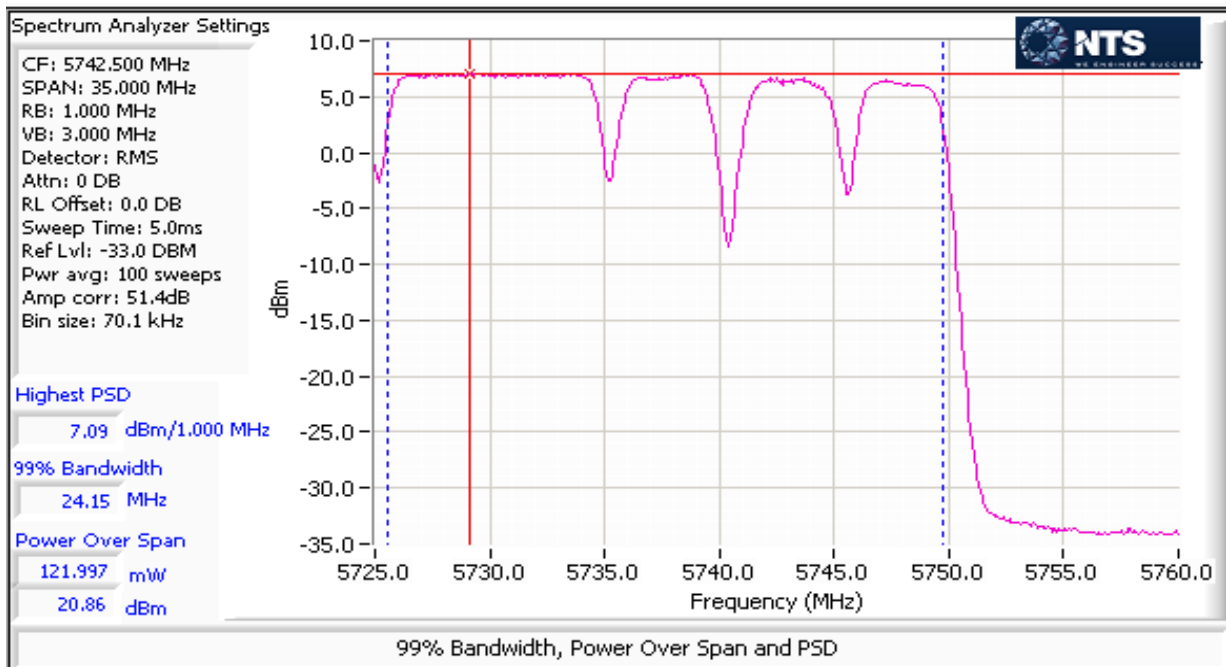

Client: Nextivity Inc	Job Number: J94664
Model: D32-2/4NU and D32-2/4CU	T-Log Number: T94720
Contact: Michiel Lotter	Account Manager: Christine Krebill
Standard: FCC Part 15.247, Part 15.407 and RSS 210	Class: N/A

CU Ch Freq 5735 MHz @ 40 MHz Bandwidth (U-NII-2C)

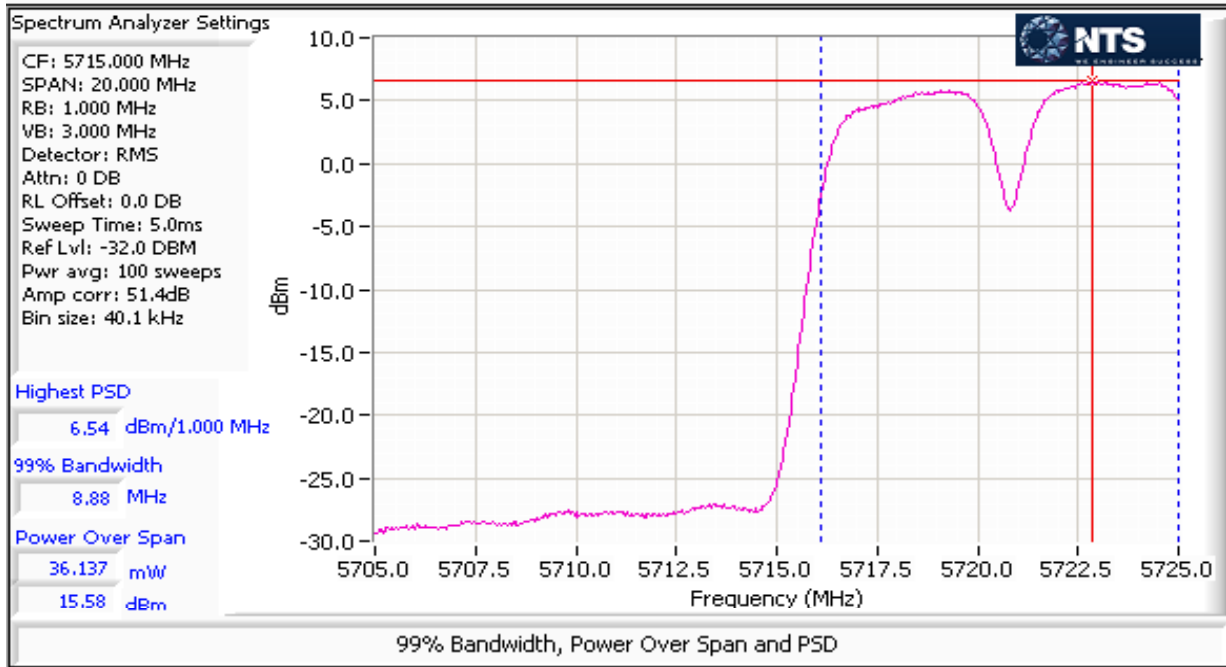

CU Ch Freq 5735 MHz @ 40 MHz Bandwidth (U-NII-3)

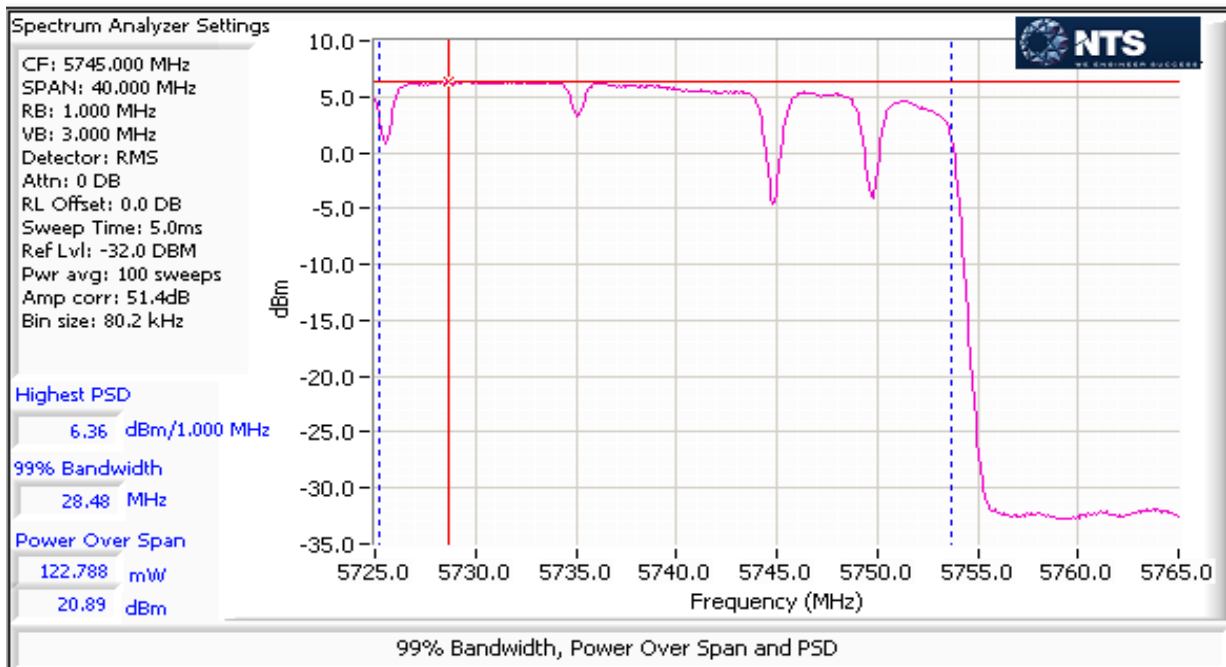

Client: Nextivity Inc	Job Number: J94664
Model: D32-2/4NU and D32-2/4CU	T-Log Number: T94720
	Account Manager: Christine Krebill
Contact: Michiel Lotter	
Standard: FCC Part 15.247, Part 15.407 and RSS 210	Class: N/A

26dB BW- CU Ch Freq 5525 MHz @ 30 MHz Bandwidth

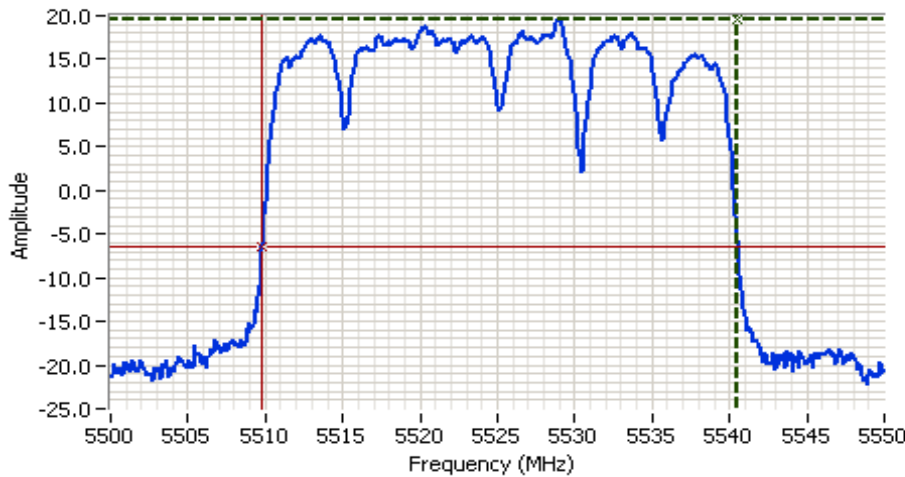

Analyzer Settings

Rohde&Schwarz,ESI
 CF: 5525.000 MHz
 SPAN: 50.000 MHz
 RB: 1.000 MHz
 VB: 3.000 MHz
 Detector: POS
 Attn: 0 DB
 RL Offset: 51.6 DB
 Sweep Time: 5.0ms
 Ref Lvl: 20.0 DBM

Comments

26dB BW: 30.661 MHz
 5525 MHz 30 MHz BW

Cursor 1	5540.4810	19.61	
Cursor 2	5509.8196	-6.39	

Delta Freq. 30.661
 Delta Amplitude 26.00



26dB Bw- CU Ch Freq 5580 MHz @ 30 MHz Bandwidth

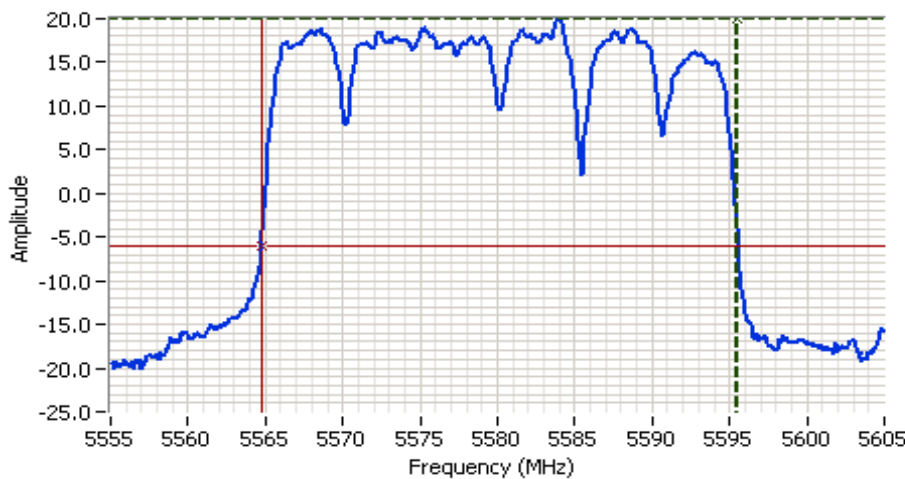

Analyzer Settings

Rohde&Schwarz,ESI
 CF: 5580.000 MHz
 SPAN: 50.000 MHz
 RB: 1.000 MHz
 VB: 3.000 MHz
 Detector: POS
 Attn: 0 DB
 RL Offset: 47.9 DB
 Sweep Time: 5.0ms
 Ref Lvl: 25.0 DBM

Comments

26dB BW: 30.661 MHz
 5580 MHz 30 MHz BW

Cursor 1	5595.4810	19.97	
Cursor 2	5564.8196	-6.03	

Delta Freq. 30.661
 Delta Amplitude 26.00



Client: Nextivity Inc	Job Number: J94664
Model: D32-2/4NU and D32-2/4CU	T-Log Number: T94720
Contact: Michiel Lotter	Account Manager: Christine Krebill
Standard: FCC Part 15.247, Part 15.407 and RSS 210	Class: N/A

26dB Bw- CU Ch Freq 5715 MHz @ 30 MHz Bandwidth (U-NII-2C: 25.281 MHz, U-NII-3: 5.481 MHz)

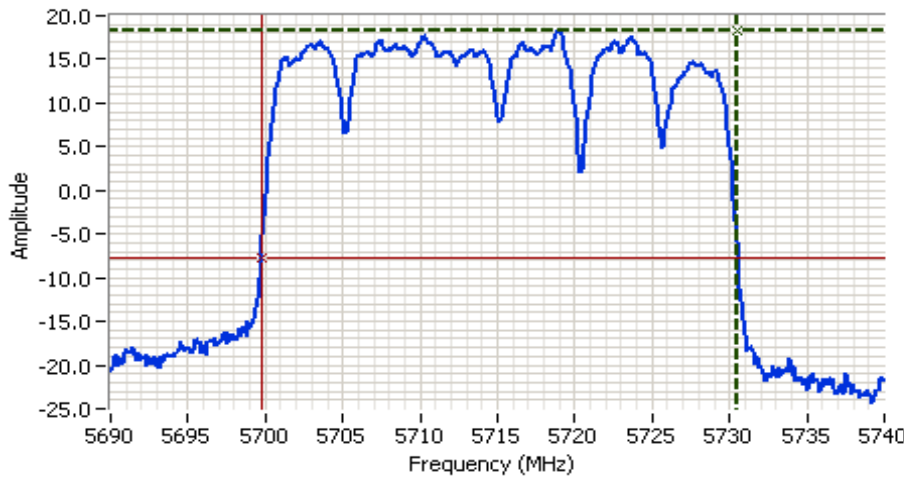

Analyzer Settings

Rohde&Schwarz,ESI
 CF: 5715.000 MHz
 SPAN: 50.000 MHz
 RB: 1.000 MHz
 VB: 3.000 MHz
 Detector: POS
 Attn: 0 DB
 RL Offset: 51.4 DB
 Sweep Time: 5.0ms
 Ref Lvl: 20.0 DBM

Comments

Total 26dB BW: 30.762 MHz
 U-NII-2C: 25.281 MHz
 U-NII-3: 5.481 MHz

Cursor 1	5730.4810	18.38		Delta Freq.	30.762
Cursor 2	5699.7194	-7.62		Delta Amplitude	26.00



26dB Bw- CU Ch Freq 5525 MHz @ 40 MHz Bandwidth

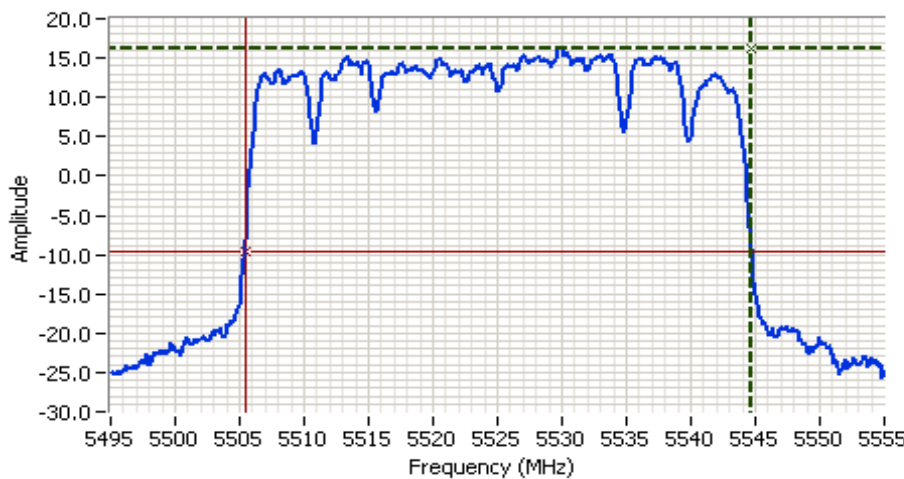

Analyzer Settings

Rohde&Schwarz,ESI
 CF: 5525.000 MHz
 SPAN: 60.000 MHz
 RB: 1.000 MHz
 VB: 3.000 MHz
 Detector: POS
 Attn: 0 DB
 RL Offset: 48.0 DB
 Sweep Time: 5.0ms
 Ref Lvl: 25.0 DBM

Comments

26dB BW: 39.198 MHz
 5525 MHz 40 MHz BW

Cursor 1	5544.6593	16.28		Delta Freq.	39.198
Cursor 2	5505.4609	-9.72		Delta Amplitude	26.00



Client: Nextivity Inc	Job Number: J94664
Model: D32-2/4NU and D32-2/4CU	T-Log Number: T94720
Contact: Michiel Lotter	Account Manager: Christine Krebill
Standard: FCC Part 15.247, Part 15.407 and RSS 210	Class: N/A

26dB Bw- CU Ch Freq 5580 MHz @ 40 MHz Bandwidth

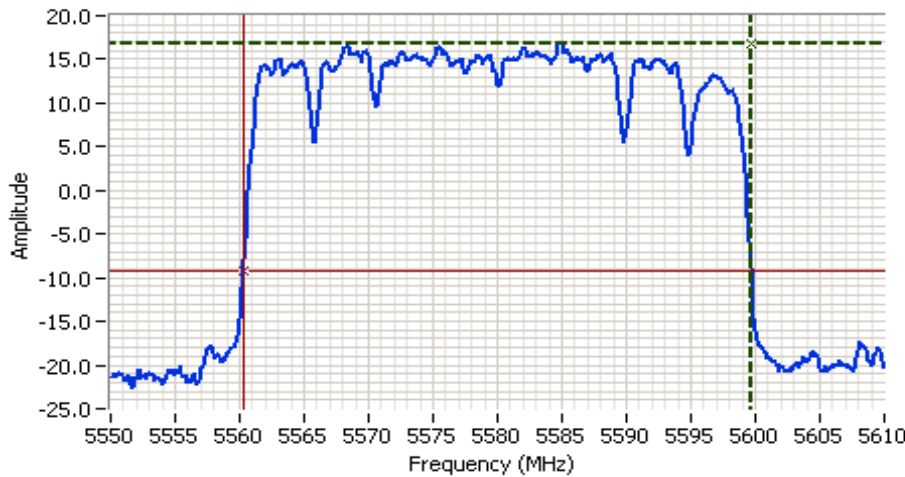

Analyzer Settings

Rohde&Schwarz,ESI
 CF: 5580.000 MHz
 SPAN: 60.000 MHz
 RB: 1.000 MHz
 VB: 3.000 MHz
 Detector: POS
 Attn: 0 DB
 RL Offset: 47.9 DB
 Sweep Time: 5.0ms
 Ref Lvl: 25.0 DBM

Comments

26dB BW: 39.319 MHz
 5580 MHz 40 MHz BW

Cursor 1 5599.6593 16.78
 Cursor 2 5560.3407 -9.22

Delta Freq. 39.319
 Delta Amplitude 26.00



26dB Bw- CU Ch Freq 5715 MHz @ 40 MHz Bandwidth (U-NII-2C: 29.659 MHz, U-NII-3: 9.539 MHz)

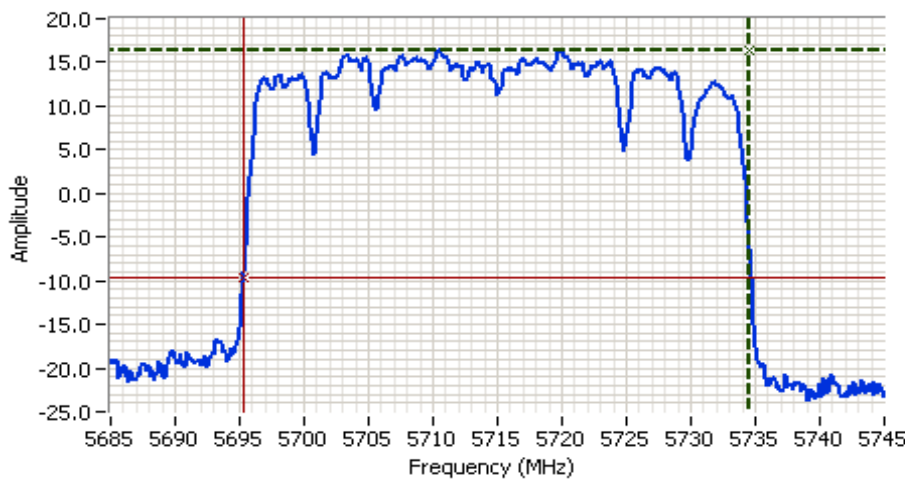

Analyzer Settings

Rohde&Schwarz,ESI
 CF: 5715.000 MHz
 SPAN: 60.000 MHz
 RB: 1.000 MHz
 VB: 3.000 MHz
 Detector: POS
 Attn: 0 DB
 RL Offset: 51.4 DB
 Sweep Time: 5.0ms
 Ref Lvl: 23.4 DBM

Comments

Total 26dB BW: 39.198 MHz
 U-NII-2C: 29.659 MHz
 U-NII-3: 9.539 MHz

Cursor 1 5734.5391 16.37
 Cursor 2 5695.3407 -9.63

Delta Freq. 39.198
 Delta Amplitude 26.00



Client: Nextivity Inc	Job Number: J94664
Model: D32-2/4NU and D32-2/4CU	T-Log Number: T94720
	Account Manager: Christine Krebill
Contact: Michiel Lotter	
Standard: FCC Part 15.247, Part 15.407 and RSS 210	Class: N/A

26dB BW-CU Ch Freq 5735 MHz @ 30 MHz Bandwidth (U-NII-2C: 5.281 MHz, U-NII-3: 25.481 MHz)

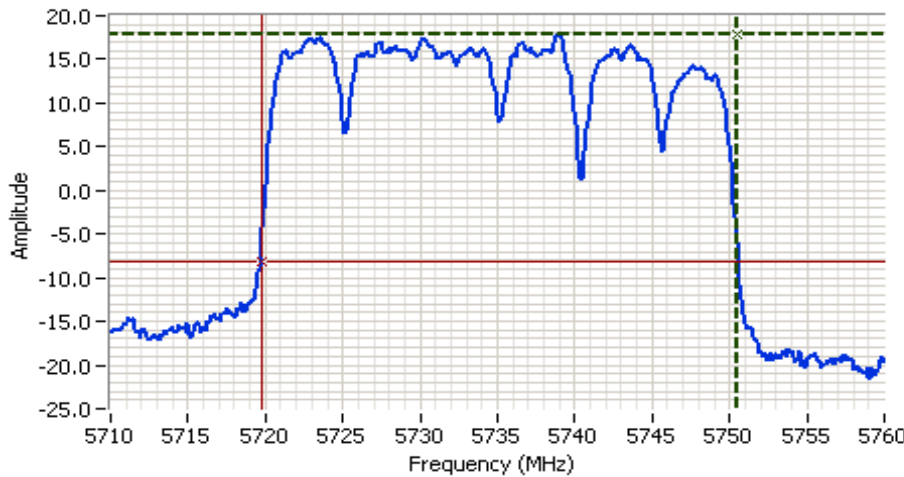

Analyzer Settings

Rohde&Schwarz,ESI
 CF: 5735.000 MHz
 SPAN: 50.000 MHz
 RB: 1.000 MHz
 VB: 3.000 MHz
 Detector: POS
 Attn: 0 DB
 RL Offset: 51.4 DB
 Sweep Time: 5.0ms
 Ref Lvl: 20.0 DBM

Comments

Total 26dB BW: 30.762 MHz
 U-NII-2C: 5.281 MHz
 U-NII-3: 25.481 MHz

Cursor 1	5750.4810	17.95		Delta Freq.	30.762
Cursor 2	5719.7194	-8.05		Delta Amplitude	26.00



26dB BW-CU Ch Freq 5735 MHz @ 40 MHz Bandwidth (U-NII-2C: 9.659 MHz, U-NII-3: 29.539 MHz)

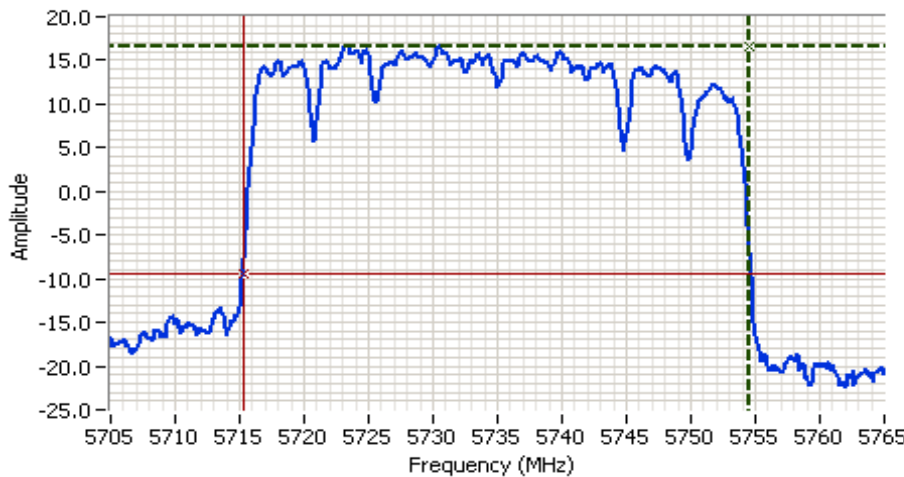

Analyzer Settings

Rohde&Schwarz,ESI
 CF: 5735.000 MHz
 SPAN: 60.000 MHz
 RB: 1.000 MHz
 VB: 3.000 MHz
 Detector: POS
 Attn: 0 DB
 RL Offset: 51.4 DB
 Sweep Time: 5.0ms
 Ref Lvl: 20.0 DBM

Comments

Total 26dB BW: 39.198 MHz
 U-NII-2C: 9.659 MHz
 U-NII-3: 29.539 MHz

Cursor 1	5754.5391	16.66		Delta Freq.	39.198
Cursor 2	5715.3407	-9.34		Delta Amplitude	26.00



Client: Nextivity Inc	Job Number: J94664
Model: D32-2/4NU and D32-2/4CU	T-Log Number: T94720
	Account Manager: Christine Krebill
Contact: Michiel Lotter	
Standard: FCC Part 15.247, Part 15.407 and RSS 210	Class: N/A

Run #2: Peak Excursion Measurement

30MHz: Device meets the requirement for the peak excursion

Peak Excursion(dB)			Peak Excursion(dB)			Peak Excursion(dB)		
Freq	Value	Limit	Freq	Value	Limit	Freq	Value	Limit
(MHz)			(MHz)			(MHz)		
5525	10.9	13.0	5580	10.7	13.0	5715	10.5	13.0
5735	10.1	13.0						

40MHz: Device meets the requirement for the peak excursion

Peak Excursion(dB)			Peak Excursion(dB)			Peak Excursion(dB)		
Freq	Value	Limit	Freq	Value	Limit	Freq	Value	Limit
(MHz)			(MHz)			(MHz)		
5525	9.9	13.0	5580	10.1	13.0	5715	10.0	13.0
5735	10.5	13.0						

Client: Nextivity Inc	Job Number: J94664
Model: D32-2/4NU and D32-2/4CU	T-Log Number: T94720
	Account Manager: Christine Krebill
Contact: Michiel Lotter	
Standard: FCC Part 15.247, Part 15.407 and RSS 210	Class: N/A

Worst Case Plots Showing Peak Excursion

Trace A: RBW = 1MHz, VBW = 3MHz, Peak hold

Trace B: Same settings as used for power/PSD measurements (RBW = 1 MHz, VBW = 3MHz, Integrated average power)

CU Ch Freq 5525 MHz @ 30 MHz Bandwidth

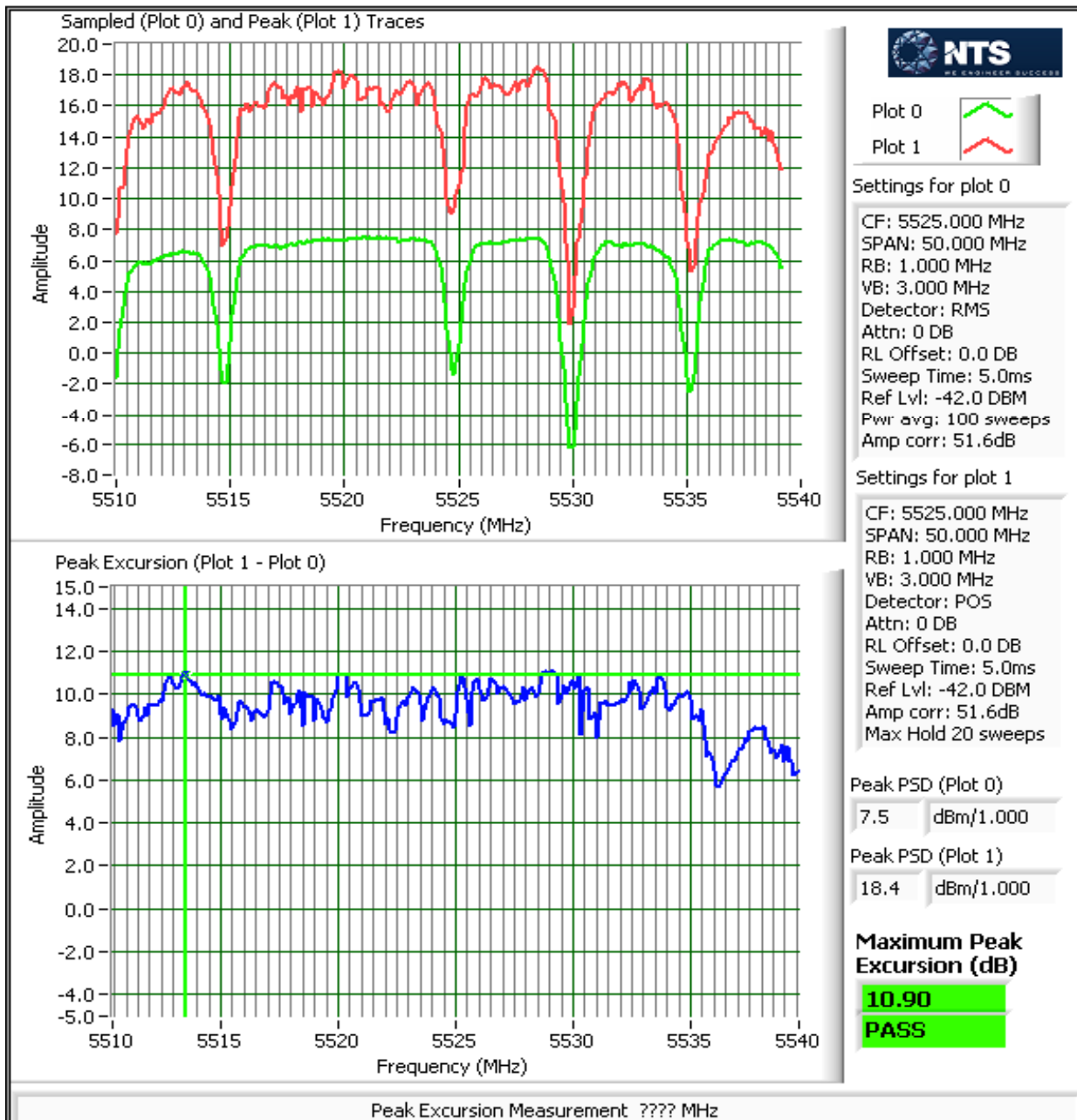

Client: Nextivity Inc	Job Number: J94664
Model: D32-2/4NU and D32-2/4CU	T-Log Number: T94720
	Account Manager: Christine Krebill
Contact: Michiel Lotter	
Standard: FCC Part 15.247, Part 15.407 and RSS 210	Class: N/A

Run #3: TDWR 5600 MHz and 5650 MHz requirement

FCC 15.215 (c) Intentional radiators operating under the alternative provisions to the general emission limits, as contained in §§15.217 through 15.257 and in Subpart E of this part, must be designed to ensure that the 20 dB bandwidth of the emission, or whatever bandwidth may otherwise be specified in the specific rule section under which the equipment operates, is contained within the frequency band designated in the rule section under which the equipment is operated.

Channel Frequency 5580 MHz with 30 MHz Bandwidth

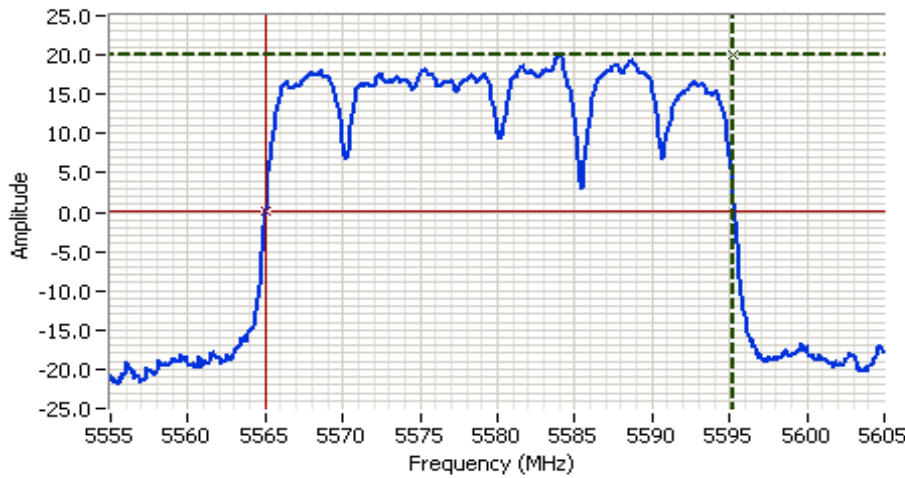

Analyzer Settings

Rohde&Schwarz,ESI
 CF: 5580.000 MHz
 SPAN: 50.000 MHz
 RB: 1.000 MHz
 VB: 3.000 MHz
 Detector: POS
 Attn: 0 DB
 RL Offset: 47.9 DB
 Sweep Time: 5.0ms
 Ref Lvl: 25.0 DBM

Comments

20dB BW: 30.261 MHz
 5580 MHz 30 MHz BW

Cursor 1 5595.2806 20.03
 Cursor 2 5565.0200 0.03

Delta Freq. 30.261
 Delta Amplitude 20.00



Channel Frequency 5580 MHz with 40 MHz Bandwidth

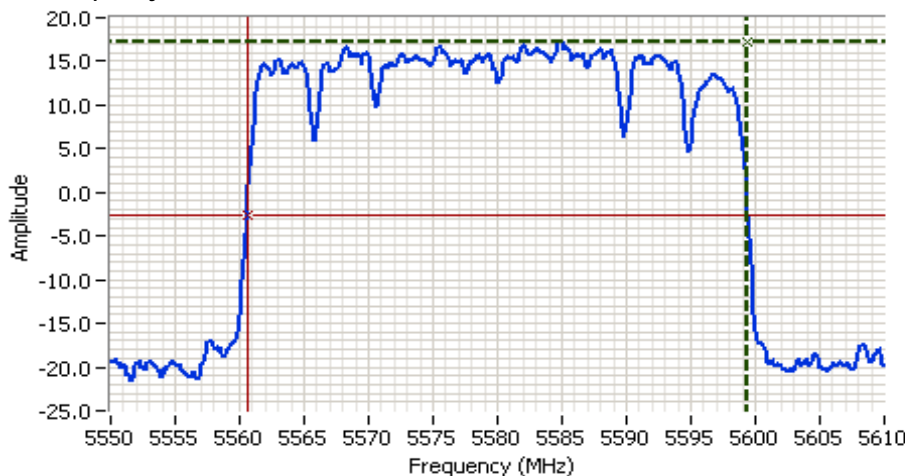

Analyzer Settings

Rohde&Schwarz,ESI
 CF: 5580.000 MHz
 SPAN: 60.000 MHz
 RB: 1.000 MHz
 VB: 3.000 MHz
 Detector: POS
 Attn: 0 DB
 RL Offset: 47.9 DB
 Sweep Time: 5.0ms
 Ref Lvl: 25.0 DBM

Comments

20dB BW: 38.838 MHz
 5580 MHz 40 MHz BW

Cursor 1 5599.4188 17.31
 Cursor 2 5560.5812 -2.69

Delta Freq. 38.838
 Delta Amplitude 20.00



Client: Nextivity Inc	Job Number: J94664
Model: D32-2/4NU and D32-2/4CU	T-Log Number: T94720
	Account Manager: Christine Krebill
Contact: Michiel Lotter	
Standard: FCC Part 15.247, Part 15.407 and RSS 210	Class: N/A

Channel Frequency 5680 MHz with 30 MHz Bandwidth

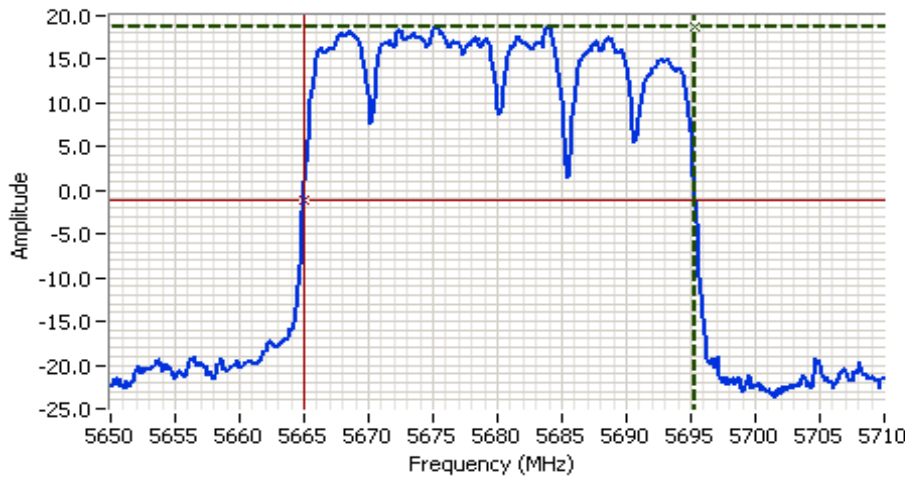

Analyzer Settings

Rohde&Schwarz,ESI
 CF: 5680.000 MHz
 SPAN: 60.000 MHz
 RB: 1.000 MHz
 VB: 3.000 MHz
 Detector: POS
 Attn: 0 DB
 RL Offset: 47.8 DB
 Sweep Time: 5.0ms
 Ref Lvl: 25.0 DBM

Comments

20dB BW: 30.301 MHz
 5680 MHz 30 MHz BW

Cursor 1	5695.3307	18.82	
Cursor 2	5665.0301	-1.18	

Delta Freq. 30.301
 Delta Amplitude 20.00



Channel Frequency 5680 MHz with 40 MHz Bandwidth

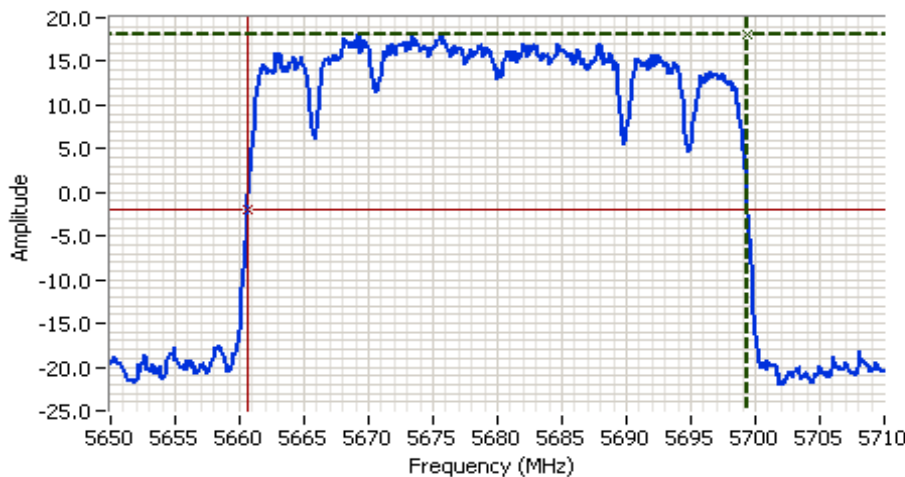

Analyzer Settings

Rohde&Schwarz,ESI
 CF: 5680.000 MHz
 SPAN: 60.000 MHz
 RB: 1.000 MHz
 VB: 3.000 MHz
 Detector: POS
 Attn: 0 DB
 RL Offset: 47.8 DB
 Sweep Time: 5.0ms
 Ref Lvl: 25.0 DBM

Comments

20dB BW: 38.597 MHz
 5680 MHz 40 MHz BW

Cursor 1	5699.2986	18.05	
Cursor 2	5660.7014	-1.95	

Delta Freq. 38.597
 Delta Amplitude 20.00





EMC Test Data

Client: Nextivity Inc	Job Number: J94664
Model: D32-2/4NU and D32-2/4CU	T-Log Number: T94720
	Account Manager: Christine Krebill
Contact: Michiel Lotter	
Standard: FCC Part 15.247, Part 15.407 and RSS 210	Class: N/A

RSS 210 and FCC 15.407 (U-NII) Radiated Spurious Emissions

Test Specific Details

Objective: The objective of this test session is to perform final qualification testing of the EUT with respect to the specification listed above.

General Test Configuration

The EUT and all local support equipment were located on the turntable for radiated spurious emissions testing.

For radiated emissions testing the measurement antenna was located 3 meters from the EUT.

Ambient Conditions:

Temperature: 21-24 °C
 Rel. Humidity: 30-45 %

Summary of Results (U-NII bands)

Run #	Mode	Channel	Software Setting	Measured Power	Test Performed	Limit	Result / Margin
1a U-NII 2C 5470-5725	Proprietary 30 MHz BW	Low 5525 MHz	-	-	Restricted Band Edge 5460 MHz	15.209	41.3 dBµV/m @ 5460.0 MHz (-12.7 dB)
				-	Band Edge 5460 - 5470 MHz	15E	62.4 dBµV/m @ 5470.0 MHz (-5.9 dB)
				-	Radiated Emissions, 30 MHz - 40 GHz	FCC 15.209 / 15 E	35.4 dBµV/m @ 38.84 MHz (-4.6 dB)
		Center 5580 MHz	-	-	Radiated Emissions, 1 - 40 GHz	FCC 15.209 / 15 E	44.2 dBµV/m @ 5373.7 MHz (-9.8 dB)
		High 5735 MHz	-	-	Radiated Emissions, 1 - 40 GHz	FCC 15.209 / 15 E	43.4 dBµV/m @ 5375.1 MHz (-10.6 dB)
1b U-NII 2C 5470-5725	Proprietary 40 MHz BW	Low 5525 MHz	-	-	Restricted Band Edge 5460 MHz	15.209	45.0 dBµV/m @ 5460.0 MHz (-9.0 dB)
				-	Band Edge 5460 - 5470 MHz	15E	64.5 dBµV/m @ 5466.1 MHz (-3.8 dB)
				-	Radiated Emissions, 30 MHz - 40 GHz	FCC 15.209 / 15 E	35.3 dBµV/m @ 38.58 MHz (-4.7 dB)
		Center 5580 MHz	-	-	Radiated Emissions, 1 - 40 GHz	FCC 15.209 / 15 E	44.1 dBµV/m @ 5374.0 MHz (-9.9 dB)
		High 5735 MHz	-	-	Radiated Emissions, 1 - 40 GHz	FCC 15.209 / 15 E	43.3 dBµV/m @ 5373.8 MHz (-10.7 dB)



EMC Test Data

Client: Nextivity Inc	Job Number: J94664
Model: D32-2/4NU and D32-2/4CU	T-Log Number: T94720
	Account Manager: Christine Krebill
Contact: Michiel Lotter	
Standard: FCC Part 15.247, Part 15.407 and RSS 210	Class: N/A

Modifications Made During Testing

No modifications were made to the EUT during testing

Deviations From The Standard

No deviations were made from the requirements of the standard.

Test Procedure Comments:

U-NII Bands

Unless otherwise noted, average measurements above 1GHz were performed as documented in FCC KDB 789033 D01 v01r03 H) 1) c) and H) 2) c) for U-NII band measurements. Per H) 1) d), $E(dB\mu V/m) = EIRP(dBm) + 95.2$ for 3 meters radiated emission measurements

DTS Bands

Unless otherwise noted, average measurements above 1GHz were performed as documented in FCC KDB 558074 D01 v03r01 11 and 13.3.4 for DTS band measurements

Antenna: Connected. Integral antenna

Duty Cycle: 100%

The EUT was located on the turntable for radiated spurious emissions testing. DELL Latitude D830 Laptop and Nextivity Chart Interface (V:2.0.0.2) software was used to configure the EUT. The laptop was not connected during the tests.



EMC Test Data

Client: Nextivity Inc	Job Number: J94664
Model: D32-2/4NU and D32-2/4CU	T-Log Number: T94720
	Account Manager: Christine Krebill
Contact: Michiel Lotter	
Standard: FCC Part 15.247, Part 15.407 and RSS 210	Class: N/A

Run #1, Radiated Spurious Emissions, 30 - 40,000 MHz. Operation in the 5470-5725 MHz Band

Run #1a: Low Channel @ 5525 MHz 30 MHz BW

Date of Test: 3/12/2014

Test Engineer: Jack Liu

Test Location: FT Chamber #7

5460 MHz Restricted Band Edge Radiated Field Strength

Frequency	Level	Pol	FCC 15.209		Detector	Azimuth	Height	Comments
MHz	dB μ V/m	v/h	Limit	Margin	Pk/QP/Avg	degrees	meters	
5460.000	41.3	V	54.0	-12.7	AVG	265	1.0	POS; RB 1 MHz; VB: 10 Hz
5457.600	56.1	V	74.0	-17.9	PK	265	1.0	POS; RB 1 MHz; VB: 3 MHz
5460.000	41.2	H	54.0	-12.8	AVG	297	1.1	POS; RB 1 MHz; VB: 10 Hz
5459.200	54.9	H	74.0	-19.1	PK	297	1.1	POS; RB 1 MHz; VB: 3 MHz

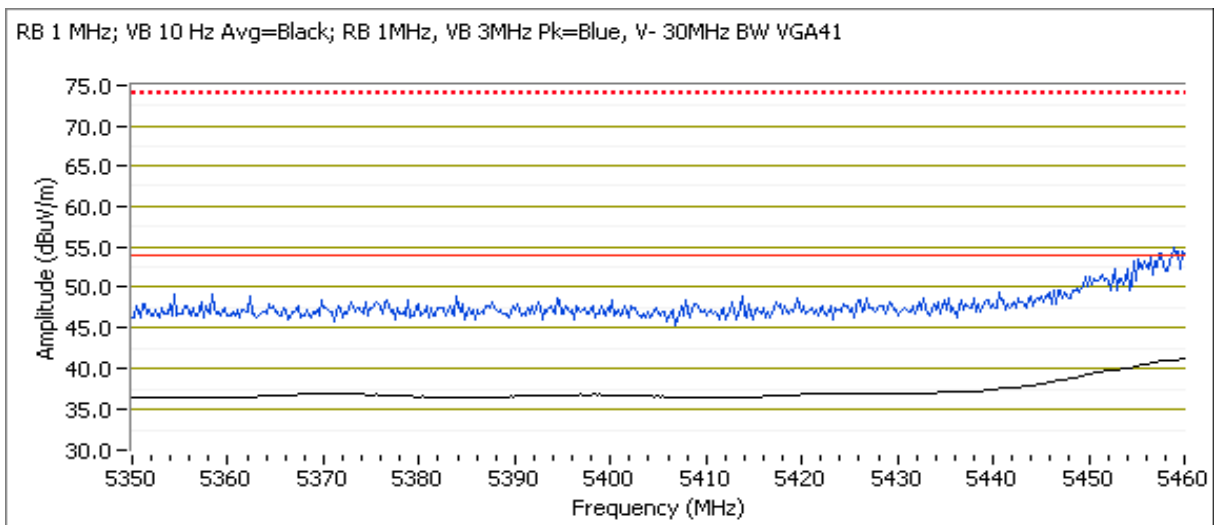



EMC Test Data

Client: Nextivity Inc	Job Number: J94664
Model: D32-2/4NU and D32-2/4CU	T-Log Number: T94720
	Account Manager: Christine Krebill
Contact: Michiel Lotter	
Standard: FCC Part 15.247, Part 15.407 and RSS 210	Class: N/A

Date of Test: 3/12/2014
 Test Engineer: Jack Liu
 Test Location: FT Chamber #7

Low Channel @ 5525 MHz 30 MHz BW
 5460-5470 MHz Band Edge Radiated Field Strength

Frequency MHz	Level dB μ V/m	Pol v/h	FCC 15E		Detector Pk/QP/Avg	Azimuth degrees	Height meters	Comments
			Limit	Margin				
5469.960	62.4	H	68.3	-5.9	PK	298	1.1	POS; RB 1 MHz; VB: 3 MHz
5469.960	62.2	V	68.3	-6.1	PK	263	1.0	POS; RB 1 MHz; VB: 3 MHz

Note 1: For emissions outside of the restricted bands the limit is -27 dBm/MHz eirp (68.3 dBuV/m). The measurement method required is a peak measurement (RB=1 MHz, VB \geq 3 MHz, peak detector). As an alternative, per KDB 789033 D01 v01r03 H) 2) c) (i), An out-of-band emission that complies with both the average and peak limits of 15.209 is not required to satisfy the -27 dBm/MHz limit, compliance can be demonstrated by meeting the average and peak limits of 15.209.

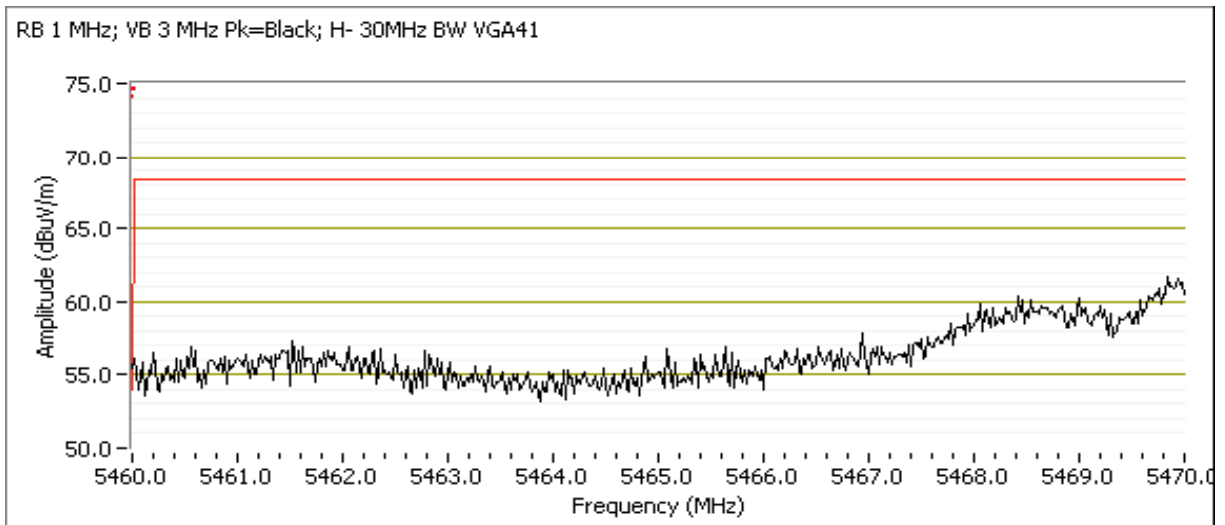

Client: Nextivity Inc	Job Number: J94664
Model: D32-2/4NU and D32-2/4CU	T-Log Number: T94720
	Account Manager: Christine Krebill
Contact: Michiel Lotter	
Standard: FCC Part 15.247, Part 15.407 and RSS 210	Class: N/A

Date of Test: 3/13/14 & 3/14/14, 3/17/14
 Test Engineer: Jack Liu, Deniz Demirci
 Test Location: FT Chamber #7

Low Channel @ 5525 MHz 30 MHz BW

Spurious Radiated Emissions:

Frequency MHz	Level dB μ V/m	Pol v/h	FCC 15.209		Detector Pk/QP/Avg	Azimuth degrees	Height meters	Comments
			Limit	Margin				
38.837	35.4	V	40.0	-4.6	QP	338	1.0	QP (1.00s)
66.005	31.4	V	40.0	-8.6	QP	181	1.0	QP (1.00s)
5376.500	44.2	V	54.0	-9.8	AVG	22	1.5	RB 1 MHz;VB 10 Hz;Peak
5373.800	56.1	V	74.0	-17.9	PK	22	1.5	RB 1 MHz;VB 3 MHz;Peak
5798.580	53.3	H	68.3	-15.0	PK	288	1.5	RB 1 MHz;VB 3 MHz;Peak
31540.210	23.8	H	54.0	-30.2	AVG	146	1.2	Noise floor reading

- Note 1: Emissions in the 30-1000 MHz range are not radio related, they are the same regardless of channel.
- Note 2: Scans made between 18 - 40 GHz with the measurement antenna moved around the card and its antennas 20-50 cm from the device indicated there were no significant emissions in this frequency range
- Note 3: For emissions outside of the restricted bands the limit is -27 dBm/MHz eirp (68.3 dBuV/m). The measurement method required is a peak measurement (RB=1 MHz, VB \geq 3 MHz, peak detector).As an alternative, per KDB 789033 D01 v01r03 H) 2) c) (i), An out-of-band emission that complies with both the average and peak limits of 15.209 is not required to satisfy the -27 dBm/MHz limit, compliance can be demonstrated by meeting the average and peak limits of 15.209.

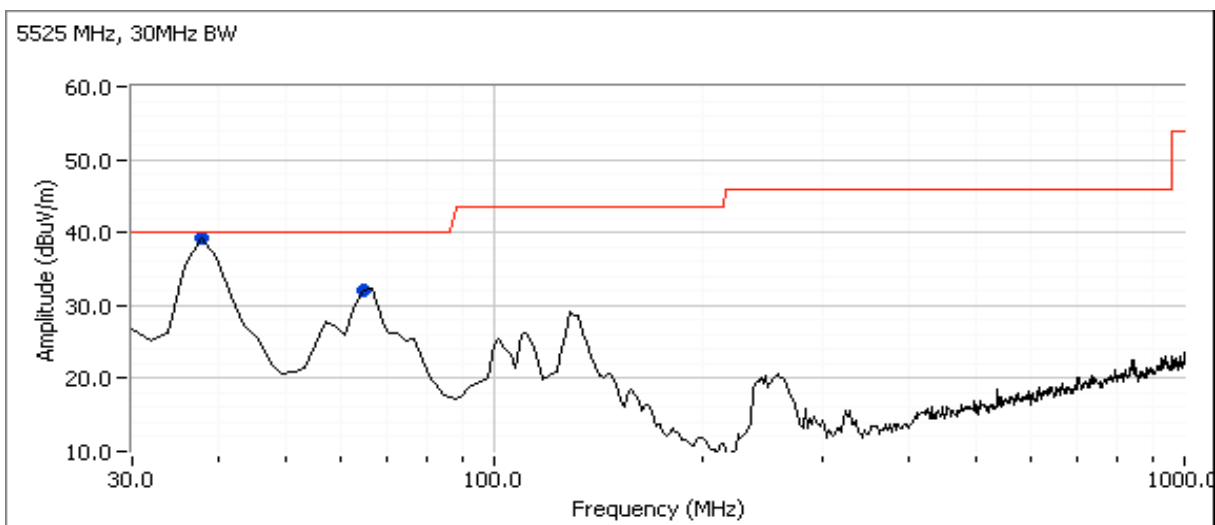

Client: Nextivity Inc	Job Number: J94664
Model: D32-2/4NU and D32-2/4CU	T-Log Number: T94720
	Account Manager: Christine Krebill
Contact: Michiel Lotter	
Standard: FCC Part 15.247, Part 15.407 and RSS 210	Class: N/A

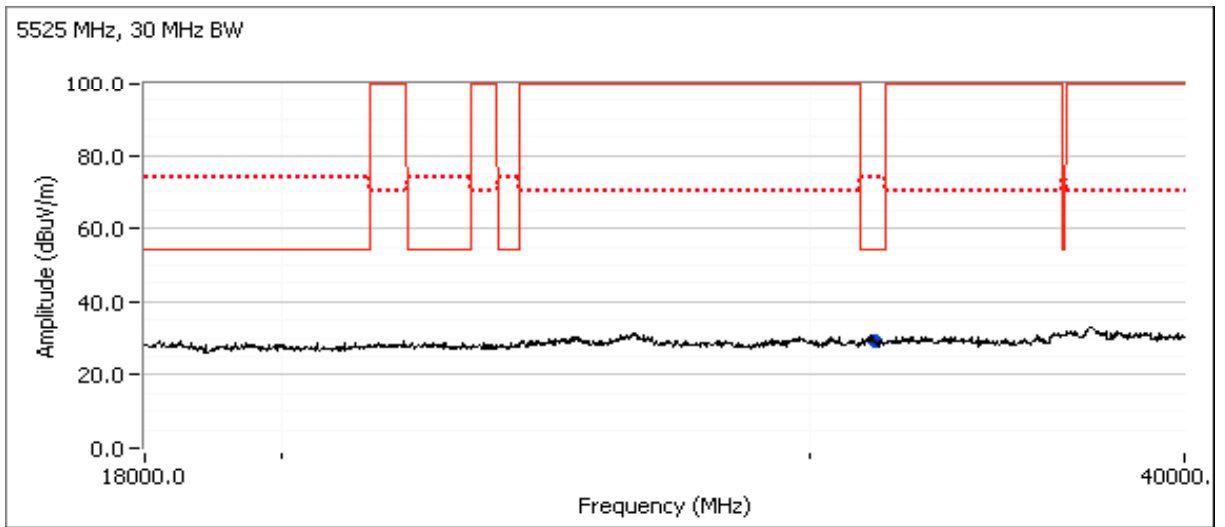
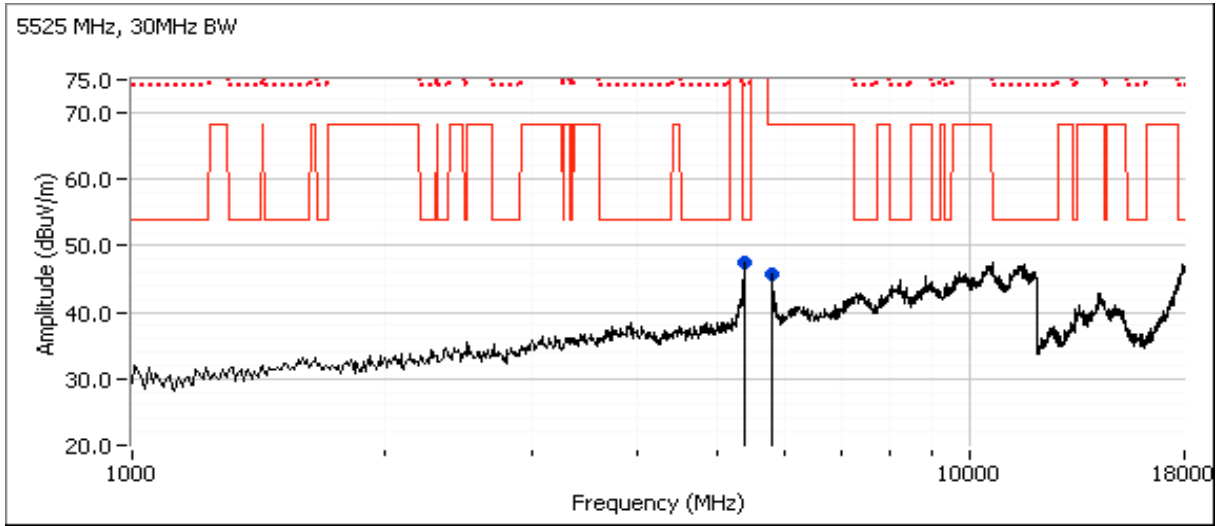

Client: Nextivity Inc	Job Number: J94664
Model: D32-2/4NU and D32-2/4CU	T-Log Number: T94720
	Account Manager: Christine Krebill
Contact: Michiel Lotter	
Standard: FCC Part 15.247, Part 15.407 and RSS 210	Class: N/A

Run #1a: Mid Channel @ 5580 MHz 30 MHz BW
 Date of Test: 3/13/14 & 3/14/14
 Test Engineer: Jack Liu
 Test Location: FT Chamber #7

Spurious Radiated Emissions:

Frequency	Level	Pol	FCC 15.209		Detector	Azimuth	Height	Comments
MHz	dB μ V/m	v/h	Limit	Margin	Pk/QP/Avg	degrees	meters	
5373.720	44.2	H	54.0	-9.8	AVG	52	1.0	RB 1 MHz;VB 10 Hz;Peak
5374.450	55.6	H	74.0	-18.4	PK	52	1.0	RB 1 MHz;VB 3 MHz;Peak
5799.430	53.2	V	68.3	-15.1	PK	148	2.0	RB 1 MHz;VB 3 MHz;Peak

- Note 1: Scans made between 18 - 40 GHz with the measurement antenna moved around the card and its antennas 20-50 cm from the device indicated there were no significant emissions in this frequency range
- Note 2: For emissions outside of the restricted bands the limit is -27 dBm/MHz eirp (68.3 dB μ V/m). The measurement method required is a peak measurement (RB=1 MHz, VB \geq 3 MHz, peak detector).As an alternative, per KDB 789033 D01 v01r03 H) 2) c) (i), An out-of-band emission that complies with both the average and peak limits of 15.209 is not required to satisfy the -27 dBm/MHz limit, compliance can be demonstrated by meeting the average and peak limits of 15.209.

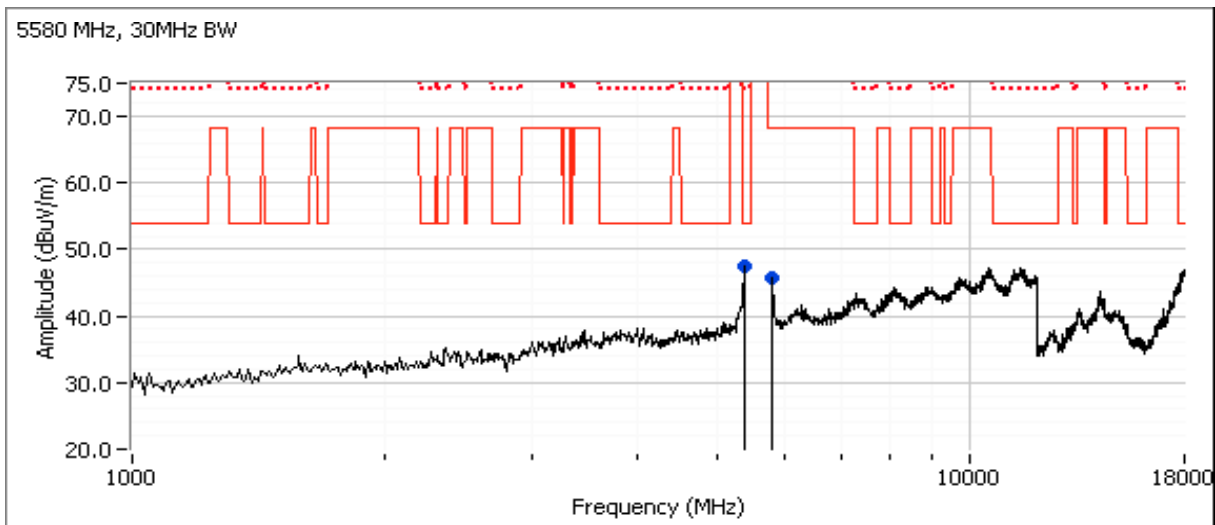

Client: Nextivity Inc	Job Number: J94664
Model: D32-2/4NU and D32-2/4CU	T-Log Number: T94720
	Account Manager: Christine Krebill
Contact: Michiel Lotter	
Standard: FCC Part 15.247, Part 15.407 and RSS 210	Class: N/A

Run #1a: High Channel @ 5735 MHz 30 MHz BW
 Date of Test: 3/14/2014
 Test Engineer: Jack Liu
 Test Location: FT Chamber #7

Spurious Radiated Emissions:

Frequency	Level	Pol	FCC 15.209		Detector	Azimuth	Height	Comments
MHz	dB μ V/m	v/h	Limit	Margin	PK/QP/Avg	degrees	meters	
5375.140	43.4	V	54.0	-10.6	AVG	172	1.9	RB 1 MHz;VB 10 Hz;Peak
5374.360	54.5	V	74.0	-19.5	PK	172	1.9	RB 1 MHz;VB 3 MHz;Peak
5974.400	53.5	V	68.3	-14.8	PK	196	2.5	RB 1 MHz;VB 3 MHz;Peak

Note 2: Scans made between 18 - 40 GHz with the measurement antenna moved around the card and its antennas 20-50 cm from the device indicated there were no significant emissions in this frequency range

Note 3: Emission Bandwidth of Center frequency of 5735 MHz channel extend across 5725 MHz band edge for U-NII 2C, therefore FCC 15.407 U-NII band rules apply for this channel per KDB 644545 D01 v01r02. Hence, band edge requirement does not apply.

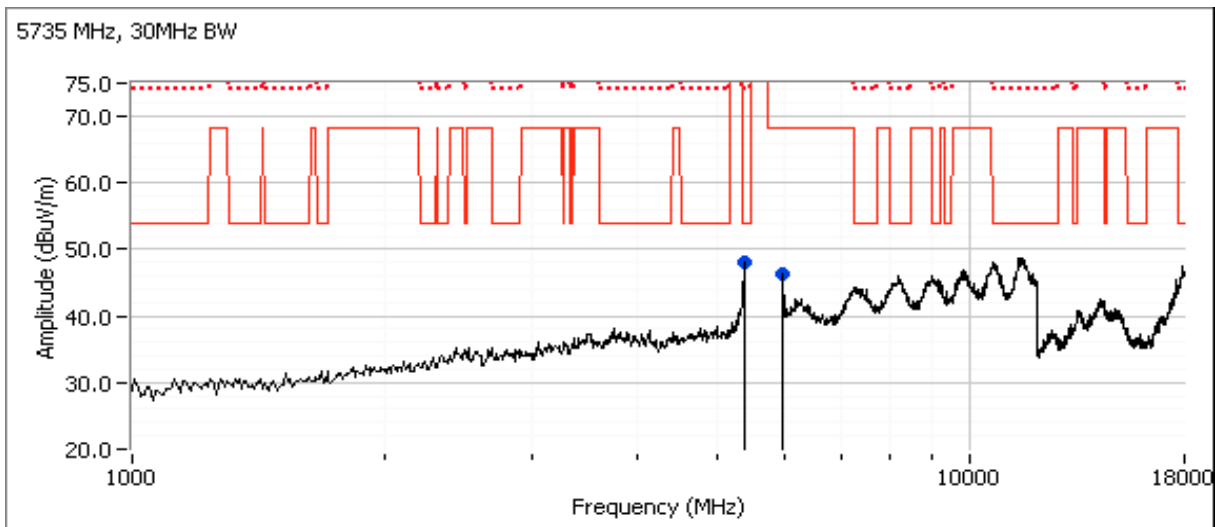



EMC Test Data

Client: Nextivity Inc	Job Number: J94664
Model: D32-2/4NU and D32-2/4CU	T-Log Number: T94720
	Account Manager: Christine Krebill
Contact: Michiel Lotter	
Standard: FCC Part 15.247, Part 15.407 and RSS 210	Class: N/A

Run #1b: Low Channel @ 5525 MHz 40 MHz BW

Date of Test: 3/12/2014
 Test Engineer: Jack Liu
 Test Location: FT Chamber #7

5460 MHz Restricted Band Edge Radiated Field Strength

Frequency MHz	Level dB μ V/m	Pol v/h	FCC 15.209		Detector Pk/QP/Avg	Azimuth degrees	Height meters	Comments
			Limit	Margin				
5460.000	45.0	V	54.0	-9.0	AVG	256	1.0	POS; RB 1 MHz; VB: 10 Hz
5458.720	59.8	V	74.0	-14.2	PK	256	1.0	POS; RB 1 MHz; VB: 3 MHz
5460.000	44.2	H	54.0	-9.8	AVG	299	1.1	POS; RB 1 MHz; VB: 10 Hz
5458.560	59.4	H	74.0	-14.6	PK	299	1.1	POS; RB 1 MHz; VB: 3 MHz

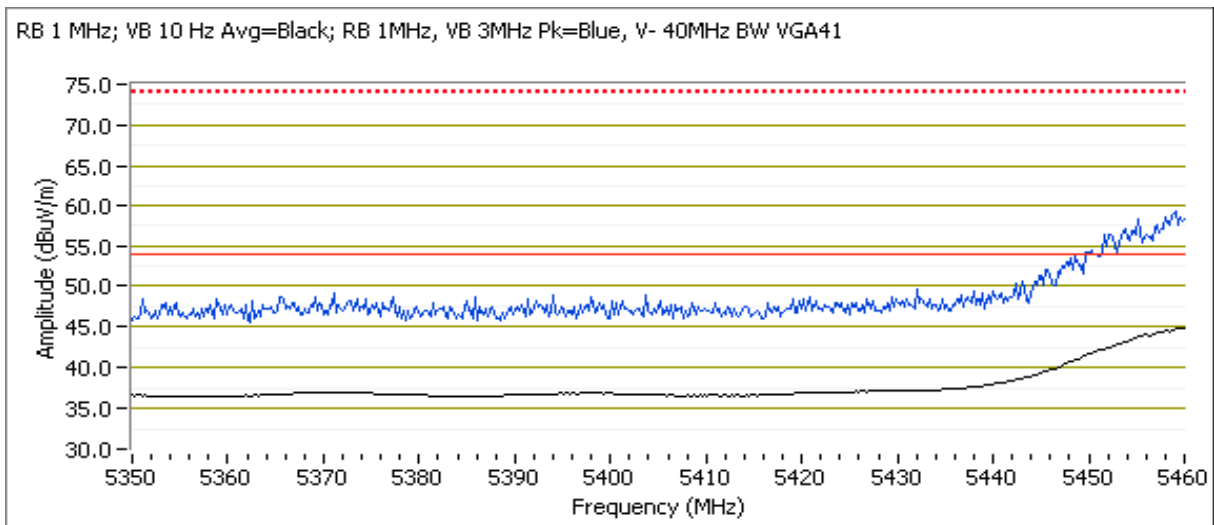



EMC Test Data

Client: Nextivity Inc	Job Number: J94664
Model: D32-2/4NU and D32-2/4CU	T-Log Number: T94720
	Account Manager: Christine Krebill
Contact: Michiel Lotter	
Standard: FCC Part 15.247, Part 15.407 and RSS 210	Class: N/A

Date of Test: 3/12/2014
 Test Engineer: Jack Liu
 Test Location: FT Chamber #7

Low Channel @ 5525 MHz 40 MHz BW
 5460-5470 MHz Band Edge Radiated Field Strength

Frequency MHz	Level dB μ V/m	Pol v/h	FCC 15.209		Detector Pk/QP/Avg	Azimuth degrees	Height meters	Comments
			Limit	Margin				
5466.110	64.5	V	68.3	-3.8	PK	263	1.0	POS; RB 1 MHz; VB: 3 MHz
5469.960	63.8	H	68.3	-4.5	PK	299	1.1	POS; RB 1 MHz; VB: 3 MHz

Note 1: For emissions outside of the restricted bands the limit is -27 dBm/MHz eirp (68.3 dBuV/m). The measurement method required is a peak measurement (RB=1 MHz, VB \geq 3 MHz, peak detector). As an alternative, per KDB 789033 D01 v01r03 H) 2) c) (i), An out-of-band emission that complies with both the average and peak limits of 15.209 is not required to satisfy the -27 dBm/MHz limit, compliance can be demonstrated by meeting the average and peak limits of 15.209.

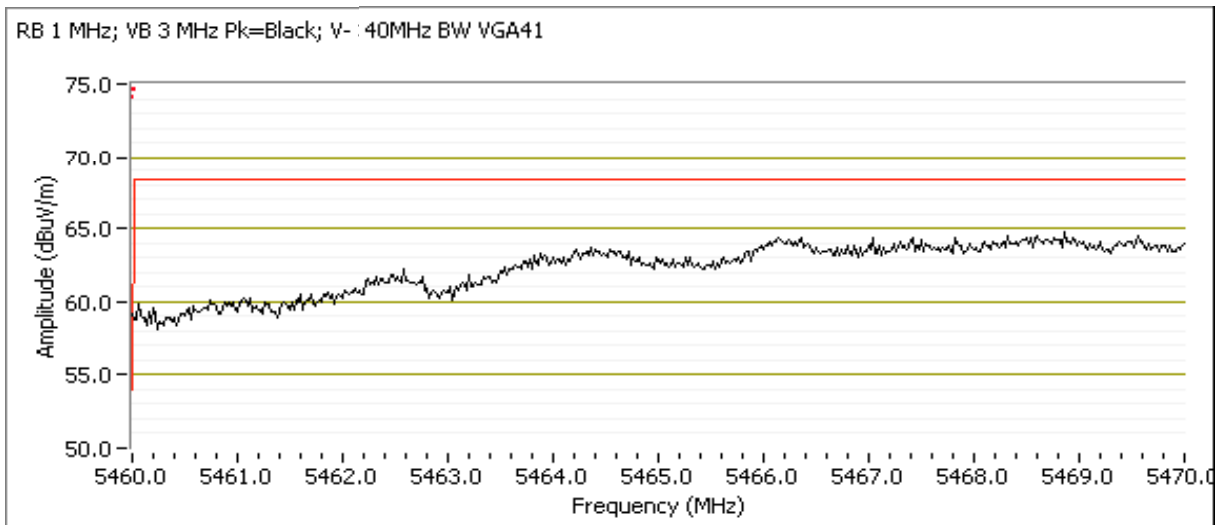

Client: Nextivity Inc	Job Number: J94664
Model: D32-2/4NU and D32-2/4CU	T-Log Number: T94720
	Account Manager: Christine Krebill
Contact: Michiel Lotter	
Standard: FCC Part 15.247, Part 15.407 and RSS 210	Class: N/A

Date of Test: 3/13/14, 3/14/14, 3/17/14
 Test Engineer: Jack Liu / R. Varelas / Deniz Demirci
 Test Location: FT Chamber #7

Low Channel @ 5525 MHz 40 MHz BW

Spurious Radiated Emissions:

Frequency MHz	Level dB μ V/m	Pol v/h	FCC 15.209		Detector Pk/QP/Avg	Azimuth degrees	Height meters	Comments
			Limit	Margin				
38.581	35.3	V	40.0	-4.7	QP	302	1.0	QP (1.00s)
63.361	31.2	V	40.0	-8.8	QP	174	1.2	QP (1.00s)
5373.500	44.1	H	54.0	-9.9	AVG	260	1.5	RB 1 MHz;VB 10 Hz;Peak
5375.710	55.3	H	74.0	-18.7	PK	260	1.5	RB 1 MHz;VB 3 MHz;Peak
5799.040	54.2	V	68.3	-14.1	PK	52	1.0	RB 1 MHz;VB 3 MHz;Peak
31426.760	23.9	V	54.0	-30.1	AVG	340	1.0	Noise floor reading

Note 1: Emissions in the 30-1000 MHz range are not radio related, they are the same regardless of channel.

Note 2: Scans made between 18 - 40 GHz with the measurement antenna moved around the card and its antennas 20-50 cm from the device indicated there were no significant emissions in this frequency range

Note 3: For emissions outside of the restricted bands the limit is -27 dBm/MHz eirp (68.3 dBuV/m). The measurement method required is a peak measurement (RB=1 MHz, VB \geq 3 MHz, peak detector).As an alternative, per KDB 789033 D01 v01r03 H) 2) c) (i), An out-of-band emission that complies with both the average and peak limits of 15.209 is not required to satisfy the -27 dBm/MHz limit, compliance can be demonstrated by meeting the average and peak limits of 15.209.

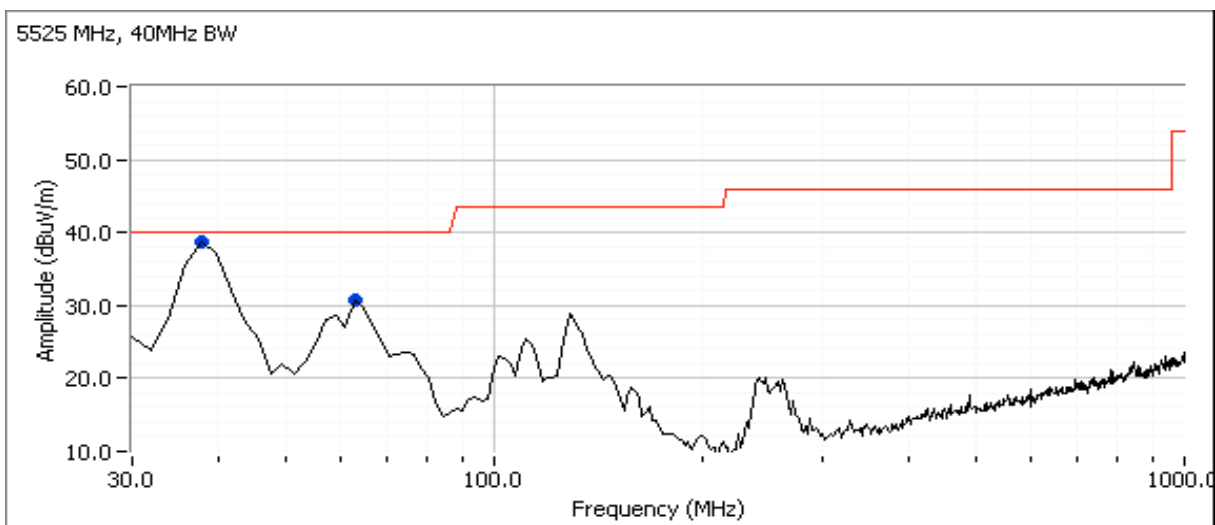

Client: Nextivity Inc	Job Number: J94664
Model: D32-2/4NU and D32-2/4CU	T-Log Number: T94720
	Account Manager: Christine Krebill
Contact: Michiel Lotter	
Standard: FCC Part 15.247, Part 15.407 and RSS 210	Class: N/A

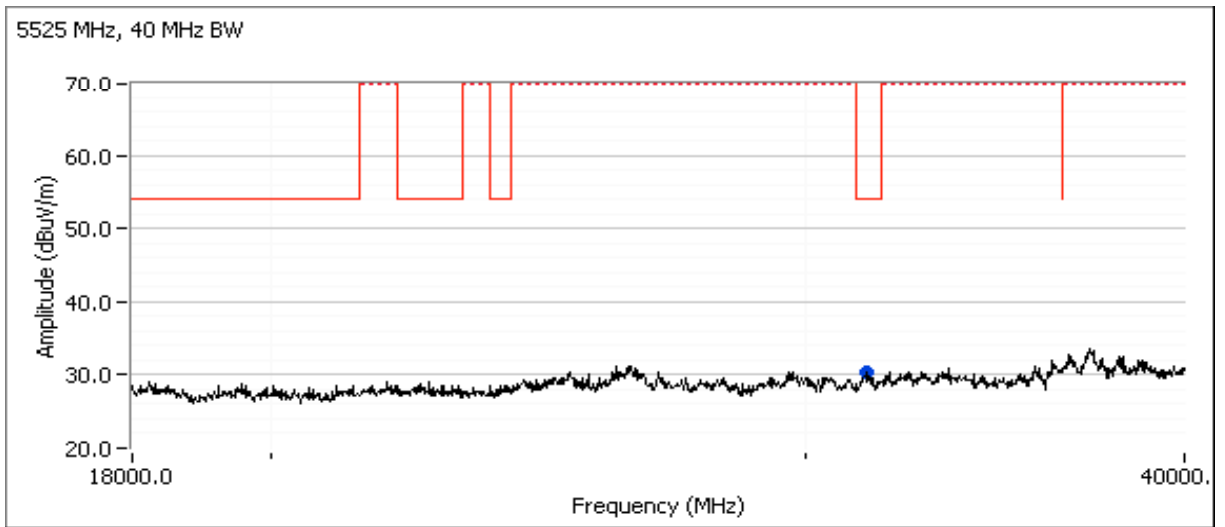
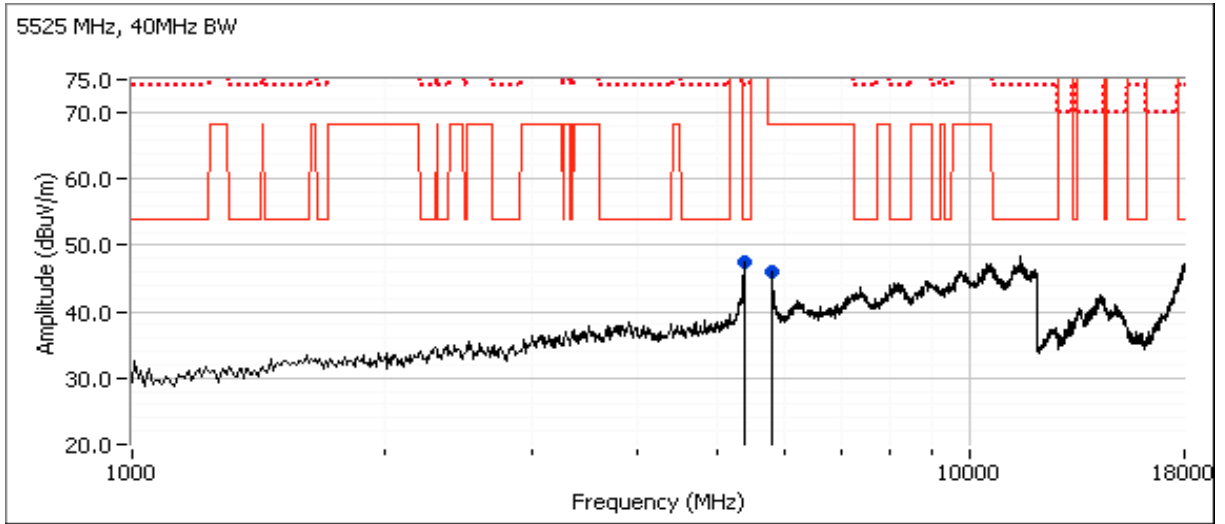

Client: Nextivity Inc	Job Number: J94664
Model: D32-2/4NU and D32-2/4CU	T-Log Number: T94720
	Account Manager: Christine Krebill
Contact: Michiel Lotter	
Standard: FCC Part 15.247, Part 15.407 and RSS 210	Class: N/A

Run #1b: Mid Channel @ 5580 MHz 40 MHz BW
 Date of Test: 3/13/2014
 Test Engineer: Jack Liu / R. Varelas
 Test Location: FT Chamber #7

Spurious Radiated Emissions:

Frequency	Level	Pol	FCC 15.209		Detector	Azimuth	Height	Comments
MHz	dB μ V/m	v/h	Limit	Margin	Pk/QP/Avg	degrees	meters	
5374.040	44.1	H	54.0	-9.9	AVG	348	2.5	RB 1 MHz;VB 10 Hz;Peak
5374.190	55.3	H	74.0	-18.7	PK	348	2.5	RB 1 MHz;VB 3 MHz;Peak
5800.400	53.4	H	68.3	-14.9	PK	46	1.5	RB 1 MHz;VB 3 MHz;Peak

- Note 1: Scans made between 18 - 40 GHz with the measurement antenna moved around the card and its antennas 20-50 cm from the device indicated there were no significant emissions in this frequency range
- Note 2: For emissions outside of the restricted bands the limit is -27 dBm/MHz eirp (68.3 dB μ V/m). The measurement method required is a peak measurement (RB=1 MHz, VB \geq 3 MHz, peak detector).As an alternative, per KDB 789033 D01 v01r03 H) 2) c) (i), An out-of-band emission that complies with both the average and peak limits of 15.209 is not required to satisfy the -27 dBm/MHz limit, compliance can be demonstrated by meeting the average and peak limits of 15.209.

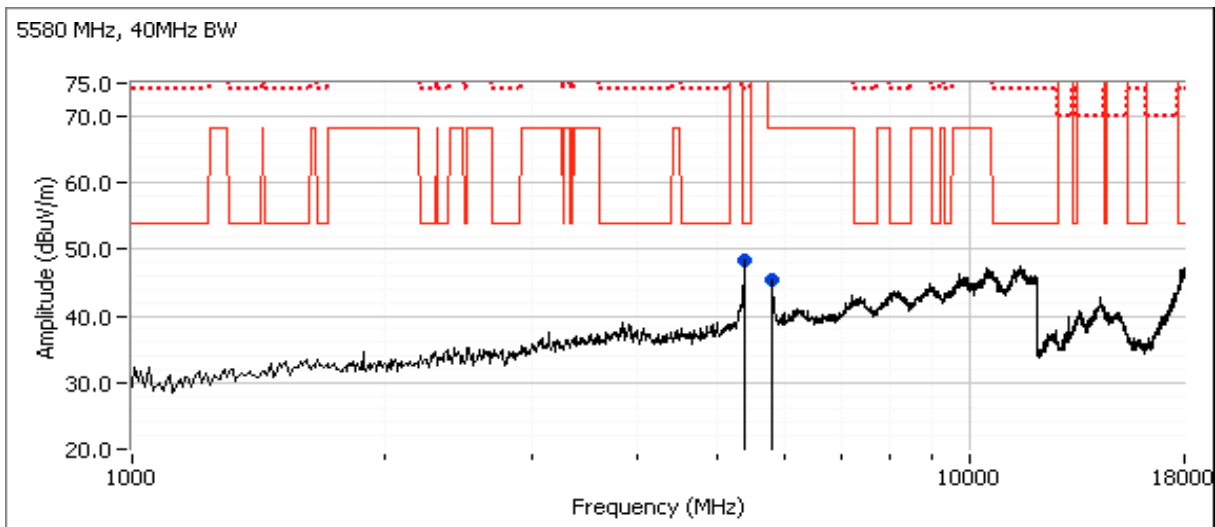

Client: Nextivity Inc	Job Number: J94664
Model: D32-2/4NU and D32-2/4CU	T-Log Number: T94720
	Account Manager: Christine Krebill
Contact: Michiel Lotter	
Standard: FCC Part 15.247, Part 15.407 and RSS 210	Class: N/A

Run #1b: High Channel @ 5735 MHz 40 MHz BW

Date of Test: 3/14/2014

Test Engineer: Jack Liu

Test Location: FT Chamber #7

Spurious Radiated Emissions:

Frequency	Level	Pol	FCC 15.209		Detector	Azimuth	Height	Comments
MHz	dB μ V/m	v/h	Limit	Margin	Pk/QP/Avg	degrees	meters	
5373.790	43.3	V	54.0	-10.7	AVG	168	1.6	RB 1 MHz;VB 10 Hz;Peak
5374.580	54.8	V	74.0	-19.2	PK	168	1.6	RB 1 MHz;VB 3 MHz;Peak
5974.270	52.8	H	68.3	-15.5	PK	302	1.9	RB 1 MHz;VB 3 MHz;Peak

Note 1: Scans made between 18 - 40 GHz with the measurement antenna moved around the card and its antennas 20-50 cm from the device indicated there were no significant emissions in this frequency range

Note 2: Emission Bandwidth of Center frequency of 5735 MHz channel extend across 5725 MHz band edge for U-NII 2C, therefore FCC 15.407 U-NII band rules apply for this channel per KDB 644545 D01 v01r02. Hence, band edge requirement does not apply.

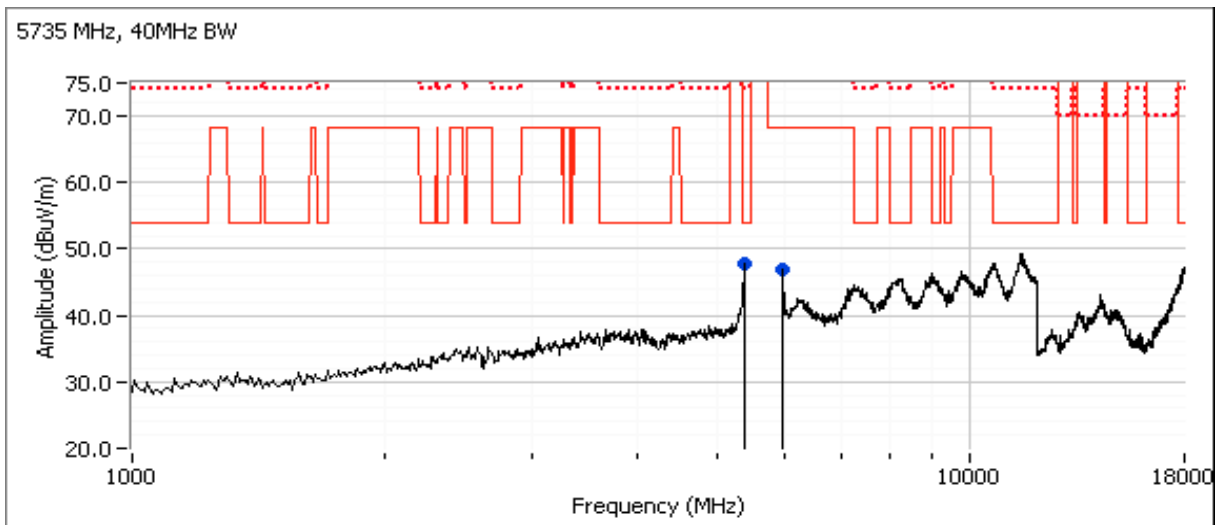



EMC Test Data

Client: Nextivity Inc	Job Number: J94664
Model: D32-2/4NU and D32-2/4CU	T-Log Number: T94720
	Project Manager: Christine Krebill
Contact: Michiel Lotter	Project Coordinator: -
Standard: FCC Part 15.247, Part 15.407 and RSS 210	Class: B

Conducted Emissions

(Elliott Laboratories Fremont Facility, Semi-Anechoic Chamber)

Test Specific Details

Objective: The objective of this test session is to perform final qualification testing of the EUT with respect to the specification listed above.

Date of Test: 3/19/2014	Config. Used: 1
Test Engineer: Deniz Demirci	Config Change: None
Test Location: Fremont Chamber #7	EUT Voltage: 120V/60Hz

General Test Configuration

For tabletop equipment, the EUT was located on a wooden table inside the semi-anechoic chamber, 40 cm from a vertical coupling plane and 80 cm from the LISN. A second LISN was used for all local support equipment. Remote support equipment was located outside of the semi-anechoic chamber. Cables running to remote support equipment were routed through metal conduit and passed through a ferrite clamp upon exiting the chamber.

Ambient Conditions: Temperature: 21-23 °C
 Rel. Humidity: 30-45 %

Summary of Results

Run #	Test Performed	Limit	Result	Margin
1	Network Unit (Window Unit) CE, AC Power, 120V/60Hz	Class B	Pass	37.3 dBµV @ 0.157 MHz (-18.3 dB)

Modifications Made During Testing

No modifications were made to the EUT during testing

Deviations From The Standard

No deviations were made from the requirements of the standard.

Client: Nextivity Inc	Job Number: J94664
Model: D32-2/4NU and D32-2/4CU	T-Log Number: T94720
	Project Manager: Christine Krebill
Contact: Michiel Lotter	Project Coordinator: -
Standard: FCC Part 15.247, Part 15.407 and RSS 210	Class: B

Run #1: AC Power Port Conducted Emissions, 0.15 - 30MHz, 120V/60Hz

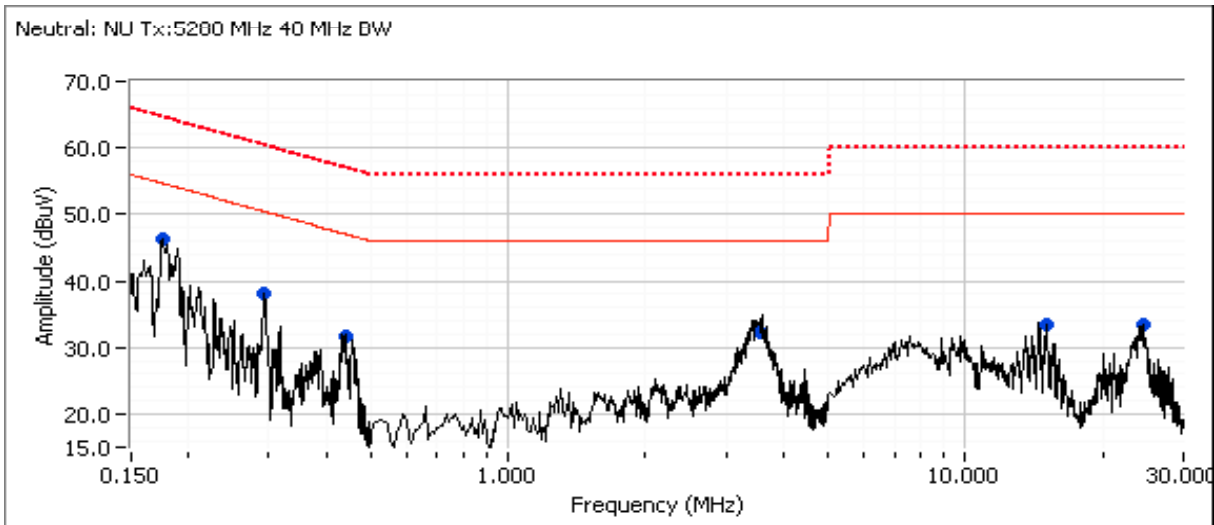
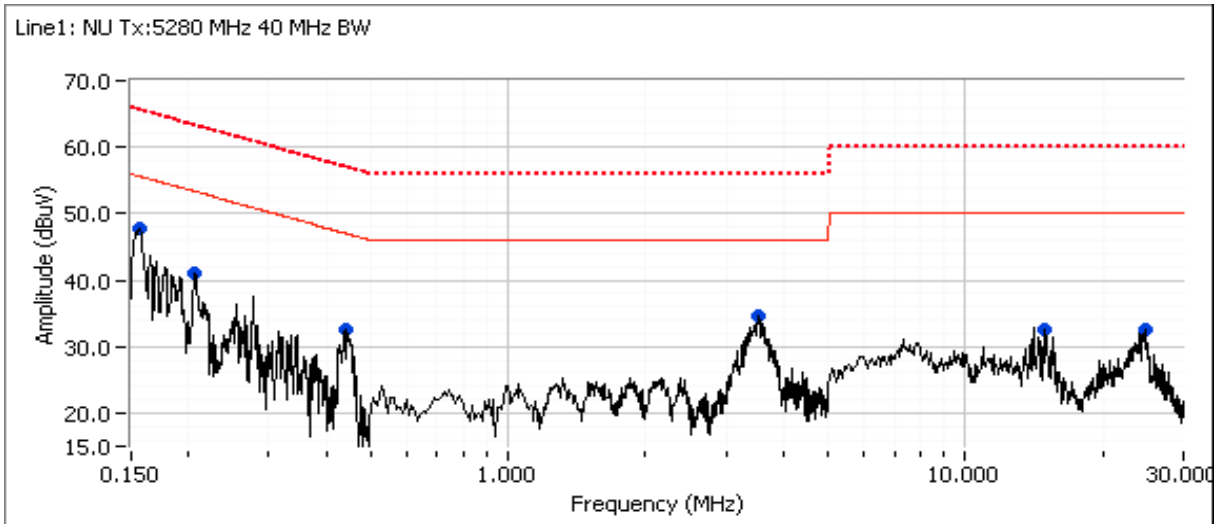



EMC Test Data

Client: Nextivity Inc	Job Number: J94664
Model: D32-2/4NU and D32-2/4CU	T-Log Number: T94720
	Project Manager: Christine Krebill
Contact: Michiel Lotter	Project Coordinator: -
Standard: FCC Part 15.247, Part 15.407 and RSS 210	Class: B

Preliminary peak readings captured during pre-scan (peak readings vs. average limit)

Frequency MHz	Level dB μ V	AC Line	Class B		Detector QP/Ave	Comments
			Limit	Margin		
0.157	47.9	Line 1	55.6	-7.7	Peak	
0.206	41.0	Line 1	53.3	-12.3	Peak	
0.443	32.6	Line 1	47.0	-14.4	Peak	
3.527	34.7	Line 1	46.0	-11.3	Peak	
14.895	32.5	Line 1	50.0	-17.5	Peak	
24.721	32.5	Line 1	50.0	-17.5	Peak	
0.176	46.3	Neutral	54.7	-8.4	Peak	
0.293	38.0	Neutral	50.4	-12.4	Peak	
0.441	31.6	Neutral	47.0	-15.4	Peak	
3.566	32.4	Neutral	46.0	-13.6	Peak	
15.020	33.4	Neutral	50.0	-16.6	Peak	
24.489	33.5	Neutral	50.0	-16.5	Peak	



EMC Test Data

Client: Nextivity Inc	Job Number: J94664
Model: D32-2/4NU and D32-2/4CU	T-Log Number: T94720
	Project Manager: Christine Krebill
Contact: Michiel Lotter	Project Coordinator: -
Standard: FCC Part 15.247, Part 15.407 and RSS 210	Class: B

Final quasi-peak and average readings

Frequency MHz	Level dB μ V	AC Line	Class B		Detector QP/Ave	Comments
			Limit	Margin		
0.157	37.3	Line 1	55.6	-18.3	AVG	AVG (0.10s)
0.157	46.1	Line 1	65.6	-19.5	QP	QP (1.00s)
3.558	26.2	Neutral	46.0	-19.8	AVG	AVG (0.10s)
3.527	26.0	Line 1	46.0	-20.0	AVG	AVG (0.10s)
0.443	24.4	Line 1	47.0	-22.6	AVG	AVG (0.10s)
0.442	23.8	Neutral	47.0	-23.2	AVG	AVG (0.10s)
0.176	31.1	Neutral	54.7	-23.6	AVG	AVG (0.10s)
0.176	41.1	Neutral	64.7	-23.6	QP	QP (1.00s)
3.527	32.2	Line 1	56.0	-23.8	QP	QP (1.00s)
3.558	32.2	Neutral	56.0	-23.8	QP	QP (1.00s)
0.206	29.3	Line 1	53.4	-24.1	AVG	AVG (0.10s)
0.206	39.0	Line 1	63.4	-24.4	QP	QP (1.00s)
0.443	32.2	Line 1	57.0	-24.8	QP	QP (1.00s)
0.442	31.5	Neutral	57.0	-25.5	QP	QP (1.00s)
14.987	22.8	Neutral	50.0	-27.2	AVG	AVG (0.10s)
24.538	21.9	Neutral	50.0	-28.1	AVG	AVG (0.10s)
24.721	20.5	Line 1	50.0	-29.5	AVG	AVG (0.10s)
14.987	30.5	Neutral	60.0	-29.5	QP	QP (1.00s)
14.895	20.3	Line 1	50.0	-29.7	AVG	AVG (0.10s)
0.294	20.3	Neutral	50.4	-30.1	AVG	AVG (0.10s)
0.294	30.0	Neutral	60.4	-30.4	QP	QP (1.00s)
24.538	28.6	Neutral	60.0	-31.4	QP	QP (1.00s)
14.895	28.2	Line 1	60.0	-31.8	QP	QP (1.00s)
24.721	27.6	Line 1	60.0	-32.4	QP	QP (1.00s)



EMC Test Data

Client: Nextivity Inc	Job Number: J94664
Model: D32-2/4NU and D32-2/4CU	T-Log Number: T94720
	Project Manager: Christine Krebill
Contact: Michiel Lotter	Project Coordinator: -
Standard: FCC Part 15.247, Part 15.407 and RSS 210	Class: B

Conducted Emissions

(Elliott Laboratories Fremont Facility, Semi-Anechoic Chamber)

Test Specific Details

Objective: The objective of this test session is to perform final qualification testing of the EUT with respect to the specification listed above.

Date of Test: 3/19/2014	Config. Used: 1
Test Engineer: Deniz Demirci	Config Change: None
Test Location: Fremont Chamber #7	EUT Voltage: 120V/60Hz

General Test Configuration

For tabletop equipment, the EUT was located on a wooden table inside the semi-anechoic chamber, 40 cm from a vertical coupling plane and 80 cm from the LISN. A second LISN was used for all local support equipment. Remote support equipment was located outside of the semi-anechoic chamber. Cables running to remote support equipment were routed through metal conduit and passed through a ferrite clamp upon exiting the chamber.

Ambient Conditions: Temperature: 21-23 °C
 Rel. Humidity: 30-45 %

Summary of Results

Run #	Test Performed	Limit	Result	Margin
1	Coverage Unit CE, AC Power, 120V/60Hz	Class B	Pass	27.1 dBµV @ 3.535 MHz (-18.9 dB)

Modifications Made During Testing

No modifications were made to the EUT during testing

Deviations From The Standard

No deviations were made from the requirements of the standard.

Client: Nextivity Inc	Job Number: J94664
Model: D32-2/4NU and D32-2/4CU	T-Log Number: T94720
	Project Manager: Christine Krebill
Contact: Michiel Lotter	Project Coordinator: -
Standard: FCC Part 15.247, Part 15.407 and RSS 210	Class: B

Run #1: AC Power Port Conducted Emissions, 0.15 - 30MHz, 120V/60Hz

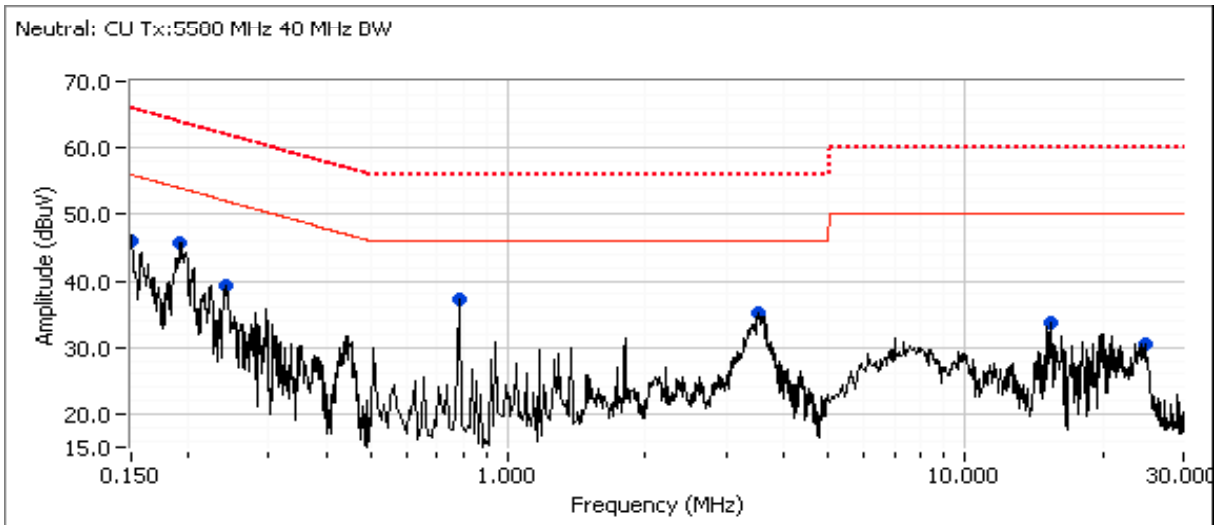
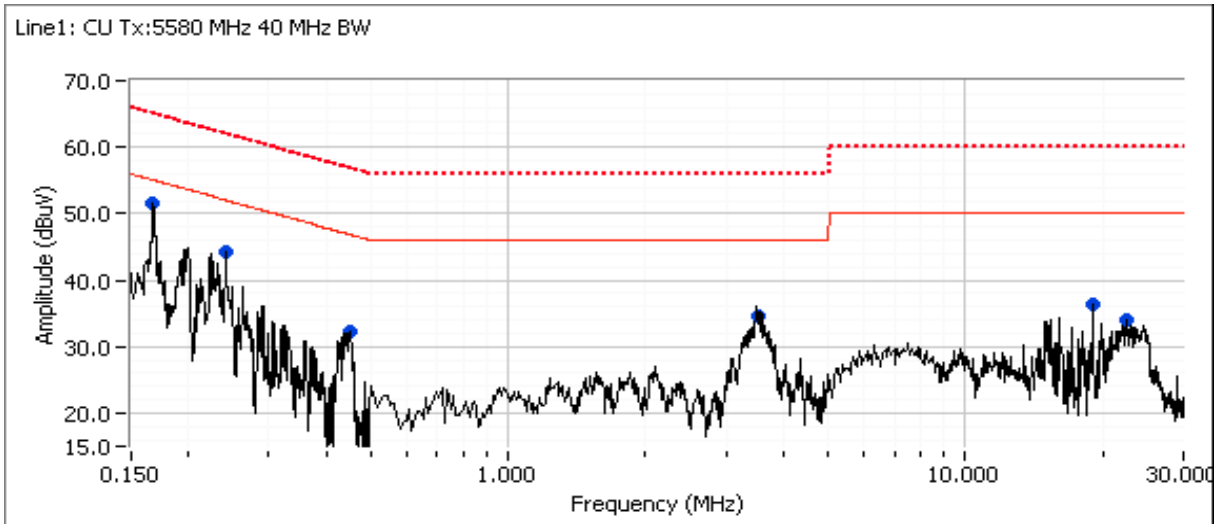



EMC Test Data

Client: Nextivity Inc	Job Number: J94664
Model: D32-2/4NU and D32-2/4CU	T-Log Number: T94720
	Project Manager: Christine Krebill
Contact: Michiel Lotter	Project Coordinator: -
Standard: FCC Part 15.247, Part 15.407 and RSS 210	Class: B

Preliminary peak readings captured during pre-scan (peak readings vs. average limit)

Frequency MHz	Level dB μ V	AC Line	Class B		Detector QP/Ave	Comments
			Limit	Margin		
0.168	51.5	Line 1	55.1	-3.6	Peak	
0.242	44.2	Line 1	52.0	-7.8	Peak	
0.450	32.2	Line 1	46.9	-14.7	Peak	
3.539	34.6	Line 1	46.0	-11.4	Peak	
18.978	36.4	Line 1	50.0	-13.6	Peak	
22.435	34.1	Line 1	50.0	-15.9	Peak	
0.151	45.9	Neutral	56.0	-10.1	Peak	
0.192	45.6	Neutral	53.9	-8.3	Peak	
0.241	39.2	Neutral	52.1	-12.9	Peak	
0.780	37.2	Neutral	46.0	-8.8	Peak	
3.539	35.2	Neutral	46.0	-10.8	Peak	
15.321	33.7	Neutral	50.0	-16.3	Peak	
24.739	30.4	Neutral	50.0	-19.6	Peak	



EMC Test Data

Client: Nextivity Inc	Job Number: J94664
Model: D32-2/4NU and D32-2/4CU	T-Log Number: T94720
	Project Manager: Christine Krebill
Contact: Michiel Lotter	Project Coordinator: -
Standard: FCC Part 15.247, Part 15.407 and RSS 210	Class: B

Final quasi-peak and average readings

Frequency MHz	Level dB μ V	AC Line	Class B		Detector QP/Ave	Comments
			Limit	Margin		
3.535	27.1	Neutral	46.0	-18.9	AVG	AVG (0.10s)
0.167	36.1	Line 1	55.1	-19.0	AVG	AVG (0.10s)
3.542	26.9	Line 1	46.0	-19.1	AVG	AVG (0.10s)
0.191	44.8	Neutral	64.0	-19.2	QP	QP (1.00s)
0.242	42.6	Neutral	62.0	-19.4	QP	QP (1.00s)
0.151	46.4	Neutral	65.9	-19.5	QP	QP (1.00s)
0.191	34.4	Neutral	54.0	-19.6	AVG	AVG (0.10s)
0.167	45.3	Line 1	65.1	-19.8	QP	QP (1.00s)
0.151	34.7	Neutral	55.9	-21.2	AVG	AVG (0.10s)
3.535	33.3	Neutral	56.0	-22.7	QP	QP (1.00s)
3.542	33.1	Line 1	56.0	-22.9	QP	QP (1.00s)
0.449	23.7	Line 1	46.9	-23.2	AVG	AVG (0.10s)
0.242	36.9	Line 1	62.0	-25.1	QP	QP (1.00s)
0.449	31.2	Line 1	56.9	-25.7	QP	QP (1.00s)
0.242	26.0	Line 1	52.0	-26.0	AVG	AVG (0.10s)
0.242	25.7	Neutral	52.0	-26.3	AVG	AVG (0.10s)
22.388	22.2	Line 1	50.0	-27.8	AVG	AVG (0.10s)
0.783	27.9	Neutral	56.0	-28.1	QP	QP (1.00s)
15.328	30.4	Neutral	60.0	-29.6	QP	QP (1.00s)
24.725	19.0	Neutral	50.0	-31.0	AVG	AVG (0.10s)
22.388	28.7	Line 1	60.0	-31.3	QP	QP (1.00s)
19.014	27.5	Line 1	60.0	-32.5	QP	QP (1.00s)
0.783	12.0	Neutral	46.0	-34.0	AVG	AVG (0.10s)
24.725	25.8	Neutral	60.0	-34.2	QP	QP (1.00s)
19.014	13.9	Line 1	50.0	-36.1	AVG	AVG (0.10s)
15.328	13.1	Neutral	50.0	-36.9	AVG	AVG (0.10s)

End of Report

This page is intentionally blank and marks the last page of this test report.