

EMC Test Report

*Application for Grant of Equipment Authorization
pursuant to*

FCC Part 15, Subpart E

Model: CELFI-RSWU104

FCC ID: YETCELFI-RSWU104

APPLICANT: Nextivity Incorporated
12230 World Trade Drive Suite 250
San Diego, CA 92128

TEST SITE(S): Elliott Laboratories
41039 Boyce Road.
Fremont, CA. 94538-2435

REPORT DATE: May 20, 2010

FINAL TEST DATES: May 6, May 7, May 18 and May 20, 2010

AUTHORIZED SIGNATORY:



David W. Bare
Chief Engineer
Elliott Laboratories.



Testing Cert #2016-01

Elliott Laboratories is accredited by the A2LA, certificate number 2016-01, to perform the test(s) listed in this report, except where noted otherwise. This report shall not be reproduced, except in its entirety, without the written approval of Elliott Laboratories

REVISION HISTORY

Rev#	Date	Comments	Modified By
1	5/20/2010	First release	

TABLE OF CONTENTS

COVER PAGE	1
REVISION HISTORY	2
TABLE OF CONTENTS	3
SCOPE	5
OBJECTIVE	5
STATEMENT OF COMPLIANCE	6
DEVIATIONS FROM THE STANDARDS	6
TEST RESULTS SUMMARY	7
UNII / LELAN DEVICES.....	7
GENERAL REQUIREMENTS APPLICABLE TO ALL BANDS	8
MEASUREMENT UNCERTAINTIES.....	9
EQUIPMENT UNDER TEST (EUT) DETAILS	10
GENERAL.....	10
OTHER EUT DETAILS.....	10
ANTENNA SYSTEM	10
ENCLOSURE.....	10
MODIFICATIONS.....	10
SUPPORT EQUIPMENT.....	11
EUT INTERFACE PORTS	11
EUT OPERATION.....	11
TEST SITE	12
GENERAL INFORMATION.....	12
CONDUCTED EMISSIONS CONSIDERATIONS	12
RADIATED EMISSIONS CONSIDERATIONS	12
MEASUREMENT INSTRUMENTATION	13
RECEIVER SYSTEM	13
INSTRUMENT CONTROL COMPUTER	13
LINE IMPEDANCE STABILIZATION NETWORK (LISN)	13
FILTERS/ATTENUATORS	14
ANTENNAS.....	14
ANTENNA MAST AND EQUIPMENT TURNTABLE.....	14
INSTRUMENT CALIBRATION.....	14
TEST PROCEDURES	15
EUT AND CABLE PLACEMENT	15
CONDUCTED EMISSIONS.....	15
RADIATED EMISSIONS	15
RADIATED EMISSIONS.....	16
CONDUCTED EMISSIONS FROM ANTENNA PORT	18
BANDWIDTH MEASUREMENTS	18
SPECIFICATION LIMITS AND SAMPLE CALCULATIONS.....	19
GENERAL TRANSMITTER RADIATED EMISSIONS SPECIFICATION LIMITS	19
FCC 15.407 (A) OUTPUT POWER LIMITS.....	20
SPURIOUS EMISSIONS LIMITS –UNII AND LELAN DEVICES	20
SAMPLE CALCULATIONS - CONDUCTED EMISSIONS	20
SAMPLE CALCULATIONS - RADIATED EMISSIONS	21
SAMPLE CALCULATIONS - FIELD STRENGTH TO EIRP CONVERSION	22
APPENDIX A TEST EQUIPMENT CALIBRATION DATA	1
APPENDIX B TEST DATA	2
APPENDIX C PHOTOGRAPHS OF TEST CONFIGURATIONS	3
APPENDIX D PROPOSED FCC ID LABEL & LABEL LOCATION	4
APPENDIX E DETAILED PHOTOGRAPHS	5
APPENDIX F OPERATOR'S MANUAL	6

APPENDIX G BLOCK DIAGRAM.....	7
APPENDIX H SCHEMATIC DIAGRAMS.....	8
APPENDIX I THEORY OF OPERATION.....	9
APPENDIX J PARTS LIST	10
APPENDIX K RF EXPOSURE INFORMATION.....	11

SCOPE

An electromagnetic emissions test has been performed on the Nextivity Incorporated model CELFI-RSWU104, pursuant to the following rules:

FCC Part 15, Subpart E requirements for UNII Devices (using FCC DA 02-2138, August 30, 2002)

Conducted and radiated emissions data has been collected, reduced, and analyzed within this report in accordance with measurement guidelines set forth in the following reference standards and as outlined in Elliott Laboratories test procedures:

ANSI C63.4:2003
FCC UNII test procedure 2002-08 DA-02-2138, August 2002

The intentional radiator above has been tested in a simulated typical installation to demonstrate compliance with the relevant Industry Canada performance and procedural standards.

Final system data was gathered in a mode that tended to maximize emissions by varying orientation of EUT, orientation of power and I/O cabling, antenna search height, and antenna polarization.

Every practical effort was made to perform an impartial test using appropriate test equipment of known calibration. All pertinent factors have been applied to reach the determination of compliance.

OBJECTIVE

The primary objective of the manufacturer is compliance with the regulations outlined in the previous section.

Prior to marketing in the USA, all unlicensed transmitters and transceivers require certification. Receive-only devices operating between 30 MHz and 960 MHz are subject to either certification or a manufacturer's declaration of conformity, with all other receive-only devices exempt from the technical requirements.

Certification is a procedure where the manufacturer submits test data and technical information to a certification body and receives a certificate or grant of equipment authorization upon successful completion of the certification body's review of the submitted documents. Once the equipment authorization has been obtained, the label indicating compliance must be attached to all identical units, which are subsequently manufactured.

Maintenance of compliance is the responsibility of the manufacturer. Any modification of the product which may result in increased emissions should be checked to ensure compliance has been maintained (i.e., printed circuit board layout changes, different line filter, different power supply, harnessing or I/O cable changes, etc.).

STATEMENT OF COMPLIANCE

The tested sample of Nextivity Incorporated model CELFI-RSWU104 complied with the requirements of the following regulations:

FCC Part 15, Subpart E requirements for UNII Devices

Maintenance of compliance is the responsibility of the manufacturer. Any modifications to the product should be assessed to determine their potential impact on the compliance status of the device with respect to the standards detailed in this test report.

The test results recorded herein are based on a single type test of Nextivity Incorporated model CELFI-RSWU104 and therefore apply only to the tested sample. The sample was selected and prepared by Rama Akella of Nextivity Incorporated.

DEVIATIONS FROM THE STANDARDS

No deviations were made from the published requirements listed in the scope of this report.

TEST RESULTS SUMMARY**UNII / LELAN DEVICES****Operation in the 5.47 – 5.725 GHz Band**

FCC Rule Part	Description	Measured Value / Comments	Limit / Requirement	Result (margin)
15.407(a) (2)	26dB Bandwidth	39.4 MHz	N/A – limits output power if < 20MHz	N/A
15.407(a) (2)	Output Power	15.3 dBm (0.034 W)	24dBm (250mW)	Complies
15.407(a) (2)	Power Spectral Density	0.4 dBm/MHz	11 dBm/MHz	Complies
15.407(b) (6) / 15.209	Spurious Emissions below 1GHz	29.4dB μ V/m @ 82.12MHz	Refer to standard	Complies (-10.6 dB)
15.407(b) (3)	Spurious Emissions above 1GHz	52.4 dBuV/m @ 11345.56 MHz	Refer to standard	Complies (-1.6 dB)
15.407(a)(6)	Peak Excursion Ratio	10.6 dB	< 13dB	Complies

Requirements for all U-NII bands

FCC Rule Part	Description	Measured Value / Comments	Limit / Requirement	Result
15.407	Modulation	OFDM Digital Modulation is used	Digital modulation is required	Complies
15.31(m)	# of Test Frequencies	Measurements on three channels in each band	Device was tested on the top, bottom and center channels in each band	Complies
15.407 (c)	Operation in the absence of information to transmit	Operation would cease but operation never stops as information from cell tower will always be present	Device shall automatically discontinue operation in the absence of information to transmit	Complies
15.407 (g)	Frequency Stability	Frequency stability is better than 10ppm	Signal shall be maintained within the band of operation	Complies
15.407 (h1)	Transmit Power Control	TPC mechanism is discussed in the Operational Description Page 5	The U-NII device shall have the capability to operate with a mean EIRP value lower than 24dBm (250mW)	Complies
15.407 (h2)	Dynamic frequency Selection (device with radar detection)	Refer to separate test report, reference R79033	Threshold -62dBm (-64dBm if eirp > 200mW) Channel Availability Check > 60s Channel closing transmission time < 260ms Channel move time < 10s Non occupancy period > 30minutes	Complies
	User Manual information	Refer to Exhibit for details		Complies

GENERAL REQUIREMENTS APPLICABLE TO ALL BANDS

FCC Rule Part	Description	Measured Value / Comments	Limit / Requirement	Result (margin)
15.203	RF Connector	Integral antenna	Integral antenna or non standard RF connector	Complies
15.109	Receiver spurious emissions	Not applicable for receives operating in these bands	-	-
15.207	AC Conducted Emissions	50.7dBuV @ 21.748MHz	Refer to standard	Complies (-9.3 dB)
15.407 (f)	RF Exposure Requirements	Refer to MPE calculations in separate Exhibit	Refer to OET 65, FCC Part 1 and RSS 102	Complies

MEASUREMENT UNCERTAINTIES

ISO/IEC 17025 requires that an estimate of the measurement uncertainties associated with the emissions test results be included in the report. The measurement uncertainties given below are based on a 95% confidence level and were calculated in accordance with UKAS document LAB 34.

Measurement Type	Measurement Unit	Frequency Range	Expanded Uncertainty
RF power, conducted (power meter)	dBm	25 to 7000 MHz	± 0.52 dB
RF power, conducted (Spectrum analyzer)	dBm	25 to 7000 MHz	± 0.7 dB
Conducted emission of transmitter	dBm	25 to 26500 MHz	± 0.7 dB
Conducted emission of receiver	dBm	25 to 26500 MHz	± 0.7 dB
Radiated emission (substitution method)	dBm	25 to 26500 MHz	± 2.5 dB
Radiated emission (field strength)	dB μ V/m	25 to 1000 MHz	± 3.6 dB
		1000 to 40000 MHz	± 6.0 dB
Conducted Emissions (AC Power)	dB μ V	0.15 to 30 MHz	± 2.4 dB

EQUIPMENT UNDER TEST (EUT) DETAILS**GENERAL**

The Nextivity Incorporated model CELFI-RSWU104 is part of a cellular repeater system that is designed to allow for cellular reception within a building. The CELFI-RSWU104 communicates with cellular tower and can transmit to the CELFI-RSCU104 in the 5470-5725 MHz band. It was treated as table-top equipment during testing to simulate the end-user environment. The CELFI-RSWU104 is powered via external AC/DC adapters. The electrical rating of the adapters is 90-264VAC, 47-63 Hz, 1.0A Max.

The sample was received on April 12, 2010 and tested on May 6, May 7, May 18 and May 20, 2010. The EUT consisted of the following component(s):

Company	Model	Description	Serial Number	FCC ID
Nextivity	CELF1-RSWU1	Cel-Fi Window Unit	Various	YETCELF1-RSWU104

OTHER EUT DETAILS

The communication in the U-NII bands is a nominally 40 MHz proprietary signal. The WU transmits in the 5470-5725 MHz band only and receives in the 5150-5350 MHz band in normal use. During CU synchronization, the WU receives in both 5150-5350 and 5470-5735 MHz bands. The CU transmits in the 5150-5350 MHz band and receives in the 5470-5725 MHz band. Once communication is established between the WU and CU, there is 100% usage of the TX channel for both the WU and CU.

ANTENNA SYSTEM

The antenna system consists of custom built antennas mounted inside the enclosure. They are not accessible or removable.

ENCLOSURE

The EUT enclosure is primarily constructed of plastic. It measures approximately 20.9 cm wide by 5.9 cm deep by 24.5 cm high.

MODIFICATIONS

The following modifications were made to the EUT during the time the product was at Elliott:

Increased PA Bias voltage; Added 3dB attenuator between transmit IC and PA.

SUPPORT EQUIPMENT

The following equipment was used as support equipment for testing:

Company	Model	Description	Serial Number	FCC ID
Dell	PP18L	Laptop	37670547493	-
Dell	HA65NS1-00	Power Adaptor	CN-OHN662-47890-870-A2C2	-

EUT INTERFACE PORTS

The I/O cabling configuration during testing was as follows:

Port	Connected To	Description	Cable(s)	
			Shielded or Unshielded	Length(m)
Console (Serial)	Laptop USB	Multi-conductor	Shielded	1.5
AC Adapter Power	AC Mains	Direct Plug in	Unshielded	2.0
DC Power	AC Adapter	Two wire	Unshielded	2.0

Note: The USB port was not connected during testing. Nextivity stated that this is for loading code and therefore would not normally be connected.

EUT OPERATION

During emissions testing, the EUT was configured to transmit a modulated 100% duty cycle signal at the selected power and frequency.

TEST SITE**GENERAL INFORMATION**

Final test measurements were taken at the test sites listed below. Pursuant to section 2.948 of the FCC's Rules and section 3.3 of RSP-100, construction, calibration, and equipment data has been filed with the Commission and with industry Canada.

Site	Registration Numbers		Location
	FCC	Canada	
Chamber 3	769238	2845B-3	41039 Boyce Road Fremont, CA 94538-2435
Chamber 4	211948	2845B-4	

ANSI C63.4:2003 recommends that ambient noise at the test site be at least 6 dB below the allowable limits. Ambient levels are below this requirement. The test site(s) contain separate areas for radiated and conducted emissions testing. Considerable engineering effort has been expended to ensure that the facilities conform to all pertinent requirements of ANSI C63.4:2003.

CONDUCTED EMISSIONS CONSIDERATIONS

Conducted emissions testing is performed in conformance with ANSI C63.4:2003. Measurements are made with the EUT connected to the public power network through a nominal, standardized RF impedance, which is provided by a line impedance stabilization network, known as a LISN. A LISN is inserted in series with each current-carrying conductor in the EUT power cord.

RADIATED EMISSIONS CONSIDERATIONS

The FCC has determined that radiation measurements made in a shielded enclosure are not suitable for determining levels of radiated emissions. Radiated measurements are performed in an open field environment or in a semi-anechoic chamber. The test sites are maintained free of conductive objects within the CISPR defined elliptical area incorporated in ANSI C63.4:2003 guidelines and meet the Normalized Site Attenuation (NSA) requirements of ANSI C63.4:2003.

MEASUREMENT INSTRUMENTATION

RECEIVER SYSTEM

An EMI receiver as specified in CISPR 16-1-1 is used for emissions measurements. The receivers used can measure over the frequency range of 9 kHz up to 2000 MHz. These receivers allow both ease of measurement and high accuracy to be achieved. The receivers have Peak, Average, and CISPR (Quasi-peak) detectors built into their design so no external adapters are necessary. The receiver automatically sets the required bandwidth for the CISPR detector used during measurements. If the repetition frequency of the signal being measured is below 20Hz, peak measurements are made in lieu of Quasi-Peak measurements.

For measurements above the frequency range of the receivers, a spectrum analyzer is utilized because it provides visibility of the entire spectrum along with the precision and versatility required to support engineering analysis. Average measurements above 1000MHz are performed on the spectrum analyzer using the linear-average method with a resolution bandwidth of 1 MHz and a video bandwidth of 10 Hz, unless the signal is pulsed in which case the average (or video) bandwidth of the measuring instrument is reduced to onset of pulse desensitization and then increased.

INSTRUMENT CONTROL COMPUTER

The receivers utilize either a Rohde & Schwarz EZM Spectrum Monitor/Controller or contain an internal Spectrum Monitor/Controller to view and convert the receiver measurements to the field strength at an antenna or voltage developed at the LISN measurement port, which is then compared directly with the appropriate specification limit. This provides faster, more accurate readings by performing the conversions described under Sample Calculations within the Test Procedures section of this report. Results are printed in a graphic and/or tabular format, as appropriate. A personal computer is used to record all measurements made with the receivers.

The Spectrum Monitor provides a visual display of the signal being measured. In addition, the controller or a personal computer run automated data collection programs which control the receivers. This provides added accuracy since all site correction factors, such as cable loss and antenna factors are added automatically.

LINE IMPEDANCE STABILIZATION NETWORK (LISN)

Line conducted measurements utilize a fifty microhenry Line Impedance Stabilization Network as the monitoring point. The LISN used also contains a 250 uH CISPR adapter. This network provides for calibrated radio frequency noise measurements by the design of the internal low pass and high pass filters on the EUT and measurement ports, respectively.

FILTERS/ATTENUATORS

External filters and precision attenuators are often connected between the receiving antenna or LISN and the receiver. This eliminates saturation effects and non-linear operation due to high amplitude transient events.

ANTENNAS

A loop antenna is used below 30 MHz. For the measurement range 30 MHz to 1000 MHz either a combination of a biconical antenna and a log periodic or a bi-log antenna is used. Above 1000 MHz, horn antennas are used. The antenna calibration factors to convert the received voltage to an electric field strength are included with appropriate cable loss and amplifier gain factors to determine an overall site factor, which is then programmed into the test receivers or incorporated into the test software.

ANTENNA MAST AND EQUIPMENT TURNTABLE

The antennas used to measure the radiated electric field strength are mounted on a non-conductive antenna mast equipped with a motor-drive to vary the antenna height. Measurements below 30 MHz are made with the loop antenna at a fixed height of 1m above the ground plane.

ANSI C63.4:2003 specifies that the test height above ground for table mounted devices shall be 80 centimeters. Floor mounted equipment shall be placed on the ground plane if the device is normally used on a conductive floor or separated from the ground plane by insulating material from 3 to 12 mm if the device is normally used on a non-conductive floor. During radiated measurements, the EUT is positioned on a motorized turntable in conformance with this requirement.

INSTRUMENT CALIBRATION

All test equipment is regularly checked to ensure that performance is maintained in accordance with the manufacturer's specifications. All antennas are calibrated at regular intervals with respect to tuned half-wave dipoles. An exhibit of this report contains the list of test equipment used and calibration information.

TEST PROCEDURES

EUT AND CABLE PLACEMENT

The regulations require that interconnecting cables be connected to the available ports of the unit and that the placement of the unit and the attached cables simulate the worst case orientation that can be expected from a typical installation, so far as practicable. To this end, the position of the unit and associated cabling is varied within the guidelines of ANSI C63.4:2003, and the worst-case orientation is used for final measurements.

CONDUCTED EMISSIONS

Conducted emissions are measured at the plug end of the power cord supplied with the EUT. Excess power cord length is wrapped in a bundle between 30 and 40 centimeters in length near the center of the cord. Preliminary measurements are made to determine the highest amplitude emission relative to the specification limit for all the modes of operation. Placement of system components and varying of cable positions are performed in each mode. A final peak mode scan is then performed in the position and mode for which the highest emission was noted on all current carrying conductors of the power cord.

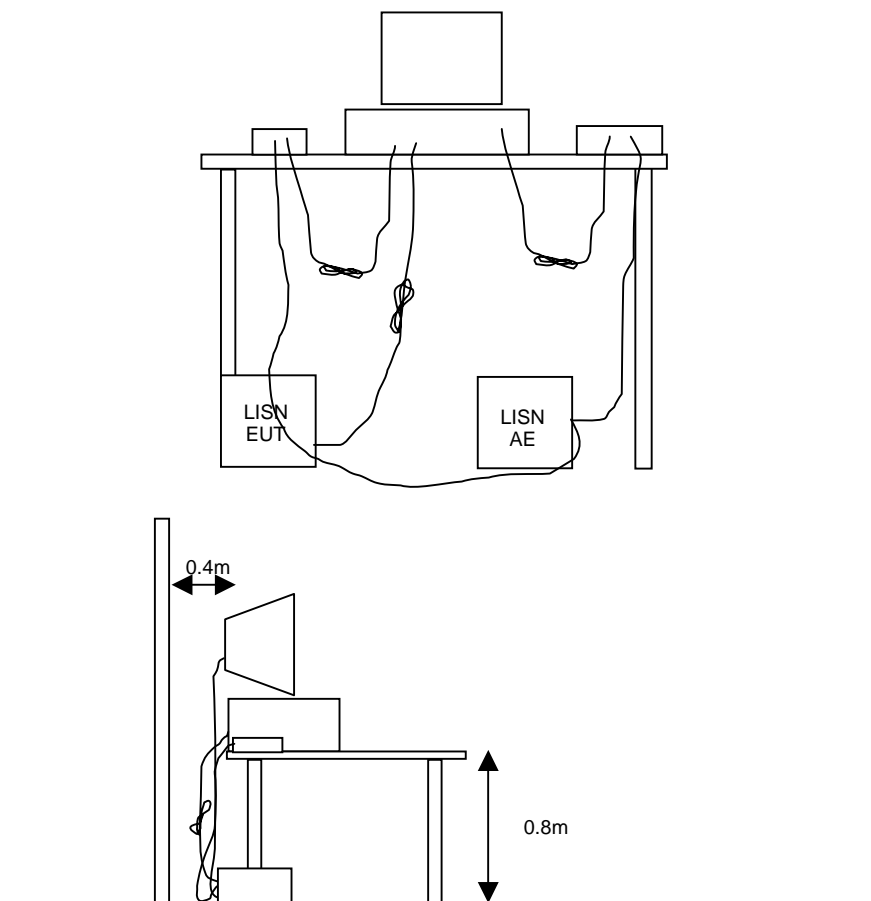

RADIATED EMISSIONS

A preliminary scan of the radiated emissions is performed in which all significant EUT frequencies are identified with the system in a nominal configuration. At least two scans are performed, one scan for each antenna polarization (horizontal and vertical; loop parallel and perpendicular to the EUT). During the preliminary scans, the EUT is rotated through 360°, the antenna height is varied (for measurements above 30 MHz) and cable positions are varied to determine the highest emission relative to the limit. Preliminary scans may be performed in a fully anechoic chamber for the purposes of identifying the frequencies of the highest emissions from the EUT.

A speaker is provided in the receiver to aid in discriminating between EUT and ambient emissions. Other methods used during the preliminary scan for EUT emissions involve scanning with near field magnetic loops, monitoring I/O cables with RF current clamps, and cycling power to the EUT.

Final maximization is a phase in which the highest amplitude emissions identified in the spectral search are viewed while the EUT azimuth angle is varied from 0 to 360 degrees relative to the receiving antenna. The azimuth, which results in the highest emission is then maintained while varying the antenna height from one to four meters (for measurements above 30 MHz, measurements below 30 MHz are made with the loop antenna at a fixed height of 1m). The result is the identification of the highest amplitude for each of the highest peaks. Each recorded level is corrected in the receiver using appropriate factors for cables, connectors, antennas, and preamplifier gain.

When testing above 18 GHz, the receive antenna is located at 1meter from the EUT and the antenna height is restricted to a maximum of 2.5 meters.

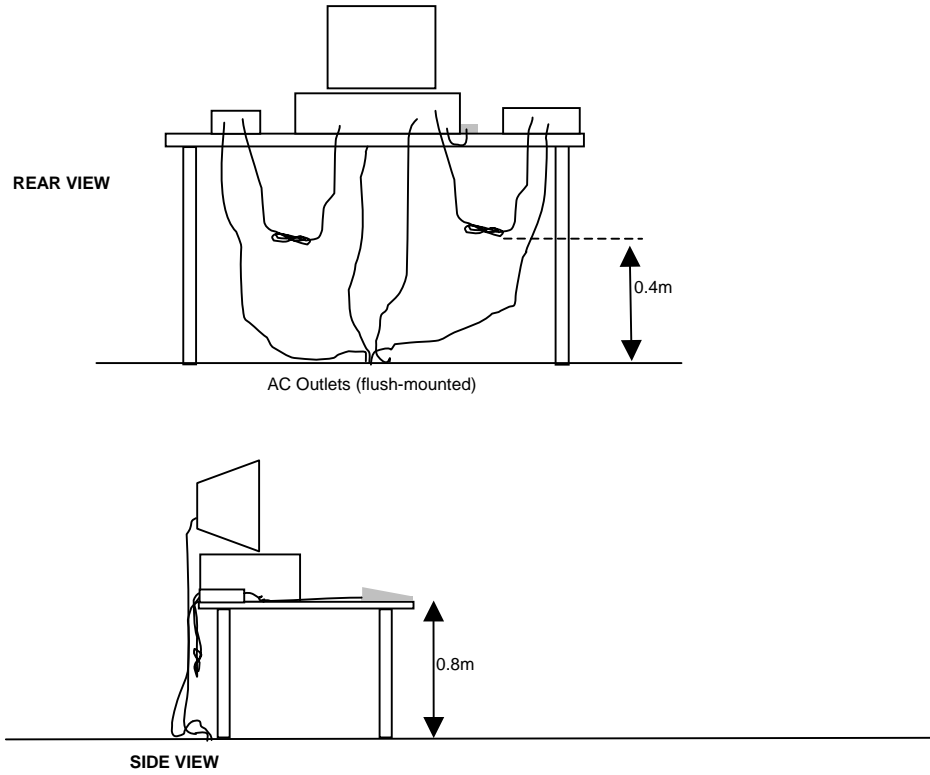

Typical Test Configuration for Radiated Field Strength Measurements

CONDUCTED EMISSIONS FROM ANTENNA PORT

Direct measurements of power, bandwidth and power spectral density are performed, where possible, with the antenna port of the EUT connected to either the power meter or spectrum analyzer via a suitable attenuator and/or filter. These are used to ensure that the front end of the measurement instrument is not overloaded by the fundamental transmission.

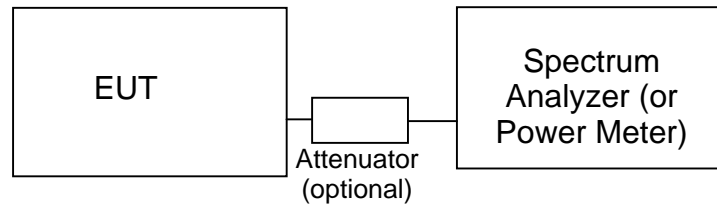
**Test Configuration for Antenna Port Measurements**

Measurement bandwidths (video and resolution) are set in accordance with the relevant standards and Elliott's test procedures for the type of radio being tested. When power measurements are made using a resolution bandwidth less than the signal bandwidth the power is calculated by summing the power across the signal bandwidth using either the analyzer channel power function or by capturing the trace data and calculating the power using software. In both cases the summed power is corrected to account for the equivalent noise bandwidth (ENBW) of the resolution bandwidth used.

If power averaging is used (typically for certain digital modulation techniques), the EUT is configured to transmit continuously. Power averaging is performed using either the built-in function of the analyzer or, if the analyzer does not feature power averaging, using external software. In both cases the average power is calculated over a number of sweeps (typically 100). When the EUT cannot be configured to continuously transmit then either the analyzer is configured to perform a gated sweep to ensure that the power is averaged over periods that the device is transmitting or power averaging is disabled and a max-hold feature is used.

If a power meter is used to make output power measurements the sensor head type (peak or average) is stated in the test data table.

BANDWIDTH MEASUREMENTS

The 6dB, 20dB and/or 26dB signal bandwidth is measured in using the bandwidths recommended by ANSI C63.4. When required, the 99% bandwidth is measured using the methods detailed in RSS GEN.

SPECIFICATION LIMITS AND SAMPLE CALCULATIONS

The limits for conducted emissions are given in units of microvolts, and the limits for radiated emissions are given in units of microvolts per meter at a specified test distance. Data is measured in the logarithmic form of decibels relative to one microvolt, or dB microvolts (dBuV). For radiated emissions, the measured data is converted to the field strength at the antenna in dB microvolts per meter (dBuV/m). The results are then converted to the linear forms of uV and uV/m for comparison to published specifications.

For reference, converting the specification limits from linear to decibel form is accomplished by taking the base ten logarithm, then multiplying by 20. These limits in both linear and logarithmic form are as follows:

GENERAL TRANSMITTER RADIATED EMISSIONS SPECIFICATION LIMITS

The table below shows the limits for the spurious emissions from transmitters that fall in restricted bands¹ (with the exception of transmitters operating under FCC Part 15 Subpart D and RSS 210 Annex 9), the limits for all emissions from a low power device operating under the general rules of RSS 310 (tables 3 and 4), RSS 210 (table 2) and FCC Part 15 Subpart C section 15.209.

Frequency Range (MHz)	Limit (uV/m)	Limit (dBuV/m @ 3m)
0.009-0.490	$2400/F_{\text{KHz}} @ 300\text{m}$	$67.6-20*\log_{10}(F_{\text{KHz}}) @ 300\text{m}$
0.490-1.705	$24000/F_{\text{KHz}} @ 30\text{m}$	$87.6-20*\log_{10}(F_{\text{KHz}}) @ 30\text{m}$
1.705 to 30	30 @ 30m	29.5 @ 30m
30 to 88	100 @ 3m	40 @ 3m
88 to 216	150 @ 3m	43.5 @ 3m
216 to 960	200 @ 3m	46.0 @ 3m
Above 960	500 @ 3m	54.0 @ 3m

¹ The restricted bands are detailed in FCC 15.203, RSS 210 Table 1 and RSS 310 Table 2

FCC 15.407 (a) OUTPUT POWER LIMITS

The table below shows the limits for output power and output power density. Where the signal bandwidth is less than 20 MHz the maximum output power is reduced to the power spectral density limit plus 10 times the log of the bandwidth (in MHz).

Operating Frequency (MHz)	Output Power	Power Spectral Density
5150 – 5250	50mW (17 dBm)	4 dBm/MHz
5250 – 5350	250 mW (24 dBm)	11 dBm/MHz
5725 – 5825	1 Watts (30 dBm)	17 dBm/MHz

For system using antennas with gains exceeding 6dBi, the output power and power spectral density limits are reduced by 1dB for every dB the antenna gain exceeds 6dBi. Fixed point-to-point applications using the 5725 – 5825 MHz band may use antennas with gains of up to 23dBi without this limitation. If the gain exceeds 23dBi then the output power limit of 1 Watt is reduced by 1dB for every dB the gain exceeds 23dBi.

The peak excursion envelope is limited to 13dB.

SPURIOUS EMISSIONS LIMITS –UNII and LELAN DEVICES

The spurious emissions limits for signals below 1GHz are the FCC/RSS-GEN general limits. For emissions above 1GHz, signals in restricted bands are subject to the FCC/RSS GEN general limits. All other signals have a limit of –27dBm/MHz, which is a field strength of 68.3dBuV/m/MHz at a distance of 3m. This is an average limit so the peak value of the emission may not exceed –7dBm/MHz (68.3dBuV/m/MHz at a distance of 3m). For devices operating in the 5725-5850Mhz bands under the LELAN/UNII rules, the limit within 10Mhz of the allocated band is increased to –17dBm/MHz.

SAMPLE CALCULATIONS - CONDUCTED EMISSIONS

Receiver readings are compared directly to the conducted emissions specification limit (decibel form) as follows:

$$R_T - S = M$$

where:

R_T = Receiver Reading in dBuV

S = Specification Limit in dBuV

M = Margin to Specification in +/- dB

SAMPLE CALCULATIONS - RADIATED EMISSIONS

Receiver readings are compared directly to the specification limit (decibel form). The receiver internally corrects for cable loss, preamplifier gain, and antenna factor. The calculations are in the reverse direction of the actual signal flow, thus cable loss is added and the amplifier gain is subtracted. The Antenna Factor converts the voltage at the antenna coaxial connector to the field strength at the antenna elements.

A distance factor, when used for electric field measurements above 30MHz, is calculated by using the following formula:

$$F_d = 20 * \text{LOG}_{10} (D_m/D_s)$$

where:

$$F_d = \text{Distance Factor in dB}$$

$$D_m = \text{Measurement Distance in meters}$$

$$D_s = \text{Specification Distance in meters}$$

For electric field measurements below 30MHz the extrapolation factor is either determined by making measurements at multiple distances or a theoretical value is calculated using the formula:

$$F_d = 40 * \text{LOG}_{10} (D_m/D_s)$$

Measurement Distance is the distance at which the measurements were taken and Specification Distance is the distance at which the specification limits are based. The antenna factor converts the voltage at the antenna coaxial connector to the field strength at the antenna elements.

The margin of a given emission peak relative to the limit is calculated as follows:

$$R_c = R_r + F_d$$

and

$$M = R_c - L_s$$

where:

$$R_r = \text{Receiver Reading in dBuV/m}$$

$$F_d = \text{Distance Factor in dB}$$

$$R_c = \text{Corrected Reading in dBuV/m}$$

$$L_s = \text{Specification Limit in dBuV/m}$$

$$M = \text{Margin in dB Relative to Spec}$$

SAMPLE CALCULATIONS - FIELD STRENGTH TO EIRP CONVERSION

Where the radiated electric field strength is expressed in terms of the equivalent isotropic radiated power (eirp), or where a field strength measurement of output power is made in lieu of a direct measurement, the following formula is used to convert between eirp and field strength at a distance of d (meters) from the equipment under test:

$$E = \frac{1000000 \sqrt{30 P}}{d} \quad \text{microvolts per meter}$$

where P is the eirp (Watts)

For a measurement at 3m the conversion from a logarithmic value for field strength (dBuV/m) to an eirp power (dBm) is -95.3dB.

Appendix A Test Equipment Calibration Data**Conducted Emissions - AC Power Ports, 06-May-10**

<u>Manufacturer</u>	<u>Description</u>	<u>Model</u>	<u>Asset #</u>	<u>Cal Due</u>
EMCO	LISN, 10 kHz-100 MHz	3825/2	1293	3/12/2011
Rohde & Schwarz	Pulse Limiter	ESH3 Z2	1594	6/9/2010
Rohde & Schwarz	EMI Test Receiver, 20 Hz-7 GHz	ESIB7	1756	3/16/2011
Fischer Custom Comm	LISN, 25A, 150kHz to 30MHz, 25 Amp,	FCC-LISN-50-25-2- 09	2001	10/21/2010

Radio Power PSD and Spurious Emissions, 07-May-10

<u>Manufacturer</u>	<u>Description</u>	<u>Model</u>	<u>Asset #</u>	<u>Cal Due</u>
EMCO	Antenna, Horn, 1-18 GHz (SA40-Blu)	3115	1386	9/2/2010
Rohde & Schwarz	EMI Test Receiver, 20 Hz-7 GHz	ESIB7	1756	3/16/2011

Radiated Emissions, 1,000 - 40,000 MHz, 07-May-10

<u>Manufacturer</u>	<u>Description</u>	<u>Model</u>	<u>Asset #</u>	<u>Cal Due</u>
EMCO	Antenna, Horn, 1-18 GHz (SA40-Blu)	3115	1386	9/2/2010
Hewlett Packard	SpecAn 9 kHz - 40 GHz, FT (SA40) Blue	8564E (84125C)	1393	4/14/2011
Hewlett Packard	Head (Inc W1-W4, 1742 , 1743) Blue	84125C	1620	5/4/2011
Micro-Tronics	Band Reject Filter, 5150-5350 MHz	BRC50703-02	1729	9/25/2010
Micro-Tronics	Band Reject Filter, 5470-5725 MHz	BRC50704-02	1730	9/25/2010
Hewlett Packard	High Pass filter, 8.2 GHz (Purple System)	P/N 84300-80039 (84125C)	1767	11/4/2010
Hewlett Packard	Microwave Preamplifier, 1- 26.5GHz	8449B	1780	9/17/2010
A.H. Systems	Red System Horn, 18-40GHz	SAS-574, p/n: 2581	2161	3/5/2011

Radiated Emissions, 1000 - 18,000 MHz, 18-May-10

<u>Manufacturer</u>	<u>Description</u>	<u>Model</u>	<u>Asset #</u>	<u>Cal Due</u>
Hewlett Packard	Microwave Preamplifier, 1- 26.5GHz	8449B	870	8/19/2010
Hewlett Packard	SpecAn 30 Hz -40 GHz, SV (SA40) Red	8564E (84125C)	1148	6/12/2010
Hewlett Packard	High Pass filter, 8.2 GHz (Red System)	P/N 84300-80039 (84125C)	1152	9/28/2010
EMCO	Antenna, Horn, 1-18 GHz	3115	1561	6/10/2010
Micro-Tronics	Band Reject Filter, 5470-5725 MHz	BRC50704-02	1730	9/25/2010

Radiated Emissions, 30 - 1,000 MHz, 20-May-10

<u>Manufacturer</u>	<u>Description</u>	<u>Model</u>	<u>Asset #</u>	<u>Cal Due</u>
Rohde & Schwarz	EMI Test Receiver, 20 Hz-7 GHz	ESIB7	1630	31-Mar-11
Sunol Sciences	Biconilog, 30-3000 MHz	JB3	1657	23-Jun-10
Com-Power Corp.	Preamplifier, 30-1000 MHz	PA-103A	2204	26-Feb-11

Appendix B Test Data

T78964 21 Pages



EMC Test Data

Client:	Nextivity, Inc.	Job Number:	J78899
Model:	Cel-Fi	T-Log Number:	T78964
		Account Manager:	Sheareen Washington
Contact:	Rama Akella		-
Emissions Standard(s):	FCC Part 15 and 27	Class:	B
Immunity Standard(s):	-	Environment:	Radio

EMC Test Data

For The

Nextivity, Inc.

Model

Cel-Fi

Date of Last Test: 5/20/2010

Client: Nextivity, Inc.	Job Number: J78899
Model: Cel-Fi	T-Log Number: T78964
	Account Manager: Sheareen Washington
Contact: Rama Akella	
Standard: FCC Part 15 and 27	Class: B

Radiated Emissions

(Elliott Laboratories Fremont Facility, Semi-Anechoic Chamber)

Test Specific Details

Objective: The objective of this test session is to perform final qualification testing of the EUT with respect to the specification listed above.

Date of Test: 5/20/2010	Config. Used: 1
Test Engineer: Rafael Varelas	Config Change: None
Test Location: Fremont Chamber #5	EUT Voltage: 120V/60Hz

General Test Configuration

The EUT and any local support equipment were located on the turntable for radiated emissions testing.

The test distance and extrapolation factor (if applicable) are detailed under each run description.

Note, **preliminary** testing indicates that the emissions were maximized by orientation of the EUT and elevation of the measurement antenna. **Maximized** testing indicated that the emissions were maximized by orientation of the EUT, elevation of the measurement antenna, and manipulation of the EUT's interface cables.

Ambient Conditions:

Temperature:	18.9 °C
Rel. Humidity:	33 %

Summary of Results

Run #	Test Performed	Limit	Result	Margin
2	Radiated Emissions 30 - 1000 MHz, Maximized	FCC Class B	Pass	29.4dBµV/m @ 82.12MHz (-10.6dB)

Modifications Made During Testing

No modifications were made to the EUT during testing

Deviations From The Standard

No deviations were made from the requirements of the standard.

Client: Nextivity, Inc.	Job Number: J78899
Model: Cel-Fi	T-Log Number: T78964
Contact: Rama Akella	Account Manager: Sheareen Washington
Standard: FCC Part 15 and 27	Class: B

Run #1: Preliminary Radiated Emissions, 30 - 1000 MHz

Frequency Range	Test Distance	Limit Distance	Extrapolation Factor
30 - 1000 MHz	3	3	0.0

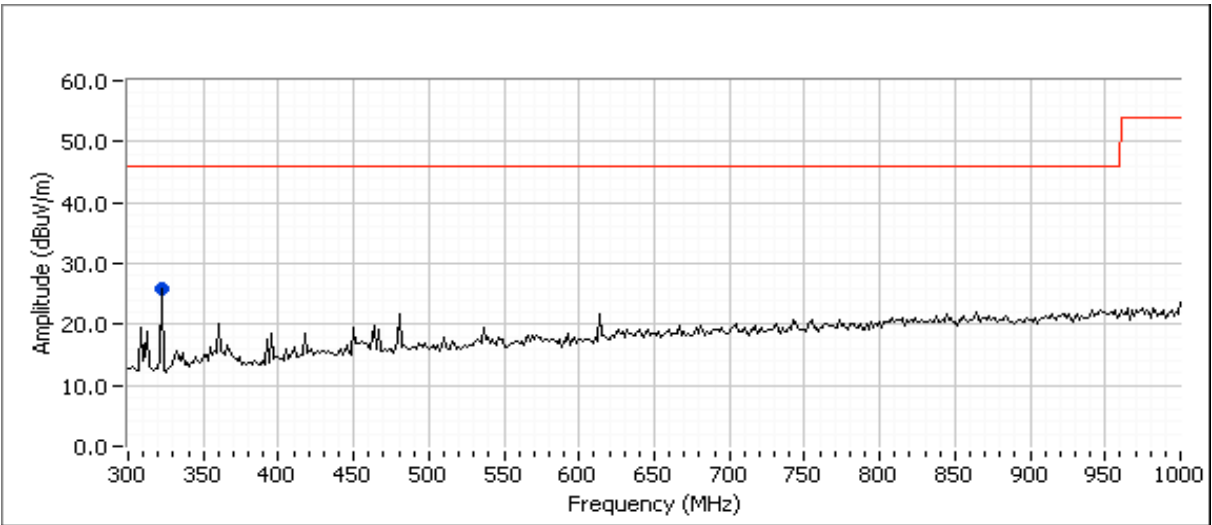
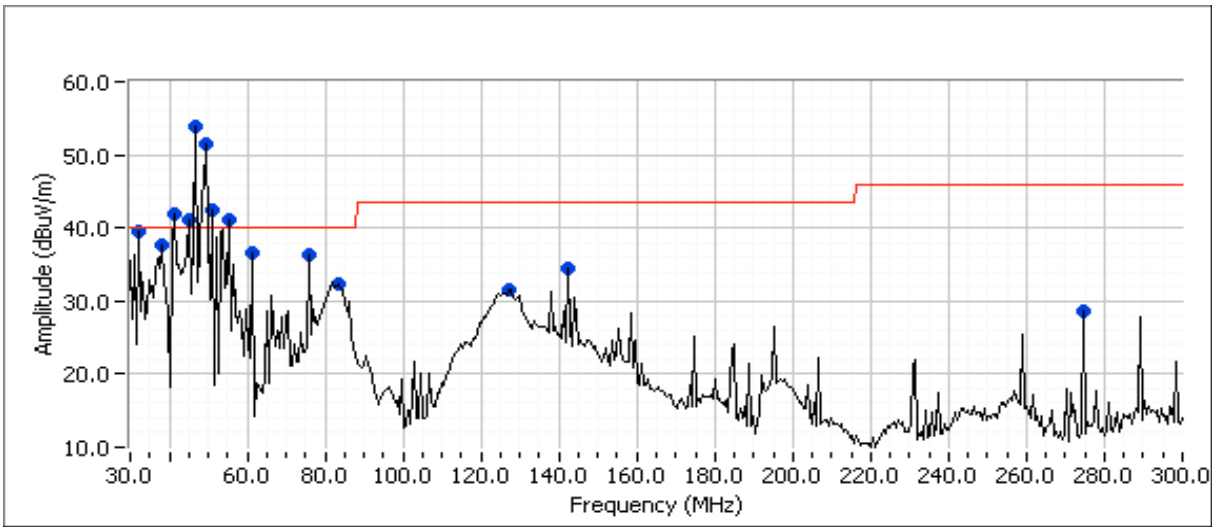



EMC Test Data

Client:	Nextivity, Inc.	Job Number:	J78899
Model:	Cel-Fi	T-Log Number:	T78964
Contact:	Rama Akella	Account Manager:	Sheareen Washington
Standard:	FCC Part 15 and 27	Class:	B

Preliminary peak readings captured during pre-scan

Frequency MHz	Level dB μ V/m	Pol v/h	FCC Class B		Detector Pk/QP/Avg	Azimuth degrees	Height meters	Comments
			Limit	Margin				
43.488	41.8	V	40.0	1.8	Peak	33	3.5	
44.289	41.1	V	40.0	1.1	Peak	33	3.5	
46.120	53.8	V	40.0	13.8	Peak	204	1.5	
47.596	51.6	V	40.0	11.6	Peak	215	2.5	
52.699	42.5	V	40.0	2.5	Peak	174	4.0	
53.461	41.2	V	40.0	1.2	Peak	215	2.5	
30.359	39.5	V	40.0	-0.5	Peak	207	1.5	
39.990	37.6	V	40.0	-2.4	Peak	178	3.5	
63.153	36.5	V	40.0	-3.5	Peak	204	1.5	
77.736	36.4	V	40.0	-3.6	Peak	359	2.5	
82.117	32.4	V	40.0	-7.6	Peak	124	1.0	
125.798	31.6	V	43.5	-11.9	Peak	98	1.0	
142.385	34.5	V	43.5	-9.0	Peak	163	1.5	
275.560	28.6	V	46.0	-17.4	Peak	359	3.5	
319.763	25.7	V	46.0	-20.3	Peak	148	1.5	

Preliminary quasi-peak readings (no manipulation of EUT interface cables)

Frequency MHz	Level dB μ V/m	Pol v/h	FCC Class B		Detector Pk/QP/Avg	Azimuth degrees	Height meters	Comments
			Limit	Margin				
43.488	25.2	V	40.0	-14.8	QP	19	1.7	QP (1.00s)
44.289	24.7	V	40.0	-15.3	QP	25	1.0	QP (1.00s)
82.117	29.4	V	40.0	-10.6	QP	139	1.0	QP (1.00s)
52.699	17.9	V	40.0	-22.1	QP	185	1.0	QP (1.00s)
39.990	14.4	V	40.0	-25.6	QP	166	1.0	QP (1.00s)
46.120	26.5	V	40.0	-13.5	QP	216	1.0	QP (1.00s)
63.153	11.5	V	40.0	-28.5	QP	185	4.0	QP (1.00s)
30.359	20.8	V	40.0	-19.2	QP	206	1.0	QP (1.00s)
47.596	21.1	V	40.0	-18.9	QP	215	1.0	QP (1.00s)
53.461	18.1	V	40.0	-21.9	QP	215	1.0	QP (1.00s)
77.736	20.8	V	40.0	-19.2	QP	360	1.0	QP (1.00s)

Client:	Nextivity, Inc.	Job Number:	J78899
Model:	Cel-Fi	T-Log Number:	T78964
		Account Manager:	Sheareen Washington
Contact:	Rama Akella		
Standard:	FCC Part 15 and 27	Class:	B

Run #2: Maximized Readings From Run #1
Maximized quasi-peak readings (includes manipulation of EUT interface cables)

Frequency Range	Test Distance	Limit Distance	Extrapolation Factor
30 - 1000 MHz	3	3	0.0

Frequency MHz	Level dB μ V/m	Pol v/h	FCC Class B		Detector Pk/QP/Avg	Azimuth degrees	Height meters	Comments
			Limit	Margin				
82.117	29.4	V	40.0	-10.6	QP	139	1.0	QP (1.00s)
46.120	26.5	V	40.0	-13.5	QP	216	1.0	QP (1.00s)
43.488	25.2	V	40.0	-14.8	QP	19	1.7	QP (1.00s)
44.289	24.7	V	40.0	-15.3	QP	25	1.0	QP (1.00s)
47.596	21.1	V	40.0	-18.9	QP	215	1.0	QP (1.00s)
30.359	20.8	V	40.0	-19.2	QP	206	1.0	QP (1.00s)

Client:	Nextivity, Inc.	Job Number:	J78899
Model:	Cel-Fi	T-Log Number:	T78964
Contact:	Rama Akella	Account Manager:	Sheareen Washington
Standard:	FCC Part 15 and 27	Class:	N/A

RSS 210 and FCC 15.407 (UNII) Radiated Spurious Emissions

Test Specific Details

Objective: The objective of this test session is to perform final qualification testing of the EUT with respect to the specification listed above.

Date of Test: 5/18/2010
 Test Engineer: Rafael Varelas
 Test Location: FT Chamber#4

Config. Used: 1
 Config Change: None
 EUT Voltage: 120V/60Hz

General Test Configuration

The EUT and all local support equipment were located on the turntable for radiated spurious emissions testing.

For radiated emissions testing the measurement antenna was located 3 meters from the EUT.

Ambient Conditions: 5/18/2010
 Temperature: 19.4 °C
 Rel. Humidity: 35 %

Summary of Results

Run #	Channel	Test Performed	Limit	Result / Margin
1	Low (5524.2 MHz) 5525 Macro	Radiated Emissions, 1 - 40 GHz	FCC 15.209 / 15 E	47.2dBµV/m @ 11045.0MHz (-6.8dB)
	Middle (5563.2 MHz) 5564 Macro	Radiated Emissions, 1 - 40 GHz	FCC 15.209 / 15 E	45.0dBµV/m @ 11123.9MHz (-9.0dB)
	High (5668.8 MHz) 5670 Macro	Radiated Emissions, 1 - 40 GHz	FCC 15.209 / 15 E	52.4dBµV/m @ 11345.6MHz (-1.6dB)

Modifications Made During Testing

The following modifications were made to the EUT prior to testing in order to comply with the requirements of the standard:

Increased PA Bias voltage; Added 3dB attenuator between IC and PA.

Deviations From The Standard

No deviations were made from the requirements of the standard.

Client:	Nextivity, Inc.	Job Number:	J78899
Model:	Cel-Fi	T-Log Number:	T78964
Contact:	Rama Akella	Account Manager:	Sheareen Washington
Standard:	FCC Part 15 and 27	Class:	N/A

Run #1a: Low Channel
EUT S/N:102952000234

Spurious Radiated Emissions:

Frequency MHz	Level dBuV/m	Pol v/h	15.209 / 15E		Detector Pk/QP/Avg	Azimuth degrees	Height meters	Comments
			Limit	Margin				
11044.950	47.2	V	54.0	-6.8	AVG	152	1.1	MHz; VB: 10 Hz
11042.580	58.8	V	74.0	-15.2	PK	152	1.1	MHz; VB: 1 MHz
4264.060	40.2	V	54.0	-13.8	AVG	0	1.0	MHz; VB: 10 Hz
4263.680	46.9	V	74.0	-27.1	PK	0	1.0	MHz; VB: 1 MHz
4419.850	45.5	V	68.3	-22.8	AVG	200	1.0	MHz; VB: 10 Hz
4419.810	49.9	V	88.3	-38.4	PK	200	1.0	MHz; VB: 1 MHz
1328.400	31.3	V	54.0	-22.7	AVG	263	1.0	MHz; VB: 10 Hz
1329.600	51.8	V	74.0	-22.2	PK	263	1.0	MHz; VB: 1 MHz

- Note 1: For emissions in restricted bands, the limit of 15.209 was used. For all other emissions, the **average** limit was set to -27dBm/MHz (~68dBuV/m).
- Note 2: From 18-40 GHz, a near field scan of emissions from the EUT was performed and nothing was observed above the noise floor of the test equipment.

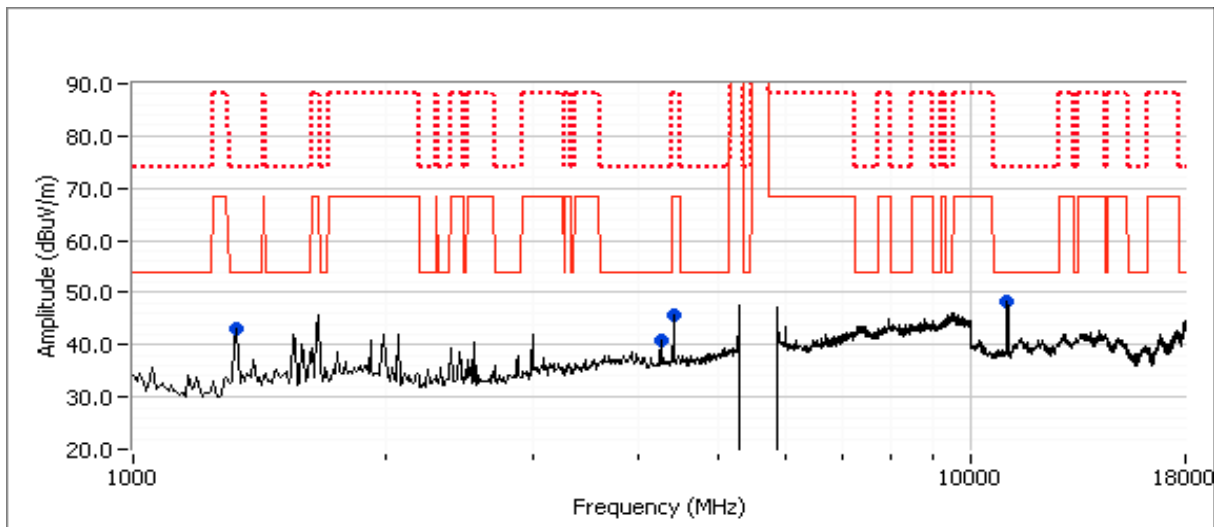

Client:	Nextivity, Inc.	Job Number:	J78899
Model:	Cel-Fi	T-Log Number:	T78964
Contact:	Rama Akella	Account Manager:	Sheareen Washington
Standard:	FCC Part 15 and 27	Class:	N/A

Run #1b: Center Channel

EUT S/N:102952000234

Spurious Radiated Emissions:

Frequency MHz	Level dBuV/m	Pol v/h	15.209 / 15E		Detector Pk/QP/Avg	Azimuth degrees	Height meters	Comments
			Limit	Margin				
11123.900	45.0	H	54.0	-9.0	AVG	91	1.6	MHz; VB: 10 Hz
11131.670	56.1	H	74.0	-17.9	PK	91	1.6	MHz; VB: 1 MHz
4264.040	41.0	V	54.0	-13.0	AVG	347	1.0	MHz; VB: 10 Hz
4263.960	47.0	V	74.0	-27.0	PK	347	1.0	MHz; VB: 1 MHz
4450.570	45.3	H	68.3	-23.0	AVG	240	1.0	MHz; VB: 10 Hz
4450.480	49.8	H	88.3	-38.5	PK	240	1.0	MHz; VB: 1 MHz
1330.370	29.9	V	54.0	-24.1	AVG	14	1.1	MHz; VB: 10 Hz
1332.240	49.3	V	74.0	-24.7	PK	14	1.1	MHz; VB: 1 MHz

- Note 1: For emissions in restricted bands, the limit of 15.209 was used. For all other emissions, the **average** limit was set to -27dBm/MHz (~68dBuV/m).
- Note 2: From 18-40 GHz, a near field scan of emissions from the EUT was performed and nothing was observed above the noise floor of the test equipment.

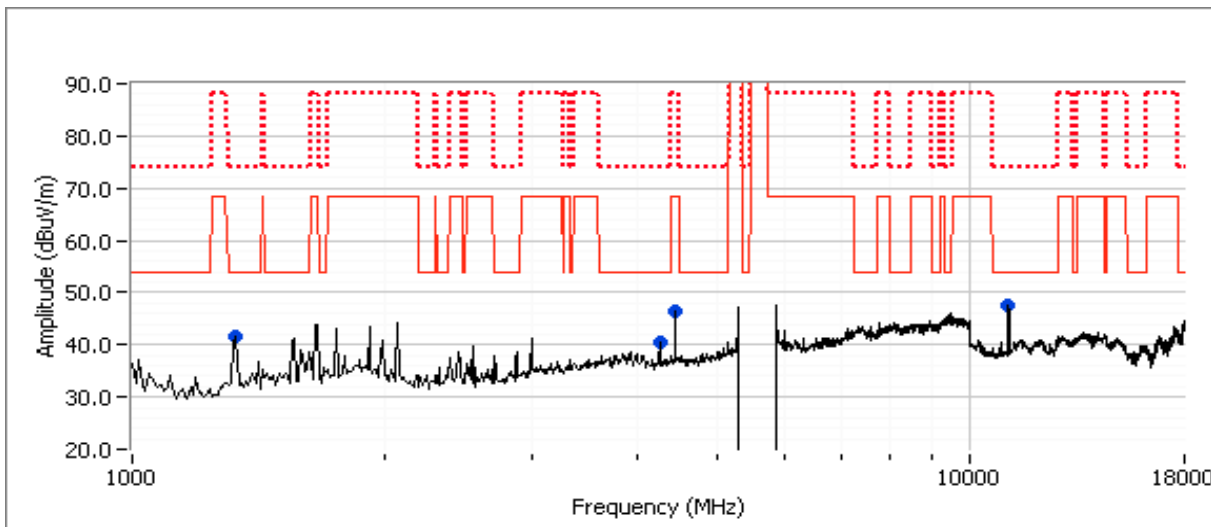

Client: Nextivity, Inc.	Job Number: J78899
Model: Cel-Fi	T-Log Number: T78964
Contact: Rama Akella	Account Manager: Sheareen Washington
Standard: FCC Part 15 and 27	Class: N/A

Run #1c: High Channel (5670 MHz Macro)

EUT S/N:102952000234

Spurious Radiated Emissions:

Frequency MHz	Level dBuV/m	Pol v/h	15.209 / 15E		Detector Pk/QP/Avg	Azimuth degrees	Height meters	Comments
			Limit	Margin				
11345.560	52.4	H	54.0	-1.6	AVG	71	1.5	MHz; VB: 10 Hz
11343.030	64.1	H	74.0	-9.9	PK	71	1.5	MHz; VB: 1 MHz
4535.110	50.8	V	54.0	-3.2	AVG	200	1.0	MHz; VB: 10 Hz
4535.030	53.3	V	74.0	-20.7	PK	200	1.0	MHz; VB: 1 MHz
1328.550	35.1	V	54.0	-18.9	AVG	103	1.1	MHz; VB: 10 Hz
1328.890	48.2	V	74.0	-25.8	PK	103	1.1	MHz; VB: 1 MHz

Note 1: For emissions in restricted bands, the limit of 15.209 was used. For all other emissions, the **average** limit was set to -27dBm/MHz (~68dBuV/m).

Note 2: From 18-40 GHz, a near field scan of emissions from the EUT was performed and nothing was observed above the noise floor of the test equipment.

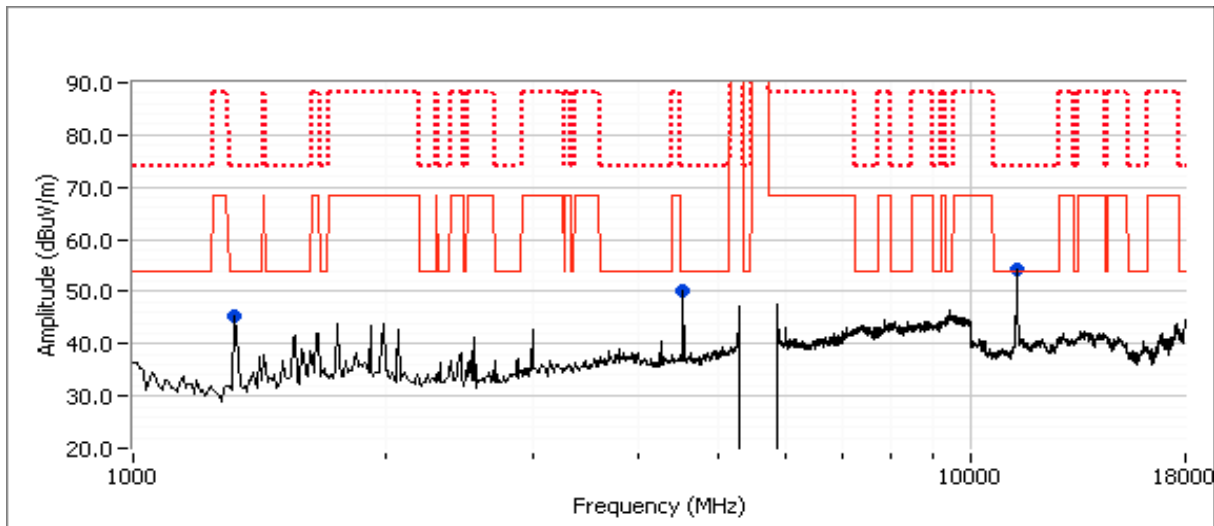

Client:	Nextivity, Inc.	Job Number:	J78899
Model:	Cel-Fi	T-Log Number:	T78964
Contact:	Rama Akella	Account Manager:	Sheareen Washington
Standard:	FCC Part 15 and 27	Class:	N/A

RSS 210 and FCC 15.407 (UNII) Radiated Emissions

Test Specific Details

Objective: The objective of this test session is to perform final qualification testing of the EUT with respect to the specification listed above.

General Test Configuration

The EUT and all local support equipment were located on the turntable for radiated spurious emissions testing.

For radiated emissions testing the measurement antenna was located 3 meters from the EUT.

Ambient Conditions: 5/7/2010
 Temperature: 20 °C
 Rel. Humidity: 32 %

Summary of Results

Run #	Channel	Test Performed	Limit	Result / Margin
1	5470 - 5725MHz, Low, Middle and High	Power	15.407(a) (1), (2)	15.3 dBm
		PSD	15.407(a) (1), (2)	0.4 dBm
		Peak Excursion	15.407(a) (6)	10.6 dB
		26dB Bandwidth	15.407	39.4 MHz
		99% Bandwidth	RSS 210	33.0 MHz

Modifications Made During Testing

The following modifications were made to the EUT prior to testing in order to comply with the requirements of the standard:
 Increased PA Bias voltage; Added 3dB attenuator between IC and PA.

Deviations From The Standard

No deviations were made from the requirements of the standard.



EMC Test Data

Client:	Nextivity, Inc.	Job Number:	J78899
Model:	Cel-Fi	T-Log Number:	T78964
		Account Manager:	Sheareen Washington
Contact:	Rama Akella		
Standard:	FCC Part 15 and 27	Class:	N/A

Run #1, Radiated Spurious Emissions, 30 - 40,000 MHz. Operation in the 5470-5725 MHz Band

Date of Test: 5/7/2010 Config. Used: 1
 Test Engineer: David W. Bare Config Change: None
 Test Location: Chamber #3 EUT Voltage: 120V/60Hz

Run #1a: Power Measurements from Field Strength

EUT Antenna Gain (dBi): 3.6

Fundamental Signal Field Strength

Frequency	Level	Pol	15.209 / 15.247		Detector	Azimuth	Height	Comments
MHz	dB μ V/m	v/h	Limit	Margin	Pk/QP/Avg	degrees	meters	
5524.200	95.0	V	NA	-	AVG	340	1.0	POS; RB 1 MHz; VB: 10 Hz
5524.200	104.6	V	NA	-	PK	340	1.0	POS; RB 1 MHz; VB: 10 MHz
5563.200	95.7	V	NA	-	AVG	348	1.0	POS; RB 1 MHz; VB: 10 Hz
5563.200	105.2	V	NA	-	PK	348	1.0	POS; RB 1 MHz; VB: 10 MHz
5668.800	94.5	V	NA	-	AVG	341	1.1	POS; RB 1 MHz; VB: 10 Hz
5668.800	104.0	V	NA	-	PK	341	1.1	POS; RB 1 MHz; VB: 10 MHz
5668.800	96.5	H	NA	-	AVG	65	1.1	POS; RB 1 MHz; VB: 10 Hz
5668.800	107.0	H	NA	-	PK	65	1.1	POS; RB 1 MHz; VB: 10 MHz
5563.200	96.3	H	NA	-	AVG	63	1.0	POS; RB 1 MHz; VB: 10 Hz
5563.200	106.5	H	NA	-	PK	63	1.0	POS; RB 1 MHz; VB: 10 MHz
5523.360	96.1	H	NA	-	AVG	74	1.0	POS; RB 1 MHz; VB: 10 Hz
5523.350	106.0	H	NA	-	PK	74	1.0	POS; RB 1 MHz; VB: 10 MHz

Frequency (MHz)	Software Setting	Bandwidth		Output Power ¹ dBm		Power (Watts)	PSD ² dBm/MHz			Result
		26dB	99% ⁴	Calculated	Limit		Calculated	FCC Limit	RSS Limit ³	
5524.2	Note 5	39.4	33.0	14.1	24.0	0.026	-0.4	11.0	11.0	Pass
5563.2	Note 5	39.3	32.9	14.6	24.0	0.029	-0.1	11.0	11.0	Pass
5668.8	Note 5	38.7	32.9	15.3	24.0	0.034	0.4	11.0	11.0	Pass

Note 1: Output power measured using a spectrum analyzer reading in dBm corrected to field strength by adding antenna factor + cable loss and converted to EIRP value by adding 11.7dB (-95.3 dB μ V/m -> dBm + 107 dBm -> dB μ V). This is noted as Amp corr in plots. Subtracting the EUT antenna gain from this value results in output power (see plots below):
 RBW=1MHz, VB=3 MHz, sample detector, power averaging on (transmitted signal was continuous) and power integration over 50 MHz (method 1 of DA-02-2138A1).

Note 2: Measured using the same analyzer settings used for output power.

Note 3: For RSS-210 the limit for the 5150 - 5250 MHz band accounts for the antenna gain as the maximum eirp allowed is 10dBm/MHz. The limits are also corrected for instances where the highest measured value of the PSD exceeds the average PSD (calculated from the measured power divided by the measured 99% bandwidth) by more than 3dB by the amount that the measured value exceeds the average by more than 3dB.

Note 4: 99% Bandwidth measured in accordance with RSS GEN - RB > 1% of span and VB >=3xRB

Note 5: Power settings - Chain 1: VGA set to 6 and Power Amp on; Chain 2: VGA set to 5 and Power Amp on

Client: Nextivity, Inc.	Job Number: J78899
Model: Cel-Fi	T-Log Number: T78964
Contact: Rama Akella	Account Manager: Sheareen Washington
Standard: FCC Part 15 and 27	Class: N/A

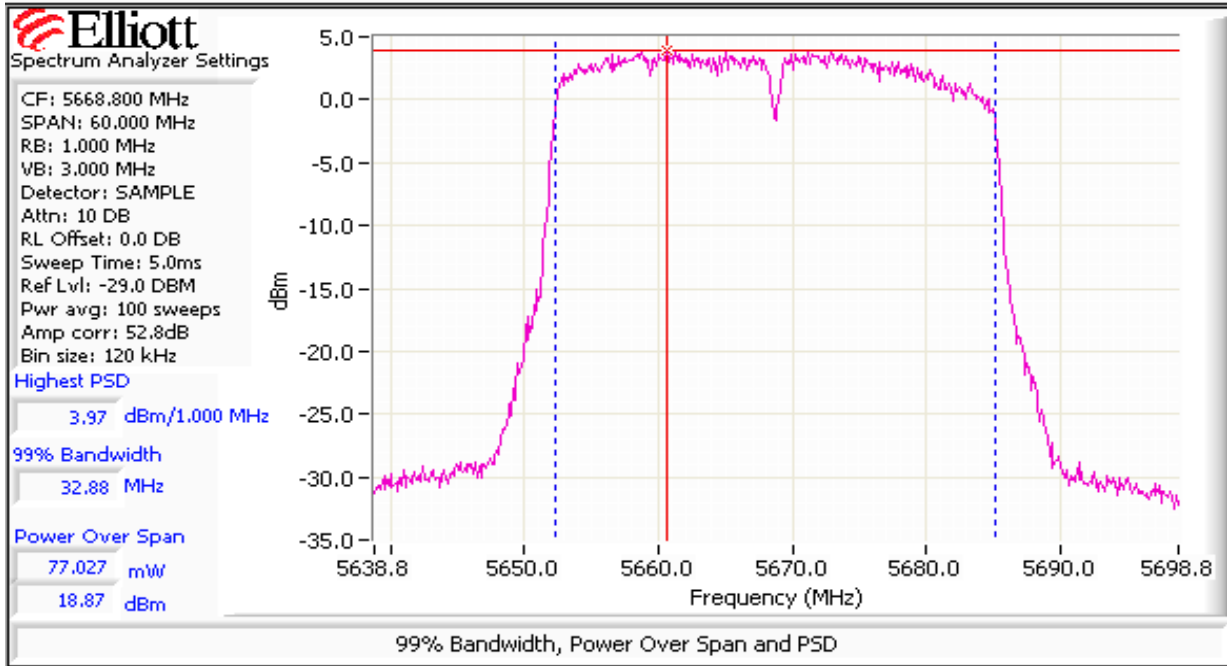

Peak Excursion Measurement

Device meets the requirement for the peak excursion

Freq	Peak Excursion(dB)	
(MHz)	Value	Limit
5524.2	10.3	13.0
5563.2	10.6	13.0
5668.8	10.5	13.0

Client: Nextivity, Inc.	Job Number: J78899
Model: Cel-Fi	T-Log Number: T78964
Contact: Rama Akella	Account Manager: Sheareen Washington
Standard: FCC Part 15 and 27	Class: N/A

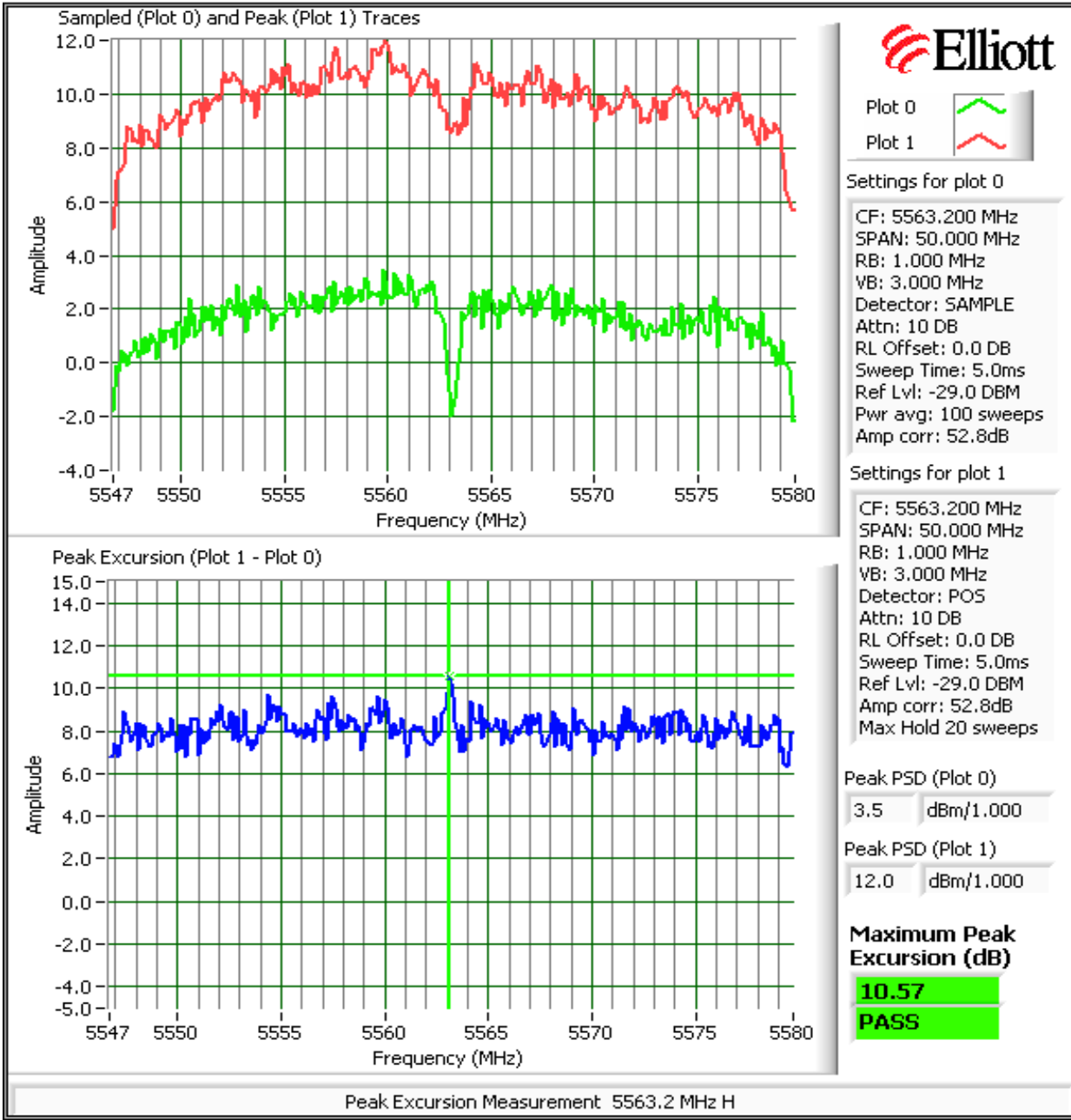

Client: Nextivity, Inc.	Job Number: J78899
Model: Cel-Fi	T-Log Number: T78964
	Account Manager: Sheareen Washington
Contact: Rama Akella	
Standard: FCC Part 15 and 27	Class: N/A

RSS 210 and FCC 15.407 (UNII) Radiated Spurious Emissions

Test Specific Details

Objective: The objective of this test session is to perform final qualification testing of the EUT with respect to the specification listed above.

Date of Test: 5/7/2010
 Test Engineer: David W. Bare
 Test Location: FT Chamber#3

Config. Used: 1
 Config Change: None
 EUT Voltage: 120V/60Hz

General Test Configuration

The EUT and all local support equipment were located on the turntable for radiated spurious emissions testing. All remote support equipment was located approximately 30 meters from the EUT with all I/O connections running on top of the groundplane or routed in overhead in the GR-1089 test configuration.

For radiated emissions testing the measurement antenna was located 3 meters from the EUT.

Ambient Conditions: Temperature: 20 °C
 Rel. Humidity: 32 %

Summary of Results

Run #	Mode	Channel	Power Setting	Test Performed	Limit	Result / Margin
1	-	5470-5725 Low	Note 1	Restricted Band Edge at 5460 and 5470 MHz	15.209	45.3dBµV/m @ 5460.0MHz (-8.7dB)
2	-	5470-5725 High	Note 1	Restricted Band Edge at 5725 MHz	15.209	50.4dBµV/m @ 5725.3MHz (-17.9dB)

Modifications Made During Testing

The following modifications were made to the EUT prior to testing in order to comply with the requirements of the standard:
 Increased PA Bias voltage; Added 3dB attenuator between IC and PA.

Deviations From The Standard

No deviations were made from the requirements of the standard.

Note 1: Power settings - Chain 1: VGA set to 6 and Power Amp on; Chain 2: VGA set to 5 and Power Amp on

Client: Nextivity, Inc.	Job Number: J78899
Model: Cel-Fi	T-Log Number: T78964
Contact: Rama Akella	Account Manager: Sheareen Washington
Standard: FCC Part 15 and 27	Class: N/A

Run #1, Radiated Spurious Emissions, Band Edge, Operation in the 5470-5725 MHz Band

RB 1 MHz; VB 10 Hz = Black trace, RB = VB = 1 MHz = Blue trace, Vertical

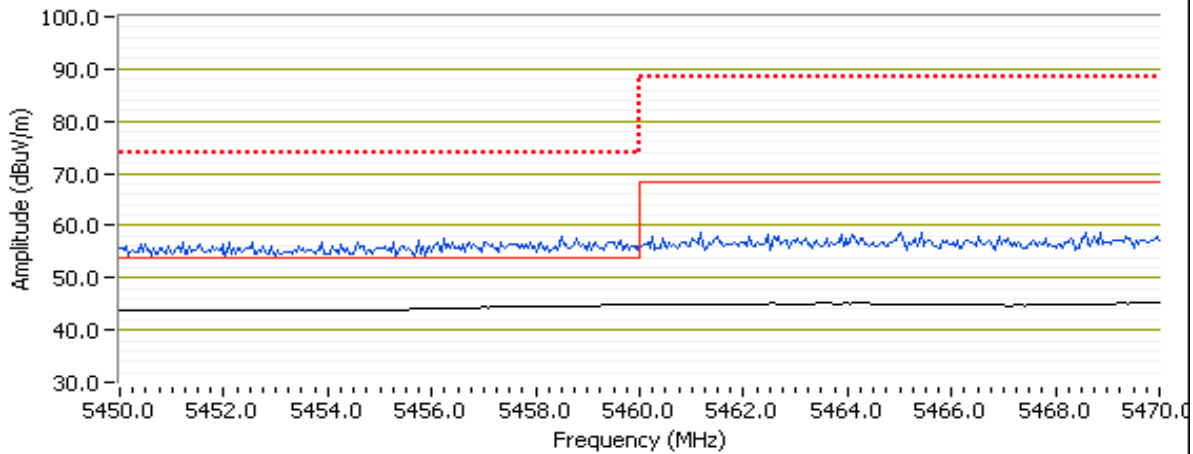

RB 1 MHz; VB 10 Hz = Black trace, RB = VB = 1 MHz = Blue trace, Horizontal

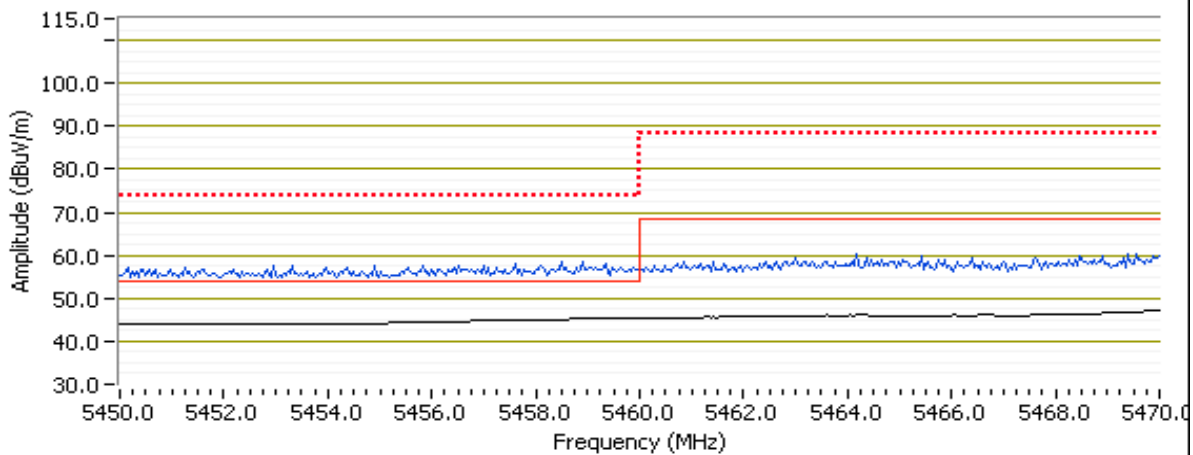



EMC Test Data

Client:	Nextivity, Inc.	Job Number:	J78899
Model:	Cel-Fi	T-Log Number:	T78964
Contact:	Rama Akella	Account Manager:	Sheareen Washington
Standard:	FCC Part 15 and 27	Class:	N/A

5460 MHz and 5470 MHz Band Edge Signal Radiated Field Strength

Frequency MHz	Level dB μ V/m	Pol v/h	FCC 15.209		Detector Pk/QP/Avg	Azimuth degrees	Height meters	Comments
			Limit	Margin				
5460.000	45.3	H	54.0	-8.7	AVG	74	1.0	POS; RB 1 MHz; VB: 10 Hz
5457.500	57.8	H	74.0	-16.2	PK	74	1.0	POS; RB 1 MHz; VB: 10 MHz
5470.000	47.2	H	68.3	-21.1	AVG	74	1.0	POS; RB 1 MHz; VB: 10 Hz
5465.990	59.4	H	88.3	-28.9	PK	74	1.0	POS; RB 1 MHz; VB: 10 MHz
5459.980	44.8	V	54.0	-9.2	AVG	340	1.0	POS; RB 1 MHz; VB: 10 Hz
5458.860	58.1	V	74.0	-15.9	PK	340	1.0	POS; RB 1 MHz; VB: 10 MHz
5469.820	46.7	V	68.3	-21.6	AVG	340	1.0	POS; RB 1 MHz; VB: 10 Hz
5468.350	59.0	V	88.3	-29.3	PK	340	1.0	POS; RB 1 MHz; VB: 10 MHz

Client: Nextivity, Inc.	Job Number: J78899
Model: Cel-Fi	T-Log Number: T78964
Contact: Rama Akella	Account Manager: Sheareen Washington
Standard: FCC Part 15 and 27	Class: N/A

Run #2, Radiated Spurious Emissions, Band Edge, Operation in the 5250-5350 MHz Band

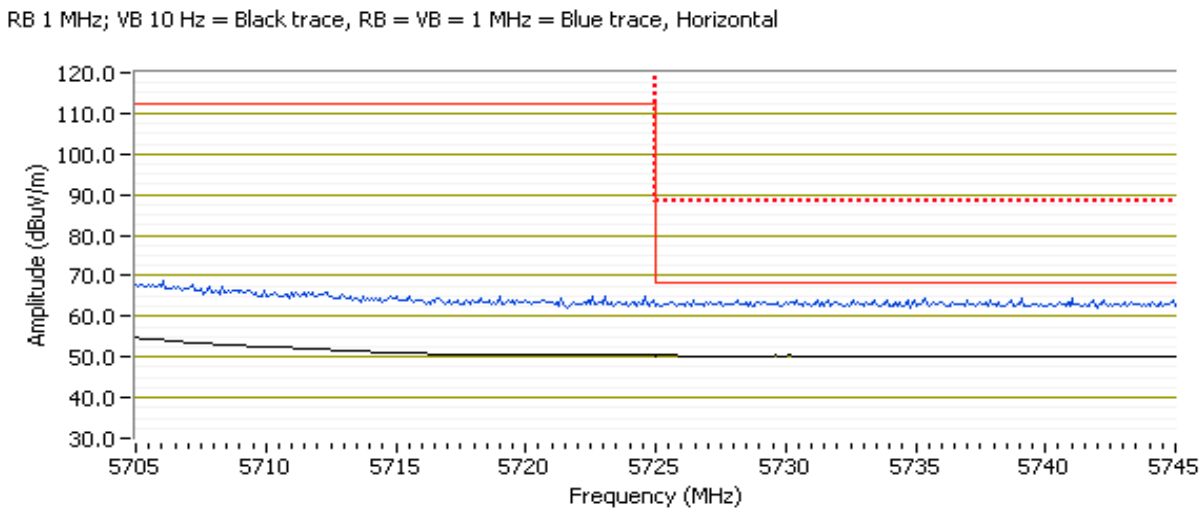
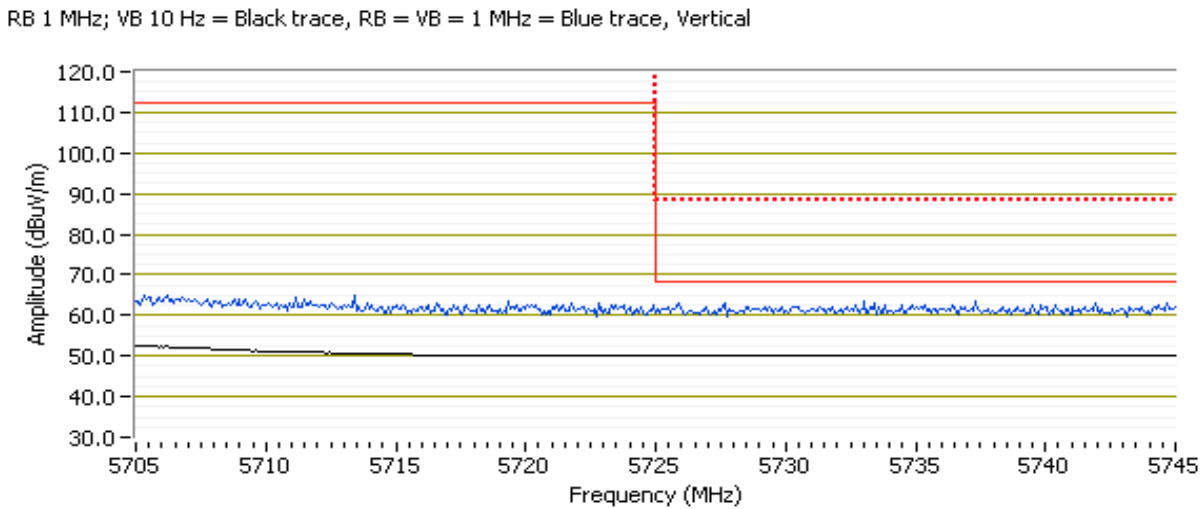

5725 MHz Band Edge Signal Radiated Field Strength

Frequency	Level	Pol	FCC 15.209		Detector	Azimuth	Height	Comments
MHz	dBuV/m	v/h	Limit	Margin	PK/QP/Avg	degrees	meters	
5725.340	50.4	H	68.3	-17.9	AVG	65	1.1	POS; RB 1 MHz; VB: 10 Hz
5727.410	64.0	H	88.3	-24.3	PK	65	1.1	POS; RB 1 MHz; VB: 10 MHz
5727.700	50.1	V	68.3	-18.2	AVG	341	1.1	POS; RB 1 MHz; VB: 10 Hz
5726.520	63.1	V	88.3	-25.2	PK	341	1.1	POS; RB 1 MHz; VB: 10 MHz

Client: Nextivity, Inc.	Job Number: J78899
Model: Cel-Fi	T-Log Number: T78964
	Account Manager: Sheareen Washington
Contact: Rama Akella	
Standard: FCC Part 15 and 27	Class: B

Conducted Emissions

(Elliott Laboratories Fremont Facility, Semi-Anechoic Chamber)

Test Specific Details

Objective: The objective of this test session is to perform final qualification testing of the EUT with respect to the specification listed above.

Date of Test: 5/6/2010
 Test Engineer: Vishal Narayan
 Test Location: Fremont Chamber #4

Config. Used: 1
 Config Change: None
 EUT Voltage: 230V/50Hz and 120V/60Hz

General Test Configuration

For tabletop equipment, the EUT was located on a wooden table inside the semi-anechoic chamber, 40 cm from a vertical coupling plane and 80cm from the LISN. A second LISN was used for all local support equipment.

Ambient Conditions:
 Temperature: 20 °C
 Rel. Humidity: 40 %

Summary of Results

Run #	Test Performed	Limit	Result	Margin
2	CE, AC Power, 120V/60Hz	FCC 15.207(a)	Pass	50.7dBµV @ 21.748MHz (-9.3dB)

Modifications Made During Testing

No modifications were made to the EUT during testing

Deviations From The Standard

No deviations were made from the requirements of the standard.

Client: Nextivity, Inc.	Job Number: J78899
Model: Cel-Fi	T-Log Number: T78964
Contact: Rama Akella	Account Manager: Sheareen Washington
Standard: FCC Part 15 and 27	Class: B

Run #2: AC Power Port Conducted Emissions, 0.15 - 30MHz, 120V/60Hz
WU s/n:102952000234

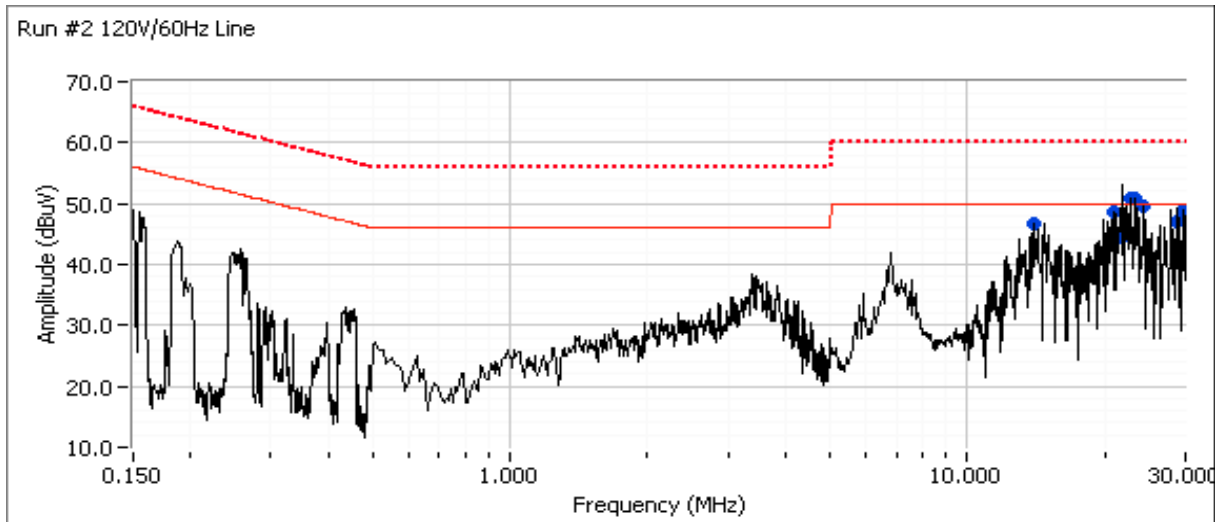
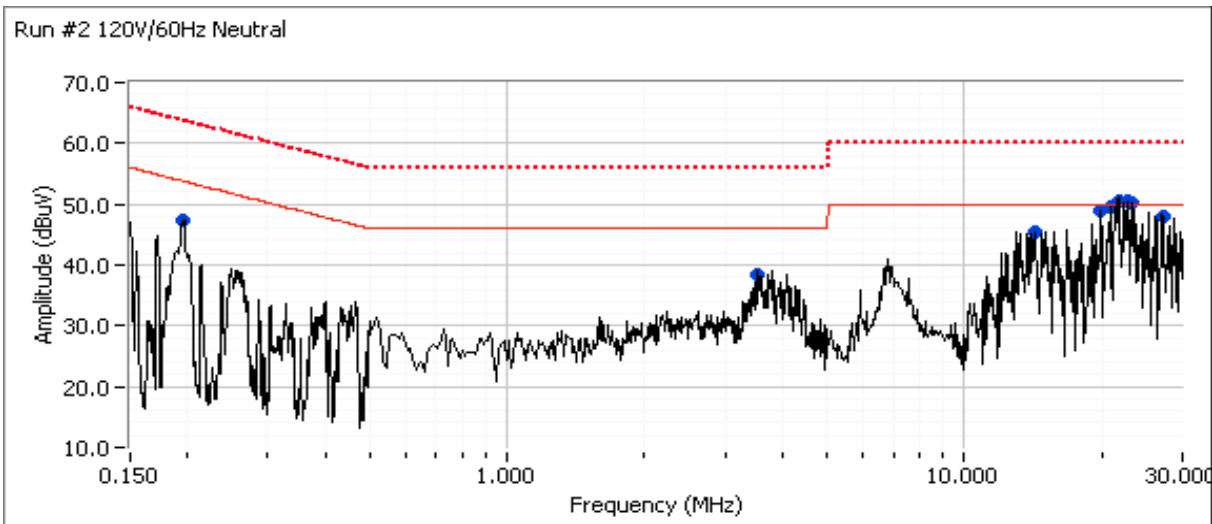



EMC Test Data

Client: Nextivity, Inc.	Job Number: J78899
Model: Cel-Fi	T-Log Number: T78964
	Account Manager: Sheareen Washington
Contact: Rama Akella	
Standard: FCC Part 15 and 27	Class: B

Continuation of Run #2

Preliminary peak readings captured during pre-scan (peak readings vs. average limit)

Frequency MHz	Level dBµV	AC Line	FCC 15.207(a)		Detector QP/Ave	Comments
			Limit	Margin		
22.658	50.7	Line	50.0	0.7	Peak	
23.324	50.7	Line	50.0	0.7	Peak	
21.839	50.6	Neutral	50.0	0.6	Peak	
22.658	50.6	Neutral	50.0	0.6	Peak	
23.388	50.1	Neutral	50.0	0.1	Peak	
24.296	49.6	Line	50.0	-0.4	Peak	
20.839	49.5	Neutral	50.0	-0.5	Peak	
20.019	48.8	Neutral	50.0	-1.2	Peak	
29.756	48.8	Line	50.0	-1.2	Peak	
20.839	48.6	Line	50.0	-1.4	Peak	
27.209	48.1	Neutral	50.0	-1.9	Peak	
28.845	47.0	Line	50.0	-3.0	Peak	
13.923	46.7	Line	50.0	-3.3	Peak	
14.197	45.4	Neutral	50.0	-4.6	Peak	
21.748	44.4	Line	50.0	-5.6	Peak	
0.196	47.2	Neutral	53.8	-6.6	Peak	
3.548	38.4	Neutral	46.0	-7.6	Peak	

Final quasi-peak and average readings

Frequency MHz	Level dBµV	AC Line	FCC 15.207(a)		Detector QP/Ave	Comments
			Limit	Margin		
21.748	50.7	Line	60.0	-9.3	QP	QP (1.00s)
22.658	50.6	Line	60.0	-9.4	QP	QP (1.00s)
22.658	50.5	Neutral	60.0	-9.5	QP	QP (1.00s)
21.839	50.4	Neutral	60.0	-9.6	QP	QP (1.00s)
28.845	48.5	Line	60.0	-11.5	QP	QP (1.00s)
29.756	48.4	Line	60.0	-11.6	QP	QP (1.00s)
20.839	48.1	Neutral	60.0	-11.9	QP	QP (1.00s)
20.839	48.0	Line	60.0	-12.0	QP	QP (1.00s)
23.388	47.7	Neutral	60.0	-12.3	QP	QP (1.00s)
24.296	46.6	Line	60.0	-13.4	QP	QP (1.00s)
27.209	46.3	Neutral	60.0	-13.7	QP	QP (1.00s)
20.019	46.0	Neutral	60.0	-14.0	QP	QP (1.00s)
13.923	45.5	Line	60.0	-14.5	QP	QP (1.00s)
21.839	33.4	Neutral	50.0	-16.6	AVG	AVG (0.10s)
21.748	33.3	Line	50.0	-16.7	AVG	AVG (0.10s)
22.658	32.9	Neutral	50.0	-17.1	AVG	AVG (0.10s)



EMC Test Data

Client: Nextivity, Inc.	Job Number: J78899
Model: Cel-Fi	T-Log Number: T78964
	Account Manager: Sheareen Washington
Contact: Rama Akella	
Standard: FCC Part 15 and 27	Class: B

Continuation of Run #2

Frequency MHz	Level dB μ V	AC Line	FCC 15.207(a)		Detector QP/Ave	Comments
			Limit	Margin		
22.658	32.4	Line	50.0	-17.6	AVG	AVG (0.10s)
23.324	42.4	Line	60.0	-17.6	QP	QP (1.00s)
14.197	41.9	Neutral	60.0	-18.1	QP	QP (1.00s)
0.196	44.5	Neutral	63.8	-19.3	QP	QP (1.00s)
0.196	34.1	Neutral	53.8	-19.7	AVG	AVG (0.10s)
20.839	29.8	Line	50.0	-20.2	AVG	AVG (0.10s)
23.388	29.1	Neutral	50.0	-20.9	AVG	AVG (0.10s)
20.839	28.9	Neutral	50.0	-21.1	AVG	AVG (0.10s)
20.019	28.1	Neutral	50.0	-21.9	AVG	AVG (0.10s)
27.209	27.4	Neutral	50.0	-22.6	AVG	AVG (0.10s)
23.324	27.3	Line	50.0	-22.7	AVG	AVG (0.10s)
28.845	27.3	Line	50.0	-22.7	AVG	AVG (0.10s)
29.756	27.0	Line	50.0	-23.0	AVG	AVG (0.10s)
24.296	26.9	Line	50.0	-23.1	AVG	AVG (0.10s)
3.548	32.3	Neutral	56.0	-23.7	QP	QP (1.00s)
13.923	25.3	Line	50.0	-24.7	AVG	AVG (0.10s)
3.548	21.1	Neutral	46.0	-24.9	AVG	AVG (0.10s)
14.197	23.0	Neutral	50.0	-27.0	AVG	AVG (0.10s)

Appendix C Photographs of Test Configurations

Uploaded as a separate exhibit

Appendix D Proposed FCC ID Label & Label Location

Uploaded as a separate exhibit

Appendix E Detailed Photographs

Uploaded as a separate exhibit

Appendix F Operator's Manual

Uploaded as a separate exhibit

Appendix G Block Diagram

Uploaded as a separate exhibit

Appendix H Schematic Diagrams

Uploaded as a separate exhibit

Appendix I Theory of Operation

Uploaded as a separate exhibit

Appendix J Parts List

Uploaded as a separate exhibit

Appendix K RF Exposure Information

Uploaded as a separate exhibit