

Radio Test Report

***FCC Part 22 and RSS 132
824 MHz to 849 MHz***

Model: CELFI-RS225WU

IC CERTIFICATION #: 9298A-CRS225WU
FCC ID: YETCELFIR225WU

APPLICANT: Nextivity Inc.
12230 World Trade Drive Suite 250
San Diego, CA 92128

TEST SITE(S): Elliott Laboratories
41039 Boyce Road.
Fremont, CA. 94538-2435

IC SITE REGISTRATION #: 2845B-3; 2845B-4, 2845B-5, 2845B-7

REPORT DATE: May 9, 2012

FINAL TEST DATES: March 15, 22, 23, 29, April 1, 11 and May 4,
2012

TOTAL NUMBER OF PAGES: 60

PROGRAM MGR /
TECHNICAL REVIEWER:

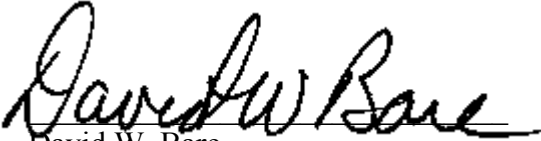

David W. Bare
Chief Engineer

QUALITY ASSURANCE DELEGATE /
FINAL REPORT PREPARER:

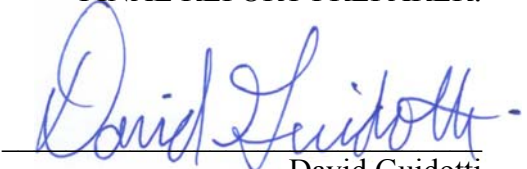

David Guidotti
Senior Technical Writer



Elliott Laboratories is accredited by the A2LA, certificate number 0214.26, to perform the test(s) listed in this report, except where noted otherwise. This report and the information contained herein represent the results of testing test articles identified and selected by the client performed to specifications and/or procedures selected by the client. National Technical Systems (NTS) makes no representations, expressed or implied, that such testing is adequate (or inadequate) to demonstrate efficiency, performance, reliability, or any other characteristic of the articles being tested, or similar products. This report should not be relied upon as an endorsement or certification by NTS of the equipment tested, nor does it represent any statement whatsoever as to its merchantability or fitness of the test article, or similar products, for a particular purpose. This report shall not be reproduced except in full

REVISION HISTORY

| Rev# | Date | Comments | Modified By |
|------|------------|---------------|-------------|
| - | 05-09-2012 | First release | |

TABLE OF CONTENTS

| | |
|--|-----------|
| REVISION HISTORY | 2 |
| TABLE OF CONTENTS | 3 |
| SCOPE..... | 4 |
| OBJECTIVE | 5 |
| STATEMENT OF COMPLIANCE..... | 5 |
| DEVIATIONS FROM THE STANDARDS..... | 5 |
| TEST RESULTS..... | 6 |
| FCC PART 22 AND RSS-132 (HANDSET OR OTHER UE) | 6 |
| EXTREME CONDITIONS | 7 |
| MEASUREMENT UNCERTAINTIES..... | 7 |
| EQUIPMENT UNDER TEST (EUT) DETAILS..... | 8 |
| GENERAL..... | 8 |
| ANTENNA SYSTEM | 8 |
| ENCLOSURE..... | 8 |
| MODIFICATIONS..... | 8 |
| SUPPORT EQUIPMENT | 8 |
| EUT INTERFACE PORTS | 9 |
| EUT OPERATION | 9 |
| TESTING | 10 |
| GENERAL INFORMATION..... | 10 |
| RF PORT MEASUREMENT PROCEDURES | 11 |
| OUTPUT POWER..... | 11 |
| BANDWIDTH MEASUREMENTS | 12 |
| CONDUCTED SPURIOUS EMISSIONS..... | 12 |
| TRANSMITTER MASK MEASUREMENTS..... | 13 |
| FREQUENCY STABILITY..... | 13 |
| TRANSIENT FREQUENCY BEHAVIOR:..... | 13 |
| RADIATED EMISSIONS MEASUREMENTS..... | 14 |
| INSTRUMENTATION | 15 |
| FILTERS/ATTENUATORS | 15 |
| ANTENNAS..... | 15 |
| ANTENNA MAST AND EQUIPMENT TURNTABLE..... | 15 |
| SAMPLE CALCULATIONS | 16 |
| SAMPLE CALCULATIONS - CONDUCTED SPURIOUS EMISSIONS | 16 |
| SAMPLE CALCULATIONS –RADIATED FIELD STRENGTH..... | 16 |
| SAMPLE CALCULATIONS –RADIATED POWER..... | 17 |
| RECEIVER RADIATED SPURIOUS EMISSIONS SPECIFICATION LIMITS | 18 |
| APPENDIX A TEST EQUIPMENT CALIBRATION DATA | 19 |
| APPENDIX B TEST DATA | 20 |
| END OF REPORT | 60 |

SCOPE

Tests have been performed on the Nextivity Inc. model CELFI-RS225WU, pursuant to the relevant requirements of the following standard(s) in order to obtain device certification against the regulatory requirements of the Federal Communications Commission and Industry Canada.

- Code of Federal Regulations (CFR) Title 47 Part 2
- Industry Canada RSS-Gen Issue 3
- CFR 47 Part 22
- RSS-132 Issue 2, Rev. 1 September 2005 Cellular Telephones Employing New Technologies Operating in the Bands 824-849 MHz and 869-894 MHz

Conducted and radiated emissions data has been collected, reduced, and analyzed within this report in accordance with measurement guidelines set forth in the following reference standards and as outlined in Elliott Laboratories test procedures:

ANSI C63.4:2003
ANSI TIA-603-C August 17, 2004

The intentional radiator above has been tested in a simulated typical installation to demonstrate compliance with the relevant Industry Canada performance and procedural standards.

Every practical effort was made to perform an impartial test using appropriate test equipment of known calibration. All pertinent factors have been applied to reach the determination of compliance.

The test results recorded herein are based on a single type test of the Nextivity Inc. model CELFI-RS225WU and therefore apply only to the tested sample. The sample was selected and prepared by Steve Van Skike of Nextivity Inc.

OBJECTIVE

The primary objective of the manufacturer is compliance with the regulations outlined in the previous section.

Prior to marketing in the USA, the device requires certification. Prior to marketing in Canada, Class I transmitters, receivers and transceivers require certification.

Certification is a procedure where the manufacturer submits test data and technical information to a certification body and receives a certificate or grant of equipment authorization upon successful completion of the certification body's review of the submitted documents. Once the equipment authorization has been obtained, the label indicating compliance must be attached to all identical units, which are subsequently manufactured.

Maintenance of compliance is the responsibility of the manufacturer. Any modification of the product which may result in increased emissions should be checked to ensure compliance has been maintained (i.e., printed circuit board layout changes, different line filter, different power supply, harnessing or I/O cable changes, etc.).

STATEMENT OF COMPLIANCE

The tested sample of Nextivity Inc. model CELFI-RS225WU complied with the requirements of the standards and frequency bands declared in the scope of this test report.

Maintenance of compliance is the responsibility of the manufacturer. Any modifications to the product should be assessed to determine their potential impact on the compliance status of the device with respect to the standards detailed in this test report.

DEVIATIONS FROM THE STANDARDS

No deviations were made from the published requirements listed in the scope of this report.

TEST RESULTS**FCC Part 22 and RSS-132 (Handset or other UE)**

| FCC | Canada | Description | Measured | Limit | Result |
|---|--------------------------|---|----------------------------------|----------------------------|--------|
| Transmitter Modulation, output power and other characteristics | | | | | |
| §2.1033 (c) (5) § 22.905 | RSS 132 | Frequency Range | 826.4 – 846.6 MHz | 824-849 MHz | Pass |
| §2.1033 (c) (6) §2.1033 (c) (7) §2.1046 § 22.913(a) | RSS-132 4.4 | ERP | 89mW erp | 7 Watts erp | Pass |
| §2.1033 (c) (4) §2.1047 § 22.917(b) | RSS 132 4.5.1.1 | Emission types | WCDMA F9W | - | - |
| | | Emission mask Note 1 | < -13dBm at both band edges | -13dBm at band edge | Pass |
| | RSS GEN 4.4.1 | 99% Bandwidth | 4.060 MHz | - | - |
| §2.1049 | | Occupied Bandwidth | 4.060 MHz | - | - |
| Transmitter spurious emissions | | | | | |
| §2.1051 §2.1057 §22.917 | RSS 132 4.5 | At the antenna terminals | All < -40dBm | -13dBm | Pass |
| §2.1053 §2.1057 §22.917 | RSS 132 4.5 | Field strength | All < -33dBm erp | -13dBm erp | Pass |
| Receiver spurious emissions | | | | | |
| 15.109 | RSS GEN 7.2.3 Table 1 | Field strength | 36.2 dBuV/m | See limit table on page 18 | Pass |
| Other details | | | | | |
| §2.1055 §22.355 | RSS-132 4.3 | Frequency stability | 0 ppm | 2.5 ppm | Pass |
| §2.1093 | RS 102 | RF Exposure | 0.12mW/cm ² | 1.0mW/cm ² | Pass |
| §2.1033 (c) (8) | RSP 100 7.2 (a) | Final radio frequency amplifying circuit's dc voltages and currents for normal operation over the power range | Refer to operational description | - | - |
| - | - | Antenna Gain | 4.4 dBi | - | - |
| Notes | | | | | |
| Note 1 – The measurement at the channel edge is made in a reference bandwidth of 100kHz or at least 1% the 26dB emission bandwidth. For measurements more than 1MHz from the edge of the channel the measurement bandwidth is 100kHz. | | | | | |

EXTREME CONDITIONS

Frequency stability is determined over extremes of temperature and voltage. The extremes of voltage were 85 to 115 percent of the nominal value.

The extremes of temperature were -30°C to +50°C as specified in FCC §2.1055(a)(1).

MEASUREMENT UNCERTAINTIES

ISO/IEC 17025 requires that an estimate of the measurement uncertainties associated with the emissions test results be included in the report. The measurement uncertainties given below are based on a 95% confidence level (based on a coverage factor (k=2) and were calculated in accordance with NAMAS document NIS 81 and M3003.

| Measurement Type | Measurement Unit | Frequency Range | Expanded Uncertainty |
|---|------------------|--------------------------------|------------------------------|
| RF frequency | Hz | 25 to 7,000 MHz | 1.7×10^{-7} |
| RF power, conducted | dBm | 25 to 7,000 MHz | ± 0.52 dB |
| Conducted emission of transmitter | dBm | 25 to 40,000 MHz | ± 0.7 dB |
| Conducted emission of receiver | dBm | 25 to 40,000 MHz | ± 0.7 dB |
| Radiated emission (substitution method) | dBm | 25 to 40,000 MHz | ± 2.5 dB |
| Radiated emission (field strength) | dB μ V/m | 25 to 1,000 MHz 1 to 40 GHz | ± 3.6 dB ± 6.0 dB |

EQUIPMENT UNDER TEST (EUT) DETAILS**GENERAL**

The Nextivity Inc. model CELFI-RS225WU is half of a smart repeater system that receives a cell signal from a cell site, converts it to a signal in the 5 GHz ISM band & transmits that to another close by transceiver inside a building, which receives & converts it back to a cell signal. That cell signal is then transmitted to any cell phones in the building. The uplink from cell phones is this process in reverse. The EUT was treated as table-top equipment during testing to most closely simulate the end-user environment. The electrical rating of the EUT is 100-240 Volts, 50-60 Hz, 0.7 Amps.

The sample was received on March 13, 2012 and tested on March 15, 22, 23, 29, April 1, 11 and May 4, 2012. The EUT consisted of the following component(s):

| Company | Model | Description | Serial Number | FCC ID |
|---------------|------------------|-----------------------------|---------------|---------------------|
| Nextivity Inc | CELF- RS225WU | Smart cell band repeater | 150206000097 | YETCELF- RS225WU |

ANTENNA SYSTEM

The antenna is integral to the device.

ENCLOSURE

The WU enclosure is primarily constructed of plastic. It measures approximately 199mm H x 144mm W x 147mm D.

MODIFICATIONS

No modifications were made to the EUT during the time the product was at Elliott.

SUPPORT EQUIPMENT

No support equipment was used during testing.

EUT INTERFACE PORTS

The I/O cabling configuration during testing was as follows:

| Port | Connected To | Description | Cable(s) | |
|------------------------|-------------------------|----------------|------------------------|-----------|
| | | | Shielded or Unshielded | Length(m) |
| DC Power | External pwr supply out | 2 wire | Unshielded | 2 |
| External pwr supply in | AC Mains | Direct plug-in | NA | NA |

Note: The custom USB port was not connected during testing. Nextivity stated that this is for setup purposes and therefore would not normally be connected. The external antenna port was not connected during Tx testing.

EUT OPERATION

During emissions testing the EUT was transmitting at full power on the channel called out in the specific test, or receiving on the channel called out in the specific test.

TESTING**GENERAL INFORMATION**

Antenna port measurements were taken at the Elliott Laboratories test site located at 41039 Boyce Road, Fremont, CA 94538-2435.

Radiated spurious emissions measurements were taken at the Elliott Laboratories Anechoic Chambers and/or Open Area Test Site(s) listed below. The sites conform to the requirements of ANSI C63.4: 2003 *American National Standard for Methods of Measurement of Radio-Noise Emissions from Low-Voltage Electrical and Electronic Equipment in the Range of 9 kHz to 40 GHz* and CISPR 16-1-4:2007 - *Specification for radio disturbance and immunity measuring apparatus and methods Part 1-4: Radio disturbance and immunity measuring apparatus Ancillary equipment Radiated disturbances*. They are on file with the FCC and industry Canada.

| Site | Registration Numbers | | Location |
|-----------|----------------------|------------|---|
| | FCC | Canada | |
| Chamber 3 | 769238 | IC 2845B-3 | 41039 Boyce Road Fremont, CA 94538-2435 |
| Chamber 4 | 211948 | IC 2845B-4 | |
| Chamber 5 | 211948 | IC 2845B-5 | |
| Chamber 7 | A2LA Accredited | IC 2845B-7 | |

In the case of Open Area Test Sites, ambient levels are at least 6 dB below the specification limits with the exception of predictable local TV, radio, and mobile communications traffic.

Considerable engineering effort has been expended to ensure that the facilities conform to all pertinent requirements.

RF PORT MEASUREMENT PROCEDURES

Conducted measurements are performed with the EUT's rf input/output connected to the input of a spectrum analyzer, power meter or modulation analyzer. When required an attenuator, filter and/or dc block is placed between the EUT and the spectrum analyzer to avoid overloading the front end of the measurement device. Measurements are corrected for the insertion loss of the attenuators and cables inserted between the rf port of the EUT and the measurement equipment.

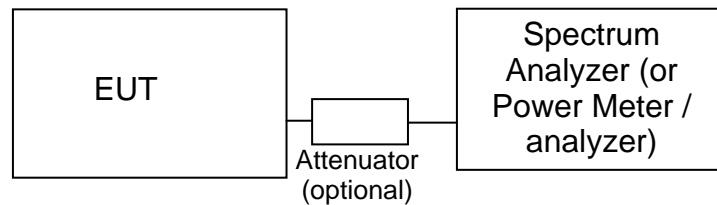

Test Configuration for Antenna Port Measurements

For devices with an integral antenna the output power and spurious emissions are measured as a field strength at a test distance of (typically) 3m and then converted to an eirp using a substitution measurement (refer to RADIATED EMISSIONS MEASUREMENTS). All other measurements are made as detailed below but with the test equipment connected to a measurement antenna directed at the EUT.

OUTPUT POWER

Output power is measured using a power meter and an average sensor head, a spectrum analyzer or a power meter and peak power sensor head as required by the relevant rule part(s). Where necessary measurements are gated to ensure power is only measured over periods that the device is transmitting.

Power measurements made directly on the rf power port are, when appropriate, converted to an EIRP by adding the gain of the highest gain antenna that can be used with the device under test, as specified by the manufacturer.

BANDWIDTH MEASUREMENTS

The 6dB, 20dB and/or 26dB signal bandwidth is measured in using the bandwidths recommended by ANSI C63.4. When required, the 99% bandwidth is measured using the methods detailed in RSS GEN. The measurement bandwidth is set to be at least 1% of the instrument's frequency span.

CONDUCTED SPURIOUS EMISSIONS

Initial scans are made using a peak detector (RBW=VBW) and using scan rates to ensure that the EUT transmits before the sweep moves out of each resolution bandwidth (for transmit mode measurements). Where the limits are expressed as an average power the spectrum analyzer is tuned to that frequency with a narrow span (wide enough to capture the emission and its sidebands) and the resolution and video bandwidths are adjusted as required by the reference measurement standards. For transmitter measurements the appropriate detector (average, peak, normal, sample, quasi-peak) is used when making measurements for licensed devices. For receiver conducted spurious measurements the detector is set to peak.

TRANSMITTER MASK MEASUREMENTS

The transmitter mask measurements are made using resolution bandwidths as specified in the pertinent rule part(s). Where narrower bandwidths are used the measurement is corrected to account for the reduced bandwidth by either using the adjacent channel power function of the spectrum analyzer to sum the power across the required measurement bandwidth. The frequency span of the analyzer is set to ensure the fundamental signal and all significant sidebands are displayed.

The top of the mask may be set by the total output power of the signal, the power of the unmodulated signal or the peak value of the signal in the reference bandwidth being used for the mask measurement.

FREQUENCY STABILITY

The EUT is placed inside a temperature chamber with all support and test equipment located outside of the chamber. The temperature is varied across the specified frequency range in 10 degree increments with frequency measurements made at each temperature step. The EUT is allowed enough time to stabilize at each temperature variation.

The spectrum analyzer is configured to give a 5- or 6-digit display for the marker-frequency function. The spectrum analyzer's built-in frequency counter is used to measure the maximum deviation of the fundamental frequency at each temperature. Where possible the device is set to transmit an unmodulated signal. Where this is not possible the frequency drift is determined by finding a stable point on the signal (e.g. the null at the centre of an OFDM signal) or by calculating a centre frequency based on the upper and lower XdB points (where X is typically 6dB or 10dB) on the signal's skirts.

TRANSIENT FREQUENCY BEHAVIOR:

The TIA/EIA 603 procedure is used to determine compliance with transient frequency timing requirements as the radio is keyed on and off.

The EUTs rf output is connected via a combiner/splitter to the test receiver/spectrum analyzer and to a diode detector. The test receiver or spectrum analyzer video output is connected to an oscilloscope, which is triggered by the output from the diode detector.

Plots showing Ton, T1, and T2 are made when turning on the transmitter and showing T3 when turning off the transmitter.

RADIATED EMISSIONS MEASUREMENTS

Receiver radiated spurious emissions measurements are made in accordance with ANSI C63.4:2003 by measuring the field strength of the emissions from the device at a specific test distance and comparing them to a field strength limit. Where the field strength limit is specified at a longer distance than the measurement distance the measurement is extrapolated to the limit distance.

Transmitter radiated spurious emissions are initially measured as a field strength. The eirp or erp limit as specified in the relevant rule part(s) is converted to a field strength at the test distance and the emissions from the EUT are then compared to that limit. Emissions within 20dB of this limit are the subjected to a substitution measurement.

All radiated emissions measurements are performed in two phases. A preliminary scan of emissions is conducted in either an anechoic chamber or on an OATS during which all significant EUT frequencies are identified with the system in a nominal configuration. At least two scans are performed across the complete frequency range of interest and at each operating frequency identified in the reference standard. One or more of these is with the antenna polarized vertically while the one or more of these is with the antenna polarized horizontally. Initial scans are made using a peak detector (RBW=VBW) and using scan rates to ensure that the EUT transmits before the sweep moves out of each resolution bandwidth (for transmit mode).

During the preliminary scans, the EUT is rotated through 360°, the antenna height is varied and cable positions are varied to determine the highest emission relative to the limit. For transmitter spurious emissions, where the limit is expressed as an effective radiated power, the eirp or erp is converted to a field strength limit.

Final measurements are made on an OATS or in a semi-anechoic chamber at the significant frequencies observed during the preliminary scan(s) using the same process of rotating the EUT and raising/lowering the measurement antenna to find the highest level of the emission. The field strength is recorded and, for receiver spurious emissions, compared to the field strength limit. For the final measurement the appropriate detectors (average, peak, normal, sample, quasi-peak) are used. For receiver measurements below 1GHz the detector is a Quasi-Peak detector, above 1GHz a peak detector is used and the peak value (RB=VB=1MHz) and average value (RB=1MHz, VB=10Hz) are recorded.

For transmitter spurious emissions, the radiated power of all emissions within 20dB of the calculated field strength limit are determined using a substitution measurement. The substitution measurement is made by replacing the EUT with an antenna of known gain (typically a dipole antenna or a double-ridged horn antenna), connected to a signal source. The output power of the signal generator is adjusted until the maximum field strength from the substitution antenna is similar to the field strength recorded from the EUT. The erp of the EUT is then calculated.

INSTRUMENTATION

An EMI receiver as specified in CISPR 16-1-1 is used for radiated emissions measurements. The receivers used can measure over the frequency range of 9 kHz up to 7000 MHz. These receivers allow both ease of measurement and high accuracy to be achieved. The receivers have Peak, Average, and CISPR (Quasi-peak) detectors built into their design so no external adapters are necessary.

For measurements above the frequency range of the receivers and for all conducted measurements a spectrum analyzer is utilized because it provides visibility of the entire spectrum along with the precision and versatility required to support engineering analysis.

Measurement bandwidths for the test instruments are set in accordance with the requirements of the standards referenced in this document.

Software control is used to correct the measurements for transducer factors (e.g. antenna) and the insertion loss of cables, attenuators and other series elements to obtain the final measurement value. This provides faster, more accurate readings by performing the conversions described under Sample Calculations within the Test Procedures section of this report. Results are exported in a graphic and/or tabular format, as appropriate.

FILTERS/ATTENUATORS

External filters and precision attenuators are often connected between the EUT antenna port or receiving antenna and the test receiver. This eliminates saturation effects and non-linear operation due to high amplitude transient events.

ANTENNAS

A combination of biconical, log periodic or bi-log antennas are used to cover the range from 30 MHz to 1000 MHz. Broadband antennas or tuned dipole antennas are used over the entire 25 to 1000 MHz frequency range as the reference antenna for substitution measurements.

Above 1000 MHz, a dual-ridge guide horn antenna or octave horn antenna are used as reference and measurement antennas.

The antenna calibration factors are included in site factors that are programmed into the test receivers and instrument control software when measuring the radiated field strength.

ANTENNA MAST AND EQUIPMENT TURNTABLE

The antennas used to measure the radiated electric field strength are mounted on a non-conductive antenna mast equipped with a motor-drive to vary the antenna height.

Table mounted devices are placed on a non-conductive table at a height of 80 centimeters above the floor. Floor mounted equipment is placed on the ground plane if the device is normally used on a conductive floor or separated from the ground plane by insulating material from 3 to 12 mm if the device is normally used on a non-conductive floor. The EUT is positioned on a motorized turntable to allow it to be rotated during testing to determine the angle with the highest level of emissions.

SAMPLE CALCULATIONS**SAMPLE CALCULATIONS - CONDUCTED SPURIOUS EMISSIONS**

Measurements are compared directly to the conducted emissions specification limit (decibel form). The calculation is as follows:

$$R_r - S = M$$

where:

$$\begin{aligned} R_r &= \text{Measured value in dBm} \\ S &= \text{Specification Limit in dBm} \\ M &= \text{Margin to Specification in +/- dB} \end{aligned}$$

SAMPLE CALCULATIONS - RADIATED FIELD STRENGTH

Measurements of radiated field strength are compared directly to the specification limit (decibel form). The receiver and/or control software corrects for cable loss, preamplifier gain, and antenna factor. The calculations are in the reverse direction of the actual signal flow, thus cable loss is added and the amplifier gain is subtracted. The Antenna Factor converts the voltage at the antenna coaxial connector to the field strength at the antenna elements.

A distance factor is used when measurements are made at a test distance that is different to the specified limit distance by using the following formula:

$$F_d = 20 * \text{LOG}_{10} (D_m/D_s)$$

where:

$$\begin{aligned} F_d &= \text{Distance Factor in dB} \\ D_m &= \text{Measurement Distance in meters} \\ D_s &= \text{Specification Distance in meters} \end{aligned}$$

For electric field measurements below 30MHz the extrapolation factor is either determined by making measurements at multiple distances or a theoretical value is calculated using the formula:

$$F_d = 40 * \text{LOG}_{10} (D_m/D_s)$$

The margin of a given emission peak relative to the limit is calculated as follows:

$$R_c = R_r + F_d$$

and

$$M = R_c - L_s$$

where:

$$R_r = \text{Receiver Reading in dBuV/m}$$

- F_d = Distance Factor in dB
 R_c = Corrected Reading in dBuV/m
 L_s = Specification Limit in dBuV/m
 M = Margin in dB Relative to Spec

SAMPLE CALCULATIONS –RADIATED POWER

The erp/eirp limits for transmitter spurious measurements are converted to a field strength in free space using the following formula:

$$E = \frac{\sqrt{30 P G}}{d}$$

where:

- E = Field Strength in V/m
 P = Power in Watts
 G = Gain of isotropic antenna (numeric gain) = 1
 D = measurement distance in meters

The field strength limit is then converted to decibel form (dBuV/m) and the margin of a given emission peak relative to the limit is calculated (refer to *SAMPLE CALCULATIONS –RADIATED FIELD STRENGTH*).

When substitution measurements are required (all signals with less than 20dB of margin relative to the calculated field strength limit) the eirp of the spurious emission is calculated using:

$$P_{EUT} = P_s - (E_s - E_{EUT})$$

and

$$P_s = G + P_{in}$$

where:

- P_s = effective isotropic radiated power of the substitution antenna (dBm)
 P_{in} = power input to the substitution antenna (dBm)
 G = gain of the substitution antenna (dBi)
 E_s = field strength the substitution antenna (dBm) at eirp P_s
 E_{EUT} = field strength measured from the EUT

Where necessary the effective isotropic radiated power is converted to effective radiated power by subtracting the gain of a dipole (2.2dBi) from the eirp value.

RECEIVER RADIATED SPURIOUS EMISSIONS SPECIFICATION LIMITS

The table below shows the limits for the spurious emissions from receivers as detailed in FCC Part 15.109, RSS 210 Table 2, RSS GEN Table 1 and RSS 310 Table 3. Note that receivers operating outside of the frequency range 30 MHz – 960 MHz are exempt from the requirements of 15.109.

| Frequency Range (MHz) | Limit (uV/m @ 3m) | Limit (dBuV/m @ 3m) |
|-----------------------|-------------------|---------------------|
| 30 to 88 | 100 | 40 |
| 88 to 216 | 150 | 43.5 |
| 216 to 960 | 200 | 46.0 |
| Above 960 | 500 | 54.0 |

Appendix A Test Equipment Calibration Data**Antenna Conducted, 15-Mar-12**

| <u>Manufacturer</u> | <u>Description</u> | <u>Model</u> | <u>Asset #</u> | <u>Cal Due</u> |
|---------------------|---|--------------|----------------|----------------|
| Anritsu | Anritsu 68347C Signal Generator, 10MHz-20GHz | 68347C | 1785 | 11/16/2012 |
| Agilent | PSA, Spectrum Analyzer, (installed options, 111, 115, 123, 1DS, B7J, HYX, | E4446A | 2139 | 2/23/2013 |

Antenna Conducted, 22-Mar-12

| <u>Manufacturer</u> | <u>Description</u> | <u>Model</u> | <u>Asset #</u> | <u>Cal Due</u> |
|---------------------|---|--------------|----------------|----------------|
| Rohde & Schwarz | Power Meter, Single Channel, +1795+1796 | NRVS | 1534 | 5/17/2012 |
| Anritsu | Anritsu 68347C Signal Generator, 10MHz-20GHz | 68347C | 1785 | 11/16/2012 |
| Agilent | PSA, Spectrum Analyzer, (installed options, 111, 115, 123, 1DS, B7J, HYX, | E4446A | 2139 | 2/23/2013 |

Radiated Spurious Emissions, 30 - 20,000 MHz, 23-Mar-12

| <u>Manufacturer</u> | <u>Description</u> | <u>Model</u> | <u>Asset #</u> | <u>Cal Due</u> |
|---------------------|------------------------------------|-----------------------|----------------|----------------|
| Hewlett Packard | SpecAn 9 KHz-26.5 GHz, Non-Program | 8563E | 284 | 1/13/2013 |
| EMCO | Antenna, Horn, 1-18GHz | 3115 | 868 | 6/8/2012 |
| Hewlett Packard | Microwave Preamplifier, 1-26.5GHz | 8449B | 870 | 2/23/2013 |
| Rohde & Schwarz | EMI Test Receiver, 20 Hz-40 GHz | ESIB40 (1088.7490.40) | 2493 | 12/9/2012 |

Radiated Spurious Emissions, 30 - 3,000 MHz, 29-Mar-12

| <u>Manufacturer</u> | <u>Description</u> | <u>Model</u> | <u>Asset #</u> | <u>Cal Due</u> |
|---------------------|------------------------------------|---------------|----------------|----------------|
| Hewlett Packard | SpecAn 9 KHz-26.5 GHz, Non-Program | 8563E | 284 | 1/13/2013 |
| Hewlett Packard | Microwave Preamplifier, 1-26.5GHz | 8449B | 870 | 2/23/2013 |
| EMCO | Antenna, Horn, 1-18 GHz (SA40-Red) | 3115 | 1142 | 8/2/2012 |
| Sunol Sciences | Biconilog, 30-3000 MHz | JB3 | 1549 | 5/25/2013 |
| Rohde & Schwarz | EMI Test Receiver, 20 Hz-7 GHz | ESIB7 | 1756 | 4/6/2012 |
| Hewlett Packard | Preamplifier, 100 kHz - 1.3 GHz | 8447D OPT 010 | 1826 | 5/17/2012 |

Frequency Stability, 29-Mar-12 and 11-Apr-12

| <u>Manufacturer</u> | <u>Description</u> | <u>Model</u> | <u>Asset #</u> | <u>Cal Due</u> |
|---------------------|---|--------------|----------------|----------------|
| Fluke Mfg. Inc. | Fluke True RMS Multimeter | 111 | 1557 | 3/8/2013 |
| Agilent | PSA, Spectrum Analyzer, (installed options, 111, 115, 123, 1DS, B7J, HYX, | E4446A | 2139 | 2/23/2013 |
| Thermotron | Temp Chamber (w/ F4 Watlow Controller) | S1.2 | 2170 | 7/8/2012 |

Radiated Emissions, 30 - 1,000 MHz, 4-May-12

| | | | | |
|-----------------|---------------------------------|---------------|------|-----------|
| Sunol Sciences | Biconilog, 30-3000 MHz | JB3 | 1549 | 25-May-13 |
| Rohde & Schwarz | EMI Test Receiver, 20 Hz-7 GHz | ESIB7 | 1756 | 06-Apr-12 |
| Hewlett Packard | Preamplifier, 100 kHz - 1.3 GHz | 8447D OPT 010 | 1826 | 17-May-12 |

Appendix B Test Data

T86829 Pages 21 - 59

| | | | |
|------------------------|--|-----------------|------------------|
| Client: | Nextivity Inc | Job Number: | J86441 |
| Model: | RS225 WU and RS225 CU | T-Log Number: | T86829 |
| Contact: | | Steve van Skike | Account Manager: |
| Emissions Standard(s): | RSS 132, RSS 133, FCC Part 22, FCC Part 24 | Class: | - |
| Immunity Standard(s): | - | Environment: | - |

EMC Test Data

For The

Nextivity Inc

Model

RS225 WU and RS225 CU

Date of Last Test: 5/4/2012

| | | | |
|-----------|--|------------------|---------------------|
| Client: | Nextivity Inc | Job Number: | J86441 |
| Model: | RS225 WU and RS225 CU | T-Log Number: | T86829 |
| Contact: | Steve van Skike | Account Manager: | Sheareen Washington |
| Standard: | RSS 132, RSS 133, FCC Part 22, FCC Part 24 | Class: | N/A |

RSS 132, RSS 133, FCC Part 22, FCC Part 24 Channel Power, PAR, OBW

Test Specific Details

Objective: The objective of this test session is to perform final qualification testing of the EUT with respect to the specification listed above.

Date of Test: 3/15/2012 0:00
 Test Engineer: Deniz
 Test Location: Lab#4

Config. Used: 1
 Config Change: None
 EUT Voltage: 120V/60Hz

Test Procedure:

WU was set to operate at maximum power at lowest, center and highest channels for Band V and Band II

Ambient Conditions:

Temperature: 20 °C
 Rel. Humidity: 32 %

RS225 WU Summary of Results

Channel Power

Antenna gain = 4.4 dBi

| Run # | Modulation Type | Channel number | Channel Frequency (MHz) | Channel Power (dBm) | Rule part |
|-------|-----------------|----------------|-------------------------|---------------------|----------------------|
| 1 | WCDMA | 4132 | 826.4 | 17.0 | RSS 132, FCC Part 22 |
| 2 | WCDMA | 4182 | 836.4 | 17.3 | RSS 132, FCC Part 22 |
| 3 | WCDMA | 4233 | 846.6 | 17.1 | RSS 132, FCC Part 22 |
| 4 | WCDMA | 9262 | 1852.4 | 19.1 | RSS 133, FCC Part 24 |
| 5 | WCDMA | 9400 | 1880.0 | 19.1 | RSS 133, FCC Part 24 |
| 6 | WCDMA | 9538 | 1907.6 | 18.9 | RSS 133, FCC Part 24 |

Occupied Bandwidth

| Run # | Modulation Type | Channel number | Channel Frequency (MHz) | Occupied Bandwidth | Type | Rule part |
|-------|-----------------|----------------|-------------------------|--------------------|-------|------------------------|
| 2 | WCDMA | 4182 | 836.4 | 4.060 MHz | 99% | RSS-Gen Issue 3, 4.6.1 |
| 5 | WCDMA | 9400 | 1880.0 | 4.060 MHz | 99% | RSS-Gen Issue 3, 4.6.1 |
| 2 | WCDMA | 4182 | 836.4 | 4.115 MHz | 26 dB | FCC Part 22.917 |
| 5 | WCDMA | 9400 | 1880.0 | 4.115 MHz | 26 dB | FCC Part 24.238 |

Peak-to-Average ratio

| Run # | Channel number | Channel Frequency | Peak Channel Power (dBm) | Av. Channel Power (dBm) | PAR (dB) | Rule part |
|-------|----------------|-------------------|--------------------------|-------------------------|----------|--------------------------|
| 5 | 9400 | 1880.0 | 25.50 | 19.11 | 6.39 | RSS 133, FCC Part 24.232 |

| | | | |
|-----------|--|------------------|---------------------|
| Client: | Nextivity Inc | Job Number: | J86441 |
| Model: | RS225 WU and RS225 CU | T-Log Number: | T86829 |
| Contact: | Steve van Skike | Account Manager: | Sheareen Washington |
| Standard: | RSS 132, RSS 133, FCC Part 22, FCC Part 24 | Class: | N/A |

Test Setup:

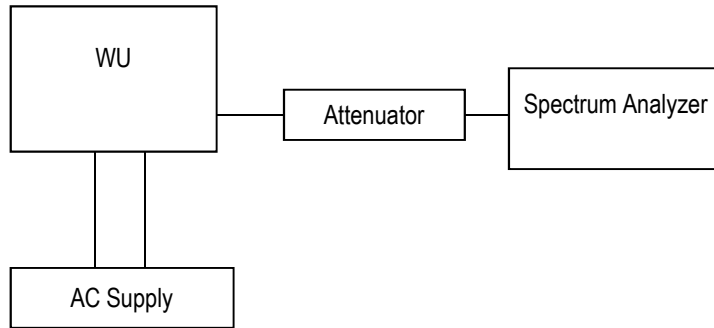

Modifications Made During Testing

No modifications were made to the EUT during testing

Deviations From The Standard

No deviations were made from the requirements of the standard.

| | |
|--|--------------------------------------|
| Client: Nextivity Inc | Job Number: J86441 |
| Model: RS225 WU and RS225 CU | T-Log Number: T86829 |
| Contact: Steve van Skike | Account Manager: Sheareen Washington |
| Standard: RSS 132, RSS 133, FCC Part 22, FCC Part 24 | Class: N/A |

Run #2 Channel 4182, Channel Power and 99% Bandwidth

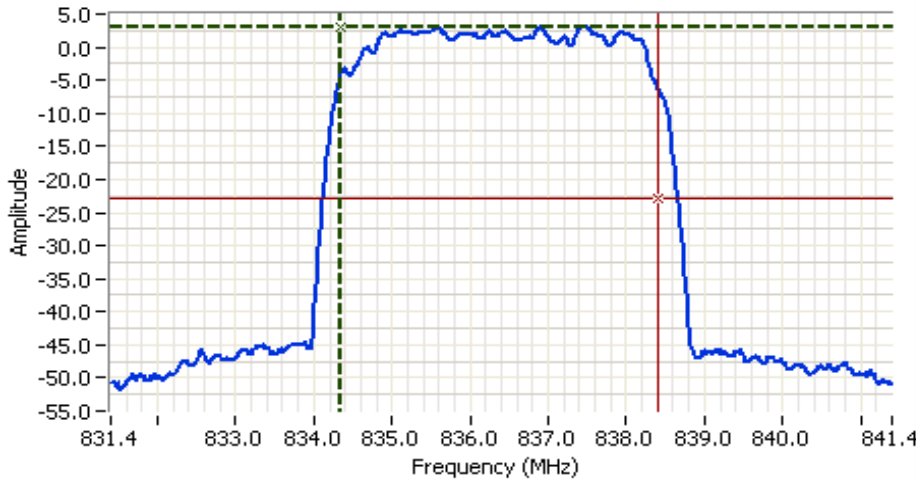

Analyzer Settings
 Agilent Technologies, E4446A
 CF: 836.400 MHz
 SPAN: 10.000 MHz
 RB: 100 kHz
 VB: 1.000 MHz
 Detector: RMS
 Attn: 20 DB
 RL Offset: 10.6 DB
 Sweep Time: 1.0s
 Ref Lvl: 20.0 DBM

Comments
 99% power BW: 4.060 MHz
 Power over span: 17.26dBm

| | | | |
|----------|----------|--------|--|
| Cursor 1 | 834.3451 | 3.12 | |
| Cursor 2 | 838.4050 | -22.88 | |

Delta Freq. 4.060
 Delta Amplitude 26.00



Run #2 Channel 4182, 26 dB Bandwidth

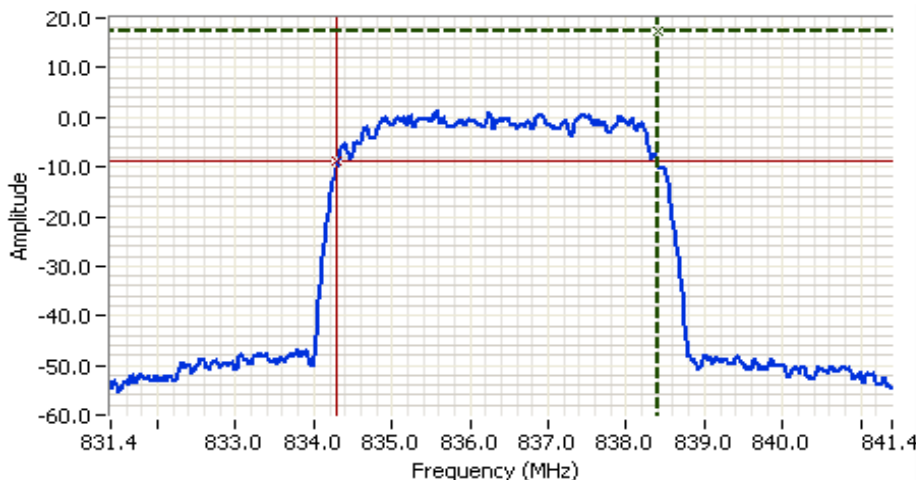

Analyzer Settings
 Agilent Technologies, E4446A
 CF: 836.400 MHz
 SPAN: 10.000 MHz
 RB: 51.0 kHz
 VB: 510 kHz
 Detector: RMS
 Attn: 20 DB
 RL Offset: 10.6 DB
 Sweep Time: 1.0s
 Ref Lvl: 20.0 DBM

Comments
 26dB BW: 4.115 MHz

| | | | |
|----------|----------|-------|--|
| Cursor 1 | 838.4052 | 17.26 | |
| Cursor 2 | 834.2906 | -8.74 | |

Delta Freq. 4.115
 Delta Amplitude 26.00



| | |
|--|--------------------------------------|
| Client: Nextivity Inc | Job Number: J86441 |
| Model: RS225 WU and RS225 CU | T-Log Number: T86829 |
| Contact: Steve van Skike | Account Manager: Sheareen Washington |
| Standard: RSS 132, RSS 133, FCC Part 22, FCC Part 24 | Class: N/A |

Run #5 Channel 9400, Channel Power and 99% Bandwidth

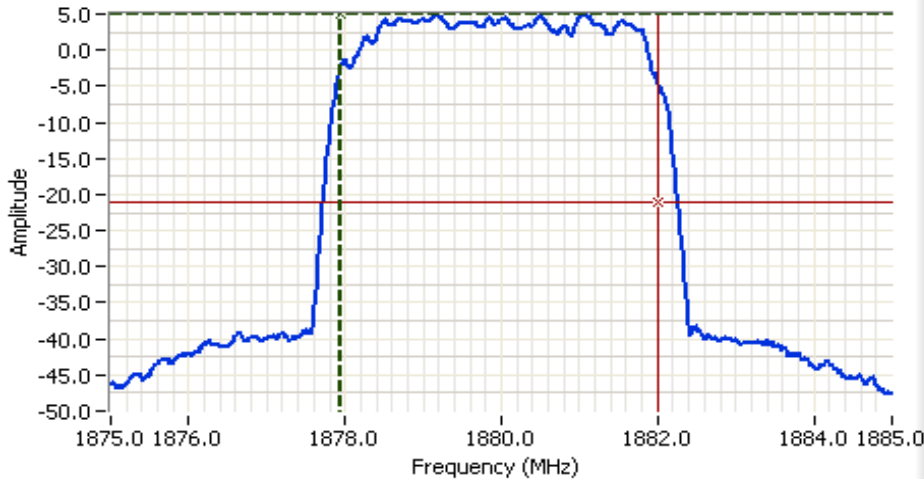

Analyzer Settings
 Agilent Technologies, E4446A
 CF: 1880.000 MHz
 SPAN: 10.000 MHz
 RB: 100 kHz
 VB: 1.000 MHz
 Detector: RMS
 Attn: 30 DB
 RL Offset: 11.1 DB
 Sweep Time: 1.0s
 Ref Lvl: 27.0 DBM

Comments
 99% power BW: 4.060 MHz
 Power over span: 19.11dBm

| | | | |
|----------|-----------|--------|--|
| Cursor 1 | 1877.9451 | 4.93 | |
| Cursor 2 | 1882.0050 | -21.07 | |

Delta Freq. 4.060
 Delta Amplitude 26.00



Run #5 Channel 9400, 26 dB Bandwidth

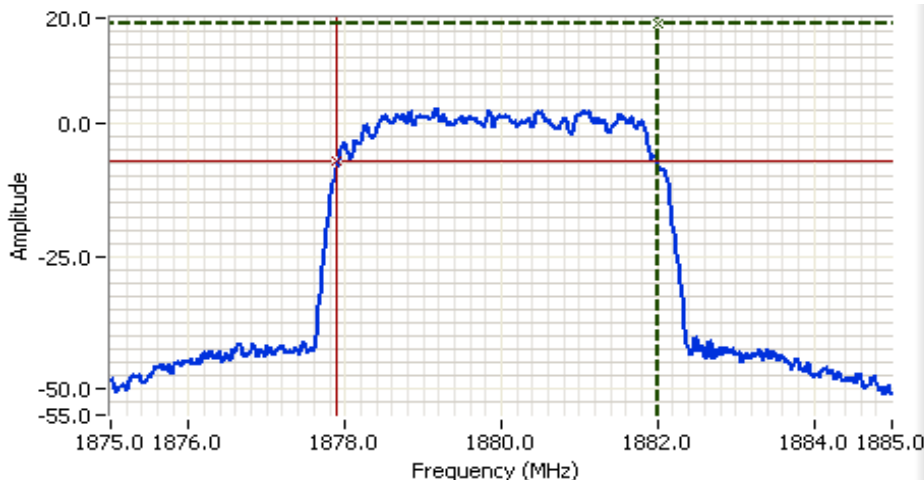

Analyzer Settings
 Agilent Technologies, E4446A
 CF: 1880.000 MHz
 SPAN: 10.000 MHz
 RB: 51.0 kHz
 VB: 510 kHz
 Detector: RMS
 Attn: 30 DB
 RL Offset: 11.1 DB
 Sweep Time: 1.0s
 Ref Lvl: 27.0 DBM

Comments
 26dB BW: 4.115 MHz

| | | | |
|----------|-----------|-------|--|
| Cursor 1 | 1882.0052 | 19.11 | |
| Cursor 2 | 1877.8906 | -6.89 | |

Delta Freq. 4.115
 Delta Amplitude 26.00



| | |
|--|--------------------------------------|
| Client: Nextivity Inc | Job Number: J86441 |
| Model: RS225 WU and RS225 CU | T-Log Number: T86829 |
| Contact: Steve van Skike | Account Manager: Sheareen Washington |
| Standard: RSS 132, RSS 133, FCC Part 22, FCC Part 24 | Class: N/A |

Run #5 Channel 9400, Peak power

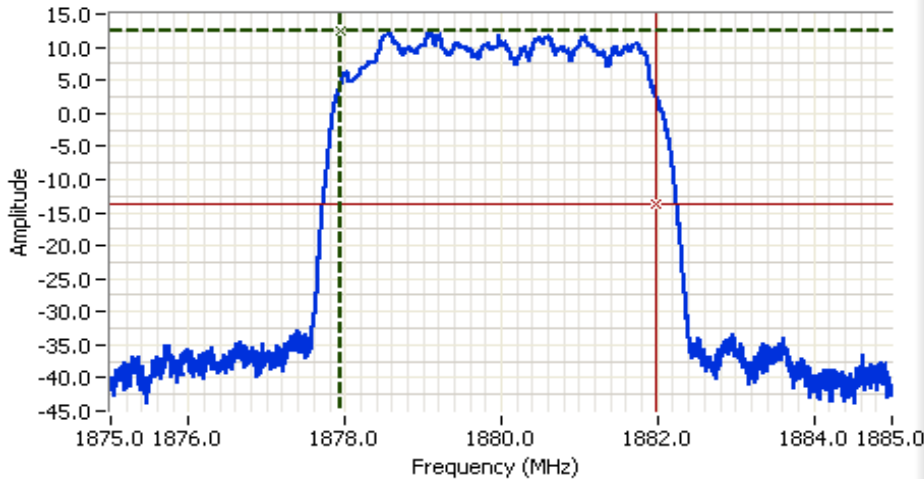

Analyzer Settings
 Agilent Technologies, E4446A
 CF: 1880.000 MHz
 SPAN: 10.000 MHz
 RB: 100 kHz
 VB: 1.000 MHz
 Detector: POS
 Attn: 30 DB
 RL Offset: 11.1 DB
 Sweep Time: 1.0s
 Ref Lvl: 30.0 DBM

Comments
 Power over span: 25.50dBm

| | | | |
|----------|-----------|--------|--|
| Cursor 1 | 1877.9333 | 12.40 | |
| Cursor 2 | 1881.9867 | -13.60 | |

Delta Freq. 4.053
 Delta Amplitude 26.00



| | | | |
|-----------|--|------------------|---------------------|
| Client: | Nextivity Inc | Job Number: | J86441 |
| Model: | RS225 WU and RS225 CU | T-Log Number: | T86829 |
| Contact: | Steve van Skike | Account Manager: | Sheareen Washington |
| Standard: | RSS 132, RSS 133, FCC Part 22, FCC Part 24 | Class: | N/A |

RSS 132, RSS 133, FCC Part 22, FCC Part 24 Conducted spurious measurements

Test Specific Details

Objective: The objective of this test session is to perform final qualification testing of the EUT with respect to the specification listed above.

Date of Test: 3/22/2012 0:00
 Test Engineer: Deniz Demerci
 Test Location: Lab #4

Config. Used: 1
 Config Change: None
 EUT Voltage: 120V/60Hz

Test Procedure:

WU was set to operate at maximum power at Lowest, center and highest channels for Band V and Band II
 Scanned frequency ranges 30-300 MHz, 300-1000 MHz, 1000-6000 MHz, 6000-10000 MHz, 10000-18000 MHz and 18000-20000 MHz with RBW 1 MHz, VBW 3 MHz, each range 10 Sweep@10s, using RMS detector

Ambient Conditions:

Temperature: 20 °C
 Rel. Humidity: 32 %

RS225 WU Summary of Results

No emission observed above the noise floor

Modifications Made During Testing

No modifications were made to the EUT during testing

Deviations From The Standard

No deviations were made from the requirements of the standard.

Test Setup:

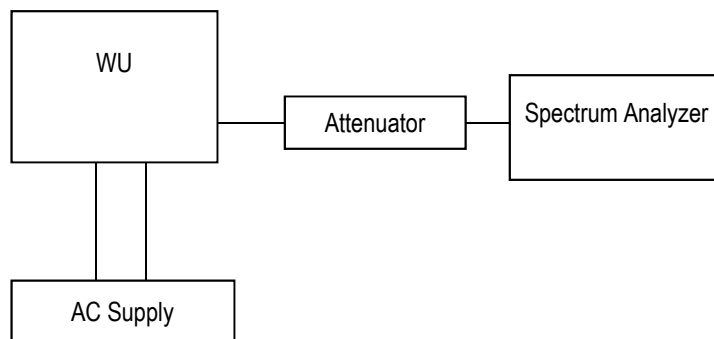

| | | | |
|-----------|--|------------------|---------------------|
| Client: | Nextivity Inc | Job Number: | J86441 |
| Model: | RS225 WU and RS225 CU | T-Log Number: | T86829 |
| Contact: | Steve van Skike | Account Manager: | Sheareen Washington |
| Standard: | RSS 132, RSS 133, FCC Part 22, FCC Part 24 | Class: | N/A |

Run #1 Band V, Low channel

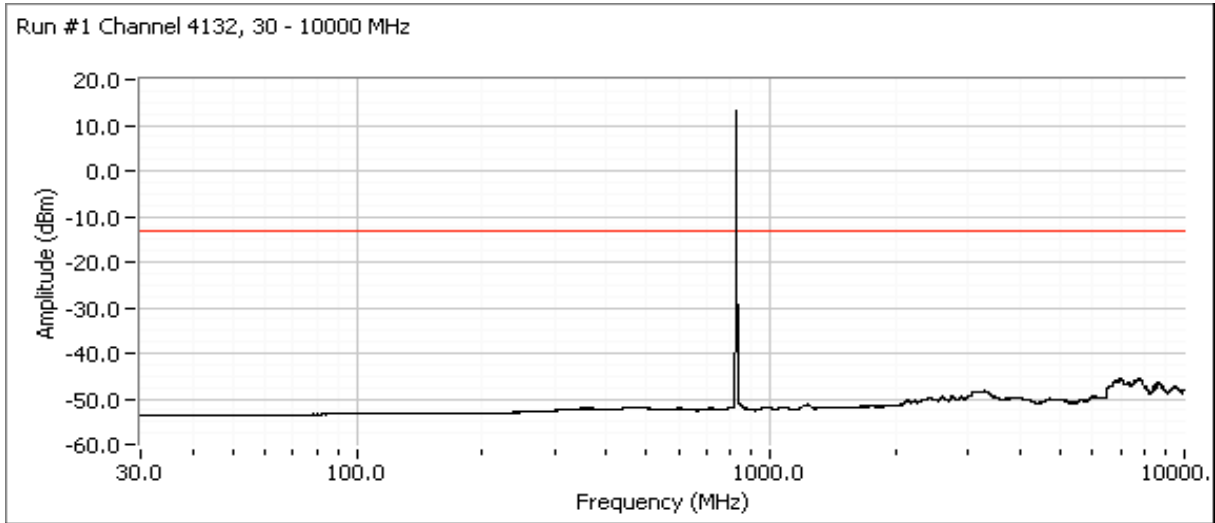

Run #2 Band V, Mid channel

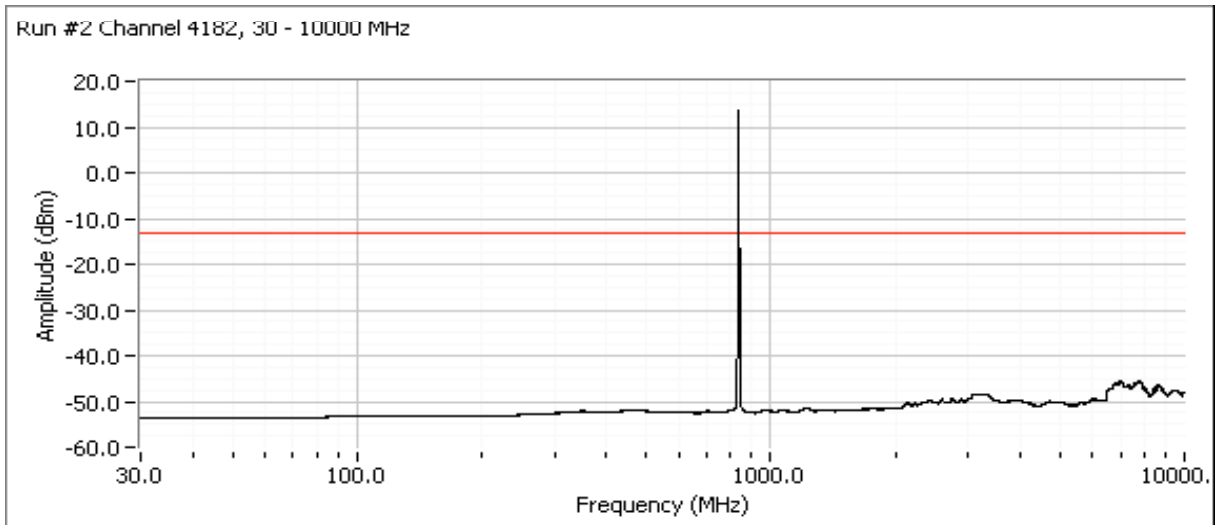

| | |
|--|--------------------------------------|
| Client: Nextivity Inc | Job Number: J86441 |
| Model: RS225 WU and RS225 CU | T-Log Number: T86829 |
| Contact: Steve van Skike | Account Manager: Sheareen Washington |
| Standard: RSS 132, RSS 133, FCC Part 22, FCC Part 24 | Class: N/A |

Run #3 Band V High channel

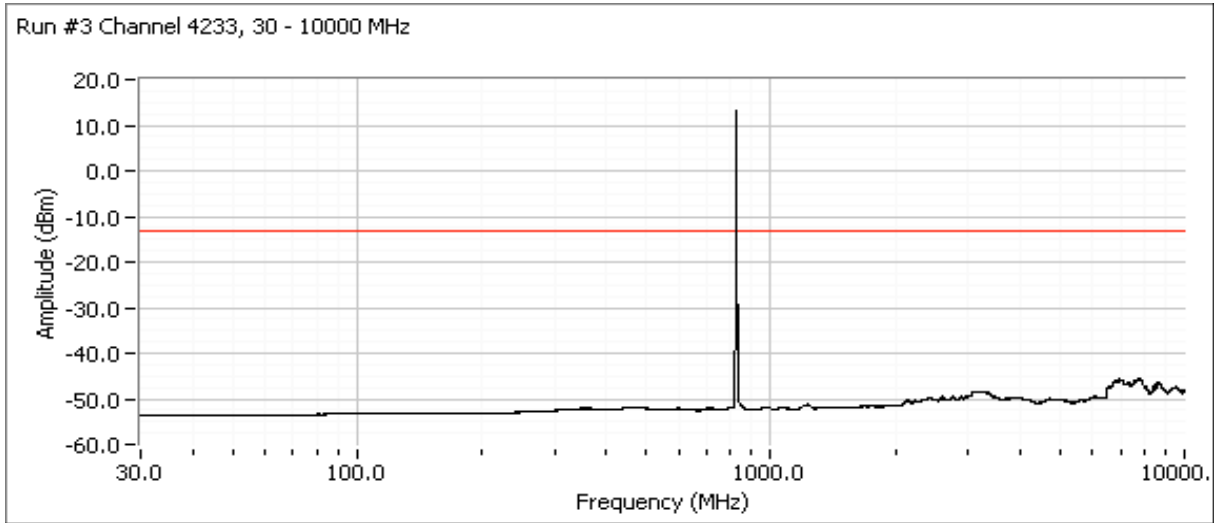

Run #4 Band II, Low channel

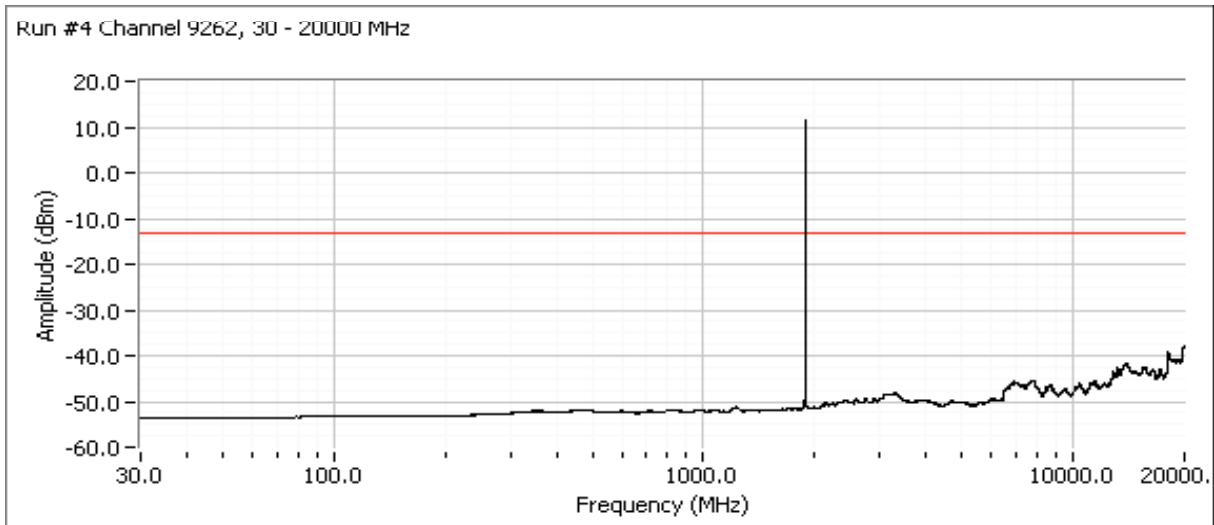

| | |
|--|--------------------------------------|
| Client: Nextivity Inc | Job Number: J86441 |
| Model: RS225 WU and RS225 CU | T-Log Number: T86829 |
| Contact: Steve van Skike | Account Manager: Sheareen Washington |
| Standard: RSS 132, RSS 133, FCC Part 22, FCC Part 24 | Class: N/A |

Run #5 Band II Mid channel

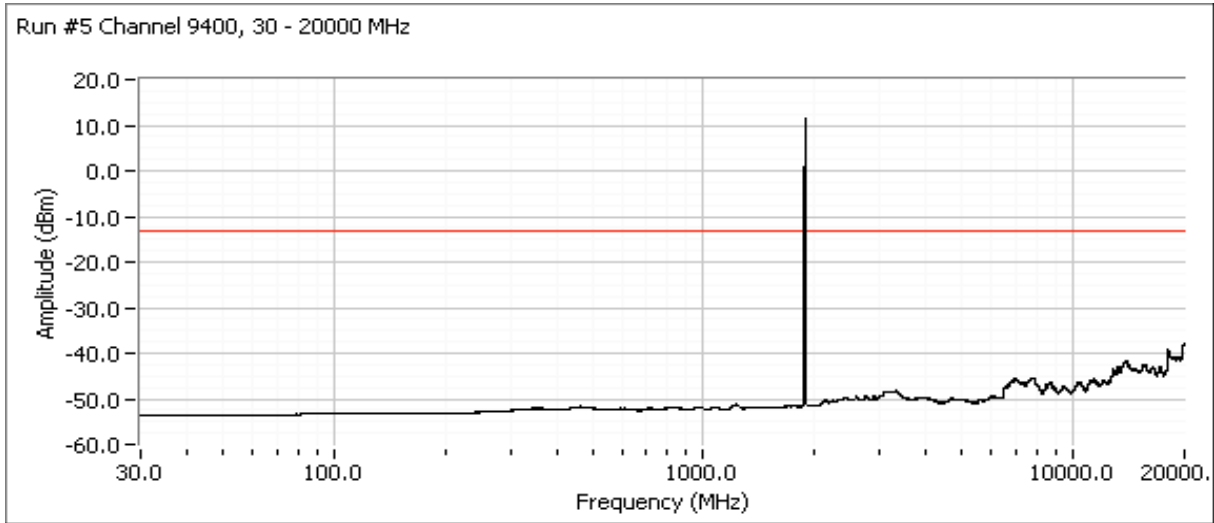

Run #6 Band II High channel

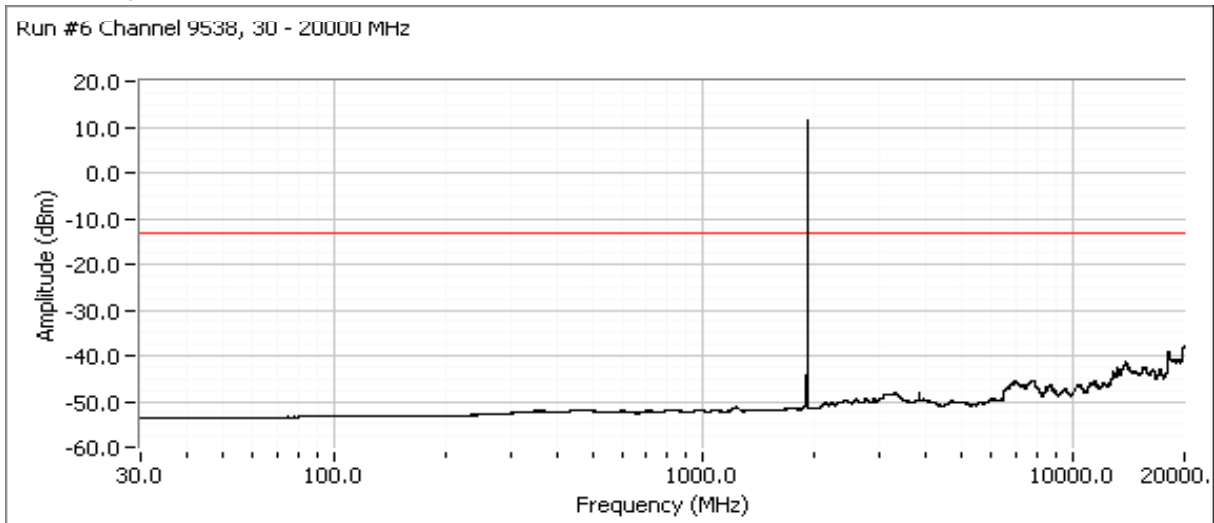

| | | | |
|-----------|--|------------------|---------------------|
| Client: | Nextivity Inc | Job Number: | J86441 |
| Model: | RS225 WU and RS225 CU | T-Log Number: | T86829 |
| | | Account Manager: | Sheareen Washington |
| Contact: | Steve van Skike | | |
| Standard: | RSS 132, RSS 133, FCC Part 22, FCC Part 24 | Class: | - |

**RSS 132, RSS 133, FCC Part 22, FCC Part 24
Frequency tolerance /Frequency Stability**

Test Specific Details

Objective: The objective of this test session is to perform final qualification testing of the EUT with respect to the specification listed above.

Date of Test: 3/29/2012, 4/11/2012
Test Engineer: J. Caizzi, M. Birgani
Test Location: FT Lab 4

Config. Used: 1
Config Change: None
EUT Voltage: 120V/60Hz

Specifications

- 2.1055 Measurements required: Frequency stability;
- (a) The frequency stability shall be measured with variation of ambient temperature as follows:
 - (1) From -30° to +50° centigrade for all equipment except that specified in paragraphs (a) (2) and (3) of this section.
 - (d) The frequency stability shall be measured with variation of primary supply voltage as follows:
 - (1) Vary primary supply voltage from 85 to 115 percent of the nominal value

Cell Mode

22.355 Frequency Tolerance;
The carrier frequency of each transmitter in the Public Mobile Services must be maintained within the tolerances given below;
821 - 896 MHz, Mobile ≤3 watts 2.5 ppm

PCS Mode

24.235 Frequency stability;
The frequency stability shall be sufficient to ensure that the fundamental emission stays within the authorized frequency block.

Modifications Made During Testing

No modifications were made to the EUT during testing

Deviations From The Standard

No deviations were made from the requirements of the standard.

Test Procedure:

The WU and CU were placed in the thermal chamber and tested at 20° Celsius and increased in 10 degree increments to 50° Celsius and then down to -30° Celcius.
After a sufficient time of temperature stabilization with the EUT was attached to the spectrum analyzer.

| | |
|--|--------------------------------------|
| Client: Nextivity Inc | Job Number: J86441 |
| Model: RS225 WU and RS225 CU | T-Log Number: T86829 |
| | Account Manager: Sheareen Washington |
| Contact: Steve van Skike | |
| Standard: RSS 132, RSS 133, FCC Part 22, FCC Part 24 | Class: - |

Test Setup:

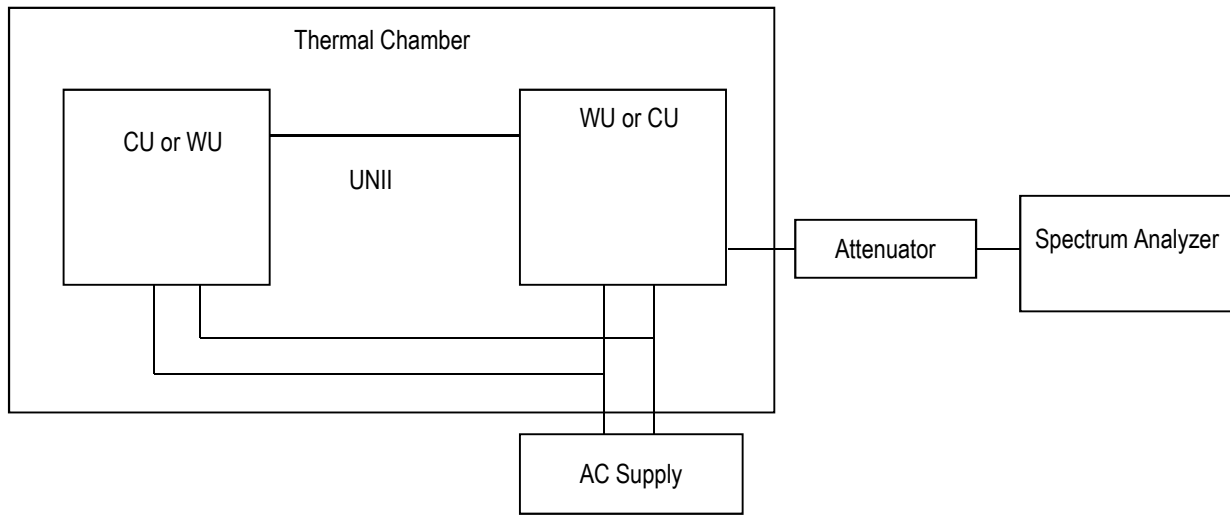

RS225 WU test was performed by J.Caizzi on 3/29/2012
 RS225 CU test was performed by M. Birgani on 4/11/2012

| | |
|--|--------------------------------------|
| Client: Nextivity Inc | Job Number: J86441 |
| Model: RS225 WU and RS225 CU | T-Log Number: T86829 |
| | Account Manager: Sheareen Washington |
| Contact: Steve van Skike | |
| Standard: RSS 132, RSS 133, FCC Part 22, FCC Part 24 | Class: - |

RS225 WU Test Result:

| Temperature (C) | Voltage (Vac) | 850 WCDMA 836.0 MHz | | | PCS WCDMA 1880 MHz | | |
|-----------------|---------------|--------------------------|------------|-------------|--------------------------|------------|-------------|
| | | Measured frequency (MHz) | Error (Hz) | Error (ppm) | Measured frequency (MHz) | Error (Hz) | Error (ppm) |
| 20 | 120.00 | 835.979200 | 0 | 0.00 | 1879.979200 | 0 | 0.00 |
| 20 | 102.00 | 835.979200 | 0 | 0.00 | 1879.979200 | 0 | 0.00 |
| 20 | 138.00 | 835.979200 | 0 | 0.00 | 1879.979200 | 0 | 0.00 |
| -30 | 120.00 | 835.979200 | 0 | 0.00 | 1879.969954 | 9246 | 4.92 |
| -20 | 120.00 | 835.979200 | 0 | 0.00 | 1879.983300 | 4100 | 2.18 |
| -10 | 120.00 | 835.979200 | 0 | 0.00 | 1879.979200 | 0 | 0.00 |
| 0 | 120.00 | 835.979200 | 0 | 0.00 | 1879.979200 | 0 | 0.00 |
| 10 | 120.00 | 835.979200 | 0 | 0.00 | 1879.979200 | 0 | 0.00 |
| 30 | 120.00 | 835.979200 | 0 | 0.00 | 1879.979200 | 0 | 0.00 |
| 40 | 120.00 | 835.979200 | 0 | 0.00 | 1879.979200 | 0 | 0.00 |
| 50 | 120.00 | 835.979200 | 0 | 0.00 | 1879.979200 | 0 | 0.00 |

RS225 CU Test Result:

| Temperature (C) | Voltage (Vac) | 850 WCDMA 881.0 MHz | | | PCS WCDMA 1960 MHz | | |
|-----------------|---------------|--------------------------|------------|-------------|--------------------------|------------|-------------|
| | | Measured frequency (MHz) | Error (Hz) | Error (ppm) | Measured frequency (MHz) | Error (Hz) | Error (ppm) |
| 20 | 120.00 | 885.200110 | 0 | 0.0 | 1960.000283 | 0 | 0.0 |
| 20 | 102.00 | 885.200112 | 2 | 0.0 | 1960.000283 | 0 | 0.0 |
| 20 | 138.00 | 885.200110 | 0 | 0.0 | 1960.000283 | 0 | 0.0 |
| -30 | 120.00 | 885.200450 | 340 | 0.39 | 1960.000954 | 671 | 0.34 |
| -20 | 120.00 | 885.200130 | 20 | 0.02 | 1960.000304 | 21 | 0.01 |
| -10 | 120.00 | 885.200105 | 5 | 0.01 | 1960.000190 | 93 | 0.05 |
| 0 | 120.00 | 885.200021 | 89 | 0.10 | 1960.000112 | 171 | 0.09 |
| 10 | 120.00 | 885.200024 | 86 | 0.10 | 1960.000032 | 251 | 0.13 |
| 30 | 120.00 | 885.200245 | 135 | 0.15 | 1960.000653 | 370 | 0.19 |
| 40 | 120.00 | 885.200575 | 465 | 0.53 | 1960.001188 | 905 | 0.46 |
| 50 | 120.00 | 885.200884 | 774 | 0.88 | 1960.002065 | 1782 | 0.91 |

| | | | |
|-----------|--|------------------|---------------------|
| Client: | Nextivity Inc | Job Number: | J86441 |
| Model: | RS225 WU and RS225 CU | T-Log Number: | T86829 |
| Contact: | Steve van Skike | Account Manager: | Sheareen Washington |
| Standard: | RSS 132, RSS 133, FCC Part 22, FCC Part 24 | Class: | - |

RSS 132, RSS 133, FCC Part 22, FCC Part 24 Radiated TX spurious emissions

Test Specific Details

Objective: The objective of this test session is to perform final qualification testing of the EUT with respect to the specification listed above.

Date of Test: 3/23/2012 & 3/29/12

Config. Used: 1

Test Engineer: J. Caizzi/ C. Groat, M. Birgani

Config Change: None

Test Location: Fremont Chamber #7

EUT Voltage: 120V/60Hz

General Test Configuration

The EUT and all local support equipment were located on the turntable for radiated spurious emissions testing.

For radiated emissions testing the measurement antenna was located 3 meters from the EUT.

Ambient Conditions:

Temperature: 18-21 °C

Rel. Humidity: 30-40 %

Summary of Results

| Run # | Mode | Channel | Power Setting | Test Performed | Limit | Result / Margin | | |
|-------|-----------------------|---------|---------------|--|--------------|---|--------------|--------------|
| 1a | Band V 1 channel | Low | Max | Radiated Spurious Emissions 1 GHz - 9 GHz | FCC Part 22H | >20dB Margin | | |
| 1b | | Center | | | | >20dB Margin | | |
| 1c | | High | | | | >20dB Margin | | |
| 2a | Band V 3 channels | Low | Max | | | >20dB Margin | | |
| 2b | | Center | | | | >20dB Margin | | |
| 2c | | High | | | | >20dB Margin | | |
| 3a | Band II 1 channel | Low | Max | | | Radiated Spurious Emissions 1 GHz - 20 GHz | FCC Part 24E | >20dB Margin |
| 3b | | Center | | | | | | >20dB Margin |
| 3c | | High | | | | | | >20dB Margin |
| 4a | Band II 3 channels | Low | Max | >20dB Margin | | | | |
| 4b | | Center | | >20dB Margin | | | | |
| 4c | | High | | >20dB Margin | | | | |

Modifications Made During Testing

No modifications were made to the EUT during testing

Deviations From The Standard

No deviations were made from the requirements of the standard.

| | | | |
|-----------|--|------------------|---------------------|
| Client: | Nextivity Inc | Job Number: | J86441 |
| Model: | RS225 WU and RS225 CU | T-Log Number: | T86829 |
| Contact: | Steve van Skike | Account Manager: | Sheareen Washington |
| Standard: | RSS 132, RSS 133, FCC Part 22, FCC Part 24 | Class: | - |

Test Procedure:

WU was set to operate at maximum power at low center and high channels.

Test Setup:

EUT CELFI-RS225WU S# 15020600097

Note 1: The field strength limit in the tables above was calculated from the erp/eirp limit detailed in the standard using the free space propagation equation: $E = \sqrt{(30PG)/d}$. This limit is conservative - it does not consider the presence of the ground plane and, for erp limits, the dipole gain (2.2dBi) has not been included. The erp or eirp for all signals with less than 20dB of margin relative to this field strength limit is determined using substitution measurements.

Note 2: Emissions observed below 1 GHz were not affected by changing channels or bands.

Run 1: Band V WU, 1 channel

Run 1a: Band V WU, low channel 4132 (826.4 MHz)

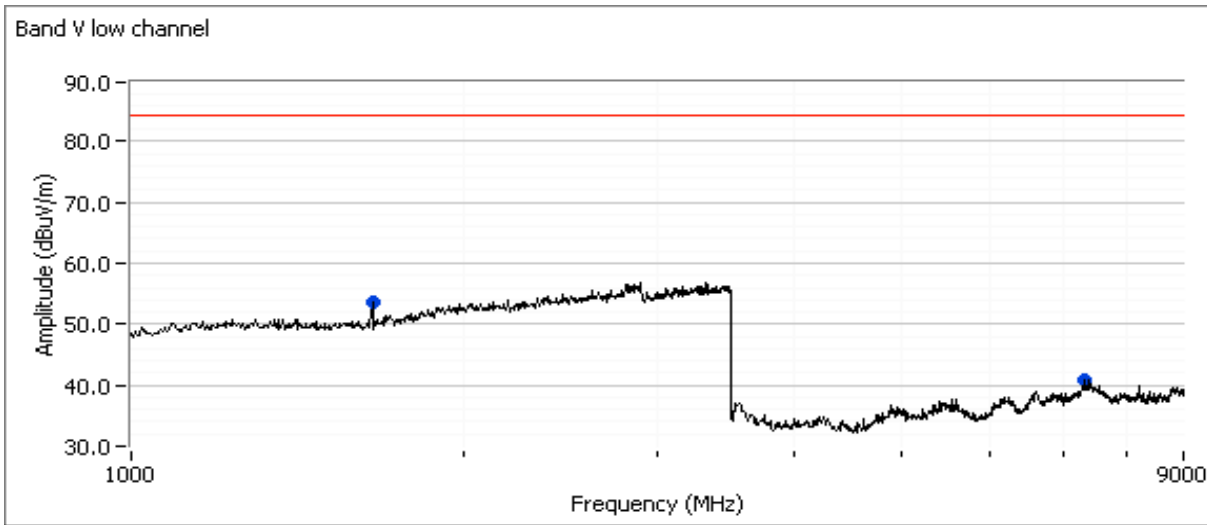

Spurious Emissions

| Frequency MHz | Level dB μ V/m | Pol v/h | FCC Part 22 Limit | Note 1 Margin | Detector RMS/Peak | Azimuth degrees | Height meters | Comments |
|---------------|--------------------|---------|-------------------|---------------|-------------------|-----------------|---------------|----------|
| 1654.170 | 53.5 | V | 84.4 | -30.9 | Peak | 92 | 1.3 | |
| 7331.670 | 41.0 | H | 84.4 | -43.4 | Peak | 28 | 1.3 | |

| | | | |
|-----------|--|------------------|---------------------|
| Client: | Nextivity Inc | Job Number: | J86441 |
| Model: | RS225 WU and RS225 CU | T-Log Number: | T86829 |
| Contact: | Steve van Skike | Account Manager: | Sheareen Washington |
| Standard: | RSS 132, RSS 133, FCC Part 22, FCC Part 24 | Class: | - |

Run 1b: Band V WU, center channel 4182 (836.4 MHz)

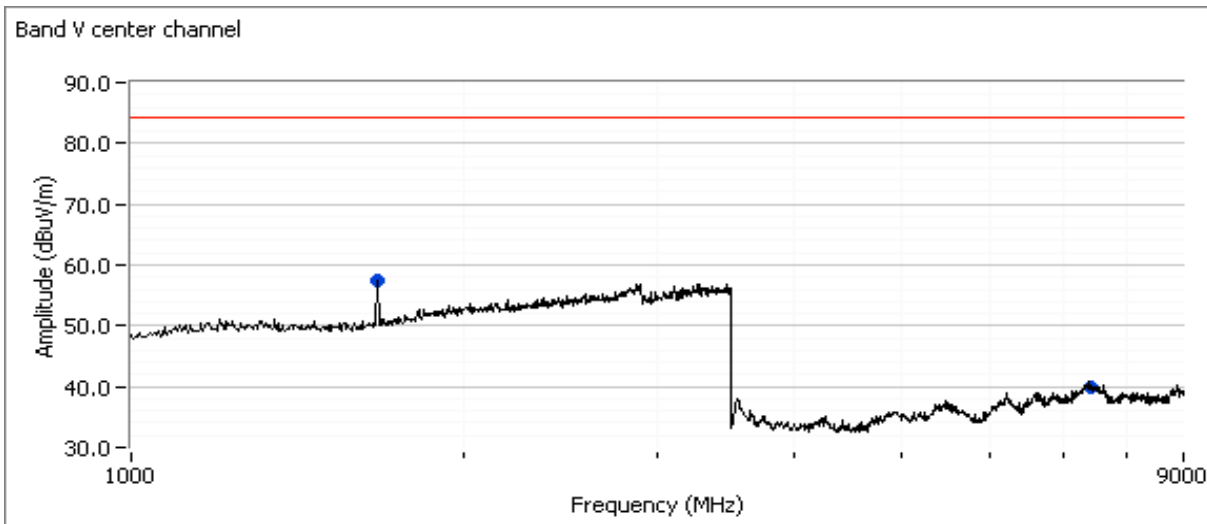

Spurious Emissions

| Frequency MHz | Level dB μ V/m | Pol v/h | FCC Part 22 ^{Note 1} | | Detector RMS/Peak | Azimuth degrees | Height meters | Comments |
|------------------|-----------------------|------------|-------------------------------|--------|----------------------|--------------------|------------------|----------|
| | | | Limit | Margin | | | | |
| 1675.000 | 57.4 | V | 84.4 | -27.0 | Peak | 143 | 1.3 | |
| 7414.170 | 40.0 | V | 84.4 | -44.4 | Peak | 266 | 2.5 | |

| | | | |
|-----------|--|------------------|---------------------|
| Client: | Nextivity Inc | Job Number: | J86441 |
| Model: | RS225 WU and RS225 CU | T-Log Number: | T86829 |
| Contact: | Steve van Skike | Account Manager: | Sheareen Washington |
| Standard: | RSS 132, RSS 133, FCC Part 22, FCC Part 24 | Class: | - |

Run 1c: Band V WU, high channel 4233 (846.6 MHz)

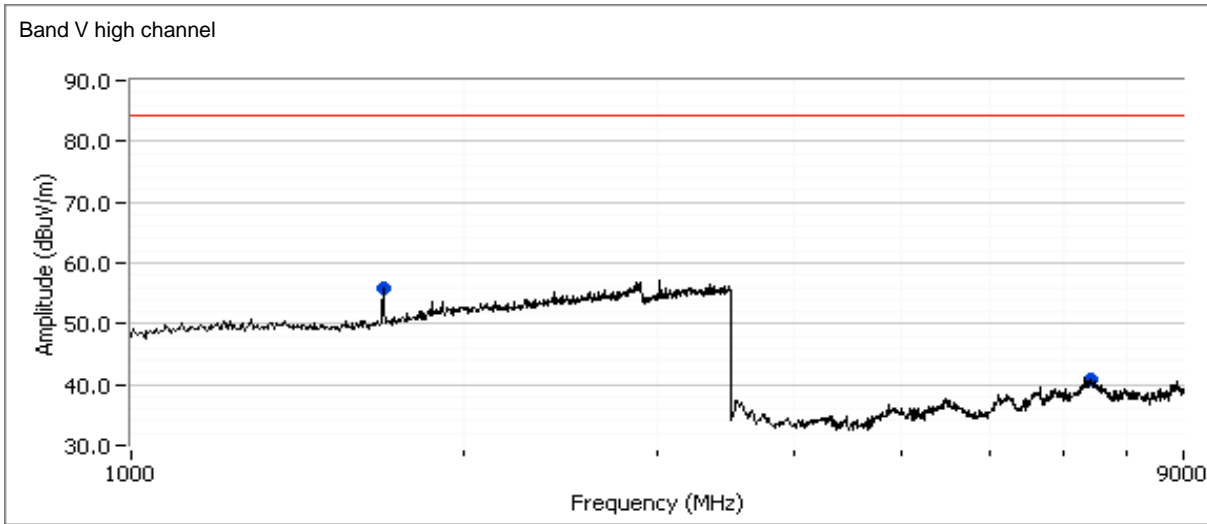

Spurious Emissions

| Frequency MHz | Level dB μ V/m | Pol v/h | FCC Part 22 ^{Note 1} | | Detector RMS/Peak | Azimuth degrees | Height meters | Comments |
|------------------|-----------------------|------------|-------------------------------|--------|----------------------|--------------------|------------------|----------|
| | | | Limit | Margin | | | | |
| 1691.670 | 56.0 | V | 84.4 | -28.4 | Peak | 135 | 1.3 | |
| 7414.170 | 40.8 | V | 84.4 | -43.6 | Peak | 269 | 1.3 | |

| | | | |
|-----------|--|------------------|---------------------|
| Client: | Nextivity Inc | Job Number: | J86441 |
| Model: | RS225 WU and RS225 CU | T-Log Number: | T86829 |
| Contact: | Steve van Skike | Account Manager: | Sheareen Washington |
| Standard: | RSS 132, RSS 133, FCC Part 22, FCC Part 24 | Class: | - |

Run 2: Band V WU, 3 channels

Run 2a: Band V WU, low channel (826.4 ,831.4 ,836.4 MHz)

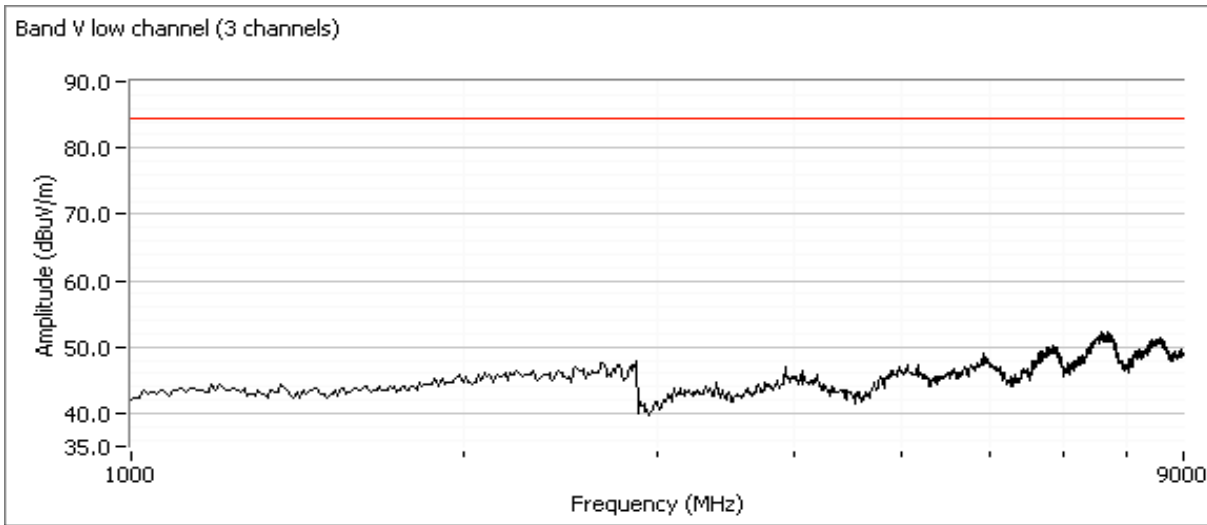

Spurious Emissions

| Frequency MHz | Level dB μ V/m | Pol v/h | FCC Part 22 ^{Note 1} Limit | Margin | Detector RMS/Peak | Azimuth degrees | Height meters | Comments |
|----------------------------|-----------------------|------------|--|--------|----------------------|--------------------|------------------|----------|
| More than 20dB below limit | | | | | | | | |

| | | | |
|-----------|--|------------------|---------------------|
| Client: | Nextivity Inc | Job Number: | J86441 |
| Model: | RS225 WU and RS225 CU | T-Log Number: | T86829 |
| Contact: | Steve van Skike | Account Manager: | Sheareen Washington |
| Standard: | RSS 132, RSS 133, FCC Part 22, FCC Part 24 | Class: | - |

Run 2b: Band V WU, center channel (831.4, 836.4, 841.4 MHz)

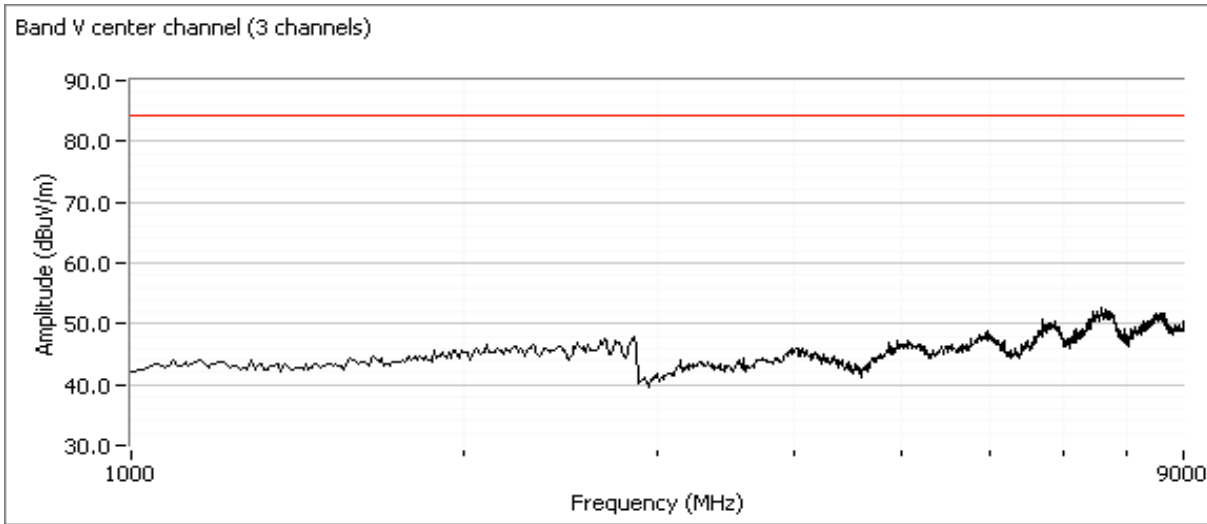

Spurious Emissions

| Frequency MHz | Level dB μ V/m | Pol v/h | FCC Part 22 Limit | Margin <small>Note 1</small> | Detector RMS/Peak | Azimuth degrees | Height meters | Comments |
|----------------------------|-----------------------|------------|----------------------|---------------------------------|----------------------|--------------------|------------------|----------|
| More than 20dB below limit | | | | | | | | |

| | | | |
|-----------|--|------------------|---------------------|
| Client: | Nextivity Inc | Job Number: | J86441 |
| Model: | RS225 WU and RS225 CU | T-Log Number: | T86829 |
| Contact: | Steve van Skike | Account Manager: | Sheareen Washington |
| Standard: | RSS 132, RSS 133, FCC Part 22, FCC Part 24 | Class: | - |

Run 2c: Band V WU, high channel (836.6, 841.6, 846.6 MHz)

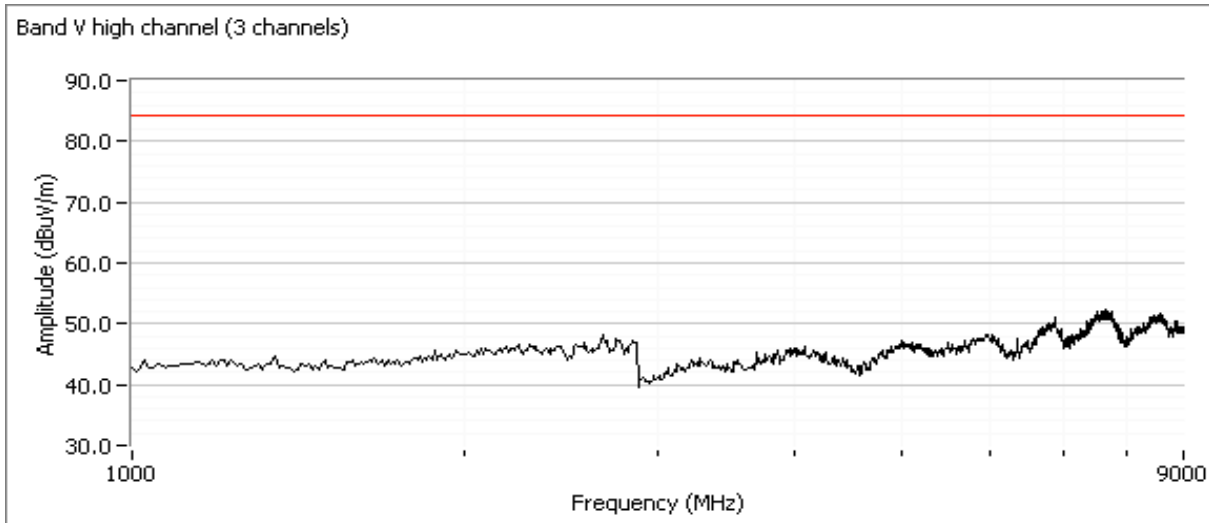

Spurious Emissions

| Frequency MHz | Level dB μ V/m | Pol v/h | FCC Part 22 Limit | Margin <small>Note 1</small> | Detector RMS/Peak | Azimuth degrees | Height meters | Comments |
|----------------------------|-----------------------|------------|----------------------|---------------------------------|----------------------|--------------------|------------------|----------|
| More than 20dB below limit | | | | | | | | |

| | | | |
|-----------|--|------------------|---------------------|
| Client: | Nextivity Inc | Job Number: | J86441 |
| Model: | RS225 WU and RS225 CU | T-Log Number: | T86829 |
| Contact: | Steve van Skike | Account Manager: | Sheareen Washington |
| Standard: | RSS 132, RSS 133, FCC Part 22, FCC Part 24 | Class: | - |

Run 3: Band II WU, 1 channel

Run 3a: Band II WU, low channel 9662 (1852.4 MHz)

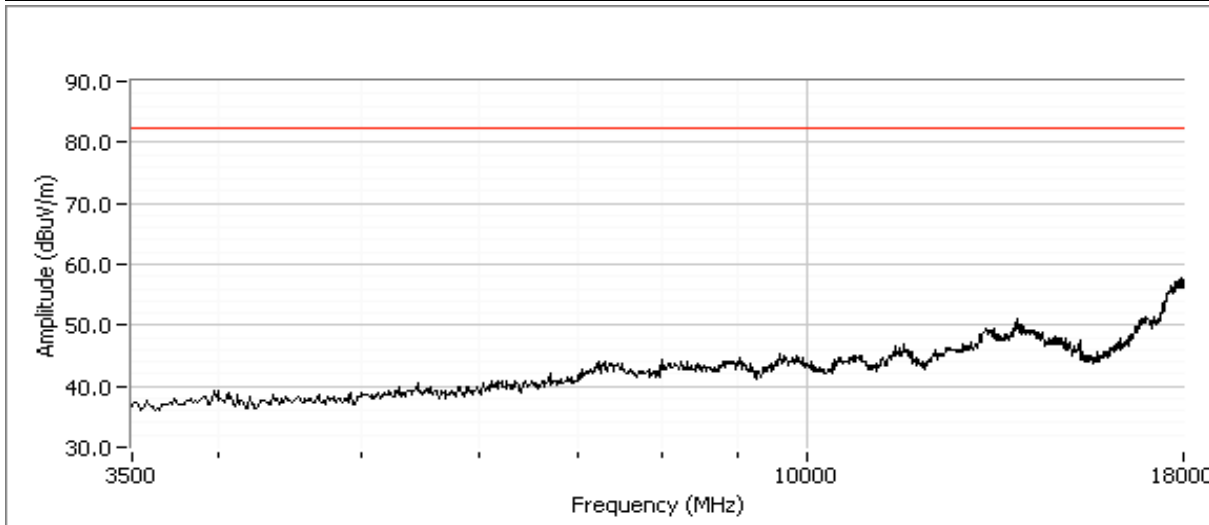
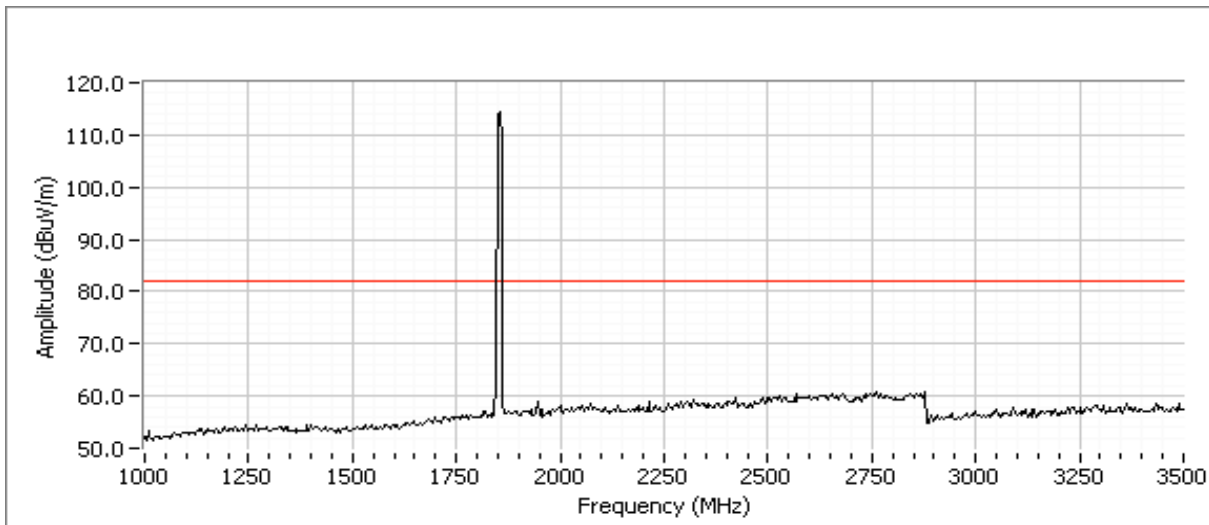

Spurious Emissions

| Frequency MHz | Level dB μ V/m | Pol v/h | FCC Part 24 Limit | Detector RMS/Peak | Azimuth degrees | Height meters | Comments |
|----------------------------|-----------------------|------------|----------------------|----------------------|--------------------|------------------|----------|
| More than 20dB below limit | | | | | | | |

| | |
|--|--------------------------------------|
| Client: Nextivity Inc | Job Number: J86441 |
| Model: RS225 WU and RS225 CU | T-Log Number: T86829 |
| Contact: Steve van Skike | Account Manager: Sheareen Washington |
| Standard: RSS 132, RSS 133, FCC Part 22, FCC Part 24 | Class: - |

Run 3b: Band II WU, center channel 9400 (1880 MHz)

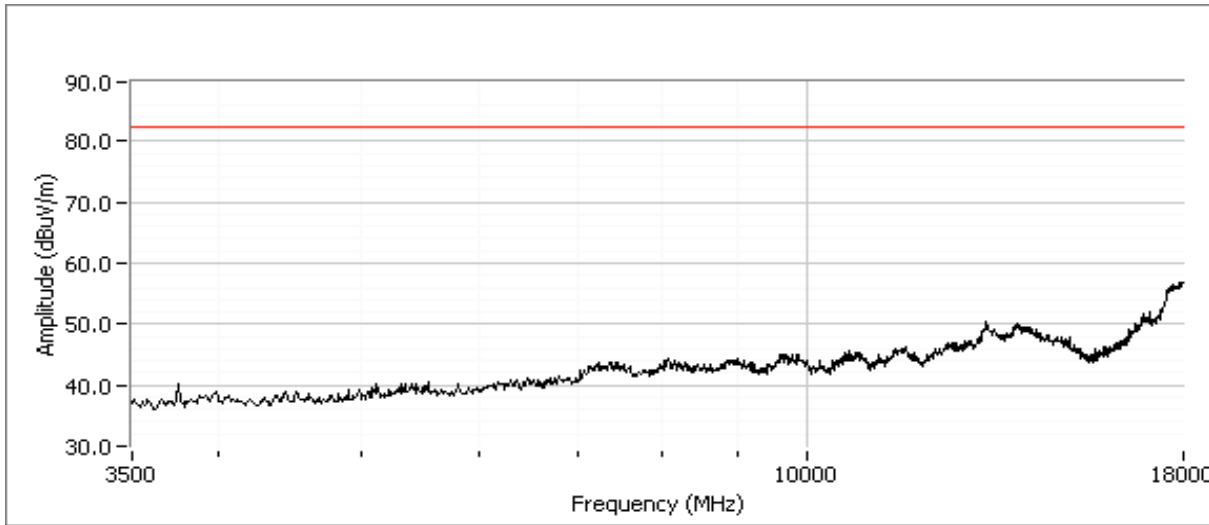
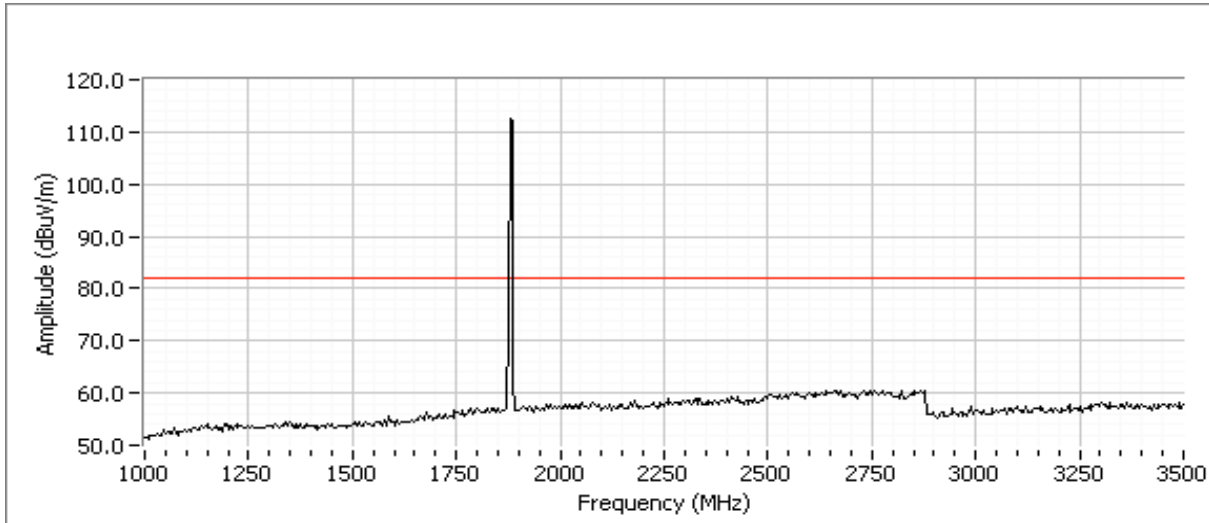

Spurious Emissions

| Frequency MHz | Level dB μ V/m | Pol v/h | FCC Part 24 Limit | Margin <small>Note 1</small> | Detector RMS/Peak | Azimuth degrees | Height meters | Comments |
|----------------------------|-----------------------|------------|----------------------|---------------------------------|----------------------|--------------------|------------------|----------|
| More than 20dB below limit | | | | | | | | |

| | |
|--|--------------------------------------|
| Client: Nextivity Inc | Job Number: J86441 |
| Model: RS225 WU and RS225 CU | T-Log Number: T86829 |
| Contact: Steve van Skike | Account Manager: Sheareen Washington |
| Standard: RSS 132, RSS 133, FCC Part 22, FCC Part 24 | Class: - |

Run 3c: Band II WU, high channel 9538 (1907.6 MHz)

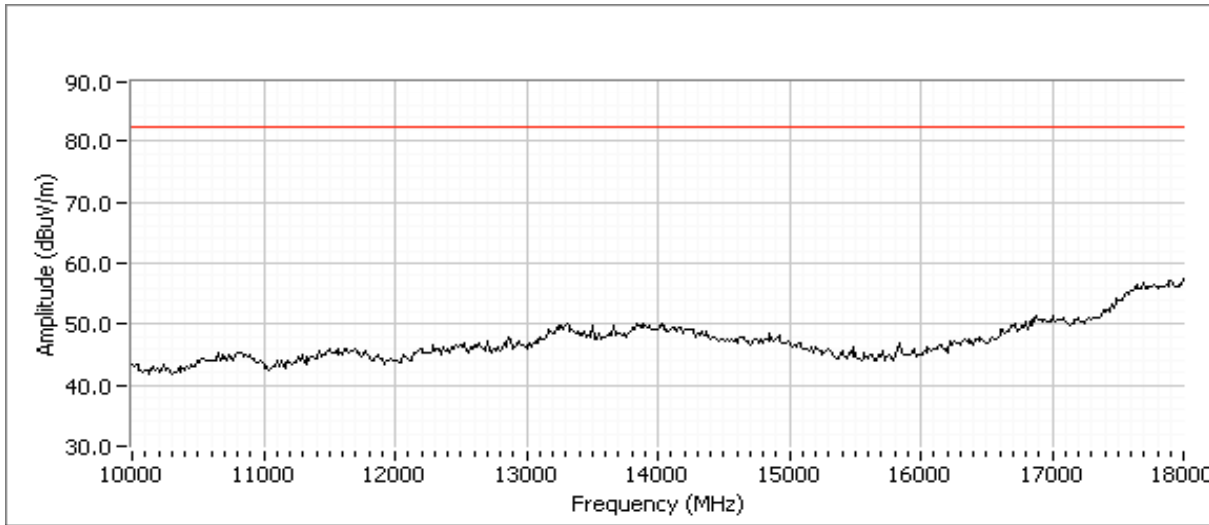
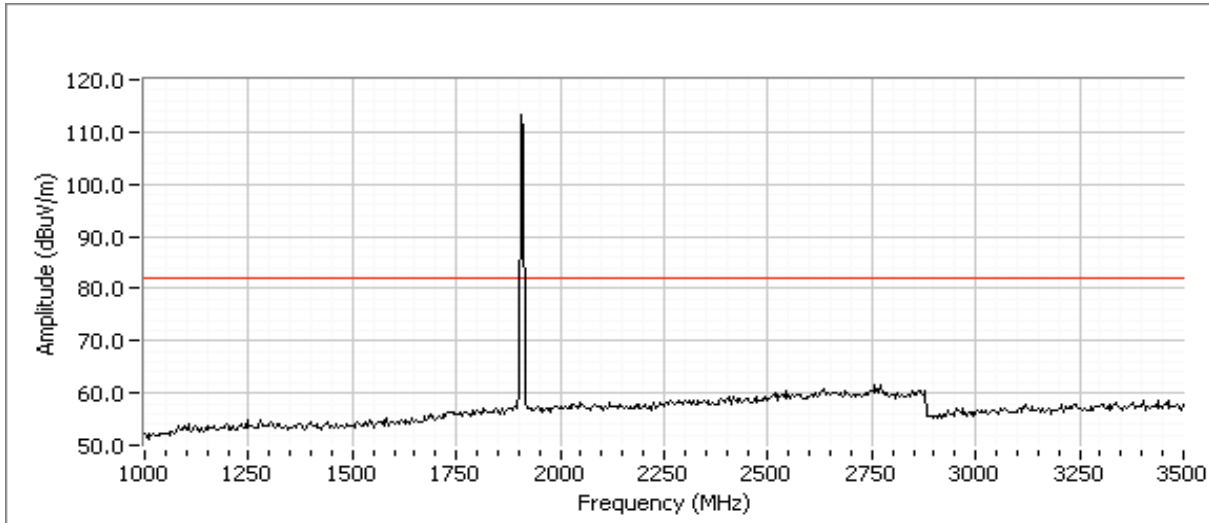

Spurious Emissions

| Frequency MHz | Level dB μ V/m | Pol v/h | FCC Part 24 Limit | Margin <small>Note 1</small> | Detector RMS/Peak | Azimuth degrees | Height meters | Comments |
|----------------------------|-----------------------|------------|----------------------|---------------------------------|----------------------|--------------------|------------------|----------|
| More than 20dB below limit | | | | | | | | |

| | |
|--|--------------------------------------|
| Client: Nextivity Inc | Job Number: J86441 |
| Model: RS225 WU and RS225 CU | T-Log Number: T86829 |
| Contact: Steve van Skike | Account Manager: Sheareen Washington |
| Standard: RSS 132, RSS 133, FCC Part 22, FCC Part 24 | Class: - |

Run 4: Band II WU, 3 channel

Run 4a: Band II WU, low channel 9662,9287,9337 (1852.4,1857.4,1867.4 MHz)

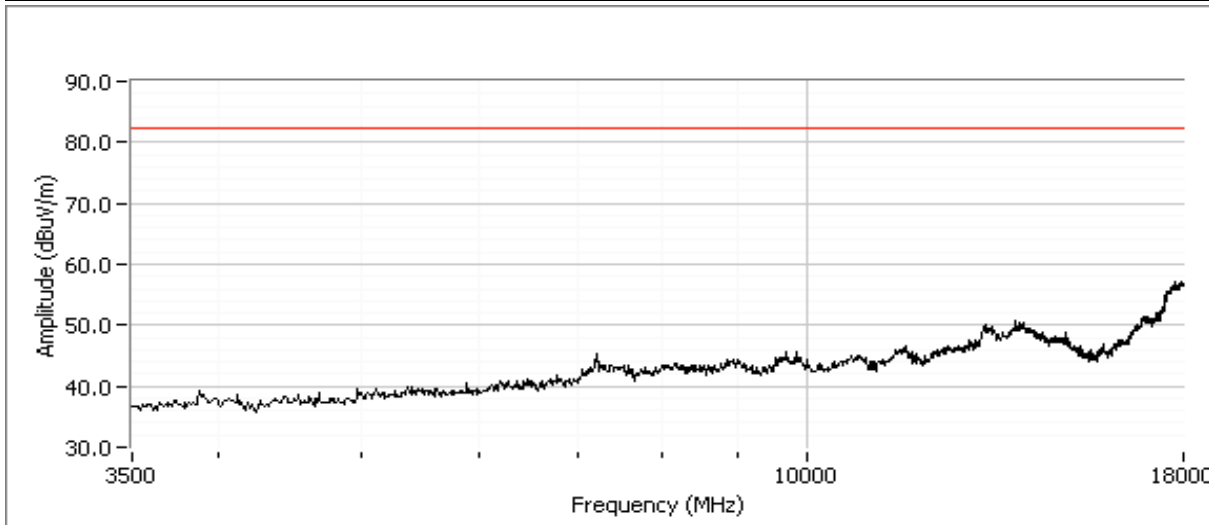
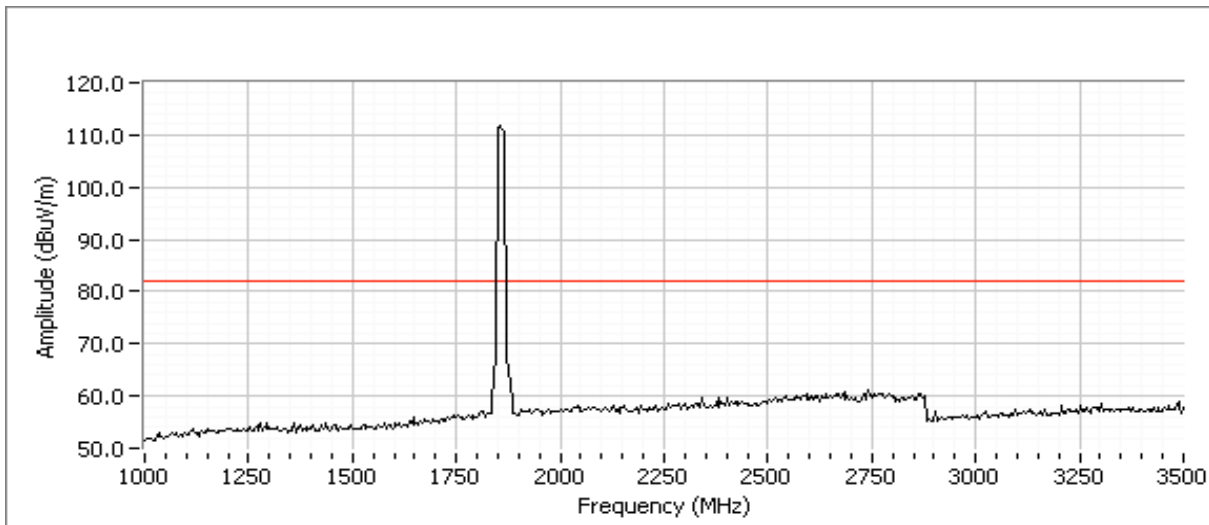

Spurious Emissions

| Frequency MHz | Level dB μ V/m | Pol v/h | FCC Part 24 Limit | Detector RMS/Peak | Azimuth degrees | Height meters | Comments |
|----------------------------|-----------------------|------------|----------------------|----------------------|--------------------|------------------|----------|
| More than 20dB below limit | | | | | | | |

| | | | |
|-----------|--|------------------|---------------------|
| Client: | Nextivity Inc | Job Number: | J86441 |
| Model: | RS225 WU and RS225 CU | T-Log Number: | T86829 |
| Contact: | Steve van Skike | Account Manager: | Sheareen Washington |
| Standard: | RSS 132, RSS 133, FCC Part 22, FCC Part 24 | Class: | - |

Run 4b: Band II WU, center channel 9375,9400,9425 (1875,1880,1885 MHz)

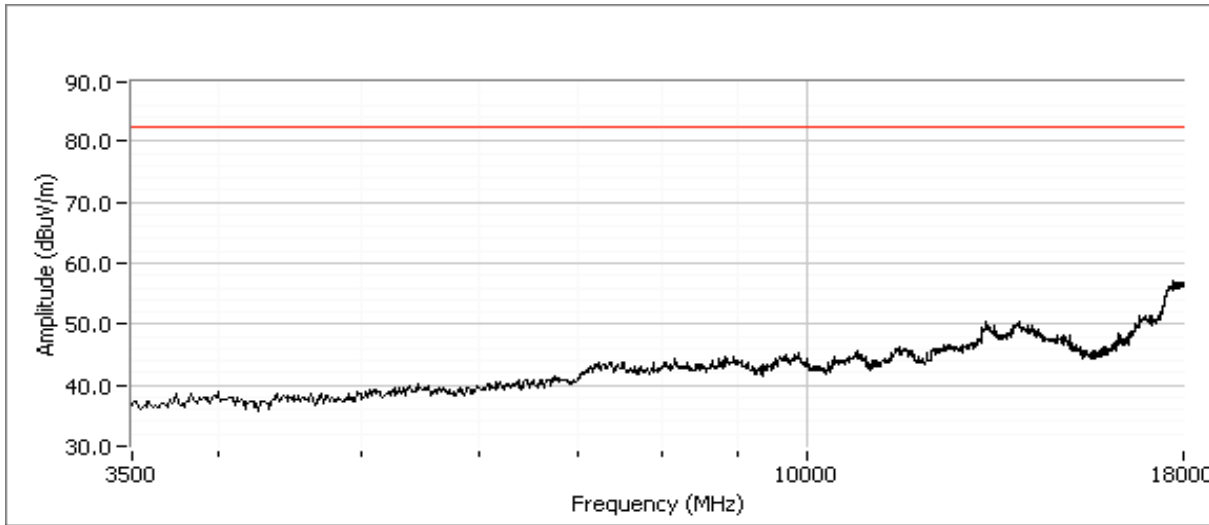
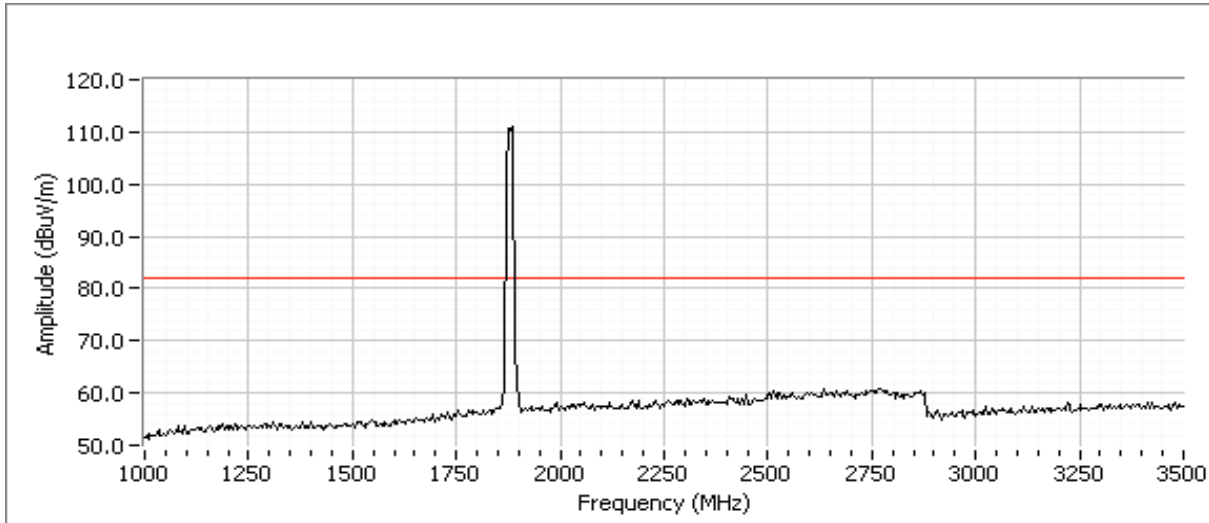

Spurious Emissions

| Frequency MHz | Level dB μ V/m | Pol v/h | FCC Part 24 Limit | Margin <small>Note 1</small> | Detector RMS/Peak | Azimuth degrees | Height meters | Comments |
|----------------------------|-----------------------|------------|----------------------|---------------------------------|----------------------|--------------------|------------------|----------|
| More than 20dB below limit | | | | | | | | |

| | | | |
|-----------|--|------------------|---------------------|
| Client: | Nextivity Inc | Job Number: | J86441 |
| Model: | RS225 WU and RS225 CU | T-Log Number: | T86829 |
| Contact: | Steve van Skike | Account Manager: | Sheareen Washington |
| Standard: | RSS 132, RSS 133, FCC Part 22, FCC Part 24 | Class: | - |

Run 4c: Band II WU, high channel 9488,9513,9538 (1897.6,1902.6,1907.6 MHz)

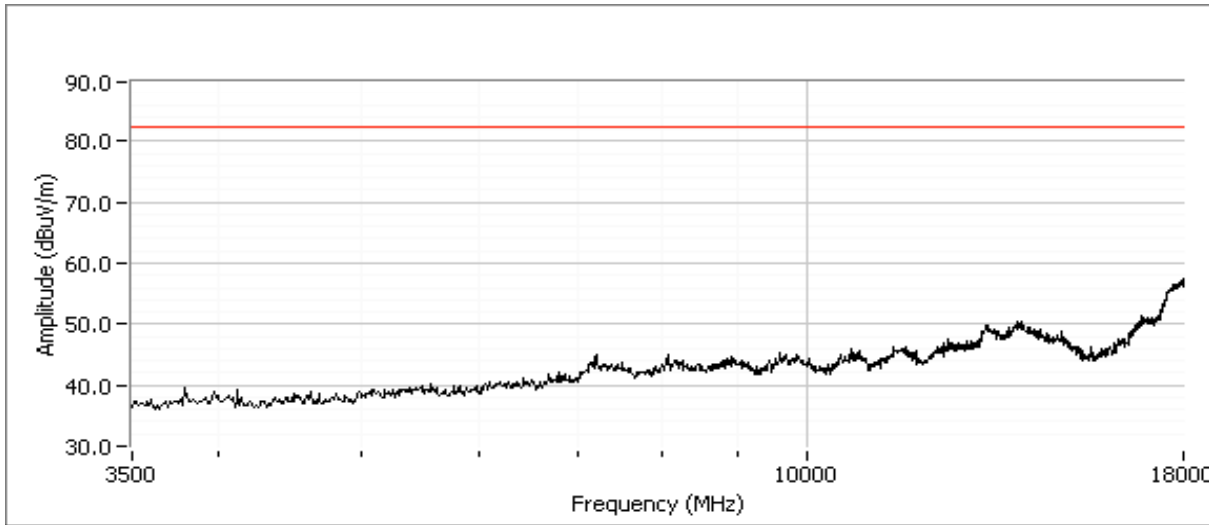
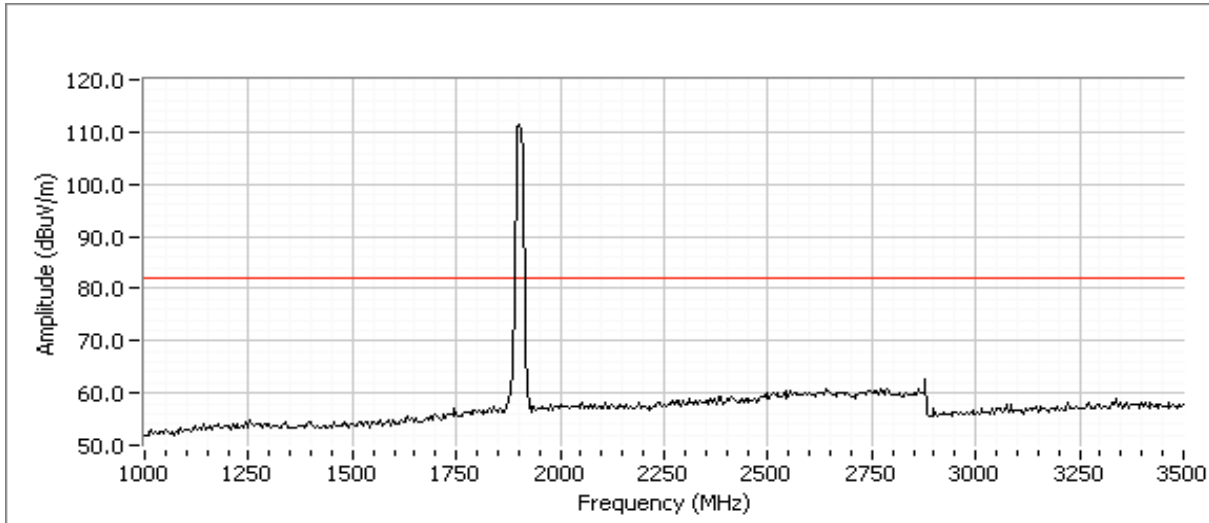

Spurious Emissions

| Frequency MHz | Level dB μ V/m | Pol v/h | FCC Part 24 Limit | Margin <small>Note 1</small> | Detector RMS/Peak | Azimuth degrees | Height meters | Comments |
|----------------------------|-----------------------|------------|----------------------|---------------------------------|----------------------|--------------------|------------------|----------|
| More than 20dB below limit | | | | | | | | |

| | | | |
|-----------|--|------------------|---------------------|
| Client: | Nextivity Inc | Job Number: | J86441 |
| Model: | RS225 WU and RS225 CU | T-Log Number: | T86829 |
| Contact: | Steve van Skike | Account Manager: | Sheareen Washington |
| Standard: | RSS 132, RSS 133, FCC Part 22, FCC Part 24 | Class: | - |

Radiated Emissions

(Elliott Laboratories Fremont Facility, Semi-Anechoic Chamber)

Test Specific Details

Objective: The objective of this test session is to perform final qualification testing of the EUT with respect to the specification listed above.

| | |
|-----------------------------------|------------------------|
| Date of Test: 5/4/2012 | Config. Used: 1 |
| Test Engineer: Joseph Cadigal | Config Change: none |
| Test Location: Fremont Chamber #5 | EUT Voltage: 120V/60Hz |

General Test Configuration

The EUT and any local support equipment were located on the turntable for radiated emissions testing. Any remote support equipment was located outside the semi-anechoic chamber. Any cables running to remote support equipment were routed through metal conduit and when possible passed through a ferrite clamp upon exiting the chamber.

The test distance and extrapolation factor (if applicable) are detailed under each run description.

Ambient Conditions:

| | |
|----------------|-------|
| Temperature: | 23 °C |
| Rel. Humidity: | 37 % |

Summary of Results

| Run # | Test Performed | Limit | Result | Margin |
|--------|--|-------|--------|--------------|
| 1 - 12 | Radiated Emissions 30 - 1000 MHz, Maximized | FCC | Pass | >20dB margin |

Modifications Made During Testing

No modifications were made to the EUT during testing

Deviations From The Standard

No deviations were made from the requirements of the standard.

| | | | |
|-----------|--|------------------|---------------------|
| Client: | Nextivity Inc | Job Number: | J86441 |
| Model: | RS225 WU and RS225 CU | T-Log Number: | T86829 |
| Contact: | Steve van Skike | Account Manager: | Sheareen Washington |
| Standard: | RSS 132, RSS 133, FCC Part 22, FCC Part 24 | Class: | - |

Run #1: Radiated Emissions, 30 - 1000 MHz

| Frequency Range | Test Distance | Limit Distance | Extrapolation Factor |
|-----------------|---------------|----------------|----------------------|
| 30 - 1000 MHz | 3 | 3 | 0.0 |

Band 5 3 channels RF low

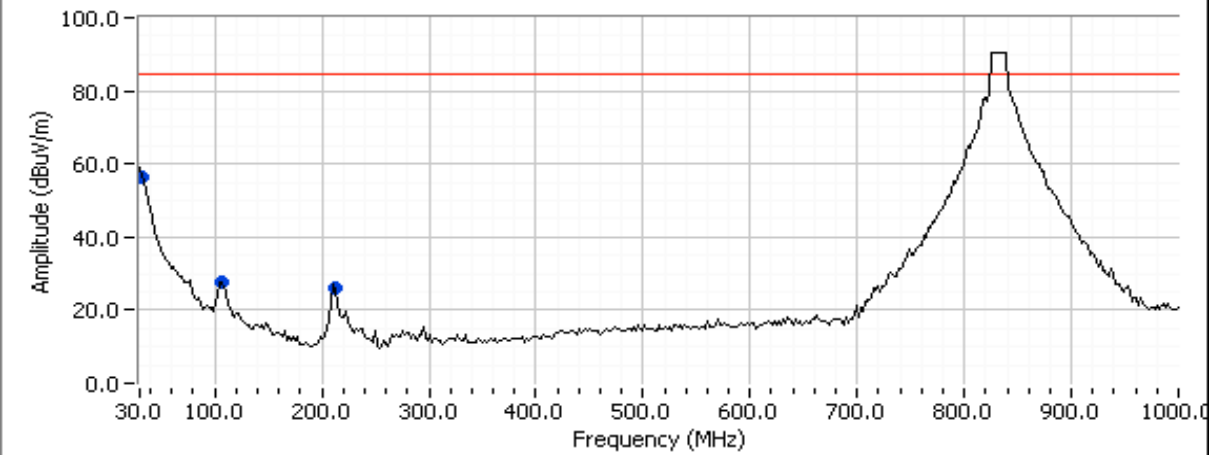

Spurious Emissions

| Frequency MHz | Level dBµV/m | Pol v/h | FCC | | Detector Pk/QP/Avg | Azimuth degrees | Height meters | Comments |
|------------------|-----------------|------------|-------|--------|-----------------------|--------------------|------------------|----------|
| | | | Limit | Margin | | | | |
| 211.679 | 26.0 | H | 84.4 | -58.4 | Peak | 63 | 1.0 | |
| 106.197 | 27.6 | H | 84.4 | -56.8 | Peak | 67 | 3.0 | |
| 30.058 | 56.5 | V | 84.4 | -27.9 | Peak | 104 | 2.0 | |

| | | | |
|-----------|--|------------------|---------------------|
| Client: | Nextivity Inc | Job Number: | J86441 |
| Model: | RS225 WU and RS225 CU | T-Log Number: | T86829 |
| Contact: | Steve van Skike | Account Manager: | Sheareen Washington |
| Standard: | RSS 132, RSS 133, FCC Part 22, FCC Part 24 | Class: | - |

Run #2: Radiated Emissions, 30 - 1000 MHz

| Frequency Range | Test Distance | Limit Distance | Extrapolation Factor |
|-----------------|---------------|----------------|----------------------|
| 30 - 1000 MHz | 3 | 3 | 0.0 |

Band 5 single channel

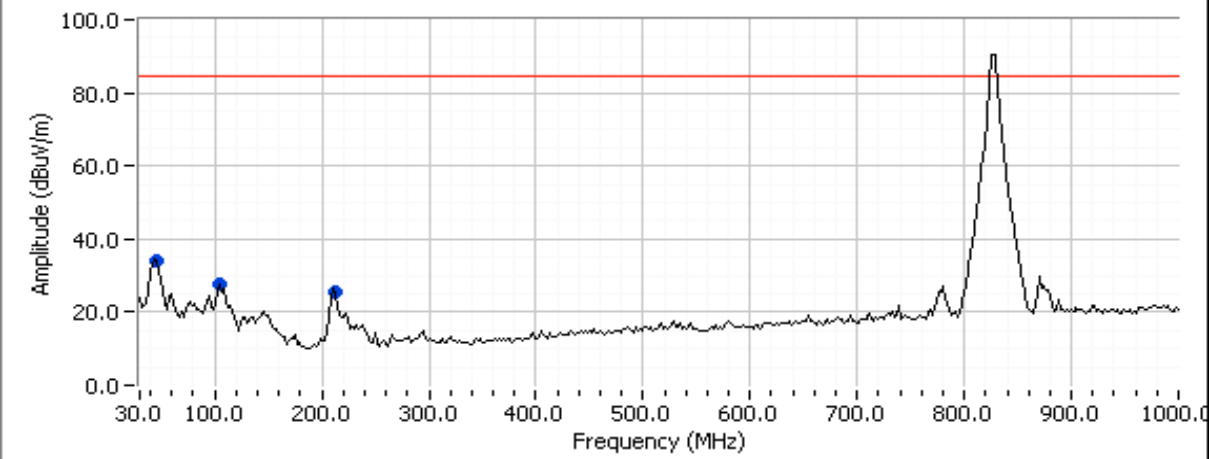

Spurious Emissions

| Frequency MHz | Level dBµV/m | Pol v/h | FCC | | Detector Pk/QP/Avg | Azimuth degrees | Height meters | Comments |
|------------------|-----------------|------------|-------|--------|-----------------------|--------------------|------------------|----------|
| | | | Limit | Margin | | | | |
| 103.662 | 27.5 | V | 84.4 | -56.9 | Peak | 0 | 1.0 | |
| 212.309 | 25.6 | H | 84.4 | -58.8 | Peak | 221 | 1.5 | |
| 44.233 | 33.9 | V | 84.4 | -50.5 | Peak | 253 | 1.0 | |

| | | | |
|-----------|--|------------------|---------------------|
| Client: | Nextivity Inc | Job Number: | J86441 |
| Model: | RS225 WU and RS225 CU | T-Log Number: | T86829 |
| Contact: | Steve van Skike | Account Manager: | Sheareen Washington |
| Standard: | RSS 132, RSS 133, FCC Part 22, FCC Part 24 | Class: | - |

Run #3: Radiated Emissions, 30 - 1000 MHz

| Frequency Range | Test Distance | Limit Distance | Extrapolation Factor |
|-----------------|---------------|----------------|----------------------|
| 30 - 1000 MHz | 3 | 3 | 0.0 |

Band 5 Three RF chain MID

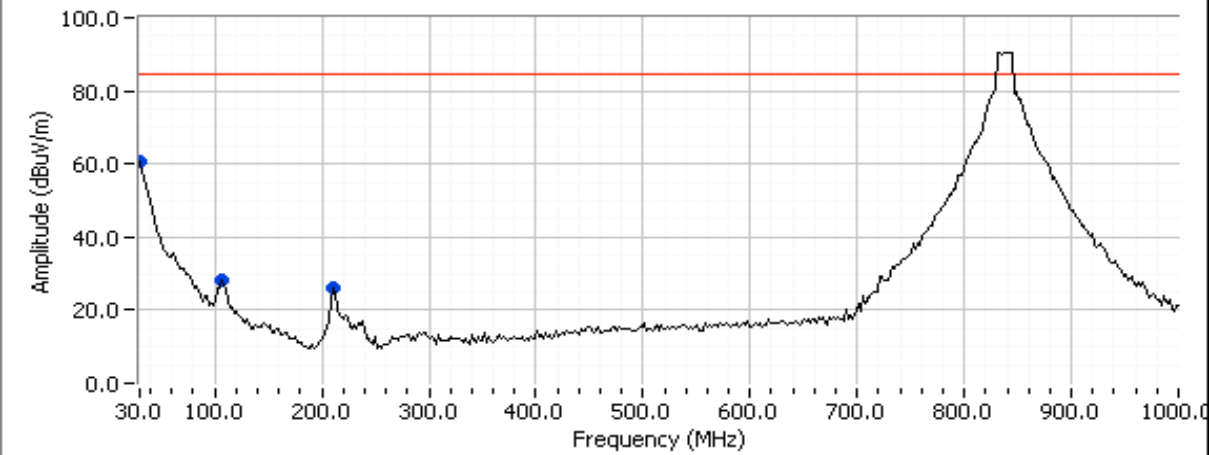

Spurious Emissions

| Frequency MHz | Level dB μ V/m | Pol v/h | FCC | | Detector Pk/QP/Avg | Azimuth degrees | Height meters | Comments |
|------------------|-----------------------|------------|-------|--------|-----------------------|--------------------|------------------|----------|
| | | | Limit | Margin | | | | |
| 104.548 | 28.0 | H | 84.4 | -56.4 | Peak | 71 | 3.0 | |
| 30.051 | 60.9 | V | 84.4 | -23.5 | Peak | 77 | 1.0 | |
| 211.151 | 26.0 | H | 84.4 | -58.4 | Peak | 240 | 1.5 | |

| | | | |
|-----------|--|------------------|---------------------|
| Client: | Nextivity Inc | Job Number: | J86441 |
| Model: | RS225 WU and RS225 CU | T-Log Number: | T86829 |
| Contact: | Steve van Skike | Account Manager: | Sheareen Washington |
| Standard: | RSS 132, RSS 133, FCC Part 22, FCC Part 24 | Class: | - |

Run #4: Radiated Emissions, 30 - 1000 MHz

| Frequency Range | Test Distance | Limit Distance | Extrapolation Factor |
|-----------------|---------------|----------------|----------------------|
| 30 - 1000 MHz | 3 | 3 | 0.0 |

Band 5 Single MID channel

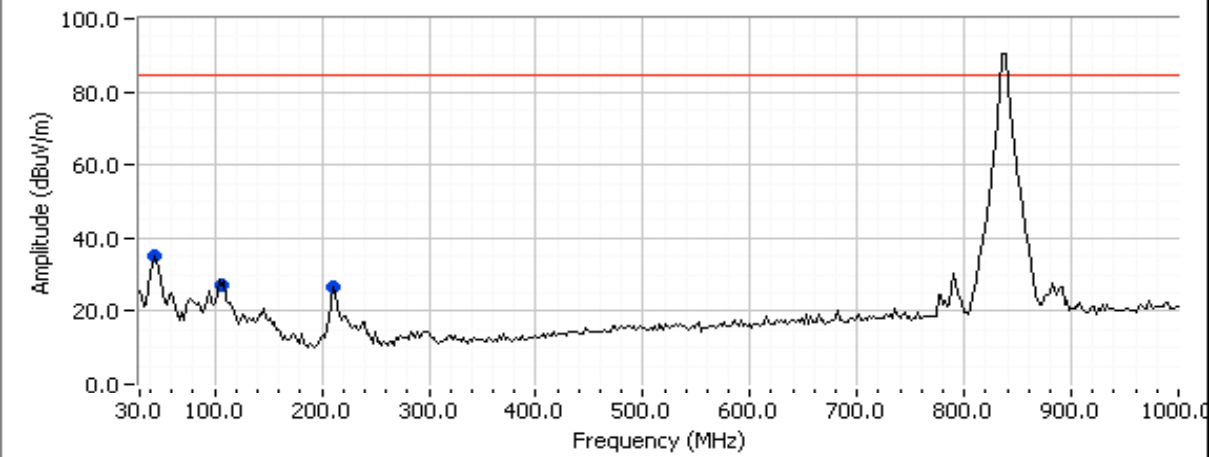

Spurious Emissions

| Frequency MHz | Level dB μ V/m | Pol v/h | FCC | | Detector Pk/QP/Avg | Azimuth degrees | Height meters | Comments |
|------------------|-----------------------|------------|-------|--------|-----------------------|--------------------|------------------|----------|
| | | | Limit | Margin | | | | |
| 212.224 | 26.7 | H | 84.4 | -57.7 | Peak | 39 | 2.0 | |
| 104.642 | 27.0 | V | 84.4 | -57.4 | Peak | 308 | 1.0 | |
| 43.743 | 35.3 | V | 84.4 | -49.1 | Peak | 321 | 1.0 | |

| | | | |
|-----------|--|------------------|---------------------|
| Client: | Nextivity Inc | Job Number: | J86441 |
| Model: | RS225 WU and RS225 CU | T-Log Number: | T86829 |
| Contact: | Steve van Skike | Account Manager: | Sheareen Washington |
| Standard: | RSS 132, RSS 133, FCC Part 22, FCC Part 24 | Class: | - |

Run #5: Radiated Emissions, 30 - 1000 MHz

| Frequency Range | Test Distance | Limit Distance | Extrapolation Factor |
|-----------------|---------------|----------------|----------------------|
| 30 - 1000 MHz | 3 | 3 | 0.0 |

Band 5 Three RF chain high

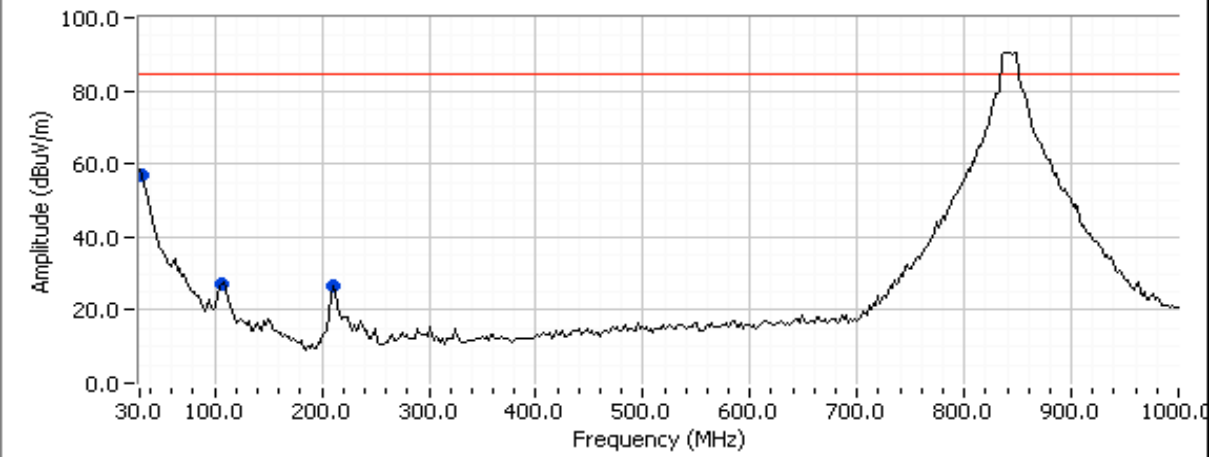

Spurious Emissions

| Frequency | Level | Pol | FCC | | Detector | Azimuth | Height | Comments |
|-----------|--------------|-----|-------|--------|-----------|---------|--------|----------|
| | | | Limit | Margin | | | | |
| MHz | dB μ V/m | v/h | Limit | Margin | Pk/QP/Avg | degrees | meters | |
| 30.051 | 56.8 | V | 84.4 | -27.6 | Peak | 53 | 1.0 | |
| 211.851 | 26.4 | H | 84.4 | -58.0 | Peak | 236 | 1.5 | |
| 104.867 | 27.3 | V | 84.4 | -57.1 | Peak | 312 | 1.0 | |

| | | | |
|-----------|--|------------------|---------------------|
| Client: | Nextivity Inc | Job Number: | J86441 |
| Model: | RS225 WU and RS225 CU | T-Log Number: | T86829 |
| Contact: | Steve van Skike | Account Manager: | Sheareen Washington |
| Standard: | RSS 132, RSS 133, FCC Part 22, FCC Part 24 | Class: | - |

Run #6: Radiated Emissions, 30 - 1000 MHz

| Frequency Range | Test Distance | Limit Distance | Extrapolation Factor |
|-----------------|---------------|----------------|----------------------|
| 30 - 1000 MHz | 3 | 3 | 0.0 |

Band 5 single highest chain

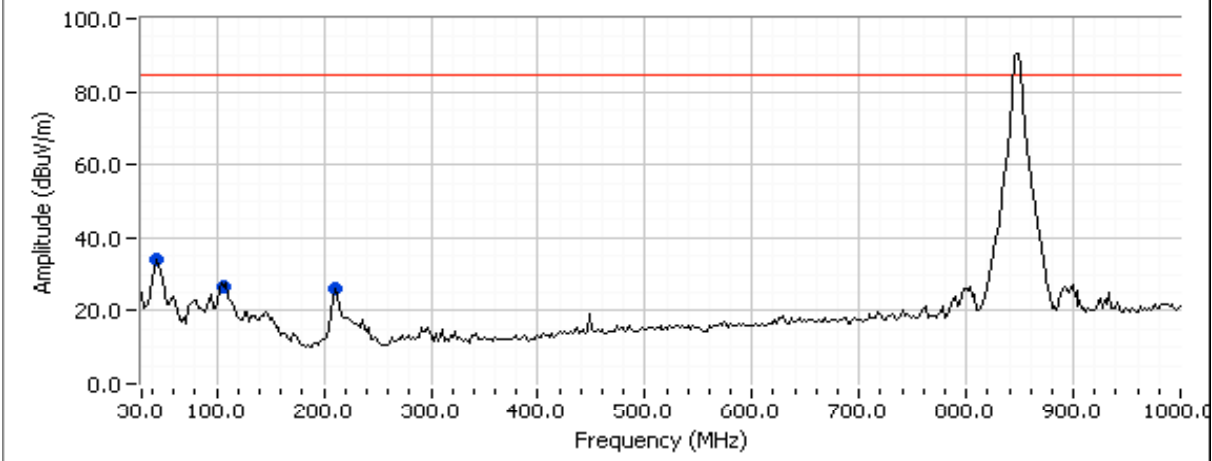

Spurious Emissions

| Frequency MHz | Level dB μ V/m | Pol v/h | FCC | | Detector Pk/QP/Avg | Azimuth degrees | Height meters | Comments |
|------------------|-----------------------|------------|-------|--------|-----------------------|--------------------|------------------|----------|
| | | | Limit | Margin | | | | |
| 41.667 | 34.1 | V | 84.4 | -50.3 | Peak | 3 | 1.0 | |
| 211.027 | 26.1 | H | 84.4 | -58.3 | Peak | 246 | 1.5 | |
| 104.712 | 26.4 | V | 84.4 | -58.0 | Peak | 325 | 1.0 | |

| | | | |
|-----------|--|------------------|---------------------|
| Client: | Nextivity Inc | Job Number: | J86441 |
| Model: | RS225 WU and RS225 CU | T-Log Number: | T86829 |
| Contact: | Steve van Skike | Account Manager: | Sheareen Washington |
| Standard: | RSS 132, RSS 133, FCC Part 22, FCC Part 24 | Class: | - |

Run #7: Radiated Emissions, 30 - 1000 MHz

| Frequency Range | Test Distance | Limit Distance | Extrapolation Factor |
|-----------------|---------------|----------------|----------------------|
| 30 - 1000 MHz | 3 | 3 | 0.0 |

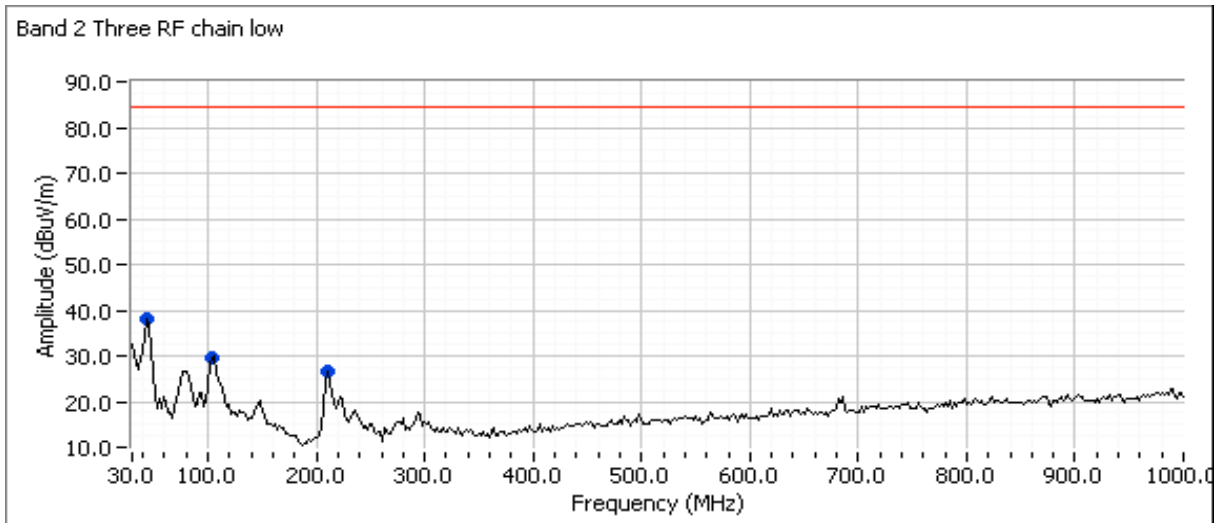

Spurious Emissions

| Frequency MHz | Level dB μ V/m | Pol v/h | FCC | | Detector Pk/QP/Avg | Azimuth degrees | Height meters | Comments |
|------------------|-----------------------|------------|-------|--------|-----------------------|--------------------|------------------|----------|
| | | | Limit | Margin | | | | |
| 211.354 | 26.6 | H | 84.4 | -57.8 | Peak | 245 | 1.0 | |
| 45.236 | 38.0 | V | 84.4 | -46.4 | Peak | 311 | 1.0 | |
| 104.603 | 29.6 | V | 84.4 | -54.8 | Peak | 345 | 1.0 | |

| | | | |
|-----------|--|------------------|---------------------|
| Client: | Nextivity Inc | Job Number: | J86441 |
| Model: | RS225 WU and RS225 CU | T-Log Number: | T86829 |
| Contact: | Steve van Skike | Account Manager: | Sheareen Washington |
| Standard: | RSS 132, RSS 133, FCC Part 22, FCC Part 24 | Class: | - |

Run #8: Radiated Emissions, 30 - 1000 MHz

| Frequency Range | Test Distance | Limit Distance | Extrapolation Factor |
|-----------------|---------------|----------------|----------------------|
| 30 - 1000 MHz | 3 | 3 | 0.0 |

Band 2 Single channel low

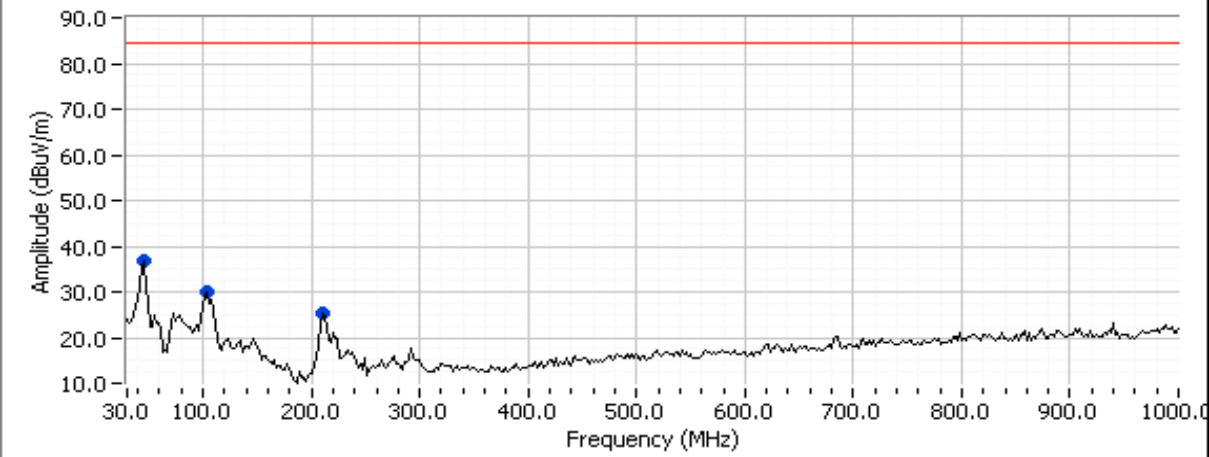

Spurious Emissions

| Frequency MHz | Level dBµV/m | Pol v/h | FCC | | Detector Pk/QP/Avg | Azimuth degrees | Height meters | Comments |
|------------------|-----------------|------------|-------|--------|-----------------------|--------------------|------------------|----------|
| | | | Limit | Margin | | | | |
| 211.859 | 25.2 | H | 84.4 | -59.2 | Peak | 228 | 2.0 | |
| 103.227 | 30.2 | V | 84.4 | -54.2 | Peak | 334 | 1.0 | |
| 44.186 | 36.6 | V | 84.4 | -47.8 | Peak | 360 | 1.0 | |

| | | | |
|-----------|--|------------------|---------------------|
| Client: | Nextivity Inc | Job Number: | J86441 |
| Model: | RS225 WU and RS225 CU | T-Log Number: | T86829 |
| Contact: | Steve van Skike | Account Manager: | Sheareen Washington |
| Standard: | RSS 132, RSS 133, FCC Part 22, FCC Part 24 | Class: | - |

Run #9: Radiated Emissions, 30 - 1000 MHz

| Frequency Range | Test Distance | Limit Distance | Extrapolation Factor |
|-----------------|---------------|----------------|----------------------|
| 30 - 1000 MHz | 3 | 3 | 0.0 |

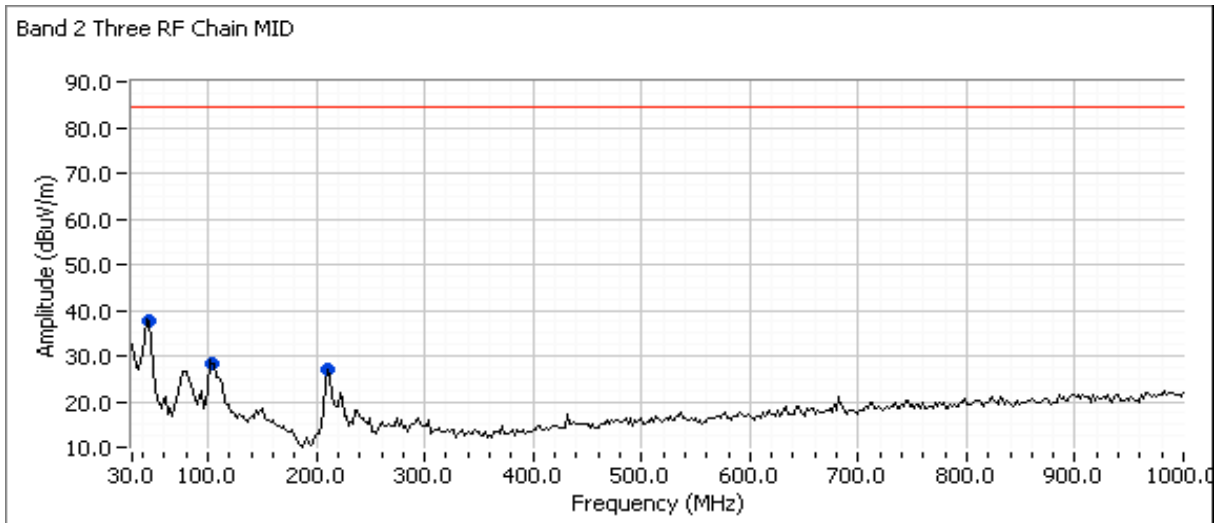

Spurious Emissions

| Frequency MHz | Level dB μ V/m | Pol v/h | FCC | | Detector Pk/QP/Avg | Azimuth degrees | Height meters | Comments |
|------------------|-----------------------|------------|-------|--------|-----------------------|--------------------|------------------|----------|
| | | | Limit | Margin | | | | |
| 104.191 | 28.3 | V | 84.4 | -56.1 | Peak | 2 | 2.0 | |
| 211.587 | 27.0 | H | 84.4 | -57.4 | Peak | 235 | 1.0 | |
| 45.042 | 37.5 | V | 84.4 | -46.9 | Peak | 351 | 1.0 | |

| | | | |
|-----------|--|------------------|---------------------|
| Client: | Nextivity Inc | Job Number: | J86441 |
| Model: | RS225 WU and RS225 CU | T-Log Number: | T86829 |
| Contact: | Steve van Skike | Account Manager: | Sheareen Washington |
| Standard: | RSS 132, RSS 133, FCC Part 22, FCC Part 24 | Class: | - |

Run #10: Radiated Emissions, 30 - 1000 MHz

| Frequency Range | Test Distance | Limit Distance | Extrapolation Factor |
|-----------------|---------------|----------------|----------------------|
| 30 - 1000 MHz | 3 | 3 | 0.0 |

Band 2 Single MID chain

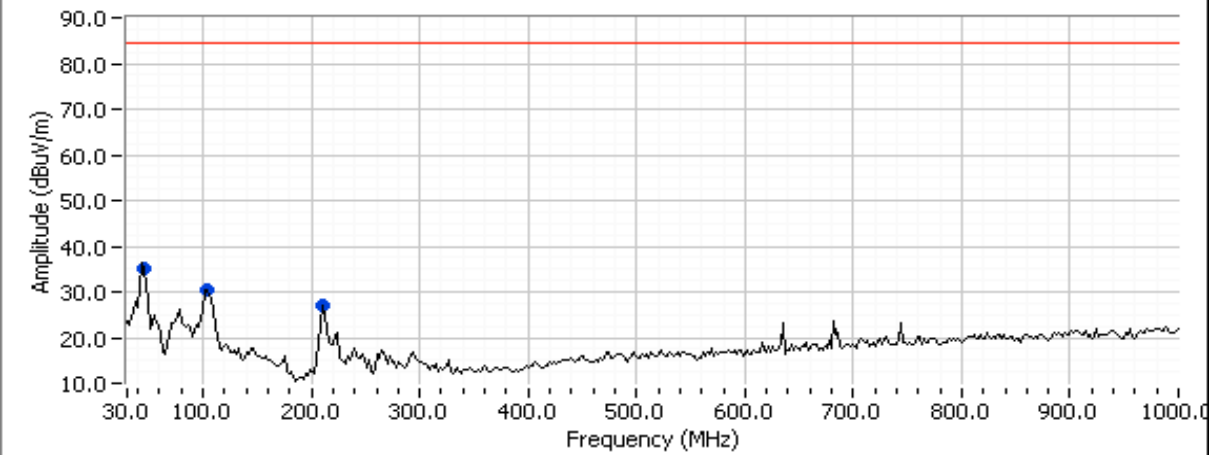

Spurious Emissions

| Frequency MHz | Level dBµV/m | Pol v/h | FCC | | Detector Pk/QP/Avg | Azimuth degrees | Height meters | Comments |
|------------------|-----------------|------------|-------|--------|-----------------------|--------------------|------------------|----------|
| | | | Limit | Margin | | | | |
| 101.951 | 30.5 | V | 84.4 | -53.9 | Peak | 3 | 1.0 | |
| 211.556 | 26.9 | H | 84.4 | -57.5 | Peak | 224 | 1.0 | |
| 43.875 | 35.1 | V | 84.4 | -49.3 | Peak | 282 | 1.0 | |

| | | | |
|-----------|--|------------------|---------------------|
| Client: | Nextivity Inc | Job Number: | J86441 |
| Model: | RS225 WU and RS225 CU | T-Log Number: | T86829 |
| Contact: | Steve van Skike | Account Manager: | Sheareen Washington |
| Standard: | RSS 132, RSS 133, FCC Part 22, FCC Part 24 | Class: | - |

Run #11: Radiated Emissions, 30 - 1000 MHz

| Frequency Range | Test Distance | Limit Distance | Extrapolation Factor |
|-----------------|---------------|----------------|----------------------|
| 30 - 1000 MHz | 3 | 3 | 0.0 |

Band 2 Three RF Chain High

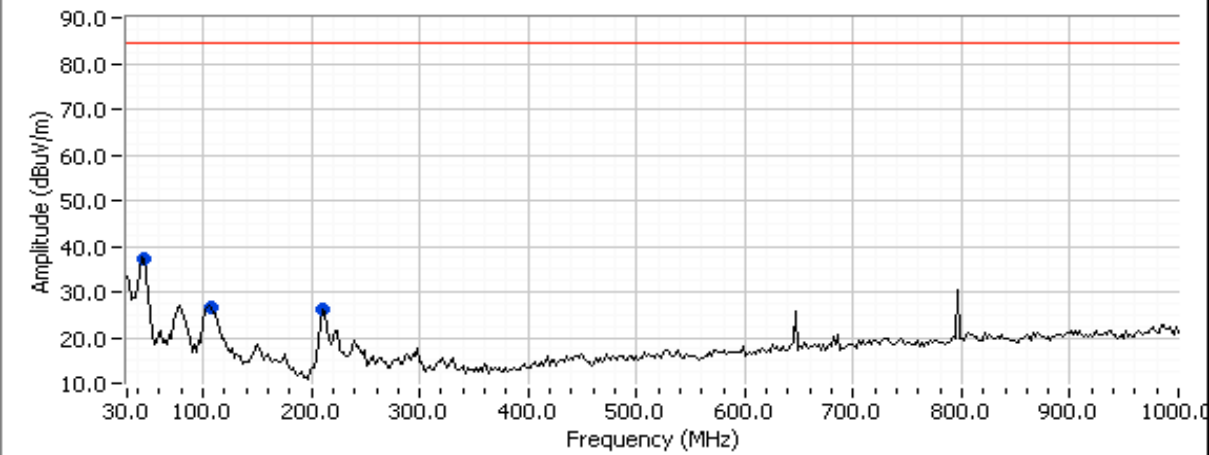

Spurious Emissions

| Frequency MHz | Level dB μ V/m | Pol v/h | FCC | | Detector Pk/QP/Avg | Azimuth degrees | Height meters | Comments |
|------------------|-----------------------|------------|-------|--------|-----------------------|--------------------|------------------|----------|
| | | | Limit | Margin | | | | |
| 45.360 | 37.3 | V | 84.4 | -47.1 | Peak | 328 | 1.0 | |
| 106.399 | 26.8 | V | 84.4 | -57.6 | Peak | 308 | 1.0 | |
| 211.797 | 26.0 | H | 84.4 | -58.4 | Peak | 206 | 1.0 | |

| | | | |
|-----------|--|------------------|---------------------|
| Client: | Nextivity Inc | Job Number: | J86441 |
| Model: | RS225 WU and RS225 CU | T-Log Number: | T86829 |
| Contact: | Steve van Skike | Account Manager: | Sheareen Washington |
| Standard: | RSS 132, RSS 133, FCC Part 22, FCC Part 24 | Class: | - |

Run #12: Radiated Emissions, 30 - 1000 MHz

| Frequency Range | Test Distance | Limit Distance | Extrapolation Factor |
|-----------------|---------------|----------------|----------------------|
| 30 - 1000 MHz | 3 | 3 | 0.0 |

Band 2 Single highest channel

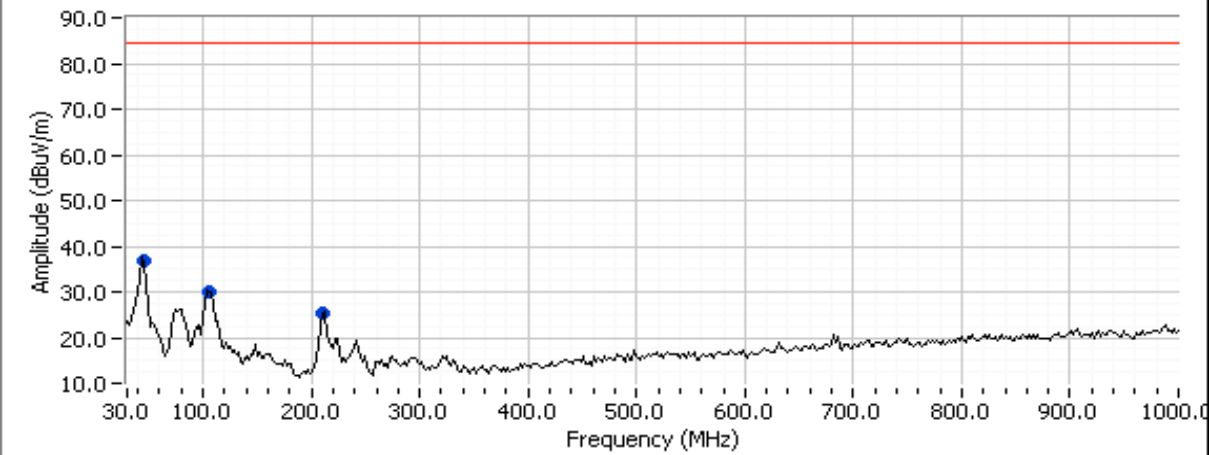

Spurious Emissions

| Frequency MHz | Level dB μ V/m | Pol v/h | FCC | | Detector Pk/QP/Avg | Azimuth degrees | Height meters | Comments |
|------------------|-----------------------|------------|-------|--------|-----------------------|--------------------|------------------|----------|
| | | | Limit | Margin | | | | |
| 210.887 | 25.5 | H | 84.4 | -58.9 | Peak | 68 | 1.0 | |
| 105.831 | 30.2 | V | 84.4 | -54.2 | Peak | 357 | 1.0 | |
| 44.645 | 36.6 | V | 84.4 | -47.8 | Peak | 271 | 1.0 | |

End of Report

This page is intentionally blank and marks the last page of this test report.