

*TEST REPORT*

*Covering the  
DYNAMIC FREQUENCY SELECTION (DFS)  
REQUIREMENTS  
OF*

*FCC Part 15 Subpart E (UNII), RSS-210 Annex 9*

*Nextivity Inc.  
Model(s): CELFI-RS225WU & CELFI-RS225CU*

COMPANY: Nextivity Inc.  
12230 World Trade Drive Suite 250  
San Diego, CA, 92128

TEST SITE: Elliott Laboratories  
41039 Boyce Road  
Fremont, CA 94538

REPORT DATE: May 1, 2012

FINAL TEST DATE: March 26, 27, 2012

TEST ENGINEER: Wayne Fisher

PROGRAM MGR /  
TECHNICAL REVIEWER:

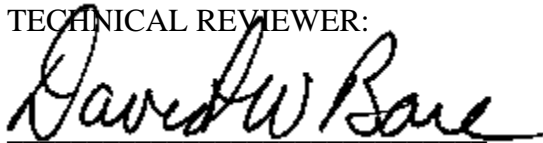

David Bare  
Chief Engineer

QUALITY ASSURANCE DELEGATE /  
FINAL REPORT PREPARER:



David Guidotti  
Senior Technical Writer



Elliott Laboratories is accredited by the A2LA, certificate number 0214.26, to perform the test(s) listed in this report, except where noted otherwise. This report and the information contained herein represent the results of testing test articles identified and selected by the client performed to specifications and/or procedures selected by the client. National Technical Systems (NTS) makes no representations, expressed or implied, that such testing is adequate (or inadequate) to demonstrate efficiency, performance, reliability, or any other characteristic of the articles being tested, or similar products. This report should not be relied upon as an endorsement or certification by NTS of the equipment tested, nor does it represent any statement **whatsoever** as to its merchantability or fitness of the test article, or similar products, for a particular purpose. This report shall not be reproduced except in full

**REVISION HISTORY**

Rev #	Date	Comments	Modified By
1.0	05-01-2012	First Release	-

**TABLE OF CONTENTS**

<b>REVISION HISTORY .....</b>	<b>2</b>
<b>TABLE OF CONTENTS .....</b>	<b>3</b>
<b>LIST OF TABLES.....</b>	<b>4</b>
<b>LIST OF FIGURES.....</b>	<b>7</b>
<b>SCOPE.....</b>	<b>8</b>
<b>OBJECTIVE.....</b>	<b>8</b>
<b>STATEMENT OF COMPLIANCE.....</b>	<b>8</b>
<b>DEVIATIONS FROM THE STANDARD.....</b>	<b>8</b>
<b>TEST RESULTS.....</b>	<b>9</b>
TEST RESULTS SUMMARY – FCC PART 15, MASTER DEVICE .....	9
MEASUREMENT UNCERTAINTIES.....	13
<b>EQUIPMENT UNDER TEST (EUT) DETAILS.....</b>	<b>14</b>
GENERAL.....	14
ENCLOSURE.....	16
MODIFICATIONS.....	16
SUPPORT EQUIPMENT.....	16
EUT INTERFACE PORTS .....	16
EUT OPERATION .....	17
<b>RADAR WAVEFORMS.....</b>	<b>18</b>
<b>DFS TEST METHODS.....</b>	<b>19</b>
RADIATED TEST METHOD .....	19
<b>DFS MEASUREMENT INSTRUMENTATION.....</b>	<b>21</b>
RADAR GENERATION SYSTEM .....	21
CHANNEL MONITORING SYSTEM.....	22
<b>DFS MEASUREMENT METHODS .....</b>	<b>23</b>
DFS RADAR DETECTION BANDWIDTH .....	23
DFS – CHANNEL CLOSING TRANSMISSION TIME AND CHANNEL MOVE TIME .....	23
DFS – CHANNEL NON-OCCUPANCY AND VERIFICATION OF PASSIVE SCANNING.....	23
DFS CHANNEL AVAILABILITY CHECK TIME.....	24
UNIFORM LOADING.....	24
TRANSMIT POWER CONTROL (TPC) .....	24
<b>SAMPLE CALCULATIONS .....</b>	<b>25</b>
DETECTION PROBABILITY / SUCCESS RATE .....	25
THRESHOLD LEVEL .....	25
<b>APPENDIX A TEST EQUIPMENT CALIBRATION DATA .....</b>	<b>26</b>
<b>APPENDIX B TEST DATA TABLES FOR RADAR DETECTION PROBABILITY .....</b>	<b>27</b>
<b>APPENDIX C TEST DATA TABLES AND PLOTS FOR CHANNEL CLOSING .....</b>	<b>169</b>
FCC PART 15 SUBPART E CHANNEL CLOSING MEASUREMENTS .....	169
<b>APPENDIX D TEST DATA – CHANNEL AVAILABILITY CHECK.....</b>	<b>183</b>
5250- 5350 MHZ, 5470 – 5725 MHZ .....	183
<b>APPENDIX E ANTENNA SPECIFICATION .....</b>	<b>187</b>
<b>APPENDIX F TEST CONFIGURATION PHOTOGRAPH(S) .....</b>	<b>195</b>
<b>APPENDIX G DFS IMPLEMENTATION PROPOSAL FOR CEL-FI U-NII LINK.....</b>	<b>196</b>

**LIST OF TABLES**

Table 1 FCC Part 15 Subpart E Master Device Test Result Summary – WU (CU Synchronization Mode) Fl .....	9
Table 2 FCC Part 15 Subpart E Master Device Test Result Summary – WU (CU Synchronization Mode) Fh .....	10
Table 3 FCC Part 15 Subpart E Master Device Test Result Summary – CU (Steady State Mode) Fl .....	11
Table 4 FCC Part 15 Subpart E Master Device Test Result Summary – WU (Steady State Mode) Fh .....	12
Table 5 FCC Short Pulse Radar Test Waveforms.....	18
Table 6 FCC Long Pulse Radar Test Waveforms.....	18
Table 7 FCC Frequency Hopping Radar Test Waveforms .....	18
<b>Table 8 – CU - Detection Bandwidth Measurements (Bandwidth: +11MHz /-11MHz) .....</b>	<b>28</b>
Table 9 - Summary of All Results - CU Steady State.....	28
Table 10 - FCC Short Pulse Radar (Type 1) Results CU Steady State.....	29
Table 11 - FCC Short Pulse Radar (Type 2) Results CU Steady State.....	30
Table 12 - FCC Short Pulse Radar (Type 3) Results CU Steady State.....	31
Table 13 - FCC Short Pulse Radar (Type 4) Results CU Steady State.....	32
Table 14 - Long Sequence Waveform Summary CU Steady State.....	33
Table 15 - CU Steady State Long Sequence Waveform Trial#1 (Detected) .....	33
Table 16 - CU Steady State Long Sequence Waveform Trial#2 (Detected) .....	34
Table 17 - CU Steady State Long Sequence Waveform Trial#3 (Detected) .....	34
Table 18 - CU Steady State Long Sequence Waveform Trial#4 (Detected) .....	34
Table 19 - CU Steady State Long Sequence Waveform Trial#5 (Detected) .....	35
Table 20 - CU Steady State Long Sequence Waveform Trial#6 (Detected) .....	35
Table 21 - CU Steady State Long Sequence Waveform Trial#7 (Detected) .....	36
Table 22 - CU Steady State Long Sequence Waveform Trial#8 (Detected) .....	36
Table 23 - CU Steady State Long Sequence Waveform Trial#9 (Detected) .....	37
Table 24 - CU Steady State Long Sequence Waveform Trial#10 (Detected) .....	37
Table 25 - CU Steady State Long Sequence Waveform Trial#11 (Detected) .....	38
Table 26 - CU Steady State Long Sequence Waveform Trial#12 (Detected) .....	38
Table 27 - CU Steady State Long Sequence Waveform Trial#13 (Detected) .....	39
Table 28 - CU Steady State Long Sequence Waveform Trial#14 (Detected) .....	39
Table 29 - CU Steady State Long Sequence Waveform Trial#15 (Detected) .....	40
Table 30 - CU Steady State Long Sequence Waveform Trial#16 (Detected) .....	40
Table 31 - CU Steady State Long Sequence Waveform Trial#17 (Detected) .....	41
Table 32 - CU Steady State Long Sequence Waveform Trial#18 (Detected) .....	41
Table 33 - CU Steady State Long Sequence Waveform Trial#19 (Detected) .....	42
Table 34 - CU Steady State Long Sequence Waveform Trial#20 (Detected) .....	42
Table 35 - CU Steady State Long Sequence Waveform Trial#21 (Detected) .....	42
Table 36 - CU Steady State Long Sequence Waveform Trial#22 (Detected) .....	43
Table 37 - CU Steady State Long Sequence Waveform Trial#23 (Detected) .....	43
Table 38 - CU Steady State Long Sequence Waveform Trial#24 (Detected) .....	43
Table 39 - CU Steady State Long Sequence Waveform Trial#25 (Detected) .....	44
Table 40 - CU Steady State Long Sequence Waveform Trial#26 (Detected) .....	44
Table 41 - CU Steady State Long Sequence Waveform Trial#27 (Detected) .....	45
Table 42 - CU Steady State Long Sequence Waveform Trial#28 (Detected) .....	45
Table 43 - CU Steady State Long Sequence Waveform Trial#29 (Detected) .....	46
Table 44 - CU Steady State Long Sequence Waveform Trial#30 (Detected) .....	46
Table 45 - FCC frequency hopping radar (Type 6) Results CU Steady State .....	47
Table 46 – WU, CU Acquire High Band - Detection Bandwidth Measurements (Bandwidth:+17MHz /-16MHz).....	66
Table 47 - Summary of All Results - CU Acquire, High Band .....	67
Table 48 - FCC Short Pulse Radar (Type 1) Results CU Acquire, High Band .....	67
Table 49 - FCC Short Pulse Radar (Type 2) Results CU Acquire, High Band .....	68

Table 50 - FCC Short Pulse Radar (Type 3) Results CU Acquire, High Band .....	69
Table 51 - FCC Short Pulse Radar (Type 4) Results CU Acquire .....	70
Table 52 - Long Sequence Waveform Summary WU, CU Acquire Mode High Band .....	71
Table 53 - WU, CU Acquire Mode High Band, Long Sequence Waveform Trial#1 (Detected) .....	72
Table 54 - WU, CU Acquire Mode High Band, Long Sequence Waveform Trial#2 (Detected) .....	72
Table 55 - WU, CU Acquire Mode High Band, Long Sequence Waveform Trial#3 (Detected) .....	73
Table 56 - WU, CU Acquire Mode High Band, Long Sequence Waveform Trial#4 (Detected) .....	73
Table 57 - WU, CU Acquire Mode High Band, Long Sequence Waveform Trial#5 (Detected) .....	73
Table 58 - WU, CU Acquire Mode High Band, Long Sequence Waveform Trial#6 (Detected) .....	74
Table 59 - WU, CU Acquire Mode High Band, Long Sequence Waveform Trial#7 (Detected) .....	74
Table 60 - WU, CU Acquire Mode High Band, Long Sequence Waveform Trial#8 (Detected) .....	75
Table 61 - WU, CU Acquire Mode High Band, Long Sequence Waveform Trial#9 (Detected) .....	75
Table 62 - WU, CU Acquire Mode High Band, Long Sequence Waveform Trial#10 (Detected) .....	76
Table 63 - WU, CU Acquire Mode High Band, Long Sequence Waveform Trial#11 (Detected) .....	76
Table 64 - WU, CU Acquire Mode High Band, Long Sequence Waveform Trial#12 (Detected) .....	77
Table 65 - WU, CU Acquire Mode High Band, Long Sequence Waveform Trial#13 (Detected) .....	77
Table 66 - WU, CU Acquire Mode High Band, Long Sequence Waveform Trial#14 (Detected) .....	77
Table 67 - WU, CU Acquire Mode High Band, Long Sequence Waveform Trial#15 (Detected) .....	78
Table 68 - WU, CU Acquire Mode High Band, Long Sequence Waveform Trial#16 (Detected) .....	78
Table 69 - WU, CU Acquire Mode High Band, Long Sequence Waveform Trial#17 (Detected) .....	78
Table 70 - WU, CU Acquire Mode High Band, Long Sequence Waveform Trial#18 (Detected) .....	79
Table 71 - WU, CU Acquire Mode High Band, Long Sequence Waveform Trial#19 (Detected) .....	79
Table 72 - WU, CU Acquire Mode High Band, Long Sequence Waveform Trial#20 (Detected) .....	79
Table 73 - WU, CU Acquire Mode High Band, Long Sequence Waveform Trial#21 (Detected) .....	80
Table 74 - WU, CU Acquire Mode High Band, Long Sequence Waveform Trial#22 (Detected) .....	80
Table 75 - WU, CU Acquire Mode High Band, Long Sequence Waveform Trial#23 (Detected) .....	81
Table 76 - WU, CU Acquire Mode High Band, Long Sequence Waveform Trial#24 (Detected) .....	81
Table 77 - WU, CU Acquire Mode High Band, Long Sequence Waveform Trial#25 (Detected) .....	82
Table 78 - WU, CU Acquire Mode High Band, Long Sequence Waveform Trial#26 (Detected) .....	82
Table 79 - WU, CU Acquire Mode High Band, Long Sequence Waveform Trial#27 (Detected) .....	83
Table 80 - WU, CU Acquire Mode High Band, Long Sequence Waveform Trial#28 (Detected) .....	83
Table 81 - WU, CU Acquire Mode High Band, Long Sequence Waveform Trial#29 (Detected) .....	84
Table 82 - WU, CU Acquire Mode High Band, Long Sequence Waveform Trial#30 (Detected) .....	84
Table 83 - FCC frequency hopping radar (Type 6) Results, WU, CU Acquire Mode High Band .....	85
Table 84 WU, CU Acquire Low Band Detection Bandwidth Measurements (Bandwidth: +11MHz /- 11MHz) .....	99
Table 85 - Summary of All Results – WU, CU Acquire LowBand .....	99
Table 86 - FCC Short Pulse Radar (Type 1) Results WU, CU Acquire LowBand .....	100
Table 87 - FCC Short Pulse Radar (Type 2) Results WU, CU Acquire LowBand .....	101
Table 88 - FCC Short Pulse Radar (Type 3) Results WU, CU Acquire LowBand .....	102
Table 89 - FCC Short Pulse Radar (Type 4) Results WU, CU Acquire LowBand .....	103
Table 90 - Long Sequence Waveform Summary WU, CU Acquire, Low Band .....	104
Table 91 - WU, CU Acquire, Low Band, Long Sequence Waveform Trial#1 (Detected) .....	104
Table 92 - WU, CU Acquire, Low Band, Long Sequence Waveform Trial#2 (Detected) .....	105
Table 93 - WU, CU Acquire, Low Band, Long Sequence Waveform Trial#3 (Detected) .....	105
Table 94 - WU, CU Acquire, Low Band, Long Sequence Waveform Trial#4 (Detected) .....	106
Table 95 - WU, CU Acquire, Low Band, Long Sequence Waveform Trial#5 (Detected) .....	106
Table 96 - WU, CU Acquire, Low Band, Long Sequence Waveform Trial#6 (Detected) .....	106
Table 97 - WU, CU Acquire, Low Band, Long Sequence Waveform Trial#7 (Detected) .....	107
Table 98 - WU, CU Acquire, Low Band, Long Sequence Waveform Trial#8 (Detected) .....	107
Table 99 - WU, CU Acquire, Low Band, Long Sequence Waveform Trial#9 (Detected) .....	108
Table 100 - WU, CU Acquire, Low Band, Long Sequence Waveform Trial#10 (Detected) .....	108
Table 101 - WU, CU Acquire, Low Band, Long Sequence Waveform Trial#11 (Detected) .....	109
Table 102 - WU, CU Acquire, Low Band, Long Sequence Waveform Trial#12 (Detected) .....	109
Table 103 - WU, CU Acquire, Low Band, Long Sequence Waveform Trial#13 (Detected) .....	110

Table 104 - WU, CU Acquire, Low Band, Long Sequence Waveform Trial#14 (Detected) .....	110
Table 105 - WU, CU Acquire, Low Band, Long Sequence Waveform Trial#15 (Detected) .....	111
Table 106 - WU, CU Acquire, Low Band, Long Sequence Waveform Trial#16 (Detected) .....	111
Table 107 - WU, CU Acquire, Low Band, Long Sequence Waveform Trial#17 (Detected) .....	111
Table 108 - WU, CU Acquire, Low Band, Long Sequence Waveform Trial#18 (Detected) .....	112
Table 109 - WU, CU Acquire, Low Band, Long Sequence Waveform Trial#19 (Detected) .....	112
Table 110 - WU, CU Acquire, Low Band, Long Sequence Waveform Trial#20 (Detected) .....	112
Table 111 - WU, CU Acquire, Low Band, Long Sequence Waveform Trial#21 (Detected) .....	113
Table 112 - WU, CU Acquire, Low Band, Long Sequence Waveform Trial#22 (Detected) .....	113
Table 113 - WU, CU Acquire, Low Band, Long Sequence Waveform Trial#23 (Detected) .....	114
Table 114 - WU, CU Acquire, Low Band, Long Sequence Waveform Trial#24 (Detected) .....	114
Table 115 - WU, CU Acquire, Low Band, Long Sequence Waveform Trial#25 (Detected) .....	115
Table 116 - WU, CU Acquire, Low Band, Long Sequence Waveform Trial#26 (Detected) .....	115
Table 117 - WU, CU Acquire, Low Band, Long Sequence Waveform Trial#27 (Detected) .....	116
Table 118 - WU, CU Acquire, Low Band, Long Sequence Waveform Trial#28 (Detected) .....	116
Table 119 - WU, CU Acquire, Low Band, Long Sequence Waveform Trial#29 (Detected) .....	116
Table 120 - WU, CU Acquire, Low Band, Long Sequence Waveform Trial#30 (Detected) .....	117
Table 121 - FCC frequency hopping radar (Type 6) Results, WU, CU Acquire, Low Band .....	118
Table 122 - Summary of All Results - WU Steady State .....	137
Table 123 - FCC Short Pulse Radar (Type 1) Results WU Steady State .....	137
Table 124 - FCC Short Pulse Radar (Type 2) Results WU Steady State .....	138
Table 125 - FCC Short Pulse Radar (Type 3) Results WU Steady State .....	139
Table 126 - FCC Short Pulse Radar (Type 4) Results WU Steady State .....	140
Table 127 - Long Sequence Waveform Summary WU Steady State .....	141
Table 128 - WU Steady State Long Sequence Waveform Trial#1 (Detected) .....	141
Table 129 - WU Steady State Long Sequence Waveform Trial#2 (Detected) .....	142
Table 130 - WU Steady State Long Sequence Waveform Trial#3 (Detected) .....	142
Table 131 - WU Steady State Long Sequence Waveform Trial#4 (Detected) .....	143
Table 132 - WU Steady State Long Sequence Waveform Trial#5 (Detected) .....	143
Table 133 - WU Steady State Long Sequence Waveform Trial#6 (Detected) .....	144
Table 134 - WU Steady State Long Sequence Waveform Trial#7 (Detected) .....	144
Table 135 - WU Steady State Long Sequence Waveform Trial#8 (Detected) .....	145
Table 136 - WU Steady State Long Sequence Waveform Trial#9 (Detected) .....	145
Table 137 - WU Steady State Long Sequence Waveform Trial#10 (Detected) .....	145
Table 138 - WU Steady State Long Sequence Waveform Trial#11 (Detected) .....	146
Table 139 - WU Steady State Long Sequence Waveform Trial#12 (Detected) .....	146
Table 140 - WU Steady State Long Sequence Waveform Trial#13 (Detected) .....	147
Table 141 - WU Steady State Long Sequence Waveform Trial#14 (Detected) .....	147
Table 142 - WU Steady State Long Sequence Waveform Trial#15 (Detected) .....	147
Table 143 - WU Steady State Long Sequence Waveform Trial#16 (Detected) .....	148
Table 144 - WU Steady State Long Sequence Waveform Trial#17 (Detected) .....	148
Table 145 - WU Steady State Long Sequence Waveform Trial#18 (Detected) .....	148
Table 146 - WU Steady State Long Sequence Waveform Trial#19 (Detected) .....	149
Table 147 - WU Steady State Long Sequence Waveform Trial#20 (Detected) .....	149
Table 148 - WU Steady State Long Sequence Waveform Trial#21 (Detected) .....	150
Table 149 - WU Steady State Long Sequence Waveform Trial#22 (Detected) .....	150
Table 150 - WU Steady State Long Sequence Waveform Trial#23 (Detected) .....	151
Table 151 - WU Steady State Long Sequence Waveform Trial#24 (Detected) .....	151
Table 152 - WU Steady State Long Sequence Waveform Trial#25 (Detected) .....	151
Table 153 - WU Steady State Long Sequence Waveform Trial#26 (Detected) .....	152
Table 154 - WU Steady State Long Sequence Waveform Trial#27 (Detected) .....	152
Table 155 - WU Steady State Long Sequence Waveform Trial#28 (Detected) .....	153
Table 156 - WU Steady State Long Sequence Waveform Trial#29 (Detected) .....	153
Table 157 - WU Steady State Long Sequence Waveform Trial#30 (Detected) .....	154
Table 158 - Summary of All Results - WU Steady State .....	154

Table 159 - FCC frequency hopping radar (Type 6) Results WU Steady State .....	155
Table 160 FCC Part 15 Subpart E Channel Closing Test Results .....	169

### LIST OF FIGURES

Figure 1 Cel-Fi Three-Hop Repeater System.....	14
Figure 2 Test Configuration for radiated Measurement Method .....	19
Figure 3 Channel Utilization During In-Service Detection Measurements .....	27
Figure 4 Channel Closing Time and Channel Move Time – 40 second plot, Low Band, CU Steady State .....	170
Figure 5 Close-Up of Transmissions Occurring More Than 200ms After The End of Radar, Low Band, CU Steady State .....	171
Figure 6 Channel Closing Time and Channel Move Time – 40 second plot, Low Band, CU Steady State .....	172
Figure 7 Close-Up of Transmissions Occurring More Than 200ms After The End of Radar, Low Band, CU Steady State .....	173
Figure 8 Channel Closing Time and Channel Move Time – 40 second plot, High Band, WU Steady State .....	174
Figure 9 Close-Up of Transmissions Occurring More Than 200ms After The End of Radar, High Band, WU Steady State .....	175
Figure 10 Channel Closing Time and Channel Move Time – 40 second plot, High Band, WU Steady State .....	176
Figure 11 Close-Up of Transmissions Occurring More Than 200ms After The End of Radar, High Band, WU Steady State .....	177
Figure 12 Channel Closing Time and Channel Move Time – 40 second plot, Low Band, WU, CU Acquire Mode .....	178
Figure 13 Close-Up of Transmissions Occurring More Than 200ms After The End of Radar, Low Band, WU, CU Acquire Mode .....	179
Figure 14 Channel Closing Time and Channel Move Time – 40 second plot, Low Band, WU, CU Acquire Mode .....	180
Figure 15 Close-Up of Transmissions Occurring More Than 200ms After The End of Radar, Low Band, WU, CU Acquire Mode .....	181
Figure 16 Radar Channel Non-Occupancy Plot, CU Low Band .....	182
Figure 17 Radar Channel Non-Occupancy Plot, WU High Band.....	182
Figure 18 Plot of EUT Start-Up after CAC, WU Low Band .....	183
Figure 19 Plot of EUT Start-Up After CAC, WU High Band .....	184
Figure 20 Radar Applied At Start of CAC, WU Low Band .....	185
Figure 21 Radar Applied At End of CAC, WU Low Band .....	185
Figure 22 Radar Applied At Start of CAC, WU High Band.....	186
Figure 23 Radar Applied At End of CAC, WU High Band.....	186

### **SCOPE**

Test data has been taken pursuant to the relevant DFS requirements of the following standard(s):

- FCC Part 15 Subpart E Unlicensed National Information Infrastructure (U-NII) Devices.
- RSS-210 Annex 9 Local Area Network Devices.

Tests were performed in accordance with these standards together with the current published versions of the basic standards referenced therein as outlined in Elliott Laboratories test procedures. The test results recorded herein are based on a single type test of the Nextivity Inc. models CELFI-RS225WU & CELFI-RS225CU and therefore apply only to the tested samples. The samples were selected and prepared by Steve Van Skike of Nextivity Inc..

### **OBJECTIVE**

The objective of the manufacturer is to comply with the standards identified in the previous section. In order to demonstrate compliance, the manufacturer or a contracted laboratory makes measurements and takes the necessary steps to ensure that the equipment complies with the appropriate technical standards. Compliance with some DFS features is covered through a manufacturer statement or through observation of the device.

### **STATEMENT OF COMPLIANCE**

The tested samples of the Nextivity Inc. models CELFI-RS225WU & CELFI-RS225CU complied with the DFS requirements of FCC Part 15.407(h)(2) RSS-210 Annex A9.3.

Maintenance of compliance is the responsibility of the manufacturer. Any modifications to the product should be assessed to determine their potential impact on the compliance status of the device with respect to the standards detailed in this test report.

### **DEVIATIONS FROM THE STANDARD**

No deviations were made from the test methods and requirements covered by the scope of this report.



**TEST RESULTS****TEST RESULTS SUMMARY – FCC Part 15, MASTER DEVICE**

<b>Table 1 FCC Part 15 Subpart E Master Device Test Result Summary – WU (CU Synchronization Mode) F1</b>						
Description	Radar Type	EUT Frequency	Measured Value	Requirement	Test Data	Status
Channel Availability Check (CAC) Time	Type 1	5284.4 MHz	60s	≥ 60s	Appendix D	Pass
CAC Detection Threshold	Type 1	5284.4 MHz	-62dBm	-62dBm (See note 2)	Appendix D	Pass
In-Service Monitoring Detection Threshold	Type 1 Type 2 Type 3 Type 4 Type 5 Type 6	5284.4 MHz	-62dBm (note 2)	-62dBm (See note 2)	Appendix B	Pass
Bandwidth Detection	Type 1	Varies	MHz	80% of the 99% BW	-	Pass
Channel closing transmission time	Type 1 Type 5	5284.4 MHz	-10ms 0ms	≤ 260ms	Appendix C	Pass
Channel move time	Type 1 Type 5	5284.4 MHz	-10m	≤ 10s	Appendix C	Pass
Uniform Loading		-	-	Uniform Loading	Refer to operational description	-

1) Tests were performed using the radiated test method.  
2) The measured detection threshold is based on testing the master device using the radiated test method when connected to an antenna with a nominal gain of 5.5dBi. The limit is based on an eirp of less than 23dBm.  
3) The in-service monitoring detection threshold and detection probability measurements were made with the device operating in the 5500-5700 MHz band.

<b>Table 2 FCC Part 15 Subpart E Master Device Test Result Summary – WU (CU Synchronization Mode) Fh</b>						
Description	Radar Type	EUT Frequency	Measured Value	Requirement	Test Data	Status
Channel Availability Check (CAC) Time	Type 1	5563.2 MHz	> 60s	≥ 60s	Appendix D	Pass
CAC Detection Threshold	Type 1		-62dBm	-62dBm (See note 2)	Appendix D	Pass
In-Service Monitoring Detection Threshold	Type 1 Type 2 Type 3 Type 4 Type 5 Type 6	5563.2 MHz	-62dBm (note 2)	-62dBm (See note 2)	Appendix B	Pass
Bandwidth Detection	Type 1	Not required in this mode per DFS Implementation Proposal				
Channel closing transmission time	Type 1 Type 5					
Channel move time	Type 1 Type 5					
Non-occupancy period	-	5563.2 MHz	>30 minutes	>30 minutes	Appendix C	Pass
Uniform Loading		-	-	Uniform Loading	Refer to operational description	-
1) Tests were performed using the radiated test method. 2) The measured detection threshold is based on testing the master device using the radiated test method when connected to an antenna with a nominal gain of 5.5dBi. The limit is based on an eirp of less than 23dBm. 3) The in-service monitoring detection threshold and detection probability measurements were made with the device operating in the 5500-5700 MHz band.						

<b>Table 3 FCC Part 15 Subpart E Master Device Test Result Summary – CU (Steady State Mode) F1</b>						
Description	Radar Type	EUT Frequency	Measured Value	Requirement	Test Data	Status
Channel Availability Check (CAC) Time	Type 1	N/A – CU does not perform CAC				
In-Service Monitoring Detection Threshold	Type 1 Type 2 Type 3 Type 4 Type 5 Type 6	5284.8 MHz	-62dBm (note 2)	-62dBm (See note 2)	Appendix B	Pass
Bandwidth Detection	Type 1	Varies	MHz	80% of the 99% BW	-	Pass
Channel closing transmission time	Type 1 Type 5	5284.4 MHz	-10ms 0ms	≤ 260ms	Appendix C	Pass
Channel move time	Type 1 Type 5	5284.4 MHz	0ms -10.07s	≤ 10s	Appendix C	Pass
Non-occupancy period	-	5284.4 MHz	>30 minutes	>30 minutes	Appendix C	Pass
Uniform Loading		-	-	Uniform Loading	Refer to operational description	-
1) Tests were performed using the radiated test method. 2) The measured detection threshold is based on testing the master device using the radiated test method when connected to an antenna with a nominal gain of 5.5dBi. The limit is based on an eirp of less than 23dBm. 3) The in-service monitoring detection threshold and detection probability measurements were made with the device operating in the 5500-5700 MHz band.						

<b>Table 4 FCC Part 15 Subpart E Master Device Test Result Summary – WU (Steady State Mode) Fh</b>						
Description	Radar Type	EUT Frequency	Measured Value	Requirement	Test Data	Status
Channel Availability Check (CAC) Time	Type 1	N/A – No start up in this mode				
In-Service Monitoring Detection Threshold	Type 1 Type 2 Type 3 Type 4 Type 5 Type 6	5563.2MHz	-62dBm (note 2)	-62dBm (See note 2)	Appendix B	Pass
Bandwidth Detection	Type 1	Varies	MHz	80% of the 99% BW	-	Pass
Channel closing transmission time	Type 1 Type 5	5563.2 MHz	0ms 0ms	≤ 260ms	Appendix C	Pass
Channel move time	Type 1 Type 5	5563.2 MHz	0.2s -8.5s	≤ 10s	Appendix C	Pass
Non-occupancy period	-	5563.2 MHz	>30 minutes	>30 minutes	Appendix C	Pass
Uniform Loading		-	-	Uniform Loading	Refer to operational description	-
<ol style="list-style-type: none"> <li>1) Tests were performed using the radiated test method.</li> <li>2) The measured detection threshold is based on testing the master device using the radiated test method when connected to an antenna with a nominal gain of 5.5dBi. The limit is based on an eirp of less than 23dBm.</li> <li>3) The in-service monitoring detection threshold and detection probability measurements were made with the device operating in the 5500-5700 MHz band.</li> </ol>						

**MEASUREMENT UNCERTAINTIES**

ISO/IEC 17025 requires that an estimate of the measurement uncertainties associated with the emissions test results be included in the report. The measurement uncertainties given below are based on a 95% confidence level, with a coverage factor (k=2) and were calculated in accordance with UKAS document LAB 34.

Measurement	Measurement Unit	Expanded Uncertainty
Timing (Channel move time, aggregate transmission time)	ms	Timing resolution $\pm 0.24\%$
Timing (non occupancy period)	seconds	5 seconds
DFS Threshold (radiated)	dBm	1.6
DFS Threshold (conducted)	dBm	1.2

**EQUIPMENT UNDER TEST (EUT) DETAILS****GENERAL**

The Nextivity Inc. model CELFI-RS225WU & CELFI-RS225CU Cel-Fi Residential System is a WCDMA Cellular Repeater for indoor residential use based on a split three-hop repeater concept designed to provide better indoor cellular coverage (Figure 1).

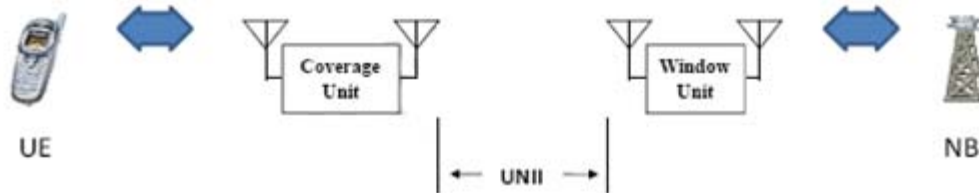

**Figure 1 Cel-Fi Three-Hop Repeater System**

Cel-Fi consists of two devices, the Window Unit (WU) and the Coverage Unit (CU). The Window Unit is placed in the area of a home with the strongest signal from a wireless carrier. The WU communicates with the cell tower. The Coverage Unit is placed in the center of the home, communicates wirelessly with the WU and "lights up" the interior of the home with significantly enhanced signal, thus enabling better quality calls and greater download speeds.

The WU is responsible for allocating the duplex channels for both the WU and CU. It performs the Channel Availability Check (CAC). To satisfy the uniform loading requirement, the WU scans all U-NII channels to perform a RSSI measurement prior to channel selection. The pair of selected channels are randomly chosen from among those whose RSSI value is below a specified threshold. Those channels whose nominal bandwidth occupies the 5600-5650 MHz band may be omitted from the list of usable channels during initial power up. Accordingly, the WU will omit channels occupying 5600-5650 MHz during initial channel selection.

The sample was received on March 26, 2012 and tested on March 26, 27, 2012. The EUT consisted of the following component(s):

Manufacturer	Model	Description	Serial Number
Nextivity Inc.	CELFY-RS225 WU	Window Unit	150201000108
Nextivity Inc.	CELFY-RS225 CU	Coverage Unit	151201000129
Nextivity Inc.	WRG20F-120AB-0A	AC/DC Adapter (x2)	N/A

Nextivity's declared values for the EUT operational characteristics that affect DFS are as follows:

**Operating Modes (5250 – 5350 MHz, 5470 – 5725 MHz) – CELFI-RS225WU**

- Master Device 5250-5350MHz – Note: The device acts as a Master in the 5250-5350MHz band only during CU Synchronization or Acquire mode.
- Master Device 5470-5725 MHz
- Master Device 5470-5725 MHz (excluding 5600-5650 MHz)

**Operating Modes (5250 – 5350 MHz) – CELFI-RS225CU**

- Master Device 5250-5350 MHz
- Master Device 5470-5725 MHz
- Master Device 5470-5725 MHz (excluding 5600-5650 MHz)

**Antenna Gains / EIRP (5250 – 5725 MHz) – CELFI-RS225WU**

	5250 – 5350 MHz	5470 – 5725 MHz
Lowest Antenna Gain (dBi)	5.5	5.5
Highest Antenna Gain (dBi)	5.5	5.5
EIRP Output Power (dBm)	22.1	Note

Note – The WU does not transmit in the 5470-5725 MHz band but does receive in this band.

DFS testing was performed with the EUT oriented in the direction of highest antenna gain.

**Antenna Gains / EIRP (5250 – 5350 MHz) – CELFI-RS225CU**

	5250 – 5350 MHz	5470 – 5725 MHz
Lowest Antenna Gain (dBi)	5.5	5.5
Highest Antenna Gain (dBi)	5.5	5.5
EIRP Output Power (dBm)	Note	26.1

Note – The CU does not transmit in the 5250-5350 MHz band but does receive in this band.

DFS testing was performed with the EUT oriented in the direction of highest antenna gain.

**Channel Protocol**

- IP Based
- Frame Based

**ENCLOSURE**

The EUT (WU) enclosure measures approximately 199mm H x 143mm W x 148mm D. It is primarily constructed of plastic.

The EUT (CU) enclosure measures approximately 157mm H x 145mm W x 58mm D. It is primarily constructed of plastic.

**MODIFICATIONS**

The EUT did not require modifications during testing in order to comply with the requirements of the standard(s) referenced in this test report.

**SUPPORT EQUIPMENT**

The following equipment was used as local support equipment for testing:

Manufacturer	Model	Description	Serial Number	FCC ID
Nokia	C6-01	Cell Phone on AT&T Network	353758042532560	PYARM-801
Dell	Latitude D630	Laptop	-	DoC
Nextivity Inc.	CELFI-RS225 WU	Window Unit	150201000108	-
Nextivity Inc.	CELFI-RS225 CU	Coverage Unit	151201000129	-

The WU and the CU are both Master devices during normal operation in their respective bands.

**EUT INTERFACE PORTS**

The I/O cabling configuration during testing was as follows:

Port	Connected To	Cable(s)		
		Description	Shielded or Unshielded	Length (m)
USB	Laptop USB	Multi-wire	Shielded	3
AC Adapter Power	AC Mains	-	-	-
DC Power	AC Adapter	Two wire	Unshielded	2



**EUT OPERATION**

The EUTs were operating with the software that are secured by encryption to prevent the user from disabling the DFS function.

Master Device:       Version 700N032-205-002  
Client Device:       Version 700N032-205-002

The manufacturer provided special software that over-rode the non-occupancy mechanism (allowing return to the same channel) for the purposes of determining the probability of detection. This test feature was disabled and the normal operating software enabled for verifying the 30-minute non-occupancy period and channel move time.

The start of the Channel Availability Check was 5 seconds after the command to change channel was sent.

During the tests the system was configured as described in the Nextivity DFS Implementation Proposal document for each of the modes tested.

In the CU Synchronization Mode, the WU traffic on the channel is set at 50% duty cycle in software. In Steady State mode, the traffic on the channel is continuous on FL for the WU and on FH for the CU. In Steady State mode, the WU is only receiving on FH and the CU is only receiving on FL. Refer to refer to Figure 3 in Appendix B.

**RADAR WAVEFORMS**

<b>Table 5 FCC Short Pulse Radar Test Waveforms</b>					
Radar Type	Pulse Width (μsec)	PRI (μsec)	Pulses / burst	Minimum Detection Percentage	Minimum Number of Trials
1	1	1428	18	60%	30
2	1-5	150-230	23-29	60%	30
3	6-10	200-500	16-18	60%	30
4	11-20	200-500	12-16	60%	30
Aggregate (Radar Types 1-4)				80%	120

<b>Table 6 FCC Long Pulse Radar Test Waveforms</b>							
Radar Type	Pulse Width (μsec)	Chirp Width (MHz)	PRI (μsec)	Pulses / burst	Number of Bursts	Minimum Detection Percentage	Minimum Number of Trials
5	50-100	5-20	1000-2000	1-3	8-20	80%	30

<b>Table 7 FCC Frequency Hopping Radar Test Waveforms</b>							
Radar Type	Pulse Width (μsec)	PRI (μsec)	Pulses / hop	Hopping Rate (kHz)	Hopping Sequence Length (msec)	Minimum Detection Percentage	Minimum Number of Trials
6	1	333	9	0.333	300	70%	30

**DFS TEST METHODS**

**RADIATED TEST METHOD**

The combination of master and slave devices is located in an anechoic chamber. The simulated radar waveform is transmitted from a directional horn antenna (typically an EMCO 3115) toward the unit performing the radar detection (radar detection device, RDD). Every effort is made to ensure that the main beam of the EUT's antenna is aligned with the radar-generating antenna.

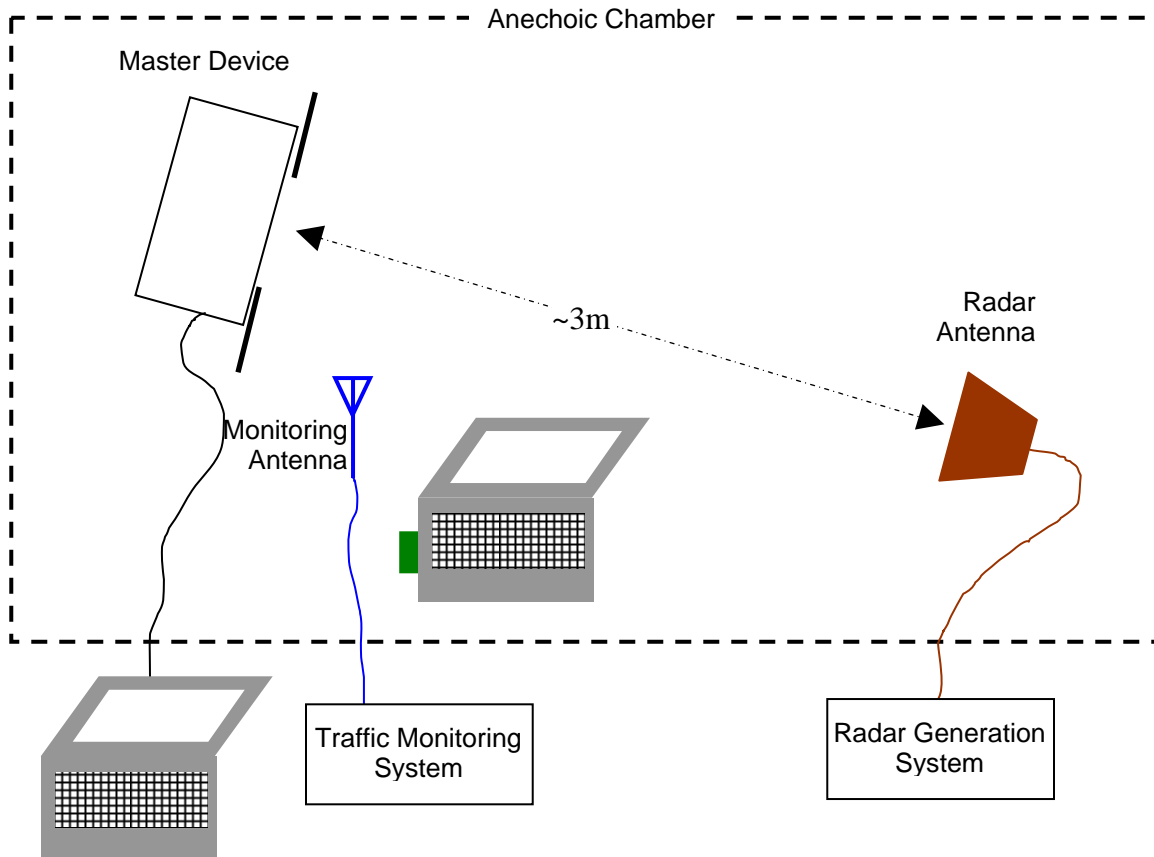

**Figure 2 Test Configuration for radiated Measurement Method**

The signal level of the simulated waveform is set to a reference level equal to the threshold level (plus 1dB if testing against FCC requirements). Lower levels may also be applied on request of the manufacturer. The level reported is the level at the RDD antenna and so it is not corrected for the RDD's antenna gain. The RDD is configured with the lowest gain antenna assembly intended for use with the device.

The signal level is verified by measuring the CW signal level from the radar generation system using a reference antenna of gain  $G_{REF}$  (dBi). The radar signal level is calculated from the measured level,  $R$  (dBm), and any cable loss,  $L$  (dB), between the reference antenna and the measuring instrument:

$$\text{Applied level (dBm)} = R - G_{REF} + L$$

If both master and client devices have radar detection capability then the device not under test is positioned with absorbing material between its antenna and the radar generating antenna, and the radar level at the non RDD is verified to be at least 20dB below the threshold level to ensure that any responses are due to the RDD detecting radar.

The antenna connected to the channel monitoring subsystem is positioned to allow both master and client transmissions to be observed, with the level of the EUT's transmissions between 6 and 10dB higher than those from the other device.

---

## **DFS MEASUREMENT INSTRUMENTATION**

### **RADAR GENERATION SYSTEM**

An Agilent PSG is used as the radar-generating source. The integral arbitrary waveform generators are programmed using Agilent's "Pulse Building" software and Elliott custom software to produce the required waveforms, with the capability to produce both unmodulated and modulated (FM Chirp) pulses. Where there are multiple values for a specific radar parameter then the software selects a value at random and, for FCC tests, the software verifies that the resulting waveform is truly unique.

With the exception of the hopping waveforms required by the FCC's rules (see below), the radar generator is set to a single frequency within the radar detection bandwidth of the EUT. The frequency is varied from trial to trial by stepping in 5MHz steps.

Frequency hopping radar waveforms are simulated using a time domain model. A randomly hopping sequence algorithm (which uses each channel in the hopping radar's range once in a hopping sequence) generates a hop sequence. A segment of the first 100 elements of the hop sequence are then examined to determine if it contains one or more frequencies within the radar detection bandwidth of the EUT. If it does not then the first element of the segment is discarded and the next frequency in the sequence is added. The process repeats until a valid segment is produced. The radar system is then programmed to produce bursts at time slots coincident with the frequencies within the segment that fall in the detection bandwidth. The frequency of the generator is stepped in 1 MHz increments across the EUT's detection range.

The radar signal level is verified during testing using a CW signal with the AGC function switched on. Correction factors to account for the fact that pulses are generated with the AGC functions switched off are measured annually and an offset is used to account for this in the software.

The generator output is connected to the coupling port of the conducted set-up or to the radar-generating antenna.

---

**CHANNEL MONITORING SYSTEM**

Channel monitoring is achieved using a spectrum analyzer and digital storage oscilloscope. The analyzer is configured in a zero-span mode, center frequency set to the radar waveform's frequency or the center frequency of the EUT's operating channel. The IF output of the analyzer is connected to one input of the oscilloscope.

A signal generator output is set to send either the modulating signal directly or a pulse gate with an output pulse co-incident with each radar pulse. This output is connected to a second input on the oscilloscope and the oscilloscope displays both the channel traffic (via the if input) and the radar pulses on its display.

For in service monitoring tests the analyzer sweep time is set to > 20 seconds and the oscilloscope is configured with a data record length of 10 seconds for the short duration and frequency hopping waveforms, 20 seconds for the long duration waveforms. Both instruments are set for a single acquisition sequence. The analyzer is triggered 500ms before the start of the waveform and the oscilloscope is triggered directly by the modulating pulse train. Timing measurements for aggregate channel transmission time and channel move time are made from the oscilloscope data, with the end of the waveform clearly identified by the pulse train on one trace. The analyzer trace data is used to confirm that the last transmission occurred within the 10-second record of the oscilloscope. If necessary the record length of the oscilloscope is expanded to capture the last transmission on the channel prior to the channel move.

Channel availability check time timing plots are made using the analyzer. The analyzer is triggered at start of the EUT's channel availability check and used to verify that the EUT does not transmit when radar is applied during the check time.

The analyzer detector and oscilloscope sampling mode is set to peak detect for all plots.

## ***DFS MEASUREMENT METHODS***

### ***DFS RADAR DETECTION BANDWIDTH***

The radar detection bandwidth is determined by using FCC radar waveform 1 and applying radar pulses at offsets from the center channel frequency by multiples of 1MHz. These bursts are applied with no traffic on the channel. The first frequencies above and below the center channel frequency that have a detection rate below 90% define the radar bandwidth, the actual range being 1MHz below the upper frequency and 1MHz above the lower frequency.

### ***DFS – CHANNEL CLOSING TRANSMISSION TIME AND CHANNEL MOVE TIME***

Channel clearing and closing times are measured by applying a burst of radar with the device configured to change channel and by observing the channel for transmissions. The time between the end of the applied radar waveform and the final transmission on the channel is the channel move time.

The aggregate transmission closing time is measured in one of two ways:

FCC/KCC Notice No. 2010-48 – the total time of all individual transmissions from the EUT that are observed starting 200ms at the end of the last radar pulse in the waveform. This value is required to be less than 60ms.

### ***DFS – CHANNEL NON-OCCUPANCY AND VERIFICATION OF PASSIVE SCANNING***

The channel that was in use prior to radar detection by the master is additionally monitored for 30 minutes to ensure no transmissions on the vacated channel over the required non-occupancy period. This is achieved by tuning the spectrum analyzer to the vacated channel in zero-span mode and connecting the IF output to an oscilloscope. The oscilloscope is triggered by the radar pulse and set to provide a single sweep (in peak detect mode) that lasts for at least 30 minutes after the end of the channel move time.

For devices with a client-mode that are being evaluated against FCC rules the manufacturer must supply an attestation letter stating that the client device does not employ any active scanning techniques (i.e. does not transmit in the DFS bands without authorization from a Master device).

***DFS CHANNEL AVAILABILITY CHECK TIME***

It is preferred that the EUT report when it starts the radar channel availability check. If the EUT does not report the start of the check time, then the time to start transmitting on a channel after switching the device on is measured to approximate the time from power-on to the end of the channel availability check. The start of the channel availability check is assumed to be 60 seconds prior to the first transmission on the channel.

To evaluate the channel availability check, a single burst of one radar type is applied within the first 2 seconds of the start of the channel availability check and it is verified that the device does not use the channel by continuing to monitor the channel for a period of at least 60 seconds. The test is repeated by applying a burst of radar in the last 2 seconds (i.e. between 58 and 60 seconds after the start of CAC when evaluating a 60-second CAC) of the channel availability check.

***UNIFORM LOADING***

Compliance with the FCC's channel loading requirement is demonstrated through the manufacturer's operational description for the device under test.

***TRANSMIT POWER CONTROL (TPC)***

Compliance with the transmit power control requirements for devices is demonstrated through measurements showing multiple power levels and manufacturer statements explaining how the power control is implemented.



## **SAMPLE CALCULATIONS**

### **DETECTION PROBABILITY / SUCCESS RATE**

The detection probability, or success rate, for any one radar waveform equals the number of successful trials divided by the total number of trials for that waveform.

In the case of the FCC requirements, for radar waveform types 1 through 4 an additional calculation is made to determine the average detection probability over all four radar waveform types. This calculation is the arithmetic mean of the four individual probabilities.

### **THRESHOLD LEVEL**

The threshold level is the level of the simulated radar waveform at the EUT's antenna. If the test is performed in a conducted fashion then the level at the rf input equals the level at the antenna plus the gain of the antenna assembly, in dBi. The gain of the antenna assembly equals the gain of the antenna minus the loss of the cabling between the rf input and the antenna. The lowest gain value for all antenna assemblies intended for use with the device is used when making this calculation.

If the test is performed using the radiated method then the threshold level is the level at the antenna.

**Appendix A Test Equipment Calibration Data**

<b><u>Manufacturer</u></b>	<b><u>Description</u></b>	<b><u>Model #</u></b>	<b><u>Asset #</u></b>	<b><u>Cal Due</u></b>
Hewlett Packard	EMC Spectrum Analyzer, 9 kHz - 6.5 GHz	8595EM	780	25-Jan-13
EMCO	Antenna, Horn, 1-18GHz	3115	868	08-Jun-12
EMCO	Antenna, Horn, 1-18 GHz	3117	1662	04-May-12
Agilent	PSG Vector Signal Generator (250kHz - 20GHz)	E8267C	1877	30-Mar-12
Tektronix	500MHz, 2CH, 5GS/s Scope	TDS5052B	2118	07-Oct-12

**Appendix B Test Data Tables for Radar Detection Probability**

The plot below shows the channel loading during testing as evaluated over a 1 second period. The traffic was generated by an active cell phone call with random voice traffic per Nextivity DFS Implementation Proposal for Cel-Fi U-NII Link.

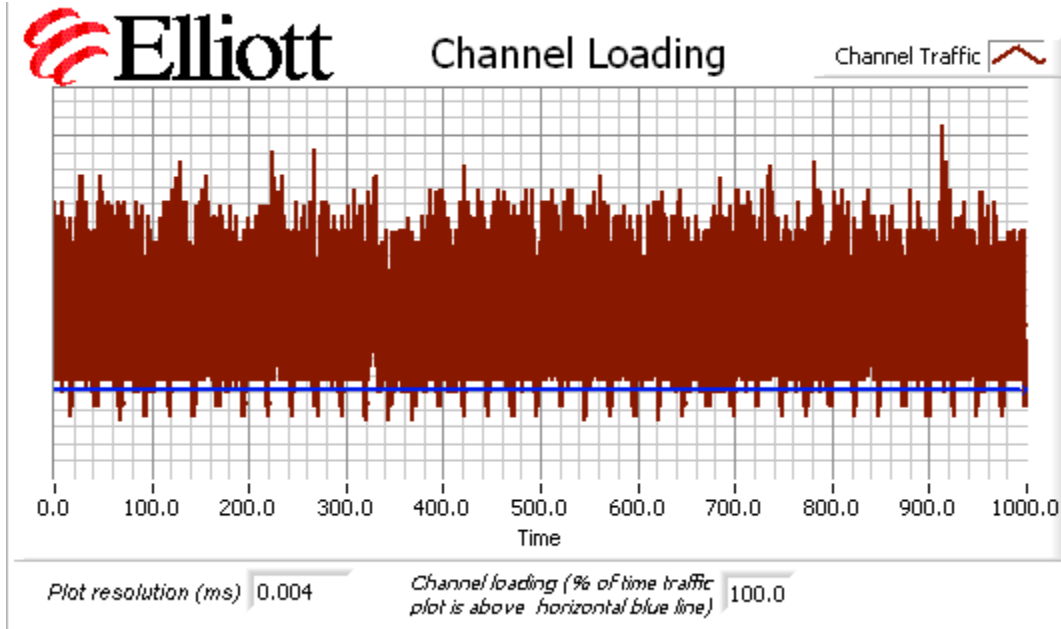

**Figure 3 Channel Utilization During In-Service Detection Measurements**

**Table 8 – CU - Detection Bandwidth Measurements (Bandwidth: +11MHz /-11MHz)**

EUT Frequency	Radar Type	Radar Frequency	# Detected	# Not Detected	Success (%)
5284.80 MHz	FCC Short Pulse Radar (Type 1)	5272.80 MHz	5	3	62
5284.80 MHz	FCC Short Pulse Radar (Type 1)	5273.80 MHz	10	0	100
5284.80 MHz	FCC Short Pulse Radar (Type 1)	5274.80 MHz	10	0	100
5284.80 MHz	FCC Short Pulse Radar (Type 1)	5275.80 MHz	10	0	100
5284.80 MHz	FCC Short Pulse Radar (Type 1)	5276.80 MHz	10	0	100
5284.80 MHz	FCC Short Pulse Radar (Type 1)	5277.80 MHz	10	0	100
5284.80 MHz	FCC Short Pulse Radar (Type 1)	5278.80 MHz	10	0	100
5284.80 MHz	FCC Short Pulse Radar (Type 1)	5279.80 MHz	10	0	100
5284.80 MHz	FCC Short Pulse Radar (Type 1)	5280.80 MHz	10	0	100
5284.80 MHz	FCC Short Pulse Radar (Type 1)	5281.80 MHz	10	0	100
5284.80 MHz	FCC Short Pulse Radar (Type 1)	5282.80 MHz	10	0	100
5284.80 MHz	FCC Short Pulse Radar (Type 1)	5283.80 MHz	10	0	100
5284.80 MHz	FCC Short Pulse Radar (Type 1)	5284.80 MHz	10	0	100
5284.80 MHz	FCC Short Pulse Radar (Type 1)	5285.80 MHz	10	0	100
5284.80 MHz	FCC Short Pulse Radar (Type 1)	5286.80 MHz	10	0	100
5284.80 MHz	FCC Short Pulse Radar (Type 1)	5287.80 MHz	10	0	100
5284.80 MHz	FCC Short Pulse Radar (Type 1)	5288.80 MHz	10	0	100
5284.80 MHz	FCC Short Pulse Radar (Type 1)	5289.80 MHz	10	0	100
5284.80 MHz	FCC Short Pulse Radar (Type 1)	5290.80 MHz	10	0	100
5284.80 MHz	FCC Short Pulse Radar (Type 1)	5291.80 MHz	10	0	100
5284.80 MHz	FCC Short Pulse Radar (Type 1)	5292.80 MHz	10	0	100
5284.80 MHz	FCC Short Pulse Radar (Type 1)	5293.80 MHz	10	0	100
5284.80 MHz	FCC Short Pulse Radar (Type 1)	5294.80 MHz	10	0	100
5284.80 MHz	FCC Short Pulse Radar (Type 1)	5295.80 MHz	10	0	100
5284.80 MHz	FCC Short Pulse Radar (Type 1)	5296.80 MHz	1	3	25

CU Steady State – In Service Monitoring (Client with Detection, WU is master)

**Table 9 - Summary of All Results - CU Steady State**

Waveform Name	Pd (%)	Pd Required (%)	Number of Trials	Status
FCC Short Pulse Radar (Type 1)	100.0 %	60.0 %	30	PASSED
FCC Short Pulse Radar (Type 2)	100.0 %	60.0 %	30	PASSED
FCC Short Pulse Radar (Type 3)	100.0 %	60.0 %	30	PASSED
FCC Short Pulse Radar (Type 4)	100.0 %	60.0 %	30	PASSED
Aggregate of above results	100.0 %	80.0 %	120	PASSED
Long Sequence	100.0 %	80.0 %	30	PASSED
FCC frequency hopping radar (Type 6)	100.0 %	70.0 %	46	PASSED

**Table 10 - FCC Short Pulse Radar (Type 1) Results CU Steady State**

Trial #	Pulses/ Burst	Pulse Width (us)	PRI (us)	Detected	Fr (MHz) and level (dBm)	Burst Information
1	18	1.0	1428.0	Yes	5284.8MHz, -62.0dBm	Single burst
2	18	1.0	1428.0	Yes	5279.8MHz, -62.0dBm	Single burst
3	18	1.0	1428.0	Yes	5289.8MHz, -62.0dBm	Single burst
4	18	1.0	1428.0	Yes	5284.8MHz, -62.0dBm	Single burst
5	18	1.0	1428.0	Yes	5279.8MHz, -62.0dBm	Single burst
6	18	1.0	1428.0	Yes	5289.8MHz, -62.0dBm	Single burst
7	18	1.0	1428.0	Yes	5284.8MHz, -62.0dBm	Single burst
8	18	1.0	1428.0	Yes	5279.8MHz, -62.0dBm	Single burst
9	18	1.0	1428.0	Yes	5289.8MHz, -62.0dBm	Single burst
10	18	1.0	1428.0	Yes	5284.8MHz, -62.0dBm	Single burst
11	18	1.0	1428.0	Yes	5279.8MHz, -62.0dBm	Single burst
12	18	1.0	1428.0	Yes	5289.8MHz, -62.0dBm	Single burst
13	18	1.0	1428.0	Yes	5284.8MHz, -62.0dBm	Single burst
14	18	1.0	1428.0	Yes	5279.8MHz, -62.0dBm	Single burst
15	18	1.0	1428.0	Yes	5289.8MHz, -62.0dBm	Single burst
16	18	1.0	1428.0	Yes	5284.8MHz, -62.0dBm	Single burst
17	18	1.0	1428.0	Yes	5279.8MHz, -62.0dBm	Single burst
18	18	1.0	1428.0	Yes	5289.8MHz, -62.0dBm	Single burst
19	18	1.0	1428.0	Yes	5284.8MHz, -62.0dBm	Single burst
20	18	1.0	1428.0	Yes	5279.8MHz, -62.0dBm	Single burst
21	18	1.0	1428.0	Yes	5289.8MHz, -62.0dBm	Single burst
22	18	1.0	1428.0	Yes	5284.8MHz, -62.0dBm	Single burst
23	18	1.0	1428.0	Yes	5279.8MHz, -62.0dBm	Single burst
24	18	1.0	1428.0	Yes	5289.8MHz, -62.0dBm	Single burst
25	18	1.0	1428.0	Yes	5284.8MHz, -62.0dBm	Single burst
26	18	1.0	1428.0	Yes	5279.8MHz, -62.0dBm	Single burst
27	18	1.0	1428.0	Yes	5289.8MHz, -62.0dBm	Single burst
28	18	1.0	1428.0	Yes	5284.8MHz, -62.0dBm	Single burst
29	18	1.0	1428.0	Yes	5279.8MHz, -62.0dBm	Single burst
30	18	1.0	1428.0	Yes	5289.8MHz, -62.0dBm	Single burst

**Table 11 - FCC Short Pulse Radar (Type 2) Results CU Steady State**

Trial #	Pulses/ Burst	Pulse Width (us)	PRI (us)	Detected	Fr (MHz) and level (dBm)	Burst Information
1	27	3.1	162.0	Yes	5284.8MHz, -62.0dBm	Single burst
2	24	2.6	193.0	Yes	5279.8MHz, -62.0dBm	Single burst
3	28	1.2	208.0	Yes	5289.8MHz, -62.0dBm	Single burst
4	25	1.2	176.0	Yes	5284.8MHz, -62.0dBm	Single burst
5	25	2.2	155.0	Yes	5279.8MHz, -62.0dBm	Single burst
6	24	2.1	225.0	Yes	5289.8MHz, -62.0dBm	Single burst
7	26	2.2	169.0	Yes	5284.8MHz, -62.0dBm	Single burst
8	27	3.0	210.0	Yes	5279.8MHz, -62.0dBm	Single burst
9	26	1.7	226.0	Yes	5289.8MHz, -62.0dBm	Single burst
10	26	2.4	174.0	Yes	5284.8MHz, -62.0dBm	Single burst
11	26	3.3	200.0	Yes	5279.8MHz, -62.0dBm	Single burst
12	28	3.5	227.0	Yes	5289.8MHz, -62.0dBm	Single burst
13	24	2.1	173.0	Yes	5284.8MHz, -62.0dBm	Single burst
14	27	4.2	154.0	Yes	5279.8MHz, -62.0dBm	Single burst
15	29	1.0	166.0	Yes	5289.8MHz, -62.0dBm	Single burst
16	25	1.5	205.0	Yes	5284.8MHz, -62.0dBm	Single burst
17	23	2.9	191.0	Yes	5279.8MHz, -62.0dBm	Single burst
18	23	1.9	185.0	Yes	5289.8MHz, -62.0dBm	Single burst
19	24	3.0	199.0	Yes	5284.8MHz, -62.0dBm	Single burst
20	24	4.7	150.0	Yes	5279.8MHz, -62.0dBm	Single burst
21	26	4.3	180.0	Yes	5289.8MHz, -62.0dBm	Single burst
22	26	2.8	194.0	Yes	5284.8MHz, -62.0dBm	Single burst
23	27	1.2	207.0	Yes	5279.8MHz, -62.0dBm	Single burst
24	27	4.3	177.0	Yes	5289.8MHz, -62.0dBm	Single burst
25	28	2.6	165.0	Yes	5284.8MHz, -62.0dBm	Single burst
26	24	1.6	170.0	Yes	5279.8MHz, -62.0dBm	Single burst
27	24	3.1	176.0	Yes	5289.8MHz, -62.0dBm	Single burst
28	25	4.6	203.0	Yes	5284.8MHz, -62.0dBm	Single burst
29	24	2.3	187.0	Yes	5279.8MHz, -62.0dBm	Single burst
30	26	4.1	175.0	Yes	5289.8MHz, -62.0dBm	Single burst

**Table 12 - FCC Short Pulse Radar (Type 3) Results CU Steady State**

Trial #	Pulses/ Burst	Pulse Width (us)	PRI (us)	Detected	Fr (MHz) and level (dBm)	Burst Information
1	18	6.9	293.0	Yes	5284.8MHz, -62.0dBm	Single burst
2	17	6.4	326.0	Yes	5279.8MHz, -62.0dBm	Single burst
3	17	9.1	299.0	Yes	5289.8MHz, -62.0dBm	Single burst
4	17	9.0	390.0	Yes	5284.8MHz, -62.0dBm	Single burst
5	16	8.4	419.0	Yes	5279.8MHz, -62.0dBm	Single burst
6	16	6.4	446.0	Yes	5289.8MHz, -62.0dBm	Single burst
7	18	7.5	452.0	Yes	5284.8MHz, -62.0dBm	Single burst
8	18	8.4	489.0	Yes	5279.8MHz, -62.0dBm	Single burst
9	16	6.2	429.0	Yes	5289.8MHz, -62.0dBm	Single burst
10	17	9.0	368.0	Yes	5284.8MHz, -62.0dBm	Single burst
11	17	7.1	342.0	Yes	5279.8MHz, -62.0dBm	Single burst
12	17	7.7	414.0	Yes	5289.8MHz, -62.0dBm	Single burst
13	17	6.8	438.0	Yes	5284.8MHz, -62.0dBm	Single burst
14	17	9.0	359.0	Yes	5279.8MHz, -62.0dBm	Single burst
15	18	7.0	280.0	Yes	5289.8MHz, -62.0dBm	Single burst
16	16	8.8	226.0	Yes	5284.8MHz, -62.0dBm	Single burst
17	16	7.0	270.0	Yes	5279.8MHz, -62.0dBm	Single burst
18	16	8.3	383.0	Yes	5289.8MHz, -62.0dBm	Single burst
19	17	7.5	439.0	Yes	5284.8MHz, -62.0dBm	Single burst
20	17	6.2	220.0	Yes	5279.8MHz, -62.0dBm	Single burst
21	17	8.5	213.0	Yes	5289.8MHz, -62.0dBm	Single burst
22	16	7.1	448.0	Yes	5284.8MHz, -62.0dBm	Single burst
23	17	6.2	408.0	Yes	5279.8MHz, -62.0dBm	Single burst
24	18	7.5	479.0	Yes	5289.8MHz, -62.0dBm	Single burst
25	17	9.9	228.0	Yes	5284.8MHz, -62.0dBm	Single burst
26	17	8.9	228.0	Yes	5279.8MHz, -62.0dBm	Single burst
27	16	9.3	254.0	Yes	5289.8MHz, -62.0dBm	Single burst
28	17	6.0	356.0	Yes	5284.8MHz, -62.0dBm	Single burst
29	17	7.7	210.0	Yes	5279.8MHz, -62.0dBm	Single burst
30	17	6.5	254.0	Yes	5289.8MHz, -62.0dBm	Single burst

**Table 13 - FCC Short Pulse Radar (Type 4) Results CU Steady State**

Trial #	Pulses/ Burst	Pulse Width (us)	PRI (us)	Detected	Fr (MHz) and level (dBm)	Burst Information
1	13	11.9	316.0	Yes	5284.8MHz, -62.0dBm	Single burst
2	15	11.3	381.0	Yes	5279.8MHz, -62.0dBm	Single burst
3	13	17.9	269.0	Yes	5289.8MHz, -62.0dBm	Single burst
4	15	13.4	285.0	Yes	5284.8MHz, -62.0dBm	Single burst
5	13	17.0	356.0	Yes	5279.8MHz, -62.0dBm	Single burst
6	14	18.5	249.0	Yes	5289.8MHz, -62.0dBm	Single burst
7	14	16.2	484.0	Yes	5284.8MHz, -62.0dBm	Single burst
8	12	15.9	232.0	Yes	5279.8MHz, -62.0dBm	Single burst
9	12	12.0	323.0	Yes	5289.8MHz, -62.0dBm	Single burst
10	14	16.0	212.0	Yes	5284.8MHz, -62.0dBm	Single burst
11	15	19.2	337.0	Yes	5279.8MHz, -62.0dBm	Single burst
12	14	11.5	249.0	Yes	5289.8MHz, -62.0dBm	Single burst
13	12	13.1	246.0	Yes	5284.8MHz, -62.0dBm	Single burst
14	15	17.4	395.0	Yes	5279.8MHz, -62.0dBm	Single burst
15	13	14.7	354.0	Yes	5289.8MHz, -62.0dBm	Single burst
16	15	18.9	400.0	Yes	5284.8MHz, -62.0dBm	Single burst
17	13	11.5	494.0	Yes	5279.8MHz, -62.0dBm	Single burst
18	14	16.1	333.0	Yes	5289.8MHz, -62.0dBm	Single burst
19	15	14.4	279.0	Yes	5284.8MHz, -62.0dBm	Single burst
20	15	18.1	366.0	Yes	5279.8MHz, -62.0dBm	Single burst
21	13	11.6	302.0	Yes	5289.8MHz, -62.0dBm	Single burst
22	15	18.2	226.0	Yes	5284.8MHz, -62.0dBm	Single burst
23	14	19.8	320.0	Yes	5279.8MHz, -62.0dBm	Single burst
24	15	17.6	385.0	Yes	5289.8MHz, -62.0dBm	Single burst
25	15	12.4	216.0	Yes	5284.8MHz, -62.0dBm	Single burst
26	13	16.0	404.0	Yes	5279.8MHz, -62.0dBm	Single burst
27	13	15.2	409.0	Yes	5289.8MHz, -62.0dBm	Single burst
28	15	18.4	226.0	Yes	5284.8MHz, -62.0dBm	Single burst
29	14	14.1	269.0	Yes	5279.8MHz, -62.0dBm	Single burst
30	13	16.5	336.0	Yes	5289.8MHz, -62.0dBm	Single burst



**Table 14 - Long Sequence Waveform Summary CU Steady State**

Long Sequence Trial	Result	Radar Frequency / Amplitude
Trial #1	Detected	5284.8MHz, -62.0dBm
Trial #2	Detected	5279.8MHz, -62.0dBm
Trial #3	Detected	5289.8MHz, -62.0dBm
Trial #4	Detected	5284.8MHz, -62.0dBm
Trial #5	Detected	5279.8MHz, -62.0dBm
Trial #6	Detected	5289.8MHz, -62.0dBm
Trial #7	Detected	5284.8MHz, -62.0dBm
Trial #8	Detected	5279.8MHz, -62.0dBm
Trial #9	Detected	5289.8MHz, -62.0dBm
Trial #10	Detected	5284.8MHz, -62.0dBm
Trial #11	Detected	5279.8MHz, -62.0dBm
Trial #12	Detected	5289.8MHz, -62.0dBm
Trial #13	Detected	5284.8MHz, -62.0dBm
Trial #14	Detected	5279.8MHz, -62.0dBm
Trial #15	Detected	5289.8MHz, -62.0dBm
Trial #16	Detected	5284.8MHz, -62.0dBm
Trial #17	Detected	5279.8MHz, -62.0dBm
Trial #18	Detected	5289.8MHz, -62.0dBm
Trial #19	Detected	5284.8MHz, -62.0dBm
Trial #20	Detected	5279.8MHz, -62.0dBm
Trial #21	Detected	5289.8MHz, -62.0dBm
Trial #22	Detected	5284.8MHz, -62.0dBm
Trial #23	Detected	5279.8MHz, -62.0dBm
Trial #24	Detected	5289.8MHz, -62.0dBm
Trial #25	Detected	5284.8MHz, -62.0dBm
Trial #26	Detected	5279.8MHz, -62.0dBm
Trial #27	Detected	5289.8MHz, -62.0dBm
Trial #28	Detected	5284.8MHz, -62.0dBm
Trial #29	Detected	5279.8MHz, -62.0dBm
Trial #30	Detected	5289.8MHz, -62.0dBm

**Table 15 - CU Steady State Long Sequence Waveform Trial#1 (Detected)**

Burst #	# Pulses	Pulse Width (us)	Chirp (MHz)	Interval 1 to 2 (us)	Interval 2 to 3 (us)	Start time (us)
1	3	91.2	8	1493.0	1016.0	0.704579
2	2	97.9	7	1164.0	-	1.331662
3	2	99.0	5	1256.0	-	1.837582
4	1	64.2	12	-	-	2.823170
5	3	76.7	6	1320.0	1670.0	3.446995
6	3	78.2	15	1456.0	1132.0	4.249065
7	3	63.6	20	1105.0	1588.0	5.152066
8	1	69.8	16	-	-	5.364295
9	3	83.9	7	1811.0	1590.0	6.415963
10	2	66.5	8	1035.0	-	7.419541
11	1	86.1	7	-	-	8.084690
12	2	59.8	5	1200.0	-	8.901681
13	2	58.1	10	1470.0	-	9.119276
14	2	95.4	5	1621.0	-	9.905561
15	3	55.8	10	1624.0	1608.0	10.809803
16	1	98.1	10	-	-	11.820855

**Table 16 - CU Steady State Long Sequence Waveform Trial#2 (Detected)**

Burst #	# Pulses	Pulse Width (us)	Chirp (MHz)	Interval 1 to 2 (us)	Interval 2 to 3 (us)	Start time (us)
1	1	94.1	14	-	-	1.317351
2	1	57.4	9	-	-	1.548016
3	2	96.1	10	1497.0	-	4.395465
4	2	79.5	15	1042.0	-	4.546027
5	1	58.0	14	-	-	6.894147
6	3	60.7	9	1014.0	1971.0	8.936278
7	2	74.3	16	1604.0	-	10.002834
8	2	54.3	9	1001.0	-	11.193297

**Table 17 - CU Steady State Long Sequence Waveform Trial#3 (Detected)**

Burst #	# Pulses	Pulse Width (us)	Chirp (MHz)	Interval 1 to 2 (us)	Interval 2 to 3 (us)	Start time (us)
1	1	82.0	13	-	-	0.601149
2	1	67.4	19	-	-	1.394636
3	1	71.3	8	-	-	1.843957
4	3	94.4	20	1979.0	1126.0	2.403072
5	2	89.1	7	1853.0	-	3.279363
6	1	69.5	15	-	-	4.532613
7	3	86.9	14	1193.0	1891.0	4.890275
8	1	59.4	6	-	-	6.370229
9	2	85.5	18	1585.0	-	6.681437
10	3	50.3	7	1860.0	1269.0	7.756324
11	1	87.3	19	-	-	8.710684
12	2	69.6	8	1622.0	-	9.260518
13	2	95.5	7	1445.0	-	9.904347
14	2	53.7	9	1181.0	-	10.477584
15	3	76.3	19	1411.0	1318.0	11.641710

**Table 18 - CU Steady State Long Sequence Waveform Trial#4 (Detected)**

Burst #	# Pulses	Pulse Width (us)	Chirp (MHz)	Interval 1 to 2 (us)	Interval 2 to 3 (us)	Start time (us)
1	2	51.9	13	1838.0	-	0.158358
2	2	54.3	6	1730.0	-	1.762429
3	2	80.1	10	1720.0	-	2.751144
4	2	56.7	6	1700.0	-	2.976880
5	2	69.8	13	1784.0	-	4.081216
6	2	77.9	17	1998.0	-	5.077656
7	2	57.4	6	1117.0	-	5.816011
8	2	98.1	17	1961.0	-	6.475086
9	3	60.6	12	1424.0	1855.0	8.111358
10	2	59.6	15	1733.0	-	8.955497
11	2	58.5	10	1721.0	-	9.799842
12	1	89.1	19	-	-	10.863523
13	2	56.9	15	1750.0	-	11.333599

**Table 19 - CU Steady State Long Sequence Waveform Trial#5 (Detected)**

Burst #	# Pulses	Pulse Width (us)	Chirp (MHz)	Interval 1 to 2 (us)	Interval 2 to 3 (us)	Start time (us)
1	2	50.5	15	1674.0	-	0.198643
2	1	86.0	20	-	-	1.044356
3	2	73.3	20	1555.0	-	1.703251
4	3	74.4	17	1772.0	1941.0	1.932404
5	2	93.3	10	1796.0	-	2.973455
6	2	60.3	10	1612.0	-	3.177723
7	3	78.9	13	1305.0	1097.0	4.381374
8	3	72.3	5	1892.0	1357.0	4.884965
9	2	75.2	7	1433.0	-	5.245022
10	2	79.1	18	1906.0	-	5.775013
11	2	62.7	13	1686.0	-	6.604814
12	3	61.0	6	1355.0	1297.0	7.515013
13	3	91.2	15	1273.0	1368.0	7.864424
14	3	81.1	11	1737.0	1387.0	8.530601
15	3	92.8	16	1721.0	1980.0	9.250112
16	1	90.2	14	-	-	10.076049
17	3	79.4	17	1302.0	1633.0	10.670137
18	3	86.9	15	1887.0	1476.0	10.992287
19	2	50.4	10	1556.0	-	11.767081

**Table 20 - CU Steady State Long Sequence Waveform Trial#6 (Detected)**

Burst #	# Pulses	Pulse Width (us)	Chirp (MHz)	Interval 1 to 2 (us)	Interval 2 to 3 (us)	Start time (us)
1	2	98.6	16	1507.0	-	0.579545
2	3	73.8	17	1706.0	1489.0	1.223970
3	2	90.2	16	1139.0	-	1.729539
4	3	76.1	8	1699.0	1037.0	2.866502
5	2	50.2	5	1835.0	-	4.122379
6	2	72.8	19	1295.0	-	4.846444
7	3	78.3	14	1261.0	1243.0	5.825458
8	2	52.4	13	1667.0	-	6.232185
9	1	89.3	13	-	-	6.883268
10	2	77.9	7	1519.0	-	7.782629
11	2	79.0	14	1974.0	-	9.324838
12	1	64.3	8	-	-	9.702044
13	2	68.0	19	1664.0	-	10.976816
14	3	60.1	18	1826.0	1596.0	11.971622

**Table 21 - CU Steady State Long Sequence Waveform Trial#7 (Detected)**

Burst #	# Pulses	Pulse Width (us)	Chirp (MHz)	Interval 1 to 2 (us)	Interval 2 to 3 (us)	Start time (us)
1	1	56.2	15	-	-	0.023551
2	3	91.2	9	1146.0	1016.0	1.050341
3	2	72.4	10	1530.0	-	2.163121
4	2	93.1	10	1238.0	-	2.296151
5	1	66.9	12	-	-	3.441898
6	2	72.2	6	1359.0	-	4.120959
7	2	57.4	13	1086.0	-	5.126173
8	2	54.4	14	1090.0	-	5.880957
9	3	71.6	17	1353.0	1388.0	6.472181
10	3	82.4	9	1055.0	1515.0	7.387379
11	1	67.0	12	-	-	8.136526
12	2	64.3	15	1349.0	-	8.532490
13	2	94.7	16	1049.0	-	9.292861
14	1	72.9	7	-	-	10.046342
15	1	52.2	8	-	-	10.888703
16	1	94.2	13	-	-	11.852365

**Table 22 - CU Steady State Long Sequence Waveform Trial#8 (Detected)**

Burst #	# Pulses	Pulse Width (us)	Chirp (MHz)	Interval 1 to 2 (us)	Interval 2 to 3 (us)	Start time (us)
1	1	66.9	10	-	-	0.017854
2	2	95.1	17	1992.0	-	0.963294
3	2	58.7	18	1786.0	-	1.424131
4	2	90.0	19	1284.0	-	2.106969
5	2	74.6	20	1026.0	-	2.698760
6	3	56.2	15	1995.0	1893.0	3.478349
7	2	97.7	19	1201.0	-	4.512074
8	1	77.1	19	-	-	5.018963
9	3	71.2	17	1838.0	1855.0	5.681855
10	3	56.2	11	1440.0	1609.0	6.305567
11	2	65.4	20	1115.0	-	7.082886
12	2	61.0	8	1998.0	-	7.366369
13	2	66.0	19	1543.0	-	8.299977
14	2	90.9	10	1289.0	-	9.178503
15	1	96.6	19	-	-	9.555258
16	3	92.8	8	1306.0	1379.0	10.454148
17	3	75.7	14	1385.0	1763.0	10.747603
18	2	71.2	7	1796.0	-	11.833040

**Table 23 - CU Steady State Long Sequence Waveform Trial#9 (Detected)**

Burst #	# Pulses	Pulse Width (us)	Chirp (MHz)	Interval 1 to 2 (us)	Interval 2 to 3 (us)	Start time (us)
1	3	81.1	11	1033.0	1786.0	0.529419
2	2	65.9	15	1944.0	-	1.290055
3	3	93.9	17	1468.0	1832.0	2.591504
4	2	74.2	10	1277.0	-	3.738402
5	3	66.9	7	1652.0	1500.0	4.355917
6	2	52.3	16	1635.0	-	5.499936
7	1	53.0	5	-	-	6.691981
8	3	82.5	7	1369.0	1515.0	7.416412
9	3	56.5	6	1867.0	1402.0	8.521452
10	2	65.2	19	1887.0	-	9.834407
11	2	51.0	11	1922.0	-	10.702585
12	3	98.2	12	1183.0	1122.0	11.054457

**Table 24 - CU Steady State Long Sequence Waveform Trial#10 (Detected)**

Burst #	# Pulses	Pulse Width (us)	Chirp (MHz)	Interval 1 to 2 (us)	Interval 2 to 3 (us)	Start time (us)
1	2	64.3	15	1349.0	-	0.226764
2	1	51.1	17	-	-	1.560839
3	2	97.7	11	1363.0	-	2.137821
4	2	58.3	14	1642.0	-	3.139936
5	3	75.0	10	1973.0	1231.0	3.683376
6	1	81.7	8	-	-	4.710463
7	2	91.3	12	1590.0	-	5.649855
8	2	56.2	6	1534.0	-	6.076101
9	1	74.2	6	-	-	7.705165
10	2	61.3	7	1982.0	-	7.753427
11	2	61.9	19	1517.0	-	8.665950
12	1	67.5	18	-	-	9.754742
13	2	52.6	19	1830.0	-	10.845554
14	2	78.9	14	1995.0	-	11.634769

**Table 25 - CU Steady State Long Sequence Waveform Trial#11 (Detected)**

Burst #	# Pulses	Pulse Width (us)	Chirp (MHz)	Interval 1 to 2 (us)	Interval 2 to 3 (us)	Start time (us)
1	2	78.7	15	1372.0	-	0.596265
2	3	82.1	7	1241.0	1852.0	1.112958
3	3	53.7	9	1797.0	1171.0	1.549312
4	3	53.6	7	1867.0	1187.0	2.671923
5	1	56.9	17	-	-	3.505330
6	2	69.2	6	1807.0	-	4.005198
7	2	81.6	19	1808.0	-	5.025543
8	1	57.1	9	-	-	5.490194
9	1	87.0	17	-	-	6.310989
10	1	85.9	17	-	-	7.083402
11	2	86.9	19	1595.0	-	7.878862
12	2	96.7	10	1556.0	-	8.783583
13	2	84.3	11	1641.0	-	9.223445
14	2	96.4	9	1756.0	-	9.846803
15	1	80.1	13	-	-	11.216003
16	3	62.2	18	1125.0	1050.0	11.851458

**Table 26 - CU Steady State Long Sequence Waveform Trial#12 (Detected)**

Burst #	# Pulses	Pulse Width (us)	Chirp (MHz)	Interval 1 to 2 (us)	Interval 2 to 3 (us)	Start time (us)
1	1	90.7	18	-	-	0.389934
2	2	80.7	6	1309.0	-	1.703005
3	2	65.5	7	1670.0	-	2.675905
4	3	88.8	15	1476.0	1159.0	3.947239
5	1	86.1	16	-	-	4.325370
6	3	74.4	16	1405.0	1019.0	5.945743
7	2	72.6	16	1681.0	-	6.988813
8	3	87.4	10	1928.0	1478.0	7.299851
9	2	81.3	12	1106.0	-	8.924936
10	1	55.9	14	-	-	9.827999
11	3	84.2	15	1956.0	1196.0	10.534055
12	2	96.2	16	1555.0	-	11.625661

**Table 27 - CU Steady State Long Sequence Waveform Trial#13 (Detected)**

Burst #	# Pulses	Pulse Width (us)	Chirp (MHz)	Interval 1 to 2 (us)	Interval 2 to 3 (us)	Start time (us)
1	3	67.6	11	1424.0	1924.0	0.265737
2	1	69.9	16	-	-	1.108356
3	1	69.9	8	-	-	1.439950
4	3	61.5	17	1017.0	1711.0	2.268094
5	2	79.4	13	1224.0	-	3.081659
6	1	98.1	10	-	-	3.654902
7	3	75.0	14	1415.0	1135.0	4.565908
8	2	81.0	6	1584.0	-	4.968041
9	2	94.7	10	1999.0	-	6.261877
10	2	76.4	15	1115.0	-	6.831853
11	2	54.2	13	1943.0	-	7.574613
12	2	54.9	9	1506.0	-	8.108869
13	3	78.7	18	1878.0	1228.0	9.044276
14	2	75.7	18	1234.0	-	9.758792
15	3	82.9	7	1774.0	1418.0	10.494734
16	1	57.1	19	-	-	11.164201
17	3	83.1	8	1251.0	1246.0	11.882007

**Table 28 - CU Steady State Long Sequence Waveform Trial#14 (Detected)**

Burst #	# Pulses	Pulse Width (us)	Chirp (MHz)	Interval 1 to 2 (us)	Interval 2 to 3 (us)	Start time (us)
1	3	91.7	12	1472.0	1746.0	1.281156
2	1	67.4	8	-	-	2.446016
3	2	74.9	8	1517.0	-	3.505577
4	2	50.9	6	1221.0	-	5.201699
5	3	59.3	12	1089.0	1187.0	5.853383
6	3	57.8	9	1624.0	1142.0	7.686754
7	1	78.5	8	-	-	8.174993
8	1	88.1	12	-	-	10.063640
9	1	74.6	13	-	-	10.814507

**Table 29 - CU Steady State Long Sequence Waveform Trial#15 (Detected)**

Burst #	# Pulses	Pulse Width (us)	Chirp (MHz)	Interval 1 to 2 (us)	Interval 2 to 3 (us)	Start time (us)
1	2	79.2	18	1688.0	-	0.423324
2	1	77.3	16	-	-	0.858486
3	2	83.4	7	1635.0	-	1.505895
4	1	53.5	17	-	-	2.057597
5	1	52.6	6	-	-	3.067162
6	3	52.4	8	1395.0	1348.0	3.190466
7	2	99.4	20	1152.0	-	4.024029
8	1	69.1	15	-	-	4.969065
9	3	54.5	10	1908.0	1591.0	5.073017
10	3	65.4	7	1985.0	1627.0	5.981537
11	3	65.7	13	1871.0	1444.0	6.926493
12	2	70.8	9	1754.0	-	7.529391
13	2	60.9	11	1491.0	-	7.952530
14	1	93.4	9	-	-	8.446327
15	2	53.9	11	1836.0	-	8.954874
16	1	90.8	18	-	-	9.477017
17	3	68.1	16	1746.0	1316.0	10.365392
18	3	94.8	17	1363.0	1142.0	11.292837
19	2	53.5	15	1506.0	-	11.813864

**Table 30 - CU Steady State Long Sequence Waveform Trial#16 (Detected)**

Burst #	# Pulses	Pulse Width (us)	Chirp (MHz)	Interval 1 to 2 (us)	Interval 2 to 3 (us)	Start time (us)
1	3	66.7	11	1632.0	1386.0	0.475003
2	1	55.9	11	-	-	1.175940
3	2	66.4	11	1271.0	-	2.602946
4	2	92.6	13	1705.0	-	3.650346
5	2	72.6	13	1909.0	-	3.951644
6	3	64.9	6	1698.0	1548.0	5.063731
7	2	98.1	11	1076.0	-	6.439734
8	1	75.0	19	-	-	7.238502
9	2	56.8	5	1682.0	-	8.131283
10	2	77.3	8	1357.0	-	9.207148
11	1	91.0	8	-	-	9.956855
12	2	86.6	14	1420.0	-	10.509709
13	2	69.5	18	1245.0	-	11.329142



**Table 31 - CU Steady State Long Sequence Waveform Trial#17 (Detected)**

Burst #	# Pulses	Pulse Width (us)	Chirp (MHz)	Interval 1 to 2 (us)	Interval 2 to 3 (us)	Start time (us)
1	2	50.9	11	1950.0	-	0.126827
2	3	87.5	10	1153.0	1208.0	1.382951
3	3	88.1	18	1865.0	1975.0	1.707282
4	2	95.9	10	1389.0	-	2.386856
5	2	73.7	9	1464.0	-	3.713061
6	2	56.1	13	1878.0	-	4.213967
7	1	90.6	7	-	-	5.116941
8	1	82.7	18	-	-	5.840085
9	1	72.3	14	-	-	6.138516
10	1	63.6	6	-	-	7.343893
11	2	59.6	10	1075.0	-	7.690390
12	1	66.7	17	-	-	8.949448
13	3	75.3	15	1249.0	1732.0	9.690435
14	2	52.5	13	1355.0	-	10.272358
15	3	81.8	16	1914.0	1075.0	10.836052
16	2	55.0	16	1298.0	-	11.352696

**Table 32 - CU Steady State Long Sequence Waveform Trial#18 (Detected)**

Burst #	# Pulses	Pulse Width (us)	Chirp (MHz)	Interval 1 to 2 (us)	Interval 2 to 3 (us)	Start time (us)
1	3	50.2	11	1843.0	1872.0	0.778220
2	3	77.6	19	1332.0	1584.0	0.867272
3	1	79.0	20	-	-	2.033593
4	3	86.1	5	1297.0	1184.0	2.657848
5	3	80.4	13	1938.0	1933.0	3.588928
6	2	87.4	10	1495.0	-	4.422536
7	2	85.8	13	1235.0	-	5.144545
8	3	72.3	18	1513.0	1745.0	6.275088
9	2	99.9	15	1773.0	-	7.395933
10	3	62.0	6	1641.0	1174.0	8.351930
11	2	97.0	7	1402.0	-	8.816891
12	3	97.4	16	1943.0	1998.0	9.867063
13	1	79.4	14	-	-	10.462885
14	2	51.3	16	1701.0	-	11.526799

**Table 33 - CU Steady State Long Sequence Waveform Trial#19 (Detected)**

Burst #	# Pulses	Pulse Width (us)	Chirp (MHz)	Interval 1 to 2 (us)	Interval 2 to 3 (us)	Start time (us)
1	1	76.8	10	-	-	0.673066
2	2	52.2	9	1614.0	-	1.570611
3	3	66.7	7	1654.0	1631.0	2.367897
4	3	99.8	18	1986.0	1763.0	3.123349
5	2	77.8	8	1257.0	-	3.986195
6	2	78.6	8	1484.0	-	5.203048
7	2	68.7	9	1910.0	-	5.562150
8	2	81.1	14	1509.0	-	6.602789
9	1	68.0	11	-	-	7.416182
10	3	73.7	11	1855.0	2000.0	8.897970
11	1	89.0	18	-	-	9.331685
12	3	63.5	15	1952.0	1819.0	10.731625
13	2	53.9	18	1228.0	-	11.282952

**Table 34 - CU Steady State Long Sequence Waveform Trial#20 (Detected)**

Burst #	# Pulses	Pulse Width (us)	Chirp (MHz)	Interval 1 to 2 (us)	Interval 2 to 3 (us)	Start time (us)
1	2	84.2	20	1490.0	-	0.104682
2	2	64.0	19	1071.0	-	1.941365
3	1	87.2	16	-	-	2.697541
4	3	83.7	9	1281.0	1530.0	3.775515
5	3	86.9	6	1384.0	1871.0	4.718535
6	2	83.1	12	1466.0	-	5.587040
7	3	51.5	11	1819.0	1381.0	6.629231
8	2	67.0	17	1328.0	-	7.630416
9	3	59.1	11	1601.0	1152.0	8.037794
10	2	68.6	20	1074.0	-	9.513351
11	2	97.4	7	1527.0	-	10.182196
12	2	94.5	14	1379.0	-	11.361335

**Table 35 - CU Steady State Long Sequence Waveform Trial#21 (Detected)**

Burst #	# Pulses	Pulse Width (us)	Chirp (MHz)	Interval 1 to 2 (us)	Interval 2 to 3 (us)	Start time (us)
1	2	66.3	16	1030.0	-	0.665736
2	2	69.7	13	1480.0	-	1.310316
3	1	97.2	19	-	-	2.369625
4	2	96.2	11	1474.0	-	3.547330
5	1	73.6	14	-	-	4.542632
6	2	72.5	9	1102.0	-	5.077294
7	2	98.7	5	1577.0	-	6.434281
8	1	61.1	8	-	-	7.186688
9	3	90.4	9	1743.0	1075.0	8.548267
10	2	90.4	9	1787.0	-	9.460053
11	2	68.1	17	1305.0	-	10.407526
12	2	51.5	10	1587.0	-	11.295424

**Table 36 - CU Steady State Long Sequence Waveform Trial#22 (Detected)**

Burst #	# Pulses	Pulse Width (us)	Chirp (MHz)	Interval 1 to 2 (us)	Interval 2 to 3 (us)	Start time (us)
1	2	91.9	8	1752.0	-	0.883642
2	1	58.8	11	-	-	1.533659
3	3	85.8	15	1971.0	1631.0	2.480855
4	2	88.6	17	1613.0	-	3.554692
5	1	94.2	14	-	-	3.952293
6	2	60.6	19	1905.0	-	5.507816
7	2	94.8	7	1021.0	-	6.407822
8	3	89.2	10	1392.0	1197.0	6.472528
9	3	67.3	10	1968.0	1178.0	7.814674
10	3	99.2	12	1772.0	1708.0	8.550053
11	3	69.1	8	1491.0	1711.0	9.235391
12	2	96.7	6	1401.0	-	10.251514
13	2	79.2	15	1447.0	-	11.775431

**Table 37 - CU Steady State Long Sequence Waveform Trial#23 (Detected)**

Burst #	# Pulses	Pulse Width (us)	Chirp (MHz)	Interval 1 to 2 (us)	Interval 2 to 3 (us)	Start time (us)
1	1	99.1	18	-	-	0.408315
2	3	87.2	10	1693.0	1382.0	0.756430
3	2	67.8	10	1440.0	-	1.788185
4	2	96.3	16	1242.0	-	2.385767
5	2	90.7	14	1458.0	-	3.688091
6	3	50.7	14	1907.0	1259.0	4.450606
7	2	80.4	16	1982.0	-	5.184797
8	2	50.6	19	1216.0	-	5.308136
9	2	57.1	13	1294.0	-	6.270054
10	2	84.6	13	1235.0	-	7.083729
11	2	75.0	6	1071.0	-	7.750734
12	1	70.8	10	-	-	8.533584
13	2	65.7	15	1534.0	-	9.237880
14	2	54.6	11	1568.0	-	10.340919
15	1	74.0	13	-	-	10.925112
16	3	95.7	19	1438.0	1519.0	11.530823

**Table 38 - CU Steady State Long Sequence Waveform Trial#24 (Detected)**

Burst #	# Pulses	Pulse Width (us)	Chirp (MHz)	Interval 1 to 2 (us)	Interval 2 to 3 (us)	Start time (us)
1	1	75.0	18	-	-	0.395447
2	2	54.1	12	1324.0	-	2.045591
3	2	52.5	15	1290.0	-	2.448281
4	2	88.1	11	1376.0	-	4.067231
5	2	52.7	11	1151.0	-	5.134873
6	1	88.8	8	-	-	5.789270
7	3	79.3	6	1457.0	1584.0	6.548959
8	2	63.9	20	1540.0	-	8.602823
9	2	90.0	6	1599.0	-	9.575735
10	1	85.0	20	-	-	10.448914
11	1	70.4	19	-	-	11.188731

**Table 39 - CU Steady State Long Sequence Waveform Trial#25 (Detected)**

Burst #	# Pulses	Pulse Width (us)	Chirp (MHz)	Interval 1 to 2 (us)	Interval 2 to 3 (us)	Start time (us)
1	2	64.4	7	1236.0	-	0.359153
2	1	76.9	10	-	-	1.363047
3	2	66.0	18	1842.0	-	2.777290
4	2	76.4	10	1022.0	-	3.451555
5	3	60.6	19	1045.0	1166.0	4.331071
6	2	66.2	6	1771.0	-	5.528285
7	2	94.5	6	1850.0	-	6.576195
8	2	83.4	19	1855.0	-	7.659719
9	3	82.8	6	1674.0	1415.0	8.402527
10	3	78.9	14	1768.0	1352.0	9.794442
11	2	73.4	8	1696.0	-	10.507072
12	3	57.7	15	1958.0	1496.0	11.510474

**Table 40 - CU Steady State Long Sequence Waveform Trial#26 (Detected)**

Burst #	# Pulses	Pulse Width (us)	Chirp (MHz)	Interval 1 to 2 (us)	Interval 2 to 3 (us)	Start time (us)
1	1	54.2	12	-	-	0.060414
2	3	72.1	19	1676.0	1183.0	1.051447
3	2	90.4	19	1875.0	-	2.571033
4	3	97.4	18	1764.0	1988.0	3.545317
5	1	60.8	14	-	-	4.039857
6	3	64.1	6	1390.0	1969.0	5.824735
7	3	95.7	7	1184.0	1115.0	6.573013
8	2	69.5	5	1848.0	-	7.265129
9	1	82.5	10	-	-	8.762675
10	3	78.2	14	1403.0	1109.0	9.990454
11	2	90.1	13	1904.0	-	10.696232
12	1	91.9	17	-	-	11.598859

**Table 41 - CU Steady State Long Sequence Waveform Trial#27 (Detected)**

Burst #	# Pulses	Pulse Width (us)	Chirp (MHz)	Interval 1 to 2 (us)	Interval 2 to 3 (us)	Start time (us)
1	2	74.5	12	1957.0	-	0.298354
2	1	53.4	7	-	-	1.019945
3	1	97.5	7	-	-	1.434618
4	3	87.2	17	1634.0	1720.0	1.904898
5	2	67.1	7	1709.0	-	2.856589
6	2	61.7	10	1369.0	-	3.511303
7	1	76.4	12	-	-	3.828677
8	1	67.5	10	-	-	4.213521
9	1	70.6	19	-	-	4.924383
10	2	96.9	10	1425.0	-	5.908971
11	3	70.4	6	1985.0	1655.0	6.385876
12	1	66.2	11	-	-	6.738874
13	3	58.6	16	1869.0	1241.0	7.374296
14	1	98.7	5	-	-	8.045609
15	3	54.8	6	1020.0	1059.0	8.625301
16	2	61.8	13	1705.0	-	9.207814
17	2	74.7	17	1098.0	-	10.191530
18	3	70.9	20	1010.0	1948.0	10.440788
19	2	73.6	9	1583.0	-	11.135732
20	2	98.4	14	1371.0	-	11.513526

**Table 42 - CU Steady State Long Sequence Waveform Trial#28 (Detected)**

Burst #	# Pulses	Pulse Width (us)	Chirp (MHz)	Interval 1 to 2 (us)	Interval 2 to 3 (us)	Start time (us)
1	3	60.4	10	1552.0	1863.0	0.258175
2	1	84.1	14	-	-	0.985682
3	2	80.5	14	1830.0	-	1.874532
4	3	58.6	17	1564.0	1631.0	2.192965
5	2	75.5	13	1030.0	-	2.829382
6	1	59.0	11	-	-	3.279596
7	1	73.4	14	-	-	4.147062
8	2	60.3	6	1506.0	-	4.950211
9	2	97.5	9	1042.0	-	5.432878
10	1	64.3	19	-	-	5.853654
11	2	63.3	14	1887.0	-	6.720144
12	3	91.4	19	1070.0	1051.0	6.993803
13	2	95.0	12	1897.0	-	7.652676
14	3	80.2	16	1468.0	1253.0	8.399525
15	1	51.6	12	-	-	9.155037
16	1	84.1	15	-	-	9.825088
17	2	93.2	19	1600.0	-	10.432905
18	3	50.6	16	1860.0	1271.0	11.324953
19	2	88.3	16	1884.0	-	11.843163

**Table 43 - CU Steady State Long Sequence Waveform Trial#29 (Detected)**

Burst #	# Pulses	Pulse Width (us)	Chirp (MHz)	Interval 1 to 2 (us)	Interval 2 to 3 (us)	Start time (us)
1	2	67.2	12	1907.0	-	0.260605
2	2	69.5	19	1821.0	-	0.772088
3	3	51.3	20	1665.0	1613.0	1.655504
4	2	51.7	12	1099.0	-	2.712310
5	1	70.1	11	-	-	2.837181
6	2	83.5	10	1921.0	-	4.216497
7	2	51.6	9	1081.0	-	4.278892
8	3	83.6	20	1351.0	1521.0	5.445248
9	1	74.7	12	-	-	5.846056
10	1	52.8	10	-	-	6.748716
11	1	69.2	17	-	-	7.422388
12	3	83.2	13	1233.0	1054.0	7.961686
13	1	73.0	6	-	-	9.136946
14	2	96.4	13	1889.0	-	9.692032
15	2	63.4	6	1921.0	-	9.946736
16	1	85.2	8	-	-	10.784970
17	2	53.4	12	1907.0	-	11.533176

**Table 44 - CU Steady State Long Sequence Waveform Trial#30 (Detected)**

Burst #	# Pulses	Pulse Width (us)	Chirp (MHz)	Interval 1 to 2 (us)	Interval 2 to 3 (us)	Start time (us)
1	2	56.1	17	1407.0	-	0.519315
2	2	62.6	8	1866.0	-	0.920661
3	2	90.7	15	1269.0	-	1.641877
4	1	87.0	14	-	-	2.698935
5	2	50.7	13	1906.0	-	2.954773
6	2	85.7	6	1349.0	-	3.786178
7	2	52.5	12	1396.0	-	4.386578
8	2	71.5	19	1987.0	-	5.269567
9	3	81.5	11	1337.0	1902.0	6.283866
10	3	82.5	6	1276.0	1323.0	6.908559
11	2	56.0	10	1482.0	-	7.419385
12	1	77.0	9	-	-	8.249707
13	2	66.8	16	1642.0	-	9.079833
14	3	54.3	15	1801.0	1640.0	9.257063
15	2	92.9	13	1133.0	-	10.124256
16	1	81.0	13	-	-	11.002479
17	2	89.7	12	1991.0	-	11.303304

Table 45 - FCC frequency hopping radar (Type 6) Results CU Steady State						
Trial #	Pulses/ Burst	Pulse Width (us)	PRI (us)	Detected	Fr (MHz) and level (dBm)	Burst Information
1	9	1.0	333.0	Yes	5294.8MHz, -62.0dBm	Hop sequence: 5580, 5290, 5503, 5411, 5496, 5596, 5523, 5623, 5381, 5601, 5482, 5710, 5708, 5369, 5283, 5441, 5705, 5434, 5373, 5573, 5258, 5445, 5442, 5286, 5637, 5642, 5690, 5564, 5342, 5679, 5723, 5402, 5329, 5428, 5534, 5611, 5651, 5685, 5701, 5477, 5281, 5378, 5680, 5508, 5632, 5532, 5585, 5275, 5391, 5416, 5665, 5544, 5406, 5541, 5563, 5481, 5636, 5535, 5543, 5475, 5408, 5472, 5307, 5656, 5615, 5579, 5311, 5704, 5407, 5323, 5720, 5393, 5437, 5713, 5553, 5682, 5485, 5517, 5700, 5370, 5397, 5438, 5610, 5347, 5627, 5448, 5473, 5664, 5560, 5681, 5519, 5488, 5582, 5424, 5650, 5252, 5716, 5693, 5277, 5722 (6 hits) (03/27/2012 09:30:12 AM)
2	9	1.0	333.0	Yes	5295.8MHz, -62.0dBm	Hop sequence: 5610, 5283, 5508, 5471, 5422, 5287, 5486, 5288, 5396, 5603, 5632, 5593, 5543, 5556, 5252, 5401, 5411, 5392, 5468, 5584, 5265, 5503, 5331, 5272, 5450, 5521, 5464, 5648, 5442, 5677, 5398, 5364, 5326, 5435, 5426, 5572, 5709, 5278, 5579, 5612, 5419, 5685, 5564, 5408, 5251, 5296, 5623, 5352, 5404, 5649, 5413, 5341, 5523, 5536, 5647, 5269, 5405, 5715, 5700, 5387, 5680, 5558, 5433, 5379, 5640, 5475, 5355, 5560, 5489, 5646, 5691, 5285, 5689, 5563, 5453, 5546, 5678, 5255, 5545, 5391, 5359, 5480, 5611, 5630, 5306, 5292, 5513, 5448, 5429, 5716, 5451, 5659, 5532, 5416, 5518, 5365, 5343, 5674, 5602, 5706 (6 hits) (03/27/2012 09:30:19 AM)
3	9	1.0	333.0	Yes	5273.8MHz, -62.0dBm	Hop sequence: 5502, 5629, 5563, 5390, 5269, 5630, 5307, 5374, 5290, 5310, 5568, 5511, 5272, 5488, 5666, 5560, 5450, 5491, 5453, 5306, 5429, 5573, 5358, 5645, 5725, 5644, 5648, 5525, 5614, 5417, 5400, 5320, 5487, 5662, 5540, 5387, 5346, 5385, 5257, 5345, 5603, 5721, 5355, 5702, 5685, 5566, 5544, 5578,

Table 45 - FCC frequency hopping radar (Type 6) Results CU Steady State						
Trial #	Pulses/ Burst	Pulse Width (us)	PRI (us)	Detected	Fr (MHz) and level (dBm)	Burst Information
						5528, 5396, 5620, 5496, 5609, 5714, 5463, 5604, 5574, 5716, 5384, 5651, 5309, 5667, 5469, 5693, 5562, 5529, 5252, 5315, 5659, 5351, 5676, 5569, 5704, 5435, 5536, 5302, 5356, 5675, 5300, 5516, 5545, 5619, 5329, 5697, 5348, 5256, 5557, 5391, 5715, 5600, 5393, 5505, 5587, 5425, 5363, 5558, 5486, 5552, 5703, 5681 (1 hits) (03/27/2012 09:30:27 AM)
4	9	1.0	333.0	Yes	5274.8MHz, -62.0dBm	Hop sequence: 5360, 5350, 5517, 5298, 5327, 5256, 5366, 5688, 5377, 5603, 5637, 5296, 5381, 5285, 5415, 5726, 5693, 5569, 5406, 5661, 5271, 5539, 5341, 5678, 5405, 5252, 5401, 5703, 5410, 5718, 5478, 5589, 5489, 5522, 5624, 5662, 5365, 5413, 5604, 5681, 5511, 5453, 5487, 5253, 5332, 5632, 5399, 5473, 5416, 5307, 5600, 5261, 5354, 5625, 5564, 5504, 5649, 5398, 5288, 5651, 5363, 5408, 5512, 5684, 5297, 5336, 5580, 5300, 5672, 5301, 5424, 5714, 5540, 5468, 5673, 5337, 5484, 5534, 5613, 5362, 5259, 5283, 5561, 5380, 5386, 5454, 5257, 5349, 5355, 5486, 5346, 5505, 5482, 5480, 5317, 5439, 5388, 5617, 5544, 5713 (3 hits) (03/27/2012 09:30:34 AM)
5	9	1.0	333.0	Yes	5275.8MHz, -62.0dBm	Hop sequence: 5687, 5577, 5345, 5336, 5433, 5494, 5453, 5484, 5444, 5526, 5668, 5551, 5289, 5306, 5616, 5373, 5662, 5435, 5682, 5390, 5355, 5283, 5474, 5509, 5316, 5507, 5260, 5335, 5410, 5556, 5287, 5499, 5461, 5454, 5488, 5486, 5360, 5716, 5385, 5312, 5534, 5324, 5262, 5561, 5294, 5417, 5414, 5399, 5619, 5327, 5261, 5309, 5365, 5463, 5429, 5341, 5389, 5655, 5278, 5529, 5275, 5650, 5302, 5402, 5426, 5553, 5251, 5612, 5303, 5424, 5635, 5456, 5555, 5276, 5591, 5394, 5673, 5266, 5496, 5558, 5672, 5511, 5400, 5715, 5637, 5640, 5416, 5256, 5415, 5699, 5427, 5450, 5709, 5466, 5419, 5467, 5307, 5471, 5331, 5598 (7 hits) (03/27/2012



Table 45 - FCC frequency hopping radar (Type 6) Results CU Steady State						
Trial #	Pulses/ Burst	Pulse Width (us)	PRI (us)	Detected	Fr (MHz) and level (dBm)	Burst Information
						09:30:41 AM)
6	9	1.0	333.0	Yes	5276.8MHz, -62.0dBm	Hop sequence: 5298, 5583, 5284, 5636, 5557, 5281, 5297, 5598, 5698, 5580, 5506, 5700, 5300, 5401, 5329, 5574, 5384, 5308, 5325, 5350, 5597, 5579, 5656, 5628, 5431, 5311, 5318, 5464, 5313, 5577, 5655, 5292, 5674, 5699, 5303, 5432, 5541, 5573, 5460, 5374, 5563, 5695, 5693, 5362, 5718, 5449, 5703, 5593, 5419, 5403, 5558, 5439, 5443, 5691, 5550, 5524, 5354, 5399, 5528, 5585, 5310, 5272, 5429, 5274, 5333, 5307, 5275, 5336, 5472, 5677, 5603, 5337, 5626, 5686, 5424, 5599, 5440, 5407, 5606, 5660, 5682, 5480, 5694, 5709, 5495, 5317, 5499, 5639, 5255, 5367, 5555, 5402, 5293, 5373, 5366, 5408, 5477, 5646, 5600, 5534 (6 hits) (03/27/2012 09:30:49 AM)
7	9	1.0	333.0	Yes	5277.8MHz, -62.0dBm	Hop sequence: 5435, 5613, 5377, 5336, 5419, 5580, 5451, 5484, 5365, 5387, 5340, 5723, 5343, 5424, 5702, 5404, 5261, 5629, 5292, 5549, 5518, 5379, 5609, 5591, 5253, 5675, 5573, 5359, 5700, 5472, 5625, 5521, 5305, 5431, 5706, 5344, 5333, 5541, 5273, 5509, 5606, 5417, 5315, 5589, 5374, 5536, 5645, 5446, 5382, 5550, 5366, 5515, 5535, 5562, 5578, 5452, 5319, 5414, 5551, 5561, 5269, 5471, 5662, 5279, 5595, 5646, 5678, 5713, 5557, 5556, 5677, 5670, 5263, 5460, 5396, 5300, 5425, 5701, 5569, 5267, 5533, 5354, 5630, 5284, 5469, 5405, 5327, 5709, 5688, 5428, 5350, 5388, 5426, 5612, 5622, 5705, 5334, 5295, 5348, 5468 (4 hits) (03/27/2012 09:30:56 AM)
8	9	1.0	333.0	Yes	5278.8MHz, -62.0dBm	Hop sequence: 5477, 5711, 5459, 5530, 5501, 5364, 5438, 5390, 5719, 5260, 5486, 5340, 5600, 5367, 5421, 5690, 5684, 5585, 5411, 5413, 5355, 5647, 5310, 5503, 5315, 5539, 5591, 5653, 5720, 5568, 5495, 5552, 5510, 5519, 5324, 5509, 5629, 5631, 5405, 5605, 5559, 5273, 5455, 5688, 5529, 5333, 5343, 5253,

Table 45 - FCC frequency hopping radar (Type 6) Results CU Steady State						
Trial #	Pulses/ Burst	Pulse Width (us)	PRI (us)	Detected	Fr (MHz) and level (dBm)	Burst Information
						5434, 5384, 5545, 5498, 5581, 5470, 5319, 5592, 5380, 5706, 5417, 5464, 5255, 5571, 5436, 5362, 5361, 5330, 5611, 5672, 5285, 5698, 5408, 5597, 5637, 5317, 5425, 5618, 5621, 5275, 5480, 5586, 5258, 5372, 5304, 5268, 5374, 5441, 5328, 5387, 5296, 5689, 5546, 5679, 5594, 5601, 5692, 5409, 5506, 5535, 5373, 5524 (2 hits) (03/27/2012 09:31:04 AM)
9	9	1.0	333.0	Yes	5279.8MHz, -62.0dBm	Hop sequence: 5563, 5578, 5702, 5618, 5710, 5429, 5469, 5674, 5302, 5328, 5283, 5439, 5639, 5493, 5470, 5273, 5635, 5505, 5450, 5317, 5331, 5583, 5697, 5484, 5613, 5678, 5356, 5494, 5430, 5537, 5679, 5447, 5483, 5402, 5385, 5436, 5630, 5713, 5668, 5573, 5425, 5460, 5640, 5262, 5479, 5459, 5540, 5531, 5529, 5487, 5719, 5330, 5705, 5666, 5721, 5471, 5363, 5650, 5354, 5376, 5504, 5379, 5659, 5278, 5289, 5603, 5510, 5434, 5523, 5464, 5550, 5421, 5566, 5669, 5383, 5345, 5272, 5286, 5492, 5709, 5584, 5664, 5657, 5387, 5634, 5295, 5296, 5397, 5371, 5551, 5581, 5692, 5643, 5545, 5694, 5382, 5615, 5475, 5511, 5391 (5 hits) (03/27/2012 09:31:31 AM)
10	9	1.0	333.0	Yes	5280.8MHz, -62.0dBm	Hop sequence: 5529, 5592, 5381, 5392, 5642, 5362, 5634, 5339, 5598, 5582, 5290, 5561, 5666, 5519, 5710, 5348, 5289, 5692, 5635, 5261, 5576, 5310, 5345, 5584, 5414, 5425, 5446, 5300, 5568, 5600, 5556, 5545, 5574, 5721, 5367, 5551, 5308, 5360, 5650, 5613, 5481, 5601, 5555, 5492, 5390, 5370, 5696, 5522, 5589, 5317, 5629, 5648, 5724, 5318, 5628, 5314, 5305, 5638, 5369, 5493, 5705, 5498, 5439, 5475, 5267, 5552, 5616, 5295, 5530, 5466, 5720, 5402, 5703, 5669, 5478, 5373, 5511, 5372, 5459, 5301, 5388, 5469, 5342, 5709, 5566, 5473, 5471, 5415, 5468, 5539, 5564, 5465, 5397, 5253, 5264, 5673, 5385, 5587, 5454, 5258 (3 hits) (03/27/2012

Table 45 - FCC frequency hopping radar (Type 6) Results CU Steady State						
Trial #	Pulses/ Burst	Pulse Width (us)	PRI (us)	Detected	Fr (MHz) and level (dBm)	Burst Information
						09:31:38 AM)
11	9	1.0	333.0	Yes	5281.8MHz, -62.0dBm	Hop sequence: 5600, 5480, 5451, 5410, 5486, 5346, 5568, 5676, 5674, 5536, 5595, 5578, 5716, 5634, 5571, 5723, 5488, 5692, 5316, 5661, 5691, 5456, 5274, 5455, 5542, 5465, 5679, 5427, 5267, 5678, 5384, 5710, 5370, 5699, 5537, 5387, 5287, 5440, 5421, 5433, 5304, 5447, 5417, 5687, 5640, 5269, 5604, 5321, 5652, 5602, 5560, 5534, 5315, 5485, 5390, 5662, 5515, 5540, 5637, 5632, 5419, 5701, 5434, 5650, 5295, 5466, 5484, 5441, 5552, 5555, 5258, 5322, 5399, 5715, 5651, 5517, 5521, 5526, 5708, 5360, 5450, 5335, 5350, 5665, 5670, 5302, 5331, 5348, 5324, 5255, 5585, 5330, 5426, 5606, 5549, 5712, 5621, 5260, 5509, 5482 (3 hits) (03/27/2012 09:31:45 AM)
12	9	1.0	333.0	Yes	5282.8MHz, -62.0dBm	Hop sequence: 5687, 5559, 5600, 5703, 5338, 5259, 5423, 5694, 5648, 5630, 5661, 5462, 5624, 5258, 5380, 5472, 5307, 5488, 5274, 5537, 5519, 5606, 5715, 5525, 5357, 5589, 5446, 5621, 5508, 5642, 5305, 5276, 5691, 5375, 5622, 5518, 5552, 5468, 5290, 5395, 5529, 5253, 5670, 5311, 5289, 5414, 5658, 5563, 5675, 5458, 5349, 5466, 5708, 5677, 5382, 5556, 5296, 5370, 5279, 5588, 5316, 5698, 5356, 5431, 5623, 5445, 5683, 5699, 5499, 5506, 5390, 5287, 5551, 5340, 5692, 5326, 5456, 5483, 5460, 5710, 5494, 5503, 5293, 5645, 5547, 5676, 5392, 5442, 5609, 5283, 5539, 5394, 5475, 5682, 5570, 5626, 5341, 5644, 5679, 5479 (8 hits) (03/27/2012 09:31:53 AM)
13	9	1.0	333.0	Yes	5283.8MHz, -62.0dBm	Hop sequence: 5493, 5368, 5362, 5293, 5280, 5383, 5366, 5461, 5479, 5663, 5489, 5615, 5376, 5554, 5522, 5357, 5372, 5579, 5531, 5511, 5416, 5345, 5680, 5557, 5563, 5312, 5710, 5434, 5449, 5290, 5724, 5625, 5458, 5584, 5635, 5586, 5336, 5365, 5675, 5692, 5339, 5603, 5715, 5517, 5347, 5629, 5521, 5311,

Table 45 - FCC frequency hopping radar (Type 6) Results CU Steady State						
Trial #	Pulses/ Burst	Pulse Width (us)	PRI (us)	Detected	Fr (MHz) and level (dBm)	Burst Information
						5392, 5322, 5283, 5562, 5251, 5655, 5323, 5442, 5314, 5529, 5292, 5337, 5436, 5622, 5338, 5633, 5510, 5607, 5585, 5656, 5564, 5403, 5545, 5404, 5265, 5523, 5466, 5528, 5688, 5687, 5341, 5470, 5268, 5645, 5264, 5608, 5297, 5538, 5698, 5261, 5353, 5315, 5277, 5386, 5702, 5578, 5486, 5566, 5266, 5488, 5630, 5393 (6 hits) (03/27/2012 09:32:05 AM)
14	9	1.0	333.0	Yes	5284.8MHz, -62.0dBm	Hop sequence: 5655, 5476, 5556, 5287, 5428, 5683, 5353, 5371, 5433, 5534, 5419, 5697, 5478, 5694, 5712, 5279, 5355, 5720, 5357, 5511, 5360, 5537, 5596, 5423, 5549, 5638, 5523, 5526, 5489, 5280, 5521, 5289, 5692, 5509, 5364, 5597, 5629, 5408, 5548, 5656, 5362, 5459, 5462, 5699, 5561, 5616, 5285, 5447, 5538, 5564, 5380, 5705, 5253, 5648, 5441, 5628, 5257, 5522, 5572, 5553, 5493, 5483, 5429, 5269, 5365, 5323, 5653, 5339, 5710, 5496, 5574, 5667, 5422, 5660, 5639, 5722, 5649, 5432, 5550, 5707, 5577, 5601, 5600, 5643, 5444, 5420, 5666, 5457, 5607, 5715, 5334, 5508, 5286, 5700, 5471, 5383, 5274, 5387, 5669, 5446 (7 hits) (03/27/2012 09:32:13 AM)
15	9	1.0	333.0	Yes	5285.8MHz, -62.0dBm	Hop sequence: 5598, 5396, 5289, 5539, 5291, 5455, 5589, 5253, 5533, 5308, 5535, 5463, 5618, 5466, 5493, 5639, 5590, 5482, 5566, 5467, 5503, 5712, 5431, 5720, 5637, 5507, 5490, 5583, 5401, 5578, 5276, 5690, 5341, 5434, 5259, 5299, 5610, 5317, 5567, 5602, 5657, 5716, 5518, 5511, 5356, 5288, 5677, 5559, 5488, 5508, 5448, 5387, 5615, 5399, 5594, 5544, 5388, 5391, 5707, 5579, 5672, 5495, 5519, 5625, 5565, 5462, 5549, 5329, 5352, 5609, 5502, 5676, 5556, 5430, 5344, 5336, 5441, 5318, 5541, 5301, 5500, 5415, 5333, 5547, 5327, 5617, 5452, 5668, 5357, 5268, 5424, 5494, 5658, 5528, 5694, 5523, 5377, 5313, 5326, 5606 (4 hits) (03/27/2012

Table 45 - FCC frequency hopping radar (Type 6) Results CU Steady State						
Trial #	Pulses/ Burst	Pulse Width (us)	PRI (us)	Detected	Fr (MHz) and level (dBm)	Burst Information
						09:32:26 AM)
16	9	1.0	333.0	Yes	5286.8MHz, -62.0dBm	Hop sequence: 5655, 5512, 5451, 5438, 5668, 5324, 5397, 5375, 5543, 5568, 5263, 5583, 5492, 5537, 5488, 5430, 5524, 5349, 5687, 5457, 5709, 5525, 5432, 5606, 5269, 5603, 5675, 5581, 5384, 5550, 5450, 5674, 5695, 5690, 5441, 5664, 5499, 5669, 5576, 5563, 5255, 5460, 5557, 5380, 5394, 5645, 5649, 5526, 5535, 5646, 5297, 5385, 5517, 5467, 5325, 5658, 5262, 5703, 5459, 5427, 5471, 5713, 5334, 5354, 5531, 5405, 5673, 5509, 5656, 5364, 5286, 5464, 5348, 5602, 5468, 5290, 5604, 5470, 5331, 5445, 5704, 5539, 5313, 5419, 5279, 5515, 5352, 5694, 5401, 5413, 5252, 5409, 5333, 5547, 5408, 5677, 5402, 5300, 5433, 5559 (3 hits) (03/27/2012 09:32:38 AM)
17	9	1.0	333.0	Yes	5287.8MHz, -62.0dBm	Hop sequence: 5421, 5287, 5260, 5311, 5604, 5263, 5475, 5555, 5303, 5363, 5376, 5480, 5609, 5377, 5673, 5293, 5399, 5280, 5647, 5358, 5695, 5502, 5369, 5618, 5726, 5666, 5560, 5451, 5340, 5447, 5627, 5689, 5533, 5692, 5445, 5466, 5724, 5265, 5538, 5581, 5276, 5348, 5715, 5597, 5663, 5651, 5301, 5636, 5501, 5615, 5539, 5446, 5642, 5688, 5613, 5518, 5428, 5540, 5571, 5595, 5362, 5519, 5669, 5558, 5541, 5494, 5468, 5564, 5422, 5353, 5516, 5705, 5506, 5350, 5283, 5431, 5296, 5635, 5716, 5629, 5330, 5593, 5592, 5499, 5390, 5264, 5251, 5632, 5693, 5526, 5698, 5598, 5622, 5646, 5562, 5660, 5306, 5393, 5710, 5704 (5 hits) (03/27/2012 09:32:45 AM)
18	9	1.0	333.0	Yes	5288.8MHz, -62.0dBm	Hop sequence: 5609, 5616, 5443, 5603, 5440, 5675, 5635, 5457, 5533, 5678, 5312, 5481, 5518, 5551, 5562, 5302, 5520, 5416, 5563, 5571, 5412, 5335, 5496, 5274, 5259, 5627, 5705, 5330, 5472, 5467, 5394, 5684, 5702, 5578, 5273, 5669, 5257, 5388, 5694, 5670, 5267, 5674, 5362, 5448, 5256, 5509, 5617, 5662,

Table 45 - FCC frequency hopping radar (Type 6) Results CU Steady State						
Trial #	Pulses/ Burst	Pulse Width (us)	PRI (us)	Detected	Fr (MHz) and level (dBm)	Burst Information
						5505, 5427, 5433, 5323, 5293, 5549, 5369, 5581, 5542, 5567, 5561, 5523, 5444, 5552, 5291, 5604, 5377, 5306, 5644, 5269, 5500, 5719, 5545, 5701, 5453, 5252, 5313, 5569, 5528, 5640, 5442, 5661, 5253, 5576, 5392, 5641, 5282, 5506, 5261, 5303, 5317, 5643, 5494, 5573, 5255, 5251, 5532, 5378, 5592, 5687, 5430, 5575 (4 hits) (03/27/2012 09:32:51 AM)
19	9	1.0	333.0	Yes	5289.8MHz, -62.0dBm	Hop sequence: 5634, 5472, 5507, 5380, 5252, 5603, 5692, 5316, 5488, 5409, 5456, 5713, 5525, 5592, 5295, 5644, 5682, 5463, 5491, 5350, 5342, 5340, 5395, 5453, 5264, 5607, 5253, 5466, 5654, 5544, 5255, 5411, 5279, 5387, 5625, 5482, 5270, 5532, 5312, 5680, 5413, 5307, 5471, 5620, 5446, 5291, 5600, 5412, 5303, 5666, 5365, 5602, 5724, 5678, 5277, 5362, 5376, 5378, 5383, 5353, 5486, 5669, 5673, 5317, 5297, 5597, 5423, 5257, 5533, 5590, 5594, 5429, 5558, 5697, 5708, 5513, 5676, 5449, 5259, 5518, 5322, 5384, 5314, 5263, 5374, 5334, 5445, 5447, 5272, 5549, 5502, 5534, 5690, 5635, 5642, 5289, 5631, 5402, 5517, 5469 (5 hits) (03/27/2012 09:32:58 AM)
20	9	1.0	333.0	Yes	5290.8MHz, -62.0dBm	Hop sequence: 5457, 5651, 5601, 5603, 5254, 5309, 5481, 5570, 5567, 5422, 5604, 5702, 5255, 5626, 5550, 5631, 5431, 5660, 5362, 5592, 5627, 5482, 5297, 5501, 5522, 5594, 5312, 5419, 5294, 5337, 5465, 5452, 5252, 5333, 5498, 5629, 5623, 5528, 5307, 5410, 5579, 5606, 5387, 5525, 5325, 5453, 5647, 5268, 5464, 5354, 5563, 5467, 5475, 5680, 5656, 5539, 5566, 5668, 5540, 5445, 5338, 5701, 5349, 5496, 5707, 5590, 5568, 5643, 5556, 5561, 5661, 5723, 5557, 5430, 5290, 5559, 5673, 5652, 5697, 5459, 5298, 5564, 5634, 5371, 5269, 5480, 5717, 5714, 5716, 5417, 5321, 5533, 5281, 5356, 5279, 5314, 5573, 5409, 5694, 5295 (5 hits) (03/27/2012

Table 45 - FCC frequency hopping radar (Type 6) Results CU Steady State						
Trial #	Pulses/ Burst	Pulse Width (us)	PRI (us)	Detected	Fr (MHz) and level (dBm)	Burst Information
						09:33:05 AM)
21	9	1.0	333.0	Yes	5291.8MHz, -62.0dBm	Hop sequence: 5386, 5414, 5618, 5287, 5649, 5672, 5552, 5619, 5369, 5255, 5314, 5531, 5407, 5596, 5324, 5597, 5364, 5509, 5686, 5344, 5483, 5720, 5404, 5610, 5681, 5541, 5473, 5469, 5363, 5409, 5707, 5420, 5471, 5478, 5426, 5684, 5347, 5589, 5252, 5273, 5351, 5442, 5452, 5401, 5556, 5348, 5421, 5267, 5614, 5319, 5587, 5264, 5602, 5372, 5399, 5311, 5459, 5315, 5561, 5276, 5285, 5637, 5354, 5340, 5397, 5519, 5493, 5367, 5581, 5339, 5670, 5654, 5448, 5547, 5716, 5512, 5585, 5444, 5651, 5542, 5479, 5582, 5603, 5253, 5671, 5505, 5431, 5277, 5272, 5568, 5645, 5669, 5400, 5627, 5588, 5321, 5514, 5496, 5682, 5527 (4 hits) (03/27/2012 09:33:13 AM)
22	9	1.0	333.0	Yes	5292.8MHz, -62.0dBm	Hop sequence: 5637, 5300, 5410, 5551, 5592, 5644, 5356, 5666, 5704, 5417, 5310, 5613, 5650, 5631, 5492, 5250, 5550, 5567, 5546, 5564, 5415, 5370, 5664, 5431, 5601, 5465, 5568, 5510, 5632, 5524, 5257, 5485, 5589, 5263, 5366, 5269, 5267, 5574, 5690, 5591, 5273, 5649, 5301, 5452, 5652, 5715, 5446, 5482, 5277, 5334, 5451, 5518, 5556, 5620, 5646, 5532, 5422, 5554, 5478, 5450, 5608, 5391, 5359, 5292, 5555, 5539, 5526, 5355, 5447, 5641, 5679, 5697, 5580, 5562, 5420, 5647, 5617, 5390, 5521, 5341, 5706, 5481, 5627, 5397, 5595, 5441, 5444, 5701, 5645, 5523, 5500, 5480, 5363, 5329, 5374, 5497, 5699, 5316, 5707, 5607 (2 hits) (03/27/2012 09:33:20 AM)
23	9	1.0	333.0	Yes	5293.8MHz, -62.0dBm	Hop sequence: 5452, 5380, 5460, 5539, 5461, 5545, 5421, 5605, 5469, 5604, 5297, 5263, 5619, 5494, 5721, 5395, 5470, 5479, 5664, 5341, 5277, 5512, 5381, 5335, 5634, 5442, 5359, 5433, 5589, 5447, 5291, 5270, 5430, 5444, 5562, 5707, 5506, 5713, 5339, 5429, 5637, 5309, 5356, 5313, 5390, 5484, 5306, 5488,

Table 45 - FCC frequency hopping radar (Type 6) Results CU Steady State						
Trial #	Pulses/ Burst	Pulse Width (us)	PRI (us)	Detected	Fr (MHz) and level (dBm)	Burst Information
						5631, 5349, 5695, 5252, 5577, 5385, 5473, 5370, 5329, 5314, 5408, 5544, 5719, 5357, 5495, 5525, 5701, 5572, 5517, 5378, 5659, 5640, 5492, 5405, 5500, 5553, 5499, 5618, 5531, 5628, 5326, 5377, 5676, 5398, 5480, 5412, 5613, 5363, 5583, 5533, 5564, 5563, 5654, 5725, 5687, 5296, 5318, 5633, 5620, 5300, 5678, 5459 (2 hits) (03/27/2012 09:33:27 AM)
24	9	1.0	333.0	Yes	5294.8MHz, -62.0dBm	Hop sequence: 5599, 5540, 5293, 5340, 5297, 5461, 5538, 5409, 5642, 5645, 5368, 5317, 5416, 5499, 5537, 5481, 5359, 5518, 5725, 5574, 5388, 5618, 5433, 5434, 5384, 5407, 5290, 5379, 5494, 5545, 5316, 5660, 5401, 5480, 5654, 5294, 5279, 5621, 5619, 5608, 5630, 5719, 5265, 5506, 5354, 5296, 5457, 5514, 5557, 5442, 5661, 5482, 5582, 5417, 5565, 5380, 5292, 5676, 5488, 5320, 5259, 5276, 5360, 5601, 5253, 5529, 5500, 5483, 5507, 5260, 5318, 5683, 5523, 5420, 5255, 5372, 5392, 5629, 5311, 5251, 5275, 5458, 5587, 5289, 5491, 5595, 5411, 5553, 5673, 5602, 5723, 5283, 5556, 5573, 5610, 5440, 5680, 5535, 5455, 5520 (9 hits) (03/27/2012 09:33:40 AM)
25	9	1.0	333.0	Yes	5295.8MHz, -62.0dBm	Hop sequence: 5420, 5651, 5366, 5295, 5643, 5489, 5259, 5262, 5431, 5607, 5597, 5263, 5467, 5620, 5549, 5355, 5621, 5484, 5442, 5482, 5330, 5492, 5456, 5507, 5383, 5715, 5415, 5644, 5365, 5517, 5462, 5634, 5344, 5588, 5636, 5583, 5473, 5422, 5375, 5572, 5327, 5374, 5332, 5398, 5329, 5689, 5590, 5571, 5593, 5370, 5642, 5362, 5552, 5477, 5696, 5271, 5316, 5511, 5508, 5513, 5251, 5254, 5430, 5471, 5410, 5682, 5610, 5565, 5293, 5465, 5400, 5526, 5360, 5664, 5466, 5461, 5318, 5699, 5706, 5656, 5379, 5708, 5500, 5542, 5578, 5695, 5310, 5632, 5575, 5493, 5671, 5580, 5265, 5429, 5264, 5434, 5322, 5313, 5547, 5726 (2 hits) (03/27/2012



Table 45 - FCC frequency hopping radar (Type 6) Results CU Steady State						
Trial #	Pulses/ Burst	Pulse Width (us)	PRI (us)	Detected	Fr (MHz) and level (dBm)	Burst Information
						09:33:48 AM)
26	9	1.0	333.0	Yes	5273.8MHz, -62.0dBm	Hop sequence: 5559, 5498, 5308, 5364, 5625, 5511, 5613, 5405, 5324, 5272, 5605, 5560, 5404, 5586, 5425, 5551, 5692, 5331, 5349, 5564, 5251, 5710, 5523, 5639, 5555, 5698, 5656, 5554, 5303, 5688, 5328, 5366, 5589, 5660, 5416, 5558, 5543, 5309, 5593, 5294, 5618, 5534, 5630, 5574, 5449, 5510, 5651, 5277, 5503, 5658, 5292, 5436, 5662, 5300, 5597, 5657, 5533, 5281, 5464, 5369, 5317, 5340, 5440, 5609, 5682, 5620, 5370, 5481, 5673, 5493, 5552, 5512, 5448, 5637, 5501, 5345, 5427, 5443, 5453, 5515, 5269, 5441, 5360, 5462, 5704, 5362, 5312, 5313, 5382, 5337, 5341, 5717, 5654, 5508, 5318, 5326, 5695, 5616, 5545, 5726 (4 hits) (03/27/2012 09:34:01 AM)
27	9	1.0	333.0	Yes	5274.8MHz, -62.0dBm	Hop sequence: 5545, 5652, 5601, 5612, 5280, 5607, 5414, 5577, 5640, 5531, 5301, 5421, 5367, 5307, 5416, 5320, 5404, 5387, 5339, 5707, 5298, 5335, 5594, 5454, 5573, 5487, 5324, 5484, 5543, 5255, 5430, 5451, 5346, 5590, 5456, 5373, 5700, 5498, 5634, 5631, 5680, 5568, 5274, 5383, 5724, 5395, 5608, 5653, 5418, 5449, 5693, 5609, 5437, 5578, 5582, 5494, 5632, 5517, 5679, 5428, 5375, 5636, 5662, 5567, 5520, 5708, 5610, 5559, 5345, 5270, 5530, 5716, 5515, 5289, 5493, 5403, 5471, 5581, 5673, 5686, 5702, 5534, 5537, 5669, 5606, 5572, 5690, 5718, 5649, 5413, 5551, 5258, 5684, 5436, 5516, 5356, 5363, 5546, 5710, 5615 (3 hits) (03/27/2012 09:34:10 AM)
28	9	1.0	333.0	Yes	5275.8MHz, -62.0dBm	Hop sequence: 5579, 5301, 5490, 5578, 5488, 5276, 5308, 5501, 5311, 5712, 5298, 5723, 5303, 5537, 5560, 5309, 5403, 5543, 5661, 5532, 5271, 5704, 5302, 5509, 5393, 5305, 5354, 5367, 5282, 5455, 5461, 5329, 5351, 5573, 5260, 5593, 5478, 5476, 5688, 5424, 5339, 5346, 5646, 5674, 5333, 5676, 5681, 5557,

Table 45 - FCC frequency hopping radar (Type 6) Results CU Steady State						
Trial #	Pulses/ Burst	Pulse Width (us)	PRI (us)	Detected	Fr (MHz) and level (dBm)	Burst Information
						5457, 5575, 5590, 5349, 5673, 5632, 5442, 5477, 5500, 5368, 5633, 5364, 5724, 5270, 5619, 5336, 5306, 5328, 5334, 5604, 5555, 5258, 5317, 5631, 5620, 5483, 5725, 5347, 5419, 5307, 5621, 5366, 5635, 5611, 5533, 5283, 5290, 5465, 5569, 5574, 5660, 5372, 5720, 5340, 5589, 5256, 5605, 5556, 5531, 5687, 5716, 5280 (5 hits) (03/27/2012 09:34:22 AM)
29	9	1.0	333.0	Yes	5276.8MHz, -62.0dBm	Hop sequence: 5724, 5619, 5560, 5675, 5286, 5607, 5302, 5723, 5345, 5480, 5639, 5614, 5425, 5636, 5635, 5390, 5696, 5685, 5562, 5513, 5653, 5327, 5542, 5319, 5340, 5514, 5716, 5634, 5643, 5431, 5650, 5323, 5572, 5262, 5536, 5714, 5290, 5527, 5463, 5622, 5370, 5525, 5457, 5420, 5539, 5702, 5721, 5472, 5433, 5297, 5697, 5609, 5251, 5395, 5647, 5673, 5700, 5298, 5374, 5339, 5506, 5512, 5256, 5392, 5726, 5645, 5641, 5338, 5355, 5578, 5318, 5616, 5503, 5487, 5717, 5288, 5434, 5253, 5415, 5660, 5589, 5394, 5497, 5680, 5523, 5494, 5632, 5315, 5460, 5266, 5293, 5623, 5676, 5371, 5499, 5631, 5317, 5464, 5382, 5294 (5 hits) (03/27/2012 09:34:30 AM)
30	9	1.0	333.0	Yes	5277.8MHz, -62.0dBm	Hop sequence: 5606, 5343, 5385, 5545, 5551, 5386, 5587, 5608, 5493, 5293, 5487, 5371, 5438, 5488, 5631, 5392, 5650, 5463, 5327, 5342, 5675, 5323, 5536, 5377, 5467, 5319, 5372, 5315, 5473, 5639, 5718, 5443, 5280, 5540, 5300, 5694, 5646, 5642, 5409, 5460, 5659, 5532, 5440, 5276, 5410, 5457, 5676, 5661, 5424, 5253, 5286, 5513, 5316, 5581, 5411, 5458, 5610, 5339, 5284, 5435, 5259, 5585, 5477, 5302, 5511, 5466, 5417, 5726, 5364, 5690, 5611, 5262, 5584, 5619, 5535, 5552, 5618, 5609, 5721, 5633, 5664, 5510, 5313, 5684, 5605, 5710, 5299, 5281, 5515, 5714, 5333, 5688, 5474, 5601, 5328, 5655, 5554, 5506, 5520, 5278 (7 hits) (03/27/2012

Table 45 - FCC frequency hopping radar (Type 6) Results CU Steady State						
Trial #	Pulses/ Burst	Pulse Width (us)	PRI (us)	Detected	Fr (MHz) and level (dBm)	Burst Information
						09:34:43 AM)
31	9	1.0	333.0	Yes	5278.8MHz, -62.0dBm	Hop sequence: 5337, 5377, 5413, 5586, 5352, 5353, 5428, 5647, 5303, 5271, 5677, 5357, 5261, 5306, 5341, 5351, 5283, 5450, 5328, 5608, 5479, 5424, 5503, 5617, 5583, 5711, 5308, 5253, 5646, 5547, 5367, 5415, 5381, 5629, 5554, 5488, 5433, 5474, 5698, 5565, 5571, 5624, 5256, 5375, 5717, 5258, 5446, 5654, 5408, 5683, 5590, 5278, 5630, 5550, 5291, 5541, 5536, 5483, 5678, 5517, 5515, 5655, 5296, 5315, 5713, 5616, 5576, 5699, 5529, 5642, 5281, 5580, 5294, 5360, 5569, 5718, 5495, 5436, 5432, 5584, 5491, 5723, 5531, 5643, 5501, 5358, 5505, 5520, 5702, 5499, 5635, 5498, 5695, 5653, 5422, 5297, 5429, 5362, 5472, 5592 (5 hits) (03/27/2012 09:34:52 AM)
32	9	1.0	333.0	Yes	5279.8MHz, -62.0dBm	Hop sequence: 5453, 5300, 5344, 5471, 5565, 5440, 5723, 5371, 5359, 5427, 5693, 5703, 5523, 5613, 5333, 5409, 5297, 5514, 5343, 5617, 5329, 5480, 5563, 5413, 5676, 5387, 5272, 5482, 5262, 5379, 5414, 5277, 5520, 5290, 5408, 5696, 5468, 5394, 5339, 5355, 5261, 5323, 5574, 5689, 5326, 5546, 5625, 5554, 5664, 5308, 5650, 5654, 5675, 5301, 5442, 5295, 5304, 5378, 5587, 5331, 5573, 5688, 5649, 5542, 5653, 5296, 5292, 5310, 5391, 5677, 5311, 5293, 5562, 5690, 5366, 5549, 5478, 5524, 5691, 5364, 5615, 5708, 5533, 5450, 5426, 5368, 5486, 5501, 5597, 5672, 5614, 5673, 5429, 5281, 5266, 5415, 5465, 5466, 5498, 5608 (6 hits) (03/27/2012 09:34:59 AM)
33	9	1.0	333.0	Yes	5280.8MHz, -62.0dBm	Hop sequence: 5542, 5465, 5259, 5251, 5521, 5445, 5261, 5325, 5548, 5609, 5492, 5491, 5392, 5294, 5534, 5364, 5380, 5430, 5284, 5650, 5644, 5437, 5407, 5661, 5399, 5356, 5453, 5508, 5382, 5680, 5393, 5266, 5264, 5689, 5606, 5306, 5410, 5404, 5527, 5255, 5368, 5600, 5461, 5577, 5405, 5388, 5696, 5715,

Table 45 - FCC frequency hopping radar (Type 6) Results CU Steady State						
Trial #	Pulses/ Burst	Pulse Width (us)	PRI (us)	Detected	Fr (MHz) and level (dBm)	Burst Information
						5272, 5630, 5479, 5591, 5308, 5351, 5525, 5435, 5480, 5713, 5562, 5539, 5717, 5425, 5554, 5519, 5705, 5598, 5718, 5469, 5464, 5350, 5573, 5657, 5719, 5653, 5641, 5509, 5328, 5697, 5313, 5344, 5326, 5544, 5699, 5638, 5282, 5367, 5667, 5288, 5669, 5414, 5623, 5643, 5501, 5532, 5298, 5552, 5649, 5455, 5252, 5675 (4 hits) (03/27/2012 09:35:07 AM)
34	9	1.0	333.0	Yes	5281.8MHz, -62.0dBm	Hop sequence: 5594, 5589, 5326, 5440, 5688, 5359, 5681, 5354, 5637, 5421, 5548, 5557, 5528, 5283, 5459, 5466, 5648, 5574, 5432, 5608, 5635, 5447, 5393, 5689, 5324, 5661, 5646, 5520, 5722, 5529, 5422, 5559, 5251, 5417, 5631, 5481, 5712, 5623, 5579, 5275, 5334, 5279, 5671, 5550, 5675, 5569, 5317, 5463, 5456, 5508, 5414, 5686, 5670, 5533, 5682, 5288, 5611, 5539, 5576, 5413, 5714, 5473, 5700, 5352, 5713, 5617, 5717, 5284, 5704, 5441, 5274, 5665, 5516, 5357, 5518, 5336, 5427, 5356, 5270, 5294, 5567, 5465, 5403, 5664, 5491, 5445, 5624, 5259, 5412, 5622, 5254, 5615, 5479, 5496, 5649, 5621, 5309, 5399, 5416, 5398 (7 hits) (03/27/2012 09:35:14 AM)
35	9	1.0	333.0	Yes	5282.8MHz, -62.0dBm	Hop sequence: 5642, 5625, 5485, 5347, 5648, 5459, 5478, 5385, 5484, 5501, 5462, 5685, 5615, 5513, 5433, 5607, 5579, 5593, 5640, 5706, 5556, 5497, 5503, 5399, 5356, 5571, 5605, 5425, 5481, 5446, 5379, 5424, 5643, 5302, 5358, 5454, 5641, 5493, 5294, 5699, 5638, 5612, 5257, 5271, 5541, 5324, 5290, 5479, 5466, 5668, 5427, 5255, 5537, 5447, 5718, 5674, 5554, 5636, 5544, 5631, 5604, 5486, 5320, 5472, 5614, 5317, 5492, 5637, 5597, 5539, 5367, 5534, 5319, 5330, 5572, 5647, 5406, 5480, 5291, 5701, 5523, 5723, 5683, 5682, 5437, 5704, 5366, 5470, 5414, 5709, 5252, 5359, 5392, 5323, 5564, 5691, 5715, 5624, 5250, 5651 (3 hits) (03/27/2012

Table 45 - FCC frequency hopping radar (Type 6) Results CU Steady State						
Trial #	Pulses/ Burst	Pulse Width (us)	PRI (us)	Detected	Fr (MHz) and level (dBm)	Burst Information
						09:35:21 AM)
36	9	1.0	333.0	Yes	5283.8MHz, -62.0dBm	Hop sequence: 5419, 5535, 5695, 5396, 5479, 5558, 5537, 5322, 5644, 5646, 5633, 5620, 5632, 5356, 5367, 5642, 5454, 5448, 5301, 5441, 5577, 5713, 5676, 5679, 5398, 5292, 5696, 5259, 5511, 5574, 5473, 5302, 5361, 5353, 5340, 5604, 5504, 5580, 5377, 5277, 5519, 5521, 5328, 5599, 5487, 5650, 5409, 5554, 5295, 5408, 5334, 5329, 5538, 5391, 5698, 5304, 5678, 5653, 5251, 5486, 5321, 5500, 5584, 5375, 5432, 5657, 5720, 5427, 5401, 5556, 5534, 5589, 5518, 5582, 5516, 5662, 5687, 5478, 5431, 5317, 5605, 5360, 5613, 5390, 5451, 5524, 5689, 5374, 5541, 5533, 5342, 5405, 5638, 5595, 5313, 5586, 5324, 5373, 5286, 5647 (4 hits) (03/27/2012 09:35:28 AM)
37	9	1.0	333.0	Yes	5284.8MHz, -62.0dBm	Hop sequence: 5281, 5334, 5642, 5353, 5650, 5587, 5694, 5348, 5357, 5482, 5263, 5640, 5420, 5447, 5708, 5412, 5304, 5545, 5607, 5561, 5698, 5710, 5306, 5406, 5549, 5309, 5462, 5654, 5688, 5611, 5317, 5623, 5386, 5596, 5667, 5507, 5652, 5260, 5460, 5390, 5275, 5300, 5393, 5544, 5683, 5604, 5421, 5278, 5367, 5250, 5504, 5579, 5360, 5551, 5669, 5651, 5282, 5570, 5319, 5618, 5343, 5572, 5609, 5340, 5398, 5593, 5373, 5699, 5429, 5655, 5424, 5540, 5573, 5428, 5614, 5329, 5542, 5580, 5686, 5256, 5554, 5625, 5352, 5502, 5649, 5613, 5601, 5599, 5371, 5405, 5526, 5703, 5379, 5475, 5338, 5294, 5547, 5706, 5470, 5431 (5 hits) (03/27/2012 09:35:35 AM)
38	9	1.0	333.0	Yes	5285.8MHz, -62.0dBm	Hop sequence: 5692, 5552, 5309, 5658, 5527, 5435, 5601, 5489, 5596, 5520, 5590, 5428, 5622, 5687, 5297, 5698, 5443, 5616, 5405, 5705, 5445, 5545, 5355, 5397, 5286, 5587, 5621, 5667, 5677, 5516, 5385, 5526, 5387, 5459, 5398, 5651, 5434, 5563, 5285, 5470, 5509, 5714, 5642, 5647, 5623, 5365, 5519, 5336,

Table 45 - FCC frequency hopping radar (Type 6) Results CU Steady State						
Trial #	Pulses/ Burst	Pulse Width (us)	PRI (us)	Detected	Fr (MHz) and level (dBm)	Burst Information
						5501, 5628, 5644, 5259, 5633, 5620, 5420, 5417, 5442, 5508, 5337, 5560, 5255, 5300, 5457, 5271, 5295, 5472, 5514, 5597, 5352, 5646, 5615, 5539, 5679, 5262, 5289, 5540, 5652, 5688, 5491, 5507, 5448, 5588, 5402, 5725, 5689, 5530, 5490, 5716, 5671, 5333, 5685, 5594, 5703, 5389, 5673, 5306, 5463, 5304, 5423, 5702 (4 hits) (03/27/2012 09:35:43 AM)
39	9	1.0	333.0	Yes	5286.8MHz, -62.0dBm	Hop sequence: 5463, 5274, 5312, 5453, 5719, 5524, 5292, 5486, 5665, 5434, 5572, 5257, 5350, 5668, 5541, 5482, 5635, 5507, 5279, 5609, 5380, 5369, 5509, 5474, 5501, 5461, 5472, 5354, 5387, 5406, 5409, 5505, 5430, 5634, 5610, 5419, 5690, 5351, 5637, 5256, 5638, 5517, 5258, 5316, 5325, 5663, 5314, 5591, 5515, 5396, 5476, 5527, 5287, 5597, 5450, 5510, 5431, 5319, 5546, 5327, 5349, 5367, 5705, 5291, 5696, 5435, 5340, 5606, 5536, 5499, 5522, 5480, 5368, 5687, 5534, 5615, 5363, 5470, 5397, 5584, 5583, 5329, 5575, 5651, 5343, 5596, 5288, 5619, 5580, 5714, 5407, 5489, 5632, 5278, 5621, 5573, 5680, 5502, 5416, 5485 (7 hits) (03/27/2012 09:35:50 AM)
40	9	1.0	333.0	Yes	5287.8MHz, -62.0dBm	Hop sequence: 5366, 5362, 5302, 5700, 5454, 5382, 5553, 5525, 5353, 5277, 5482, 5294, 5348, 5664, 5620, 5483, 5288, 5489, 5550, 5633, 5623, 5444, 5252, 5635, 5435, 5307, 5723, 5720, 5282, 5340, 5688, 5561, 5334, 5486, 5339, 5471, 5710, 5628, 5465, 5529, 5451, 5641, 5338, 5270, 5369, 5558, 5656, 5697, 5480, 5258, 5370, 5394, 5705, 5306, 5676, 5522, 5692, 5292, 5504, 5321, 5464, 5507, 5416, 5408, 5707, 5584, 5580, 5329, 5427, 5458, 5263, 5544, 5309, 5335, 5371, 5505, 5478, 5549, 5511, 5582, 5301, 5669, 5513, 5571, 5650, 5310, 5357, 5490, 5474, 5361, 5333, 5519, 5284, 5588, 5279, 5360, 5624, 5579, 5373, 5585 (7 hits) (03/27/2012

Table 45 - FCC frequency hopping radar (Type 6) Results CU Steady State						
Trial #	Pulses/ Burst	Pulse Width (us)	PRI (us)	Detected	Fr (MHz) and level (dBm)	Burst Information
						09:35:57 AM)
41	9	1.0	333.0	Yes	5288.8MHz, -62.0dBm	Hop sequence: 5720, 5309, 5387, 5329, 5253, 5374, 5724, 5477, 5304, 5577, 5361, 5589, 5463, 5258, 5375, 5661, 5496, 5386, 5653, 5625, 5665, 5446, 5291, 5472, 5271, 5520, 5505, 5423, 5712, 5532, 5622, 5279, 5655, 5528, 5331, 5399, 5380, 5465, 5688, 5321, 5725, 5606, 5285, 5600, 5694, 5437, 5617, 5551, 5689, 5668, 5649, 5645, 5275, 5316, 5706, 5252, 5461, 5572, 5501, 5389, 5549, 5652, 5448, 5468, 5562, 5453, 5337, 5400, 5523, 5454, 5656, 5424, 5550, 5493, 5568, 5288, 5596, 5449, 5451, 5685, 5633, 5261, 5539, 5303, 5527, 5385, 5709, 5498, 5628, 5571, 5429, 5524, 5369, 5671, 5630, 5414, 5620, 5293, 5707, 5710 (6 hits) (03/27/2012 09:36:03 AM)
42	9	1.0	333.0	Yes	5289.8MHz, -62.0dBm	Hop sequence: 5334, 5712, 5350, 5251, 5439, 5515, 5319, 5672, 5400, 5627, 5577, 5494, 5367, 5385, 5656, 5606, 5440, 5426, 5480, 5512, 5360, 5636, 5401, 5520, 5510, 5564, 5393, 5650, 5699, 5451, 5257, 5406, 5418, 5708, 5288, 5414, 5270, 5590, 5307, 5533, 5509, 5629, 5487, 5312, 5465, 5669, 5704, 5514, 5366, 5523, 5337, 5386, 5618, 5648, 5364, 5470, 5374, 5483, 5423, 5702, 5275, 5605, 5710, 5714, 5383, 5324, 5670, 5320, 5335, 5718, 5391, 5479, 5253, 5559, 5655, 5681, 5703, 5460, 5581, 5341, 5721, 5293, 5556, 5719, 5551, 5458, 5555, 5683, 5701, 5586, 5444, 5333, 5295, 5318, 5328, 5392, 5485, 5287, 5663, 5327 (5 hits) (03/27/2012 09:36:10 AM)
43	9	1.0	333.0	Yes	5290.8MHz, -62.0dBm	Hop sequence: 5544, 5556, 5349, 5434, 5599, 5322, 5673, 5578, 5469, 5321, 5589, 5585, 5332, 5337, 5300, 5396, 5359, 5476, 5331, 5563, 5567, 5312, 5343, 5261, 5681, 5323, 5327, 5367, 5696, 5666, 5518, 5357, 5644, 5638, 5528, 5527, 5642, 5496, 5439, 5310, 5626, 5260, 5663, 5580, 5252, 5617, 5263, 5401,

Table 45 - FCC frequency hopping radar (Type 6) Results CU Steady State						
Trial #	Pulses/ Burst	Pulse Width (us)	PRI (us)	Detected	Fr (MHz) and level (dBm)	Burst Information
						5687, 5277, 5368, 5677, 5655, 5555, 5346, 5412, 5272, 5483, 5564, 5552, 5680, 5459, 5650, 5444, 5682, 5718, 5540, 5721, 5551, 5405, 5293, 5309, 5381, 5654, 5366, 5268, 5443, 5256, 5714, 5424, 5472, 5282, 5526, 5495, 5725, 5694, 5558, 5648, 5604, 5577, 5407, 5701, 5361, 5576, 5394, 5619, 5646, 5593, 5705, 5579 (3 hits) (03/27/2012 09:36:16 AM)
44	9	1.0	333.0	Yes	5291.8MHz, -62.0dBm	Hop sequence: 5687, 5337, 5570, 5580, 5624, 5469, 5663, 5267, 5381, 5611, 5615, 5629, 5268, 5590, 5634, 5357, 5710, 5564, 5557, 5676, 5512, 5434, 5698, 5296, 5438, 5331, 5545, 5721, 5507, 5352, 5491, 5649, 5272, 5298, 5527, 5712, 5343, 5606, 5259, 5492, 5476, 5360, 5628, 5405, 5602, 5440, 5426, 5690, 5703, 5470, 5681, 5650, 5678, 5389, 5303, 5338, 5697, 5550, 5518, 5688, 5362, 5683, 5481, 5498, 5453, 5409, 5587, 5437, 5435, 5383, 5307, 5451, 5588, 5589, 5323, 5423, 5600, 5314, 5566, 5499, 5686, 5419, 5422, 5349, 5395, 5500, 5567, 5443, 5467, 5691, 5327, 5464, 5646, 5716, 5450, 5645, 5647, 5407, 5516, 5291 (1 hits) (03/27/2012 09:36:24 AM)
45	9	1.0	333.0	Yes	5292.8MHz, -62.0dBm	Hop sequence: 5693, 5440, 5292, 5641, 5546, 5358, 5667, 5590, 5422, 5378, 5606, 5723, 5252, 5474, 5448, 5334, 5332, 5557, 5445, 5521, 5491, 5442, 5464, 5273, 5313, 5572, 5561, 5722, 5304, 5434, 5505, 5492, 5596, 5376, 5488, 5510, 5639, 5391, 5315, 5482, 5716, 5499, 5415, 5632, 5502, 5717, 5549, 5646, 5701, 5330, 5377, 5404, 5368, 5322, 5536, 5420, 5691, 5279, 5715, 5708, 5386, 5441, 5276, 5569, 5274, 5253, 5672, 5570, 5436, 5365, 5628, 5683, 5475, 5679, 5384, 5339, 5250, 5514, 5374, 5599, 5452, 5295, 5416, 5615, 5305, 5483, 5509, 5680, 5466, 5516, 5500, 5260, 5342, 5343, 5526, 5659, 5262, 5382, 5460, 5714 (5 hits) (03/27/2012



Table 45 - FCC frequency hopping radar (Type 6) Results CU Steady State						
Trial #	Pulses/ Burst	Pulse Width (us)	PRI (us)	Detected	Fr (MHz) and level (dBm)	Burst Information
						09:36:32 AM)
46	9	1.0	333.0	Yes	5293.8MHz, -62.0dBm	Hop sequence: 5631, 5372, 5287, 5253, 5352, 5703, 5567, 5613, 5652, 5669, 5316, 5259, 5591, 5297, 5382, 5286, 5484, 5551, 5275, 5302, 5474, 5604, 5529, 5668, 5648, 5463, 5256, 5659, 5616, 5531, 5624, 5643, 5619, 5294, 5724, 5261, 5586, 5274, 5671, 5516, 5281, 5528, 5640, 5262, 5282, 5538, 5476, 5280, 5697, 5722, 5472, 5362, 5663, 5597, 5621, 5400, 5714, 5490, 5336, 5637, 5678, 5361, 5312, 5310, 5455, 5501, 5326, 5266, 5674, 5656, 5273, 5650, 5670, 5611, 5272, 5269, 5519, 5715, 5508, 5342, 5420, 5454, 5676, 5257, 5683, 5378, 5470, 5371, 5639, 5726, 5617, 5681, 5413, 5592, 5587, 5585, 5387, 5319, 5578, 5406 (8 hits) (03/27/2012 09:36:39 AM)

**Table 46 – WU, CU Acquire High Band - Detection Bandwidth Measurements (Bandwidth:+17MHz /- 16MHz)**

EUT Frequency	Radar Type	Radar Frequency	# Detected	# Not Detected	Success (%)
5563.20 MHz	FCC Short Pulse Radar (Type 1)	5546.20 MHz	1	3	25
5563.20 MHz	FCC Short Pulse Radar (Type 1)	5547.20 MHz	10	0	100
5563.20 MHz	FCC Short Pulse Radar (Type 1)	5548.20 MHz	10	0	100
5563.20 MHz	FCC Short Pulse Radar (Type 1)	5549.20 MHz	10	0	100
5563.20 MHz	FCC Short Pulse Radar (Type 1)	5550.20 MHz	10	0	100
5563.20 MHz	FCC Short Pulse Radar (Type 1)	5551.20 MHz	10	0	100
5563.20 MHz	FCC Short Pulse Radar (Type 1)	5552.20 MHz	10	0	100
5563.20 MHz	FCC Short Pulse Radar (Type 1)	5553.20 MHz	10	0	100
5563.20 MHz	FCC Short Pulse Radar (Type 1)	5554.20 MHz	10	0	100
5563.20 MHz	FCC Short Pulse Radar (Type 1)	5555.20 MHz	10	0	100
5563.20 MHz	FCC Short Pulse Radar (Type 1)	5556.20 MHz	10	0	100
5563.20 MHz	FCC Short Pulse Radar (Type 1)	5557.20 MHz	10	0	100
5563.20 MHz	FCC Short Pulse Radar (Type 1)	5558.20 MHz	10	0	100
5563.20 MHz	FCC Short Pulse Radar (Type 1)	5559.20 MHz	10	0	100
5563.20 MHz	FCC Short Pulse Radar (Type 1)	5560.20 MHz	10	0	100
5563.20 MHz	FCC Short Pulse Radar (Type 1)	5561.20 MHz	10	0	100
5563.20 MHz	FCC Short Pulse Radar (Type 1)	5562.20 MHz	10	0	100
5563.20 MHz	FCC Short Pulse Radar (Type 1)	5563.20 MHz	10	0	100
5563.20 MHz	FCC Short Pulse Radar (Type 1)	5564.20 MHz	10	0	100
5563.20 MHz	FCC Short Pulse Radar (Type 1)	5565.20 MHz	10	0	100
5563.20 MHz	FCC Short Pulse Radar (Type 1)	5566.20 MHz	10	0	100
5563.20 MHz	FCC Short Pulse Radar (Type 1)	5567.20 MHz	10	0	100
5563.20 MHz	FCC Short Pulse Radar (Type 1)	5568.20 MHz	10	0	100
5563.20 MHz	FCC Short Pulse Radar (Type 1)	5569.20 MHz	10	0	100
5563.20 MHz	FCC Short Pulse Radar (Type 1)	5570.20 MHz	10	0	100
5563.20 MHz	FCC Short Pulse Radar (Type 1)	5571.20 MHz	10	0	100
5563.20 MHz	FCC Short Pulse Radar (Type 1)	5572.20 MHz	10	0	100
5563.20 MHz	FCC Short Pulse Radar (Type 1)	5573.20 MHz	10	0	100
5563.20 MHz	FCC Short Pulse Radar (Type 1)	5574.20 MHz	10	0	100
5563.20 MHz	FCC Short Pulse Radar (Type 1)	5575.20 MHz	10	0	100
5563.20 MHz	FCC Short Pulse Radar (Type 1)	5576.20 MHz	10	0	100
5563.20 MHz	FCC Short Pulse Radar (Type 1)	5577.20 MHz	10	0	100
5563.20 MHz	FCC Short Pulse Radar (Type 1)	5578.20 MHz	10	0	100
5563.20 MHz	FCC Short Pulse Radar (Type 1)	5579.20 MHz	10	0	100
5563.20 MHz	FCC Short Pulse Radar (Type 1)	5580.20 MHz	10	0	100
5563.20 MHz	FCC Short Pulse Radar (Type 1)	5581.20 MHz	2	3	40

## WU, CU Acquire Mode, High Band

**Table 47 - Summary of All Results - CU Acquire, High Band**

Waveform Name	Pd (%)	Pd Required (%)	Number of Trials	Status
FCC Short Pulse Radar (Type 1)	100.0 %	60.0 %	30	PASSED
FCC Short Pulse Radar (Type 2)	100.0 %	60.0 %	30	PASSED
FCC Short Pulse Radar (Type 3)	100.0 %	60.0 %	30	PASSED
FCC Short Pulse Radar (Type 4)	100.0 %	60.0 %	30	PASSED
Aggregate of above results	100.0 %	80.0 %	120	PASSED
FCC frequency hopping radar (Type 6)	100.0 %	70.0 %	34	PASSED
Long Sequence	100.0 %	80.0 %	30	PASSED

**Table 48 - FCC Short Pulse Radar (Type 1) Results CU Acquire, High Band**

Trial #	Pulses/ Burst	Pulse Width (us)	PRI (us)	Detected	Fr (MHz) and level (dBm)	Burst Information
1	18	1.0	1428.0	Yes	5563.2MHz, -62.0dBm	Single burst
2	18	1.0	1428.0	Yes	5558.2MHz, -62.0dBm	Single burst
3	18	1.0	1428.0	Yes	5553.2MHz, -62.0dBm	Single burst
4	18	1.0	1428.0	Yes	5573.2MHz, -62.0dBm	Single burst
5	18	1.0	1428.0	Yes	5568.2MHz, -62.0dBm	Single burst
6	18	1.0	1428.0	Yes	5563.2MHz, -62.0dBm	Single burst
7	18	1.0	1428.0	Yes	5558.2MHz, -62.0dBm	Single burst
8	18	1.0	1428.0	Yes	5553.2MHz, -62.0dBm	Single burst
9	18	1.0	1428.0	Yes	5573.2MHz, -62.0dBm	Single burst
10	18	1.0	1428.0	Yes	5568.2MHz, -62.0dBm	Single burst
11	18	1.0	1428.0	Yes	5563.2MHz, -62.0dBm	Single burst
12	18	1.0	1428.0	Yes	5558.2MHz, -62.0dBm	Single burst
13	18	1.0	1428.0	Yes	5553.2MHz, -62.0dBm	Single burst
14	18	1.0	1428.0	Yes	5573.2MHz, -62.0dBm	Single burst
15	18	1.0	1428.0	Yes	5568.2MHz, -62.0dBm	Single burst
16	18	1.0	1428.0	Yes	5563.2MHz, -62.0dBm	Single burst
17	18	1.0	1428.0	Yes	5558.2MHz, -62.0dBm	Single burst
18	18	1.0	1428.0	Yes	5553.2MHz, -62.0dBm	Single burst
19	18	1.0	1428.0	Yes	5573.2MHz, -62.0dBm	Single burst
20	18	1.0	1428.0	Yes	5568.2MHz, -62.0dBm	Single burst
21	18	1.0	1428.0	Yes	5563.2MHz, -62.0dBm	Single burst
22	18	1.0	1428.0	Yes	5558.2MHz, -62.0dBm	Single burst
23	18	1.0	1428.0	Yes	5553.2MHz, -62.0dBm	Single burst
24	18	1.0	1428.0	Yes	5573.2MHz, -62.0dBm	Single burst
25	18	1.0	1428.0	Yes	5568.2MHz, -62.0dBm	Single burst
26	18	1.0	1428.0	Yes	5563.2MHz, -62.0dBm	Single burst
27	18	1.0	1428.0	Yes	5558.2MHz, -62.0dBm	Single burst
28	18	1.0	1428.0	Yes	5553.2MHz, -62.0dBm	Single burst
29	18	1.0	1428.0	Yes	5573.2MHz, -62.0dBm	Single burst
30	18	1.0	1428.0	Yes	5568.2MHz, -62.0dBm	Single burst

**Table 49 - FCC Short Pulse Radar (Type 2) Results CU Acquire, High Band**

Trial #	Pulses/ Burst	Pulse Width (us)	PRI (us)	Detected	Fr (MHz) and level (dBm)	Burst Information
1	26	2.5	207.0	Yes	5563.2MHz, -62.0dBm	Single burst
2	27	3.4	150.0	Yes	5558.2MHz, -62.0dBm	Single burst
3	29	2.3	173.0	Yes	5553.2MHz, -62.0dBm	Single burst
4	25	3.8	184.0	Yes	5573.2MHz, -62.0dBm	Single burst
5	23	4.6	215.0	Yes	5568.2MHz, -62.0dBm	Single burst
6	27	2.6	183.0	Yes	5563.2MHz, -62.0dBm	Single burst
7	26	3.9	196.0	Yes	5558.2MHz, -62.0dBm	Single burst
8	26	4.3	229.0	Yes	5553.2MHz, -62.0dBm	Single burst
9	29	3.3	199.0	Yes	5573.2MHz, -62.0dBm	Single burst
10	25	1.8	174.0	Yes	5568.2MHz, -62.0dBm	Single burst
11	29	2.2	176.0	Yes	5563.2MHz, -62.0dBm	Single burst
12	27	4.0	205.0	Yes	5558.2MHz, -62.0dBm	Single burst
13	29	3.1	190.0	Yes	5553.2MHz, -62.0dBm	Single burst
14	24	1.4	224.0	Yes	5573.2MHz, -62.0dBm	Single burst
15	24	3.1	192.0	Yes	5568.2MHz, -62.0dBm	Single burst
16	27	4.4	209.0	Yes	5563.2MHz, -62.0dBm	Single burst
17	24	3.2	180.0	Yes	5558.2MHz, -62.0dBm	Single burst
18	25	3.7	197.0	Yes	5553.2MHz, -62.0dBm	Single burst
19	25	4.5	208.0	Yes	5573.2MHz, -62.0dBm	Single burst
20	27	2.7	161.0	Yes	5568.2MHz, -62.0dBm	Single burst
21	28	5.0	226.0	Yes	5563.2MHz, -62.0dBm	Single burst
22	28	3.5	230.0	Yes	5558.2MHz, -62.0dBm	Single burst
23	24	4.8	181.0	Yes	5553.2MHz, -62.0dBm	Single burst
24	26	3.0	229.0	Yes	5573.2MHz, -62.0dBm	Single burst
25	23	4.1	159.0	Yes	5568.2MHz, -62.0dBm	Single burst
26	24	4.2	193.0	Yes	5563.2MHz, -62.0dBm	Single burst
27	26	4.7	220.0	Yes	5558.2MHz, -62.0dBm	Single burst
28	28	4.3	194.0	Yes	5553.2MHz, -62.0dBm	Single burst
29	25	4.9	191.0	Yes	5573.2MHz, -62.0dBm	Single burst
30	26	4.5	194.0	Yes	5568.2MHz, -62.0dBm	Single burst

**Table 50 - FCC Short Pulse Radar (Type 3) Results CU Acquire, High Band**

Trial #	Pulses/ Burst	Pulse Width (us)	PRI (us)	Detected	Fr (MHz) and level (dBm)	Burst Information
1	16	6.1	391.0	Yes	5563.2MHz, -62.0dBm	Single burst
2	17	8.8	409.0	Yes	5558.2MHz, -62.0dBm	Single burst
3	17	6.2	433.0	Yes	5553.2MHz, -62.0dBm	Single burst
4	18	7.1	293.0	Yes	5573.2MHz, -62.0dBm	Single burst
5	18	7.7	477.0	Yes	5568.2MHz, -62.0dBm	Single burst
6	18	6.9	447.0	Yes	5563.2MHz, -62.0dBm	Single burst
7	17	7.8	472.0	Yes	5558.2MHz, -62.0dBm	Single burst
8	17	7.9	287.0	Yes	5553.2MHz, -62.0dBm	Single burst
9	18	6.7	306.0	Yes	5573.2MHz, -62.0dBm	Single burst
10	17	9.5	492.0	Yes	5568.2MHz, -62.0dBm	Single burst
11	16	8.0	458.0	Yes	5563.2MHz, -62.0dBm	Single burst
12	18	6.2	303.0	Yes	5558.2MHz, -62.0dBm	Single burst
13	18	9.7	470.0	Yes	5553.2MHz, -62.0dBm	Single burst
14	16	9.0	258.0	Yes	5573.2MHz, -62.0dBm	Single burst
15	17	9.8	202.0	Yes	5568.2MHz, -62.0dBm	Single burst
16	17	9.4	297.0	Yes	5563.2MHz, -62.0dBm	Single burst
17	16	7.3	402.0	Yes	5558.2MHz, -62.0dBm	Single burst
18	17	6.6	366.0	Yes	5553.2MHz, -62.0dBm	Single burst
19	17	9.5	297.0	Yes	5573.2MHz, -62.0dBm	Single burst
20	18	6.1	466.0	Yes	5568.2MHz, -62.0dBm	Single burst
21	16	7.9	208.0	Yes	5563.2MHz, -62.0dBm	Single burst
22	18	9.4	401.0	Yes	5558.2MHz, -62.0dBm	Single burst
23	18	7.7	398.0	Yes	5553.2MHz, -62.0dBm	Single burst
24	16	7.5	266.0	Yes	5573.2MHz, -62.0dBm	Single burst
25	17	7.9	357.0	Yes	5568.2MHz, -62.0dBm	Single burst
26	17	8.4	239.0	Yes	5563.2MHz, -62.0dBm	Single burst
27	18	8.9	286.0	Yes	5558.2MHz, -62.0dBm	Single burst
28	18	9.9	380.0	Yes	5553.2MHz, -62.0dBm	Single burst
29	18	7.6	462.0	Yes	5573.2MHz, -62.0dBm	Single burst
30	18	8.1	354.0	Yes	5568.2MHz, -62.0dBm	Single burst

**Table 51 - FCC Short Pulse Radar (Type 4) Results CU Acquire**

Trial #	Pulses/ Burst	Pulse Width (us)	PRI (us)	Detected	Fr (MHz) and level (dBm)	Burst Information
1	16	11.2	337.0	Yes	5563.2MHz, -62.0dBm	Single burst
2	13	16.0	359.0	Yes	5558.2MHz, -62.0dBm	Single burst
3	16	11.9	248.0	Yes	5553.2MHz, -62.0dBm	Single burst
4	13	15.9	339.0	Yes	5573.2MHz, -62.0dBm	Single burst
5	16	11.7	330.0	Yes	5568.2MHz, -62.0dBm	Single burst
6	15	11.9	367.0	Yes	5563.2MHz, -62.0dBm	Single burst
7	15	14.5	373.0	Yes	5558.2MHz, -62.0dBm	Single burst
8	12	19.8	380.0	Yes	5553.2MHz, -62.0dBm	Single burst
9	15	18.6	449.0	Yes	5573.2MHz, -62.0dBm	Single burst
10	12	12.7	405.0	Yes	5568.2MHz, -62.0dBm	Single burst
11	15	13.1	397.0	Yes	5563.2MHz, -62.0dBm	Single burst
12	13	12.1	451.0	Yes	5558.2MHz, -62.0dBm	Single burst
13	14	19.5	489.0	Yes	5553.2MHz, -62.0dBm	Single burst
14	13	17.0	309.0	Yes	5573.2MHz, -62.0dBm	Single burst
15	14	13.3	449.0	Yes	5568.2MHz, -62.0dBm	Single burst
16	16	13.8	266.0	Yes	5563.2MHz, -62.0dBm	Single burst
17	15	16.1	328.0	Yes	5558.2MHz, -62.0dBm	Single burst
18	15	13.7	467.0	Yes	5553.2MHz, -62.0dBm	Single burst
19	12	17.0	326.0	Yes	5573.2MHz, -62.0dBm	Single burst
20	16	18.9	425.0	Yes	5568.2MHz, -62.0dBm	Single burst
21	16	14.1	321.0	Yes	5563.2MHz, -62.0dBm	Single burst
22	13	15.3	384.0	Yes	5558.2MHz, -62.0dBm	Single burst
23	15	19.8	477.0	Yes	5553.2MHz, -62.0dBm	Single burst
24	14	18.5	461.0	Yes	5573.2MHz, -62.0dBm	Single burst
25	15	16.1	294.0	Yes	5568.2MHz, -62.0dBm	Single burst
26	16	13.9	252.0	Yes	5563.2MHz, -62.0dBm	Single burst
27	12	19.5	300.0	Yes	5558.2MHz, -62.0dBm	Single burst
28	15	12.9	461.0	Yes	5553.2MHz, -62.0dBm	Single burst
29	14	12.3	444.0	Yes	5573.2MHz, -62.0dBm	Single burst
30	16	17.2	298.0	Yes	5568.2MHz, -62.0dBm	Single burst

<b>Table 52 - Long Sequence Waveform Summary WU, CU Acquire Mode High Band</b>		
Long Sequence Trial	Result	Radar Frequency / Amplitude
Trial #1	Detected	5563.2MHz, -62.0dBm
Trial #2	Detected	5558.2MHz, -62.0dBm
Trial #3	Detected	5553.2MHz, -62.0dBm
Trial #4	Detected	5573.2MHz, -62.0dBm
Trial #5	Detected	5568.2MHz, -62.0dBm
Trial #6	Detected	5563.2MHz, -62.0dBm
Trial #7	Detected	5558.2MHz, -62.0dBm
Trial #8	Detected	5553.2MHz, -62.0dBm
Trial #9	Detected	5573.2MHz, -62.0dBm
Trial #10	Detected	5568.2MHz, -62.0dBm
Trial #11	Detected	5563.2MHz, -62.0dBm
Trial #12	Detected	5558.2MHz, -62.0dBm
Trial #13	Detected	5553.2MHz, -62.0dBm
Trial #14	Detected	5573.2MHz, -62.0dBm
Trial #15	Detected	5568.2MHz, -62.0dBm
Trial #16	Detected	5563.2MHz, -62.0dBm
Trial #17	Detected	5558.2MHz, -62.0dBm
Trial #18	Detected	5553.2MHz, -62.0dBm
Trial #19	Detected	5573.2MHz, -62.0dBm
Trial #20	Detected	5568.2MHz, -62.0dBm
Trial #21	Detected	5563.2MHz, -62.0dBm
Trial #22	Detected	5558.2MHz, -62.0dBm
Trial #23	Detected	5553.2MHz, -62.0dBm
Trial #24	Detected	5573.2MHz, -62.0dBm
Trial #25	Detected	5568.2MHz, -62.0dBm
Trial #26	Detected	5563.2MHz, -62.0dBm
Trial #27	Detected	5558.2MHz, -62.0dBm
Trial #28	Detected	5553.2MHz, -62.0dBm
Trial #29	Detected	5573.2MHz, -62.0dBm
Trial #30	Detected	5568.2MHz, -62.0dBm

<b>Table 53 - WU, CU Acquire Mode High Band, Long Sequence Waveform Trial#1 (Detected)</b>						
Burst #	# Pulses	Pulse Width (us)	Chirp (MHz)	Interval 1 to 2 (us)	Interval 2 to 3 (us)	Start time (us)
1	2	62.4	18	1176.0	-	0.347836
2	3	93.6	17	1005.0	1797.0	0.824639
3	1	87.1	6	-	-	1.384581
4	1	99.8	20	-	-	2.015401
5	2	55.4	5	1330.0	-	2.798363
6	1	65.4	12	-	-	3.500033
7	2	77.0	19	1360.0	-	4.212856
8	2	88.6	12	1237.0	-	4.980324
9	1	50.5	19	-	-	5.686727
10	3	60.0	9	1511.0	1191.0	6.451797
11	3	75.6	6	1698.0	1454.0	7.140243
12	1	54.5	15	-	-	7.932374
13	2	72.4	19	1407.0	-	8.471893
14	2	97.7	11	1925.0	-	9.218147
15	2	59.3	18	1880.0	-	9.758476
16	1	97.9	16	-	-	10.292364
17	2	57.9	17	1321.0	-	10.784416
18	2	99.5	9	1582.0	-	11.497379

<b>Table 54 - WU, CU Acquire Mode High Band, Long Sequence Waveform Trial#2 (Detected)</b>						
Burst #	# Pulses	Pulse Width (us)	Chirp (MHz)	Interval 1 to 2 (us)	Interval 2 to 3 (us)	Start time (us)
1	2	59.0	11	1149.0	-	0.041944
2	2	58.9	12	1050.0	-	0.840209
3	3	93.9	19	1976.0	1851.0	1.516272
4	1	97.4	15	-	-	1.952635
5	2	57.9	14	1789.0	-	3.071000
6	1	83.1	12	-	-	3.202277
7	1	99.2	5	-	-	4.331559
8	1	79.3	19	-	-	5.006857
9	2	76.8	11	1461.0	-	5.441744
10	2	61.2	16	1773.0	-	6.012509
11	2	94.6	9	1090.0	-	6.619181
12	3	59.0	15	1814.0	1157.0	7.500879
13	3	85.2	18	1084.0	1326.0	8.177794
14	3	90.2	18	1787.0	1887.0	8.558351
15	2	76.6	19	1970.0	-	9.459990
16	1	97.9	14	-	-	9.746375
17	2	74.0	14	1671.0	-	10.619332
18	3	81.1	7	1242.0	1982.0	11.089670
19	1	96.7	20	-	-	11.618380



**Table 55 - WU, CU Acquire Mode High Band, Long Sequence Waveform Trial#3 (Detected)**

Burst #	# Pulses	Pulse Width (us)	Chirp (MHz)	Interval 1 to 2 (us)	Interval 2 to 3 (us)	Start time (us)
1	2	56.6	12	1002.0	-	0.756092
2	3	85.3	17	1651.0	1711.0	1.375400
3	3	78.8	5	1412.0	1193.0	1.933013
4	2	91.3	5	1800.0	-	3.327224
5	2	79.7	6	1276.0	-	4.540757
6	2	96.2	13	1047.0	-	5.395404
7	1	93.6	9	-	-	5.810408
8	2	79.2	18	1362.0	-	7.024331
9	3	57.2	12	1104.0	1886.0	7.939044
10	2	99.2	5	1831.0	-	8.883776
11	1	97.8	7	-	-	9.352143
12	2	71.3	18	1163.0	-	10.199063
13	3	88.7	12	1344.0	1248.0	11.336611

**Table 56 - WU, CU Acquire Mode High Band, Long Sequence Waveform Trial#4 (Detected)**

Burst #	# Pulses	Pulse Width (us)	Chirp (MHz)	Interval 1 to 2 (us)	Interval 2 to 3 (us)	Start time (us)
1	2	72.2	8	1173.0	-	0.500774
2	1	72.2	13	-	-	1.573598
3	1	79.9	6	-	-	2.885268
4	3	50.6	10	1308.0	1899.0	3.504873
5	2	69.0	12	1916.0	-	4.870408
6	3	90.3	20	1883.0	1342.0	6.392592
7	2	95.9	5	1124.0	-	6.957270
8	2	52.7	7	1764.0	-	8.720971
9	2	66.6	16	1477.0	-	9.316668
10	3	86.3	6	1648.0	1560.0	10.684581
11	3	94.4	11	1649.0	1630.0	11.450059

**Table 57 - WU, CU Acquire Mode High Band, Long Sequence Waveform Trial#5 (Detected)**

Burst #	# Pulses	Pulse Width (us)	Chirp (MHz)	Interval 1 to 2 (us)	Interval 2 to 3 (us)	Start time (us)
1	2	64.9	7	1794.0	-	0.146511
2	3	83.9	7	1778.0	1652.0	2.295686
3	3	56.4	14	1375.0	1630.0	3.416884
4	3	87.6	18	1564.0	1029.0	3.893056
5	3	75.0	19	1612.0	1380.0	5.376274
6	2	63.8	12	1213.0	-	6.914978
7	2	72.5	6	1370.0	-	7.831074
8	2	61.5	12	1272.0	-	8.420390
9	2	69.8	16	1663.0	-	10.521950
10	2	77.0	6	1682.0	-	10.826946

**Table 58 - WU, CU Acquire Mode High Band, Long Sequence Waveform Trial#6 (Detected)**

Burst #	# Pulses	Pulse Width (us)	Chirp (MHz)	Interval 1 to 2 (us)	Interval 2 to 3 (us)	Start time (us)
1	1	92.5	10	-	-	0.316543
2	2	91.2	9	1266.0	-	1.240117
3	3	99.9	16	1674.0	1629.0	2.391708
4	3	77.2	17	1815.0	1176.0	3.224495
5	2	97.8	12	1106.0	-	4.012377
6	2	66.2	18	1790.0	-	5.093117
7	2	79.1	19	1789.0	-	5.768572
8	1	86.0	16	-	-	6.840762
9	3	94.0	9	1634.0	1042.0	7.256116
10	3	66.8	19	1086.0	1161.0	8.147550
11	1	68.8	13	-	-	9.411865
12	1	97.5	8	-	-	10.053707
13	3	73.3	18	1033.0	1419.0	10.400818
14	1	81.4	16	-	-	11.605394

**Table 59 - WU, CU Acquire Mode High Band, Long Sequence Waveform Trial#7 (Detected)**

Burst #	# Pulses	Pulse Width (us)	Chirp (MHz)	Interval 1 to 2 (us)	Interval 2 to 3 (us)	Start time (us)
1	2	63.4	16	1296.0	-	0.355957
2	2	83.9	17	1534.0	-	0.927290
3	2	55.2	20	1182.0	-	1.555972
4	1	79.4	18	-	-	1.943198
5	2	91.2	15	1745.0	-	2.933149
6	2	91.7	10	1459.0	-	3.600868
7	2	68.5	16	1799.0	-	3.867087
8	2	53.9	12	1108.0	-	4.694470
9	3	80.9	9	1622.0	1248.0	5.244385
10	3	93.4	20	1532.0	1495.0	6.008181
11	2	55.7	11	1527.0	-	6.862837
12	2	96.8	5	1635.0	-	7.370094
13	3	53.5	9	1131.0	1318.0	7.721545
14	2	79.1	17	1210.0	-	8.640808
15	2	72.3	10	1948.0	-	9.302126
16	2	97.9	17	1004.0	-	9.733683
17	2	50.0	8	1306.0	-	10.490890
18	1	97.0	7	-	-	11.260234
19	2	81.5	11	1684.0	-	11.407445

**Table 60 - WU, CU Acquire Mode High Band, Long Sequence Waveform Trial#8 (Detected)**

Burst #	# Pulses	Pulse Width (us)	Chirp (MHz)	Interval 1 to 2 (us)	Interval 2 to 3 (us)	Start time (us)
1	2	57.1	16	1569.0	-	0.024079
2	3	84.9	14	1522.0	1036.0	1.120114
3	1	86.1	9	-	-	1.679866
4	2	63.8	7	1218.0	-	2.176484
5	1	56.9	16	-	-	3.074144
6	1	80.5	11	-	-	3.830855
7	3	59.8	14	1889.0	1757.0	4.256750
8	2	84.5	5	1631.0	-	5.348546
9	2	81.4	13	1076.0	-	6.299745
10	1	60.8	19	-	-	6.987409
11	2	50.9	18	1111.0	-	7.583096
12	2	91.2	13	1267.0	-	7.881688
13	2	72.8	19	1562.0	-	8.491213
14	2	94.6	6	1251.0	-	9.816978
15	2	78.4	13	1747.0	-	10.069614
16	2	51.8	7	1659.0	-	10.615549
17	1	72.7	11	-	-	11.329229

**Table 61 - WU, CU Acquire Mode High Band, Long Sequence Waveform Trial#9 (Detected)**

Burst #	# Pulses	Pulse Width (us)	Chirp (MHz)	Interval 1 to 2 (us)	Interval 2 to 3 (us)	Start time (us)
1	3	70.9	16	1039.0	1399.0	0.043154
2	1	82.6	9	-	-	1.012197
3	2	89.3	6	1314.0	-	1.668401
4	2	54.2	17	1791.0	-	2.964744
5	3	57.3	6	1440.0	1766.0	3.298180
6	2	89.8	10	1638.0	-	4.258434
7	1	98.7	20	-	-	4.710079
8	3	82.8	10	1820.0	1528.0	5.809217
9	2	55.4	18	1401.0	-	6.427891
10	1	60.8	18	-	-	7.101136
11	2	78.7	5	1132.0	-	7.965752
12	2	89.0	9	1317.0	-	8.446083
13	2	83.0	12	1932.0	-	9.715279
14	3	69.5	13	1875.0	1669.0	10.391753
15	3	82.7	7	1990.0	1618.0	10.692823
16	2	52.6	7	1816.0	-	11.412655

<b>Table 62 - WU, CU Acquire Mode High Band, Long Sequence Waveform Trial#10 (Detected)</b>						
Burst #	# Pulses	Pulse Width (us)	Chirp (MHz)	Interval 1 to 2 (us)	Interval 2 to 3 (us)	Start time (us)
1	2	50.7	16	1364.0	-	0.778923
2	1	99.6	13	-	-	1.510918
3	2	50.9	12	1138.0	-	1.770214
4	2	62.6	13	1898.0	-	3.010462
5	2	80.7	10	1601.0	-	3.667408
6	3	88.1	7	1988.0	1658.0	4.016094
7	2	81.8	17	1434.0	-	4.945608
8	3	57.4	18	1509.0	1680.0	5.682549
9	1	64.9	16	-	-	6.417387
10	1	87.1	17	-	-	7.940195
11	2	63.5	19	1678.0	-	8.189272
12	2	65.4	12	1206.0	-	9.201598
13	1	74.8	5	-	-	10.335020
14	2	74.8	10	1280.0	-	11.017120
15	2	90.8	11	1281.0	-	11.559003

<b>Table 63 - WU, CU Acquire Mode High Band, Long Sequence Waveform Trial#11 (Detected)</b>						
Burst #	# Pulses	Pulse Width (us)	Chirp (MHz)	Interval 1 to 2 (us)	Interval 2 to 3 (us)	Start time (us)
1	2	56.8	19	1171.0	-	0.212581
2	1	54.5	6	-	-	1.008158
3	2	94.0	12	1165.0	-	1.645023
4	3	53.5	10	1908.0	1246.0	2.305846
5	2	78.9	10	1717.0	-	3.289151
6	2	71.7	10	1473.0	-	3.992663
7	2	60.4	20	1678.0	-	4.860160
8	3	64.5	11	1049.0	1861.0	5.171265
9	2	69.1	19	1403.0	-	6.219667
10	2	94.2	15	1771.0	-	6.995790
11	3	94.3	5	1066.0	1041.0	7.376178
12	1	91.9	14	-	-	8.310933
13	1	59.9	14	-	-	8.610789
14	3	74.8	17	1857.0	1645.0	9.728762
15	2	93.7	7	1699.0	-	10.077462
16	1	84.4	11	-	-	11.114254
17	3	84.4	7	1847.0	1102.0	11.642822

Burst #	# Pulses	Pulse Width (us)	Chirp (MHz)	Interval 1 to 2 (us)	Interval 2 to 3 (us)	Start time (us)
1	2	66.4	15	1057.0	-	0.090667
2	3	68.3	20	1389.0	1623.0	2.910707
3	3	72.2	19	1740.0	1022.0	3.481647
4	3	88.8	13	1502.0	1119.0	5.777592
5	2	98.8	15	1767.0	-	6.069496
6	2	57.1	19	1741.0	-	7.634281
7	3	98.7	8	1268.0	1951.0	10.388739
8	1	75.9	10	-	-	11.494633

Burst #	# Pulses	Pulse Width (us)	Chirp (MHz)	Interval 1 to 2 (us)	Interval 2 to 3 (us)	Start time (us)
1	2	59.3	19	1831.0	-	0.474146
2	3	74.5	11	1081.0	1905.0	1.019795
3	2	83.0	18	1914.0	-	1.747725
4	2	80.7	14	1815.0	-	2.290284
5	2	79.1	16	1475.0	-	3.213871
6	3	74.9	20	1767.0	1277.0	3.900836
7	2	85.5	18	1827.0	-	5.034382
8	2	86.8	8	1440.0	-	5.918558
9	2	73.0	14	1633.0	-	6.174490
10	2	86.3	17	1376.0	-	6.788308
11	1	79.2	18	-	-	7.756345
12	1	81.9	9	-	-	8.815536
13	2	81.0	18	1566.0	-	9.031770
14	3	87.2	19	1207.0	1648.0	10.091145
15	2	88.8	16	1720.0	-	10.692943
16	2	52.9	11	1252.0	-	11.400848

Burst #	# Pulses	Pulse Width (us)	Chirp (MHz)	Interval 1 to 2 (us)	Interval 2 to 3 (us)	Start time (us)
1	1	63.6	13	-	-	0.257644
2	2	56.1	10	1459.0	-	1.434642
3	3	94.9	6	1096.0	1370.0	2.465284
4	1	62.8	15	-	-	3.897227
5	3	98.0	17	1694.0	1018.0	4.651282
6	2	75.3	11	1406.0	-	5.841842
7	2	86.1	12	1965.0	-	6.053915
8	2	54.4	10	1669.0	-	7.083264
9	2	54.3	14	1178.0	-	8.154318
10	2	87.2	7	1877.0	-	9.254723
11	3	72.7	14	1019.0	1113.0	10.164057
12	2	75.4	17	1511.0	-	11.966450

Burst #	# Pulses	Pulse Width (us)	Chirp (MHz)	Interval 1 to 2 (us)	Interval 2 to 3 (us)	Start time (us)
1	1	65.1	7	-	-	0.233433
2	2	60.8	18	1987.0	-	1.172439
3	1	75.8	18	-	-	1.496712
4	3	94.0	7	1253.0	1923.0	2.523655
5	3	98.3	9	1241.0	1447.0	3.054807
6	2	79.7	8	1694.0	-	3.848073
7	3	51.9	11	1001.0	1837.0	4.869933
8	3	61.2	17	1888.0	1936.0	5.392445
9	2	78.0	13	1558.0	-	6.196790
10	2	97.7	20	1991.0	-	6.983776
11	1	74.5	16	-	-	7.241286
12	2	84.8	17	1510.0	-	8.451908
13	3	80.0	12	1726.0	1281.0	8.786144
14	2	78.2	5	1908.0	-	9.505662
15	2	68.0	11	1060.0	-	10.548015
16	1	94.4	16	-	-	11.087126
17	2	56.8	20	1821.0	-	11.611359

Burst #	# Pulses	Pulse Width (us)	Chirp (MHz)	Interval 1 to 2 (us)	Interval 2 to 3 (us)	Start time (us)
1	3	71.5	13	1814.0	1864.0	0.886798
2	1	96.5	16	-	-	1.074995
3	1	95.1	8	-	-	2.229720
4	2	67.6	12	1779.0	-	3.378453
5	1	73.4	15	-	-	4.740732
6	1	98.4	13	-	-	5.852554
7	2	80.5	20	1495.0	-	6.217442
8	2	62.4	7	1536.0	-	7.140092
9	3	56.5	10	1979.0	1164.0	8.027549
10	2	58.8	12	1245.0	-	9.946356
11	2	50.2	8	1549.0	-	10.130749
12	2	96.5	16	1438.0	-	11.081777

Burst #	# Pulses	Pulse Width (us)	Chirp (MHz)	Interval 1 to 2 (us)	Interval 2 to 3 (us)	Start time (us)
1	2	68.7	15	1049.0	-	0.723651
2	3	84.6	13	1699.0	1788.0	2.096508
3	2	75.9	9	1135.0	-	3.186918
4	1	71.3	9	-	-	4.276303
5	1	74.5	17	-	-	6.175581
6	1	98.2	10	-	-	7.677170
7	1	62.6	18	-	-	8.248136
8	3	78.4	9	1886.0	1038.0	10.281043
9	2	59.1	14	1264.0	-	10.887839

Burst #	# Pulses	Pulse Width (us)	Chirp (MHz)	Interval 1 to 2 (us)	Interval 2 to 3 (us)	Start time (us)
1	2	64.3	19	1489.0	-	0.911448
2	1	75.3	8	-	-	2.298043
3	3	54.5	15	1806.0	1091.0	3.329823
4	2	52.7	10	1476.0	-	4.358083
5	2	53.5	10	1495.0	-	5.345039
6	3	69.3	18	1176.0	1141.0	7.124262
7	2	76.8	8	1519.0	-	7.931352
8	2	55.8	12	1871.0	-	8.845419
9	1	61.1	14	-	-	10.356503
10	1	54.7	16	-	-	11.006417

Burst #	# Pulses	Pulse Width (us)	Chirp (MHz)	Interval 1 to 2 (us)	Interval 2 to 3 (us)	Start time (us)
1	2	88.5	20	1045.0	-	0.523347
2	3	64.9	17	1223.0	1917.0	0.842569
3	1	72.7	13	-	-	1.795922
4	1	61.8	15	-	-	2.449964
5	3	85.6	6	1771.0	1620.0	3.180805
6	2	60.4	20	1490.0	-	4.165516
7	1	74.5	14	-	-	4.787946
8	1	96.2	10	-	-	5.555734
9	1	58.4	10	-	-	6.301502
10	1	76.6	19	-	-	7.125665
11	2	60.3	11	1124.0	-	7.599981
12	3	93.2	12	1780.0	1420.0	8.555531
13	1	93.1	16	-	-	9.493583
14	3	83.1	12	1974.0	1869.0	9.892070
15	2	56.5	7	1214.0	-	10.644477
16	3	91.3	13	1015.0	1860.0	11.490773

Burst #	# Pulses	Pulse Width (us)	Chirp (MHz)	Interval 1 to 2 (us)	Interval 2 to 3 (us)	Start time (us)
1	2	81.8	7	1827.0	-	1.402941
2	1	92.8	5	-	-	1.817958
3	1	100.0	19	-	-	4.267887
4	3	57.1	18	1039.0	1715.0	5.543820
5	2	60.4	9	1681.0	-	6.350299
6	2	60.0	9	1158.0	-	7.530968
7	3	73.2	16	1510.0	1545.0	9.678836
8	2	86.4	13	1711.0	-	11.596334

Burst #	# Pulses	Pulse Width (us)	Chirp (MHz)	Interval 1 to 2 (us)	Interval 2 to 3 (us)	Start time (us)
1	2	72.2	6	1356.0	-	0.312198
2	3	71.1	13	1960.0	1568.0	1.151116
3	2	90.7	19	1644.0	-	1.888580
4	3	66.3	14	1515.0	1456.0	2.629552
5	3	58.1	6	1575.0	1520.0	2.931518
6	2	53.8	11	1316.0	-	3.341101
7	3	79.3	16	1310.0	1636.0	4.014518
8	3	82.0	10	1745.0	1573.0	5.180587
9	2	96.6	11	1504.0	-	5.551248
10	3	93.5	13	1297.0	1479.0	6.093375
11	3	89.7	13	1880.0	1175.0	6.968038
12	2	74.6	5	1795.0	-	7.421618
13	1	58.7	19	-	-	8.317649
14	2	55.4	10	1642.0	-	8.738971
15	2	88.4	7	1943.0	-	9.805280
16	3	76.1	15	1105.0	1888.0	10.514454
17	1	62.0	8	-	-	11.214967
18	2	88.2	12	1127.0	-	11.891140

Burst #	# Pulses	Pulse Width (us)	Chirp (MHz)	Interval 1 to 2 (us)	Interval 2 to 3 (us)	Start time (us)
1	3	100.0	16	1172.0	1061.0	0.099178
2	1	82.2	9	-	-	1.912681
3	2	59.7	6	1847.0	-	2.476653
4	3	94.8	18	1808.0	1268.0	3.600569
5	2	55.8	14	1679.0	-	4.615755
6	2	92.8	19	1965.0	-	6.536469
7	3	74.4	12	1827.0	1820.0	7.294082
8	1	56.4	20	-	-	7.651810
9	3	71.4	14	1696.0	1409.0	8.814597
10	2	51.8	15	1241.0	-	10.595164
11	3	75.4	16	1987.0	1487.0	11.230158



Burst #	# Pulses	Pulse Width (us)	Chirp (MHz)	Interval 1 to 2 (us)	Interval 2 to 3 (us)	Start time (us)
1	1	94.4	11	-	-	0.721520
2	2	56.5	14	1285.0	-	1.038495
3	2	75.7	14	1198.0	-	2.107789
4	3	75.5	13	1553.0	1602.0	2.581483
5	3	97.0	9	1401.0	1297.0	3.933949
6	3	62.1	7	1127.0	1067.0	4.729005
7	3	83.9	7	1064.0	1831.0	5.081710
8	1	72.3	9	-	-	5.987360
9	2	66.3	11	1057.0	-	7.045321
10	3	71.2	17	1628.0	1690.0	7.829280
11	2	62.9	15	1412.0	-	8.506778
12	2	74.0	13	1477.0	-	9.307956
13	2	76.2	18	1500.0	-	10.170140
14	2	81.2	10	1086.0	-	10.620484
15	3	85.0	15	1932.0	1091.0	11.519813

Burst #	# Pulses	Pulse Width (us)	Chirp (MHz)	Interval 1 to 2 (us)	Interval 2 to 3 (us)	Start time (us)
1	2	60.1	17	1218.0	-	0.475742
2	1	91.9	13	-	-	2.315173
3	3	68.3	10	1273.0	1859.0	2.402989
4	2	98.1	14	1660.0	-	4.436586
5	3	51.6	10	1662.0	1405.0	5.152021
6	2	55.3	11	1470.0	-	6.346730
7	2	68.9	16	1381.0	-	7.708761
8	2	71.5	14	1299.0	-	9.382664
9	2	61.1	13	1995.0	-	10.044515
10	2	92.6	7	1574.0	-	11.786171

Burst #	# Pulses	Pulse Width (us)	Chirp (MHz)	Interval 1 to 2 (us)	Interval 2 to 3 (us)	Start time (us)
1	3	75.6	7	1720.0	1403.0	0.064661
2	2	53.3	18	1507.0	-	0.686987
3	2	68.8	16	1667.0	-	1.335671
4	2	88.5	19	1704.0	-	2.492389
5	1	64.0	19	-	-	2.807667
6	2	54.2	9	1796.0	-	3.218718
7	3	55.7	15	1235.0	1525.0	4.286147
8	2	77.8	12	1915.0	-	4.716742
9	1	89.7	10	-	-	5.090499
10	2	64.5	9	1434.0	-	5.768991
11	1	67.6	19	-	-	6.913081
12	1	67.0	7	-	-	7.285092
13	2	80.8	14	1713.0	-	7.770167
14	2	88.0	12	1208.0	-	8.712238
15	2	54.6	9	1716.0	-	9.382007
16	2	85.9	10	1955.0	-	9.611411
17	3	92.6	9	1636.0	1626.0	10.495069
18	3	70.0	10	1220.0	1420.0	11.114862
19	3	73.1	14	1454.0	1281.0	11.441587

Burst #	# Pulses	Pulse Width (us)	Chirp (MHz)	Interval 1 to 2 (us)	Interval 2 to 3 (us)	Start time (us)
1	3	76.1	17	1422.0	1392.0	0.100223
2	1	59.4	19	-	-	1.099134
3	2	93.0	13	1440.0	-	2.304894
4	2	94.1	17	1806.0	-	2.534988
5	1	56.1	11	-	-	3.300070
6	2	91.7	7	1724.0	-	4.497558
7	2	83.5	11	1208.0	-	5.418434
8	2	85.3	8	1195.0	-	5.962520
9	2	74.8	14	1717.0	-	6.859762
10	2	90.5	14	1488.0	-	7.748117
11	3	91.4	13	1148.0	1845.0	8.770299
12	2	71.2	14	1076.0	-	9.160132
13	2	54.9	15	1987.0	-	10.341043
14	1	61.7	11	-	-	11.092956
15	2	54.6	10	1903.0	-	11.663741

Burst #	# Pulses	Pulse Width (us)	Chirp (MHz)	Interval 1 to 2 (us)	Interval 2 to 3 (us)	Start time (us)
1	2	89.7	5	1539.0	-	0.604509
2	2	52.2	18	1929.0	-	0.974349
3	2	70.5	7	1916.0	-	1.694851
4	1	58.1	20	-	-	2.254843
5	2	76.2	5	1274.0	-	3.140492
6	2	54.6	12	1306.0	-	3.824295
7	2	64.0	14	1189.0	-	4.801686
8	2	63.5	18	1667.0	-	5.909035
9	2	83.2	13	1227.0	-	6.029693
10	3	74.8	7	1748.0	1097.0	6.903287
11	1	57.0	8	-	-	7.561899
12	1	92.3	10	-	-	8.758749
13	2	79.5	19	1262.0	-	9.104217
14	2	76.1	14	1516.0	-	10.261457
15	2	56.3	14	1267.0	-	10.688382
16	1	82.0	16	-	-	11.306618

Burst #	# Pulses	Pulse Width (us)	Chirp (MHz)	Interval 1 to 2 (us)	Interval 2 to 3 (us)	Start time (us)
1	1	87.2	10	-	-	0.559777
2	2	72.7	9	1229.0	-	1.051107
3	3	79.6	6	1193.0	1928.0	1.356156
4	1	68.5	12	-	-	2.318455
5	2	58.3	9	1094.0	-	3.312651
6	2	88.2	15	1579.0	-	3.852643
7	1	96.4	14	-	-	4.282255
8	1	82.5	10	-	-	4.969705
9	2	87.8	7	1136.0	-	5.854049
10	2	88.6	15	1382.0	-	6.021338
11	2	76.0	18	1818.0	-	7.259055
12	2	54.5	15	1822.0	-	7.433971
13	3	90.0	16	1670.0	1509.0	8.157510
14	2	85.1	19	1668.0	-	8.752846
15	2	75.3	8	1560.0	-	9.996304
16	2	88.2	18	1011.0	-	10.028002
17	2	78.6	14	1097.0	-	10.836762
18	2	98.8	8	1977.0	-	11.593966

Burst #	# Pulses	Pulse Width (us)	Chirp (MHz)	Interval 1 to 2 (us)	Interval 2 to 3 (us)	Start time (us)
1	2	78.0	14	1270.0	-	0.056421
2	3	84.7	11	1277.0	1190.0	0.835841
3	3	73.7	17	1961.0	1885.0	1.312583
4	2	55.6	13	1902.0	-	2.084539
5	2	80.8	9	1881.0	-	2.871601
6	3	65.4	15	1329.0	1183.0	3.055492
7	2	71.0	15	1410.0	-	3.835286
8	2	99.9	7	1798.0	-	4.642296
9	3	84.1	6	1186.0	1346.0	4.856748
10	3	58.8	18	1708.0	1528.0	5.543431
11	3	57.0	10	1989.0	1795.0	6.436879
12	1	74.9	15	-	-	7.059542
13	3	63.3	7	1849.0	1327.0	7.745465
14	3	85.5	15	1603.0	1877.0	8.228581
15	3	61.2	6	1601.0	1555.0	8.980305
16	2	53.2	16	1518.0	-	9.181498
17	3	99.6	14	1555.0	1240.0	9.768298
18	1	77.4	15	-	-	10.775456
19	3	93.0	19	1925.0	1610.0	10.857355
20	2	89.1	15	1133.0	-	11.494330

Burst #	# Pulses	Pulse Width (us)	Chirp (MHz)	Interval 1 to 2 (us)	Interval 2 to 3 (us)	Start time (us)
1	3	73.3	18	1983.0	1233.0	0.046096
2	1	84.6	12	-	-	1.695643
3	2	73.7	11	1975.0	-	2.171519
4	1	72.1	15	-	-	3.431168
5	2	53.1	6	1478.0	-	4.484768
6	2	76.8	16	1833.0	-	5.669116
7	2	62.0	13	1370.0	-	6.082700
8	2	61.1	18	1647.0	-	7.058699
9	2	88.6	13	1565.0	-	8.618205
10	2	53.1	15	1476.0	-	9.634052
11	2	80.7	14	1873.0	-	10.529712
12	1	67.7	14	-	-	11.279434

Table 83 - FCC frequency hopping radar (Type 6) Results, WU, CU Acquire Mode High Band						
Trial #	Pulses/ Burst	Pulse Width (us)	PRI (us)	Detected	Fr (MHz) and level (dBm)	Burst Information
1	9	1.0	333.0	Yes	5579.2MHz, -62.0dBm	Hop sequence: 5368, 5272, 5441, 5392, 5645, 5643, 5563, 5501, 5628, 5499, 5724, 5568, 5350, 5251, 5602, 5385, 5522, 5536, 5327, 5639, 5509, 5287, 5295, 5316, 5569, 5631, 5599, 5427, 5367, 5267, 5336, 5589, 5309, 5725, 5581, 5473, 5446, 5413, 5401, 5612, 5322, 5534, 5647, 5450, 5596, 5269, 5672, 5489, 5398, 5318, 5662, 5511, 5494, 5370, 5507, 5378, 5333, 5302, 5346, 5554, 5698, 5618, 5546, 5477, 5437, 5432, 5296, 5605, 5276, 5260, 5481, 5381, 5579, 5291, 5541, 5495, 5447, 5409, 5606, 5280, 5445, 5684, 5483, 5453, 5470, 5586, 5436, 5518, 5415, 5673, 5500, 5722, 5635, 5478, 5311, 5341, 5475, 5693, 5429, 5610 (5 hits) (03/26/2012 11:39:04 AM)
2	9	1.0	333.0	Yes	5580.2MHz, -62.0dBm	Hop sequence: 5488, 5723, 5321, 5693, 5315, 5646, 5382, 5396, 5716, 5410, 5253, 5459, 5343, 5329, 5571, 5581, 5685, 5275, 5313, 5297, 5350, 5406, 5625, 5578, 5677, 5264, 5725, 5254, 5301, 5469, 5664, 5371, 5644, 5626, 5665, 5697, 5668, 5376, 5320, 5712, 5491, 5650, 5387, 5669, 5635, 5692, 5416, 5370, 5577, 5472, 5357, 5375, 5674, 5583, 5575, 5423, 5589, 5471, 5614, 5617, 5624, 5620, 5279, 5428, 5328, 5530, 5460, 5654, 5302, 5497, 5474, 5602, 5436, 5594, 5657, 5630, 5561, 5684, 5340, 5588, 5388, 5570, 5532, 5399, 5645, 5558, 5523, 5609, 5456, 5425, 5521, 5318, 5332, 5383, 5660, 5348, 5492, 5342, 5509, 5719 (7 hits) (03/26/2012 11:39:14 AM)
3	9	1.0	333.0	Yes	5547.2MHz, -62.0dBm	Hop sequence: 5653, 5453, 5327, 5608, 5633, 5397, 5514, 5624, 5478, 5282, 5358, 5577, 5699, 5515, 5716, 5680, 5480, 5372, 5278, 5530, 5555, 5438, 5654, 5354, 5254, 5473, 5342, 5587, 5521, 5511, 5659, 5315, 5599, 5384, 5412, 5636, 5585, 5693, 5575, 5611, 5455, 5601, 5299, 5256, 5677, 5542, 5508, 5287,

Table 83 - FCC frequency hopping radar (Type 6) Results, WU, CU Acquire Mode High Band						
Trial #	Pulses/ Burst	Pulse Width (us)	PRI (us)	Detected	Fr (MHz) and level (dBm)	Burst Information
						5561, 5381, 5421, 5646, 5668, 5717, 5640, 5678, 5394, 5449, 5531, 5651, 5613, 5324, 5368, 5311, 5662, 5364, 5492, 5321, 5295, 5663, 5644, 5312, 5488, 5476, 5682, 5721, 5617, 5526, 5715, 5590, 5695, 5597, 5279, 5388, 5552, 5396, 5395, 5509, 5440, 5357, 5458, 5391, 5298, 5380, 5386, 5376, 5340, 5444, 5629, 5288 (5 hits) (03/26/2012 11:39:22 AM)
4	9	1.0	333.0	Yes	5548.2MHz, -62.0dBm	Hop sequence: 5517, 5431, 5306, 5709, 5711, 5292, 5461, 5691, 5642, 5718, 5340, 5611, 5473, 5588, 5355, 5626, 5657, 5596, 5319, 5260, 5587, 5268, 5269, 5408, 5511, 5500, 5715, 5326, 5679, 5317, 5402, 5438, 5380, 5632, 5554, 5490, 5460, 5295, 5570, 5384, 5383, 5636, 5372, 5412, 5712, 5391, 5329, 5557, 5519, 5480, 5699, 5270, 5716, 5641, 5508, 5316, 5639, 5349, 5541, 5296, 5725, 5714, 5513, 5437, 5577, 5717, 5279, 5453, 5510, 5584, 5300, 5645, 5682, 5593, 5332, 5569, 5405, 5604, 5477, 5429, 5341, 5713, 5619, 5403, 5558, 5354, 5624, 5425, 5616, 5351, 5664, 5509, 5722, 5505, 5478, 5474, 5435, 5472, 5430, 5285 (6 hits) (03/26/2012 11:39:31 AM)
5	9	1.0	333.0	Yes	5549.2MHz, -62.0dBm	Hop sequence: 5440, 5397, 5326, 5367, 5435, 5386, 5664, 5392, 5713, 5556, 5332, 5434, 5394, 5540, 5604, 5315, 5572, 5328, 5423, 5416, 5645, 5658, 5659, 5481, 5531, 5489, 5458, 5269, 5391, 5477, 5522, 5334, 5486, 5371, 5398, 5662, 5491, 5709, 5644, 5666, 5445, 5661, 5405, 5542, 5266, 5474, 5681, 5293, 5593, 5441, 5673, 5509, 5640, 5523, 5299, 5443, 5253, 5281, 5284, 5573, 5499, 5273, 5574, 5322, 5643, 5500, 5276, 5357, 5358, 5554, 5718, 5325, 5560, 5502, 5546, 5690, 5652, 5280, 5410, 5599, 5296, 5521, 5634, 5520, 5496, 5536, 5250, 5615, 5298, 5724, 5362, 5415, 5411, 5254, 5642, 5606, 5282, 5261, 5581, 5461 (6 hits) (03/26/2012

Table 83 - FCC frequency hopping radar (Type 6) Results, WU, CU Acquire Mode High Band						
Trial #	Pulses/ Burst	Pulse Width (us)	PRI (us)	Detected	Fr (MHz) and level (dBm)	Burst Information
						11:39:38 AM)
6	9	1.0	333.0	Yes	5550.2MHz, -62.0dBm	Hop sequence: 5299, 5473, 5290, 5719, 5506, 5430, 5325, 5328, 5333, 5363, 5700, 5257, 5484, 5535, 5260, 5595, 5314, 5650, 5676, 5502, 5658, 5550, 5669, 5631, 5561, 5539, 5660, 5272, 5511, 5476, 5372, 5498, 5619, 5552, 5545, 5478, 5389, 5633, 5699, 5701, 5296, 5437, 5464, 5589, 5494, 5610, 5436, 5576, 5415, 5416, 5485, 5640, 5712, 5351, 5573, 5600, 5398, 5553, 5577, 5292, 5526, 5705, 5659, 5662, 5408, 5562, 5419, 5347, 5365, 5426, 5386, 5578, 5639, 5686, 5472, 5582, 5683, 5624, 5593, 5538, 5255, 5317, 5723, 5698, 5638, 5394, 5605, 5565, 5495, 5666, 5567, 5574, 5599, 5380, 5369, 5364, 5446, 5300, 5661, 5331 (12 hits) (03/26/2012 11:39:46 AM)
7	9	1.0	333.0	Yes	5551.2MHz, -62.0dBm	Hop sequence: 5352, 5307, 5358, 5521, 5487, 5367, 5371, 5428, 5702, 5302, 5557, 5588, 5674, 5409, 5426, 5495, 5638, 5642, 5605, 5456, 5563, 5664, 5524, 5714, 5411, 5323, 5679, 5461, 5365, 5507, 5615, 5678, 5348, 5266, 5276, 5362, 5255, 5636, 5698, 5550, 5447, 5509, 5657, 5261, 5535, 5715, 5518, 5565, 5544, 5473, 5648, 5315, 5617, 5692, 5392, 5412, 5585, 5479, 5398, 5684, 5336, 5326, 5391, 5537, 5665, 5466, 5407, 5424, 5291, 5310, 5567, 5429, 5725, 5542, 5551, 5653, 5267, 5321, 5671, 5434, 5643, 5632, 5369, 5438, 5340, 5480, 5460, 5717, 5719, 5590, 5511, 5420, 5623, 5647, 5272, 5313, 5482, 5335, 5505, 5471 (6 hits) (03/26/2012 11:39:57 AM)
8	9	1.0	333.0	Yes	5552.2MHz, -62.0dBm	Hop sequence: 5410, 5253, 5528, 5706, 5544, 5309, 5349, 5595, 5354, 5570, 5660, 5541, 5257, 5620, 5514, 5482, 5635, 5540, 5721, 5509, 5485, 5501, 5652, 5304, 5583, 5577, 5496, 5339, 5286, 5444, 5371, 5702, 5431, 5697, 5316, 5259, 5568, 5502, 5532, 5441, 5353, 5284, 5281, 5433, 5499, 5265, 5329, 5372,

Table 83 - FCC frequency hopping radar (Type 6) Results, WU, CU Acquire Mode High Band						
Trial #	Pulses/ Burst	Pulse Width (us)	PRI (us)	Detected	Fr (MHz) and level (dBm)	Burst Information
						5377, 5551, 5305, 5662, 5397, 5356, 5403, 5345, 5563, 5461, 5464, 5332, 5328, 5712, 5366, 5322, 5599, 5674, 5251, 5718, 5481, 5264, 5435, 5645, 5530, 5622, 5682, 5279, 5601, 5434, 5382, 5586, 5708, 5546, 5425, 5576, 5406, 5642, 5676, 5519, 5420, 5490, 5488, 5639, 5719, 5600, 5448, 5462, 5471, 5299, 5520, 5385 (6 hits) (03/26/2012 11:40:04 AM)
9	9	1.0	333.0	Yes	5553.2MHz, -62.0dBm	Hop sequence: 5685, 5618, 5452, 5314, 5679, 5372, 5444, 5428, 5315, 5629, 5639, 5442, 5425, 5261, 5681, 5375, 5610, 5493, 5529, 5530, 5643, 5541, 5538, 5575, 5501, 5678, 5254, 5311, 5460, 5596, 5616, 5339, 5265, 5559, 5537, 5449, 5297, 5439, 5710, 5627, 5406, 5650, 5718, 5634, 5714, 5457, 5436, 5694, 5657, 5316, 5285, 5625, 5346, 5423, 5699, 5682, 5713, 5272, 5275, 5398, 5611, 5692, 5485, 5687, 5386, 5702, 5489, 5686, 5614, 5539, 5360, 5344, 5564, 5403, 5302, 5570, 5370, 5609, 5447, 5276, 5615, 5329, 5295, 5689, 5577, 5379, 5640, 5488, 5561, 5283, 5491, 5430, 5656, 5336, 5433, 5443, 5647, 5567, 5330, 5496 (7 hits) (03/26/2012 11:40:17 AM)
10	9	1.0	333.0	Yes	5554.2MHz, -62.0dBm	Hop sequence: 5707, 5574, 5461, 5468, 5488, 5278, 5384, 5406, 5475, 5375, 5362, 5369, 5517, 5703, 5401, 5516, 5265, 5325, 5494, 5474, 5634, 5261, 5628, 5523, 5553, 5428, 5300, 5663, 5577, 5372, 5319, 5673, 5486, 5355, 5472, 5520, 5562, 5543, 5467, 5282, 5396, 5566, 5337, 5586, 5578, 5410, 5535, 5662, 5356, 5582, 5550, 5612, 5438, 5518, 5510, 5296, 5340, 5367, 5604, 5497, 5650, 5503, 5531, 5607, 5317, 5283, 5506, 5263, 5380, 5450, 5537, 5670, 5588, 5679, 5524, 5509, 5507, 5685, 5421, 5277, 5519, 5621, 5684, 5329, 5690, 5313, 5714, 5592, 5392, 5341, 5307, 5630, 5645, 5542, 5560, 5591, 5287, 5425, 5529, 5589 (8 hits) (03/26/2012



Table 83 - FCC frequency hopping radar (Type 6) Results, WU, CU Acquire Mode High Band						
Trial #	Pulses/ Burst	Pulse Width (us)	PRI (us)	Detected	Fr (MHz) and level (dBm)	Burst Information
						11:40:24 AM)
11	9	1.0	333.0	Yes	5555.2MHz, -62.0dBm	Hop sequence: 5538, 5594, 5351, 5718, 5425, 5681, 5415, 5572, 5356, 5501, 5386, 5325, 5281, 5725, 5383, 5705, 5529, 5655, 5277, 5557, 5682, 5664, 5575, 5471, 5509, 5653, 5454, 5374, 5257, 5395, 5484, 5616, 5603, 5399, 5544, 5362, 5706, 5606, 5341, 5436, 5696, 5320, 5683, 5314, 5401, 5723, 5487, 5371, 5282, 5381, 5429, 5505, 5396, 5639, 5532, 5722, 5466, 5433, 5686, 5614, 5700, 5618, 5695, 5560, 5353, 5680, 5679, 5317, 5448, 5641, 5469, 5449, 5393, 5323, 5337, 5344, 5464, 5595, 5276, 5443, 5250, 5427, 5321, 5336, 5668, 5316, 5329, 5568, 5360, 5497, 5567, 5593, 5583, 5582, 5297, 5643, 5591, 5724, 5673, 5271 (6 hits) (03/26/2012 11:40:30 AM)
12	9	1.0	333.0	Yes	5556.2MHz, -62.0dBm	Hop sequence: 5721, 5452, 5585, 5653, 5637, 5474, 5421, 5430, 5648, 5557, 5558, 5395, 5341, 5619, 5531, 5331, 5376, 5671, 5408, 5660, 5498, 5315, 5330, 5274, 5451, 5434, 5477, 5709, 5644, 5673, 5570, 5413, 5457, 5552, 5692, 5462, 5510, 5546, 5394, 5320, 5658, 5536, 5391, 5335, 5314, 5390, 5263, 5449, 5714, 5459, 5647, 5378, 5264, 5687, 5432, 5437, 5533, 5680, 5661, 5528, 5346, 5276, 5372, 5574, 5349, 5454, 5604, 5578, 5485, 5491, 5441, 5494, 5616, 5460, 5490, 5422, 5362, 5608, 5267, 5529, 5700, 5532, 5696, 5514, 5567, 5299, 5385, 5270, 5382, 5513, 5591, 5350, 5371, 5657, 5480, 5484, 5448, 5269, 5666, 5463 (7 hits) (03/26/2012 11:40:37 AM)
13	9	1.0	333.0	Yes	5557.2MHz, -62.0dBm	Hop sequence: 5527, 5413, 5430, 5515, 5366, 5526, 5662, 5709, 5566, 5697, 5435, 5578, 5329, 5389, 5606, 5449, 5322, 5505, 5618, 5409, 5270, 5663, 5596, 5362, 5333, 5419, 5588, 5337, 5520, 5546, 5387, 5286, 5553, 5276, 5666, 5561, 5604, 5576, 5311, 5364, 5532, 5503, 5405, 5582, 5545, 5688, 5512, 5667,

Table 83 - FCC frequency hopping radar (Type 6) Results, WU, CU Acquire Mode High Band						
Trial #	Pulses/ Burst	Pulse Width (us)	PRI (us)	Detected	Fr (MHz) and level (dBm)	Burst Information
						5253, 5345, 5472, 5501, 5355, 5447, 5445, 5428, 5398, 5625, 5633, 5715, 5677, 5410, 5674, 5421, 5681, 5358, 5672, 5285, 5689, 5719, 5725, 5263, 5589, 5552, 5653, 5452, 5614, 5392, 5432, 5269, 5294, 5696, 5548, 5458, 5641, 5417, 5572, 5554, 5685, 5431, 5336, 5507, 5605, 5456, 5359, 5307, 5334, 5284, 5251, 5300 (9 hits) (03/26/2012 11:40:43 AM)
14	9	1.0	333.0	Yes	5558.2MHz, -62.0dBm	Hop sequence: 5257, 5520, 5685, 5450, 5476, 5368, 5605, 5500, 5698, 5272, 5334, 5664, 5428, 5684, 5433, 5601, 5387, 5531, 5303, 5709, 5276, 5320, 5327, 5712, 5317, 5536, 5488, 5401, 5354, 5610, 5409, 5694, 5703, 5494, 5551, 5723, 5342, 5389, 5696, 5590, 5639, 5414, 5630, 5562, 5365, 5651, 5355, 5425, 5532, 5441, 5620, 5418, 5666, 5614, 5308, 5287, 5373, 5501, 5315, 5700, 5554, 5571, 5344, 5352, 5641, 5299, 5713, 5448, 5284, 5707, 5503, 5278, 5660, 5546, 5369, 5556, 5405, 5645, 5446, 5640, 5358, 5447, 5568, 5565, 5408, 5431, 5474, 5711, 5332, 5608, 5586, 5658, 5502, 5375, 5596, 5577, 5634, 5263, 5304, 5607 (8 hits) (03/26/2012 11:40:50 AM)
15	9	1.0	333.0	Yes	5559.2MHz, -62.0dBm	Hop sequence: 5450, 5321, 5629, 5310, 5471, 5352, 5597, 5545, 5707, 5513, 5696, 5586, 5647, 5674, 5628, 5428, 5531, 5611, 5723, 5709, 5385, 5403, 5335, 5527, 5585, 5409, 5706, 5502, 5654, 5682, 5337, 5405, 5524, 5414, 5719, 5386, 5363, 5401, 5456, 5602, 5642, 5276, 5368, 5673, 5317, 5701, 5651, 5543, 5551, 5646, 5474, 5566, 5672, 5379, 5341, 5525, 5564, 5624, 5429, 5404, 5662, 5302, 5514, 5562, 5511, 5664, 5338, 5671, 5350, 5510, 5529, 5547, 5608, 5374, 5724, 5369, 5481, 5298, 5353, 5373, 5503, 5358, 5253, 5250, 5670, 5675, 5715, 5411, 5679, 5522, 5640, 5398, 5362, 5637, 5680, 5619, 5708, 5600, 5328, 5622 (4 hits) (03/26/2012

<b>Table 83 - FCC frequency hopping radar (Type 6) Results, WU, CU Acquire Mode High Band</b>						
Trial #	Pulses/ Burst	Pulse Width (us)	PRI (us)	Detected	Fr (MHz) and level (dBm)	Burst Information
						11:40:56 AM)
16	9	1.0	333.0	Yes	5560.2MHz, -62.0dBm	Hop sequence: 5301, 5359, 5307, 5393, 5423, 5478, 5498, 5725, 5690, 5580, 5267, 5497, 5337, 5553, 5589, 5475, 5624, 5419, 5701, 5266, 5704, 5270, 5368, 5345, 5466, 5320, 5467, 5542, 5424, 5717, 5576, 5331, 5678, 5286, 5256, 5287, 5384, 5655, 5549, 5503, 5685, 5275, 5377, 5476, 5315, 5654, 5550, 5496, 5333, 5390, 5353, 5645, 5556, 5399, 5631, 5619, 5526, 5464, 5305, 5494, 5343, 5365, 5569, 5519, 5591, 5527, 5382, 5507, 5450, 5363, 5274, 5436, 5570, 5300, 5623, 5721, 5261, 5313, 5530, 5259, 5282, 5640, 5372, 5543, 5334, 5322, 5504, 5492, 5297, 5688, 5693, 5568, 5602, 5646, 5407, 5603, 5431, 5409, 5538, 5604 (9 hits) (03/26/2012 11:41:03 AM)
17	9	1.0	333.0	Yes	5561.2MHz, -62.0dBm	Hop sequence: 5560, 5256, 5408, 5308, 5334, 5718, 5383, 5723, 5375, 5381, 5395, 5619, 5487, 5571, 5698, 5713, 5270, 5553, 5496, 5314, 5537, 5495, 5606, 5414, 5418, 5706, 5450, 5426, 5531, 5624, 5445, 5647, 5557, 5443, 5264, 5393, 5714, 5701, 5709, 5683, 5299, 5665, 5682, 5556, 5517, 5502, 5639, 5644, 5585, 5494, 5593, 5326, 5678, 5630, 5516, 5285, 5574, 5447, 5453, 5293, 5287, 5472, 5522, 5272, 5289, 5710, 5456, 5563, 5520, 5276, 5252, 5478, 5369, 5620, 5391, 5686, 5438, 5315, 5697, 5378, 5366, 5386, 5479, 5612, 5300, 5269, 5545, 5320, 5695, 5658, 5538, 5294, 5429, 5304, 5292, 5651, 5316, 5504, 5599, 5550 (8 hits) (03/26/2012 11:41:22 AM)
18	9	1.0	333.0	Yes	5562.2MHz, -62.0dBm	Hop sequence: 5347, 5475, 5638, 5526, 5408, 5508, 5316, 5557, 5335, 5706, 5326, 5715, 5518, 5585, 5446, 5497, 5597, 5322, 5480, 5272, 5424, 5542, 5538, 5472, 5689, 5276, 5622, 5366, 5416, 5369, 5474, 5484, 5359, 5543, 5439, 5581, 5658, 5642, 5505, 5324, 5550, 5646, 5377, 5311, 5619, 5571, 5270, 5541,

Table 83 - FCC frequency hopping radar (Type 6) Results, WU, CU Acquire Mode High Band						
Trial #	Pulses/ Burst	Pulse Width (us)	PRI (us)	Detected	Fr (MHz) and level (dBm)	Burst Information
						5644, 5489, 5438, 5277, 5710, 5506, 5283, 5681, 5370, 5317, 5378, 5625, 5563, 5493, 5375, 5603, 5371, 5363, 5640, 5561, 5584, 5605, 5631, 5256, 5699, 5460, 5496, 5702, 5320, 5511, 5488, 5669, 5386, 5521, 5380, 5309, 5345, 5372, 5381, 5593, 5398, 5289, 5679, 5298, 5583, 5718, 5421, 5670, 5442, 5430, 5479, 5436 (5 hits) (03/26/2012 11:41:35 AM)
19	9	1.0	333.0	Yes	5563.2MHz, -62.0dBm	Hop sequence: 5506, 5531, 5449, 5545, 5401, 5309, 5369, 5558, 5497, 5470, 5388, 5299, 5642, 5590, 5301, 5333, 5397, 5540, 5542, 5441, 5592, 5513, 5269, 5629, 5649, 5516, 5311, 5530, 5310, 5394, 5448, 5331, 5725, 5678, 5493, 5709, 5559, 5658, 5536, 5510, 5344, 5315, 5258, 5395, 5279, 5286, 5326, 5305, 5674, 5684, 5689, 5363, 5398, 5621, 5396, 5433, 5367, 5600, 5627, 5537, 5598, 5686, 5577, 5514, 5291, 5718, 5597, 5267, 5465, 5268, 5673, 5354, 5575, 5651, 5272, 5630, 5525, 5360, 5682, 5601, 5527, 5409, 5419, 5438, 5566, 5289, 5528, 5680, 5474, 5483, 5722, 5475, 5568, 5427, 5380, 5340, 5276, 5639, 5431, 5633 (6 hits) (03/26/2012 11:41:42 AM)
20	9	1.0	333.0	Yes	5564.2MHz, -62.0dBm	Hop sequence: 5416, 5298, 5279, 5694, 5565, 5331, 5603, 5704, 5702, 5389, 5276, 5675, 5330, 5514, 5461, 5609, 5438, 5368, 5288, 5566, 5409, 5710, 5687, 5591, 5429, 5575, 5679, 5281, 5256, 5336, 5413, 5606, 5272, 5386, 5286, 5435, 5650, 5617, 5284, 5373, 5293, 5480, 5483, 5422, 5682, 5404, 5620, 5723, 5359, 5526, 5355, 5310, 5716, 5436, 5257, 5459, 5347, 5328, 5509, 5578, 5686, 5477, 5560, 5665, 5598, 5559, 5479, 5401, 5254, 5558, 5562, 5577, 5488, 5350, 5511, 5614, 5618, 5567, 5530, 5421, 5502, 5592, 5304, 5684, 5537, 5555, 5275, 5333, 5658, 5523, 5643, 5392, 5507, 5428, 5613, 5490, 5678, 5369, 5476, 5564 (12 hits) (03/26/2012

Table 83 - FCC frequency hopping radar (Type 6) Results, WU, CU Acquire Mode High Band						
Trial #	Pulses/ Burst	Pulse Width (us)	PRI (us)	Detected	Fr (MHz) and level (dBm)	Burst Information
						11:41:49 AM)
21	9	1.0	333.0	Yes	5565.2MHz, -62.0dBm	Hop sequence: 5688, 5370, 5690, 5630, 5487, 5472, 5379, 5645, 5692, 5344, 5377, 5486, 5419, 5711, 5701, 5722, 5675, 5572, 5285, 5656, 5289, 5527, 5536, 5460, 5353, 5429, 5270, 5358, 5329, 5499, 5635, 5603, 5652, 5521, 5331, 5299, 5608, 5491, 5563, 5593, 5347, 5681, 5531, 5385, 5654, 5683, 5590, 5726, 5677, 5620, 5371, 5328, 5707, 5426, 5670, 5399, 5255, 5425, 5668, 5333, 5464, 5725, 5452, 5651, 5529, 5641, 5252, 5280, 5673, 5307, 5545, 5267, 5724, 5695, 5672, 5546, 5447, 5294, 5351, 5438, 5450, 5283, 5581, 5338, 5693, 5508, 5501, 5412, 5512, 5271, 5394, 5513, 5646, 5712, 5538, 5679, 5250, 5710, 5470, 5576 (3 hits) (03/26/2012 11:41:57 AM)
22	9	1.0	333.0	Yes	5566.2MHz, -62.0dBm	Hop sequence: 5401, 5454, 5269, 5491, 5677, 5559, 5274, 5516, 5436, 5662, 5611, 5568, 5437, 5320, 5674, 5595, 5576, 5289, 5581, 5268, 5556, 5498, 5484, 5679, 5631, 5549, 5481, 5706, 5565, 5530, 5698, 5573, 5363, 5349, 5637, 5680, 5261, 5467, 5591, 5645, 5616, 5596, 5602, 5722, 5421, 5415, 5294, 5646, 5522, 5339, 5615, 5546, 5477, 5482, 5449, 5408, 5702, 5647, 5333, 5553, 5499, 5500, 5353, 5483, 5555, 5681, 5378, 5659, 5343, 5654, 5411, 5479, 5633, 5324, 5712, 5281, 5307, 5673, 5270, 5589, 5509, 5649, 5495, 5607, 5371, 5263, 5374, 5300, 5618, 5383, 5537, 5544, 5384, 5497, 5560, 5313, 5508, 5317, 5450, 5720 (10 hits) (03/26/2012 11:42:14 AM)
23	9	1.0	333.0	Yes	5567.2MHz, -62.0dBm	Hop sequence: 5454, 5361, 5653, 5277, 5465, 5293, 5367, 5487, 5618, 5611, 5628, 5566, 5302, 5545, 5254, 5382, 5273, 5374, 5324, 5646, 5577, 5260, 5715, 5307, 5496, 5483, 5549, 5417, 5710, 5398, 5559, 5411, 5478, 5343, 5317, 5460, 5684, 5552, 5531, 5437, 5335, 5676, 5575, 5647, 5708, 5272, 5598, 5402,

Table 83 - FCC frequency hopping radar (Type 6) Results, WU, CU Acquire Mode High Band						
Trial #	Pulses/ Burst	Pulse Width (us)	PRI (us)	Detected	Fr (MHz) and level (dBm)	Burst Information
						5442, 5615, 5505, 5425, 5597, 5322, 5346, 5554, 5357, 5387, 5622, 5340, 5705, 5472, 5520, 5513, 5278, 5447, 5595, 5403, 5515, 5320, 5372, 5699, 5364, 5517, 5621, 5371, 5337, 5682, 5527, 5345, 5330, 5444, 5259, 5484, 5500, 5467, 5287, 5706, 5331, 5492, 5613, 5703, 5722, 5634, 5269, 5328, 5643, 5509, 5713, 5479 (7 hits) (03/26/2012 11:42:28 AM)
24	9	1.0	333.0	Yes	5568.2MHz, -62.0dBm	Hop sequence: 5509, 5617, 5269, 5624, 5324, 5579, 5672, 5714, 5424, 5422, 5449, 5257, 5325, 5692, 5314, 5435, 5568, 5342, 5555, 5367, 5720, 5401, 5550, 5452, 5527, 5347, 5678, 5541, 5490, 5609, 5420, 5526, 5415, 5567, 5340, 5601, 5638, 5562, 5481, 5250, 5412, 5557, 5285, 5447, 5549, 5372, 5480, 5433, 5588, 5642, 5514, 5705, 5508, 5651, 5391, 5663, 5329, 5304, 5254, 5616, 5311, 5465, 5498, 5313, 5670, 5310, 5395, 5522, 5721, 5258, 5379, 5650, 5608, 5591, 5277, 5506, 5581, 5343, 5623, 5495, 5586, 5671, 5535, 5494, 5446, 5491, 5666, 5445, 5611, 5312, 5516, 5317, 5278, 5268, 5696, 5389, 5327, 5386, 5270, 5665 (8 hits) (03/26/2012 11:42:35 AM)
25	9	1.0	333.0	Yes	5569.2MHz, -62.0dBm	Hop sequence: 5316, 5453, 5658, 5488, 5511, 5686, 5345, 5500, 5510, 5599, 5336, 5641, 5720, 5273, 5487, 5688, 5434, 5411, 5714, 5508, 5595, 5685, 5606, 5532, 5604, 5318, 5461, 5518, 5632, 5603, 5655, 5537, 5447, 5320, 5300, 5410, 5355, 5423, 5383, 5661, 5377, 5622, 5550, 5439, 5623, 5601, 5706, 5640, 5358, 5293, 5633, 5542, 5538, 5535, 5609, 5682, 5464, 5721, 5577, 5331, 5501, 5421, 5291, 5459, 5285, 5252, 5398, 5416, 5725, 5257, 5614, 5694, 5458, 5707, 5353, 5400, 5364, 5289, 5467, 5486, 5477, 5270, 5724, 5450, 5645, 5557, 5579, 5265, 5656, 5560, 5427, 5598, 5386, 5476, 5431, 5490, 5549, 5695, 5585, 5634 (6 hits) (03/26/2012

Table 83 - FCC frequency hopping radar (Type 6) Results, WU, CU Acquire Mode High Band						
Trial #	Pulses/ Burst	Pulse Width (us)	PRI (us)	Detected	Fr (MHz) and level (dBm)	Burst Information
						11:42:43 AM)
26	9	1.0	333.0	Yes	5570.2MHz, -62.0dBm	Hop sequence: 5281, 5597, 5444, 5567, 5432, 5373, 5341, 5474, 5665, 5296, 5710, 5591, 5661, 5701, 5268, 5657, 5312, 5352, 5280, 5541, 5647, 5406, 5446, 5691, 5559, 5517, 5378, 5533, 5490, 5595, 5475, 5390, 5637, 5421, 5317, 5663, 5303, 5672, 5368, 5523, 5450, 5606, 5675, 5468, 5442, 5524, 5454, 5587, 5649, 5435, 5711, 5562, 5640, 5575, 5560, 5407, 5513, 5646, 5400, 5358, 5353, 5521, 5707, 5414, 5610, 5652, 5687, 5620, 5489, 5375, 5413, 5426, 5510, 5635, 5586, 5424, 5638, 5482, 5542, 5564, 5293, 5313, 5255, 5700, 5688, 5256, 5344, 5469, 5634, 5382, 5706, 5477, 5499, 5282, 5292, 5484, 5551, 5579, 5429, 5379 (8 hits) (03/26/2012 11:42:50 AM)
27	9	1.0	333.0	Yes	5571.2MHz, -62.0dBm	Hop sequence: 5375, 5680, 5280, 5721, 5653, 5501, 5462, 5337, 5505, 5632, 5491, 5426, 5529, 5390, 5717, 5264, 5279, 5549, 5355, 5425, 5559, 5583, 5665, 5384, 5575, 5598, 5539, 5608, 5493, 5418, 5589, 5253, 5461, 5303, 5444, 5593, 5658, 5592, 5616, 5659, 5679, 5610, 5385, 5655, 5473, 5668, 5700, 5386, 5432, 5605, 5599, 5705, 5584, 5403, 5270, 5343, 5496, 5492, 5569, 5578, 5326, 5683, 5285, 5437, 5613, 5543, 5379, 5571, 5296, 5500, 5354, 5483, 5372, 5430, 5416, 5572, 5304, 5701, 5567, 5622, 5497, 5706, 5268, 5615, 5439, 5255, 5442, 5642, 5348, 5331, 5546, 5319, 5397, 5478, 5646, 5413, 5552, 5305, 5656, 5512 (9 hits) (03/26/2012 11:42:57 AM)
28	9	1.0	333.0	Yes	5572.2MHz, -62.0dBm	Hop sequence: 5690, 5613, 5388, 5271, 5502, 5389, 5671, 5637, 5381, 5666, 5491, 5546, 5252, 5352, 5453, 5371, 5654, 5679, 5540, 5299, 5547, 5548, 5322, 5321, 5700, 5515, 5431, 5367, 5373, 5325, 5500, 5725, 5358, 5382, 5549, 5481, 5286, 5523, 5570, 5517, 5496, 5644, 5557, 5603, 5305, 5636, 5616, 5618,

Table 83 - FCC frequency hopping radar (Type 6) Results, WU, CU Acquire Mode High Band						
Trial #	Pulses/ Burst	Pulse Width (us)	PRI (us)	Detected	Fr (MHz) and level (dBm)	Burst Information
						5356, 5355, 5312, 5664, 5412, 5257, 5660, 5393, 5720, 5551, 5320, 5683, 5627, 5332, 5456, 5624, 5465, 5384, 5713, 5519, 5449, 5291, 5266, 5538, 5495, 5429, 5536, 5484, 5262, 5621, 5314, 5688, 5721, 5333, 5345, 5503, 5273, 5657, 5513, 5528, 5413, 5296, 5641, 5318, 5652, 5689, 5289, 5440, 5421, 5346, 5710, 5401 (5 hits) (03/26/2012 11:43:05 AM)
29	9	1.0	333.0	Yes	5573.2MHz, -62.0dBm	Hop sequence: 5609, 5605, 5536, 5277, 5259, 5522, 5425, 5356, 5551, 5367, 5515, 5542, 5434, 5459, 5409, 5528, 5438, 5378, 5399, 5610, 5430, 5676, 5410, 5484, 5648, 5591, 5327, 5697, 5533, 5385, 5362, 5393, 5712, 5503, 5499, 5720, 5292, 5260, 5364, 5406, 5524, 5262, 5505, 5719, 5622, 5645, 5303, 5366, 5667, 5286, 5307, 5305, 5383, 5602, 5465, 5333, 5360, 5382, 5400, 5549, 5293, 5282, 5251, 5482, 5649, 5577, 5306, 5663, 5318, 5713, 5593, 5578, 5597, 5583, 5263, 5353, 5494, 5264, 5680, 5607, 5724, 5391, 5552, 5432, 5489, 5601, 5420, 5316, 5576, 5513, 5373, 5330, 5463, 5575, 5326, 5359, 5618, 5379, 5723, 5704 (7 hits) (03/26/2012 11:43:13 AM)
30	9	1.0	333.0	Yes	5574.2MHz, -62.0dBm	Hop sequence: 5546, 5527, 5261, 5431, 5704, 5558, 5591, 5586, 5504, 5444, 5331, 5614, 5583, 5535, 5263, 5574, 5601, 5328, 5528, 5382, 5663, 5366, 5539, 5492, 5441, 5357, 5469, 5262, 5324, 5674, 5578, 5385, 5699, 5515, 5580, 5566, 5719, 5351, 5334, 5365, 5502, 5411, 5335, 5542, 5269, 5252, 5587, 5374, 5450, 5437, 5396, 5433, 5423, 5376, 5326, 5548, 5514, 5445, 5487, 5455, 5585, 5624, 5449, 5684, 5651, 5577, 5456, 5293, 5557, 5398, 5507, 5721, 5686, 5552, 5495, 5670, 5289, 5349, 5572, 5545, 5302, 5479, 5481, 5509, 5284, 5641, 5373, 5477, 5625, 5406, 5643, 5268, 5407, 5612, 5709, 5257, 5443, 5497, 5650, 5283 (10 hits) (03/26/2012



Table 83 - FCC frequency hopping radar (Type 6) Results, WU, CU Acquire Mode High Band						
Trial #	Pulses/ Burst	Pulse Width (us)	PRI (us)	Detected	Fr (MHz) and level (dBm)	Burst Information
						11:43:20 AM)
31	9	1.0	333.0	Yes	5575.2MHz, -62.0dBm	Hop sequence: 5405, 5354, 5664, 5673, 5588, 5420, 5544, 5427, 5259, 5409, 5422, 5610, 5598, 5577, 5255, 5638, 5372, 5254, 5310, 5659, 5328, 5597, 5545, 5432, 5601, 5462, 5642, 5264, 5451, 5678, 5426, 5408, 5381, 5476, 5626, 5613, 5297, 5661, 5402, 5641, 5467, 5260, 5253, 5283, 5605, 5653, 5273, 5572, 5622, 5319, 5500, 5489, 5536, 5502, 5511, 5714, 5657, 5518, 5543, 5251, 5631, 5431, 5534, 5684, 5484, 5267, 5716, 5490, 5306, 5589, 5505, 5327, 5424, 5266, 5457, 5563, 5461, 5404, 5365, 5322, 5311, 5345, 5326, 5665, 5541, 5602, 5379, 5295, 5336, 5487, 5423, 5709, 5648, 5378, 5703, 5433, 5447, 5309, 5296, 5388 (3 hits) (03/26/2012 11:43:27 AM)
32	9	1.0	333.0	Yes	5576.2MHz, -62.0dBm	Hop sequence: 5420, 5309, 5287, 5335, 5375, 5511, 5633, 5637, 5396, 5411, 5640, 5668, 5552, 5600, 5507, 5515, 5256, 5665, 5659, 5539, 5565, 5487, 5528, 5279, 5557, 5703, 5574, 5329, 5310, 5275, 5630, 5634, 5578, 5347, 5400, 5688, 5349, 5492, 5564, 5432, 5602, 5713, 5454, 5716, 5354, 5284, 5685, 5421, 5377, 5636, 5343, 5677, 5352, 5416, 5276, 5405, 5371, 5372, 5533, 5495, 5612, 5591, 5257, 5584, 5607, 5370, 5673, 5253, 5693, 5683, 5604, 5379, 5669, 5708, 5712, 5259, 5494, 5414, 5643, 5543, 5596, 5657, 5613, 5457, 5710, 5378, 5624, 5427, 5438, 5707, 5455, 5346, 5705, 5611, 5497, 5260, 5605, 5691, 5606, 5393 (6 hits) (03/26/2012 11:43:36 AM)
33	9	1.0	333.0	Yes	5577.2MHz, -62.0dBm	Hop sequence: 5645, 5724, 5425, 5609, 5628, 5299, 5597, 5491, 5655, 5471, 5622, 5666, 5474, 5616, 5674, 5517, 5646, 5355, 5567, 5343, 5365, 5508, 5499, 5589, 5621, 5637, 5692, 5526, 5658, 5524, 5363, 5368, 5713, 5271, 5528, 5557, 5382, 5654, 5641, 5273, 5259, 5590, 5624, 5351, 5262, 5716, 5416, 5700,

Table 83 - FCC frequency hopping radar (Type 6) Results, WU, CU Acquire Mode High Band						
Trial #	Pulses/ Burst	Pulse Width (us)	PRI (us)	Detected	Fr (MHz) and level (dBm)	Burst Information
						5596, 5680, 5576, 5450, 5725, 5604, 5495, 5484, 5402, 5592, 5350, 5385, 5319, 5512, 5395, 5254, 5454, 5506, 5602, 5439, 5497, 5653, 5722, 5672, 5684, 5642, 5431, 5275, 5342, 5301, 5584, 5435, 5479, 5708, 5281, 5553, 5347, 5332, 5581, 5331, 5390, 5668, 5256, 5612, 5304, 5719, 5375, 5500, 5328, 5473, 5647, 5340 (4 hits) (03/26/2012 11:43:44 AM)
34	9	1.0	333.0	Yes	5578.2MHz, -62.0dBm	Hop sequence: 5567, 5709, 5356, 5516, 5604, 5576, 5668, 5659, 5450, 5325, 5267, 5694, 5508, 5603, 5568, 5311, 5283, 5717, 5253, 5633, 5406, 5332, 5658, 5641, 5529, 5537, 5689, 5528, 5339, 5605, 5467, 5585, 5601, 5492, 5276, 5261, 5549, 5393, 5692, 5397, 5514, 5314, 5358, 5409, 5377, 5720, 5286, 5672, 5328, 5383, 5522, 5422, 5371, 5636, 5643, 5296, 5711, 5702, 5559, 5656, 5488, 5372, 5695, 5308, 5542, 5663, 5321, 5539, 5266, 5345, 5505, 5322, 5275, 5335, 5654, 5453, 5592, 5724, 5491, 5696, 5660, 5333, 5487, 5677, 5420, 5390, 5517, 5412, 5637, 5704, 5499, 5579, 5541, 5682, 5425, 5346, 5418, 5446, 5351, 5670 (6 hits) (03/26/2012 11:43:51 AM)

## WU, CU Acquire mode, Low Band

**Table 84 WU, CU Acquire Low Band Detection Bandwidth Measurements (Bandwidth: +11MHz /-11MHz)**

EUT Frequency	Radar Type	Radar Frequency	# Detected	# Not Detected	Success (%)
5284.80 MHz	FCC Short Pulse Radar (Type 1)	5272.80 MHz	5	3	62
5284.80 MHz	FCC Short Pulse Radar (Type 1)	5273.80 MHz	10	0	100
5284.80 MHz	FCC Short Pulse Radar (Type 1)	5274.80 MHz	10	0	100
5284.80 MHz	FCC Short Pulse Radar (Type 1)	5275.80 MHz	10	0	100
5284.80 MHz	FCC Short Pulse Radar (Type 1)	5276.80 MHz	10	0	100
5284.80 MHz	FCC Short Pulse Radar (Type 1)	5277.80 MHz	10	0	100
5284.80 MHz	FCC Short Pulse Radar (Type 1)	5278.80 MHz	10	0	100
5284.80 MHz	FCC Short Pulse Radar (Type 1)	5279.80 MHz	10	0	100
5284.80 MHz	FCC Short Pulse Radar (Type 1)	5280.80 MHz	10	0	100
5284.80 MHz	FCC Short Pulse Radar (Type 1)	5281.80 MHz	10	0	100
5284.80 MHz	FCC Short Pulse Radar (Type 1)	5282.80 MHz	10	0	100
5284.80 MHz	FCC Short Pulse Radar (Type 1)	5283.80 MHz	10	0	100
5284.80 MHz	FCC Short Pulse Radar (Type 1)	5284.80 MHz	10	0	100
5284.80 MHz	FCC Short Pulse Radar (Type 1)	5285.80 MHz	10	0	100
5284.80 MHz	FCC Short Pulse Radar (Type 1)	5286.80 MHz	10	0	100
5284.80 MHz	FCC Short Pulse Radar (Type 1)	5287.80 MHz	10	0	100
5284.80 MHz	FCC Short Pulse Radar (Type 1)	5288.80 MHz	10	0	100
5284.80 MHz	FCC Short Pulse Radar (Type 1)	5289.80 MHz	10	0	100
5284.80 MHz	FCC Short Pulse Radar (Type 1)	5290.80 MHz	10	0	100
5284.80 MHz	FCC Short Pulse Radar (Type 1)	5291.80 MHz	10	0	100
5284.80 MHz	FCC Short Pulse Radar (Type 1)	5292.80 MHz	10	0	100
5284.80 MHz	FCC Short Pulse Radar (Type 1)	5293.80 MHz	10	0	100
5284.80 MHz	FCC Short Pulse Radar (Type 1)	5294.80 MHz	10	0	100
5284.80 MHz	FCC Short Pulse Radar (Type 1)	5295.80 MHz	10	0	100
5284.80 MHz	FCC Short Pulse Radar (Type 1)	5296.80 MHz	1	3	25

**Table 85 - Summary of All Results – WU, CU Acquire LowBand**

Waveform Name	Pd (%)	Pd Required (%)	Number of Trials	Status
FCC Short Pulse Radar (Type 1)	100.0 %	60.0 %	30	PASSED
FCC Short Pulse Radar (Type 2)	100.0 %	60.0 %	30	PASSED
FCC Short Pulse Radar (Type 3)	100.0 %	60.0 %	30	PASSED
FCC Short Pulse Radar (Type 4)	96.7 %	60.0 %	30	PASSED
Aggregate of above results	99.2 %	80.0 %	120	PASSED
FCC frequency hopping radar (Type 6)	100.0 %	70.0 %	46	PASSED
Long Sequence	100.0 %	80.0 %	30	PASSED

<b>Table 86 - FCC Short Pulse Radar (Type 1) Results WU, CU Acquire LowBand</b>						
Trial #	Pulses/ Burst	Pulse Width (us)	PRI (us)	Detected	Fr (MHz) and level (dBm)	Burst Information
1	18	1.0	1428.0	Yes	5284.8MHz, -62.0dBm	Single burst
2	18	1.0	1428.0	Yes	5279.8MHz, -62.0dBm	Single burst
3	18	1.0	1428.0	Yes	5274.8MHz, -62.0dBm	Single burst
4	18	1.0	1428.0	Yes	5294.8MHz, -62.0dBm	Single burst
5	18	1.0	1428.0	Yes	5289.8MHz, -62.0dBm	Single burst
6	18	1.0	1428.0	Yes	5284.8MHz, -62.0dBm	Single burst
7	18	1.0	1428.0	Yes	5279.8MHz, -62.0dBm	Single burst
8	18	1.0	1428.0	Yes	5274.8MHz, -62.0dBm	Single burst
9	18	1.0	1428.0	Yes	5294.8MHz, -62.0dBm	Single burst
10	18	1.0	1428.0	Yes	5289.8MHz, -62.0dBm	Single burst
11	18	1.0	1428.0	Yes	5284.8MHz, -62.0dBm	Single burst
12	18	1.0	1428.0	Yes	5279.8MHz, -62.0dBm	Single burst
13	18	1.0	1428.0	Yes	5274.8MHz, -62.0dBm	Single burst
14	18	1.0	1428.0	Yes	5294.8MHz, -62.0dBm	Single burst
15	18	1.0	1428.0	Yes	5289.8MHz, -62.0dBm	Single burst
16	18	1.0	1428.0	Yes	5284.8MHz, -62.0dBm	Single burst
17	18	1.0	1428.0	Yes	5279.8MHz, -62.0dBm	Single burst
18	18	1.0	1428.0	Yes	5274.8MHz, -62.0dBm	Single burst
19	18	1.0	1428.0	Yes	5294.8MHz, -62.0dBm	Single burst
20	18	1.0	1428.0	Yes	5289.8MHz, -62.0dBm	Single burst
21	18	1.0	1428.0	Yes	5284.8MHz, -62.0dBm	Single burst
22	18	1.0	1428.0	Yes	5279.8MHz, -62.0dBm	Single burst
23	18	1.0	1428.0	Yes	5274.8MHz, -62.0dBm	Single burst
24	18	1.0	1428.0	Yes	5294.8MHz, -62.0dBm	Single burst
25	18	1.0	1428.0	Yes	5289.8MHz, -62.0dBm	Single burst
26	18	1.0	1428.0	Yes	5284.8MHz, -62.0dBm	Single burst
27	18	1.0	1428.0	Yes	5279.8MHz, -62.0dBm	Single burst
28	18	1.0	1428.0	Yes	5274.8MHz, -62.0dBm	Single burst
29	18	1.0	1428.0	Yes	5289.8MHz, -62.0dBm	Single burst
30	18	1.0	1428.0	Yes	5284.8MHz, -62.0dBm	Single burst

<b>Table 87 - FCC Short Pulse Radar (Type 2) Results WU, CU Acquire LowBand</b>						
Trial #	Pulses/ Burst	Pulse Width (us)	PRI (us)	Detected	Fr (MHz) and level (dBm)	Burst Information
1	25	1.2	189.0	Yes	5284.8MHz, -62.0dBm	Single burst
2	27	4.4	158.0	Yes	5279.8MHz, -62.0dBm	Single burst
3	28	1.7	227.0	Yes	5289.8MHz, -62.0dBm	Single burst
4	24	4.9	175.0	Yes	5284.8MHz, -62.0dBm	Single burst
5	29	3.8	219.0	Yes	5279.8MHz, -62.0dBm	Single burst
6	28	3.2	188.0	Yes	5289.8MHz, -62.0dBm	Single burst
7	24	2.5	214.0	Yes	5284.8MHz, -62.0dBm	Single burst
8	24	2.0	189.0	Yes	5279.8MHz, -62.0dBm	Single burst
9	25	1.9	208.0	Yes	5289.8MHz, -62.0dBm	Single burst
10	29	4.8	166.0	Yes	5284.8MHz, -62.0dBm	Single burst
11	24	3.8	219.0	Yes	5279.8MHz, -62.0dBm	Single burst
12	24	2.7	218.0	Yes	5289.8MHz, -62.0dBm	Single burst
13	29	3.0	224.0	Yes	5284.8MHz, -62.0dBm	Single burst
14	27	4.0	214.0	Yes	5279.8MHz, -62.0dBm	Single burst
15	26	4.2	187.0	Yes	5289.8MHz, -62.0dBm	Single burst
16	24	1.7	158.0	Yes	5284.8MHz, -62.0dBm	Single burst
17	29	2.8	201.0	Yes	5279.8MHz, -62.0dBm	Single burst
18	25	4.9	209.0	Yes	5289.8MHz, -62.0dBm	Single burst
19	23	2.2	224.0	Yes	5284.8MHz, -62.0dBm	Single burst
20	25	1.1	197.0	Yes	5279.8MHz, -62.0dBm	Single burst
21	28	4.3	171.0	Yes	5289.8MHz, -62.0dBm	Single burst
22	26	4.0	167.0	Yes	5284.8MHz, -62.0dBm	Single burst
23	27	1.6	184.0	Yes	5279.8MHz, -62.0dBm	Single burst
24	25	1.1	189.0	Yes	5289.8MHz, -62.0dBm	Single burst
25	26	1.7	185.0	Yes	5284.8MHz, -62.0dBm	Single burst
26	28	2.3	179.0	Yes	5279.8MHz, -62.0dBm	Single burst
27	25	1.8	188.0	Yes	5289.8MHz, -62.0dBm	Single burst
28	23	1.0	178.0	Yes	5284.8MHz, -62.0dBm	Single burst
29	26	4.1	213.0	Yes	5279.8MHz, -62.0dBm	Single burst
30	25	3.5	200.0	Yes	5289.8MHz, -62.0dBm	Single burst

<b>Table 88 - FCC Short Pulse Radar (Type 3) Results WU, CU Acquire LowBand</b>						
Trial #	Pulses/ Burst	Pulse Width (us)	PRI (us)	Detected	Fr (MHz) and level (dBm)	Burst Information
1	18	8.4	208.0	Yes	5284.8MHz, -62.0dBm	Single burst
2	16	6.9	264.0	Yes	5279.8MHz, -62.0dBm	Single burst
3	17	6.7	445.0	Yes	5289.8MHz, -62.0dBm	Single burst
4	17	9.9	420.0	Yes	5284.8MHz, -62.0dBm	Single burst
5	18	6.8	213.0	Yes	5279.8MHz, -62.0dBm	Single burst
6	17	8.1	459.0	Yes	5289.8MHz, -62.0dBm	Single burst
7	18	8.4	418.0	Yes	5284.8MHz, -62.0dBm	Single burst
8	17	7.6	263.0	Yes	5279.8MHz, -62.0dBm	Single burst
9	16	7.5	423.0	Yes	5289.8MHz, -62.0dBm	Single burst
10	16	8.1	335.0	Yes	5284.8MHz, -62.0dBm	Single burst
11	16	8.3	371.0	Yes	5279.8MHz, -62.0dBm	Single burst
12	17	6.1	334.0	Yes	5289.8MHz, -62.0dBm	Single burst
13	17	6.0	388.0	Yes	5284.8MHz, -62.0dBm	Single burst
14	18	6.4	233.0	Yes	5279.8MHz, -62.0dBm	Single burst
15	17	9.5	423.0	Yes	5289.8MHz, -62.0dBm	Single burst
16	18	8.9	298.0	Yes	5284.8MHz, -62.0dBm	Single burst
17	16	6.7	228.0	Yes	5279.8MHz, -62.0dBm	Single burst
18	16	9.3	381.0	Yes	5289.8MHz, -62.0dBm	Single burst
19	17	9.6	250.0	Yes	5284.8MHz, -62.0dBm	Single burst
20	17	9.9	471.0	Yes	5279.8MHz, -62.0dBm	Single burst
21	18	7.2	210.0	Yes	5289.8MHz, -62.0dBm	Single burst
22	16	9.4	348.0	Yes	5284.8MHz, -62.0dBm	Single burst
23	16	9.2	253.0	Yes	5279.8MHz, -62.0dBm	Single burst
24	18	8.5	430.0	Yes	5289.8MHz, -62.0dBm	Single burst
25	17	7.3	359.0	Yes	5284.8MHz, -62.0dBm	Single burst
26	18	9.7	262.0	Yes	5279.8MHz, -62.0dBm	Single burst
27	16	6.8	350.0	Yes	5289.8MHz, -62.0dBm	Single burst
28	16	8.3	337.0	Yes	5284.8MHz, -62.0dBm	Single burst
29	18	6.3	298.0	Yes	5279.8MHz, -62.0dBm	Single burst
30	17	6.6	387.0	Yes	5289.8MHz, -62.0dBm	Single burst

<b>Table 89 - FCC Short Pulse Radar (Type 4) Results WU, CU Acquire LowBand</b>						
Trial #	Pulses/ Burst	Pulse Width (us)	PRI (us)	Detected	Fr (MHz) and level (dBm)	Burst Information
1	14	11.2	347.0	Yes	5284.8MHz, -62.0dBm	Single burst
2	16	12.5	367.0	Yes	5279.8MHz, -62.0dBm	Single burst
3	15	16.3	364.0	Yes	5289.8MHz, -62.0dBm	Single burst
4	15	16.6	350.0	Yes	5284.8MHz, -62.0dBm	Single burst
5	15	16.5	329.0	Yes	5279.8MHz, -62.0dBm	Single burst
6	13	17.0	257.0	Yes	5289.8MHz, -62.0dBm	Single burst
7	16	11.4	229.0	Yes	5284.8MHz, -62.0dBm	Single burst
8	15	17.0	240.0	Yes	5279.8MHz, -62.0dBm	Single burst
9	13	15.1	325.0	Yes	5289.8MHz, -62.0dBm	Single burst
10	13	12.9	438.0	Yes	5284.8MHz, -62.0dBm	Single burst
11	15	18.4	351.0	Yes	5279.8MHz, -62.0dBm	Single burst
12	12	18.1	231.0	Yes	5289.8MHz, -62.0dBm	Single burst
13	14	14.0	206.0	Yes	5284.8MHz, -62.0dBm	Single burst
14	14	18.8	275.0	Yes	5279.8MHz, -62.0dBm	Single burst
15	13	12.8	277.0	Yes	5289.8MHz, -62.0dBm	Single burst
16	14	17.0	437.0	Yes	5284.8MHz, -62.0dBm	Single burst
17	14	18.6	361.0	Yes	5279.8MHz, -62.0dBm	Single burst
18	13	11.4	397.0	Yes	5289.8MHz, -62.0dBm	Single burst
19	16	18.5	249.0	Yes	5284.8MHz, -62.0dBm	Single burst
20	15	14.0	462.0	Yes	5279.8MHz, -62.0dBm	Single burst
21	13	17.5	260.0	Yes	5289.8MHz, -62.0dBm	Single burst
22	15	20.0	310.0	Yes	5284.8MHz, -62.0dBm	Single burst
23	16	19.9	392.0	Yes	5279.8MHz, -62.0dBm	Single burst
24	13	11.7	369.0	Yes	5289.8MHz, -62.0dBm	Single burst
25	14	15.2	335.0	Yes	5284.8MHz, -62.0dBm	Single burst
26	13	19.9	288.0	No	5279.8MHz, -62.0dBm	Single burst
27	13	12.1	321.0	Yes	5289.8MHz, -62.0dBm	Single burst
28	13	19.2	259.0	Yes	5284.8MHz, -62.0dBm	Single burst
29	14	14.9	461.0	Yes	5279.8MHz, -62.0dBm	Single burst
30	14	16.4	497.0	Yes	5289.8MHz, -62.0dBm	Single burst

Long Sequence Trial	Result	Radar Frequency / Amplitude
Trial #1	Detected	5284.8MHz, -62.0dBm
Trial #2	Detected	5279.8MHz, -62.0dBm
Trial #3	Detected	5289.8MHz, -62.0dBm
Trial #4	Detected	5284.8MHz, -62.0dBm
Trial #5	Detected	5279.8MHz, -62.0dBm
Trial #6	Detected	5289.8MHz, -62.0dBm
Trial #7	Detected	5284.8MHz, -62.0dBm
Trial #8	Detected	5279.8MHz, -62.0dBm
Trial #9	Detected	5289.8MHz, -62.0dBm
Trial #10	Detected	5284.8MHz, -62.0dBm
Trial #11	Detected	5279.8MHz, -62.0dBm
Trial #12	Detected	5289.8MHz, -62.0dBm
Trial #13	Detected	5284.8MHz, -62.0dBm
Trial #14	Detected	5279.8MHz, -62.0dBm
Trial #15	Detected	5289.8MHz, -62.0dBm
Trial #16	Detected	5284.8MHz, -62.0dBm
Trial #17	Detected	5279.8MHz, -62.0dBm
Trial #18	Detected	5289.8MHz, -62.0dBm
Trial #19	Detected	5284.8MHz, -62.0dBm
Trial #20	Detected	5279.8MHz, -62.0dBm
Trial #21	Detected	5289.8MHz, -62.0dBm
Trial #22	Detected	5284.8MHz, -62.0dBm
Trial #23	Detected	5279.8MHz, -62.0dBm
Trial #24	Detected	5289.8MHz, -62.0dBm
Trial #25	Detected	5284.8MHz, -62.0dBm
Trial #26	Detected	5279.8MHz, -62.0dBm
Trial #27	Detected	5289.8MHz, -62.0dBm
Trial #28	Detected	5284.8MHz, -62.0dBm
Trial #29	Detected	5279.8MHz, -62.0dBm
Trial #30	Detected	5289.8MHz, -62.0dBm

Burst #	# Pulses	Pulse Width (us)	Chirp (MHz)	Interval 1 to 2 (us)	Interval 2 to 3 (us)	Start time (us)
1	1	58.1	18	-	-	0.812173
2	2	58.4	17	1832.0	-	1.114888
3	2	76.3	11	1847.0	-	2.488669
4	1	66.8	19	-	-	3.205134
5	1	65.7	8	-	-	3.880004
6	1	67.7	16	-	-	4.884848
7	1	83.3	17	-	-	5.243553
8	2	89.6	16	1448.0	-	6.529685
9	2	77.4	15	1478.0	-	6.957946
10	2	94.6	20	1276.0	-	8.549577
11	2	70.3	7	1953.0	-	8.860354
12	2	73.6	8	1168.0	-	10.008197
13	1	53.4	6	-	-	10.332798
14	1	80.3	15	-	-	11.190973



<b>Table 92 - WU, CU Acquire, Low Band, Long Sequence Waveform Trial#2 (Detected)</b>						
Burst #	# Pulses	Pulse Width (us)	Chirp (MHz)	Interval 1 to 2 (us)	Interval 2 to 3 (us)	Start time (us)
1	3	50.4	17	1431.0	1403.0	0.043015
2	3	67.8	10	1633.0	1716.0	1.368601
3	2	54.1	8	1834.0	-	1.688632
4	2	61.5	19	1134.0	-	3.083406
5	3	89.8	20	1369.0	1890.0	3.211446
6	3	50.9	9	1193.0	1595.0	4.556341
7	2	97.5	18	1988.0	-	5.228959
8	1	59.7	11	-	-	5.804131
9	3	70.5	16	1701.0	1138.0	6.950736
10	2	82.4	19	1962.0	-	7.892649
11	2	52.1	17	1065.0	-	8.551828
12	2	87.0	7	1718.0	-	9.044713
13	1	73.2	7	-	-	9.865782
14	3	53.3	15	1013.0	1845.0	10.740801
15	2	96.7	13	1674.0	-	11.552159

<b>Table 93 - WU, CU Acquire, Low Band, Long Sequence Waveform Trial#3 (Detected)</b>						
Burst #	# Pulses	Pulse Width (us)	Chirp (MHz)	Interval 1 to 2 (us)	Interval 2 to 3 (us)	Start time (us)
1	1	89.8	10	-	-	0.175541
2	2	88.7	7	1994.0	-	1.227082
3	3	96.8	8	1204.0	1693.0	1.874368
4	2	78.9	6	1544.0	-	2.059173
5	2	68.8	5	1953.0	-	2.802648
6	1	70.2	10	-	-	3.853473
7	2	51.0	10	1989.0	-	4.188237
8	1	81.0	9	-	-	4.732958
9	2	66.7	12	1052.0	-	5.435737
10	2	76.4	12	1997.0	-	6.567223
11	2	53.1	10	1415.0	-	6.890888
12	2	65.3	19	1180.0	-	7.822360
13	2	54.9	7	1650.0	-	8.110179
14	2	84.9	9	1057.0	-	9.256451
15	3	61.7	19	1988.0	1836.0	9.614900
16	3	79.5	12	1753.0	1773.0	10.507963
17	3	64.9	9	1739.0	1993.0	10.884876
18	3	56.2	18	1069.0	1815.0	11.726138

**Table 94 - WU, CU Acquire, Low Band, Long Sequence Waveform Trial#4 (Detected)**

Burst #	# Pulses	Pulse Width (us)	Chirp (MHz)	Interval 1 to 2 (us)	Interval 2 to 3 (us)	Start time (us)
1	1	51.7	15	-	-	0.695853
2	2	66.2	14	1356.0	-	2.343044
3	2	58.8	7	1952.0	-	2.657354
4	3	68.3	13	1582.0	1471.0	4.618878
5	3	54.1	14	1252.0	1194.0	5.442247
6	2	50.5	18	1203.0	-	6.293545
7	3	92.8	8	1360.0	1902.0	7.487576
8	3	55.8	14	1604.0	1902.0	9.351948
9	2	75.7	7	1781.0	-	10.202501
10	2	58.0	6	1048.0	-	11.222709

**Table 95 - WU, CU Acquire, Low Band, Long Sequence Waveform Trial#5 (Detected)**

Burst #	# Pulses	Pulse Width (us)	Chirp (MHz)	Interval 1 to 2 (us)	Interval 2 to 3 (us)	Start time (us)
1	1	68.8	13	-	-	0.233425
2	2	65.6	18	1822.0	-	0.953634
3	2	92.1	12	1388.0	-	1.991071
4	2	63.3	10	1869.0	-	2.522930
5	2	66.9	18	1827.0	-	3.561113
6	2	80.9	5	1961.0	-	4.084350
7	3	57.7	7	1126.0	1495.0	4.940163
8	1	70.0	7	-	-	5.724924
9	1	91.7	6	-	-	6.477936
10	3	88.2	6	1457.0	1826.0	7.447713
11	2	81.2	15	1527.0	-	7.640128
12	2	90.3	8	1691.0	-	8.340286
13	1	53.2	13	-	-	9.357334
14	1	82.8	15	-	-	9.811797
15	3	62.4	6	1926.0	1178.0	10.625253
16	2	73.6	9	1216.0	-	11.961053

**Table 96 - WU, CU Acquire, Low Band, Long Sequence Waveform Trial#6 (Detected)**

Burst #	# Pulses	Pulse Width (us)	Chirp (MHz)	Interval 1 to 2 (us)	Interval 2 to 3 (us)	Start time (us)
1	2	66.1	8	1321.0	-	0.591566
2	2	58.8	10	1545.0	-	1.146468
3	3	55.6	18	1723.0	1844.0	2.171660
4	1	85.7	9	-	-	3.033588
5	1	60.0	7	-	-	3.563089
6	1	58.2	11	-	-	4.580049
7	2	76.7	11	1252.0	-	5.860925
8	2	82.6	9	1502.0	-	6.838568
9	2	85.9	16	1056.0	-	7.424956
10	3	53.8	11	1905.0	1848.0	8.180371
11	3	82.1	11	1562.0	1051.0	8.806725
12	3	99.2	18	1417.0	1884.0	10.173376
13	1	85.7	20	-	-	10.564797
14	2	65.1	6	1717.0	-	11.558730

**Table 97 - WU, CU Acquire, Low Band, Long Sequence Waveform Trial#7 (Detected)**

Burst #	# Pulses	Pulse Width (us)	Chirp (MHz)	Interval 1 to 2 (us)	Interval 2 to 3 (us)	Start time (us)
1	3	86.7	19	1792.0	1851.0	1.435123
2	2	70.3	15	1012.0	-	2.100202
3	2	91.7	18	1491.0	-	3.153901
4	1	95.3	7	-	-	5.306437
5	3	81.2	13	1005.0	1803.0	7.115543
6	3	82.6	10	1176.0	1917.0	7.636017
7	2	77.3	19	1164.0	-	9.451159
8	2	98.7	7	1948.0	-	11.921059

**Table 98 - WU, CU Acquire, Low Band, Long Sequence Waveform Trial#8 (Detected)**

Burst #	# Pulses	Pulse Width (us)	Chirp (MHz)	Interval 1 to 2 (us)	Interval 2 to 3 (us)	Start time (us)
1	1	78.9	12	-	-	0.717133
2	3	74.5	16	1374.0	1666.0	1.102331
3	1	79.2	17	-	-	2.228482
4	2	89.6	7	1767.0	-	2.803459
5	1	96.4	10	-	-	4.190658
6	2	97.5	6	1263.0	-	5.454773
7	1	52.2	6	-	-	6.046322
8	3	83.9	7	1954.0	1839.0	6.536237
9	2	83.9	20	1938.0	-	7.935545
10	2	98.1	13	1686.0	-	8.996741
11	2	63.8	15	1367.0	-	9.748394
12	3	88.9	12	1063.0	1490.0	10.870554
13	2	81.7	6	1783.0	-	11.761666

<b>Table 99 - WU, CU Acquire, Low Band, Long Sequence Waveform Trial#9 (Detected)</b>						
Burst #	# Pulses	Pulse Width (us)	Chirp (MHz)	Interval 1 to 2 (us)	Interval 2 to 3 (us)	Start time (us)
1	1	64.7	17	-	-	0.127559
2	3	75.0	19	1198.0	1947.0	1.313424
3	1	63.9	17	-	-	2.033143
4	2	74.3	12	1191.0	-	2.742211
5	1	92.1	19	-	-	3.526942
6	2	97.4	13	1748.0	-	4.188126
7	1	96.2	5	-	-	4.653011
8	3	65.1	6	1342.0	1870.0	5.183637
9	1	64.5	19	-	-	6.301565
10	2	97.3	15	1993.0	-	6.390709
11	1	56.3	17	-	-	7.612103
12	2	76.1	12	1404.0	-	8.098897
13	1	74.1	6	-	-	8.841317
14	2	63.2	12	1192.0	-	9.767782
15	2	80.7	6	1118.0	-	10.011779
16	2	81.4	17	1751.0	-	10.937946
17	2	52.5	19	1237.0	-	11.427216

<b>Table 100 - WU, CU Acquire, Low Band, Long Sequence Waveform Trial#10 (Detected)</b>						
Burst #	# Pulses	Pulse Width (us)	Chirp (MHz)	Interval 1 to 2 (us)	Interval 2 to 3 (us)	Start time (us)
1	2	84.5	12	1821.0	-	0.689931
2	3	82.1	5	1738.0	1705.0	1.508263
3	3	93.0	6	1559.0	1770.0	2.274348
4	2	72.8	14	1717.0	-	3.177716
5	2	88.7	8	1060.0	-	4.068495
6	3	53.0	7	1358.0	1753.0	5.020145
7	1	62.2	15	-	-	6.845806
8	3	69.0	19	1310.0	1396.0	7.908978
9	2	58.7	7	1090.0	-	8.554253
10	3	86.5	18	1594.0	1163.0	9.513148
11	3	96.5	9	1465.0	1473.0	10.100489
12	3	58.2	16	1232.0	1790.0	11.809651

<b>Table 101 - WU, CU Acquire, Low Band, Long Sequence Waveform Trial#11 (Detected)</b>						
Burst #	# Pulses	Pulse Width (us)	Chirp (MHz)	Interval 1 to 2 (us)	Interval 2 to 3 (us)	Start time (us)
1	1	62.0	19	-	-	0.077454
2	1	76.3	10	-	-	1.340975
3	1	90.7	13	-	-	2.263274
4	2	52.0	14	1771.0	-	3.767474
5	1	70.4	11	-	-	4.402497
6	2	51.6	9	1865.0	-	5.411367
7	1	56.2	18	-	-	6.110310
8	1	53.6	14	-	-	7.475495
9	2	68.5	8	1248.0	-	8.075989
10	1	96.1	18	-	-	9.119107
11	1	60.6	13	-	-	10.767066
12	2	88.8	5	1158.0	-	11.197335

<b>Table 102 - WU, CU Acquire, Low Band, Long Sequence Waveform Trial#12 (Detected)</b>						
Burst #	# Pulses	Pulse Width (us)	Chirp (MHz)	Interval 1 to 2 (us)	Interval 2 to 3 (us)	Start time (us)
1	3	51.8	19	1479.0	1140.0	0.319615
2	2	63.1	18	1405.0	-	1.371697
3	2	55.6	14	1681.0	-	1.875459
4	3	68.4	12	1904.0	1717.0	3.054834
5	2	58.9	10	1724.0	-	3.714877
6	2	55.6	14	1486.0	-	5.178769
7	2	81.3	5	1878.0	-	5.856454
8	3	60.5	10	1699.0	1296.0	6.490871
9	2	94.2	15	1247.0	-	7.644666
10	1	67.5	11	-	-	8.516717
11	1	84.1	10	-	-	9.256735
12	2	73.2	16	1450.0	-	10.935619
13	1	99.2	16	-	-	11.814042

<b>Table 103 - WU, CU Acquire, Low Band, Long Sequence Waveform Trial#13 (Detected)</b>						
Burst #	# Pulses	Pulse Width (us)	Chirp (MHz)	Interval 1 to 2 (us)	Interval 2 to 3 (us)	Start time (us)
1	1	63.6	11	-	-	0.311083
2	2	56.2	13	1666.0	-	1.172844
3	1	90.5	12	-	-	1.643474
4	1	56.2	13	-	-	2.034161
5	1	83.4	16	-	-	2.657791
6	3	71.1	19	1395.0	1547.0	3.435642
7	2	60.0	14	1968.0	-	4.040246
8	2	55.0	14	1049.0	-	4.809520
9	1	78.8	9	-	-	5.340943
10	2	64.4	14	1340.0	-	5.979878
11	2	79.7	18	1870.0	-	6.680686
12	1	93.1	11	-	-	7.400365
13	2	75.0	9	1714.0	-	7.652959
14	2	85.6	7	1511.0	-	8.215222
15	3	50.5	17	1177.0	1144.0	8.943964
16	2	73.5	17	1283.0	-	9.768868
17	2	78.3	18	1401.0	-	10.396450
18	3	82.9	11	1408.0	1108.0	11.193487
19	3	94.6	14	1063.0	1783.0	11.420408

<b>Table 104 - WU, CU Acquire, Low Band, Long Sequence Waveform Trial#14 (Detected)</b>						
Burst #	# Pulses	Pulse Width (us)	Chirp (MHz)	Interval 1 to 2 (us)	Interval 2 to 3 (us)	Start time (us)
1	1	59.0	13	-	-	0.604624
2	2	51.0	16	1378.0	-	0.849530
3	1	81.4	15	-	-	1.544065
4	3	68.5	9	1856.0	1237.0	2.005977
5	1	90.9	19	-	-	2.892943
6	1	53.6	19	-	-	3.687721
7	3	52.7	16	1685.0	1626.0	4.179165
8	2	93.8	8	1286.0	-	4.949193
9	1	88.2	10	-	-	5.387792
10	2	51.6	7	1688.0	-	6.150017
11	2	84.5	16	1762.0	-	6.379694
12	2	70.4	5	1491.0	-	7.433468
13	3	54.9	16	1124.0	1056.0	7.843715
14	2	82.6	16	1166.0	-	8.563686
15	2	85.4	11	1863.0	-	9.041537
16	1	82.5	20	-	-	9.903145
17	1	67.9	16	-	-	10.514219
18	2	86.8	9	1145.0	-	10.769396
19	1	76.9	5	-	-	11.533013

<b>Table 105 - WU, CU Acquire, Low Band, Long Sequence Waveform Trial#15 (Detected)</b>						
Burst #	# Pulses	Pulse Width (us)	Chirp (MHz)	Interval 1 to 2 (us)	Interval 2 to 3 (us)	Start time (us)
1	1	95.0	16	-	-	0.982002
2	2	58.0	12	1897.0	-	1.704663
3	2	62.9	11	1201.0	-	3.035700
4	3	86.2	6	1030.0	1947.0	4.125789
5	2	72.0	8	1867.0	-	5.337524
6	2	80.4	20	1871.0	-	5.972309
7	3	82.8	13	1028.0	1539.0	7.333047
8	2	64.3	20	1269.0	-	8.019729
9	2	54.9	5	1527.0	-	9.234538
10	3	55.8	16	1949.0	1827.0	10.591811
11	3	88.6	15	1954.0	1645.0	11.130131

<b>Table 106 - WU, CU Acquire, Low Band, Long Sequence Waveform Trial#16 (Detected)</b>						
Burst #	# Pulses	Pulse Width (us)	Chirp (MHz)	Interval 1 to 2 (us)	Interval 2 to 3 (us)	Start time (us)
1	2	84.9	18	1985.0	-	0.991313
2	2	73.4	17	1073.0	-	1.285174
3	3	90.6	8	1058.0	1950.0	2.541152
4	1	73.0	12	-	-	3.343438
5	2	54.0	9	1389.0	-	4.730741
6	3	98.4	17	1011.0	1973.0	5.953477
7	1	76.4	15	-	-	6.993001
8	1	96.0	15	-	-	7.265344
9	2	95.7	13	1090.0	-	8.477229
10	2	57.3	5	1840.0	-	9.483393
11	2	57.7	13	1551.0	-	10.411084
12	2	80.8	18	1635.0	-	11.300341

<b>Table 107 - WU, CU Acquire, Low Band, Long Sequence Waveform Trial#17 (Detected)</b>						
Burst #	# Pulses	Pulse Width (us)	Chirp (MHz)	Interval 1 to 2 (us)	Interval 2 to 3 (us)	Start time (us)
1	1	77.4	13	-	-	0.106020
2	2	54.7	20	1458.0	-	1.807946
3	2	68.0	15	1112.0	-	2.740722
4	2	95.7	19	1088.0	-	3.633668
5	2	99.2	6	1121.0	-	4.259921
6	1	72.7	13	-	-	5.705867
7	1	50.5	18	-	-	6.313496
8	3	75.8	14	1227.0	1547.0	7.441377
9	2	66.9	16	1772.0	-	8.360632
10	1	93.0	12	-	-	9.129735
11	2	51.6	19	1558.0	-	10.106582
12	2	56.9	15	1090.0	-	11.925069

**Table 108 - WU, CU Acquire, Low Band, Long Sequence Waveform Trial#18 (Detected)**

Burst #	# Pulses	Pulse Width (us)	Chirp (MHz)	Interval 1 to 2 (us)	Interval 2 to 3 (us)	Start time (us)
1	2	89.7	8	1160.0	-	0.877558
2	3	57.3	10	1066.0	1954.0	1.452803
3	2	85.6	11	1100.0	-	2.514860
4	2	82.6	18	1221.0	-	3.882571
5	2	67.5	12	1703.0	-	4.676106
6	1	84.0	13	-	-	5.563236
7	2	78.5	19	1205.0	-	7.011471
8	2	58.4	9	1045.0	-	8.001206
9	3	88.1	20	1846.0	1328.0	9.100353
10	1	56.4	16	-	-	10.789006
11	2	73.5	20	1698.0	-	11.676685

**Table 109 - WU, CU Acquire, Low Band, Long Sequence Waveform Trial#19 (Detected)**

Burst #	# Pulses	Pulse Width (us)	Chirp (MHz)	Interval 1 to 2 (us)	Interval 2 to 3 (us)	Start time (us)
1	2	58.3	8	1443.0	-	0.237173
2	3	61.3	9	1959.0	1070.0	1.469084
3	1	63.8	14	-	-	1.734157
4	3	79.2	18	1366.0	1054.0	3.019751
5	2	61.3	7	1493.0	-	4.207197
6	2	57.3	11	1700.0	-	4.293780
7	2	96.6	11	1200.0	-	5.518530
8	1	79.5	9	-	-	6.114103
9	3	92.2	7	1787.0	1865.0	7.372739
10	1	74.4	11	-	-	8.185263
11	3	58.8	5	1096.0	1565.0	9.275762
12	2	59.9	11	1130.0	-	9.477425
13	2	64.3	10	1364.0	-	10.954628
14	2	83.5	6	1993.0	-	11.321007

**Table 110 - WU, CU Acquire, Low Band, Long Sequence Waveform Trial#20 (Detected)**

Burst #	# Pulses	Pulse Width (us)	Chirp (MHz)	Interval 1 to 2 (us)	Interval 2 to 3 (us)	Start time (us)
1	2	58.5	12	1427.0	-	0.240951
2	2	74.0	9	1126.0	-	1.315006
3	3	89.9	6	1429.0	1407.0	2.627215
4	3	95.3	8	1429.0	1157.0	3.114823
5	1	90.4	8	-	-	4.057376
6	3	86.5	5	1633.0	1675.0	5.352176
7	2	50.2	11	1730.0	-	6.028442
8	1	52.0	13	-	-	7.998828
9	1	63.2	17	-	-	8.774786
10	1	74.6	14	-	-	9.497013
11	1	80.9	9	-	-	10.871924
12	1	80.8	14	-	-	11.391061



<b>Table 111 - WU, CU Acquire, Low Band, Long Sequence Waveform Trial#21 (Detected)</b>						
Burst #	# Pulses	Pulse Width (us)	Chirp (MHz)	Interval 1 to 2 (us)	Interval 2 to 3 (us)	Start time (us)
1	1	83.3	6	-	-	0.520899
2	3	92.9	10	1260.0	1979.0	0.919806
3	3	69.5	10	1261.0	1424.0	1.401972
4	1	68.2	12	-	-	2.297260
5	1	91.4	17	-	-	3.033217
6	3	91.1	6	1385.0	1002.0	3.787778
7	2	83.7	15	1861.0	-	4.338757
8	1	53.1	18	-	-	4.682201
9	2	79.7	19	1907.0	-	5.854979
10	3	88.9	18	1060.0	1824.0	6.628847
11	3	70.1	13	1897.0	1918.0	7.030319
12	2	55.5	17	1118.0	-	7.422500
13	2	79.3	17	1390.0	-	8.484221
14	3	70.1	7	1167.0	1827.0	9.206424
15	2	62.7	15	1644.0	-	9.806507
16	1	98.3	10	-	-	10.295701
17	2	57.0	19	1812.0	-	11.114399
18	2	95.2	13	1029.0	-	11.874331

<b>Table 112 - WU, CU Acquire, Low Band, Long Sequence Waveform Trial#22 (Detected)</b>						
Burst #	# Pulses	Pulse Width (us)	Chirp (MHz)	Interval 1 to 2 (us)	Interval 2 to 3 (us)	Start time (us)
1	3	86.3	9	1536.0	1456.0	0.191530
2	2	74.7	17	1909.0	-	1.385575
3	2	92.3	18	1659.0	-	3.199389
4	2	98.3	10	1554.0	-	4.009046
5	2	97.6	9	1146.0	-	5.327261
6	2	89.1	14	1894.0	-	6.493338
7	3	95.2	17	1255.0	1576.0	6.974828
8	2	55.8	20	1840.0	-	8.099450
9	2	82.8	11	1458.0	-	9.157478
10	2	71.6	14	1335.0	-	9.969019
11	2	56.7	10	1893.0	-	11.373194

<b>Table 113 - WU, CU Acquire, Low Band, Long Sequence Waveform Trial#23 (Detected)</b>						
Burst #	# Pulses	Pulse Width (us)	Chirp (MHz)	Interval 1 to 2 (us)	Interval 2 to 3 (us)	Start time (us)
1	2	93.1	17	1424.0	-	0.166821
2	3	61.7	18	1282.0	1896.0	0.802021
3	2	71.2	19	1324.0	-	1.963082
4	2	64.6	17	1184.0	-	2.716337
5	3	80.6	6	1557.0	1234.0	3.269116
6	1	53.2	12	-	-	4.436878
7	1	63.7	18	-	-	5.427642
8	2	70.6	16	1316.0	-	5.974897
9	2	92.6	16	1494.0	-	7.158778
10	3	97.0	10	1115.0	1336.0	7.864407
11	2	98.0	6	1687.0	-	8.208008
12	2	70.4	13	1735.0	-	9.294054
13	1	69.5	11	-	-	10.279875
14	1	93.0	12	-	-	10.977046
15	2	58.8	7	1772.0	-	11.960283

<b>Table 114 - WU, CU Acquire, Low Band, Long Sequence Waveform Trial#24 (Detected)</b>						
Burst #	# Pulses	Pulse Width (us)	Chirp (MHz)	Interval 1 to 2 (us)	Interval 2 to 3 (us)	Start time (us)
1	2	93.2	6	1855.0	-	0.211441
2	2	96.2	12	1963.0	-	1.055253
3	2	67.9	14	1035.0	-	1.282298
4	2	57.3	7	1594.0	-	2.129894
5	2	90.3	18	1037.0	-	2.897277
6	2	74.8	6	1640.0	-	3.302311
7	3	75.5	6	1698.0	1349.0	4.091236
8	2	84.2	20	1281.0	-	4.610481
9	3	56.7	8	1425.0	1632.0	5.325309
10	2	88.3	6	1255.0	-	5.467801
11	3	77.1	6	1953.0	1415.0	6.408248
12	3	71.8	16	1002.0	1903.0	6.898017
13	2	64.1	16	1680.0	-	7.550804
14	3	91.0	6	1443.0	1863.0	7.965622
15	1	77.7	16	-	-	8.834124
16	2	53.3	7	1512.0	-	9.486605
17	2	71.6	14	1757.0	-	9.900222
18	3	99.1	18	1858.0	1480.0	10.795935
19	2	88.5	6	1895.0	-	11.267130
20	1	93.2	12	-	-	11.872112

<b>Table 115 - WU, CU Acquire, Low Band, Long Sequence Waveform Trial#25 (Detected)</b>						
Burst #	# Pulses	Pulse Width (us)	Chirp (MHz)	Interval 1 to 2 (us)	Interval 2 to 3 (us)	Start time (us)
1	2	82.1	20	1024.0	-	0.545573
2	2	61.9	11	1587.0	-	1.416605
3	2	55.9	8	1477.0	-	1.798400
4	3	62.5	8	1280.0	1650.0	2.361326
5	2	87.9	19	1539.0	-	3.114863
6	1	69.3	12	-	-	4.110743
7	2	64.7	18	1440.0	-	5.146507
8	2	82.2	9	1701.0	-	5.435091
9	2	58.9	12	1432.0	-	6.498110
10	1	85.8	11	-	-	7.422536
11	1	82.5	16	-	-	7.824283
12	2	64.2	13	1828.0	-	8.517262
13	2	86.7	6	1171.0	-	9.457569
14	1	78.6	18	-	-	10.285502
15	2	75.1	12	1785.0	-	10.745708
16	1	88.3	8	-	-	11.915143

<b>Table 116 - WU, CU Acquire, Low Band, Long Sequence Waveform Trial#26 (Detected)</b>						
Burst #	# Pulses	Pulse Width (us)	Chirp (MHz)	Interval 1 to 2 (us)	Interval 2 to 3 (us)	Start time (us)
1	2	93.2	5	1512.0	-	0.215621
2	3	76.2	18	1401.0	1222.0	1.825620
3	2	52.0	17	1705.0	-	2.730575
4	3	73.0	16	1733.0	1293.0	3.271808
5	1	50.3	12	-	-	3.958065
6	3	74.9	12	1428.0	1597.0	4.910440
7	1	53.8	6	-	-	5.585751
8	3	76.8	5	1785.0	1464.0	6.804864
9	2	66.2	9	1743.0	-	8.260913
10	1	58.8	8	-	-	8.746282
11	3	67.1	11	1687.0	1641.0	9.950000
12	2	92.2	9	1059.0	-	10.857841
13	2	97.4	8	1898.0	-	11.914855

Burst #	# Pulses	Pulse Width (us)	Chirp (MHz)	Interval 1 to 2 (us)	Interval 2 to 3 (us)	Start time (us)
1	2	69.7	14	1056.0	-	0.797913
2	2	92.2	8	1851.0	-	1.499596
3	1	90.2	5	-	-	2.291584
4	3	98.2	9	1398.0	1968.0	2.785597
5	1	95.6	6	-	-	4.363056
6	2	51.1	14	1200.0	-	4.792524
7	1	69.5	16	-	-	5.894486
8	1	84.0	19	-	-	6.512966
9	1	74.7	8	-	-	8.124167
10	3	83.3	14	1444.0	1422.0	8.645196
11	3	61.4	8	1499.0	1068.0	9.331940
12	3	62.6	6	1146.0	1762.0	10.218339
13	2	98.3	10	1095.0	-	11.309613

Burst #	# Pulses	Pulse Width (us)	Chirp (MHz)	Interval 1 to 2 (us)	Interval 2 to 3 (us)	Start time (us)
1	1	70.4	9	-	-	0.052634
2	2	81.8	8	1591.0	-	1.052510
3	2	65.0	13	1574.0	-	2.303299
4	1	99.3	20	-	-	3.260145
5	1	91.5	8	-	-	4.569092
6	2	95.7	18	1580.0	-	4.760761
7	1	66.4	6	-	-	6.183808
8	2	50.1	7	1451.0	-	7.094610
9	1	86.0	20	-	-	8.147209
10	3	70.5	8	1369.0	1393.0	8.579354
11	2	53.8	18	1064.0	-	9.558900
12	2	95.2	8	1192.0	-	10.211166
13	2	74.1	10	1287.0	-	11.862434

Burst #	# Pulses	Pulse Width (us)	Chirp (MHz)	Interval 1 to 2 (us)	Interval 2 to 3 (us)	Start time (us)
1	3	60.7	17	1582.0	1006.0	0.628971
2	3	67.6	9	1129.0	1727.0	2.354321
3	2	94.1	18	1305.0	-	2.488335
4	1	96.9	5	-	-	4.727977
5	2	55.4	16	1366.0	-	5.963097
6	1	96.2	13	-	-	6.621174
7	3	80.3	5	1506.0	1007.0	8.288989
8	3	62.0	17	1195.0	1543.0	9.194933
9	1	51.4	15	-	-	9.645784
10	3	79.8	11	1881.0	1762.0	11.705801

<b>Table 120 - WU, CU Acquire, Low Band, Long Sequence Waveform Trial#30 (Detected)</b>						
Burst #	# Pulses	Pulse Width (us)	Chirp (MHz)	Interval 1 to 2 (us)	Interval 2 to 3 (us)	Start time (us)
1	3	70.7	14	1138.0	1181.0	0.441758
2	2	85.3	17	1607.0	-	0.675021
3	2	90.9	11	1800.0	-	1.356248
4	2	95.1	8	1960.0	-	2.254329
5	1	96.3	8	-	-	2.601235
6	2	96.0	7	1011.0	-	3.483116
7	1	79.0	12	-	-	4.026436
8	2	59.8	7	1002.0	-	4.639560
9	2	56.6	19	1155.0	-	5.246656
10	2	87.8	14	1143.0	-	5.807811
11	3	78.4	15	1576.0	1084.0	6.447895
12	1	91.8	11	-	-	6.863043
13	2	95.7	14	1626.0	-	7.438524
14	1	52.5	13	-	-	8.310199
15	2	63.7	9	1274.0	-	8.911622
16	3	73.7	15	1904.0	1019.0	9.000992
17	1	80.7	18	-	-	9.741555
18	2	80.4	11	1414.0	-	10.303730
19	3	77.9	19	1035.0	1342.0	10.987069
20	3	58.2	7	1115.0	1137.0	11.871533

Table 121 - FCC frequency hopping radar (Type 6) Results, WU, CU Acquire, Low Band						
Trial #	Pulses/ Burst	Pulse Width (us)	PRI (us)	Detected	Fr (MHz) and level (dBm)	Burst Information
1	9	1.0	333.0	Yes	5294.8MHz, -62.0dBm	Hop sequence: 5409, 5628, 5330, 5525, 5304, 5461, 5297, 5473, 5696, 5644, 5283, 5419, 5291, 5572, 5661, 5282, 5386, 5448, 5648, 5597, 5689, 5722, 5605, 5324, 5588, 5561, 5678, 5321, 5346, 5537, 5686, 5301, 5449, 5564, 5579, 5676, 5322, 5440, 5671, 5464, 5349, 5450, 5385, 5586, 5477, 5296, 5466, 5574, 5433, 5438, 5679, 5635, 5514, 5702, 5633, 5657, 5308, 5559, 5530, 5650, 5673, 5627, 5355, 5685, 5646, 5319, 5680, 5387, 5659, 5392, 5488, 5279, 5376, 5591, 5623, 5418, 5667, 5510, 5293, 5656, 5364, 5427, 5260, 5272, 5269, 5494, 5415, 5467, 5612, 5258, 5567, 5366, 5592, 5261, 5460, 5707, 5384, 5542, 5725, 5520 (5 hits) (03/26/2012 02:16:53 PM)
2	9	1.0	333.0	Yes	5295.8MHz, -62.0dBm	Hop sequence: 5502, 5654, 5288, 5406, 5557, 5571, 5681, 5696, 5452, 5551, 5391, 5582, 5709, 5425, 5581, 5700, 5384, 5423, 5408, 5472, 5351, 5657, 5639, 5580, 5293, 5335, 5398, 5475, 5723, 5517, 5611, 5713, 5716, 5455, 5467, 5349, 5303, 5568, 5341, 5284, 5645, 5572, 5647, 5555, 5333, 5640, 5663, 5470, 5381, 5484, 5371, 5676, 5500, 5479, 5261, 5368, 5642, 5641, 5493, 5382, 5385, 5344, 5554, 5664, 5289, 5447, 5429, 5509, 5393, 5536, 5615, 5575, 5312, 5379, 5719, 5539, 5506, 5256, 5326, 5590, 5566, 5496, 5486, 5680, 5620, 5556, 5521, 5699, 5689, 5543, 5596, 5675, 5666, 5487, 5362, 5308, 5670, 5421, 5354, 5388 (4 hits) (03/26/2012 02:17:02 PM)
3	9	1.0	333.0	Yes	5273.8MHz, -62.0dBm	Hop sequence: 5629, 5529, 5684, 5712, 5571, 5494, 5408, 5323, 5720, 5714, 5389, 5520, 5669, 5313, 5318, 5707, 5572, 5703, 5705, 5435, 5360, 5603, 5534, 5521, 5342, 5285, 5398, 5473, 5311, 5612, 5482, 5664, 5644, 5611, 5522, 5252, 5397, 5581, 5386, 5287, 5268, 5400, 5445, 5695, 5464, 5373, 5650, 5346,

Table 121 - FCC frequency hopping radar (Type 6) Results, WU, CU Acquire, Low Band						
Trial #	Pulses/ Burst	Pulse Width (us)	PRI (us)	Detected	Fr (MHz) and level (dBm)	Burst Information
						5555, 5348, 5570, 5357, 5331, 5283, 5481, 5478, 5700, 5443, 5667, 5500, 5379, 5637, 5530, 5566, 5681, 5436, 5352, 5662, 5579, 5382, 5300, 5316, 5335, 5550, 5672, 5573, 5661, 5402, 5565, 5380, 5724, 5420, 5274, 5642, 5393, 5615, 5460, 5489, 5587, 5442, 5466, 5358, 5254, 5347, 5718, 5328, 5296, 5298, 5535, 5401 (4 hits) (03/26/2012 02:17:08 PM)
4	9	1.0	333.0	Yes	5274.8MHz, -62.0dBm	Hop sequence: 5690, 5373, 5433, 5708, 5366, 5614, 5427, 5476, 5504, 5670, 5294, 5311, 5363, 5286, 5537, 5272, 5724, 5446, 5317, 5360, 5483, 5651, 5582, 5673, 5599, 5333, 5423, 5593, 5264, 5568, 5377, 5567, 5570, 5514, 5439, 5324, 5357, 5506, 5640, 5362, 5585, 5335, 5465, 5364, 5498, 5612, 5596, 5472, 5471, 5365, 5509, 5277, 5415, 5637, 5703, 5455, 5477, 5409, 5342, 5281, 5672, 5580, 5571, 5482, 5386, 5285, 5336, 5445, 5573, 5460, 5633, 5408, 5393, 5575, 5532, 5631, 5275, 5389, 5711, 5487, 5497, 5515, 5718, 5318, 5447, 5682, 5627, 5566, 5712, 5676, 5547, 5337, 5486, 5397, 5494, 5503, 5316, 5282, 5370, 5569 (7 hits) (03/26/2012 02:17:16 PM)
5	9	1.0	333.0	Yes	5275.8MHz, -62.0dBm	Hop sequence: 5412, 5691, 5645, 5489, 5505, 5522, 5464, 5367, 5622, 5262, 5504, 5257, 5479, 5521, 5446, 5404, 5634, 5366, 5364, 5492, 5700, 5361, 5451, 5347, 5462, 5584, 5665, 5312, 5356, 5529, 5330, 5255, 5342, 5630, 5258, 5527, 5684, 5546, 5267, 5604, 5578, 5678, 5712, 5639, 5375, 5432, 5658, 5510, 5477, 5303, 5304, 5607, 5650, 5676, 5319, 5576, 5282, 5547, 5540, 5270, 5631, 5649, 5561, 5651, 5637, 5575, 5456, 5717, 5690, 5701, 5664, 5295, 5283, 5263, 5393, 5343, 5640, 5543, 5699, 5268, 5577, 5442, 5478, 5606, 5687, 5581, 5520, 5516, 5281, 5310, 5500, 5336, 5718, 5530, 5567, 5467, 5524, 5596, 5722, 5573 (4 hits) (03/26/2012

Table 121 - FCC frequency hopping radar (Type 6) Results, WU, CU Acquire, Low Band						
Trial #	Pulses/ Burst	Pulse Width (us)	PRI (us)	Detected	Fr (MHz) and level (dBm)	Burst Information
						02:17:25 PM)
6	9	1.0	333.0	Yes	5276.8MHz, -62.0dBm	Hop sequence: 5284, 5417, 5573, 5692, 5422, 5447, 5357, 5427, 5275, 5718, 5597, 5648, 5271, 5630, 5555, 5451, 5449, 5628, 5396, 5610, 5428, 5690, 5328, 5277, 5453, 5425, 5655, 5346, 5637, 5512, 5493, 5343, 5382, 5611, 5286, 5337, 5308, 5590, 5662, 5482, 5720, 5444, 5264, 5298, 5261, 5639, 5331, 5316, 5694, 5664, 5454, 5653, 5299, 5652, 5560, 5390, 5542, 5703, 5622, 5383, 5568, 5355, 5292, 5368, 5686, 5645, 5717, 5567, 5509, 5460, 5327, 5612, 5489, 5268, 5602, 5303, 5400, 5388, 5279, 5634, 5457, 5317, 5312, 5522, 5339, 5283, 5391, 5415, 5472, 5631, 5467, 5707, 5301, 5658, 5369, 5606, 5267, 5430, 5553, 5409 (7 hits) (03/26/2012 02:17:36 PM)
7	9	1.0	333.0	Yes	5277.8MHz, -62.0dBm	Hop sequence: 5709, 5413, 5550, 5353, 5475, 5706, 5305, 5575, 5561, 5423, 5509, 5555, 5597, 5281, 5629, 5260, 5498, 5514, 5674, 5425, 5598, 5275, 5517, 5412, 5570, 5545, 5539, 5568, 5421, 5529, 5523, 5351, 5587, 5368, 5526, 5296, 5359, 5252, 5391, 5456, 5515, 5610, 5264, 5415, 5335, 5289, 5593, 5417, 5485, 5286, 5557, 5486, 5316, 5404, 5430, 5379, 5454, 5276, 5698, 5429, 5398, 5410, 5471, 5642, 5363, 5271, 5619, 5618, 5588, 5319, 5477, 5384, 5633, 5323, 5577, 5340, 5308, 5713, 5502, 5303, 5314, 5679, 5576, 5689, 5657, 5377, 5551, 5258, 5367, 5723, 5620, 5717, 5255, 5499, 5254, 5461, 5416, 5420, 5704, 5349 (5 hits) (03/26/2012 02:17:44 PM)
8	9	1.0	333.0	Yes	5278.8MHz, -62.0dBm	Hop sequence: 5512, 5447, 5373, 5683, 5520, 5499, 5552, 5653, 5593, 5440, 5610, 5566, 5658, 5421, 5527, 5484, 5662, 5467, 5623, 5317, 5453, 5399, 5305, 5275, 5647, 5565, 5319, 5564, 5716, 5267, 5698, 5515, 5504, 5377, 5627, 5524, 5338, 5530, 5283, 5643, 5298, 5357, 5279, 5665, 5474, 5433, 5423, 5400,



Table 121 - FCC frequency hopping radar (Type 6) Results, WU, CU Acquire, Low Band						
Trial #	Pulses/ Burst	Pulse Width (us)	PRI (us)	Detected	Fr (MHz) and level (dBm)	Burst Information
						5608, 5560, 5701, 5555, 5443, 5684, 5389, 5448, 5583, 5522, 5622, 5461, 5468, 5439, 5611, 5664, 5661, 5321, 5668, 5531, 5687, 5470, 5632, 5696, 5680, 5595, 5343, 5350, 5526, 5391, 5270, 5670, 5434, 5509, 5603, 5325, 5410, 5620, 5472, 5342, 5501, 5644, 5482, 5332, 5523, 5360, 5559, 5415, 5413, 5656, 5368, 5678 (3 hits) (03/26/2012 02:17:54 PM)
9	9	1.0	333.0	Yes	5279.8MHz, -62.0dBm	Hop sequence: 5723, 5395, 5254, 5615, 5689, 5303, 5622, 5693, 5353, 5534, 5725, 5538, 5483, 5277, 5519, 5412, 5513, 5441, 5481, 5345, 5563, 5385, 5309, 5570, 5332, 5351, 5592, 5549, 5432, 5559, 5607, 5708, 5251, 5472, 5555, 5333, 5706, 5264, 5584, 5410, 5414, 5485, 5338, 5349, 5319, 5521, 5425, 5294, 5397, 5630, 5629, 5468, 5456, 5324, 5542, 5503, 5446, 5415, 5372, 5267, 5265, 5314, 5581, 5288, 5507, 5478, 5280, 5487, 5269, 5484, 5586, 5642, 5396, 5647, 5273, 5450, 5292, 5392, 5718, 5637, 5553, 5719, 5516, 5512, 5694, 5721, 5300, 5290, 5471, 5479, 5364, 5398, 5301, 5491, 5378, 5325, 5597, 5470, 5517, 5271 (6 hits) (03/26/2012 02:18:05 PM)
10	9	1.0	333.0	Yes	5280.8MHz, -62.0dBm	Hop sequence: 5603, 5664, 5627, 5709, 5535, 5500, 5330, 5336, 5362, 5485, 5469, 5583, 5702, 5361, 5438, 5657, 5616, 5585, 5318, 5668, 5601, 5396, 5708, 5628, 5356, 5406, 5421, 5551, 5378, 5379, 5408, 5609, 5329, 5268, 5414, 5420, 5338, 5389, 5651, 5309, 5594, 5403, 5370, 5640, 5325, 5611, 5576, 5482, 5572, 5297, 5543, 5632, 5319, 5337, 5629, 5537, 5316, 5645, 5294, 5477, 5401, 5541, 5418, 5371, 5340, 5381, 5404, 5624, 5722, 5445, 5646, 5397, 5538, 5665, 5724, 5530, 5317, 5546, 5345, 5359, 5265, 5290, 5306, 5643, 5633, 5641, 5394, 5429, 5339, 5417, 5712, 5714, 5346, 5562, 5369, 5686, 5718, 5276, 5267, 5412 (3 hits) (03/26/2012

Table 121 - FCC frequency hopping radar (Type 6) Results, WU, CU Acquire, Low Band						
Trial #	Pulses/ Burst	Pulse Width (us)	PRI (us)	Detected	Fr (MHz) and level (dBm)	Burst Information
						02:18:14 PM)
11	9	1.0	333.0	Yes	5281.8MHz, -62.0dBm	Hop sequence: 5385, 5267, 5715, 5536, 5668, 5600, 5407, 5556, 5438, 5687, 5547, 5563, 5414, 5549, 5443, 5680, 5332, 5589, 5544, 5598, 5388, 5442, 5473, 5256, 5614, 5279, 5713, 5711, 5360, 5675, 5408, 5278, 5268, 5263, 5567, 5476, 5392, 5683, 5655, 5548, 5261, 5694, 5441, 5330, 5674, 5453, 5658, 5381, 5524, 5336, 5404, 5283, 5603, 5502, 5367, 5269, 5554, 5550, 5580, 5351, 5382, 5468, 5366, 5282, 5573, 5354, 5672, 5257, 5637, 5586, 5665, 5628, 5294, 5470, 5417, 5277, 5633, 5686, 5481, 5341, 5329, 5488, 5311, 5693, 5493, 5297, 5630, 5616, 5661, 5606, 5323, 5383, 5355, 5303, 5254, 5423, 5446, 5433, 5704, 5607 (6 hits) (03/26/2012 02:18:21 PM)
12	9	1.0	333.0	Yes	5282.8MHz, -62.0dBm	Hop sequence: 5311, 5554, 5343, 5322, 5550, 5398, 5326, 5350, 5443, 5488, 5572, 5605, 5392, 5636, 5387, 5282, 5379, 5276, 5380, 5494, 5589, 5644, 5492, 5580, 5312, 5618, 5490, 5704, 5722, 5551, 5606, 5715, 5669, 5424, 5539, 5582, 5505, 5532, 5541, 5415, 5683, 5318, 5355, 5258, 5417, 5274, 5261, 5549, 5682, 5338, 5658, 5513, 5516, 5594, 5366, 5555, 5377, 5308, 5270, 5466, 5264, 5298, 5517, 5705, 5265, 5430, 5421, 5649, 5693, 5538, 5373, 5452, 5692, 5460, 5654, 5672, 5489, 5662, 5627, 5327, 5512, 5725, 5665, 5487, 5404, 5260, 5634, 5376, 5485, 5351, 5603, 5435, 5552, 5557, 5586, 5464, 5335, 5309, 5320, 5467 (3 hits) (03/26/2012 02:18:29 PM)
13	9	1.0	333.0	Yes	5283.8MHz, -62.0dBm	Hop sequence: 5278, 5485, 5466, 5279, 5648, 5504, 5333, 5702, 5579, 5281, 5696, 5621, 5545, 5265, 5634, 5673, 5591, 5627, 5688, 5626, 5354, 5593, 5552, 5381, 5492, 5313, 5642, 5653, 5297, 5412, 5641, 5664, 5339, 5343, 5377, 5479, 5618, 5430, 5594, 5577, 5724, 5703, 5321, 5317, 5362, 5677, 5391, 5489,

Table 121 - FCC frequency hopping radar (Type 6) Results, WU, CU Acquire, Low Band						
Trial #	Pulses/ Burst	Pulse Width (us)	PRI (us)	Detected	Fr (MHz) and level (dBm)	Burst Information
						5638, 5344, 5706, 5669, 5717, 5715, 5714, 5425, 5550, 5384, 5337, 5348, 5487, 5617, 5262, 5639, 5554, 5408, 5370, 5528, 5421, 5409, 5318, 5613, 5645, 5532, 5507, 5326, 5365, 5598, 5588, 5443, 5698, 5375, 5465, 5473, 5629, 5707, 5441, 5568, 5622, 5424, 5581, 5477, 5697, 5494, 5371, 5544, 5587, 5680, 5482, 5632 (3 hits) (03/26/2012 02:18:36 PM)
14	9	1.0	333.0	Yes	5284.8MHz, -62.0dBm	Hop sequence: 5647, 5389, 5444, 5694, 5584, 5577, 5455, 5336, 5352, 5589, 5435, 5403, 5330, 5643, 5393, 5526, 5721, 5565, 5671, 5704, 5632, 5357, 5441, 5662, 5423, 5344, 5699, 5722, 5715, 5624, 5689, 5544, 5374, 5342, 5709, 5470, 5446, 5595, 5449, 5561, 5320, 5461, 5298, 5609, 5600, 5534, 5297, 5343, 5616, 5299, 5537, 5506, 5265, 5465, 5331, 5573, 5636, 5507, 5327, 5492, 5497, 5563, 5348, 5478, 5302, 5723, 5285, 5439, 5365, 5360, 5272, 5416, 5293, 5664, 5479, 5282, 5345, 5460, 5496, 5564, 5627, 5646, 5338, 5369, 5314, 5712, 5476, 5432, 5462, 5427, 5701, 5351, 5692, 5559, 5321, 5614, 5255, 5719, 5322, 5574 (3 hits) (03/26/2012 02:18:44 PM)
15	9	1.0	333.0	Yes	5285.8MHz, -62.0dBm	Hop sequence: 5660, 5308, 5623, 5423, 5569, 5435, 5445, 5280, 5652, 5283, 5504, 5690, 5383, 5336, 5370, 5664, 5415, 5562, 5377, 5593, 5484, 5620, 5697, 5312, 5329, 5669, 5713, 5611, 5343, 5715, 5673, 5608, 5588, 5277, 5301, 5332, 5628, 5439, 5633, 5625, 5489, 5491, 5639, 5520, 5629, 5642, 5431, 5585, 5315, 5379, 5695, 5274, 5328, 5418, 5393, 5259, 5602, 5631, 5424, 5358, 5469, 5387, 5349, 5680, 5523, 5502, 5487, 5284, 5464, 5485, 5297, 5425, 5260, 5276, 5350, 5539, 5663, 5483, 5558, 5655, 5364, 5705, 5546, 5552, 5366, 5530, 5624, 5430, 5468, 5561, 5281, 5573, 5273, 5398, 5322, 5441, 5632, 5467, 5667, 5512 (7 hits) (03/26/2012

Table 121 - FCC frequency hopping radar (Type 6) Results, WU, CU Acquire, Low Band						
Trial #	Pulses/ Burst	Pulse Width (us)	PRI (us)	Detected	Fr (MHz) and level (dBm)	Burst Information
						02:18:53 PM)
16	9	1.0	333.0	Yes	5286.8MHz, -62.0dBm	Hop sequence: 5701, 5604, 5574, 5266, 5609, 5290, 5576, 5518, 5448, 5557, 5475, 5460, 5336, 5481, 5314, 5652, 5474, 5617, 5387, 5638, 5553, 5463, 5466, 5442, 5440, 5343, 5663, 5404, 5467, 5315, 5422, 5369, 5506, 5366, 5337, 5419, 5529, 5564, 5292, 5542, 5453, 5296, 5438, 5503, 5639, 5585, 5371, 5348, 5693, 5484, 5491, 5349, 5678, 5255, 5606, 5452, 5646, 5648, 5429, 5625, 5350, 5328, 5677, 5305, 5297, 5306, 5565, 5555, 5599, 5621, 5508, 5628, 5645, 5720, 5357, 5587, 5287, 5479, 5260, 5520, 5308, 5545, 5592, 5643, 5415, 5340, 5464, 5580, 5594, 5658, 5469, 5527, 5674, 5344, 5317, 5269, 5540, 5615, 5521, 5659 (3 hits) (03/26/2012 02:19:05 PM)
17	9	1.0	333.0	Yes	5287.8MHz, -62.0dBm	Hop sequence: 5427, 5304, 5661, 5532, 5270, 5716, 5523, 5495, 5659, 5670, 5284, 5635, 5479, 5338, 5469, 5287, 5713, 5525, 5571, 5668, 5565, 5266, 5517, 5389, 5601, 5445, 5314, 5522, 5553, 5504, 5695, 5285, 5480, 5534, 5717, 5616, 5311, 5320, 5334, 5352, 5322, 5581, 5507, 5502, 5348, 5271, 5632, 5300, 5587, 5373, 5604, 5342, 5306, 5377, 5372, 5356, 5488, 5652, 5590, 5253, 5611, 5608, 5719, 5481, 5685, 5671, 5527, 5435, 5596, 5578, 5599, 5683, 5399, 5711, 5650, 5343, 5384, 5487, 5640, 5622, 5307, 5256, 5390, 5645, 5660, 5268, 5278, 5395, 5409, 5283, 5544, 5431, 5718, 5309, 5375, 5631, 5674, 5499, 5692, 5526 (5 hits) (03/26/2012 02:19:14 PM)
18	9	1.0	333.0	Yes	5288.8MHz, -62.0dBm	Hop sequence: 5534, 5522, 5281, 5599, 5548, 5699, 5703, 5432, 5321, 5336, 5381, 5274, 5330, 5641, 5452, 5283, 5422, 5629, 5560, 5568, 5500, 5268, 5529, 5424, 5572, 5357, 5696, 5633, 5717, 5262, 5645, 5701, 5528, 5299, 5337, 5590, 5443, 5393, 5466, 5425, 5474, 5603, 5537, 5497, 5459, 5596, 5396, 5688,

Table 121 - FCC frequency hopping radar (Type 6) Results, WU, CU Acquire, Low Band						
Trial #	Pulses/ Burst	Pulse Width (us)	PRI (us)	Detected	Fr (MHz) and level (dBm)	Burst Information
						5333, 5456, 5598, 5656, 5585, 5624, 5686, 5718, 5527, 5644, 5493, 5657, 5373, 5690, 5410, 5406, 5723, 5277, 5301, 5479, 5627, 5505, 5392, 5397, 5367, 5582, 5322, 5643, 5261, 5532, 5449, 5403, 5615, 5524, 5510, 5395, 5587, 5654, 5445, 5352, 5469, 5431, 5340, 5725, 5683, 5496, 5660, 5565, 5311, 5707, 5453, 5667 (4 hits) (03/26/2012 02:19:28 PM)
19	9	1.0	333.0	Yes	5289.8MHz, -62.0dBm	Hop sequence: 5537, 5630, 5531, 5650, 5681, 5657, 5320, 5396, 5612, 5714, 5381, 5259, 5363, 5428, 5332, 5516, 5467, 5548, 5294, 5480, 5356, 5666, 5644, 5342, 5482, 5530, 5687, 5403, 5305, 5322, 5285, 5679, 5455, 5662, 5502, 5368, 5461, 5434, 5523, 5311, 5529, 5251, 5578, 5665, 5622, 5674, 5538, 5288, 5617, 5616, 5479, 5317, 5721, 5301, 5647, 5570, 5712, 5525, 5296, 5453, 5586, 5336, 5693, 5313, 5255, 5506, 5722, 5459, 5379, 5271, 5351, 5398, 5589, 5703, 5287, 5295, 5292, 5542, 5337, 5425, 5330, 5280, 5297, 5568, 5551, 5424, 5298, 5355, 5704, 5451, 5518, 5338, 5500, 5552, 5469, 5566, 5268, 5390, 5309, 5495 (7 hits) (03/26/2012 02:19:38 PM)
20	9	1.0	333.0	Yes	5290.8MHz, -62.0dBm	Hop sequence: 5364, 5565, 5272, 5530, 5551, 5595, 5383, 5270, 5525, 5378, 5299, 5302, 5286, 5491, 5613, 5658, 5615, 5276, 5419, 5374, 5725, 5649, 5264, 5294, 5444, 5274, 5639, 5545, 5480, 5377, 5645, 5641, 5686, 5692, 5338, 5466, 5446, 5569, 5339, 5677, 5471, 5426, 5432, 5572, 5313, 5375, 5311, 5300, 5664, 5469, 5278, 5621, 5403, 5541, 5373, 5418, 5630, 5552, 5644, 5691, 5308, 5251, 5317, 5342, 5324, 5477, 5592, 5690, 5441, 5473, 5722, 5334, 5292, 5499, 5542, 5715, 5680, 5464, 5335, 5304, 5723, 5326, 5681, 5346, 5570, 5401, 5604, 5600, 5543, 5718, 5440, 5321, 5721, 5558, 5720, 5593, 5462, 5637, 5350, 5494 (6 hits) (03/26/2012

Table 121 - FCC frequency hopping radar (Type 6) Results, WU, CU Acquire, Low Band						
Trial #	Pulses/ Burst	Pulse Width (us)	PRI (us)	Detected	Fr (MHz) and level (dBm)	Burst Information
						02:19:48 PM)
21	9	1.0	333.0	Yes	5291.8MHz, -62.0dBm	Hop sequence: 5464, 5369, 5558, 5290, 5567, 5514, 5628, 5415, 5306, 5513, 5496, 5381, 5399, 5675, 5530, 5411, 5450, 5657, 5581, 5518, 5338, 5414, 5504, 5669, 5672, 5316, 5308, 5503, 5436, 5622, 5258, 5599, 5419, 5562, 5291, 5295, 5560, 5403, 5676, 5426, 5603, 5445, 5434, 5425, 5497, 5636, 5637, 5555, 5697, 5561, 5719, 5459, 5718, 5534, 5688, 5372, 5380, 5365, 5404, 5598, 5268, 5488, 5589, 5707, 5390, 5509, 5710, 5662, 5263, 5621, 5602, 5611, 5454, 5435, 5343, 5350, 5480, 5529, 5276, 5257, 5326, 5344, 5556, 5398, 5494, 5417, 5261, 5500, 5259, 5400, 5317, 5465, 5362, 5522, 5634, 5444, 5593, 5512, 5591, 5307 (4 hits) (03/26/2012 02:19:54 PM)
22	9	1.0	333.0	Yes	5292.8MHz, -62.0dBm	Hop sequence: 5266, 5598, 5525, 5548, 5712, 5509, 5574, 5440, 5538, 5536, 5675, 5464, 5642, 5308, 5409, 5693, 5590, 5410, 5350, 5700, 5329, 5309, 5567, 5603, 5597, 5542, 5273, 5312, 5406, 5252, 5703, 5281, 5301, 5667, 5303, 5344, 5592, 5714, 5399, 5706, 5564, 5487, 5296, 5387, 5485, 5504, 5447, 5584, 5630, 5285, 5622, 5451, 5716, 5459, 5316, 5550, 5556, 5479, 5713, 5441, 5391, 5382, 5627, 5546, 5340, 5588, 5541, 5481, 5279, 5559, 5293, 5572, 5652, 5558, 5429, 5514, 5412, 5689, 5663, 5421, 5695, 5356, 5609, 5683, 5685, 5341, 5384, 5334, 5508, 5307, 5636, 5668, 5261, 5718, 5389, 5530, 5453, 5707, 5510, 5723 (4 hits) (03/26/2012 02:20:02 PM)
23	9	1.0	333.0	Yes	5293.8MHz, -62.0dBm	Hop sequence: 5409, 5358, 5613, 5661, 5346, 5407, 5608, 5707, 5484, 5514, 5289, 5451, 5490, 5536, 5646, 5427, 5432, 5462, 5455, 5311, 5546, 5590, 5574, 5569, 5485, 5710, 5416, 5378, 5372, 5544, 5400, 5525, 5414, 5327, 5665, 5419, 5390, 5383, 5549, 5395, 5499, 5504, 5470, 5633, 5389, 5354, 5593, 5554,

Table 121 - FCC frequency hopping radar (Type 6) Results, WU, CU Acquire, Low Band						
Trial #	Pulses/ Burst	Pulse Width (us)	PRI (us)	Detected	Fr (MHz) and level (dBm)	Burst Information
						5481, 5603, 5277, 5323, 5257, 5333, 5476, 5450, 5538, 5488, 5624, 5508, 5293, 5263, 5405, 5680, 5495, 5705, 5632, 5260, 5467, 5271, 5318, 5637, 5391, 5258, 5719, 5315, 5670, 5506, 5610, 5717, 5272, 5307, 5714, 5379, 5478, 5261, 5703, 5366, 5692, 5259, 5357, 5430, 5255, 5288, 5696, 5371, 5471, 5436, 5394, 5622 (4 hits) (03/26/2012 02:20:11 PM)
24	9	1.0	333.0	Yes	5294.8MHz, -62.0dBm	Hop sequence: 5588, 5441, 5664, 5624, 5289, 5501, 5701, 5460, 5291, 5304, 5322, 5377, 5309, 5448, 5680, 5528, 5706, 5522, 5644, 5553, 5465, 5510, 5413, 5323, 5265, 5634, 5655, 5600, 5636, 5437, 5640, 5618, 5318, 5506, 5595, 5619, 5368, 5641, 5602, 5567, 5253, 5431, 5494, 5341, 5617, 5694, 5390, 5509, 5388, 5420, 5355, 5691, 5312, 5545, 5631, 5578, 5589, 5520, 5356, 5484, 5605, 5472, 5725, 5642, 5468, 5683, 5585, 5489, 5479, 5269, 5492, 5389, 5660, 5603, 5395, 5674, 5717, 5695, 5321, 5421, 5511, 5517, 5657, 5507, 5587, 5273, 5475, 5462, 5307, 5556, 5340, 5264, 5354, 5548, 5606, 5562, 5278, 5670, 5400, 5452 (3 hits) (03/26/2012 02:20:27 PM)
25	9	1.0	333.0	Yes	5295.8MHz, -62.0dBm	Hop sequence: 5398, 5344, 5520, 5332, 5291, 5275, 5251, 5421, 5425, 5689, 5626, 5326, 5284, 5406, 5601, 5582, 5260, 5336, 5660, 5633, 5271, 5323, 5535, 5566, 5565, 5404, 5625, 5688, 5301, 5352, 5693, 5276, 5381, 5499, 5649, 5419, 5295, 5708, 5644, 5661, 5486, 5279, 5632, 5435, 5272, 5575, 5285, 5705, 5263, 5537, 5587, 5466, 5463, 5386, 5508, 5686, 5704, 5470, 5488, 5512, 5367, 5579, 5395, 5288, 5562, 5671, 5479, 5641, 5465, 5621, 5618, 5717, 5396, 5605, 5602, 5597, 5393, 5521, 5525, 5316, 5259, 5403, 5372, 5698, 5267, 5522, 5713, 5428, 5699, 5327, 5325, 5556, 5645, 5434, 5684, 5674, 5518, 5517, 5580, 5407 (8 hits) (03/26/2012

Table 121 - FCC frequency hopping radar (Type 6) Results, WU, CU Acquire, Low Band						
Trial #	Pulses/ Burst	Pulse Width (us)	PRI (us)	Detected	Fr (MHz) and level (dBm)	Burst Information
						02:20:48 PM)
26	9	1.0	333.0	Yes	5273.8MHz, -62.0dBm	Hop sequence: 5425, 5517, 5361, 5505, 5366, 5541, 5625, 5296, 5456, 5325, 5473, 5400, 5410, 5673, 5550, 5268, 5566, 5376, 5621, 5264, 5290, 5351, 5551, 5448, 5280, 5521, 5308, 5496, 5331, 5299, 5431, 5467, 5485, 5592, 5394, 5393, 5554, 5373, 5657, 5642, 5369, 5530, 5518, 5706, 5335, 5327, 5549, 5567, 5725, 5342, 5267, 5656, 5484, 5414, 5597, 5406, 5519, 5441, 5534, 5664, 5663, 5675, 5697, 5506, 5354, 5339, 5539, 5385, 5328, 5715, 5654, 5332, 5440, 5449, 5346, 5577, 5383, 5490, 5573, 5417, 5302, 5457, 5529, 5260, 5350, 5497, 5323, 5301, 5359, 5695, 5495, 5559, 5608, 5387, 5605, 5688, 5432, 5309, 5565, 5571 (2 hits) (03/26/2012 02:20:58 PM)
27	9	1.0	333.0	Yes	5274.8MHz, -62.0dBm	Hop sequence: 5364, 5646, 5351, 5578, 5422, 5334, 5367, 5453, 5649, 5387, 5432, 5655, 5688, 5446, 5498, 5385, 5511, 5347, 5302, 5503, 5650, 5619, 5507, 5628, 5307, 5542, 5265, 5512, 5414, 5482, 5653, 5262, 5427, 5581, 5601, 5525, 5276, 5558, 5720, 5359, 5266, 5706, 5472, 5541, 5630, 5272, 5294, 5405, 5281, 5317, 5477, 5360, 5610, 5551, 5615, 5275, 5480, 5260, 5452, 5388, 5489, 5509, 5308, 5676, 5495, 5579, 5491, 5377, 5326, 5631, 5271, 5663, 5269, 5577, 5518, 5428, 5375, 5304, 5594, 5515, 5635, 5443, 5339, 5599, 5340, 5686, 5259, 5618, 5448, 5463, 5341, 5548, 5300, 5383, 5546, 5645, 5255, 5660, 5252, 5444 (4 hits) (03/26/2012 02:21:06 PM)
28	9	1.0	333.0	Yes	5275.8MHz, -62.0dBm	Hop sequence: 5605, 5714, 5669, 5526, 5700, 5336, 5293, 5559, 5557, 5315, 5466, 5349, 5653, 5398, 5692, 5388, 5441, 5578, 5667, 5468, 5629, 5344, 5718, 5438, 5472, 5346, 5660, 5464, 5290, 5598, 5479, 5607, 5375, 5623, 5582, 5480, 5563, 5632, 5276, 5591, 5536, 5265, 5405, 5708, 5684, 5393, 5306, 5400,



Table 121 - FCC frequency hopping radar (Type 6) Results, WU, CU Acquire, Low Band						
Trial #	Pulses/ Burst	Pulse Width (us)	PRI (us)	Detected	Fr (MHz) and level (dBm)	Burst Information
						5294, 5720, 5450, 5309, 5454, 5500, 5457, 5696, 5510, 5419, 5499, 5458, 5341, 5474, 5597, 5284, 5645, 5532, 5343, 5361, 5538, 5571, 5434, 5676, 5449, 5543, 5589, 5350, 5363, 5348, 5713, 5503, 5320, 5604, 5710, 5429, 5681, 5691, 5289, 5266, 5619, 5682, 5334, 5574, 5540, 5426, 5505, 5618, 5650, 5250, 5347, 5483 (6 hits) (03/26/2012 02:21:13 PM)
29	9	1.0	333.0	Yes	5276.8MHz, -62.0dBm	Hop sequence: 5408, 5686, 5518, 5449, 5276, 5354, 5295, 5360, 5358, 5560, 5568, 5628, 5569, 5412, 5669, 5698, 5337, 5541, 5326, 5372, 5310, 5627, 5706, 5253, 5414, 5402, 5441, 5386, 5500, 5259, 5507, 5418, 5293, 5328, 5574, 5576, 5572, 5496, 5488, 5475, 5375, 5470, 5536, 5480, 5438, 5336, 5321, 5327, 5458, 5586, 5545, 5512, 5429, 5482, 5369, 5704, 5717, 5291, 5394, 5679, 5656, 5596, 5395, 5654, 5619, 5323, 5258, 5517, 5546, 5610, 5620, 5368, 5721, 5680, 5594, 5652, 5435, 5351, 5588, 5430, 5570, 5688, 5270, 5640, 5549, 5465, 5387, 5478, 5365, 5523, 5288, 5454, 5406, 5501, 5581, 5254, 5420, 5324, 5457, 5382 (5 hits) (03/26/2012 02:21:21 PM)
30	9	1.0	333.0	Yes	5277.8MHz, -62.0dBm	Hop sequence: 5326, 5270, 5495, 5691, 5424, 5494, 5659, 5630, 5699, 5490, 5505, 5614, 5723, 5721, 5707, 5464, 5518, 5649, 5255, 5488, 5681, 5605, 5533, 5310, 5640, 5313, 5612, 5282, 5266, 5713, 5453, 5668, 5491, 5390, 5332, 5296, 5492, 5449, 5512, 5711, 5661, 5540, 5466, 5558, 5656, 5417, 5319, 5336, 5306, 5573, 5291, 5348, 5323, 5536, 5261, 5292, 5462, 5415, 5597, 5398, 5272, 5623, 5386, 5664, 5403, 5534, 5393, 5316, 5456, 5710, 5507, 5663, 5645, 5569, 5271, 5584, 5515, 5335, 5258, 5361, 5362, 5395, 5287, 5446, 5619, 5642, 5585, 5328, 5695, 5487, 5654, 5508, 5418, 5277, 5600, 5712, 5302, 5651, 5445, 5311 (5 hits) (03/26/2012

Table 121 - FCC frequency hopping radar (Type 6) Results, WU, CU Acquire, Low Band						
Trial #	Pulses/ Burst	Pulse Width (us)	PRI (us)	Detected	Fr (MHz) and level (dBm)	Burst Information
						02:21:34 PM)
31	9	1.0	333.0	Yes	5278.8MHz, -62.0dBm	Hop sequence: 5613, 5711, 5330, 5304, 5595, 5421, 5366, 5338, 5630, 5641, 5308, 5563, 5712, 5584, 5555, 5560, 5580, 5550, 5443, 5423, 5383, 5607, 5260, 5307, 5335, 5256, 5631, 5378, 5540, 5412, 5257, 5694, 5687, 5418, 5570, 5676, 5493, 5336, 5577, 5526, 5344, 5601, 5394, 5582, 5534, 5463, 5521, 5518, 5398, 5401, 5509, 5488, 5354, 5266, 5331, 5674, 5558, 5494, 5487, 5585, 5414, 5505, 5637, 5380, 5725, 5395, 5589, 5441, 5591, 5356, 5265, 5612, 5684, 5600, 5374, 5288, 5538, 5700, 5302, 5654, 5429, 5537, 5618, 5439, 5270, 5672, 5276, 5451, 5692, 5543, 5282, 5616, 5571, 5275, 5536, 5391, 5485, 5449, 5316, 5677 (4 hits) (03/26/2012 02:21:47 PM)
32	9	1.0	333.0	Yes	5279.8MHz, -62.0dBm	Hop sequence: 5507, 5718, 5694, 5475, 5634, 5672, 5392, 5341, 5430, 5426, 5256, 5432, 5303, 5487, 5684, 5567, 5335, 5480, 5271, 5280, 5348, 5544, 5472, 5452, 5464, 5446, 5546, 5692, 5306, 5515, 5608, 5334, 5621, 5655, 5535, 5607, 5529, 5442, 5448, 5667, 5413, 5357, 5511, 5369, 5431, 5543, 5269, 5712, 5394, 5658, 5676, 5380, 5390, 5327, 5510, 5261, 5525, 5416, 5628, 5489, 5647, 5322, 5321, 5705, 5706, 5488, 5415, 5585, 5713, 5418, 5474, 5606, 5506, 5427, 5451, 5494, 5344, 5642, 5345, 5260, 5636, 5579, 5593, 5383, 5513, 5420, 5666, 5376, 5519, 5273, 5629, 5319, 5421, 5669, 5278, 5295, 5279, 5717, 5596, 5315 (4 hits) (03/26/2012 02:22:11 PM)
33	9	1.0	333.0	Yes	5280.8MHz, -62.0dBm	Hop sequence: 5584, 5567, 5627, 5250, 5343, 5486, 5332, 5683, 5311, 5531, 5444, 5621, 5587, 5625, 5297, 5385, 5395, 5635, 5676, 5529, 5440, 5610, 5448, 5484, 5619, 5368, 5369, 5650, 5266, 5284, 5527, 5290, 5551, 5268, 5685, 5306, 5308, 5282, 5521, 5262, 5605, 5463, 5380, 5552, 5483, 5301, 5652, 5420,

Table 121 - FCC frequency hopping radar (Type 6) Results, WU, CU Acquire, Low Band						
Trial #	Pulses/ Burst	Pulse Width (us)	PRI (us)	Detected	Fr (MHz) and level (dBm)	Burst Information
						5561, 5669, 5688, 5394, 5376, 5689, 5690, 5292, 5383, 5724, 5409, 5651, 5354, 5633, 5687, 5331, 5471, 5659, 5253, 5660, 5507, 5411, 5347, 5598, 5523, 5418, 5663, 5639, 5672, 5304, 5706, 5271, 5594, 5722, 5571, 5606, 5279, 5541, 5461, 5352, 5670, 5511, 5428, 5472, 5563, 5516, 5336, 5692, 5353, 5260, 5579, 5532 (5 hits) (03/26/2012 02:22:20 PM)
34	9	1.0	333.0	Yes	5281.8MHz, -62.0dBm	Hop sequence: 5406, 5320, 5395, 5601, 5435, 5644, 5272, 5557, 5591, 5612, 5583, 5536, 5380, 5629, 5706, 5383, 5562, 5529, 5429, 5635, 5463, 5256, 5392, 5393, 5348, 5518, 5450, 5724, 5600, 5720, 5617, 5411, 5688, 5452, 5523, 5312, 5709, 5460, 5496, 5422, 5359, 5362, 5467, 5292, 5634, 5466, 5692, 5484, 5560, 5287, 5434, 5581, 5357, 5327, 5579, 5631, 5561, 5696, 5506, 5409, 5355, 5661, 5325, 5572, 5503, 5507, 5373, 5723, 5578, 5311, 5627, 5267, 5285, 5613, 5344, 5547, 5494, 5322, 5511, 5370, 5701, 5543, 5509, 5266, 5427, 5472, 5526, 5687, 5610, 5433, 5381, 5476, 5399, 5331, 5400, 5420, 5650, 5308, 5442, 5703 (3 hits) (03/26/2012 02:22:28 PM)
35	9	1.0	333.0	Yes	5282.8MHz, -62.0dBm	Hop sequence: 5312, 5449, 5417, 5414, 5536, 5364, 5493, 5621, 5558, 5316, 5501, 5542, 5387, 5505, 5526, 5593, 5325, 5570, 5289, 5535, 5598, 5628, 5574, 5520, 5455, 5517, 5539, 5480, 5676, 5385, 5330, 5260, 5354, 5670, 5463, 5629, 5390, 5277, 5382, 5424, 5372, 5630, 5584, 5489, 5253, 5444, 5609, 5464, 5294, 5336, 5565, 5661, 5275, 5461, 5448, 5334, 5679, 5320, 5582, 5667, 5638, 5639, 5523, 5452, 5357, 5500, 5309, 5522, 5632, 5711, 5571, 5518, 5331, 5353, 5597, 5581, 5666, 5699, 5435, 5515, 5556, 5633, 5406, 5705, 5701, 5471, 5379, 5660, 5338, 5351, 5563, 5393, 5345, 5669, 5503, 5678, 5411, 5447, 5702, 5514 (4 hits) (03/26/2012

Table 121 - FCC frequency hopping radar (Type 6) Results, WU, CU Acquire, Low Band						
Trial #	Pulses/ Burst	Pulse Width (us)	PRI (us)	Detected	Fr (MHz) and level (dBm)	Burst Information
						02:22:36 PM)
36	9	1.0	333.0	Yes	5283.8MHz, -62.0dBm	Hop sequence: 5257, 5577, 5293, 5544, 5331, 5340, 5366, 5290, 5625, 5486, 5650, 5281, 5304, 5558, 5684, 5300, 5361, 5598, 5541, 5668, 5509, 5600, 5634, 5380, 5412, 5255, 5571, 5275, 5397, 5568, 5411, 5715, 5702, 5461, 5686, 5404, 5414, 5302, 5643, 5626, 5531, 5514, 5513, 5285, 5325, 5327, 5431, 5705, 5570, 5457, 5574, 5631, 5605, 5687, 5671, 5430, 5437, 5661, 5504, 5529, 5465, 5539, 5601, 5697, 5299, 5420, 5474, 5416, 5371, 5382, 5683, 5572, 5608, 5656, 5478, 5481, 5607, 5365, 5691, 5464, 5262, 5283, 5588, 5336, 5395, 5554, 5442, 5716, 5636, 5322, 5421, 5339, 5429, 5535, 5375, 5390, 5354, 5719, 5444, 5334 (6 hits) (03/26/2012 02:22:43 PM)
37	9	1.0	333.0	Yes	5284.8MHz, -62.0dBm	Hop sequence: 5317, 5636, 5652, 5512, 5551, 5301, 5391, 5596, 5442, 5578, 5294, 5449, 5427, 5333, 5365, 5388, 5637, 5514, 5372, 5639, 5387, 5470, 5251, 5269, 5390, 5303, 5346, 5687, 5599, 5295, 5534, 5508, 5439, 5609, 5589, 5262, 5285, 5521, 5260, 5654, 5264, 5702, 5373, 5502, 5376, 5455, 5675, 5535, 5647, 5582, 5313, 5458, 5330, 5662, 5321, 5509, 5339, 5405, 5288, 5277, 5699, 5625, 5519, 5332, 5263, 5566, 5474, 5359, 5588, 5420, 5281, 5691, 5650, 5510, 5297, 5379, 5570, 5425, 5716, 5441, 5464, 5345, 5542, 5344, 5306, 5690, 5541, 5325, 5708, 5562, 5532, 5323, 5383, 5522, 5590, 5307, 5410, 5591, 5518, 5618 (6 hits) (03/26/2012 02:22:52 PM)
38	9	1.0	333.0	Yes	5285.8MHz, -62.0dBm	Hop sequence: 5547, 5473, 5343, 5710, 5628, 5586, 5495, 5352, 5290, 5572, 5366, 5553, 5439, 5403, 5542, 5659, 5522, 5280, 5457, 5276, 5528, 5642, 5702, 5485, 5364, 5532, 5316, 5426, 5458, 5438, 5460, 5549, 5649, 5493, 5471, 5477, 5594, 5496, 5618, 5541, 5313, 5326, 5623, 5634, 5704, 5252, 5461, 5497,

Table 121 - FCC frequency hopping radar (Type 6) Results, WU, CU Acquire, Low Band						
Trial #	Pulses/ Burst	Pulse Width (us)	PRI (us)	Detected	Fr (MHz) and level (dBm)	Burst Information
						5353, 5691, 5608, 5491, 5467, 5667, 5344, 5635, 5381, 5253, 5639, 5393, 5518, 5504, 5309, 5430, 5571, 5602, 5519, 5643, 5464, 5686, 5714, 5272, 5500, 5652, 5371, 5689, 5411, 5450, 5709, 5429, 5577, 5703, 5660, 5492, 5394, 5321, 5256, 5486, 5663, 5251, 5268, 5270, 5722, 5517, 5658, 5459, 5508, 5501, 5334, 5261 (3 hits) (03/26/2012 02:22:59 PM)
39	9	1.0	333.0	Yes	5286.8MHz, -62.0dBm	Hop sequence: 5573, 5531, 5618, 5281, 5354, 5477, 5269, 5307, 5378, 5585, 5320, 5342, 5538, 5624, 5433, 5545, 5560, 5609, 5389, 5466, 5527, 5376, 5366, 5548, 5566, 5641, 5296, 5576, 5437, 5591, 5683, 5619, 5490, 5713, 5368, 5448, 5588, 5709, 5655, 5385, 5599, 5665, 5544, 5674, 5678, 5526, 5720, 5346, 5686, 5606, 5658, 5414, 5356, 5672, 5275, 5574, 5428, 5380, 5604, 5333, 5373, 5352, 5511, 5253, 5613, 5259, 5506, 5449, 5395, 5499, 5469, 5291, 5482, 5659, 5420, 5593, 5267, 5601, 5602, 5306, 5536, 5264, 5515, 5707, 5432, 5276, 5476, 5724, 5690, 5442, 5500, 5611, 5284, 5594, 5654, 5462, 5444, 5343, 5367, 5694 (5 hits) (03/26/2012 02:23:06 PM)
40	9	1.0	333.0	Yes	5287.8MHz, -62.0dBm	Hop sequence: 5545, 5338, 5321, 5721, 5636, 5702, 5564, 5696, 5565, 5500, 5413, 5294, 5414, 5256, 5412, 5627, 5482, 5660, 5420, 5464, 5479, 5298, 5328, 5712, 5508, 5643, 5690, 5465, 5436, 5350, 5606, 5345, 5670, 5518, 5707, 5272, 5532, 5411, 5675, 5458, 5263, 5262, 5360, 5269, 5276, 5340, 5455, 5543, 5253, 5525, 5539, 5443, 5607, 5320, 5325, 5617, 5390, 5432, 5603, 5311, 5638, 5683, 5497, 5717, 5306, 5554, 5353, 5524, 5367, 5623, 5684, 5719, 5713, 5560, 5358, 5505, 5685, 5287, 5640, 5295, 5701, 5710, 5581, 5277, 5676, 5483, 5280, 5540, 5509, 5372, 5686, 5561, 5609, 5369, 5466, 5536, 5428, 5515, 5363, 5610 (6 hits) (03/26/2012

Table 121 - FCC frequency hopping radar (Type 6) Results, WU, CU Acquire, Low Band						
Trial #	Pulses/ Burst	Pulse Width (us)	PRI (us)	Detected	Fr (MHz) and level (dBm)	Burst Information
						02:23:13 PM)
41	9	1.0	333.0	Yes	5288.8MHz, -62.0dBm	Hop sequence: 5535, 5303, 5348, 5479, 5404, 5350, 5502, 5475, 5393, 5628, 5417, 5457, 5280, 5632, 5335, 5340, 5587, 5716, 5721, 5514, 5428, 5561, 5644, 5373, 5624, 5577, 5700, 5378, 5411, 5701, 5642, 5673, 5588, 5477, 5488, 5620, 5418, 5392, 5520, 5717, 5472, 5288, 5442, 5574, 5578, 5483, 5436, 5445, 5585, 5354, 5401, 5269, 5710, 5599, 5630, 5635, 5690, 5332, 5286, 5583, 5421, 5275, 5580, 5713, 5537, 5405, 5270, 5473, 5432, 5371, 5714, 5250, 5670, 5521, 5394, 5367, 5592, 5594, 5551, 5715, 5429, 5522, 5547, 5600, 5667, 5284, 5706, 5613, 5482, 5671, 5351, 5291, 5507, 5304, 5699, 5724, 5423, 5657, 5362, 5426 (6 hits) (03/26/2012 02:23:20 PM)
42	9	1.0	333.0	Yes	5289.8MHz, -62.0dBm	Hop sequence: 5392, 5637, 5298, 5355, 5545, 5420, 5505, 5270, 5455, 5252, 5623, 5650, 5469, 5526, 5358, 5422, 5677, 5297, 5369, 5379, 5450, 5445, 5671, 5645, 5531, 5403, 5522, 5573, 5597, 5460, 5328, 5725, 5399, 5459, 5304, 5724, 5363, 5344, 5607, 5268, 5579, 5599, 5567, 5536, 5601, 5606, 5480, 5633, 5301, 5610, 5680, 5307, 5433, 5516, 5411, 5524, 5412, 5444, 5436, 5434, 5575, 5620, 5290, 5512, 5657, 5530, 5385, 5519, 5454, 5281, 5479, 5325, 5688, 5636, 5629, 5338, 5665, 5303, 5681, 5261, 5473, 5491, 5709, 5598, 5546, 5551, 5498, 5593, 5314, 5632, 5694, 5532, 5553, 5251, 5478, 5616, 5547, 5569, 5529, 5617 (2 hits) (03/26/2012 02:23:30 PM)
43	9	1.0	333.0	Yes	5290.8MHz, -62.0dBm	Hop sequence: 5332, 5535, 5627, 5552, 5527, 5483, 5298, 5624, 5288, 5541, 5380, 5603, 5615, 5296, 5339, 5349, 5496, 5422, 5705, 5718, 5516, 5479, 5637, 5468, 5476, 5570, 5571, 5407, 5435, 5505, 5447, 5550, 5502, 5689, 5442, 5707, 5270, 5287, 5566, 5576, 5520, 5331, 5630, 5379, 5579, 5610, 5699, 5394,

Table 121 - FCC frequency hopping radar (Type 6) Results, WU, CU Acquire, Low Band						
Trial #	Pulses/ Burst	Pulse Width (us)	PRI (us)	Detected	Fr (MHz) and level (dBm)	Burst Information
						5503, 5281, 5427, 5321, 5636, 5677, 5629, 5361, 5664, 5587, 5278, 5328, 5443, 5668, 5495, 5621, 5499, 5715, 5304, 5656, 5716, 5491, 5714, 5608, 5272, 5666, 5256, 5411, 5678, 5558, 5353, 5634, 5452, 5466, 5524, 5600, 5413, 5358, 5708, 5717, 5688, 5277, 5687, 5330, 5652, 5286, 5639, 5607, 5661, 5643, 5324, 5696 (6 hits) (03/26/2012 02:23:40 PM)
44	9	1.0	333.0	Yes	5291.8MHz, -62.0dBm	Hop sequence: 5428, 5273, 5530, 5498, 5604, 5407, 5263, 5633, 5703, 5594, 5272, 5585, 5362, 5425, 5475, 5501, 5393, 5652, 5708, 5347, 5330, 5265, 5709, 5469, 5412, 5493, 5454, 5327, 5597, 5602, 5298, 5533, 5301, 5289, 5337, 5368, 5274, 5559, 5576, 5310, 5461, 5552, 5663, 5600, 5724, 5381, 5540, 5491, 5636, 5314, 5287, 5539, 5269, 5701, 5371, 5455, 5335, 5705, 5488, 5254, 5465, 5640, 5332, 5261, 5423, 5694, 5649, 5526, 5613, 5543, 5691, 5341, 5308, 5622, 5672, 5560, 5592, 5588, 5712, 5567, 5307, 5579, 5365, 5603, 5361, 5367, 5256, 5285, 5637, 5508, 5440, 5460, 5284, 5509, 5456, 5544, 5260, 5373, 5568, 5443 (5 hits) (03/26/2012 02:23:49 PM)
45	9	1.0	333.0	Yes	5292.8MHz, -62.0dBm	Hop sequence: 5464, 5557, 5259, 5497, 5663, 5556, 5537, 5504, 5378, 5399, 5601, 5626, 5380, 5355, 5466, 5374, 5644, 5697, 5519, 5481, 5700, 5631, 5616, 5459, 5322, 5407, 5304, 5677, 5402, 5333, 5549, 5313, 5499, 5475, 5336, 5576, 5278, 5345, 5401, 5421, 5352, 5693, 5637, 5610, 5545, 5297, 5675, 5337, 5287, 5505, 5453, 5645, 5573, 5360, 5415, 5330, 5708, 5354, 5332, 5569, 5395, 5511, 5321, 5446, 5605, 5602, 5280, 5678, 5635, 5651, 5465, 5370, 5667, 5271, 5699, 5255, 5526, 5292, 5288, 5687, 5436, 5397, 5277, 5320, 5308, 5581, 5349, 5431, 5682, 5296, 5595, 5482, 5438, 5357, 5665, 5457, 5404, 5455, 5516, 5419 (6 hits) (03/26/2012

Table 121 - FCC frequency hopping radar (Type 6) Results, WU, CU Acquire, Low Band						
Trial #	Pulses/ Burst	Pulse Width (us)	PRI (us)	Detected	Fr (MHz) and level (dBm)	Burst Information
						02:23:57 PM)
46	9	1.0	333.0	Yes	5293.8MHz, -62.0dBm	Hop sequence: 5454, 5381, 5430, 5611, 5682, 5327, 5717, 5339, 5566, 5544, 5391, 5710, 5383, 5666, 5374, 5502, 5465, 5287, 5476, 5328, 5474, 5457, 5623, 5335, 5620, 5329, 5711, 5699, 5301, 5299, 5702, 5482, 5290, 5527, 5422, 5480, 5394, 5639, 5390, 5509, 5567, 5529, 5289, 5664, 5695, 5441, 5558, 5282, 5479, 5313, 5595, 5592, 5478, 5562, 5392, 5660, 5600, 5314, 5686, 5678, 5305, 5393, 5429, 5268, 5334, 5613, 5597, 5277, 5499, 5560, 5627, 5435, 5610, 5346, 5700, 5307, 5540, 5511, 5687, 5368, 5326, 5693, 5416, 5349, 5671, 5594, 5494, 5262, 5584, 5654, 5322, 5297, 5427, 5543, 5271, 5275, 5608, 5720, 5591, 5387 (6 hits) (03/26/2012 02:24:11 PM)



## WU, Steady State Mode

Table 122 - Summary of All Results - WU Steady State				
Waveform Name	Pd (%)	Pd Required (%)	Number of Trials	Status
FCC Short Pulse Radar (Type 1)	96.8 %	60.0 %	31	In process
FCC Short Pulse Radar (Type 2)	96.7 %	60.0 %	30	PASSED
FCC Short Pulse Radar (Type 3)	100.0 %	60.0 %	30	PASSED
FCC Short Pulse Radar (Type 4)	100.0 %	60.0 %	30	PASSED
Aggregate of above results	98.4 %	80.0 %	121	PASSED
Long Sequence	100.0 %	80.0 %	30	PASSED

Table 123 - FCC Short Pulse Radar (Type 1) Results WU Steady State						
Trial #	Pulses/ Burst	Pulse Width (us)	PRI (us)	Detected	Fr (MHz) and level (dBm)	Burst Information
1	18	1.0	1428.0	No	5563.2MHz, -62.0dBm	Single burst
2	18	1.0	1428.0	Yes	5558.2MHz, -62.0dBm	Single burst
3	18	1.0	1428.0	Yes	5553.2MHz, -62.0dBm	Single burst
4	18	1.0	1428.0	Yes	5573.2MHz, -62.0dBm	Single burst
5	18	1.0	1428.0	Yes	5568.2MHz, -62.0dBm	Single burst
6	18	1.0	1428.0	Yes	5563.2MHz, -62.0dBm	Single burst
7	18	1.0	1428.0	Yes	5558.2MHz, -62.0dBm	Single burst
8	18	1.0	1428.0	Yes	5553.2MHz, -62.0dBm	Single burst
9	18	1.0	1428.0	Yes	5573.2MHz, -62.0dBm	Single burst
10	18	1.0	1428.0	Yes	5568.2MHz, -62.0dBm	Single burst
11	18	1.0	1428.0	Yes	5563.2MHz, -62.0dBm	Single burst
12	18	1.0	1428.0	Yes	5558.2MHz, -62.0dBm	Single burst
13	18	1.0	1428.0	Yes	5553.2MHz, -62.0dBm	Single burst
14	18	1.0	1428.0	Yes	5573.2MHz, -62.0dBm	Single burst
15	18	1.0	1428.0	Yes	5568.2MHz, -62.0dBm	Single burst
16	18	1.0	1428.0	Yes	5563.2MHz, -62.0dBm	Single burst
17	18	1.0	1428.0	Yes	5558.2MHz, -62.0dBm	Single burst
18	18	1.0	1428.0	Yes	5553.2MHz, -62.0dBm	Single burst
19	18	1.0	1428.0	Yes	5573.2MHz, -62.0dBm	Single burst
20	18	1.0	1428.0	Yes	5568.2MHz, -62.0dBm	Single burst
21	18	1.0	1428.0	Yes	5563.2MHz, -62.0dBm	Single burst
22	18	1.0	1428.0	Yes	5558.2MHz, -62.0dBm	Single burst
23	18	1.0	1428.0	Yes	5553.2MHz, -62.0dBm	Single burst
24	18	1.0	1428.0	Yes	5573.2MHz, -62.0dBm	Single burst
25	18	1.0	1428.0	Yes	5568.2MHz, -62.0dBm	Single burst
26	18	1.0	1428.0	Yes	5563.2MHz, -62.0dBm	Single burst
27	18	1.0	1428.0	Yes	5558.2MHz, -62.0dBm	Single burst
28	18	1.0	1428.0	Yes	5553.2MHz, -62.0dBm	Single burst
29	18	1.0	1428.0	Yes	5573.2MHz, -62.0dBm	Single burst
30	18	1.0	1428.0	Yes	5568.2MHz, -62.0dBm	Single burst
31	18	1.0	1428.0	Yes	5563.2MHz, -62.0dBm	Single burst

**Table 124 - FCC Short Pulse Radar (Type 2) Results WU Steady State**

Trial #	Pulses/ Burst	Pulse Width (us)	PRI (us)	Detected	Fr (MHz) and level (dBm)	Burst Information
1	25	2.2	177.0	Yes	5563.2MHz, -62.0dBm	Single burst
2	23	1.4	223.0	Yes	5558.2MHz, -62.0dBm	Single burst
3	28	3.0	206.0	Yes	5553.2MHz, -62.0dBm	Single burst
4	25	3.1	200.0	Yes	5573.2MHz, -62.0dBm	Single burst
5	24	2.2	151.0	Yes	5568.2MHz, -62.0dBm	Single burst
6	25	2.7	152.0	Yes	5563.2MHz, -62.0dBm	Single burst
7	27	3.0	160.0	Yes	5558.2MHz, -62.0dBm	Single burst
8	29	4.4	152.0	Yes	5553.2MHz, -62.0dBm	Single burst
9	26	3.4	222.0	Yes	5573.2MHz, -62.0dBm	Single burst
10	27	3.2	191.0	Yes	5568.2MHz, -62.0dBm	Single burst
11	28	4.5	187.0	Yes	5563.2MHz, -62.0dBm	Single burst
12	28	1.8	192.0	Yes	5558.2MHz, -62.0dBm	Single burst
13	29	2.3	153.0	Yes	5553.2MHz, -62.0dBm	Single burst
14	28	1.3	228.0	Yes	5573.2MHz, -62.0dBm	Single burst
15	25	3.6	195.0	Yes	5568.2MHz, -62.0dBm	Single burst
16	26	1.1	213.0	Yes	5563.2MHz, -62.0dBm	Single burst
17	24	3.4	187.0	Yes	5558.2MHz, -62.0dBm	Single burst
18	26	1.0	216.0	Yes	5553.2MHz, -62.0dBm	Single burst
19	27	2.0	206.0	Yes	5573.2MHz, -62.0dBm	Single burst
20	27	5.0	175.0	Yes	5568.2MHz, -62.0dBm	Single burst
21	29	2.4	227.0	Yes	5563.2MHz, -62.0dBm	Single burst
22	26	1.6	177.0	Yes	5558.2MHz, -62.0dBm	Single burst
23	26	3.4	178.0	Yes	5553.2MHz, -62.0dBm	Single burst
24	24	3.7	202.0	Yes	5573.2MHz, -62.0dBm	Single burst
25	29	4.2	162.0	Yes	5568.2MHz, -62.0dBm	Single burst
26	27	4.4	161.0	Yes	5563.2MHz, -62.0dBm	Single burst
27	26	3.2	170.0	Yes	5558.2MHz, -62.0dBm	Single burst
28	25	1.6	187.0	Yes	5553.2MHz, -62.0dBm	Single burst
29	26	3.9	192.0	Yes	5573.2MHz, -62.0dBm	Single burst
30	26	1.1	230.0	No	5568.2MHz, -62.0dBm	Single burst

**Table 125 - FCC Short Pulse Radar (Type 3) Results WU Steady State**

Trial #	Pulses/ Burst	Pulse Width (us)	PRI (us)	Detected	Fr (MHz) and level (dBm)	Burst Information
1	17	9.7	375.0	Yes	5563.2MHz, -62.0dBm	Single burst
2	16	6.5	385.0	Yes	5558.2MHz, -62.0dBm	Single burst
3	16	6.7	201.0	Yes	5553.2MHz, -62.0dBm	Single burst
4	17	6.1	395.0	Yes	5573.2MHz, -62.0dBm	Single burst
5	17	8.6	309.0	Yes	5568.2MHz, -62.0dBm	Single burst
6	17	6.9	399.0	Yes	5563.2MHz, -62.0dBm	Single burst
7	16	8.2	431.0	Yes	5558.2MHz, -62.0dBm	Single burst
8	18	9.0	454.0	Yes	5553.2MHz, -62.0dBm	Single burst
9	16	7.7	331.0	Yes	5573.2MHz, -62.0dBm	Single burst
10	18	6.3	292.0	Yes	5568.2MHz, -62.0dBm	Single burst
11	17	9.4	262.0	Yes	5563.2MHz, -62.0dBm	Single burst
12	16	8.4	244.0	Yes	5558.2MHz, -62.0dBm	Single burst
13	17	7.8	456.0	Yes	5553.2MHz, -62.0dBm	Single burst
14	17	8.5	296.0	Yes	5573.2MHz, -62.0dBm	Single burst
15	16	6.3	238.0	Yes	5568.2MHz, -62.0dBm	Single burst
16	18	9.7	457.0	Yes	5563.2MHz, -62.0dBm	Single burst
17	18	9.4	349.0	Yes	5558.2MHz, -62.0dBm	Single burst
18	18	6.5	294.0	Yes	5553.2MHz, -62.0dBm	Single burst
19	18	6.5	495.0	Yes	5573.2MHz, -62.0dBm	Single burst
20	17	9.3	424.0	Yes	5568.2MHz, -62.0dBm	Single burst
21	17	6.8	351.0	Yes	5563.2MHz, -62.0dBm	Single burst
22	17	6.9	202.0	Yes	5558.2MHz, -62.0dBm	Single burst
23	18	9.3	266.0	Yes	5553.2MHz, -62.0dBm	Single burst
24	18	7.0	300.0	Yes	5573.2MHz, -62.0dBm	Single burst
25	17	9.1	227.0	Yes	5568.2MHz, -62.0dBm	Single burst
26	17	7.5	393.0	Yes	5563.2MHz, -62.0dBm	Single burst
27	16	7.2	245.0	Yes	5558.2MHz, -62.0dBm	Single burst
28	17	7.4	377.0	Yes	5553.2MHz, -62.0dBm	Single burst
29	17	6.9	435.0	Yes	5573.2MHz, -62.0dBm	Single burst
30	16	8.1	339.0	Yes	5568.2MHz, -62.0dBm	Single burst

**Table 126 - FCC Short Pulse Radar (Type 4) Results WU Steady State**

Trial #	Pulses/ Burst	Pulse Width (us)	PRI (us)	Detected	Fr (MHz) and level (dBm)	Burst Information
1	13	17.6	201.0	Yes	5563.2MHz, -62.0dBm	Single burst
2	14	12.2	480.0	Yes	5558.2MHz, -62.0dBm	Single burst
3	16	16.5	235.0	Yes	5553.2MHz, -62.0dBm	Single burst
4	12	19.2	371.0	Yes	5573.2MHz, -62.0dBm	Single burst
5	15	17.6	402.0	Yes	5568.2MHz, -62.0dBm	Single burst
6	13	13.0	301.0	Yes	5563.2MHz, -62.0dBm	Single burst
7	13	15.9	241.0	Yes	5558.2MHz, -62.0dBm	Single burst
8	13	14.3	293.0	Yes	5553.2MHz, -62.0dBm	Single burst
9	15	14.5	292.0	Yes	5573.2MHz, -62.0dBm	Single burst
10	13	12.2	377.0	Yes	5568.2MHz, -62.0dBm	Single burst
11	15	15.3	237.0	Yes	5563.2MHz, -62.0dBm	Single burst
12	15	14.0	311.0	Yes	5558.2MHz, -62.0dBm	Single burst
13	13	12.8	226.0	Yes	5553.2MHz, -62.0dBm	Single burst
14	13	18.4	258.0	Yes	5573.2MHz, -62.0dBm	Single burst
15	12	19.8	341.0	Yes	5568.2MHz, -62.0dBm	Single burst
16	13	19.5	364.0	Yes	5563.2MHz, -62.0dBm	Single burst
17	12	11.5	259.0	Yes	5558.2MHz, -62.0dBm	Single burst
18	15	19.7	422.0	Yes	5553.2MHz, -62.0dBm	Single burst
19	14	14.5	414.0	Yes	5573.2MHz, -62.0dBm	Single burst
20	14	15.8	393.0	Yes	5568.2MHz, -62.0dBm	Single burst
21	14	19.0	328.0	Yes	5563.2MHz, -62.0dBm	Single burst
22	13	18.5	328.0	Yes	5558.2MHz, -62.0dBm	Single burst
23	16	16.3	391.0	Yes	5553.2MHz, -62.0dBm	Single burst
24	14	13.2	228.0	Yes	5573.2MHz, -62.0dBm	Single burst
25	14	16.4	434.0	Yes	5568.2MHz, -62.0dBm	Single burst
26	13	14.7	410.0	Yes	5563.2MHz, -62.0dBm	Single burst
27	16	15.0	200.0	Yes	5558.2MHz, -62.0dBm	Single burst
28	15	17.8	251.0	Yes	5553.2MHz, -62.0dBm	Single burst
29	13	12.1	271.0	Yes	5573.2MHz, -62.0dBm	Single burst
30	12	12.8	489.0	Yes	5568.2MHz, -62.0dBm	Single burst

**Table 127 - Long Sequence Waveform Summary WU Steady State**

Long Sequence Trial	Result	Radar Frequency / Amplitude
Trial #1	Detected	5563.2MHz, -62.0dBm
Trial #2	Detected	5558.2MHz, -62.0dBm
Trial #3	Detected	5553.2MHz, -62.0dBm
Trial #4	Detected	5573.2MHz, -62.0dBm
Trial #5	Detected	5568.2MHz, -62.0dBm
Trial #6	Detected	5563.2MHz, -62.0dBm
Trial #7	Detected	5558.2MHz, -62.0dBm
Trial #8	Detected	5553.2MHz, -62.0dBm
Trial #9	Detected	5573.2MHz, -62.0dBm
Trial #10	Detected	5568.2MHz, -62.0dBm
Trial #11	Detected	5563.2MHz, -62.0dBm
Trial #12	Detected	5558.2MHz, -62.0dBm
Trial #13	Detected	5553.2MHz, -62.0dBm
Trial #14	Detected	5573.2MHz, -62.0dBm
Trial #15	Detected	5568.2MHz, -62.0dBm
Trial #16	Detected	5563.2MHz, -62.0dBm
Trial #17	Detected	5558.2MHz, -62.0dBm
Trial #18	Detected	5553.2MHz, -62.0dBm
Trial #19	Detected	5573.2MHz, -62.0dBm
Trial #20	Detected	5568.2MHz, -62.0dBm
Trial #21	Detected	5563.2MHz, -62.0dBm
Trial #22	Detected	5558.2MHz, -62.0dBm
Trial #23	Detected	5553.2MHz, -62.0dBm
Trial #24	Detected	5573.2MHz, -62.0dBm
Trial #25	Detected	5568.2MHz, -62.0dBm
Trial #26	Detected	5563.2MHz, -62.0dBm
Trial #27	Detected	5558.2MHz, -62.0dBm
Trial #28	Detected	5553.2MHz, -62.0dBm
Trial #29	Detected	5573.2MHz, -62.0dBm
Trial #30	Detected	5568.2MHz, -62.0dBm

**Table 128 - WU Steady State Long Sequence Waveform Trial#1 (Detected)**

Burst #	# Pulses	Pulse Width (us)	Chirp (MHz)	Interval 1 to 2 (us)	Interval 2 to 3 (us)	Start time (us)
1	1	60.8	20	-	-	0.052437
2	3	54.7	5	1241.0	1582.0	1.255136
3	1	72.3	13	-	-	2.105169
4	2	99.6	8	1705.0	-	2.274358
5	2	84.1	9	1836.0	-	3.020480
6	3	65.5	20	1760.0	1482.0	3.784972
7	2	87.6	15	1242.0	-	4.876740
8	3	62.0	20	1076.0	1015.0	5.618605
9	1	98.7	6	-	-	6.612311
10	1	62.4	13	-	-	7.173567
11	1	86.2	12	-	-	7.608643
12	1	55.5	10	-	-	8.425812
13	3	73.1	6	1792.0	1648.0	9.347666
14	2	99.0	5	1723.0	-	9.839726
15	1	65.7	19	-	-	10.977566
16	3	57.9	14	1273.0	1514.0	11.892937

**Table 129 - WU Steady State Long Sequence Waveform Trial#2 (Detected)**

Burst #	# Pulses	Pulse Width (us)	Chirp (MHz)	Interval 1 to 2 (us)	Interval 2 to 3 (us)	Start time (us)
1	3	94.1	13	1520.0	1632.0	0.278747
2	2	93.3	9	1709.0	-	1.179908
3	3	63.8	14	1891.0	1665.0	2.328408
4	1	91.8	18	-	-	3.540265
5	2	93.9	10	1397.0	-	4.811784
6	1	56.1	13	-	-	5.360509
7	3	75.0	13	1580.0	1098.0	6.062692
8	2	83.7	17	1610.0	-	7.589176
9	1	74.2	19	-	-	8.698948
10	3	79.4	10	1168.0	1176.0	9.390550
11	3	83.0	19	1037.0	1329.0	10.819471
12	3	59.6	11	1478.0	1647.0	11.756983

**Table 130 - WU Steady State Long Sequence Waveform Trial#3 (Detected)**

Burst #	# Pulses	Pulse Width (us)	Chirp (MHz)	Interval 1 to 2 (us)	Interval 2 to 3 (us)	Start time (us)
1	2	68.0	12	1483.0	-	0.289981
2	1	80.7	7	-	-	1.309995
3	2	59.1	6	1874.0	-	1.574370
4	1	91.9	7	-	-	2.268889
5	3	60.9	10	1349.0	1548.0	3.628987
6	1	91.6	17	-	-	4.312240
7	1	50.2	11	-	-	4.979538
8	2	71.6	19	1308.0	-	5.914811
9	2	99.9	12	1252.0	-	6.391635
10	2	63.8	13	1418.0	-	7.201371
11	2	91.2	7	1861.0	-	7.779689
12	3	84.6	15	1847.0	1724.0	8.521720
13	3	99.9	5	1079.0	1987.0	9.223068
14	2	98.4	10	1334.0	-	10.209767
15	2	70.6	17	1564.0	-	11.017259
16	2	73.1	13	1559.0	-	11.943923

**Table 131 - WU Steady State Long Sequence Waveform Trial#4 (Detected)**

Burst #	# Pulses	Pulse Width (us)	Chirp (MHz)	Interval 1 to 2 (us)	Interval 2 to 3 (us)	Start time (us)
1	3	50.5	14	1096.0	1617.0	0.042274
2	2	54.8	9	1874.0	-	0.948268
3	3	60.9	15	1291.0	1022.0	1.581176
4	2	68.6	15	1104.0	-	1.959558
5	1	54.1	12	-	-	3.095087
6	3	88.8	7	1868.0	1783.0	3.649760
7	1	61.2	14	-	-	4.203235
8	2	93.3	17	1981.0	-	4.817063
9	2	98.2	10	1327.0	-	5.433691
10	3	67.4	20	1680.0	1108.0	5.782510
11	3	78.5	16	1779.0	1893.0	6.579735
12	1	68.3	15	-	-	7.264903
13	2	72.3	19	1824.0	-	8.079077
14	3	60.3	10	1621.0	1902.0	8.273602
15	3	90.2	18	1066.0	1024.0	9.325895
16	1	65.0	19	-	-	10.042137
17	2	65.2	8	1672.0	-	10.648752
18	1	62.1	10	-	-	10.832096
19	1	83.9	11	-	-	11.867954

**Table 132 - WU Steady State Long Sequence Waveform Trial#5 (Detected)**

Burst #	# Pulses	Pulse Width (us)	Chirp (MHz)	Interval 1 to 2 (us)	Interval 2 to 3 (us)	Start time (us)
1	1	91.3	6	-	-	0.442564
2	2	72.1	17	1848.0	-	0.929949
3	2	89.7	9	1432.0	-	1.808139
4	2	75.9	16	1099.0	-	2.107305
5	3	76.8	19	1210.0	1592.0	3.183891
6	1	52.2	6	-	-	3.918670
7	2	74.5	11	1572.0	-	4.477941
8	2	61.1	6	1310.0	-	5.328219
9	2	71.6	6	1035.0	-	5.349338
10	2	78.0	15	1895.0	-	6.446243
11	1	58.6	20	-	-	6.911101
12	1	70.2	9	-	-	7.950119
13	3	89.8	9	1229.0	1209.0	8.445847
14	3	98.3	15	1586.0	1240.0	8.882084
15	2	72.9	8	1186.0	-	9.341036
16	2	89.0	9	1150.0	-	10.433368
17	2	60.1	17	1112.0	-	10.922601
18	1	53.1	15	-	-	11.590420

**Table 133 - WU Steady State Long Sequence Waveform Trial#6 (Detected)**

Burst #	# Pulses	Pulse Width (us)	Chirp (MHz)	Interval 1 to 2 (us)	Interval 2 to 3 (us)	Start time (us)
1	1	82.9	20	-	-	0.367734
2	1	77.6	20	-	-	0.945715
3	1	86.5	7	-	-	2.719554
4	2	60.0	9	1442.0	-	3.231484
5	1	97.1	18	-	-	4.317061
6	3	51.3	7	1198.0	1253.0	4.744167
7	3	69.3	8	1354.0	1211.0	5.938193
8	3	65.5	10	1363.0	1820.0	7.329275
9	3	50.4	16	1765.0	1916.0	7.926702
10	2	76.6	5	1617.0	-	8.322239
11	1	83.1	11	-	-	9.975330
12	1	75.8	13	-	-	10.648093
13	3	94.5	11	1166.0	1892.0	11.970376

**Table 134 - WU Steady State Long Sequence Waveform Trial#7 (Detected)**

Burst #	# Pulses	Pulse Width (us)	Chirp (MHz)	Interval 1 to 2 (us)	Interval 2 to 3 (us)	Start time (us)
1	3	80.7	9	1981.0	1087.0	0.853293
2	3	72.8	18	1883.0	1456.0	1.253285
3	2	63.0	14	1136.0	-	1.986143
4	2	97.7	15	1518.0	-	2.913668
5	1	78.3	18	-	-	4.280718
6	1	79.6	19	-	-	5.210909
7	1	54.6	9	-	-	6.243745
8	2	65.8	14	1421.0	-	7.193621
9	3	87.4	12	1755.0	1282.0	7.602720
10	1	97.0	12	-	-	9.056335
11	1	68.9	15	-	-	9.945040
12	1	85.2	15	-	-	10.964512
13	3	70.7	10	1788.0	1389.0	11.845682



**Table 135 - WU Steady State Long Sequence Waveform Trial#8 (Detected)**

Burst #	# Pulses	Pulse Width (us)	Chirp (MHz)	Interval 1 to 2 (us)	Interval 2 to 3 (us)	Start time (us)
1	2	77.8	15	1183.0	-	0.607644
2	2	76.0	19	1328.0	-	0.891443
3	1	87.0	20	-	-	1.393564
4	3	63.5	13	1792.0	1119.0	2.077013
5	1	97.6	13	-	-	2.695140
6	3	71.4	20	1352.0	1413.0	3.523945
7	3	78.8	13	1018.0	1975.0	3.919021
8	3	51.4	11	1714.0	1315.0	5.019838
9	2	73.5	17	1087.0	-	5.307559
10	2	56.2	16	1796.0	-	6.283304
11	3	91.3	14	1268.0	1410.0	6.757935
12	2	75.2	7	1959.0	-	7.138060
13	2	80.6	12	1348.0	-	7.907655
14	3	68.3	8	1461.0	1157.0	8.297567
15	2	57.6	14	1430.0	-	9.138296
16	2	78.9	18	1718.0	-	9.707867
17	3	82.3	13	1318.0	1416.0	10.133903
18	2	74.4	8	1846.0	-	10.825069
19	3	68.4	7	1337.0	1719.0	11.497755

**Table 136 - WU Steady State Long Sequence Waveform Trial#9 (Detected)**

Burst #	# Pulses	Pulse Width (us)	Chirp (MHz)	Interval 1 to 2 (us)	Interval 2 to 3 (us)	Start time (us)
1	1	90.6	11	-	-	0.073231
2	1	72.4	8	-	-	1.304645
3	2	91.2	20	1122.0	-	2.602055
4	2	87.2	16	1321.0	-	4.427440
5	2	52.6	11	1720.0	-	5.325466
6	1	82.5	6	-	-	6.323911
7	2	91.3	8	1438.0	-	7.712343
8	3	84.9	18	1756.0	1182.0	8.444107
9	1	81.9	17	-	-	10.615667
10	3	61.0	15	1064.0	1250.0	11.208504

**Table 137 - WU Steady State Long Sequence Waveform Trial#10 (Detected)**

Burst #	# Pulses	Pulse Width (us)	Chirp (MHz)	Interval 1 to 2 (us)	Interval 2 to 3 (us)	Start time (us)
1	2	88.8	10	1663.0	-	0.424044
2	1	69.9	9	-	-	1.462517
3	1	72.9	14	-	-	3.292809
4	3	69.7	15	1625.0	1741.0	5.157289
5	1	60.7	12	-	-	6.487660
6	3	90.2	13	1856.0	1022.0	7.709047
7	1	74.5	6	-	-	8.011398
8	1	63.0	16	-	-	9.335375
9	2	51.7	7	1692.0	-	11.312208

**Table 138 - WU Steady State Long Sequence Waveform Trial#11 (Detected)**

Burst #	# Pulses	Pulse Width (us)	Chirp (MHz)	Interval 1 to 2 (us)	Interval 2 to 3 (us)	Start time (us)
1	2	52.9	14	1532.0	-	0.291506
2	1	76.7	20	-	-	0.676483
3	2	53.6	18	1080.0	-	1.374215
4	2	77.6	17	1909.0	-	2.168446
5	2	59.6	8	1005.0	-	2.740258
6	2	62.3	13	1356.0	-	3.429115
7	3	59.8	15	1883.0	1386.0	4.662677
8	2	62.1	14	1483.0	-	4.856162
9	2	71.5	16	1018.0	-	5.850053
10	1	60.4	9	-	-	6.288456
11	3	99.1	19	1764.0	1937.0	6.817977
12	2	74.9	19	1278.0	-	7.391557
13	2	82.9	12	1217.0	-	8.498100
14	3	78.9	14	1886.0	1475.0	8.993792
15	1	64.8	9	-	-	9.472637
16	2	95.0	20	1111.0	-	10.530049
17	2	83.3	12	1415.0	-	11.221865
18	2	79.0	6	1124.0	-	11.773829

**Table 139 - WU Steady State Long Sequence Waveform Trial#12 (Detected)**

Burst #	# Pulses	Pulse Width (us)	Chirp (MHz)	Interval 1 to 2 (us)	Interval 2 to 3 (us)	Start time (us)
1	2	91.8	11	1794.0	-	0.591696
2	1	71.5	16	-	-	1.384516
3	3	67.2	9	1217.0	1469.0	1.609037
4	2	79.6	8	1740.0	-	2.774464
5	2	68.9	9	1942.0	-	3.607004
6	1	67.9	10	-	-	4.353030
7	3	77.3	17	1637.0	1530.0	4.736066
8	3	92.6	8	1850.0	1633.0	5.908307
9	2	57.2	20	1463.0	-	6.426088
10	2	91.2	18	1357.0	-	6.903207
11	3	70.5	5	1521.0	1280.0	8.145871
12	3	52.8	18	1124.0	1065.0	8.817052
13	3	75.9	14	1316.0	1945.0	9.725527
14	2	68.3	16	1481.0	-	10.240363
15	2	54.9	16	1849.0	-	10.635434
16	2	54.7	18	1316.0	-	11.736428

**Table 140 - WU Steady State Long Sequence Waveform Trial#13 (Detected)**

Burst #	# Pulses	Pulse Width (us)	Chirp (MHz)	Interval 1 to 2 (us)	Interval 2 to 3 (us)	Start time (us)
1	1	79.8	11	-	-	0.320378
2	1	85.8	17	-	-	1.371255
3	2	70.7	6	1581.0	-	1.832069
4	2	96.1	12	1007.0	-	2.714252
5	2	52.6	14	1561.0	-	3.349107
6	3	75.8	15	1957.0	1749.0	3.633821
7	2	65.8	6	1342.0	-	4.443238
8	3	54.2	6	1397.0	1645.0	5.070013
9	3	77.8	7	1904.0	1112.0	6.215241
10	3	77.8	7	1001.0	1265.0	6.736453
11	2	63.4	7	1018.0	-	7.438724
12	2	64.9	13	1348.0	-	8.135754
13	3	81.5	7	1625.0	1417.0	8.952603
14	3	59.4	9	1596.0	1792.0	9.204207
15	3	68.9	14	1529.0	1605.0	10.562318
16	2	57.9	12	1767.0	-	11.245124
17	3	56.2	6	1687.0	1694.0	11.832971

**Table 141 - WU Steady State Long Sequence Waveform Trial#14 (Detected)**

Burst #	# Pulses	Pulse Width (us)	Chirp (MHz)	Interval 1 to 2 (us)	Interval 2 to 3 (us)	Start time (us)
1	1	51.4	16	-	-	0.914331
2	2	70.5	15	1070.0	-	1.812593
3	3	52.8	12	1904.0	1112.0	3.861262
4	2	72.0	14	1760.0	-	4.804421
5	1	97.0	12	-	-	5.408491
6	1	87.0	13	-	-	7.228450
7	2	67.8	11	1703.0	-	9.029893
8	1	53.1	15	-	-	9.950911
9	1	58.7	6	-	-	11.474298

**Table 142 - WU Steady State Long Sequence Waveform Trial#15 (Detected)**

Burst #	# Pulses	Pulse Width (us)	Chirp (MHz)	Interval 1 to 2 (us)	Interval 2 to 3 (us)	Start time (us)
1	2	65.1	19	1400.0	-	0.824334
2	3	83.5	6	1887.0	1205.0	1.240666
3	3	74.2	8	1806.0	1628.0	2.562591
4	1	91.6	7	-	-	3.271905
5	2	56.4	13	1311.0	-	3.861519
6	1	75.6	12	-	-	5.269719
7	3	95.3	19	1889.0	1441.0	5.833323
8	1	83.0	19	-	-	7.063064
9	3	77.6	6	1347.0	1996.0	8.052321
10	1	81.9	16	-	-	8.633495
11	2	88.6	14	1210.0	-	9.348223
12	2	95.9	17	1859.0	-	10.643214
13	2	91.6	14	1550.0	-	11.972737

**Table 143 - WU Steady State Long Sequence Waveform Trial#16 (Detected)**

Burst #	# Pulses	Pulse Width (us)	Chirp (MHz)	Interval 1 to 2 (us)	Interval 2 to 3 (us)	Start time (us)
1	1	55.9	9	-	-	0.161626
2	1	70.9	10	-	-	1.156780
3	3	79.9	10	1458.0	1724.0	2.899490
4	3	70.6	14	1544.0	1732.0	3.869210
5	2	79.6	10	1373.0	-	5.332418
6	1	51.3	19	-	-	6.064033
7	3	84.9	7	1511.0	1957.0	6.586282
8	1	73.8	6	-	-	8.013090
9	2	60.2	10	1712.0	-	9.397068
10	2	96.7	14	1734.0	-	10.562288
11	2	51.0	15	1991.0	-	11.210801

**Table 144 - WU Steady State Long Sequence Waveform Trial#17 (Detected)**

Burst #	# Pulses	Pulse Width (us)	Chirp (MHz)	Interval 1 to 2 (us)	Interval 2 to 3 (us)	Start time (us)
1	2	50.5	11	1229.0	-	0.707302
2	3	95.9	6	1802.0	1798.0	2.112532
3	2	65.1	6	1533.0	-	2.492193
4	2	93.3	19	1284.0	-	3.684691
5	2	85.1	18	1908.0	-	5.121012
6	2	98.0	13	1039.0	-	5.921953
7	2	89.5	12	1439.0	-	7.003876
8	2	88.4	8	1398.0	-	8.553742
9	3	66.7	10	1356.0	1746.0	9.022212
10	3	90.7	7	1122.0	1627.0	10.861346
11	1	99.3	5	-	-	11.830630

**Table 145 - WU Steady State Long Sequence Waveform Trial#18 (Detected)**

Burst #	# Pulses	Pulse Width (us)	Chirp (MHz)	Interval 1 to 2 (us)	Interval 2 to 3 (us)	Start time (us)
1	2	75.6	19	1828.0	-	0.265021
2	1	53.7	11	-	-	0.994232
3	2	86.3	17	1870.0	-	1.857450
4	3	91.1	10	1803.0	1946.0	2.768746
5	2	53.1	14	1817.0	-	3.742012
6	2	51.5	16	1480.0	-	5.104338
7	3	64.0	14	1961.0	1116.0	5.191815
8	2	99.1	10	1213.0	-	6.851489
9	2	75.5	8	1297.0	-	7.679180
10	3	99.1	18	1373.0	1995.0	8.061066
11	2	59.2	11	1436.0	-	8.675728
12	2	91.2	13	1919.0	-	9.563193
13	2	98.6	15	1518.0	-	10.955039
14	3	51.7	16	1848.0	1281.0	11.402794

**Table 146 - WU Steady State Long Sequence Waveform Trial#19 (Detected)**

Burst #	# Pulses	Pulse Width (us)	Chirp (MHz)	Interval 1 to 2 (us)	Interval 2 to 3 (us)	Start time (us)
1	1	58.9	20	-	-	0.584119
2	1	99.9	9	-	-	1.660982
3	2	85.9	17	1228.0	-	2.480960
4	3	89.2	19	1003.0	1133.0	3.470005
5	3	85.7	5	1827.0	1854.0	3.750483
6	3	97.6	16	1364.0	1815.0	4.893959
7	2	56.3	9	1685.0	-	5.652211
8	3	78.7	8	1760.0	1552.0	7.320193
9	1	96.5	11	-	-	7.598049
10	3	61.5	8	1231.0	1501.0	8.589083
11	2	86.5	18	1288.0	-	9.284142
12	2	79.3	15	1117.0	-	10.851075
13	3	60.7	15	1048.0	1384.0	11.686204

**Table 147 - WU Steady State Long Sequence Waveform Trial#20 (Detected)**

Burst #	# Pulses	Pulse Width (us)	Chirp (MHz)	Interval 1 to 2 (us)	Interval 2 to 3 (us)	Start time (us)
1	2	62.7	9	1209.0	-	0.562526
2	3	79.4	11	1593.0	1543.0	0.968201
3	1	57.3	17	-	-	1.563290
4	2	87.7	6	1900.0	-	2.628872
5	1	92.9	6	-	-	3.127043
6	3	62.6	16	1961.0	1397.0	4.196424
7	1	51.4	7	-	-	4.467128
8	1	77.8	16	-	-	5.587936
9	3	65.3	19	1047.0	1504.0	6.174628
10	1	53.3	11	-	-	6.756254
11	2	65.8	14	1240.0	-	7.694377
12	2	57.0	15	1914.0	-	7.874710
13	2	66.0	13	1432.0	-	8.612654
14	2	85.1	9	1646.0	-	9.865389
15	2	58.2	11	1104.0	-	10.371494
16	3	77.8	9	1543.0	1138.0	10.816238
17	2	60.9	9	1530.0	-	11.868099

**Table 148 - WU Steady State Long Sequence Waveform Trial#21 (Detected)**

Burst #	# Pulses	Pulse Width (us)	Chirp (MHz)	Interval 1 to 2 (us)	Interval 2 to 3 (us)	Start time (us)
1	3	53.7	12	1275.0	1211.0	0.469253
2	2	57.1	12	1693.0	-	1.122525
3	3	50.8	12	1047.0	1925.0	1.653376
4	2	59.8	19	1249.0	-	1.914972
5	1	60.1	12	-	-	2.586696
6	2	54.3	12	1579.0	-	3.431958
7	3	87.6	9	1668.0	1327.0	3.991298
8	2	79.0	13	1306.0	-	4.234106
9	2	77.2	10	1387.0	-	4.807244
10	1	71.5	13	-	-	5.831561
11	3	56.5	16	1276.0	1011.0	6.173060
12	1	95.0	9	-	-	6.612916
13	2	79.0	18	1797.0	-	7.630653
14	3	52.9	8	1014.0	1214.0	8.294259
15	1	90.6	6	-	-	8.569644
16	2	95.6	17	1583.0	-	9.159672
17	1	74.8	13	-	-	10.012565
18	2	88.6	10	1005.0	-	10.585763
19	2	91.3	10	1201.0	-	11.329852
20	2	95.7	12	1838.0	-	11.817892

**Table 149 - WU Steady State Long Sequence Waveform Trial#22 (Detected)**

Burst #	# Pulses	Pulse Width (us)	Chirp (MHz)	Interval 1 to 2 (us)	Interval 2 to 3 (us)	Start time (us)
1	3	79.1	20	1645.0	1290.0	0.409146
2	1	56.9	11	-	-	1.414176
3	2	52.8	8	1754.0	-	2.749678
4	2	52.8	16	1690.0	-	3.576011
5	3	88.4	18	1252.0	1993.0	5.396837
6	1	56.2	18	-	-	6.063185
7	1	90.1	6	-	-	7.564177
8	3	93.5	7	1634.0	1353.0	8.697903
9	2	87.5	18	1188.0	-	9.588484
10	2	72.8	6	1965.0	-	10.283483
11	2	60.5	8	1944.0	-	11.037505

**Table 150 - WU Steady State Long Sequence Waveform Trial#23 (Detected)**

Burst #	# Pulses	Pulse Width (us)	Chirp (MHz)	Interval 1 to 2 (us)	Interval 2 to 3 (us)	Start time (us)
1	2	83.8	9	1600.0	-	1.090824
2	3	60.5	12	1164.0	1378.0	1.996310
3	2	65.2	17	1319.0	-	3.337704
4	1	57.5	12	-	-	3.709426
5	2	97.8	7	1011.0	-	5.903905
6	3	89.0	17	1083.0	1961.0	6.204805
7	2	60.1	14	1087.0	-	8.166899
8	2	77.3	9	1716.0	-	9.592617
9	2	61.5	13	1755.0	-	10.115608
10	3	59.3	16	1271.0	1957.0	10.841210

**Table 151 - WU Steady State Long Sequence Waveform Trial#24 (Detected)**

Burst #	# Pulses	Pulse Width (us)	Chirp (MHz)	Interval 1 to 2 (us)	Interval 2 to 3 (us)	Start time (us)
1	2	89.3	18	1358.0	-	0.680478
2	2	86.6	20	1342.0	-	1.181958
3	2	72.9	7	1582.0	-	1.619042
4	2	85.9	15	1238.0	-	2.903022
5	2	93.0	5	1715.0	-	3.140467
6	1	89.9	14	-	-	4.082247
7	1	85.3	14	-	-	5.022194
8	3	74.4	14	1440.0	1924.0	5.735813
9	1	68.4	15	-	-	6.550565
10	1	54.9	10	-	-	6.803990
11	3	81.8	16	1165.0	1029.0	8.003044
12	2	87.7	15	1222.0	-	8.482505
13	1	82.3	10	-	-	9.261822
14	2	80.7	13	1571.0	-	10.170646
15	3	81.8	8	1321.0	1265.0	10.505890
16	3	65.2	16	1061.0	1265.0	11.479910

**Table 152 - WU Steady State Long Sequence Waveform Trial#25 (Detected)**

Burst #	# Pulses	Pulse Width (us)	Chirp (MHz)	Interval 1 to 2 (us)	Interval 2 to 3 (us)	Start time (us)
1	3	78.7	17	1687.0	1227.0	0.038728
2	2	99.6	13	1453.0	-	2.110371
3	1	87.7	10	-	-	3.616762
4	3	85.3	10	1501.0	1516.0	5.988017
5	2	61.4	6	1562.0	-	6.772640
6	1	72.0	6	-	-	8.175778
7	1	76.7	19	-	-	9.125592
8	1	73.4	9	-	-	11.249663

**Table 153 - WU Steady State Long Sequence Waveform Trial#26 (Detected)**

Burst #	# Pulses	Pulse Width (us)	Chirp (MHz)	Interval 1 to 2 (us)	Interval 2 to 3 (us)	Start time (us)
1	1	53.5	10	-	-	0.677529
2	3	84.6	9	1656.0	1710.0	1.390433
3	2	63.2	17	1601.0	-	3.799789
4	3	55.6	8	1063.0	1032.0	4.665487
5	3	85.6	13	1945.0	1338.0	6.552000
6	3	58.6	7	1211.0	1004.0	7.161487
7	2	69.8	6	1579.0	-	8.765422
8	2	65.3	17	1287.0	-	10.324986
9	2	73.5	8	1938.0	-	11.447985

**Table 154 - WU Steady State Long Sequence Waveform Trial#27 (Detected)**

Burst #	# Pulses	Pulse Width (us)	Chirp (MHz)	Interval 1 to 2 (us)	Interval 2 to 3 (us)	Start time (us)
1	2	94.1	7	1223.0	-	0.349348
2	2	83.0	7	1071.0	-	1.137382
3	2	55.1	19	1846.0	-	1.989594
4	2	74.8	12	1023.0	-	2.782311
5	1	91.8	13	-	-	3.213972
6	1	71.3	15	-	-	3.893076
7	2	64.1	12	1300.0	-	4.683437
8	2	56.2	15	1822.0	-	5.359537
9	2	98.3	13	1919.0	-	6.064875
10	1	51.9	5	-	-	6.550294
11	2	85.7	19	1739.0	-	7.485143
12	2	91.3	16	1415.0	-	7.779432
13	2	76.7	14	1227.0	-	8.978234
14	2	92.1	18	1023.0	-	9.489103
15	2	61.1	11	1340.0	-	10.389631
16	2	85.0	6	1780.0	-	10.788183
17	1	90.4	9	-	-	11.405851



**Table 155 - WU Steady State Long Sequence Waveform Trial#28 (Detected)**

Burst #	# Pulses	Pulse Width (us)	Chirp (MHz)	Interval 1 to 2 (us)	Interval 2 to 3 (us)	Start time (us)
1	1	68.2	13	-	-	0.396219
2	2	54.9	19	1458.0	-	0.810572
3	1	82.9	18	-	-	1.422153
4	2	85.5	17	1782.0	-	2.013633
5	1	83.3	12	-	-	2.795363
6	2	58.4	18	1739.0	-	3.574413
7	1	80.5	6	-	-	4.344381
8	1	90.2	11	-	-	4.785464
9	3	68.6	20	1411.0	1253.0	5.673674
10	3	81.5	17	1798.0	1572.0	5.951347
11	2	66.8	15	1024.0	-	6.563921
12	2	76.8	17	1817.0	-	7.574474
13	3	83.3	9	1228.0	1587.0	8.026738
14	3	52.4	15	1864.0	1822.0	8.277175
15	2	79.7	13	1261.0	-	9.046903
16	3	72.1	15	1829.0	1540.0	9.512519
17	3	80.6	10	1259.0	1533.0	10.248581
18	1	61.7	17	-	-	11.201138
19	3	71.1	16	1946.0	1494.0	11.570853

**Table 156 - WU Steady State Long Sequence Waveform Trial#29 (Detected)**

Burst #	# Pulses	Pulse Width (us)	Chirp (MHz)	Interval 1 to 2 (us)	Interval 2 to 3 (us)	Start time (us)
1	2	73.9	18	1535.0	-	0.748093
2	2	56.7	7	1991.0	-	1.141326
3	2	50.6	10	1474.0	-	2.665666
4	2	51.0	15	1365.0	-	3.312918
5	2	83.3	8	1637.0	-	3.973931
6	3	89.9	8	1681.0	1095.0	5.030659
7	2	95.3	15	1247.0	-	5.813160
8	1	63.5	16	-	-	7.149433
9	2	74.6	11	1764.0	-	7.656164
10	3	78.3	14	1161.0	1119.0	9.082388
11	2	90.4	13	1398.0	-	9.429936
12	1	95.8	19	-	-	10.565776
13	1	80.3	17	-	-	11.200370

**Table 157 - WU Steady State Long Sequence Waveform Trial#30 (Detected)**

Burst #	# Pulses	Pulse Width (us)	Chirp (MHz)	Interval 1 to 2 (us)	Interval 2 to 3 (us)	Start time (us)
1	3	96.3	8	1094.0	1817.0	0.339644
2	2	87.7	17	1649.0	-	1.211421
3	1	52.2	5	-	-	1.801377
4	2	71.1	10	1696.0	-	2.313606
5	1	61.3	18	-	-	3.126546
6	2	66.5	19	1478.0	-	3.554038
7	2	73.3	13	1605.0	-	4.529840
8	3	95.4	12	1559.0	1776.0	5.112437
9	3	70.7	6	1746.0	1970.0	5.550998
10	1	65.7	12	-	-	6.533290
11	2	66.8	8	1923.0	-	7.266759
12	1	99.0	10	-	-	7.471124
13	2	87.7	17	1881.0	-	8.326028
14	1	52.9	9	-	-	9.254839
15	2	94.6	16	1894.0	-	9.533017
16	3	96.9	13	1033.0	1495.0	10.518613
17	3	64.8	9	1321.0	1893.0	11.318230
18	2	62.0	18	1647.0	-	11.550284

**Table 158 - Summary of All Results - WU Steady State**

Waveform Name	Pd (%)	Pd Required (%)	Number of Trials	Status
FCC frequency hopping radar (Type 6)	100.0 %	70.0 %	34	PASSED

Table 159 - FCC frequency hopping radar (Type 6) Results WU Steady State						
Trial #	Pulses/ Burst	Pulse Width (us)	PRI (us)	Detected	Fr (MHz) and level (dBm)	Burst Information
1	9	1.0	333.0	Yes	5579.2MHz, -62.0dBm	Hop sequence: 5452, 5515, 5662, 5633, 5612, 5397, 5626, 5402, 5322, 5519, 5476, 5484, 5457, 5460, 5536, 5327, 5474, 5319, 5314, 5296, 5672, 5334, 5394, 5640, 5451, 5442, 5432, 5532, 5375, 5668, 5271, 5331, 5479, 5529, 5390, 5524, 5379, 5318, 5646, 5578, 5285, 5692, 5582, 5637, 5382, 5357, 5301, 5577, 5586, 5570, 5371, 5364, 5423, 5676, 5401, 5323, 5424, 5494, 5412, 5557, 5496, 5422, 5438, 5542, 5636, 5658, 5579, 5302, 5600, 5581, 5335, 5341, 5261, 5493, 5446, 5499, 5561, 5400, 5551, 5465, 5522, 5278, 5588, 5441, 5659, 5398, 5336, 5678, 5654, 5498, 5572, 5415, 5421, 5544, 5439, 5343, 5615, 5518, 5501, 5405 (8 hits) (03/26/2012 05:07:00 PM)
2	9	1.0	333.0	Yes	5580.2MHz, -62.0dBm	Hop sequence: 5480, 5626, 5409, 5366, 5547, 5382, 5619, 5469, 5535, 5275, 5395, 5352, 5524, 5335, 5464, 5615, 5678, 5425, 5556, 5647, 5534, 5436, 5476, 5580, 5700, 5431, 5712, 5418, 5315, 5659, 5621, 5323, 5419, 5681, 5636, 5528, 5560, 5310, 5473, 5305, 5467, 5578, 5590, 5292, 5456, 5682, 5255, 5333, 5428, 5401, 5478, 5405, 5665, 5306, 5374, 5721, 5294, 5398, 5522, 5652, 5439, 5283, 5714, 5277, 5285, 5612, 5582, 5631, 5693, 5289, 5550, 5541, 5434, 5387, 5644, 5614, 5399, 5574, 5351, 5519, 5692, 5588, 5601, 5362, 5604, 5348, 5363, 5307, 5435, 5417, 5674, 5625, 5391, 5290, 5369, 5546, 5429, 5282, 5638, 5660 (6 hits) (03/26/2012 05:07:09 PM)
3	9	1.0	333.0	Yes	5547.2MHz, -62.0dBm	Hop sequence: 5424, 5693, 5661, 5372, 5313, 5350, 5512, 5594, 5583, 5255, 5419, 5382, 5471, 5336, 5684, 5614, 5668, 5306, 5301, 5602, 5540, 5530, 5406, 5271, 5319, 5403, 5697, 5704, 5276, 5257, 5548, 5357, 5401, 5665, 5593, 5501, 5473, 5591, 5649, 5589, 5544, 5712, 5708, 5431, 5522, 5696, 5629, 5275,

Table 159 - FCC frequency hopping radar (Type 6) Results WU Steady State						
Trial #	Pulses/ Burst	Pulse Width (us)	PRI (us)	Detected	Fr (MHz) and level (dBm)	Burst Information
						5675, 5256, 5509, 5283, 5658, 5546, 5288, 5458, 5539, 5705, 5298, 5396, 5294, 5550, 5418, 5571, 5575, 5541, 5610, 5352, 5517, 5449, 5576, 5329, 5438, 5423, 5442, 5579, 5553, 5578, 5525, 5361, 5268, 5606, 5607, 5650, 5480, 5460, 5655, 5310, 5643, 5439, 5341, 5377, 5680, 5486, 5270, 5534, 5440, 5632, 5657, 5570 (9 hits) (03/26/2012 05:07:25 PM)
4	9	1.0	333.0	Yes	5548.2MHz, -62.0dBm	Hop sequence: 5378, 5373, 5305, 5264, 5517, 5395, 5548, 5464, 5325, 5653, 5672, 5616, 5605, 5304, 5643, 5418, 5469, 5700, 5333, 5694, 5620, 5335, 5387, 5402, 5692, 5292, 5286, 5386, 5487, 5281, 5535, 5454, 5488, 5629, 5586, 5257, 5336, 5608, 5499, 5451, 5670, 5503, 5708, 5497, 5316, 5480, 5701, 5369, 5627, 5685, 5421, 5298, 5290, 5477, 5253, 5338, 5446, 5339, 5449, 5383, 5599, 5353, 5697, 5342, 5340, 5712, 5541, 5330, 5268, 5391, 5272, 5659, 5428, 5600, 5514, 5424, 5691, 5501, 5432, 5429, 5650, 5282, 5271, 5311, 5609, 5716, 5510, 5284, 5365, 5420, 5575, 5382, 5612, 5260, 5572, 5255, 5496, 5570, 5294, 5718 (4 hits) (03/26/2012 05:07:35 PM)
5	9	1.0	333.0	Yes	5549.2MHz, -62.0dBm	Hop sequence: 5267, 5272, 5251, 5523, 5260, 5541, 5331, 5307, 5663, 5602, 5378, 5675, 5266, 5702, 5456, 5302, 5287, 5682, 5634, 5564, 5337, 5284, 5468, 5257, 5709, 5596, 5611, 5622, 5581, 5494, 5383, 5492, 5619, 5440, 5516, 5530, 5540, 5556, 5590, 5422, 5412, 5288, 5627, 5428, 5280, 5652, 5504, 5424, 5511, 5686, 5659, 5493, 5674, 5614, 5418, 5429, 5289, 5506, 5535, 5283, 5532, 5520, 5711, 5396, 5357, 5690, 5693, 5384, 5330, 5455, 5522, 5462, 5423, 5620, 5724, 5259, 5576, 5697, 5572, 5617, 5595, 5721, 5419, 5579, 5425, 5363, 5484, 5584, 5486, 5603, 5640, 5401, 5254, 5315, 5467, 5657, 5638, 5327, 5261, 5340 (5 hits) (03/26/2012

Table 159 - FCC frequency hopping radar (Type 6) Results WU Steady State						
Trial #	Pulses/ Burst	Pulse Width (us)	PRI (us)	Detected	Fr (MHz) and level (dBm)	Burst Information
						05:07:42 PM)
6	9	1.0	333.0	Yes	5550.2MHz, -62.0dBm	Hop sequence: 5700, 5390, 5344, 5563, 5404, 5365, 5587, 5699, 5446, 5685, 5678, 5582, 5681, 5355, 5354, 5513, 5373, 5669, 5658, 5406, 5463, 5673, 5396, 5646, 5415, 5493, 5521, 5308, 5294, 5670, 5253, 5350, 5600, 5481, 5434, 5461, 5651, 5595, 5608, 5615, 5471, 5671, 5380, 5599, 5304, 5391, 5622, 5603, 5619, 5544, 5535, 5557, 5321, 5256, 5484, 5297, 5479, 5604, 5664, 5258, 5462, 5649, 5421, 5375, 5423, 5683, 5550, 5626, 5594, 5551, 5495, 5516, 5523, 5589, 5329, 5499, 5612, 5306, 5601, 5284, 5502, 5352, 5268, 5701, 5567, 5512, 5655, 5425, 5698, 5530, 5385, 5295, 5702, 5526, 5581, 5438, 5509, 5401, 5613, 5598 (5 hits) (03/26/2012 05:07:52 PM)
7	9	1.0	333.0	Yes	5551.2MHz, -62.0dBm	Hop sequence: 5681, 5390, 5547, 5296, 5254, 5294, 5541, 5495, 5542, 5445, 5272, 5637, 5363, 5507, 5354, 5266, 5366, 5485, 5638, 5330, 5380, 5549, 5488, 5392, 5455, 5496, 5514, 5620, 5345, 5533, 5705, 5677, 5284, 5431, 5377, 5292, 5650, 5371, 5447, 5421, 5401, 5528, 5670, 5482, 5424, 5486, 5436, 5469, 5381, 5641, 5524, 5448, 5466, 5470, 5414, 5518, 5548, 5711, 5423, 5714, 5358, 5649, 5574, 5329, 5718, 5314, 5678, 5622, 5657, 5355, 5473, 5364, 5351, 5255, 5261, 5389, 5604, 5344, 5635, 5265, 5350, 5599, 5427, 5500, 5271, 5306, 5298, 5260, 5591, 5411, 5686, 5592, 5369, 5586, 5691, 5280, 5583, 5698, 5446, 5519 (3 hits) (03/26/2012 05:07:59 PM)
8	9	1.0	333.0	Yes	5552.2MHz, -62.0dBm	Hop sequence: 5369, 5382, 5537, 5347, 5578, 5598, 5429, 5311, 5267, 5560, 5608, 5536, 5562, 5359, 5321, 5308, 5339, 5709, 5623, 5496, 5600, 5431, 5492, 5487, 5652, 5368, 5551, 5315, 5481, 5526, 5331, 5521, 5544, 5659, 5255, 5443, 5657, 5678, 5282, 5715, 5698, 5611, 5441, 5416, 5264, 5658, 5257, 5671,

Table 159 - FCC frequency hopping radar (Type 6) Results WU Steady State						
Trial #	Pulses/ Burst	Pulse Width (us)	PRI (us)	Detected	Fr (MHz) and level (dBm)	Burst Information
						5256, 5693, 5519, 5638, 5718, 5561, 5367, 5686, 5555, 5475, 5670, 5721, 5434, 5615, 5334, 5296, 5261, 5613, 5522, 5418, 5708, 5433, 5411, 5550, 5463, 5323, 5277, 5552, 5430, 5414, 5350, 5685, 5314, 5688, 5253, 5650, 5399, 5702, 5527, 5471, 5307, 5335, 5378, 5667, 5528, 5453, 5624, 5285, 5376, 5656, 5651, 5407 (8 hits) (03/26/2012 05:08:06 PM)
9	9	1.0	333.0	Yes	5553.2MHz, -62.0dBm	Hop sequence: 5604, 5452, 5426, 5486, 5654, 5611, 5646, 5312, 5472, 5643, 5281, 5303, 5315, 5362, 5405, 5672, 5534, 5644, 5703, 5631, 5482, 5550, 5370, 5668, 5679, 5612, 5716, 5570, 5473, 5374, 5487, 5466, 5498, 5637, 5399, 5696, 5359, 5284, 5711, 5353, 5400, 5699, 5693, 5386, 5585, 5351, 5515, 5592, 5274, 5375, 5266, 5504, 5574, 5541, 5263, 5533, 5479, 5277, 5500, 5573, 5535, 5615, 5307, 5653, 5635, 5687, 5684, 5713, 5726, 5383, 5328, 5581, 5354, 5536, 5694, 5372, 5407, 5662, 5338, 5470, 5525, 5710, 5262, 5595, 5283, 5689, 5584, 5299, 5398, 5670, 5590, 5477, 5560, 5385, 5282, 5331, 5655, 5507, 5554, 5572 (7 hits) (03/26/2012 05:08:13 PM)
10	9	1.0	333.0	Yes	5554.2MHz, -62.0dBm	Hop sequence: 5672, 5292, 5717, 5473, 5656, 5565, 5457, 5616, 5423, 5370, 5708, 5476, 5684, 5327, 5532, 5593, 5496, 5326, 5419, 5349, 5386, 5686, 5402, 5261, 5393, 5334, 5664, 5343, 5411, 5649, 5516, 5633, 5440, 5715, 5617, 5724, 5408, 5317, 5397, 5469, 5673, 5415, 5566, 5596, 5347, 5693, 5725, 5726, 5523, 5377, 5311, 5385, 5392, 5671, 5591, 5328, 5707, 5413, 5634, 5567, 5691, 5381, 5315, 5689, 5378, 5352, 5630, 5678, 5264, 5605, 5391, 5431, 5465, 5606, 5571, 5308, 5262, 5324, 5720, 5363, 5356, 5341, 5556, 5410, 5297, 5298, 5702, 5536, 5369, 5588, 5575, 5548, 5499, 5340, 5604, 5466, 5629, 5310, 5598, 5384 (7 hits) (03/26/2012

Table 159 - FCC frequency hopping radar (Type 6) Results WU Steady State						
Trial #	Pulses/ Burst	Pulse Width (us)	PRI (us)	Detected	Fr (MHz) and level (dBm)	Burst Information
						05:08:20 PM)
11	9	1.0	333.0	Yes	5555.2MHz, -62.0dBm	Hop sequence: 5615, 5394, 5669, 5369, 5588, 5468, 5575, 5353, 5285, 5722, 5590, 5466, 5536, 5583, 5433, 5301, 5568, 5644, 5474, 5329, 5260, 5696, 5529, 5486, 5419, 5375, 5629, 5399, 5387, 5442, 5700, 5338, 5345, 5689, 5531, 5612, 5587, 5446, 5641, 5654, 5516, 5526, 5393, 5465, 5572, 5319, 5513, 5702, 5459, 5302, 5451, 5600, 5580, 5604, 5610, 5316, 5558, 5712, 5377, 5253, 5291, 5383, 5434, 5658, 5381, 5337, 5269, 5591, 5577, 5371, 5254, 5667, 5406, 5313, 5421, 5492, 5668, 5545, 5407, 5349, 5647, 5683, 5470, 5554, 5351, 5284, 5698, 5627, 5617, 5283, 5598, 5330, 5671, 5366, 5599, 5402, 5537, 5384, 5550, 5678 (8 hits) (03/26/2012 05:08:28 PM)
12	9	1.0	333.0	Yes	5556.2MHz, -62.0dBm	Hop sequence: 5690, 5655, 5523, 5674, 5581, 5292, 5303, 5603, 5299, 5688, 5337, 5540, 5492, 5268, 5594, 5392, 5700, 5263, 5296, 5371, 5364, 5390, 5504, 5726, 5591, 5684, 5335, 5422, 5548, 5475, 5657, 5449, 5481, 5433, 5597, 5369, 5428, 5480, 5487, 5425, 5713, 5568, 5301, 5376, 5432, 5400, 5653, 5685, 5307, 5515, 5615, 5347, 5613, 5593, 5497, 5360, 5628, 5293, 5622, 5375, 5361, 5541, 5648, 5384, 5573, 5696, 5401, 5265, 5348, 5661, 5340, 5605, 5503, 5519, 5436, 5638, 5552, 5485, 5624, 5438, 5399, 5252, 5310, 5280, 5610, 5388, 5304, 5701, 5377, 5406, 5339, 5474, 5391, 5703, 5419, 5580, 5704, 5343, 5514, 5412 (5 hits) (03/26/2012 05:08:35 PM)
13	9	1.0	333.0	Yes	5557.2MHz, -62.0dBm	Hop sequence: 5697, 5577, 5441, 5454, 5633, 5711, 5540, 5420, 5603, 5542, 5462, 5396, 5514, 5295, 5564, 5373, 5529, 5349, 5289, 5477, 5718, 5559, 5523, 5691, 5293, 5310, 5594, 5712, 5632, 5408, 5538, 5313, 5376, 5308, 5338, 5519, 5415, 5361, 5555, 5513, 5425, 5271, 5646, 5536, 5656, 5493, 5645, 5266,

Table 159 - FCC frequency hopping radar (Type 6) Results WU Steady State						
Trial #	Pulses/ Burst	Pulse Width (us)	PRI (us)	Detected	Fr (MHz) and level (dBm)	Burst Information
						5377, 5478, 5524, 5437, 5611, 5344, 5604, 5346, 5263, 5629, 5418, 5406, 5331, 5507, 5325, 5393, 5694, 5426, 5324, 5584, 5702, 5585, 5286, 5639, 5311, 5456, 5416, 5686, 5336, 5388, 5526, 5436, 5570, 5391, 5369, 5535, 5573, 5644, 5328, 5722, 5257, 5480, 5384, 5251, 5258, 5417, 5337, 5501, 5300, 5693, 5655, 5554 (7 hits) (03/26/2012 05:08:41 PM)
14	9	1.0	333.0	Yes	5558.2MHz, -62.0dBm	Hop sequence: 5546, 5684, 5596, 5457, 5615, 5565, 5707, 5721, 5465, 5311, 5716, 5257, 5607, 5627, 5334, 5701, 5362, 5636, 5318, 5336, 5435, 5657, 5594, 5616, 5671, 5516, 5321, 5265, 5251, 5447, 5313, 5379, 5712, 5264, 5553, 5725, 5301, 5295, 5605, 5393, 5443, 5387, 5562, 5347, 5688, 5625, 5287, 5535, 5715, 5274, 5298, 5509, 5604, 5709, 5324, 5405, 5724, 5534, 5521, 5390, 5602, 5589, 5429, 5446, 5598, 5512, 5407, 5508, 5342, 5480, 5415, 5270, 5691, 5631, 5571, 5661, 5344, 5289, 5609, 5452, 5528, 5623, 5573, 5556, 5666, 5423, 5552, 5653, 5424, 5585, 5410, 5587, 5425, 5368, 5449, 5704, 5645, 5642, 5325, 5262 (7 hits) (03/26/2012 05:08:48 PM)
15	9	1.0	333.0	Yes	5559.2MHz, -62.0dBm	Hop sequence: 5333, 5674, 5377, 5479, 5439, 5539, 5590, 5548, 5704, 5637, 5678, 5394, 5300, 5722, 5713, 5265, 5694, 5440, 5520, 5686, 5263, 5384, 5386, 5283, 5550, 5659, 5491, 5570, 5641, 5332, 5319, 5252, 5338, 5376, 5472, 5647, 5673, 5649, 5646, 5459, 5528, 5716, 5281, 5294, 5667, 5267, 5639, 5433, 5288, 5382, 5291, 5571, 5304, 5436, 5250, 5488, 5632, 5654, 5513, 5460, 5328, 5552, 5307, 5356, 5721, 5625, 5330, 5500, 5293, 5429, 5340, 5420, 5476, 5253, 5451, 5289, 5434, 5438, 5354, 5349, 5407, 5369, 5331, 5652, 5533, 5324, 5254, 5669, 5650, 5450, 5597, 5347, 5653, 5541, 5489, 5583, 5687, 5493, 5664, 5621 (5 hits) (03/26/2012



Table 159 - FCC frequency hopping radar (Type 6) Results WU Steady State						
Trial #	Pulses/ Burst	Pulse Width (us)	PRI (us)	Detected	Fr (MHz) and level (dBm)	Burst Information
						05:08:54 PM)
16	9	1.0	333.0	Yes	5560.2MHz, -62.0dBm	Hop sequence: 5321, 5383, 5334, 5558, 5457, 5644, 5636, 5396, 5577, 5701, 5298, 5310, 5526, 5488, 5366, 5348, 5586, 5679, 5265, 5556, 5296, 5320, 5414, 5337, 5637, 5356, 5538, 5602, 5718, 5570, 5719, 5516, 5378, 5278, 5371, 5664, 5709, 5284, 5441, 5606, 5403, 5424, 5537, 5434, 5694, 5601, 5592, 5367, 5686, 5471, 5264, 5342, 5522, 5350, 5546, 5363, 5289, 5390, 5511, 5506, 5269, 5389, 5364, 5595, 5456, 5482, 5319, 5477, 5322, 5439, 5328, 5649, 5446, 5687, 5716, 5361, 5685, 5448, 5400, 5476, 5415, 5617, 5362, 5695, 5286, 5299, 5355, 5345, 5470, 5455, 5387, 5329, 5632, 5672, 5479, 5634, 5437, 5677, 5583, 5660 (4 hits) (03/26/2012 05:09:02 PM)
17	9	1.0	333.0	Yes	5561.2MHz, -62.0dBm	Hop sequence: 5715, 5719, 5606, 5376, 5319, 5629, 5344, 5675, 5283, 5412, 5667, 5580, 5708, 5651, 5674, 5586, 5660, 5568, 5350, 5543, 5254, 5623, 5385, 5375, 5659, 5492, 5270, 5626, 5396, 5359, 5695, 5621, 5405, 5640, 5308, 5546, 5564, 5488, 5302, 5573, 5720, 5282, 5572, 5327, 5684, 5574, 5369, 5633, 5584, 5264, 5361, 5401, 5587, 5263, 5288, 5650, 5700, 5321, 5468, 5388, 5536, 5372, 5267, 5251, 5290, 5480, 5566, 5441, 5686, 5400, 5547, 5699, 5298, 5291, 5455, 5387, 5679, 5687, 5697, 5570, 5425, 5560, 5262, 5714, 5635, 5276, 5250, 5269, 5508, 5703, 5604, 5348, 5605, 5460, 5627, 5462, 5421, 5373, 5271, 5669 (9 hits) (03/26/2012 05:09:09 PM)
18	9	1.0	333.0	Yes	5562.2MHz, -62.0dBm	Hop sequence: 5638, 5276, 5482, 5273, 5389, 5262, 5694, 5457, 5259, 5585, 5544, 5261, 5255, 5566, 5518, 5602, 5266, 5412, 5386, 5569, 5667, 5464, 5509, 5523, 5628, 5428, 5470, 5515, 5497, 5318, 5253, 5612, 5336, 5487, 5359, 5716, 5410, 5450, 5387, 5623, 5414, 5339, 5502, 5307, 5280, 5381, 5580, 5599,

Table 159 - FCC frequency hopping radar (Type 6) Results WU Steady State						
Trial #	Pulses/ Burst	Pulse Width (us)	PRI (us)	Detected	Fr (MHz) and level (dBm)	Burst Information
						5504, 5697, 5498, 5404, 5453, 5438, 5475, 5420, 5403, 5286, 5525, 5284, 5333, 5445, 5513, 5626, 5672, 5416, 5442, 5655, 5319, 5456, 5571, 5371, 5710, 5687, 5559, 5656, 5567, 5278, 5651, 5277, 5355, 5546, 5455, 5625, 5368, 5584, 5390, 5535, 5680, 5490, 5613, 5653, 5657, 5454, 5374, 5591, 5577, 5685, 5465, 5526 (7 hits) (03/26/2012 05:09:15 PM)
19	9	1.0	333.0	Yes	5563.2MHz, -62.0dBm	Hop sequence: 5472, 5289, 5674, 5510, 5455, 5470, 5514, 5647, 5474, 5422, 5713, 5384, 5664, 5323, 5488, 5679, 5485, 5329, 5718, 5404, 5447, 5644, 5670, 5603, 5477, 5552, 5425, 5502, 5432, 5565, 5672, 5523, 5581, 5465, 5439, 5307, 5705, 5695, 5507, 5614, 5530, 5700, 5710, 5645, 5580, 5571, 5354, 5298, 5444, 5491, 5308, 5702, 5557, 5493, 5554, 5656, 5362, 5302, 5431, 5676, 5511, 5704, 5579, 5681, 5287, 5367, 5615, 5373, 5428, 5276, 5372, 5393, 5414, 5456, 5476, 5541, 5512, 5468, 5258, 5342, 5715, 5498, 5724, 5542, 5368, 5381, 5352, 5293, 5396, 5508, 5712, 5719, 5335, 5297, 5281, 5632, 5380, 5634, 5721, 5451 (7 hits) (03/26/2012 05:09:22 PM)
20	9	1.0	333.0	Yes	5564.2MHz, -62.0dBm	Hop sequence: 5404, 5623, 5603, 5460, 5634, 5334, 5537, 5272, 5322, 5367, 5500, 5672, 5401, 5715, 5308, 5552, 5363, 5432, 5485, 5593, 5601, 5402, 5424, 5653, 5288, 5285, 5579, 5558, 5361, 5338, 5562, 5585, 5508, 5355, 5260, 5490, 5663, 5517, 5455, 5409, 5613, 5316, 5420, 5384, 5293, 5284, 5678, 5441, 5679, 5567, 5540, 5374, 5687, 5422, 5350, 5492, 5561, 5343, 5525, 5631, 5599, 5676, 5451, 5515, 5418, 5332, 5618, 5646, 5536, 5356, 5342, 5656, 5352, 5551, 5430, 5602, 5477, 5320, 5323, 5427, 5667, 5473, 5719, 5296, 5258, 5429, 5546, 5464, 5501, 5458, 5589, 5405, 5282, 5400, 5533, 5292, 5543, 5703, 5688, 5714 (7 hits) (03/26/2012

Table 159 - FCC frequency hopping radar (Type 6) Results WU Steady State						
Trial #	Pulses/ Burst	Pulse Width (us)	PRI (us)	Detected	Fr (MHz) and level (dBm)	Burst Information
						05:09:30 PM)
21	9	1.0	333.0	Yes	5565.2MHz, -62.0dBm	Hop sequence: 5273, 5633, 5404, 5583, 5659, 5304, 5405, 5454, 5484, 5686, 5427, 5612, 5271, 5294, 5290, 5712, 5362, 5646, 5618, 5279, 5479, 5693, 5697, 5266, 5695, 5653, 5321, 5386, 5377, 5453, 5310, 5617, 5675, 5285, 5352, 5417, 5434, 5509, 5627, 5506, 5365, 5724, 5662, 5442, 5512, 5465, 5647, 5356, 5673, 5581, 5716, 5634, 5296, 5704, 5351, 5624, 5275, 5538, 5638, 5674, 5690, 5415, 5497, 5720, 5473, 5403, 5584, 5252, 5307, 5267, 5502, 5320, 5397, 5360, 5343, 5355, 5539, 5332, 5531, 5529, 5272, 5575, 5295, 5482, 5337, 5263, 5475, 5387, 5448, 5547, 5445, 5463, 5672, 5631, 5648, 5602, 5691, 5393, 5703, 5329 (1 hits) (03/26/2012 05:09:42 PM)
22	9	1.0	333.0	Yes	5566.2MHz, -62.0dBm	Hop sequence: 5617, 5318, 5580, 5305, 5711, 5270, 5316, 5356, 5566, 5521, 5662, 5651, 5607, 5401, 5567, 5488, 5500, 5610, 5699, 5552, 5495, 5263, 5421, 5372, 5682, 5703, 5461, 5282, 5326, 5438, 5656, 5332, 5633, 5571, 5664, 5721, 5601, 5327, 5578, 5517, 5524, 5684, 5435, 5643, 5328, 5414, 5510, 5433, 5343, 5698, 5284, 5620, 5452, 5700, 5361, 5713, 5546, 5657, 5519, 5635, 5630, 5265, 5697, 5359, 5315, 5453, 5425, 5716, 5648, 5289, 5481, 5341, 5301, 5693, 5530, 5449, 5441, 5387, 5471, 5408, 5314, 5292, 5373, 5679, 5600, 5680, 5504, 5523, 5650, 5706, 5426, 5525, 5598, 5532, 5405, 5342, 5526, 5507, 5325, 5450 (6 hits) (03/26/2012 05:10:02 PM)
23	9	1.0	333.0	Yes	5567.2MHz, -62.0dBm	Hop sequence: 5473, 5515, 5499, 5714, 5708, 5291, 5505, 5354, 5401, 5416, 5687, 5272, 5575, 5677, 5278, 5652, 5507, 5707, 5319, 5598, 5494, 5519, 5658, 5569, 5448, 5609, 5343, 5691, 5578, 5662, 5514, 5556, 5267, 5495, 5504, 5414, 5538, 5257, 5554, 5275, 5486, 5311, 5297, 5260, 5277, 5606, 5387, 5489,

Table 159 - FCC frequency hopping radar (Type 6) Results WU Steady State						
Trial #	Pulses/ Burst	Pulse Width (us)	PRI (us)	Detected	Fr (MHz) and level (dBm)	Burst Information
						5322, 5465, 5317, 5624, 5698, 5625, 5383, 5680, 5595, 5671, 5400, 5549, 5480, 5577, 5433, 5299, 5339, 5424, 5588, 5566, 5717, 5591, 5423, 5684, 5484, 5640, 5517, 5492, 5415, 5656, 5446, 5266, 5392, 5560, 5616, 5444, 5287, 5366, 5309, 5678, 5663, 5491, 5666, 5396, 5340, 5427, 5570, 5706, 5710, 5528, 5336, 5329 (10 hits) (03/26/2012 05:10:09 PM)
24	9	1.0	333.0	Yes	5568.2MHz, -62.0dBm	Hop sequence: 5293, 5479, 5709, 5557, 5671, 5311, 5721, 5362, 5280, 5569, 5387, 5544, 5602, 5256, 5281, 5374, 5325, 5582, 5477, 5462, 5698, 5691, 5720, 5444, 5526, 5361, 5562, 5593, 5611, 5426, 5307, 5400, 5365, 5472, 5513, 5308, 5259, 5635, 5616, 5559, 5493, 5657, 5415, 5630, 5481, 5458, 5620, 5434, 5661, 5649, 5454, 5516, 5321, 5586, 5708, 5532, 5367, 5583, 5442, 5700, 5490, 5409, 5320, 5274, 5685, 5568, 5346, 5288, 5333, 5651, 5552, 5629, 5473, 5501, 5354, 5404, 5271, 5482, 5405, 5301, 5579, 5377, 5670, 5260, 5673, 5461, 5358, 5645, 5332, 5699, 5456, 5542, 5614, 5431, 5716, 5398, 5351, 5322, 5655, 5617 (7 hits) (03/26/2012 05:10:16 PM)
25	9	1.0	333.0	Yes	5569.2MHz, -62.0dBm	Hop sequence: 5564, 5588, 5473, 5690, 5255, 5594, 5396, 5308, 5576, 5700, 5635, 5297, 5509, 5644, 5271, 5474, 5486, 5273, 5667, 5522, 5664, 5571, 5691, 5372, 5358, 5277, 5617, 5464, 5352, 5320, 5354, 5562, 5600, 5593, 5394, 5417, 5261, 5515, 5582, 5435, 5259, 5482, 5423, 5584, 5424, 5366, 5640, 5692, 5446, 5254, 5527, 5722, 5380, 5365, 5457, 5684, 5403, 5265, 5686, 5444, 5496, 5281, 5633, 5410, 5431, 5682, 5300, 5658, 5327, 5569, 5524, 5369, 5441, 5555, 5580, 5578, 5447, 5706, 5425, 5385, 5418, 5321, 5665, 5257, 5595, 5606, 5325, 5615, 5519, 5574, 5642, 5619, 5625, 5716, 5400, 5305, 5445, 5393, 5620, 5477 (9 hits) (03/26/2012

Table 159 - FCC frequency hopping radar (Type 6) Results WU Steady State						
Trial #	Pulses/ Burst	Pulse Width (us)	PRI (us)	Detected	Fr (MHz) and level (dBm)	Burst Information
						05:10:22 PM)
26	9	1.0	333.0	Yes	5570.2MHz, -62.0dBm	Hop sequence: 5329, 5613, 5391, 5346, 5290, 5521, 5632, 5251, 5537, 5648, 5464, 5357, 5622, 5569, 5557, 5540, 5404, 5413, 5711, 5369, 5480, 5695, 5545, 5441, 5505, 5406, 5276, 5716, 5694, 5598, 5652, 5294, 5380, 5461, 5258, 5278, 5436, 5288, 5559, 5725, 5423, 5530, 5710, 5365, 5595, 5306, 5625, 5589, 5607, 5677, 5548, 5284, 5440, 5378, 5273, 5629, 5623, 5331, 5714, 5340, 5450, 5581, 5455, 5689, 5676, 5374, 5561, 5264, 5498, 5565, 5415, 5321, 5520, 5536, 5563, 5361, 5721, 5627, 5319, 5604, 5252, 5328, 5538, 5439, 5390, 5596, 5616, 5517, 5303, 5367, 5292, 5509, 5675, 5296, 5646, 5283, 5412, 5544, 5313, 5375 (7 hits) (03/26/2012 05:10:29 PM)
27	9	1.0	333.0	Yes	5571.2MHz, -62.0dBm	Hop sequence: 5630, 5717, 5423, 5428, 5440, 5661, 5676, 5421, 5639, 5266, 5562, 5582, 5445, 5627, 5494, 5392, 5626, 5326, 5619, 5288, 5600, 5455, 5673, 5338, 5715, 5675, 5701, 5565, 5632, 5683, 5274, 5665, 5579, 5498, 5400, 5646, 5371, 5411, 5512, 5365, 5442, 5607, 5595, 5652, 5581, 5496, 5704, 5650, 5705, 5560, 5449, 5278, 5714, 5287, 5352, 5470, 5580, 5608, 5713, 5694, 5693, 5419, 5403, 5469, 5374, 5302, 5669, 5623, 5641, 5253, 5662, 5542, 5682, 5487, 5645, 5587, 5401, 5545, 5532, 5359, 5486, 5564, 5317, 5502, 5500, 5552, 5339, 5590, 5265, 5688, 5343, 5529, 5568, 5636, 5425, 5589, 5519, 5585, 5535, 5468 (8 hits) (03/26/2012 05:10:37 PM)
28	9	1.0	333.0	Yes	5572.2MHz, -62.0dBm	Hop sequence: 5365, 5285, 5472, 5410, 5659, 5427, 5563, 5353, 5425, 5633, 5603, 5447, 5408, 5486, 5298, 5541, 5364, 5580, 5592, 5520, 5456, 5665, 5373, 5368, 5381, 5662, 5594, 5678, 5648, 5328, 5303, 5325, 5613, 5610, 5370, 5693, 5465, 5317, 5696, 5635, 5725, 5690, 5265, 5335, 5697, 5638, 5595, 5272,

Table 159 - FCC frequency hopping radar (Type 6) Results WU Steady State						
Trial #	Pulses/ Burst	Pulse Width (us)	PRI (us)	Detected	Fr (MHz) and level (dBm)	Burst Information
						5537, 5585, 5420, 5300, 5279, 5442, 5593, 5691, 5709, 5720, 5326, 5401, 5395, 5414, 5706, 5587, 5573, 5598, 5607, 5526, 5363, 5647, 5407, 5611, 5371, 5343, 5658, 5640, 5358, 5704, 5629, 5375, 5500, 5443, 5329, 5291, 5652, 5478, 5281, 5481, 5306, 5518, 5631, 5621, 5550, 5632, 5600, 5590, 5719, 5575, 5533, 5400 (5 hits) (03/26/2012 05:10:45 PM)
29	9	1.0	333.0	Yes	5573.2MHz, -62.0dBm	Hop sequence: 5251, 5707, 5695, 5691, 5371, 5568, 5644, 5391, 5563, 5374, 5501, 5384, 5439, 5460, 5276, 5500, 5669, 5454, 5486, 5495, 5423, 5390, 5431, 5339, 5548, 5633, 5458, 5331, 5420, 5466, 5354, 5326, 5625, 5718, 5576, 5538, 5343, 5498, 5287, 5543, 5378, 5311, 5306, 5604, 5428, 5356, 5524, 5406, 5594, 5615, 5639, 5519, 5303, 5690, 5652, 5702, 5705, 5597, 5719, 5323, 5648, 5292, 5424, 5575, 5441, 5467, 5388, 5264, 5704, 5598, 5389, 5462, 5582, 5259, 5302, 5258, 5425, 5593, 5448, 5643, 5506, 5699, 5520, 5381, 5434, 5349, 5436, 5290, 5701, 5304, 5482, 5723, 5681, 5536, 5512, 5684, 5377, 5422, 5517, 5359 (5 hits) (03/26/2012 05:10:52 PM)
30	9	1.0	333.0	Yes	5574.2MHz, -62.0dBm	Hop sequence: 5643, 5532, 5457, 5299, 5276, 5688, 5259, 5428, 5328, 5522, 5716, 5558, 5534, 5569, 5430, 5673, 5357, 5494, 5441, 5252, 5327, 5690, 5519, 5676, 5712, 5443, 5707, 5697, 5585, 5398, 5648, 5416, 5625, 5342, 5381, 5622, 5647, 5273, 5425, 5635, 5491, 5255, 5634, 5474, 5593, 5414, 5464, 5563, 5313, 5354, 5630, 5660, 5320, 5574, 5544, 5609, 5579, 5628, 5291, 5424, 5539, 5602, 5462, 5271, 5397, 5493, 5272, 5594, 5309, 5303, 5557, 5674, 5372, 5454, 5715, 5326, 5702, 5535, 5413, 5556, 5509, 5489, 5559, 5604, 5685, 5523, 5565, 5506, 5550, 5580, 5277, 5566, 5289, 5499, 5711, 5302, 5448, 5404, 5360, 5371 (12 hits) (03/26/2012

Table 159 - FCC frequency hopping radar (Type 6) Results WU Steady State						
Trial #	Pulses/ Burst	Pulse Width (us)	PRI (us)	Detected	Fr (MHz) and level (dBm)	Burst Information
						05:11:01 PM)
31	9	1.0	333.0	Yes	5575.2MHz, -62.0dBm	Hop sequence: 5509, 5524, 5666, 5394, 5653, 5683, 5559, 5419, 5440, 5612, 5345, 5619, 5662, 5678, 5538, 5716, 5346, 5555, 5380, 5676, 5513, 5494, 5327, 5552, 5710, 5330, 5302, 5665, 5629, 5519, 5566, 5725, 5425, 5409, 5557, 5694, 5322, 5592, 5447, 5548, 5282, 5504, 5472, 5623, 5483, 5261, 5320, 5704, 5258, 5374, 5342, 5611, 5508, 5517, 5588, 5660, 5531, 5574, 5719, 5642, 5432, 5456, 5429, 5318, 5275, 5331, 5252, 5355, 5468, 5706, 5597, 5337, 5306, 5542, 5635, 5646, 5393, 5570, 5532, 5686, 5705, 5307, 5604, 5528, 5607, 5606, 5329, 5593, 5551, 5407, 5465, 5406, 5655, 5721, 5268, 5618, 5300, 5437, 5452, 5682 (9 hits) (03/26/2012 05:11:14 PM)
32	9	1.0	333.0	Yes	5576.2MHz, -62.0dBm	Hop sequence: 5512, 5601, 5455, 5349, 5322, 5567, 5398, 5419, 5496, 5305, 5408, 5261, 5523, 5423, 5260, 5264, 5363, 5612, 5554, 5321, 5602, 5295, 5373, 5399, 5346, 5278, 5649, 5426, 5692, 5265, 5281, 5696, 5532, 5453, 5551, 5500, 5396, 5546, 5374, 5583, 5576, 5291, 5314, 5628, 5313, 5277, 5555, 5357, 5483, 5355, 5463, 5340, 5614, 5488, 5255, 5718, 5324, 5486, 5262, 5303, 5565, 5467, 5320, 5717, 5489, 5719, 5341, 5389, 5665, 5666, 5443, 5474, 5479, 5418, 5412, 5707, 5263, 5515, 5335, 5671, 5407, 5383, 5689, 5577, 5490, 5356, 5549, 5580, 5654, 5627, 5316, 5550, 5650, 5360, 5470, 5656, 5594, 5461, 5639, 5469 (10 hits) (03/26/2012 05:11:26 PM)
33	9	1.0	333.0	Yes	5577.2MHz, -62.0dBm	Hop sequence: 5439, 5655, 5443, 5440, 5491, 5482, 5413, 5652, 5572, 5424, 5611, 5351, 5666, 5450, 5487, 5294, 5432, 5372, 5677, 5716, 5564, 5451, 5665, 5682, 5485, 5663, 5344, 5303, 5339, 5254, 5718, 5270, 5473, 5576, 5618, 5604, 5347, 5533, 5600, 5592, 5557, 5290, 5421, 5360, 5683, 5401, 5695, 5406,

Table 159 - FCC frequency hopping radar (Type 6) Results WU Steady State						
Trial #	Pulses/ Burst	Pulse Width (us)	PRI (us)	Detected	Fr (MHz) and level (dBm)	Burst Information
						5588, 5513, 5342, 5323, 5711, 5501, 5373, 5476, 5599, 5315, 5349, 5660, 5584, 5422, 5621, 5609, 5418, 5458, 5467, 5697, 5348, 5319, 5282, 5262, 5299, 5399, 5403, 5529, 5301, 5540, 5536, 5305, 5610, 5435, 5423, 5343, 5417, 5657, 5496, 5494, 5530, 5553, 5486, 5656, 5375, 5693, 5408, 5474, 5355, 5637, 5551, 5437 (6 hits) (03/26/2012 05:11:36 PM)
34	9	1.0	333.0	Yes	5578.2MHz, -62.0dBm	Hop sequence: 5350, 5542, 5591, 5669, 5274, 5710, 5599, 5642, 5458, 5653, 5369, 5626, 5488, 5555, 5265, 5618, 5580, 5487, 5619, 5585, 5364, 5705, 5269, 5414, 5268, 5304, 5521, 5475, 5282, 5652, 5597, 5524, 5600, 5378, 5658, 5424, 5256, 5302, 5609, 5443, 5625, 5507, 5311, 5368, 5363, 5437, 5578, 5559, 5556, 5505, 5701, 5525, 5324, 5352, 5489, 5407, 5587, 5395, 5698, 5366, 5421, 5470, 5632, 5690, 5650, 5677, 5393, 5594, 5426, 5643, 5684, 5330, 5568, 5511, 5418, 5422, 5478, 5449, 5262, 5308, 5651, 5264, 5357, 5694, 5622, 5724, 5342, 5432, 5459, 5662, 5530, 5403, 5371, 5638, 5519, 5286, 5438, 5281, 5546, 5595 (6 hits) (03/26/2012 05:11:43 PM)



**Appendix C Test Data Tables and Plots for Channel Closing****FCC PART 15 SUBPART E Channel Closing Measurements**

<b>Table 160 FCC Part 15 Subpart E Channel Closing Test Results</b>					
Waveform Type	Channel Closing Transmission Time <sup>1</sup>		Channel Move Time		Result
	Measured	Limit	Measured	Limit	
Radar Type 1, Low Band, CU Steady State	-10 ms	60 ms	0 ms	10 s	Pass
Radar Type 5, Low Band, CU Steady State	0 ms	60 ms	-10.07 s	10 s	Pass
Radar Type 1, High Band, WU Steady State	0 ms	60 ms	155 ms	10 s	Pass
Radar Type 5, High Band, WU Steady State	0 ms	60 ms	-8.513 s	10 s	Pass
Radar Type 1, Low Band, WU, CU Acquire Mode	0 ms	60 ms	-15 ms	10 s	Pass
Radar Type 5, Low Band, WU, CU Acquire Mode	0 ms	60 ms	-6.48 s	10 s	Pass

After the final channel closing test the channel was monitored for a further 30 minutes. No transmissions occurred on the channel.

<sup>1</sup> Channel closing time for FCC measurements is the aggregate transmission time starting from 200ms after the end of the radar signal to the completion of the channel move.

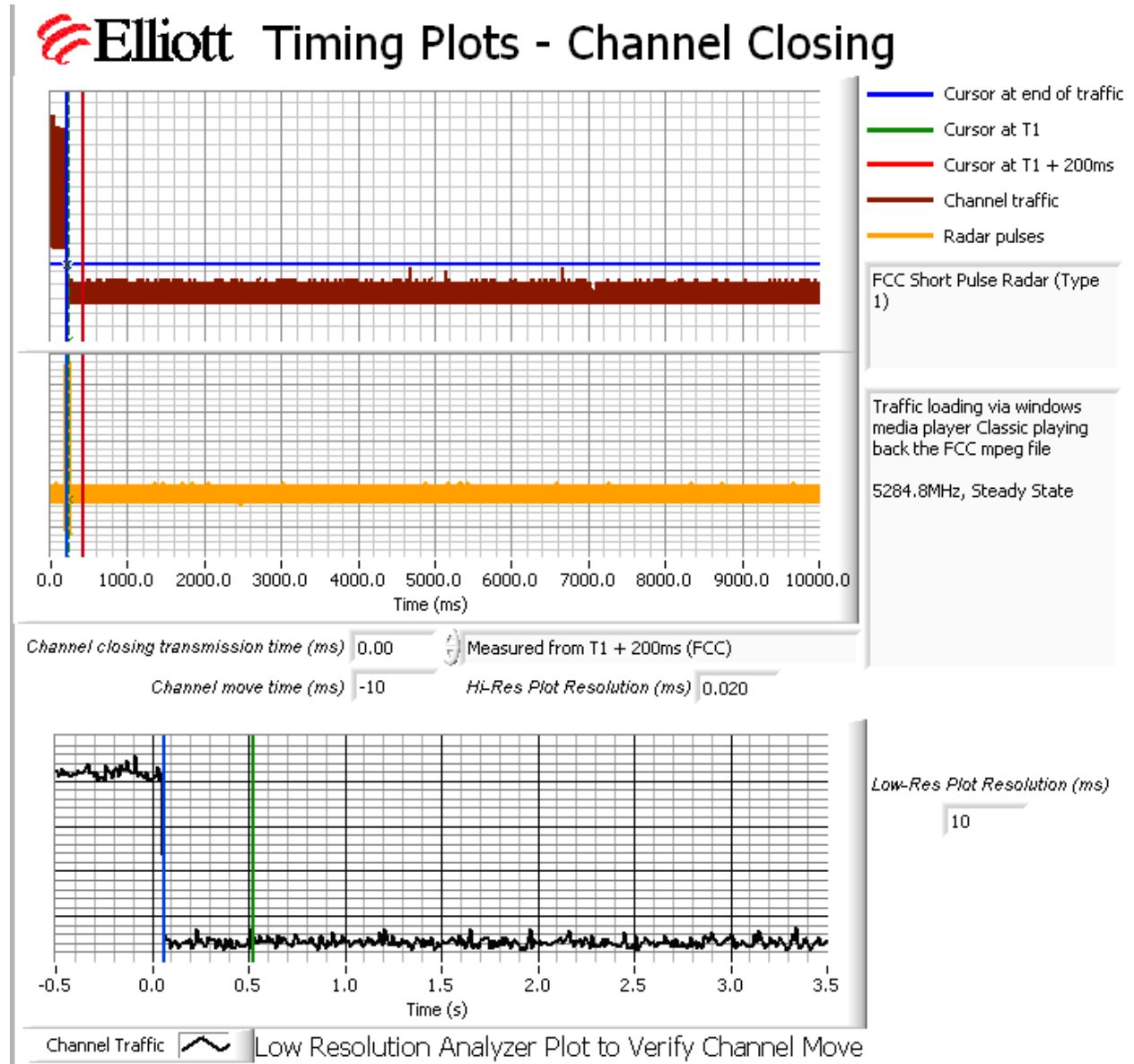

Figure 4 Channel Closing Time and Channel Move Time – 40 second plot, Low Band, CU Steady State

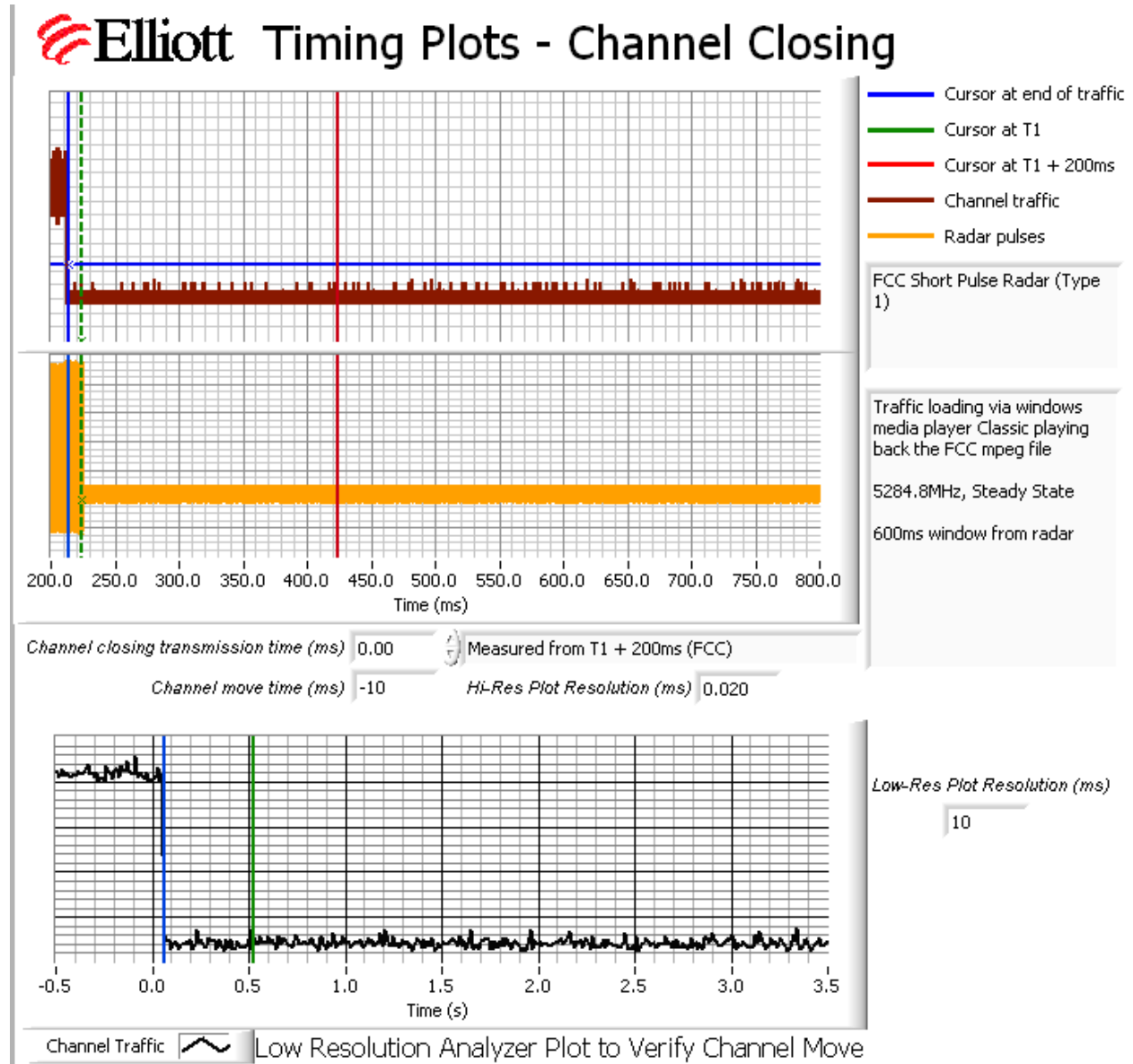

Figure 5 Close-Up of Transmissions Occurring More Than 200ms After The End of Radar, Low Band, CU Steady State

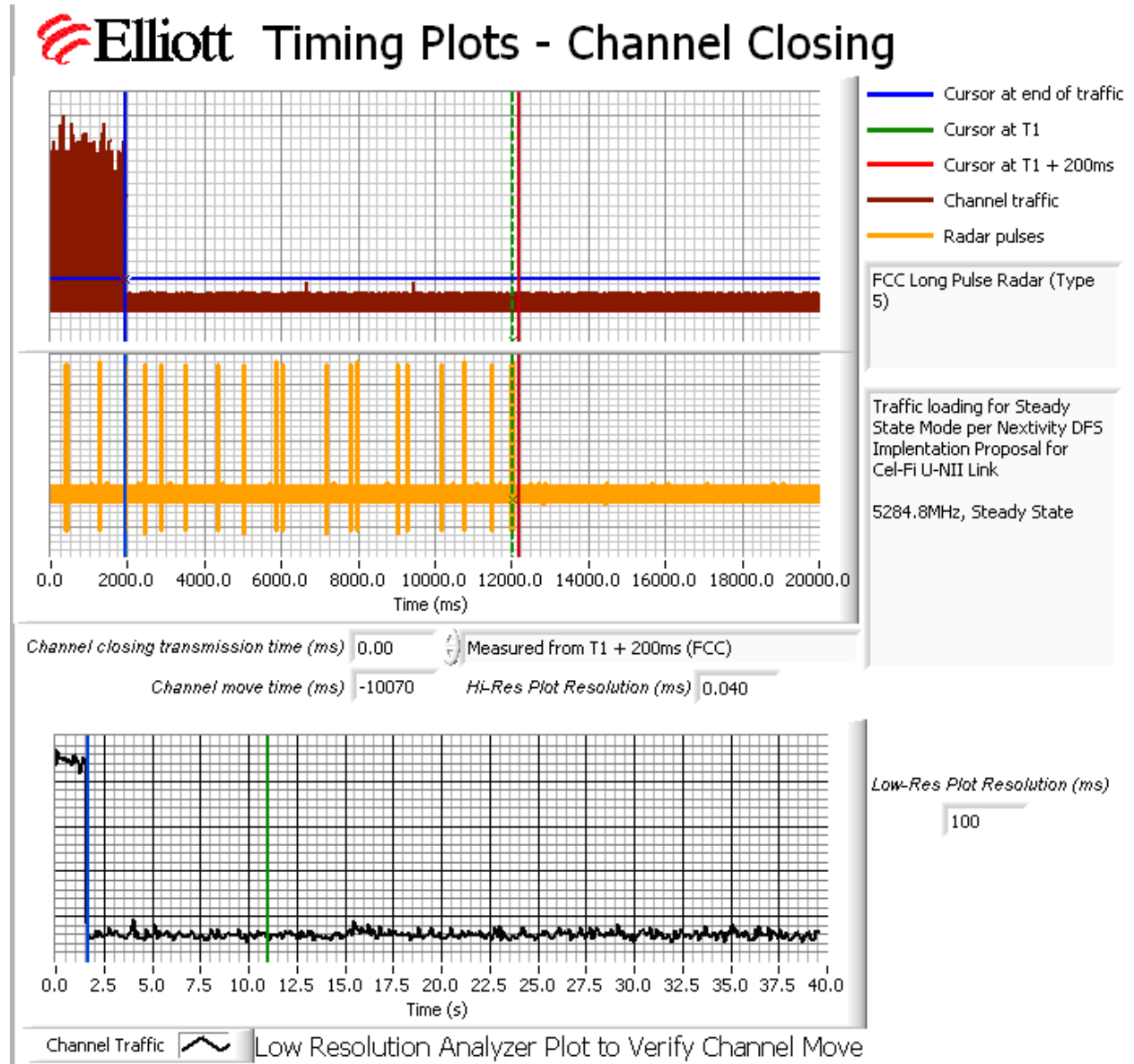
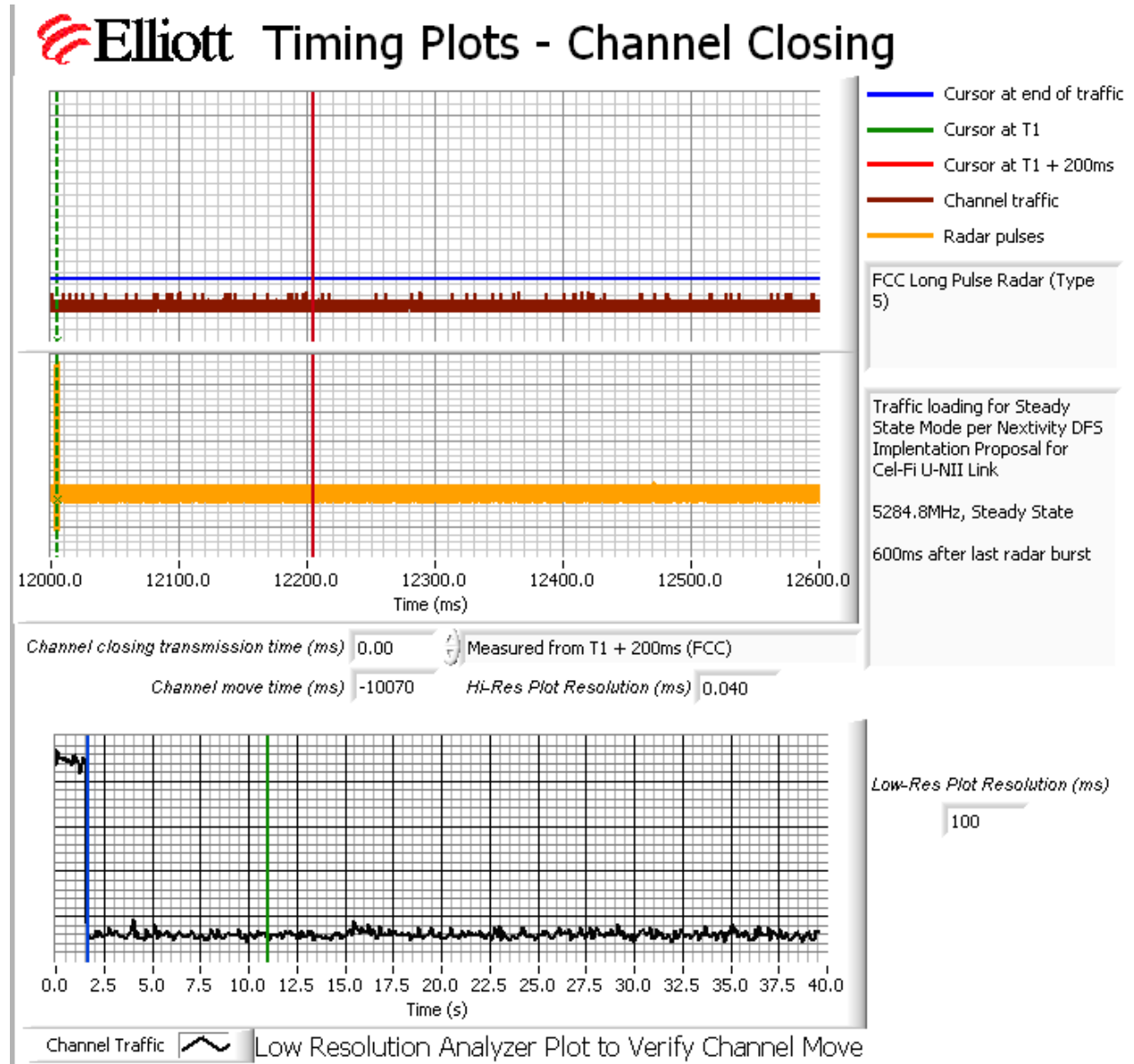

Figure 6 Channel Closing Time and Channel Move Time – 40 second plot, Low Band, CU Steady State



**Figure 7 Close-Up of Transmissions Occurring More Than 200ms After The End of Radar, Low Band, CU Steady State**

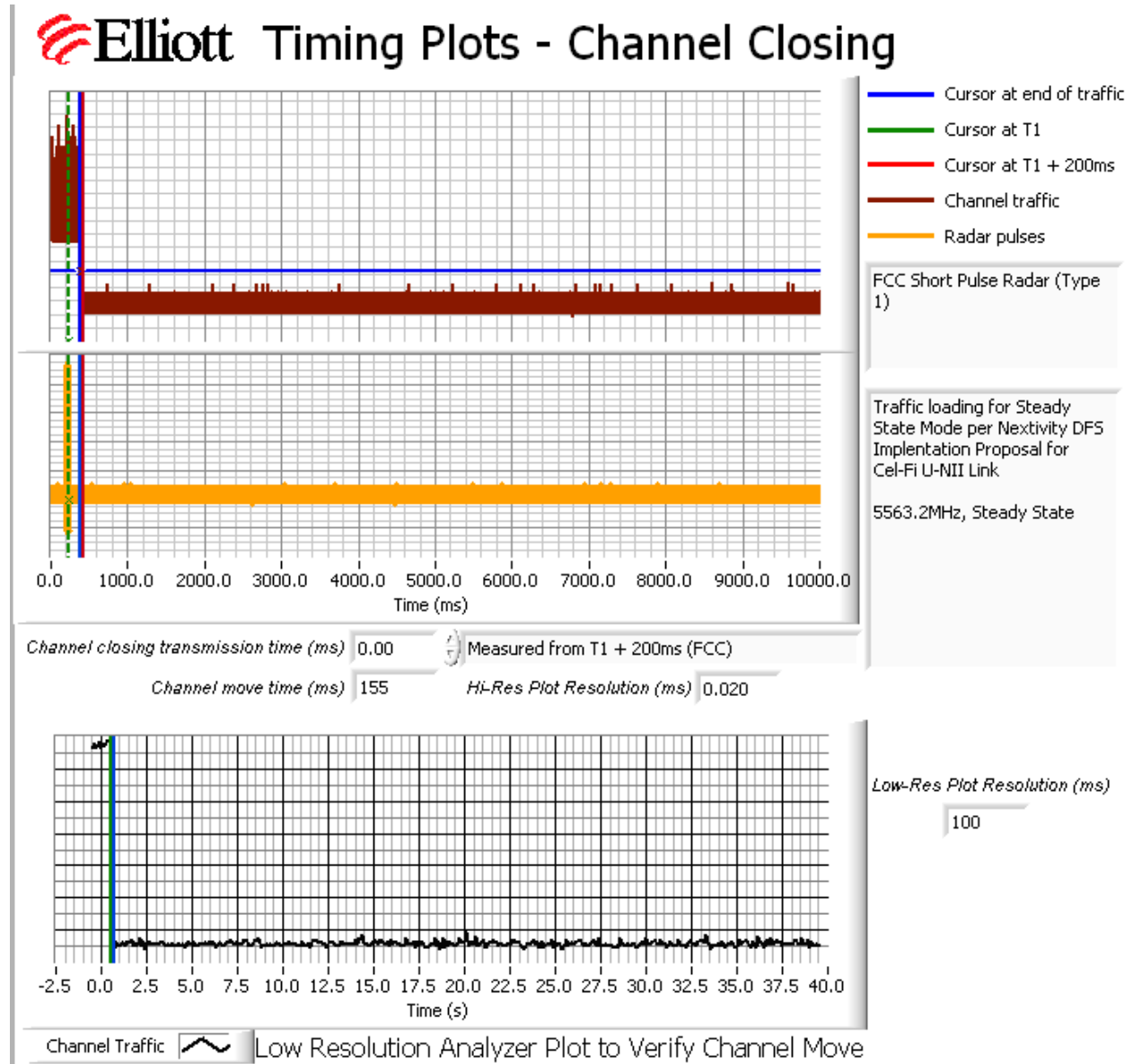

Figure 8 Channel Closing Time and Channel Move Time – 40 second plot, High Band, WU Steady State

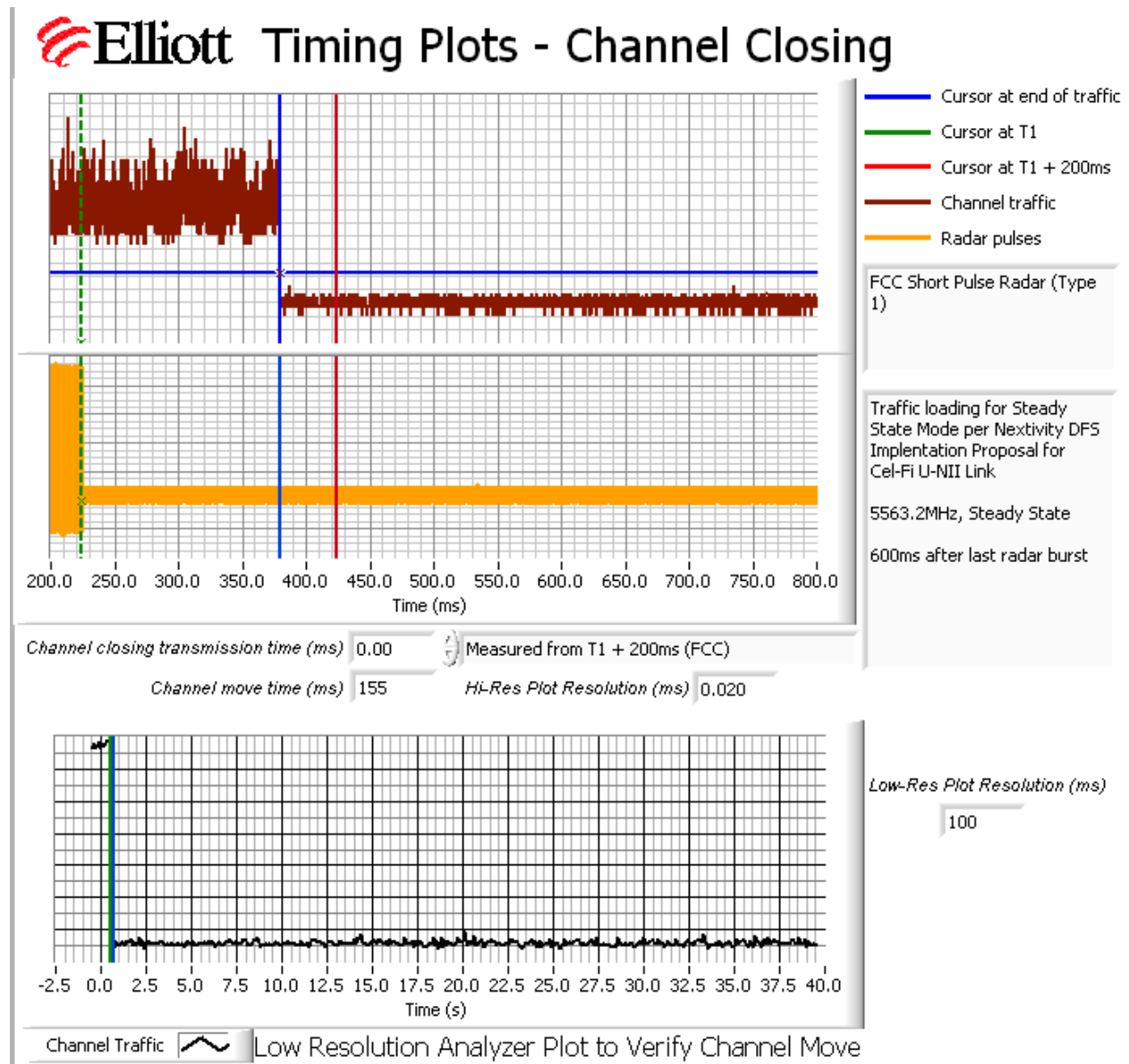

Figure 9 Close-Up of Transmissions Occurring More Than 200ms After The End of Radar, High Band, WU Steady State

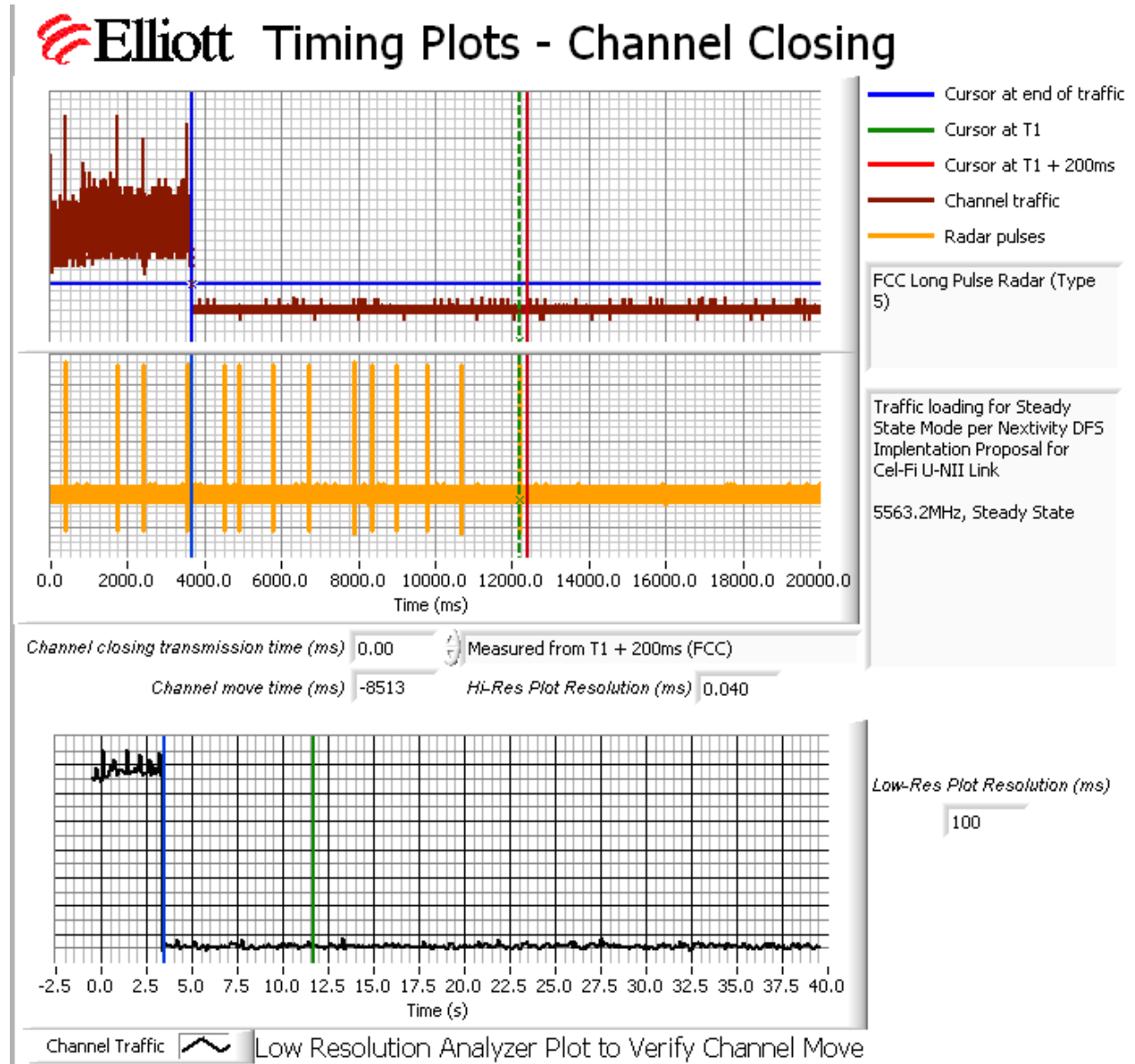

Figure 10 Channel Closing Time and Channel Move Time – 40 second plot, High Band, WU Steady State



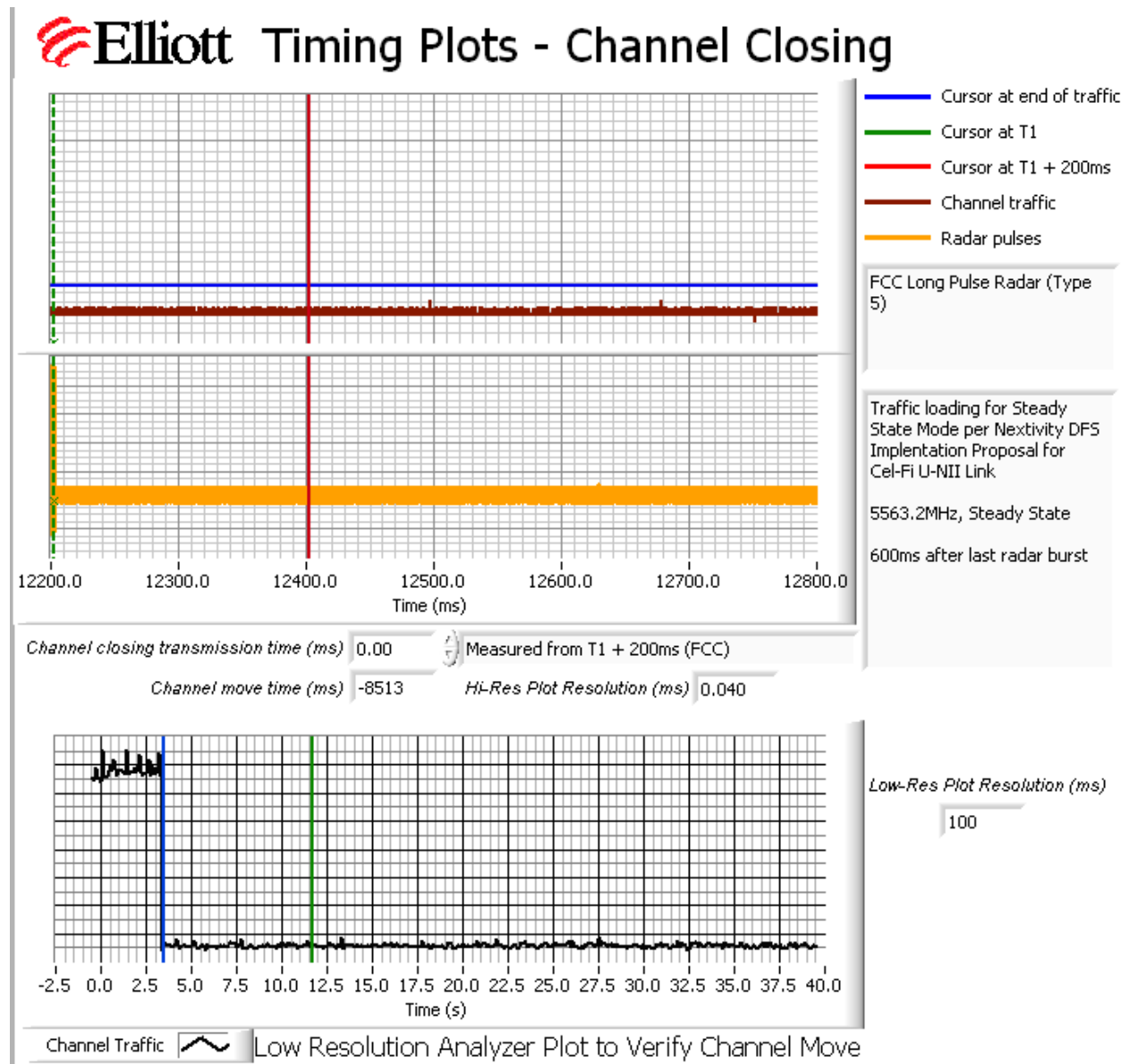

Figure 11 Close-Up of Transmissions Occurring More Than 200ms After The End of Radar, High Band, WU Steady State

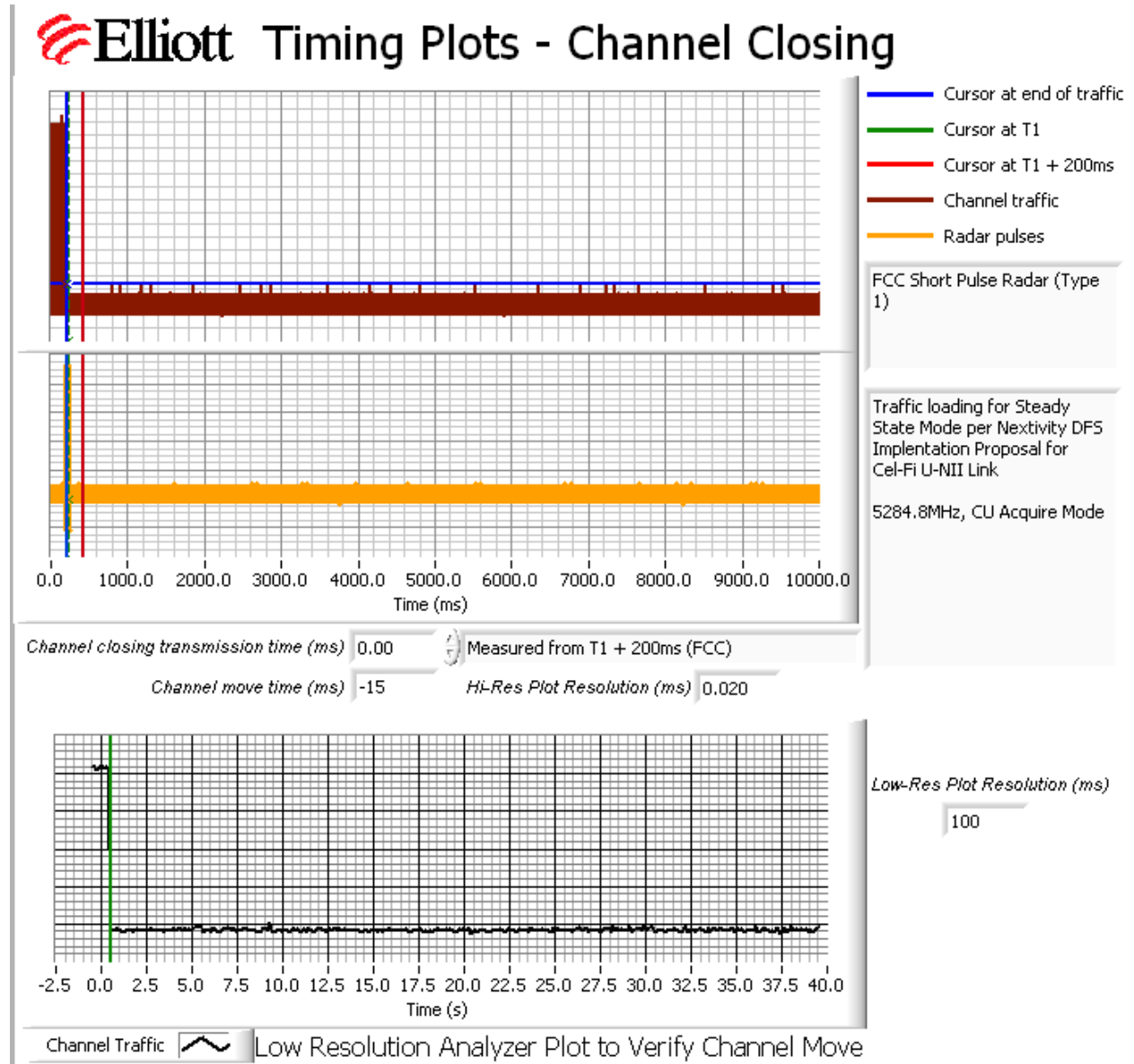

Figure 12 Channel Closing Time and Channel Move Time – 40 second plot, Low Band, WU, CU Acquire Mode

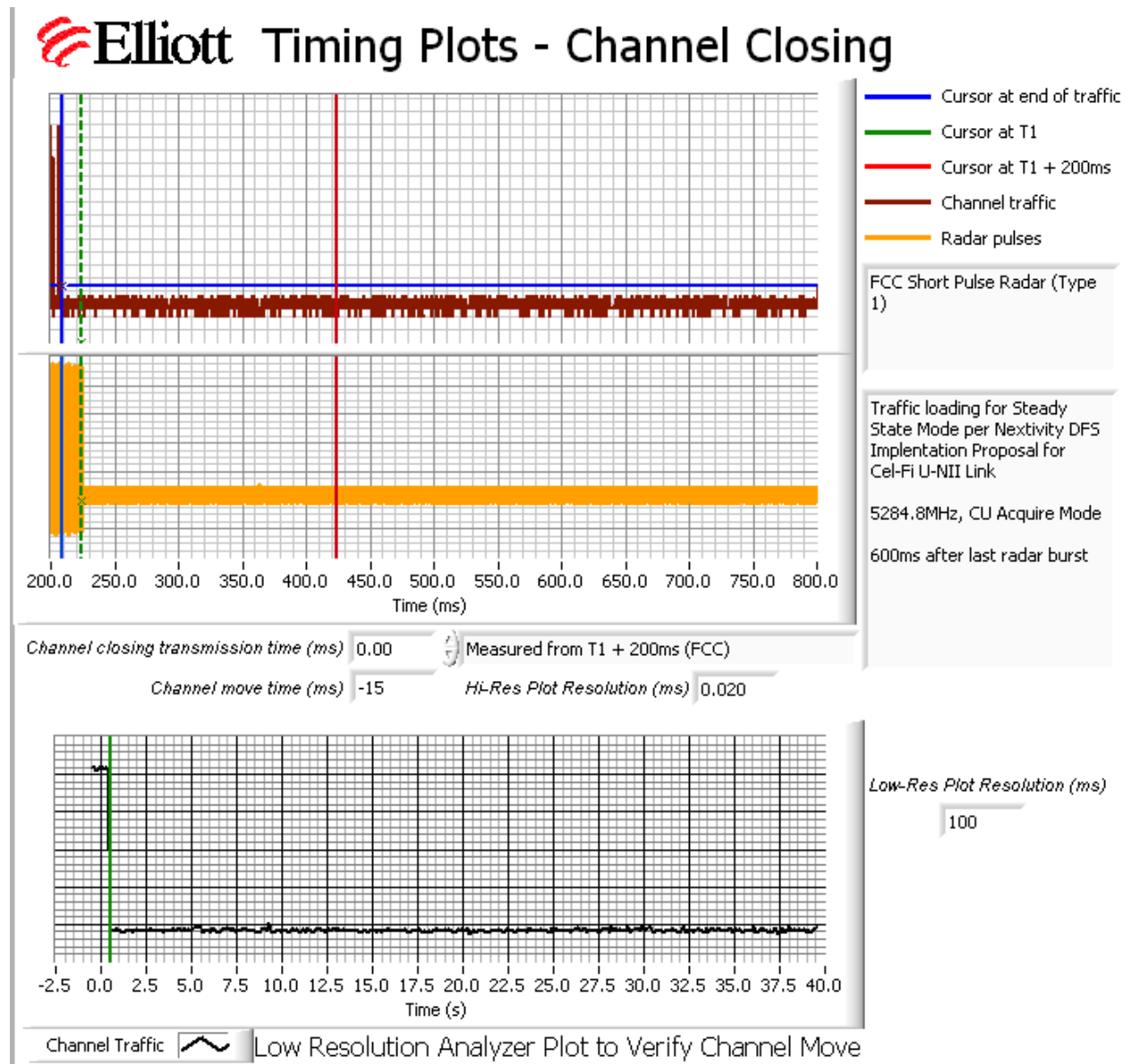

Figure 13 Close-Up of Transmissions Occurring More Than 200ms After The End of Radar, Low Band, WU, CU Acquire Mode

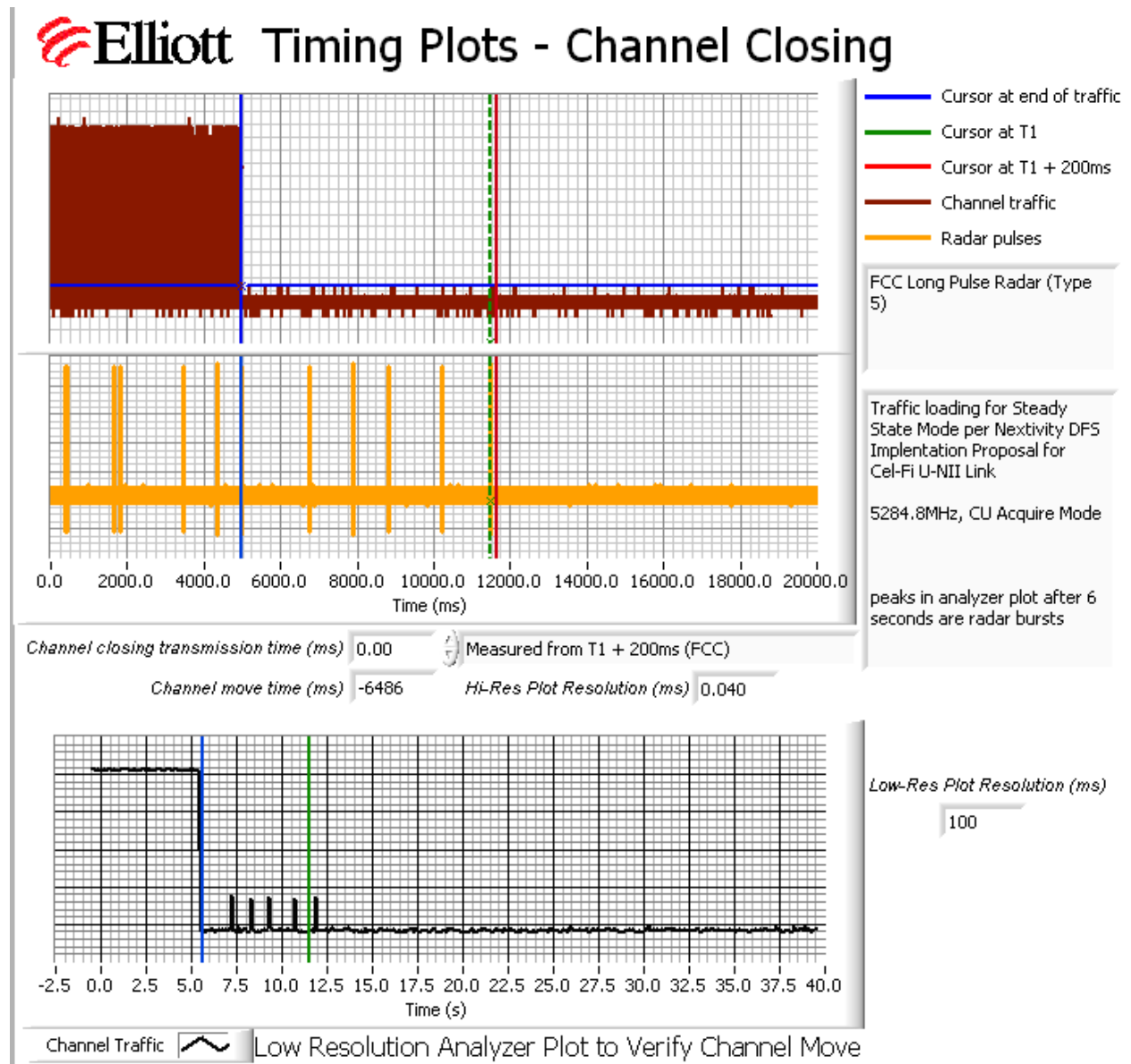

Figure 14 Channel Closing Time and Channel Move Time – 40 second plot, Low Band, WU, CU Acquire Mode

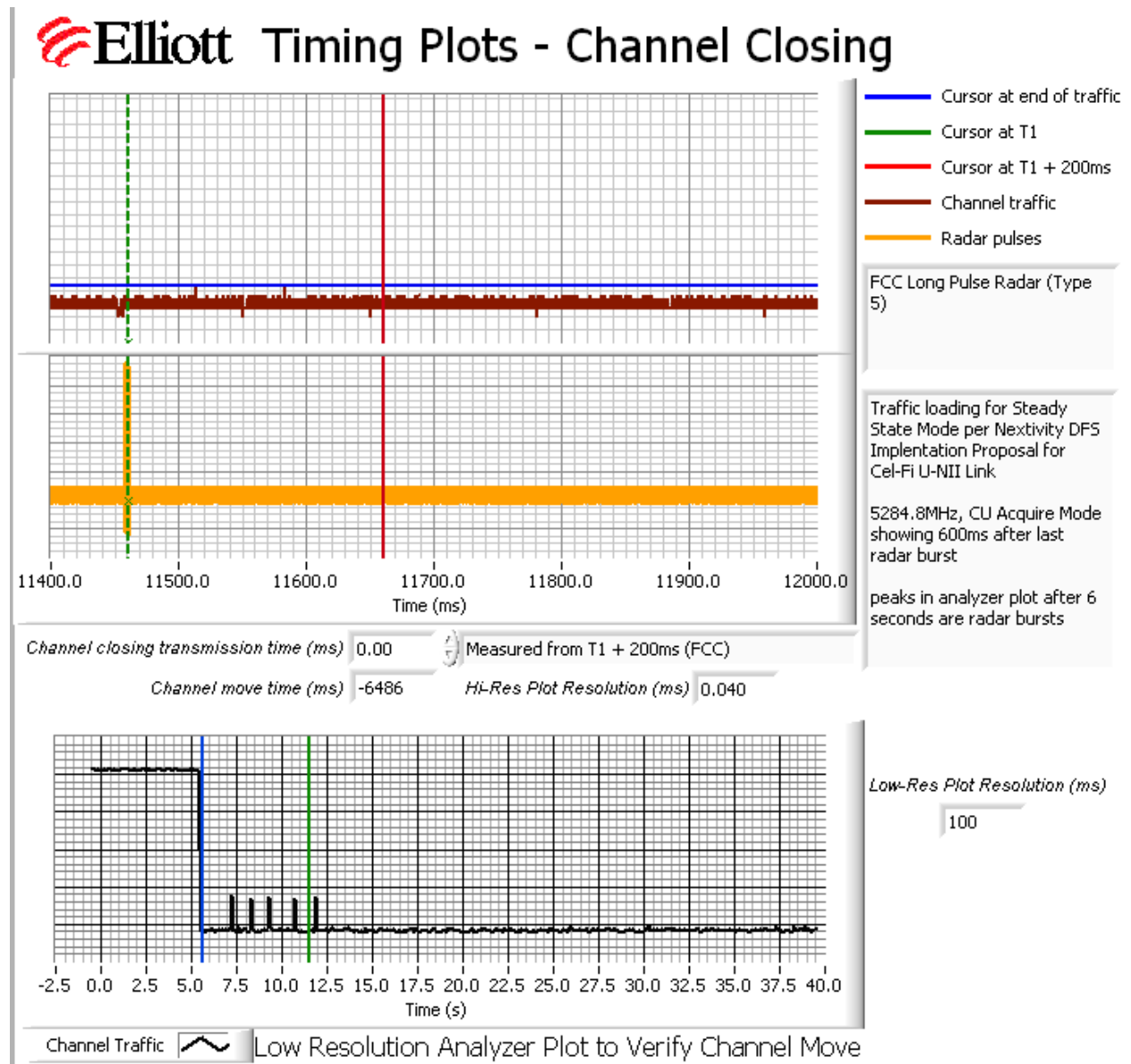

Figure 15 Close-Up of Transmissions Occurring More Than 200ms After The End of Radar, Low Band, WU, CU Acquire Mode

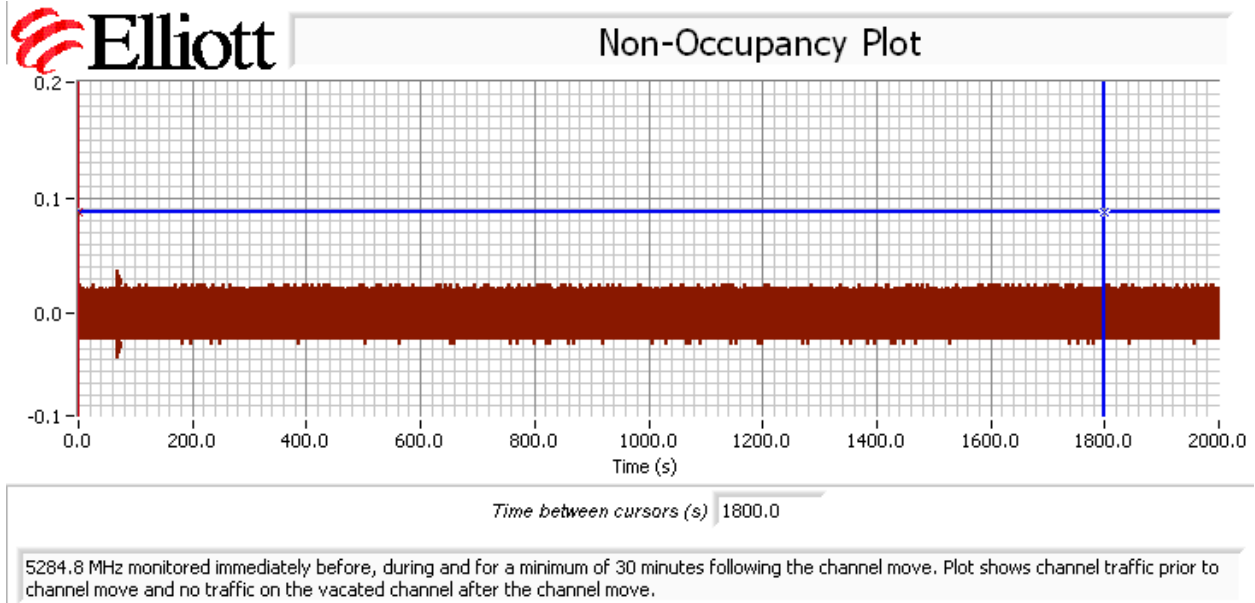

Figure 16 Radar Channel Non-Occupancy Plot, CU Low Band

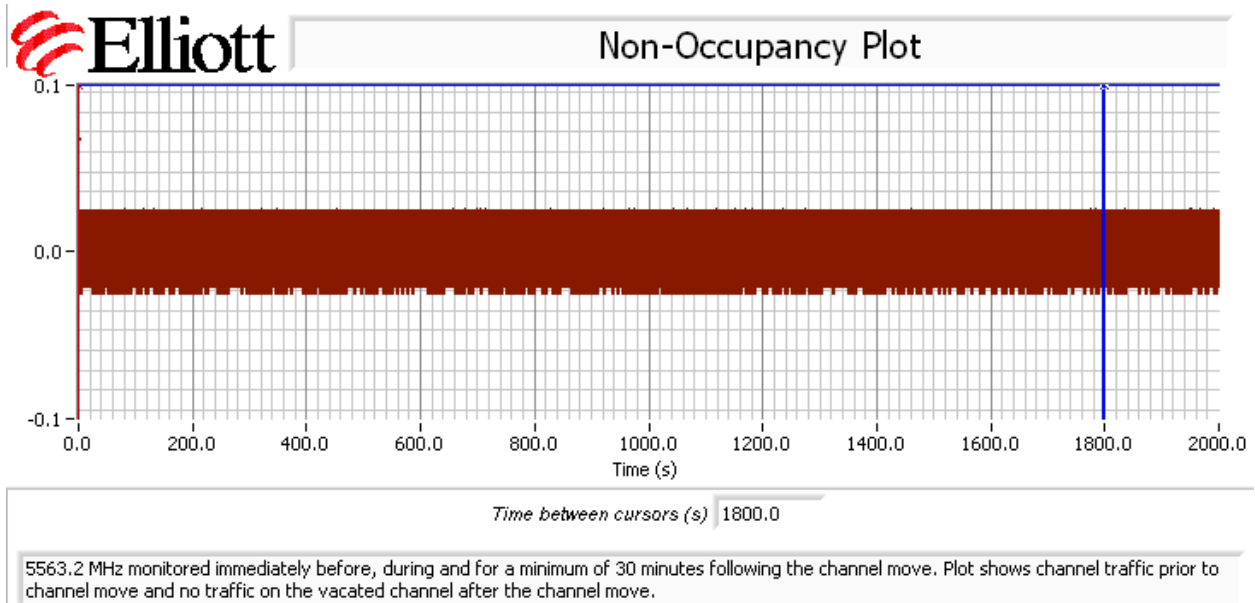

Figure 17 Radar Channel Non-Occupancy Plot, WU High Band

The non-occupancy plot was made over a 30-minute time period following the channel move time with the analyzer IF output connected to the scope and tuned to the vacated channel. No transmissions were observed after the channel move had been completed.

After the channel move the client re-associated with the master device on the new channel. After the channel move the client device stopped transmitting.

### Appendix D Test Data – Channel Availability Check

5250- 5350 MHz, 5470 – 5725 MHz

The first plot shows the first transmissions on a channel after restarting/power cycling the master device, with no radar applied during the CAC. The start of CAC is assumed to be 60 seconds before the first transmission as indicated by the green cursor line.



## Timing Plots - Channel Availability Check

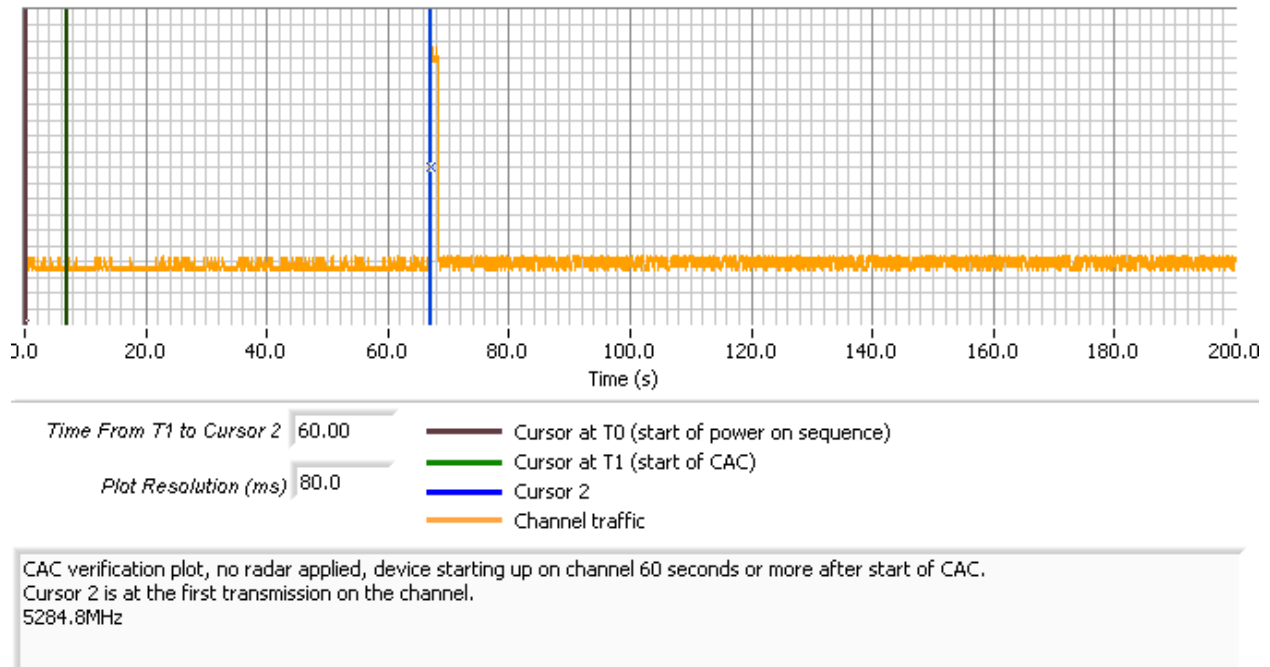
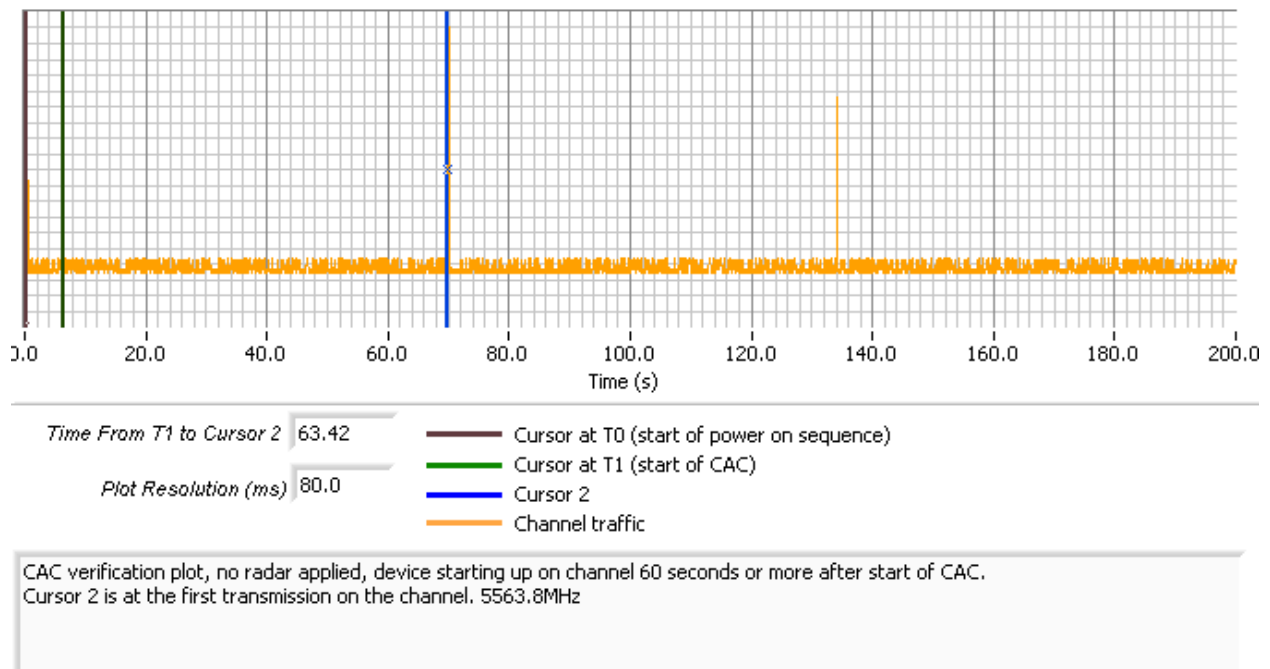

Figure 18 Plot of EUT Start-Up after CAC, WU Low Band



## Timing Plots - Channel Availability Check



**Figure 19 Plot of EUT Start-Up After CAC, WU High Band**

The channel availability check (CAC) was made by applying type 1 radar during either the first 6 seconds or last 6 seconds of the CAC period.

The level of the radar signal applied was -62dBm. Measurements were made on channel 64 (5284.8 MHz) and also on channel 120 (5563.2 MHz).

The start time is the same for each of the plots and the green cursor is positioned to coincide with the start of the Channel Availability Check period based on the plot taken with no radar applied during the CAC.

The plots show that there were no transmissions on the channel after the radar burst was applied during the CAC, and confirm that the CAC is at least 60 seconds. The description of "Channel Traffic" in the plot legend indicates the transmissions from both the radar system and the EUT on the start-up channel. In all cases only the radar burst is observed. The resolution of the plot is not fine enough to resolve the individual pulses within the burst.





## Timing Plots - Channel Availability Check

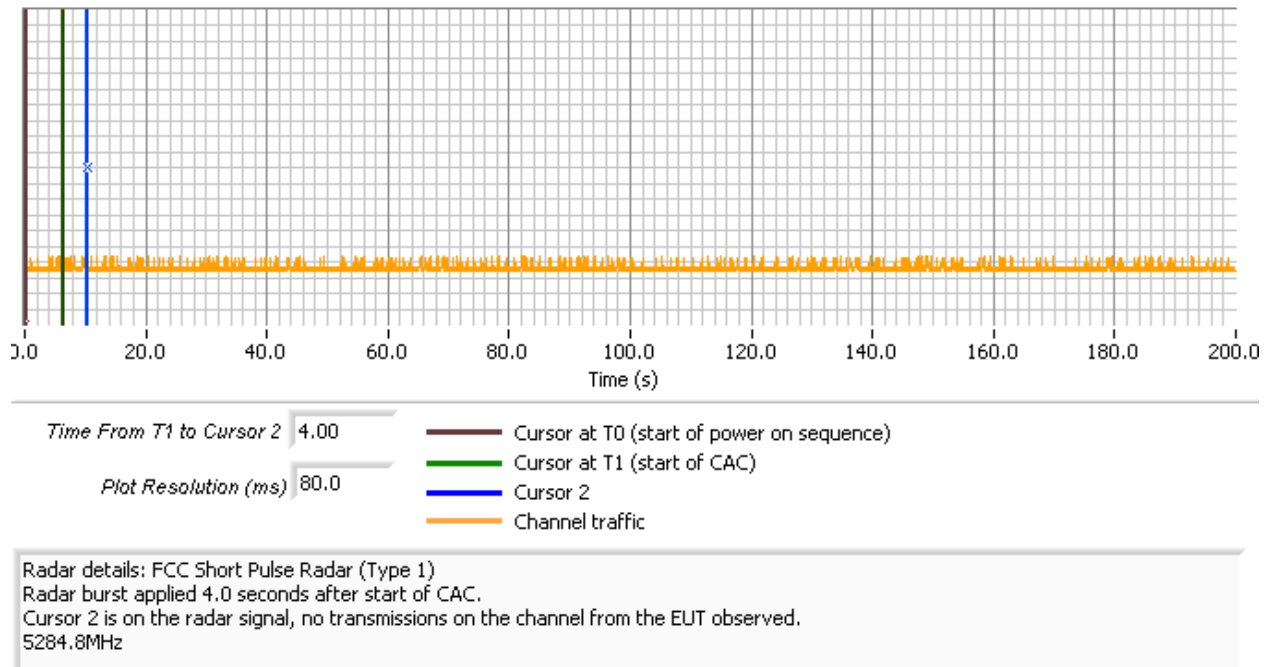

Figure 20 Radar Applied At Start of CAC, WU Low Band



## Timing Plots - Channel Availability Check

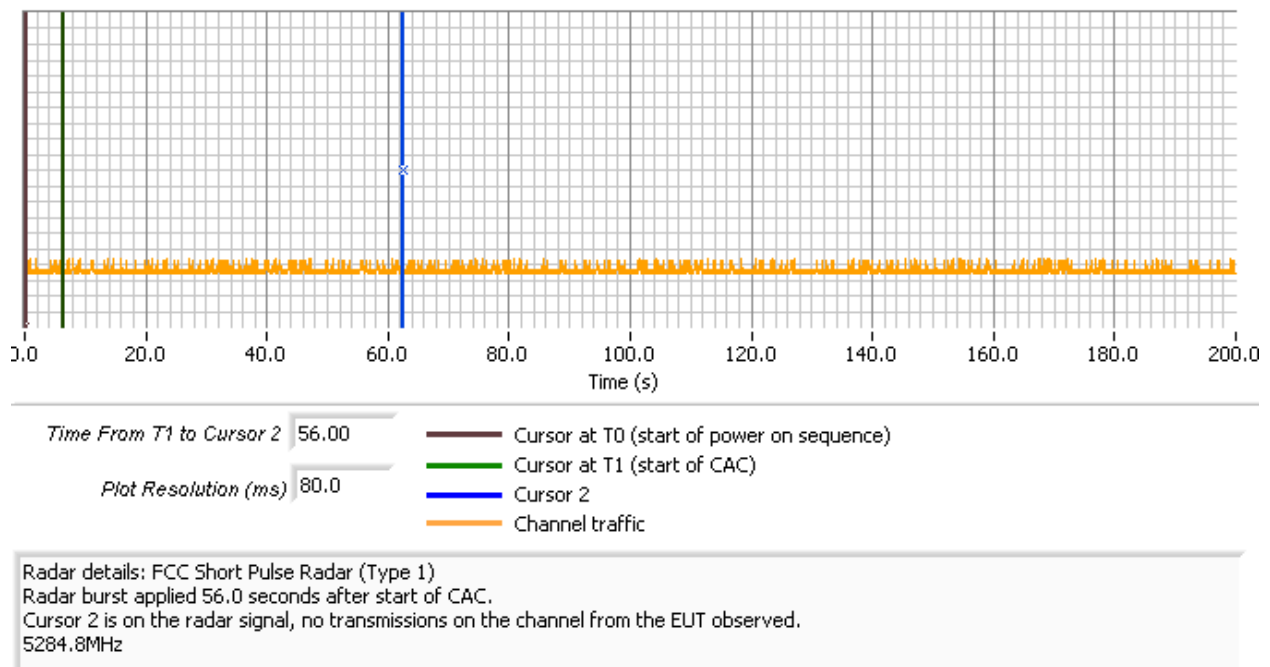

Figure 21 Radar Applied At End of CAC, WU Low Band



## Timing Plots - Channel Availability Check

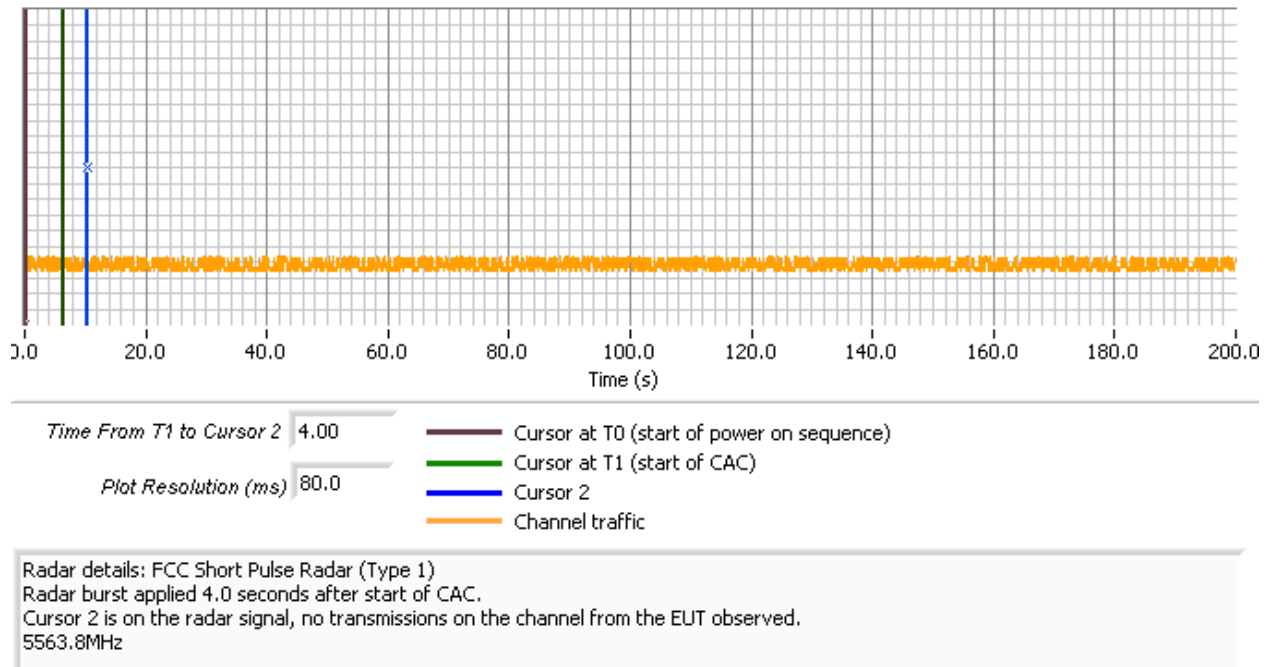

Figure 22 Radar Applied At Start of CAC, WU High Band



## Timing Plots - Channel Availability Check

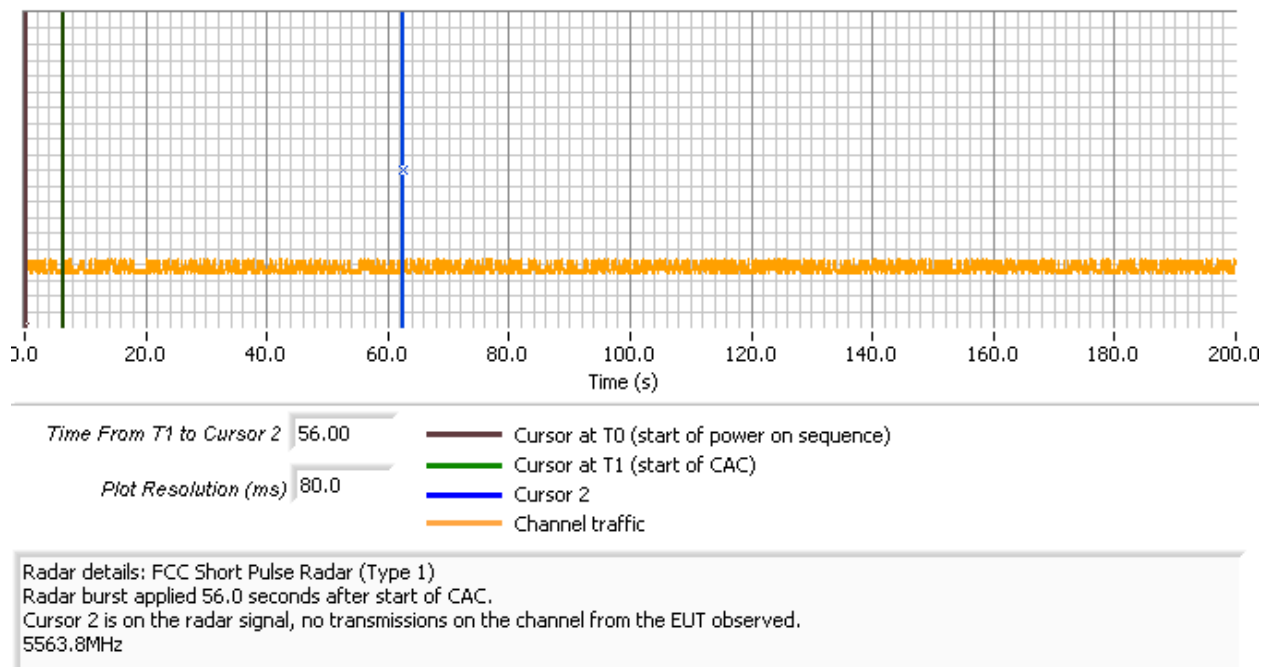

Figure 23 Radar Applied At End of CAC, WU High Band

**Appendix E Antenna Specification**

## 5250 TX (WU)

Angle

0	0.3
1	0.2
2	-0.2
3	-0.5
4	-0.9
5	-1.5
6	-0.6
8	-1.9
9	-2.3
10	-1.8
11	-1
12	-0.8
14	-0.5
15	-0.3
16	0.7
17	2.3
18	2.4
20	3
21	2.8
22	2.9
23	3.3
24	3.3
25	2.9
26	3
28	2
29	1.6
30	1.3
31	0.4
33	-0.5
34	-1.1
35	-1.5
36	-1.6
38	-0.7
39	-0.6
40	-1.1
42	-0.6
43	0.5
44	-0.1
45	0.2
47	0.4

## 5564 TX (CU)

Angle

1	1.3
2	1.6
3	1.2
5	1.2
6	1.7
7	1.4
8	1.3
10	1.3
11	1.2
12	1.1
13	0
15	-0.3
16	-1.5
17	-1.9
18	-2.5
19	-4
21	-5.5
22	-5
23	-4.1
24	-3.6
25	-3.2
26	-1.8
28	-1.9
29	-1.4
30	-0.5
31	0
33	-0.2
34	0.4
35	0.2
36	0.4
38	0.2
39	0.2
40	-0.2
42	-1.3
43	-1.1
44	-1.9
45	-2.5
47	-3.6
48	-3.9
49	-3.8

---

48	0.1	50	-5.7
49	0.4	51	-7.3
50	0.4	53	-7.6
51	0	54	-8.3
52	-0.4	55	-6.6
53	-0.5	56	-5.3
54	-0.5	57	-3.1
55	-0.2	58	-2.2
56	-0.1	59	-1.4
58	0.8	60	-0.4
59	0.3	61	0.4
60	-0.3	62	1.6
61	0.6	64	2.2
62	0.9	65	2
64	0.7	67	2.8
65	1.1	68	3.3
66	1.8	69	3.7
68	1.6	71	3.9
69	0.9	72	4.2
71	0.6	74	5.2
72	1.1	75	4.6
73	0.3	76	4.9
75	0.2	77	5.2
76	-1.1	78	5.1
77	-0.5	80	5.4
79	-1.6	81	5.2
80	-2.5	82	5.4
81	-2.7	83	5.1
82	-2.8	84	5.2
83	-3.8	85	5.2
84	-3.9	87	5.5
85	-4.2	88	4.9
87	-4.7	89	4.9
88	-4	90	4.3
89	-4.1	91	3.8
90	-4	93	3.9
91	-4.1	94	3.9
93	-4	95	3.5
94	-3.8	96	2.5
95	-4.1	98	3.2
96	-3.8	99	2
98	-3.7	100	1.6
99	-4.2	101	1.6
100	-3.2	103	0.4

---

101	-3.4	104	0.1
103	-3	105	-0.6
104	-4.2	107	-1.4
105	-3.9	108	-2.8
107	-2.6	109	-3.8
108	-2.2	110	-4.8
109	-2.6	112	-6.8
110	-2.6	113	-9.4
112	-1.8	114	-10.3
113	-2.1	115	-11.9
114	-2	117	-17.6
115	-0.7	118	-19.9
117	-0.9	119	-14.6
118	-0.3	120	-9.8
119	-0.2	121	-8
120	0.2	122	-6.5
121	0	123	-5
122	-0.4	124	-4.3
124	0.3	126	-3.2
125	0.7	127	-2.6
126	1	128	-2.4
127	-0.2	130	-0.8
128	0	131	-2.1
130	-0.1	132	-1.7
131	-0.6	134	-2.1
133	-0.7	135	-1.8
134	-0.6	136	-2
135	-0.6	138	-2.9
137	-0.2	139	-3
138	-0.6	140	-3.7
139	-1.4	142	-4
141	-1.6	143	-4.6
142	-1.3	144	-5.4
143	-1.7	145	-6.1
144	-1.3	147	-6.5
146	-1.5	148	-7.6
147	-1.6	149	-7.7
148	-1.5	150	-8.3
149	-2.4	151	-9.5
150	-3.4	152	-10.2
151	-4.1	153	-8.7
152	-4.1	154	-8.3
153	-4.1	156	-7.3
154	-3.8	157	-5.6

---

156	-4.7	158	-4.5
157	-4.6	159	-3
158	-4.7	160	-2.3
159	-4.8	162	-1.5
161	-4.1	163	-1.7
162	-2.6	164	-0.9
163	-1.9	165	-0.7
164	-2.2	167	-0.9
166	-2.2	168	-0.4
167	-1.5	169	-0.3
168	-0.9	171	-0.9
170	-0.2	172	-2.1
171	0	173	-1.4
172	0	175	-1.7
173	-0.2	176	-3.1
175	-0.7	177	-4
176	0	178	-2.9
177	-0.8	180	-4.3
179	0.3	181	-4.1
180	-0.2	182	-3.9
181	-1.4	183	-4.4
182	-2	184	-4.1
183	-1.6	185	-2.7
184	-0.8	187	-1.6
185	-0.2	188	0.4
187	-0.8	189	0.3
188	0.1	190	0.1
189	0.8	192	1.1
190	0.3	193	1.2
192	0	194	1.4
193	0.1	196	2.2
194	0.5	197	2.3
196	-0.3	198	2.9
197	-0.3	199	2.7
198	0	201	2.6
200	-0.3	202	2.7
201	-0.2	203	3.3
202	0.5	204	2.7
203	-0.5	205	2.6
205	0.4	207	3.1
206	1.1	208	2.8
207	1.6	209	2.6
208	1.9	211	3
210	2.1	212	2.4

---

211	2.1	213	2
212	1.8	214	2
213	3.3	215	2.2
214	2.6	216	2
215	2.4	217	1.1
216	1.9	218	0.6
217	1.7	220	0.8
218	2.2	221	0.8
220	2	222	0.2
221	2.5	223	0.3
222	3.2	224	0.3
223	2.3	226	-0.5
225	2.9	227	-0.6
226	3.8	228	-0.4
227	2.7	230	-0.8
229	3.5	231	-0.4
230	3.2	232	-0.9
231	4.2	234	-0.6
233	3.6	235	-0.9
234	3.9	236	-0.8
235	3.8	238	-0.7
237	2.8	239	-0.3
238	2.5	240	0.5
239	2.3	241	0.7
241	2.2	243	1.4
242	1.5	244	1.1
243	1.2	245	1.2
244	1.5	246	0.9
245	1.7	247	1.3
246	2	248	1.8
248	1.9	250	1.2
249	2.7	251	1.4
250	3	252	1.7
251	3.3	253	1.9
253	3.7	254	2.1
254	3.6	256	1.6
255	4.1	257	1.9
256	4	258	1.4
258	4.1	260	2.1
259	4.6	261	2.3
260	4.5	262	1.2
261	4.6	263	1.5
263	4.4	265	0.9
264	4.6	266	0.8

---

265	4.1	267	1
266	4.7	268	0.8
268	4.5	270	0.1
269	4.6	271	0.4
270	5.4	272	0.1
272	4.8	274	0.3
273	5.5	275	0.2
274	4.9	276	0.9
275	4.9	277	0.6
276	4.7	278	-0.1
277	5.2	279	0.4
279	4.7	280	0.3
280	4.8	281	0.7
281	5	282	0.4
283	4.6	284	0.1
285	4.6	285	1.1
286	3.8	286	1
287	3.6	287	0.5
288	2.8	289	0.2
290	2	290	0.5
291	1.2	292	0.4
292	0.9	293	0.7
294	0.6	294	0.9
295	0	296	0.1
296	-0.7	297	0.2
298	-1	298	0.4
299	-0.4	299	0
300	-1.4	301	0.5
301	-2.2	302	0.2
302	-1.8	303	0.8
304	-2.3	304	1
305	-3.1	305	-0.1
306	-2	307	0.2
307	-2.3	308	-0.3
308	-2.1	309	-0.4
310	-2.4	310	-0.1
311	-0.9	311	0.2
312	-0.5	312	0.1
313	-0.5	314	0.1
314	0.8	315	-0.4
316	1.2	316	-0.2
317	1.5	317	-0.1
318	0.8	318	0.2
319	0.9	320	-0.6



320	1.5	321	-0.3
322	0.7	322	-1
323	0.3	324	-0.2
324	0.5	325	-0.6
326	-0.7	326	0.1
327	-1.1	327	-0.2
328	-0.8	329	-0.4
330	-1.9	330	-0.2
331	-2.5	331	-0.4
332	-3.4	332	0.4
333	-3.3	333	-0.6
334	-4.3	335	0.3
336	-4.7	336	0.4
337	-4.4	337	0.2
338	-4.8	338	0.2
339	-5.8	339	-0.1
340	-5.6	340	0.1
341	-4.4	341	-0.2
342	-4.4	342	-0.2
343	-3.2	343	-0.1
344	-2.6	344	-0.3
345	-1.9	345	-0.4
346	-1.6	346	-0.1
347	-1.1	348	-0.6
348	-0.3	349	-0.6
349	0.5	350	-0.4
351	0.5	351	-0.2
352	0.5	352	0
353	0.1	353	0.4
354	0.4	354	0.5
355	-0.1	355	0.8
356	-0.2	356	1.8
357	-0.4	358	1.2
358	-0.7	359	1.4
359	-1.6		
Min TX	-5.8	-19.9	(Has a notch)
Max TX	5.5	5.5	

5564 RX (WU)			5250 RX (CU)		
Angle	RX Ant 1	RX Ant 2	angle	RX Ant 1	RX Ant 2
0	-1.5	-1	0	0.5	-3
10	-0.5	-2.5	10	-4.5	-1
20	-1.5	-5.5	20	-3	0
30	-2	-8	30	-8	-1
40	-1	-2	40	-8	-0.5
50	-3.5	-2	50	-8	-1.5
60	-5	-1	60	-10	4
70	-2	0	70	-10	-2.5
80	-0.5	-2	80	-7	2.5
90	-4	-8	90	-6	4
100	-4	-3	100	-5	1.5
110	-6	0	110	0	-4
120	-5	1.5	120	0	-2.5
130	-4	-1	130	0	0
140	1	-4	140	2	-1
150	-2	0	150	-1	-3
160	0	-1	160	0	-2
170	-4	0	170	5	-2.5
180	-2	1	180	1	-7
190	0	2	190	3	-7
200	1	-1	200	3	-6.5
210	-1	-1	210	2	-7
220	1	-1	220	0	-7
230	0	1	230	-2	-4
240	1	4	240	-4	-7
250	2.5	3	250	0	-7
260	2	1	260	-3	-7
270	2	-1	270	-6	-4
280	1	2	280	-8	-2
290	-3.5	2	290	-5	0
300	-3	2	300	2	-2
310	1	0	310	-2	-4
320	0	1	320	-1	0
330	1	0	330	-2	-4
340	-2	-1.5	340	2	-1
350	0	-1	350	0	-3
Min RX	-6	-8	-10	-7	
Max RX	2.5	4	5	4	

Appendix F Test Configuration Photograph(s)

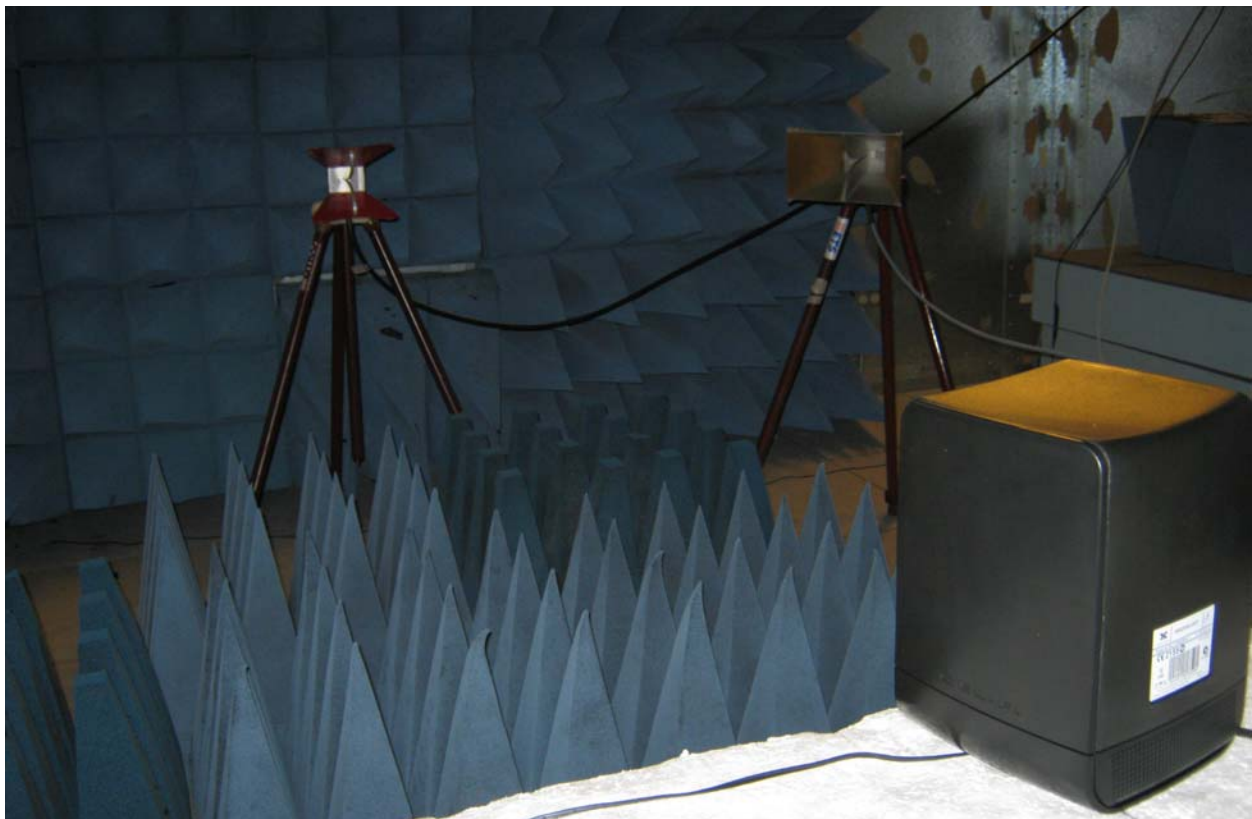

## Appendix G DFS Implementation Proposal for Cel-Fi U-NII Link



# NEXTIVITY

## DFS Implementation Proposal for Cel-Fi U-NII Link

Version 0.7

Monday, 23 February 2009

© Copyright Nextivity Inc. 2008, 2009. All Rights Reserved.

Nextivity Inc. Proprietary and Confidential

*The information contained in this document is Nextivity Inc. proprietary and confidential and is the sole property of Nextivity Inc. and shall not be used, copied, reproduced, or disclosed in whole or in part without written consent of Nextivity Inc.*

## 1. INTRODUCTION

Cel-Fi is a new product based on a split three-hop repeater concept designed to provide better indoor cellular coverage (Figure 1).

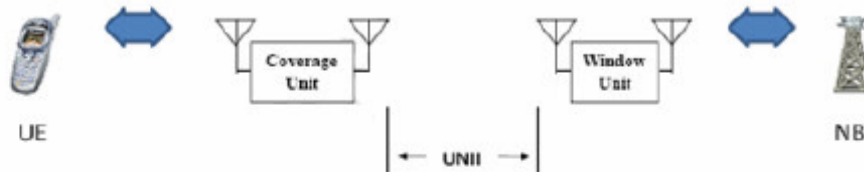

**Figure 1 - Cel-Fi Three-Hop Repeater System**

Cel-Fi consists of two devices, the Window Unit (WU) and the Coverage Unit (CU). The Window Unit is placed in the area of a home with the strongest signal from a wireless carrier. The WU communicates with the cell tower. The Coverage Unit is placed in the center of the home, communicates wirelessly with the WU and "lights up" the interior of the home with significantly enhanced signal, thus enabling better quality calls and greater download speeds.

## 2. U-NII BAND COMMUNICATION LINK

The Window Unit (WU) and the Coverage Unit (CU) communicate with each other using a proprietary point-to-point link in the U-NII band. The link requires the simultaneous use of two 40 MHz channels, where one is taken from the 5150-5350 MHz band and the other is taken from the 5470-5725 MHz band. This link is a frame-based proprietary system which bears no resemblance to 802.11 WLAN technology. The WU is the master device responsible for selecting both uplink and downlink frequencies, and for initiating transmission on the communication link.

The U-NII link uses MIMO technology to provide spatial diversity on the link. Each unit, WU and CU, has 2 transmit and 2 receive chains. Both WU and CU use identical transceivers, but some of the associated control electronics are different. From a DFS perspective the detection algorithms and receivers are the same.

The remainder of this document provides detail on the proposed DFS implementation for the U-NII link. The goal is to provide DFS functionality that satisfies both FCC and ETSI requirements.

## 3. OPERATIONAL MODES FOR DFS

The Cel-Fi system uses 4 operational modes which allow the two component devices (WU and CU) to synchronize with each other while satisfying DFS radar detection requirements. The modes are illustrated in Figure 2.

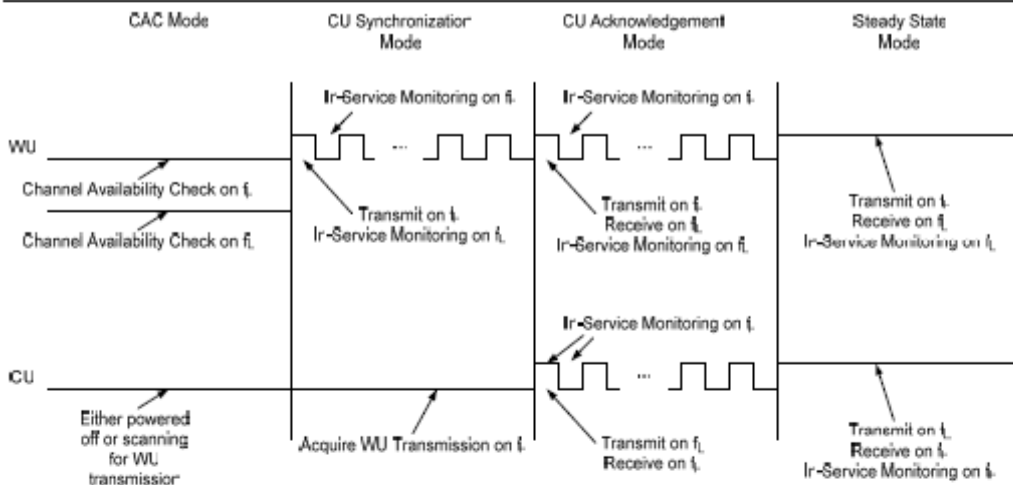

Figure 2 - U-NII Link Operational Modes

### 3.1. CAC Mode

When the WU is powered up, it performs a RSSI scan on all U-NII channels and then selects two of them for the Cel-Fi link ( $f_L$  from the 5150-5350 MHz band and  $f_H$  from the 5470-5725 MHz band). Prior to any transmission over a potential radar occupied channel, the WU will perform a channel availability check for at least 60 seconds. The WU hardware is capable of using the two receive antennas and two radio receivers to perform the CAC **simultaneously** on the selected upper and lower band channels.

In the event that the CU is powered on before the WU, it will not transmit on any U-NII channel, but will continue to scan for WU transmissions.

### 3.2. CU Synchronization Mode

Following a successful CAC on both selected channels ( $f_H$  and  $f_L$ ), the WU will initiate transmission on  $f_H$ . The transmission will be performed using a 3.15 msec frame with a 50% transmit/receive duty cycle. While transmitting on  $f_H$ , the WU will listen for radar on  $f_L$ . When not transmitting, the WU will listen for radar on  $f_H$ . This allows the WU to perform in-service monitoring on both channels simultaneously.

During this period, the CU will normally be powered on and synchronize to the WU transmission on  $f_H$ . A control channel message will specify the frequency to use for  $f_L$ .

If the CU is powered on before the WU, then this mode of operation will typically last for 10-20 msec. If the WU is powered on before the CU, then this mode will last for an arbitrary duration until the CU is powered on.

#### 3.2.1. Proposed Channel Loading Scheme for In-Service Monitoring Tests During CU Synchronization Mode

In-service monitoring tests can be performed during this mode of operation by switching the WU on and leaving the CU switched off. In this mode, the loading on  $f_H$  will always be 50% due to the transmit/receive duty cycle. During this mode, there will never be any Cel-Fi generated traffic on  $f_L$ . However, null frame intervals will occur on  $f_L$  due to the WU receiver listening for radar on  $f_H$ . This would be equivalent to a channel load of 50%. The relevant timing is shown in Figure 3.



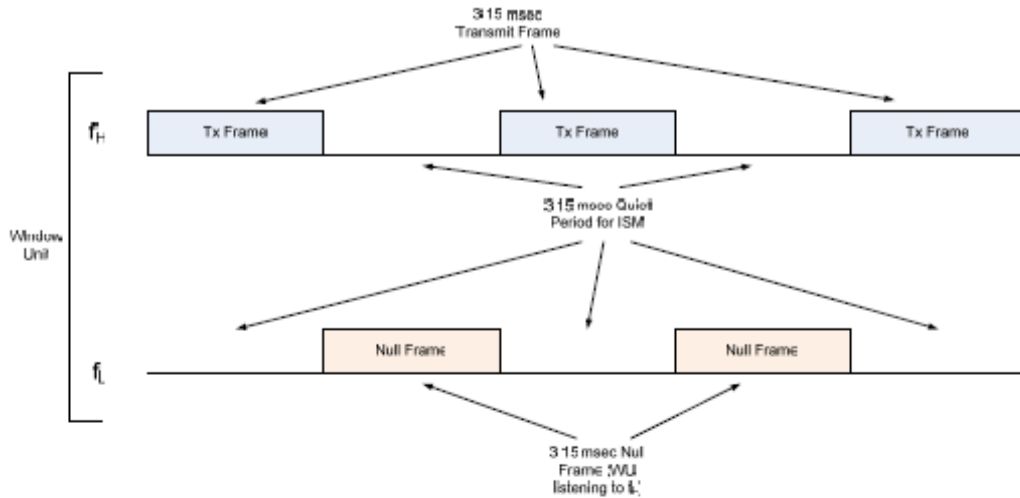

Figure 3 - Channel Loading During CU Synchronization Mode

In service monitoring tests will be performed on the WU for both  $f_H$  and  $f_L$  channels in this mode. In-service monitoring detection probability tests for all of the radar waveforms will be performed in this mode on the WU. Channel move and channel closing time measurements shall be made for the WU on  $f_H$  using radar types 1 and 5

### 3.3. CU Acknowledgement Mode

Once the CU synchronizes to the WU and determines the frequency of  $f_L$ , it may begin transmission on  $f_L$ . This transmission is performed using 3.15 msec frames with a 50% transmit/receive duty cycle. The transmissions coincide with the periods when the WU is listening on  $f_L$ .

In this mode the CU will begin in-service monitoring on  $f_H$  while the WU is performing in-service monitoring on both  $f_H$  and  $f_L$ .

This mode of operation should last no more than 90 msec. This worst case scenario would occur if the CU synchronizes with the WU but control messages are not correctly exchanged, eventually resulting in a timeout.

#### 3.3.1. Proposed Channel Loading Scheme for In-Service Monitoring Tests During CU Acknowledgment Mode

The Cel-Fi system will implement a DFS test mode that allows the system to be frozen in CU Acknowledgment mode. Although the system is normally in this mode for only a short period of time, it will facilitate evaluation of in-service monitoring performance while in this mode. In all cases, the channel loading will always be at 50% due to the normal Cel-Fi link traffic. The frame structure involved is shown in Figure 4.

As the duration of this mode is short, and as the normal operating mode described in the next section has significantly higher transmitter duty cycle (100%), it is not felt that this mode needs to be evaluated. If considered necessary, in-service monitoring can be performed on  $f_H$  and  $f_L$  at the WU and on  $f_H$  at the CU. If considered necessary, detection probability for radar waveforms 1 and 5 shall be evaluated in this mode just to confirm that in service monitoring does occur.

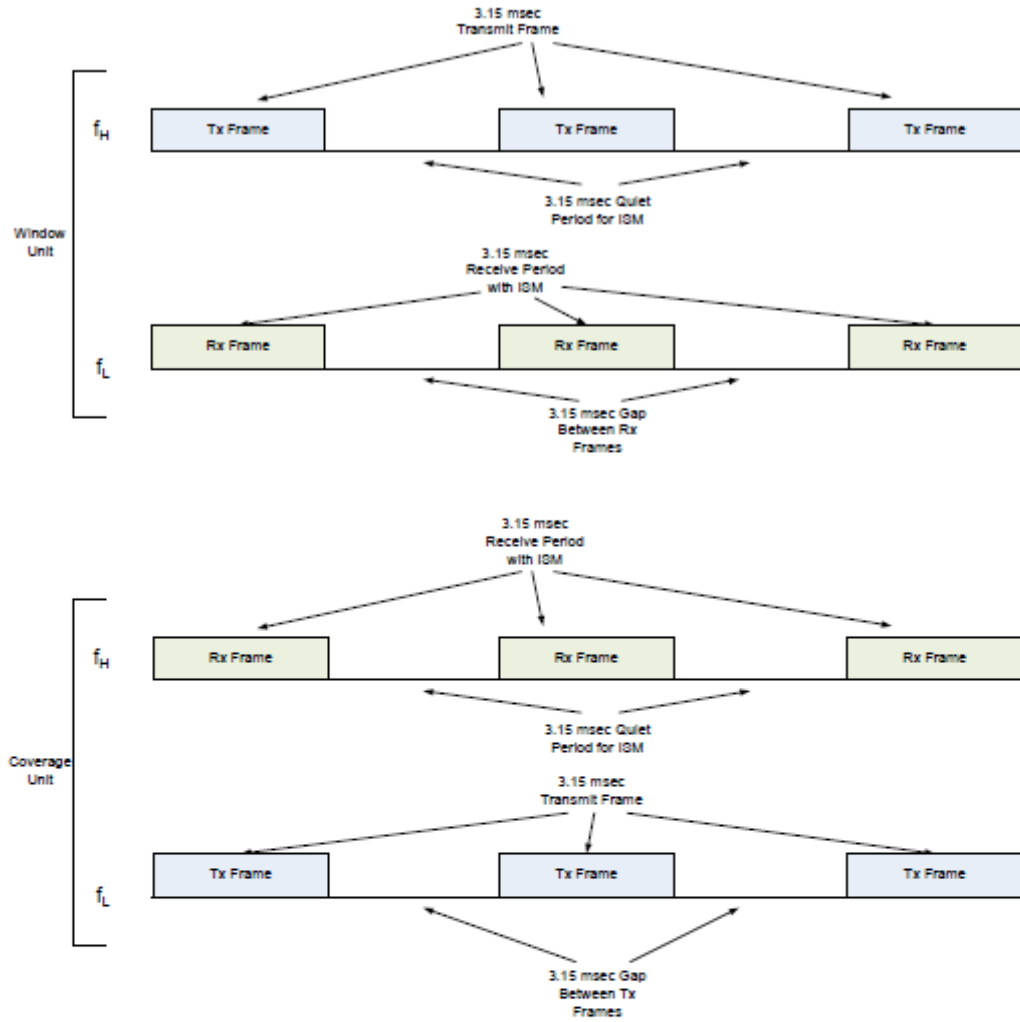
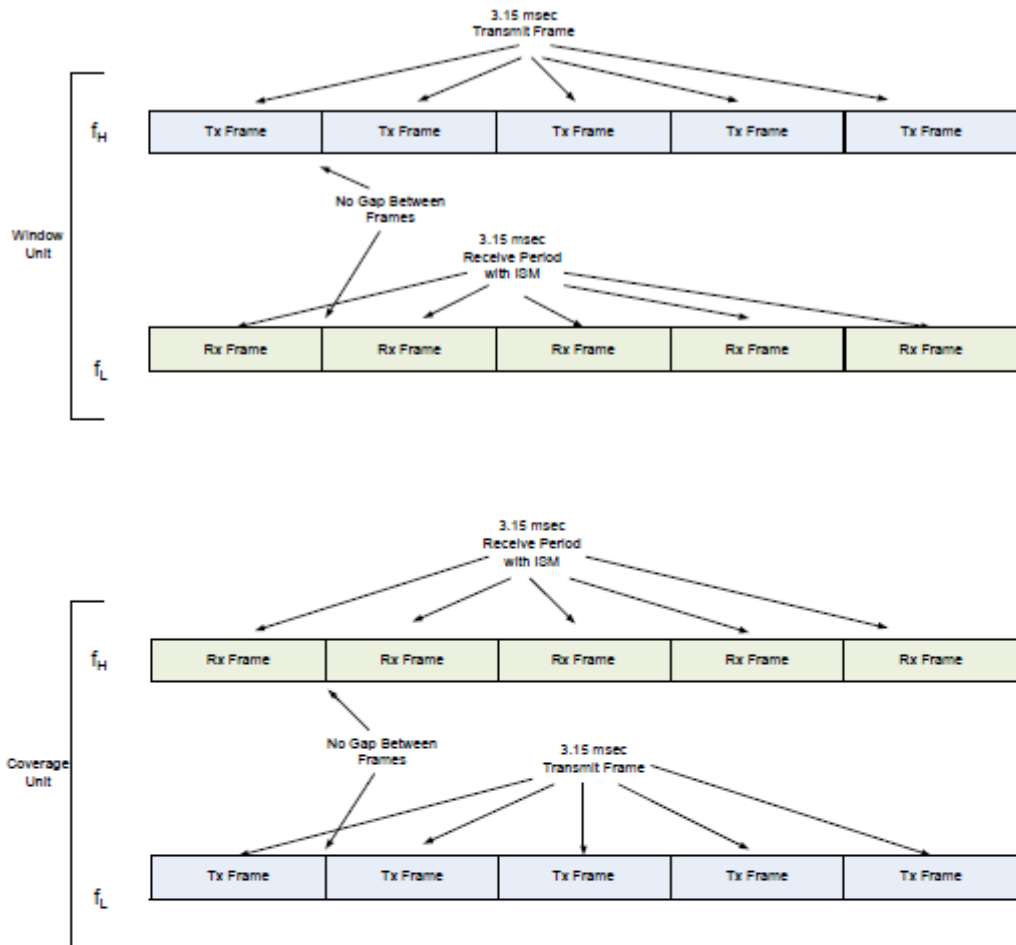

Figure 4 - Channel Loading During CU Acknowledgement Mode

### 3.4. Steady-State Mode

After the link is setup on both channels, the Cel-Fi system is able to switch into steady-state mode. The switch is coordinated between the WU and CU. In this mode the WU transmits continuously on  $f_H$  and listens continuously on  $f_L$ . The WU will be able to detect radar in the presence of the received data signal during in-service monitoring, so it effectively functions as a master for channel  $f_L$ . Similarly, the CU will transmit continuously on  $f_L$  and receive continuously on  $f_H$ . The CU will perform in-service monitoring on  $f_H$  and be the master for that channel. Thus in-service monitoring is being performed on both  $f_H$  and  $f_L$ . The frame structure for this mode is illustrated in Figure 5.





**Figure 5 - Channel Loading During Steady-State Mode**

During this mode, the channel loading is always 100% and does not change whether a cell phone call is active or not. Once the link is established between WU and CU devices, data is constantly streamed between the two so that the mobile phone remains on the network. When no phone call has been established from the user's cell phone to the network through the WU-CU, the channel is loaded with a constant stream of OFDM symbols consisting of control channel information, pilot tones, and randomly generated payload data. The randomly generated payload data required to maintain the WU-CU link is ignored by the receiver.

When a call is established through the WU-CU the randomly generated payload data between WU and CU is replaced with actual cell phone data. There is no way to determine whether a call is in progress through observation of the OFDM signal, as the signal will look identical in both cases.

In-service monitoring detection probability tests for all of the radar waveforms will be performed in this mode on the WU the CU. Channel move and channel closing time measurements shall be made for the WU and CU using radar types 1 and 5. These closing time tests will also evaluate the WU and CU in client mode. For these tests a cell call shall be established through the system using a call emulator rather than relying on the dummy payload packets

## 4. VACATING THE CHANNEL

### 4.1. Channel Move Time

In the event that one of the component Cel-Fi devices detects radar during in service monitoring, it will notify the other device through the reverse channel and cease transmitting in the radar occupied channel.

If for some reason the other device does not receive the message, it will detect that the link has been dropped and cease transmission. The assumption will be that radar has been detected.

The Cel-Fi system will ensure that the channel is vacated within 15 msec, well below the 10 second requirement.

### 4.2. Channel Closing Transmission Time

The worst case channel move time is less than the 60ms FCC and 260ms ETSI channel closing transmission times, so this requirement is automatically satisfied for both the FCC and ETSI.

### 4.3. Non-Occupancy Period

The WU will maintain a database of channels that have been identified as containing radar. These channels will not be used by the Cel-Fi system for the 30-minute non-occupancy period.

## 5. CHANNEL SELECTION

The WU will be responsible for U-NII channel selection for both the uplink and the downlink.

### 5.1. Uniform Loading

In order to satisfy the uniform loading requirement, the WU will scan all U-NII channels to perform a RSSI measurement prior to channel selection. The selected channels will be randomly selected from among those whose RSSI value is below a specified threshold.

### 5.2. 5600-5650 MHz

The initial version of the Cel-Fi system will make use of the 5600-5650 MHz portion of the U-NII band. It is likely that this part of the spectrum will not be used if:

- 1) Future changes in compliance specifications include a 10 minute CAC in the weather radar band.
- 2) Specific governments have blocked usage of these frequencies.

### 5.3. Channel Allocation

The lower U-NII band channels will be centered at 5190, 5210, 5230, 5250, 5270, 5290, and 5310 MHz. This utilizes 80% of the band spanning 5150-5350 MHz.

The upper U-NII band channels will be centered at 5510, 5530, 5550, 5570, 5590, 5610, 5630, 5650, 5670, and 5690 MHz. This utilizes 86% of the band spanning 5470-5725 MHz.

In the event that the 5600-5650 MHz band is not used, the upper band channels will be centered at 5510, 5530, 5550, 5570, 5670, and 5690 MHz. This utilizes 62% of the band spanning 5470-5725 MHz.



## 6. RADAR DETECTION

### 6.1. Detection Bandwidth

Although the U-NII link utilizes channels with a nominal bandwidth of 40 MHz, the occupied channel bandwidth is 33 MHz. The Cel-Fi devices are able to detect radar over approximately 97% of the 99% power bandwidth.

### 6.2. Detection Threshold

Since the Cel-Fi devices will transmit at a level well below 200 mW eirp, the radar detection threshold is -62 dBm.

### 6.3. Transmit Power Control

The Cel-Fi system employs transmit power control in order to keep the received signal level adequately below the radar detection threshold. At no time does the transmit power level become so great that a potential radar signal at or above the detection threshold is masked. The transmit power has a dynamic range of at least 30 dB.

During CU acknowledgement mode the WU will initially transmit at maximum power. The CU uses this information in conjunction with the measured RSSI to determine an appropriate initial transmit power level on  $f_L$ . Once an acknowledgment is received by the WU, the two units will fine tune their transmit power levels prior to switching into steady state mode.

### 6.4. Detection Probability

During CAC, the WU is able to detect 100% of the FCC or ETSI radar test signals. During in service monitoring, the detection rates will exceed those specified for both FCC and ETSI.

## 7. DOCUMENT HISTORY

Table 1 Document History

Date	Revision Number	Description	Author
July 15, 2008	0.1	Initial draft.	Richard Buz
August 1, 2008	0.2	Incorporate comments	
August 8, 2008	0.3	Added more information on the U-NII link and overall system. Elaborated on channel loading during in-service monitoring.	Richard Buz
August 8, 2008	0.4	Incorporated additional comments from Mark Briggs.	Richard Buz
September 24, 2008	0.5	Added detail for the content of Tx packets when there is or isn't a call established in response to a request from the FCC.  Added information that both WU and CU use the same transceivers and same DFS detection hardware and algorithm.  Proposed reduced tests on the CU for in-service monitoring.	Richard Buz Mark Briggs Elliott Labs

DFS Implementation Proposal For Cel-Fi U-NII Link  
Version 0.7 Monday, 23 February 2009



Date	Revision Number	Description	Author
December 16, 2008	0.6	Added detail following CTIA-FCC-Nextivity conference call	Mark Briggs Elliott Labs
February 23, 2009	0.7	<p>Modified document in accordance with NTIA feedback as follows:</p> <p>page 4 of 8, paragraph 1, NTIA requests the following changes to the Version 0.6 document dated December 16, 2008 as shown in redline/strikeout: <i>"In service monitoring tests will be performed on the WU for both <math>f_H</math> and <math>f_L</math> channels in this mode. In-service monitoring detection probability tests for all of the radar waveforms will be performed in this mode on the WU. Channel move and channel closing time measurements shall be made for the WU on <math>f_H</math> using radar types 1 and 5."</i></p> <p>On page 6 of 8, paragraph 3, NTIA requests the following changes to the Version 0.6 document dated December 16, 2008 as shown in redline/strikeout <i>"In-service monitoring detection probability tests for all of the radar waveforms will be performed in this mode on the WU the CU. Channel move and channel closing time measurements shall be made for the WU and CU using radar types 1 and 5. These closing time tests will also evaluate the WU and CU in client mode For these tests a cell call shall be established through the system using a call emulator rather than relying on the dummy payload packets"</i></p>	Mark Briggs Elliott Labs