

EMC Test Report

Application for Grant of Equipment Authorization

*Industry Canada RSS-Gen Issue 3 / RSS 210 Issue 8
FCC Part 15, Subpart E*

CELFI-RS225CU

IC CERTIFICATION #: 9298A-CRS225CU
FCC ID: YETCELFI-RS225CU

APPLICANT: Nextivity Inc.
12230 World Trade Drive Suite 250
San Diego, CA 92128

TEST SITE(S): Elliott Laboratories
41039 Boyce Road.
Fremont, CA. 94538-2435

IC SITE REGISTRATION #: 2845B-3; 2845B-4, 2845B-5, 2845B-7

REPORT DATE: May 9, 2012

FINAL TEST DATES: March 20 and April 6, 2012

TOTAL NUMBER OF PAGES: 45

PROGRAM MGR /
TECHNICAL REVIEWER:



David W. Bare
Chief Engineer

QUALITY ASSURANCE DELEGATE /
FINAL REPORT PREPARER:

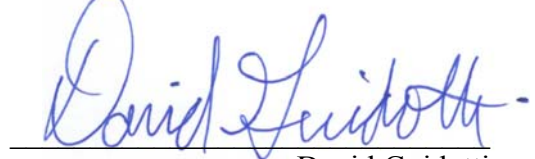

David Guidotti
Senior Technical Writer



Elliott Laboratories is accredited by the A2LA, certificate number 0214.26, to perform the test(s) listed in this report, except where noted otherwise. This report and the information contained herein represent the results of testing test articles identified and selected by the client performed to specifications and/or procedures selected by the client. National Technical Systems (NTS) makes no representations, expressed or implied, that such testing is adequate (or inadequate) to demonstrate efficiency, performance, reliability, or any other characteristic of the articles being tested, or similar products. This report should not be relied upon as an endorsement or certification by NTS of the equipment tested, nor does it represent any statement whatsoever as to its merchantability or fitness of the test article, or similar products, for a particular purpose. This report shall not be reproduced except in full

REVISION HISTORY

Rev#	Date	Comments	Modified By
-	05-09-2012	First release	

TABLE OF CONTENTS

REVISION HISTORY	2
TABLE OF CONTENTS	3
SCOPE.....	4
OBJECTIVE	5
STATEMENT OF COMPLIANCE.....	5
DEVIATIONS FROM THE STANDARDS.....	5
TEST RESULTS SUMMARY	6
UNII / LELAN DEVICES	6
GENERAL REQUIREMENTS APPLICABLE TO ALL BANDS.....	7
MEASUREMENT UNCERTAINTIES.....	8
EQUIPMENT UNDER TEST (EUT) DETAILS.....	9
GENERAL.....	9
ANTENNA SYSTEM	9
ENCLOSURE.....	9
MODIFICATIONS.....	9
SUPPORT EQUIPMENT.....	9
EUT INTERFACE PORTS	10
EUT OPERATION	10
TEST SITE.....	11
GENERAL INFORMATION.....	11
CONDUCTED EMISSIONS CONSIDERATIONS	11
RADIATED EMISSIONS CONSIDERATIONS	11
MEASUREMENT INSTRUMENTATION	12
RECEIVER SYSTEM	12
INSTRUMENT CONTROL COMPUTER	12
LINE IMPEDANCE STABILIZATION NETWORK (LISN).....	12
FILTERS/ATTENUATORS	13
ANTENNAS.....	13
ANTENNA MAST AND EQUIPMENT TURNTABLE	13
INSTRUMENT CALIBRATION.....	13
TEST PROCEDURES	14
EUT AND CABLE PLACEMENT	14
CONDUCTED EMISSIONS.....	14
RADIATED EMISSIONS.....	15
CONDUCTED EMISSIONS FROM ANTENNA PORT	17
BANDWIDTH MEASUREMENTS	17
SPECIFICATION LIMITS AND SAMPLE CALCULATIONS.....	18
CONDUCTED EMISSIONS SPECIFICATION LIMITS: FCC 15.207; FCC 15.107(A), RSS GEN	18
GENERAL TRANSMITTER RADIATED EMISSIONS SPECIFICATION LIMITS	19
RECEIVER RADIATED SPURIOUS EMISSIONS SPECIFICATION LIMITS	19
FCC 15.407 (A) OUTPUT POWER LIMITS	20
OUTPUT POWER LIMITS –LELAN DEVICES.....	20
SPURIOUS EMISSIONS LIMITS –UNII AND LELAN DEVICES	21
SAMPLE CALCULATIONS - CONDUCTED EMISSIONS	21
SAMPLE CALCULATIONS - RADIATED EMISSIONS.....	21
SAMPLE CALCULATIONS - FIELD STRENGTH TO EIRP CONVERSION.....	22
APPENDIX A TEST EQUIPMENT CALIBRATION DATA	23
APPENDIX B TEST DATA	24
END OF REPORT	45

SCOPE

An electromagnetic emissions test has been performed on the Nextivity Inc. CELFI-RS225CU, pursuant to the following rules:

- Industry Canada RSS-Gen Issue 3

- RSS 210 Issue 8 “Low-power Licence-exempt Radiocommunication Devices (All Frequency Bands): Category I Equipment”

- FCC Part 15, Subpart E requirements for UNII Devices

Conducted and radiated emissions data has been collected, reduced, and analyzed within this report in accordance with measurement guidelines set forth in the following reference standards and as outlined in Elliott Laboratories test procedures:

- ANSI C63.4:2003

- FCC UNII test procedure KDB789033

The intentional radiator above has been tested in a simulated typical installation to demonstrate compliance with the relevant Industry Canada performance and procedural standards.

Final system data was gathered in a mode that tended to maximize emissions by varying orientation of EUT, orientation of power and I/O cabling, antenna search height, and antenna polarization.

Every practical effort was made to perform an impartial test using appropriate test equipment of known calibration. All pertinent factors have been applied to reach the determination of compliance.

OBJECTIVE

The primary objective of the manufacturer is compliance with the regulations outlined in the previous section.

Prior to marketing in the USA, all unlicensed transmitters and transceivers require certification. Receive-only devices operating between 30 MHz and 960 MHz are subject to either certification or a manufacturer's declaration of conformity, with all other receive-only devices exempt from the technical requirements.

Prior to marketing in Canada, Class I transmitters, receivers and transceivers require certification. Class II devices are required to meet the appropriate technical requirements but are exempt from certification requirements.

Certification is a procedure where the manufacturer submits test data and technical information to a certification body and receives a certificate or grant of equipment authorization upon successful completion of the certification body's review of the submitted documents. Once the equipment authorization has been obtained, the label indicating compliance must be attached to all identical units, which are subsequently manufactured.

Maintenance of compliance is the responsibility of the manufacturer. Any modification of the product which may result in increased emissions should be checked to ensure compliance has been maintained (i.e., printed circuit board layout changes, different line filter, different power supply, harnessing or I/O cable changes, etc.).

STATEMENT OF COMPLIANCE

The tested sample of Nextivity Inc. CELFI-RS225CU complied with the requirements of the following regulations:

RSS 210 Issue 8 "Low-power Licence-exempt Radiocommunication Devices (All Frequency Bands): Category I Equipment"
FCC Part 15, Subpart E requirements for UNII Devices

Maintenance of compliance is the responsibility of the manufacturer. Any modifications to the product should be assessed to determine their potential impact on the compliance status of the device with respect to the standards detailed in this test report.

The test results recorded herein are based on a single type test of Nextivity Inc. CELFI-RS225CU and therefore apply only to the tested sample. The sample was selected and prepared by Steve Van Skike of Nextivity Inc..

DEVIATIONS FROM THE STANDARDS

No deviations were made from the published requirements listed in the scope of this report.

TEST RESULTS SUMMARY**UNII/LELAN DEVICES****Operation in the 5.47-5.60 and 5.65-5.725 GHz Bands**

FCC Rule Part	RSS Rule Part	Description	Measured Value / Comments	Limit / Requirement	Result (margin)
15.407(a)(2)	-	26dB Bandwidth	36.6 MHz	N/A – limits output power if < 20MHz	N/A
-	A9.2(1)	99% Bandwidth	36.6 MHz	N/A – limits output power if < 20MHz	N/A
15.407(a)(2)	A9.2(3)	Output Power	114.8mW	24 dBm / 250mW (eirp < 30dBm)	Complies
15.407(a)(2)		Power Spectral Density	8.1dBm/1MHz	11 dBm/MHz	Complies
	A9.2(3)	Power Spectral Density		11 dBm / MHz ¹	Complies
KDB 443999	A9.2(3)	Non-operation in 5600 – 5650 MHz sub band	Device cannot operate in the 5600 – 5650 MHz band –refer to Operational Description		Complies

Requirements for all U-NII/LELAN bands

FCC Rule Part	RSS Rule Part	Description	Measured Value / Comments	Limit / Requirement	Result
15.407	A9.4(1)	Modulation	OFDM Digital Modulation is used	Digital modulation is required	Complies
15.407(b)(5) / 15.209	A9.2	Spurious Emissions	51.5dBμV/m @ 5455.2MHz (-2.5dB)	Refer to page 21	Complies
15.407(a)(6)	-	Peak Excursion Ratio	11.8dB	< 13dB	Complies
-	A9.4(3)	Channel Selection	Spurious emissions tested at outermost channels in each band	Device was tested on the top, bottom and center channels in each band	N/A
15	-		Measurements on three channels in each band		N/A
15.407 (c)	A9.4(4)	Operation in the absence of information to transmit	Operation never stops as information from cell tower is always present	Device shall automatically discontinue operation in the absence of information to transmit	Complies
15.407 (g)	-	Frequency Stability	Frequency stability is better than 10ppm	Signal shall remain within the allocated band	Complies
15.407 (h1)	A9.3	Transmit Power Control	TPC is not required as the device operates at below 500mW eirp	The U-NII device shall have the capability to operate with a mean EIRP value lower than 24dBm (250mW)	Complies

¹ Reduced from 11dBm because highest value exceeded the average value by more than 3dB

FCC Rule Part	RSS Rule Part	Description	Measured Value / Comments	Limit / Requirement	Result
15.407 (h2)	A9.3	Dynamic frequency Selection (device with radar detection)	Refer to separate test report, reference R87008	Threshold -62dBm (-64dBm if eirp > 200mW) Channel Availability Check > 60s Channel closing transmission time < 260ms Channel move time < 10s Non occupancy period > 30minutes	Complies
	A9.4(5)	User Manual information	Refer to User Manual Statements	Warning regarding interference from Satellite Systems	Complies
-	A9.4(6)	User Manual	Refer to User Manual statements	Indoor use and antenna gain	Complies
-	A9.4(7)	User Manual	Refer to User Manual statements	Advice about high power radar interference	Complies

GENERAL REQUIREMENTS APPLICABLE TO ALL BANDS

FCC Rule Part	RSS Rule part	Description	Measured Value / Comments	Limit / Requirement	Result (margin)
15.203	-	RF Connector		Unique or integral antenna required	Complies
15.207	RSS GEN Table 2	AC Conducted Emissions	44.0 dB μ V @ 0.179 MHz (-20.5 dB)	Refer to page 18	Complies
15.247 (b) (5) 15.407 (f)	RSS 102	RF Exposure Requirements	Refer to MPE calculations in Exhibit 11, RSS 102 declaration and User Manual statements.	Refer to OET 65, FCC Part 1 and RSS 102	Complies
-	RSP 100 RSS GEN 7.1.5	User Manual	Refer to User Manual statements	Statement required regarding non-interference	Complies
-	RSP 100 RSS GEN 7.1.5	User Manual	Device does not use detachable antennas	Statement for products with detachable antenna	Complies
-	RSP 100 RSS GEN 4.4.1	99% Bandwidth	26.7 MHz	Information only	N/A

MEASUREMENT UNCERTAINTIES

ISO/IEC 17025 requires that an estimate of the measurement uncertainties associated with the emissions test results be included in the report. The measurement uncertainties given below are based on a 95% confidence level and were calculated in accordance with UKAS document LAB 34.

Measurement Type	Measurement Unit	Frequency Range	Expanded Uncertainty
RF power, conducted (power meter)	dBm	25 to 7000 MHz	± 0.52 dB
RF power, conducted (Spectrum analyzer)	dBm	25 to 7000 MHz	± 0.7 dB
Conducted emission of transmitter	dBm	25 to 26500 MHz	± 0.7 dB
Conducted emission of receiver	dBm	25 to 26500 MHz	± 0.7 dB
Radiated emission (substitution method)	dBm	25 to 26500 MHz	± 2.5 dB
Radiated emission (field strength)	dB μ V/m	25 to 1000 MHz	± 3.6 dB
		1000 to 40000 MHz	± 6.0 dB
Conducted Emissions (AC Power)	dB μ V	0.15 to 30 MHz	± 2.4 dB

EQUIPMENT UNDER TEST (EUT) DETAILS**GENERAL**

The Nextivity Inc. model CELFI-RS225CU is half of a smart repeater system that receives a cell signal from a cell site, converts it to a signal in the 5 GHz ISM band & transmits that to another close by transceiver inside a building, which receives & converts it back to a cell signal. That cell signal is then transmitted to any cell phones in the building. The uplink from cell phones is this process in reverse. The EUT was treated as table-top equipment during testing to most closely simulate the end-user environment. The electrical rating of the EUT is 100-240 Volts, 50-60 Hz, 0.7 Amps.

The sample was received on March 13, 2012 and tested on March 20 and April 6, 2012. The EUT consisted of the following component(s):

Company	Model	Description	Serial Number	FCC ID
Nextivity Inc	CELFY-RS225CU	Smart cell band repeater	150206000097	YETCELFY-RS225CU

ANTENNA SYSTEM

The antenna is integral to the device.

ENCLOSURE

The CU is primarily constructed of plastic. It measures approximately 157mm H x 145mm W x 58mm D.

MODIFICATIONS

No modifications were made to the EUT during the time the product was at Elliott.

SUPPORT EQUIPMENT

No support equipment was used during testing.

EUT INTERFACE PORTS

The I/O cabling configuration during testing was as follows:

Port	Connected To	Description	Cable(s)	
			Shielded or Unshielded	Length(m)
DC Power	External pwr supply out	2 wire	Unshielded	2
External pwr supply in	AC Mains	Direct plug-in	NA	NA

Note: The custom USB port was not connected during testing. Nextivity stated that this is for setup purposes and therefore would not normally be connected. The external antenna port was not connected during Tx testing.

EUT OPERATION

During emissions testing the EUT was transmitting at full power on the channel called out in the specific test, or receiving on the channel called out in the specific test.

TEST SITE**GENERAL INFORMATION**

Final test measurements were taken at the test sites listed below. Pursuant to section 2.948 of the FCC's Rules and section 3.3 of RSP-100, construction, calibration, and equipment data has been filed with the Commission and with industry Canada.

Site	Registration Numbers		Location
	FCC	Canada	
Chamber 5	211948	2845B-5	41039 Boyce Road Fremont, CA 94538-2435
Chamber 4	211948	2845B-4	

ANSI C63.4:2003 recommends that ambient noise at the test site be at least 6 dB below the allowable limits. Ambient levels are below this requirement. The test site(s) contain separate areas for radiated and conducted emissions testing. Considerable engineering effort has been expended to ensure that the facilities conform to all pertinent requirements of ANSI C63.4:2003.

CONDUCTED EMISSIONS CONSIDERATIONS

Conducted emissions testing is performed in conformance with ANSI C63.4:2003. Measurements are made with the EUT connected to the public power network through a nominal, standardized RF impedance, which is provided by a line impedance stabilization network, known as a LISN. A LISN is inserted in series with each current-carrying conductor in the EUT power cord.

RADIATED EMISSIONS CONSIDERATIONS

The FCC has determined that radiation measurements made in a shielded enclosure are not suitable for determining levels of radiated emissions. Radiated measurements are performed in an open field environment or in a semi-anechoic chamber. The test sites are maintained free of conductive objects within the CISPR defined elliptical area incorporated in ANSI C63.4:2003 guidelines and meet the Normalized Site Attenuation (NSA) requirements of ANSI C63.4:2003.

MEASUREMENT INSTRUMENTATION

RECEIVER SYSTEM

An EMI receiver as specified in CISPR 16-1-1 is used for emissions measurements. The receivers used can measure over the frequency range of 9 kHz up to 2000 MHz. These receivers allow both ease of measurement and high accuracy to be achieved. The receivers have Peak, Average, and CISPR (Quasi-peak) detectors built into their design so no external adapters are necessary. The receiver automatically sets the required bandwidth for the CISPR detector used during measurements. If the repetition frequency of the signal being measured is below 20Hz, peak measurements are made in lieu of Quasi-Peak measurements.

For measurements above the frequency range of the receivers, a spectrum analyzer is utilized because it provides visibility of the entire spectrum along with the precision and versatility required to support engineering analysis. Average measurements above 1000MHz are performed on the spectrum analyzer using the linear-average method with a resolution bandwidth of 1 MHz and a video bandwidth of 10 Hz, unless the signal is pulsed in which case the average (or video) bandwidth of the measuring instrument is reduced to onset of pulse desensitization and then increased.

INSTRUMENT CONTROL COMPUTER

The receivers utilize either a Rohde & Schwarz EZM Spectrum Monitor/Controller or contain an internal Spectrum Monitor/Controller to view and convert the receiver measurements to the field strength at an antenna or voltage developed at the LISN measurement port, which is then compared directly with the appropriate specification limit. This provides faster, more accurate readings by performing the conversions described under Sample Calculations within the Test Procedures section of this report. Results are printed in a graphic and/or tabular format, as appropriate. A personal computer is used to record all measurements made with the receivers.

The Spectrum Monitor provides a visual display of the signal being measured. In addition, the controller or a personal computer run automated data collection programs which control the receivers. This provides added accuracy since all site correction factors, such as cable loss and antenna factors are added automatically.

LINE IMPEDANCE STABILIZATION NETWORK (LISN)

Line conducted measurements utilize a fifty microhenry Line Impedance Stabilization Network as the monitoring point. The LISN used also contains a 250 uH CISPR adapter. This network provides for calibrated radio frequency noise measurements by the design of the internal low pass and high pass filters on the EUT and measurement ports, respectively.

FILTERS/ATTENUATORS

External filters and precision attenuators are often connected between the receiving antenna or LISN and the receiver. This eliminates saturation effects and non-linear operation due to high amplitude transient events.

ANTENNAS

A loop antenna is used below 30 MHz. For the measurement range 30 MHz to 1000 MHz either a combination of a biconical antenna and a log periodic or a bi-log antenna is used. Above 1000 MHz, horn antennas are used. The antenna calibration factors to convert the received voltage to an electric field strength are included with appropriate cable loss and amplifier gain factors to determine an overall site factor, which is then programmed into the test receivers or incorporated into the test software.

ANTENNA MAST AND EQUIPMENT TURNTABLE

The antennas used to measure the radiated electric field strength are mounted on a non-conductive antenna mast equipped with a motor-drive to vary the antenna height. Measurements below 30 MHz are made with the loop antenna at a fixed height of 1m above the ground plane.

ANSI C63.4:2003 specifies that the test height above ground for table mounted devices shall be 80 centimeters. Floor mounted equipment shall be placed on the ground plane if the device is normally used on a conductive floor or separated from the ground plane by insulating material from 3 to 12 mm if the device is normally used on a non-conductive floor. During radiated measurements, the EUT is positioned on a motorized turntable in conformance with this requirement.

INSTRUMENT CALIBRATION

All test equipment is regularly checked to ensure that performance is maintained in accordance with the manufacturer's specifications. All antennas are calibrated at regular intervals with respect to tuned half-wave dipoles. An exhibit of this report contains the list of test equipment used and calibration information.

TEST PROCEDURES

EUT AND CABLE PLACEMENT

The regulations require that interconnecting cables be connected to the available ports of the unit and that the placement of the unit and the attached cables simulate the worst case orientation that can be expected from a typical installation, so far as practicable. To this end, the position of the unit and associated cabling is varied within the guidelines of ANSI C63.4:2003, and the worst-case orientation is used for final measurements.

CONDUCTED EMISSIONS

Conducted emissions are measured at the plug end of the power cord supplied with the EUT. Excess power cord length is wrapped in a bundle between 30 and 40 centimeters in length near the center of the cord. Preliminary measurements are made to determine the highest amplitude emission relative to the specification limit for all the modes of operation. Placement of system components and varying of cable positions are performed in each mode. A final peak mode scan is then performed in the position and mode for which the highest emission was noted on all current carrying conductors of the power cord.

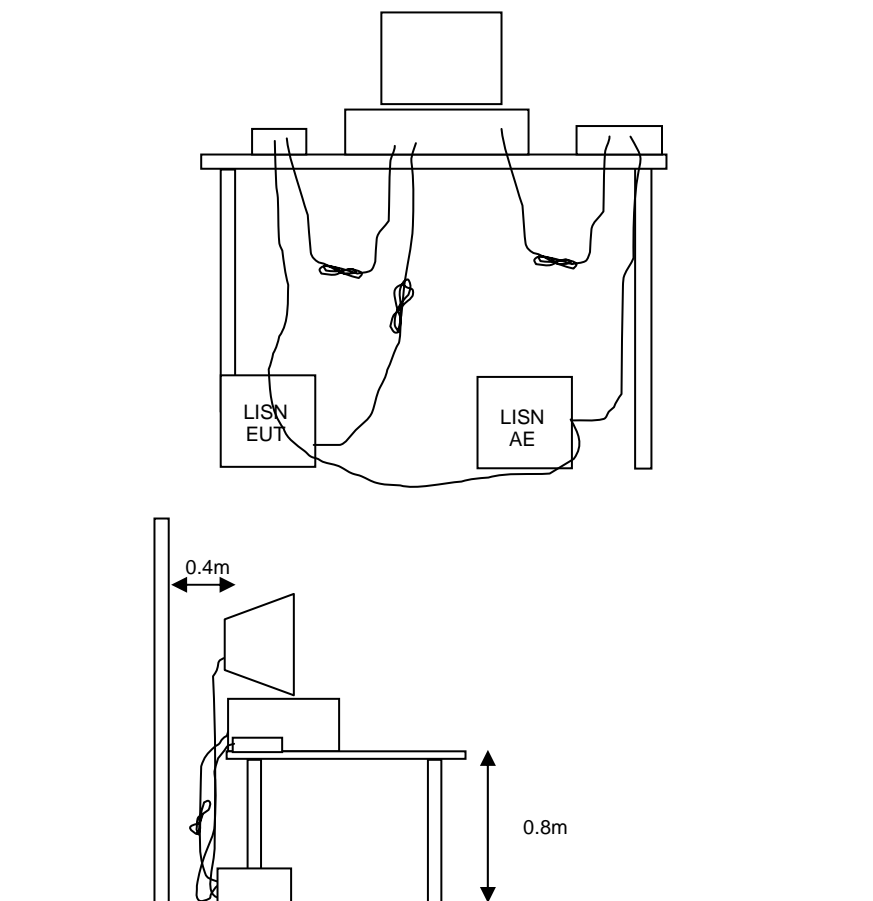

Figure 1 Typical Conducted Emissions Test Configuration

RADIATED EMISSIONS

A preliminary scan of the radiated emissions is performed in which all significant EUT frequencies are identified with the system in a nominal configuration. At least two scans are performed, one scan for each antenna polarization (horizontal and vertical; loop parallel and perpendicular to the EUT). During the preliminary scans, the EUT is rotated through 360°, the antenna height is varied (for measurements above 30 MHz) and cable positions are varied to determine the highest emission relative to the limit. Preliminary scans may be performed in a fully anechoic chamber for the purposes of identifying the frequencies of the highest emissions from the EUT.

A speaker is provided in the receiver to aid in discriminating between EUT and ambient emissions. Other methods used during the preliminary scan for EUT emissions involve scanning with near field magnetic loops, monitoring I/O cables with RF current clamps, and cycling power to the EUT.

Final maximization is a phase in which the highest amplitude emissions identified in the spectral search are viewed while the EUT azimuth angle is varied from 0 to 360 degrees relative to the receiving antenna. The azimuth, which results in the highest emission is then maintained while varying the antenna height from one to four meters (for measurements above 30 MHz, measurements below 30 MHz are made with the loop antenna at a fixed height of 1m). The result is the identification of the highest amplitude for each of the highest peaks. Each recorded level is corrected in the receiver using appropriate factors for cables, connectors, antennas, and preamplifier gain.

When testing above 18 GHz, the receive antenna is located at 1 meter from the EUT and the antenna height is restricted to a maximum of 2.5 meters.

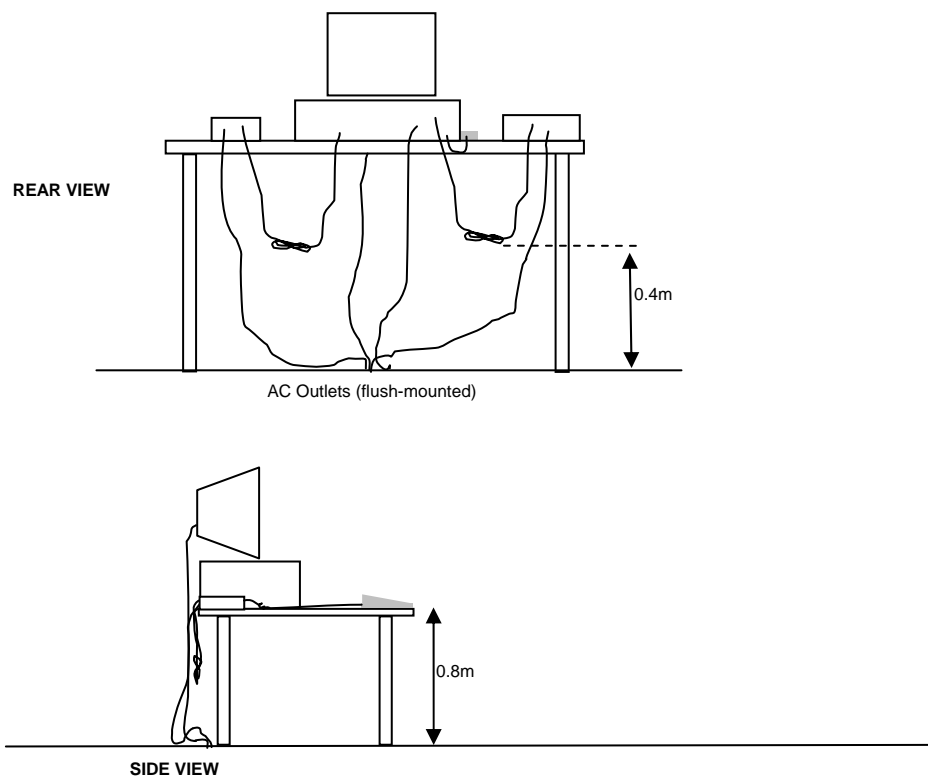

Typical Test Configuration for Radiated Field Strength Measurements

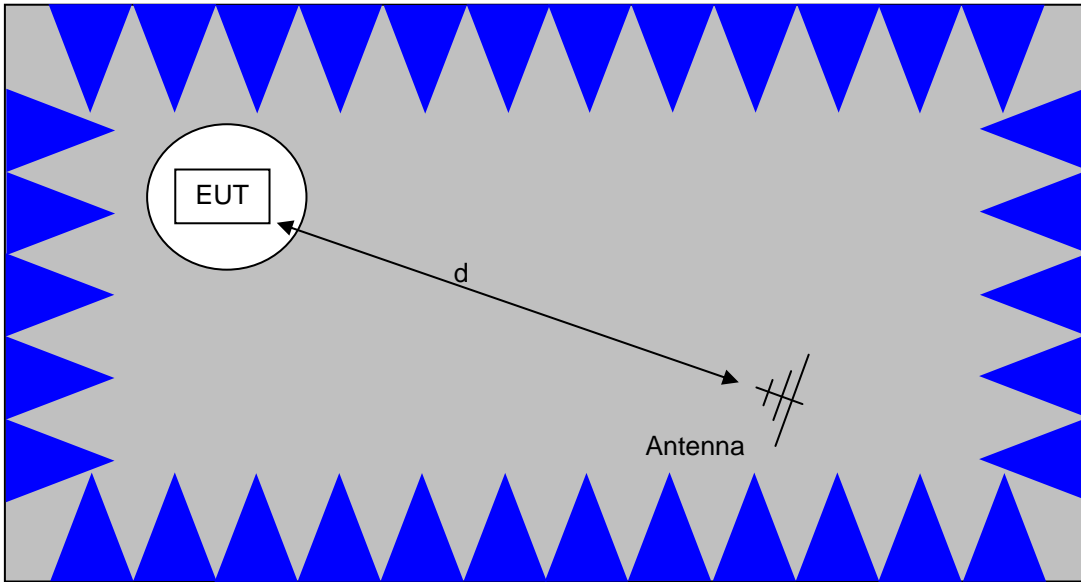

The anechoic materials on the walls and ceiling ensure compliance with the normalized site attenuation requirements of CISPR 16 / CISPR 22 / ANSI C63.4 for an alternate test site at the measurement distances used.

Floor-standing equipment is placed on the floor with insulating supports between the unit and the ground plane.

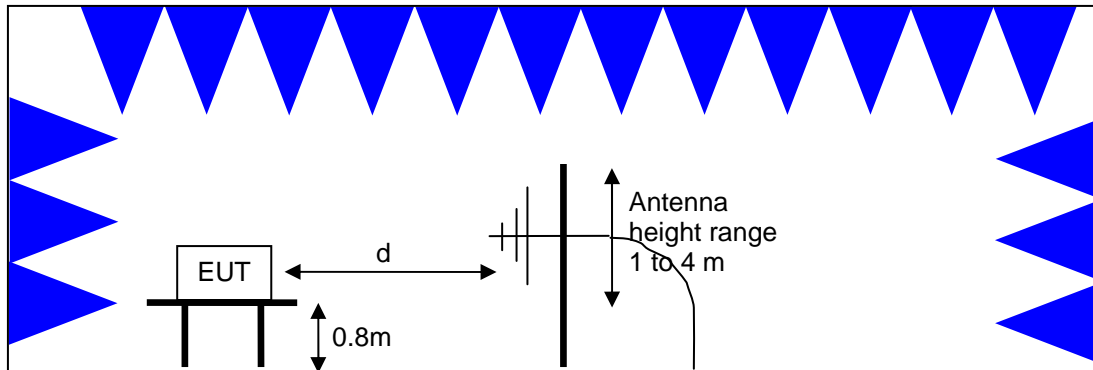

Test Configuration for Radiated Field Strength Measurements
Semi-Anechoic Chamber, Plan and Side Views

CONDUCTED EMISSIONS FROM ANTENNA PORT

Direct measurements of power, bandwidth and power spectral density are performed, where possible, with the antenna port of the EUT connected to either the power meter or spectrum analyzer via a suitable attenuator and/or filter. These are used to ensure that the front end of the measurement instrument is not overloaded by the fundamental transmission.

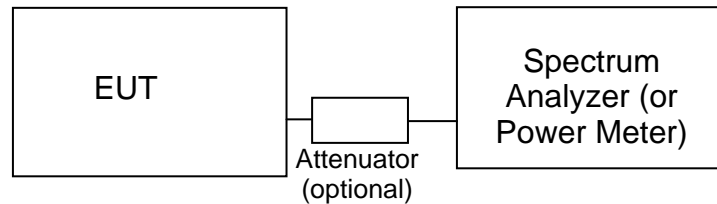
**Test Configuration for Antenna Port Measurements**

Measurement bandwidths (video and resolution) are set in accordance with the relevant standards and Elliott's test procedures for the type of radio being tested. When power measurements are made using a resolution bandwidth less than the signal bandwidth the power is calculated by summing the power across the signal bandwidth using either the analyzer channel power function or by capturing the trace data and calculating the power using software. In both cases the summed power is corrected to account for the equivalent noise bandwidth (ENBW) of the resolution bandwidth used.

If power averaging is used (typically for certain digital modulation techniques), the EUT is configured to transmit continuously. Power averaging is performed using either the built-in function of the analyzer or, if the analyzer does not feature power averaging, using external software. In both cases the average power is calculated over a number of sweeps (typically 100). When the EUT cannot be configured to continuously transmit then either the analyzer is configured to perform a gated sweep to ensure that the power is averaged over periods that the device is transmitting or power averaging is disabled and a max-hold feature is used.

If a power meter is used to make output power measurements the sensor head type (peak or average) is stated in the test data table.

BANDWIDTH MEASUREMENTS

The 6dB, 20dB and/or 26dB signal bandwidth is measured in using the bandwidths recommended by ANSI C63.4. When required, the 99% bandwidth is measured using the methods detailed in RSS GEN.

SPECIFICATION LIMITS AND SAMPLE CALCULATIONS

The limits for conducted emissions are given in units of microvolts, and the limits for radiated emissions are given in units of microvolts per meter at a specified test distance. Data is measured in the logarithmic form of decibels relative to one microvolt, or dB microvolts (dBuV). For radiated emissions, the measured data is converted to the field strength at the antenna in dB microvolts per meter (dBuV/m). The results are then converted to the linear forms of uV and uV/m for comparison to published specifications.

For reference, converting the specification limits from linear to decibel form is accomplished by taking the base ten logarithm, then multiplying by 20. These limits in both linear and logarithmic form are as follows:

CONDUCTED EMISSIONS SPECIFICATION LIMITS: FCC 15.207; FCC 15.107(a), RSS GEN

The table below shows the limits for the emissions on the AC power line from an intentional radiator and a receiver.

Frequency (MHz)	Average Limit (dBuV)	Quasi Peak Limit (dBuV)
0.150 to 0.500	Linear decrease on logarithmic frequency axis between 56.0 and 46.0	Linear decrease on logarithmic frequency axis between 66.0 and 56.0
0.500 to 5.000	46.0	56.0
5.000 to 30.000	50.0	60.0

GENERAL TRANSMITTER RADIATED EMISSIONS SPECIFICATION LIMITS

The table below shows the limits for the spurious emissions from transmitters that fall in restricted bands² (with the exception of transmitters operating under FCC Part 15 Subpart D and RSS 210 Annex 9), the limits for all emissions from a low power device operating under the general rules of RSS 310 (tables 3 and 4), RSS 210 (table 2) and FCC Part 15 Subpart C section 15.209.

Frequency Range (MHz)	Limit (uV/m)	Limit (dBuV/m @ 3m)
0.009-0.490	2400/F _{KHz} @ 300m	67.6-20*log ₁₀ (F _{KHz}) @ 300m
0.490-1.705	24000/F _{KHz} @ 30m	87.6-20*log ₁₀ (F _{KHz}) @ 30m
1.705 to 30	30 @ 30m	29.5 @ 30m
30 to 88	100 @ 3m	40 @ 3m
88 to 216	150 @ 3m	43.5 @ 3m
216 to 960	200 @ 3m	46.0 @ 3m
Above 960	500 @ 3m	54.0 @ 3m

RECEIVER RADIATED SPURIOUS EMISSIONS SPECIFICATION LIMITS

The table below shows the limits for the spurious emissions from receivers as detailed in FCC Part 15.109, RSS 210 Table 2, RSS GEN Table 1 and RSS 310 Table 3. Note that receivers operating outside of the frequency range 30 MHz – 960 MHz are exempt from the requirements of 15.109.

Frequency Range (MHz)	Limit (uV/m @ 3m)	Limit (dBuV/m @ 3m)
30 to 88	100	40
88 to 216	150	43.5
216 to 960	200	46.0
Above 960	500	54.0

² The restricted bands are detailed in FCC 15.203, RSS 210 Table 1 and RSS 310 Table 2

FCC 15.407 (a) OUTPUT POWER LIMITS

The table below shows the limits for output power and output power density. Where the signal bandwidth is less than 20 MHz the maximum output power is reduced to the power spectral density limit plus 10 times the log of the bandwidth (in MHz).

Operating Frequency (MHz)	Output Power	Power Spectral Density
5150 – 5250	50mW (17 dBm)	4 dBm/MHz
5250 – 5350	250 mW (24 dBm)	11 dBm/MHz
5725 – 5825	1 Watts (30 dBm)	17 dBm/MHz

For system using antennas with gains exceeding 6dBi, the output power and power spectral density limits are reduced by 1dB for every dB the antenna gain exceeds 6dBi. Fixed point-to-point applications using the 5725 – 5825 MHz band may use antennas with gains of up to 23dBi without this limitation. If the gain exceeds 23dBi then the output power limit of 1 Watt is reduced by 1dB for every dB the gain exceeds 23dBi.

The peak excursion envelope is limited to 13dB.

OUTPUT POWER LIMITS –LELAN DEVICES

The table below shows the limits for output power and output power density defined by RSS 210. Where the signal bandwidth is less than 20 MHz the maximum output power is reduced to the power spectral density limit plus 10 times the log of the bandwidth (in MHz).

Operating Frequency (MHz)	Output Power	Power Spectral Density
5150 – 5250	200mW (23 dBm) eirp	10 dBm/MHz eirp
5250 – 5350	250 mW (24 dBm) ³ 1W (30dBm) eirp	11 dBm/MHz
5470 – 5725	250 mW (24 dBm) ⁴ 1W (30dBm) eirp	11 dBm/MHz
5725 – 5825	1 Watts (30 dBm) 4W eirp	17 dBm/MHz

In addition, the power spectral density limit shall be reduced by 1dB for every dB the highest power spectral density exceeds the “average” power spectral density) by more than 3dB. The “average” power spectral density is determined by dividing the output power by $10\log(\text{EBW})$ where EBW is the 99% power bandwidth.

Fixed point-to-point applications using the 5725 – 5825 MHz band may use antennas with gains of up to 23dBi without this limitation. If the gain exceeds 23dBi then the output power limit of 1 Watt is reduced by 1dB for every dB the gain exceeds 23dBi.

³ If EIRP exceeds 500mW the device must employ TPC

⁴ If EIRP exceeds 500mW the device must employ TPC

SPURIOUS EMISSIONS LIMITS –UNII and LELAN DEVICES

The spurious emissions limits for signals below 1GHz are the FCC/RSS-GEN general limits. For emissions above 1GHz, signals in restricted bands are subject to the FCC/RSS GEN general limits. All other signals have a limit of -27dBm/MHz , which is a field strength of 68.3dBuV/m/MHz at a distance of 3m. This is an average limit so the peak value of the emission may not exceed -7dBm/MHz (88.3dBuV/m/MHz at a distance of 3m). For devices operating in the 5725-5850Mhz bands under the LELAN/UNII rules, the limit within 10Mhz of the allocated band is increased to -17dBm/MHz .

SAMPLE CALCULATIONS - CONDUCTED EMISSIONS

Receiver readings are compared directly to the conducted emissions specification limit (decibel form) as follows:

$$R_r - S = M$$

where:

R_r = Receiver Reading in dBuV

S = Specification Limit in dBuV

M = Margin to Specification in +/- dB

SAMPLE CALCULATIONS - RADIATED EMISSIONS

Receiver readings are compared directly to the specification limit (decibel form). The receiver internally corrects for cable loss, preamplifier gain, and antenna factor. The calculations are in the reverse direction of the actual signal flow, thus cable loss is added and the amplifier gain is subtracted. The Antenna Factor converts the voltage at the antenna coaxial connector to the field strength at the antenna elements.

A distance factor, when used for electric field measurements above 30MHz, is calculated by using the following formula:

$$F_d = 20 * \text{LOG}_{10} (D_m/D_s)$$

where:

F_d = Distance Factor in dB

D_m = Measurement Distance in meters

D_s = Specification Distance in meters

For electric field measurements below 30MHz the extrapolation factor is either determined by making measurements at multiple distances or a theoretical value is calculated using the formula:

$$F_d = 40 * \text{LOG}_{10} (D_m/D_s)$$

Measurement Distance is the distance at which the measurements were taken and Specification Distance is the distance at which the specification limits are based. The antenna factor converts the voltage at the antenna coaxial connector to the field strength at the antenna elements.

The margin of a given emission peak relative to the limit is calculated as follows:

$$R_c = R_r + F_d$$

and

$$M = R_c - L_s$$

where:

$$R_r = \text{Receiver Reading in dBuV/m}$$

$$F_d = \text{Distance Factor in dB}$$

$$R_c = \text{Corrected Reading in dBuV/m}$$

$$L_s = \text{Specification Limit in dBuV/m}$$

$$M = \text{Margin in dB Relative to Spec}$$

SAMPLE CALCULATIONS - FIELD STRENGTH TO EIRP CONVERSION

Where the radiated electric field strength is expressed in terms of the equivalent isotropic radiated power (eirp), or where a field strength measurement of output power is made in lieu of a direct measurement, the following formula is used to convert between eirp and field strength at a distance of d (meters) from the equipment under test:

$$E = \frac{1000000 \sqrt{30 P}}{d} \quad \text{microvolts per meter}$$

where P is the eirp (Watts)

For a measurement at 3m the conversion from a logarithmic value for field strength (dBuV/m) to an eirp power (dBm) is -95.3dB.

Appendix A Test Equipment Calibration Data**Conducted Emissions - AC Power Ports, 20-Mar-12**

<u>Manufacturer</u>	<u>Description</u>	<u>Model</u>	<u>Asset #</u>	<u>Cal Due</u>
Rohde & Schwarz	Pulse Limiter	ESH3 Z2	1401	4/21/2012
Fischer Custom Comm	LISN, 25A, 150kHz to 30MHz, 25 Amp,	FCC-LISN-50-25-2- 09	2000	10/18/2012
Rohde & Schwarz	EMI Test Receiver, 20 Hz-40 GHz	ESIB40 (1088.7490.40)	2493	12/9/2012

Radiated Emissions, 1000 - 18,000 MHz, 06-Apr-12

<u>Manufacturer</u>	<u>Description</u>	<u>Model</u>	<u>Asset #</u>	<u>Cal Due</u>
Rohde & Schwarz	EMI Test Receiver, 20 Hz-7 GHz	ESIB7	1538	12/6/2012
EMCO	Antenna, Horn, 1-18 GHz	3115	1561	6/22/2012
Micro-Tronics	Band Reject Filter, 5470-5725 MHz	BRC50704-02	1730	8/5/2012
Hewlett Packard	Microwave Preamplifier, 1- 26.5GHz	8449B	2199	2/23/2013
Hewlett Packard	SpecAn 9 kHz - 40 GHz, (SA40) Purple	8564E (84125C)	2415	7/28/2012

Radiated Power, 06-Apr-12

<u>Manufacturer</u>	<u>Description</u>	<u>Model #</u>	<u>Asset #</u>	<u>Cal Due</u>
Rohde & Schwarz	EMI Test Receiver, 20 Hz-7 GHz	ESIB7	1538	06-Dec-12
EMCO	Antenna, Horn, 1-18 GHz	3115	1561	22-Jun-12

Appendix B Test Data

T86797 Pages 25 –44



EMC Test Data

Client:	Nextivity Inc	Job Number:	J86441
Model:	CELF1-RS225CU & CELFI-RS225WU	T-Log Number:	T86797
		Account Manager:	Sheareen Washington
Contact:	Steve van Skike		-
Emissions Standard(s):	FCC 15B & 15E, RSS-210	Class:	-
Immunity Standard(s):	-	Environment:	-

EMC Test Data

For The

Nextivity Inc

Model

CELF1-RS225CU & CELFI-RS225WU

Date of Last Test: 4/11/2012

Client: Nextivity Inc	Job Number: J86441
Model: CELFI-RS225CU & CELFI-RS225WU	T-Log Number: T86797
	Account Manager: Sheareen Washington
Contact: Steve van Skike	
Standard: FCC 15B & 15E, RSS-210	Class: N/A

Run #1: Bandwidth, Output Power and Power Spectral Density - Single Chain Systems

Note 1:	Output power measured using a spectrum analyzer (see plots below). RBW=1MHz, VB=3 MHz, # of points in sweep \geq 2*span/RBW, sample detector, power averaging on (transmitted signal was continuous) and power integration over 50MHz (method SA-1 of KDB 789033).
Note 2:	Measured using the same analyzer settings used for output power.
Note 3:	For RSS-210 the limit for the 5150 - 5250 MHz band accounts for the antenna gain as the maximum eirp allowed is 10dBm/MHz. The limits are also corrected for instances where the highest measured value of the PSD exceeds the average PSD (calculated from the measured power divided by the measured 99% bandwidth) by more than 3dB by the amount that the measured value exceeds the average by more than 3dB.
Note 4:	99% Bandwidth measured in accordance with RSS GEN - RB > 1% of span and VB \geq 3xRB

Single Chain Operation, 5470- 5725 MHz Band

Antenna Gain (dBi): 5.5 EIRP: 406.0 mW 26.1 dBm

Frequency (MHz)	Software Setting	Bandwidth		Output Power ¹ dBm		Power (Watts)	PSD ² dBm/MHz			Result
		26dB	99% ⁴	Measured	Limit		Measured	FCC Limit	RSS Limit ³	
5525	Max	36.4	26.7	17.9	24.0	0.062	4.7	11.0	11.0	Pass
5580	Max	30.6	26.3	19.4	24.0	0.087	6.7	11.0	11.0	Pass
5670	Max	36.6	26.5	20.6	24.0	0.114	8.1	11.0	11.0	Pass

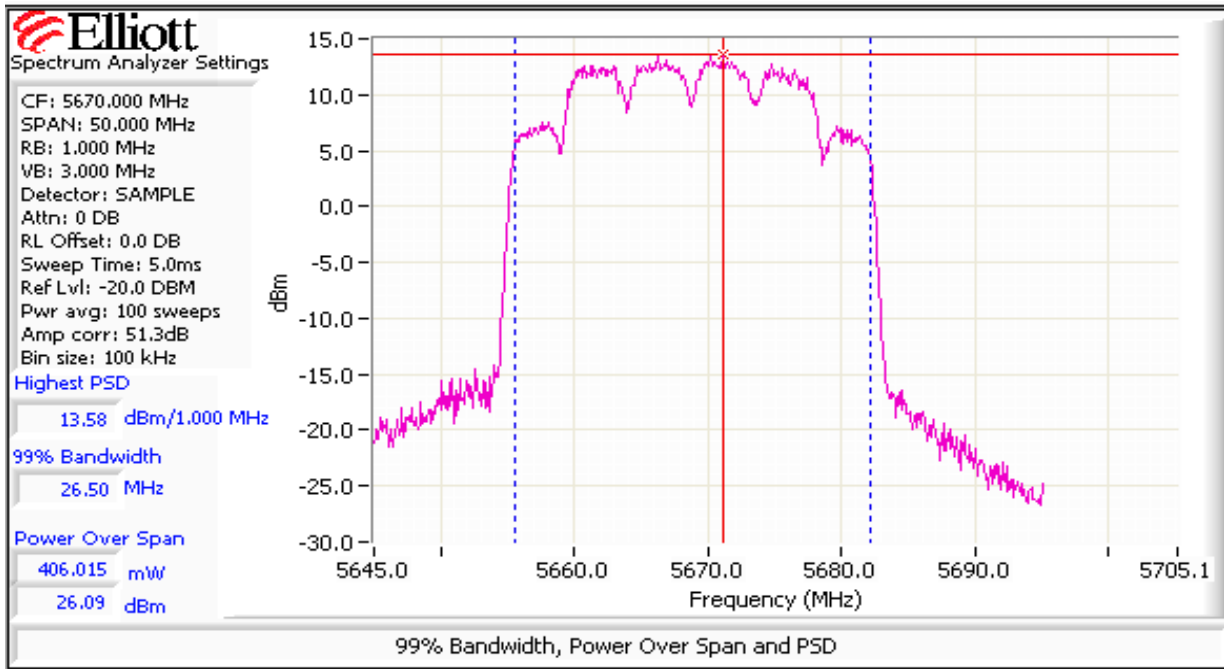

Client: Nextivity Inc	Job Number: J86441
Model: CELFI-RS225CU & CELFI-RS225WU	T-Log Number: T86797
Contact: Steve van Skike	Account Manager: Sheareen Washington
Standard: FCC 15B & 15E, RSS-210	Class: N/A

Run #2: Peak Excursion Measurement

20MHz: Device meets the requirement for the peak excursion

Freq (MHz)	Peak Excursion(dB) Value	Peak Excursion(dB) Limit	Freq (MHz)	Peak Excursion(dB) Value	Peak Excursion(dB) Limit	Freq (MHz)	Peak Excursion(dB) Value	Peak Excursion(dB) Limit
5525	11.8	13.0	5580	11.6	13.0	5670	11.3	13.0

Plots Showing Peak Excursion

Trace A: RBW = 1MHz, VBW = 3MHz, Peak hold

Trace B: Same settings as used for power/PSD measurements (RBW = 1 MHz, VBW = 3MHz, Integrated average power)

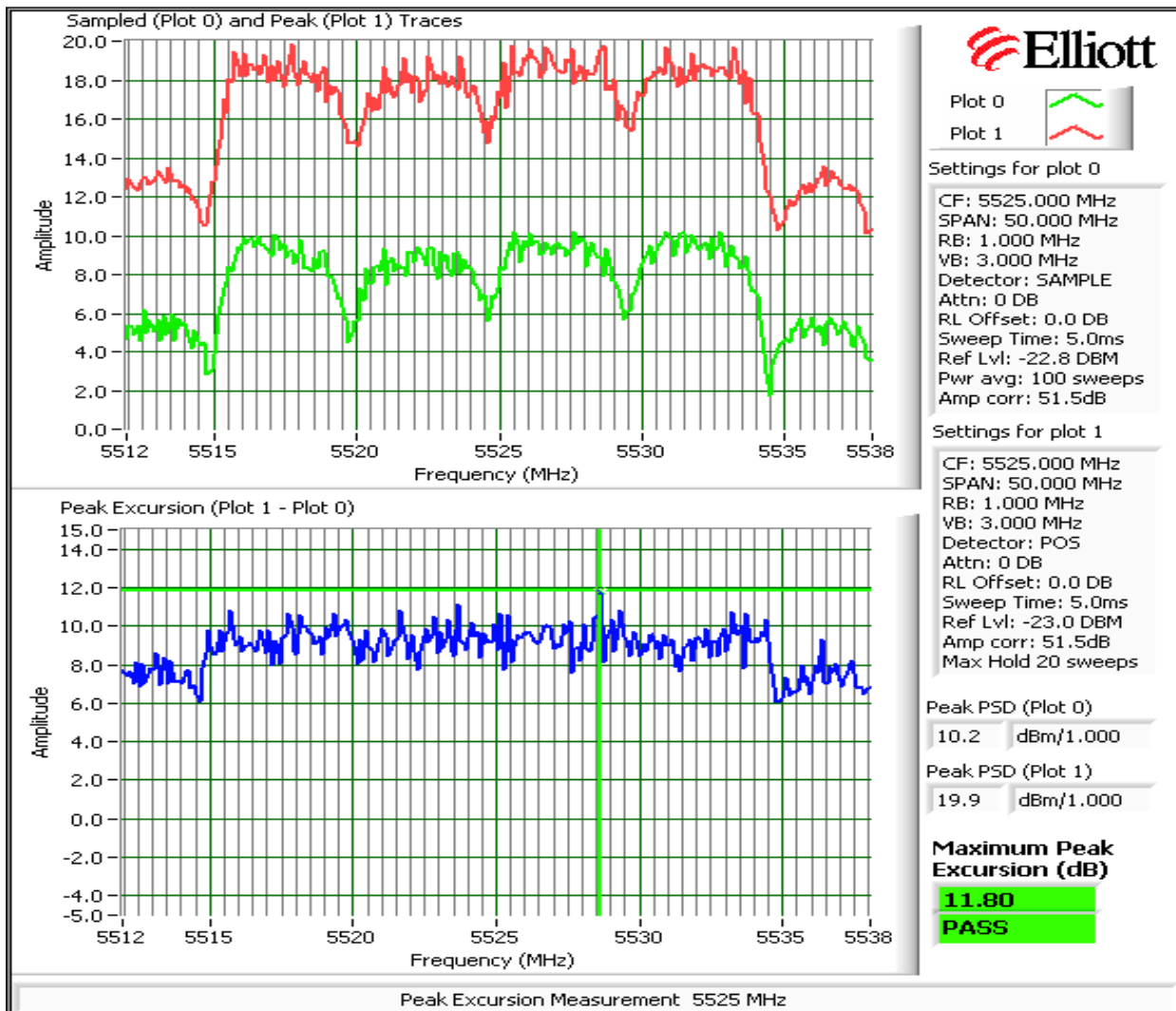

Client:	Nextivity Inc	Job Number:	J86441
Model:	CELFI-RS225CU & CELFI-RS225WU	T-Log Number:	T86797
		Account Manager:	Sheareen Washington
Contact:	Steve van Skike		
Standard:	FCC 15B & 15E, RSS-210	Class:	N/A

RSS 210 and FCC 15.407 (UNII) Radiated Spurious Emissions

Test Specific Details

Objective: The objective of this test session is to perform final qualification testing of the EUT with respect to the specification listed above.

Date of Test: 4/6/2012 0:00
 Test Engineer: Rafael Varelas
 Test Location: Fremont Chamber #4

Config. Used: 1
 Config Change: None
 EUT Voltage: 120V/60Hz

General Test Configuration

The EUT and all local support equipment were located on the turntable for radiated spurious emissions testing.

For radiated emissions testing the measurement antenna was located 3 meters from the EUT.

Ambient Conditions:

Temperature: 20.6 °C
 Rel. Humidity: 33 %

Summary of Results

Run #	Mode	Channel	Power Setting	Measured Power	Test Performed	Limit	Result / Margin
1 5470-5725	Proprietary	Low 5525 MHz	Max	-	Restricted Band Edge at 5460 MHz	15.209	51.5dBµV/m @ 5455.2MHz (-2.5dB)
				-	Band Edge 5460 - 5470 MHz	15E	65.1 dBµV/m @ 5469.7 MHz (-3.2 dB)
				-	Radiated Emissions, 30 MHz - 40 GHz	FCC 15.209 / 15 E	No significant emissions observed
		-		Radiated Emissions, 1 - 40 GHz	FCC 15.209 / 15 E	46.1dBµV/m @ 11160.5MHz (-7.9dB)	
		-		Band Edge 5725MHz	15E	64.9 dBµV/m @ 5725.0 MHz (-3.4 dB)	
		-		Radiated Emissions, 1 - 40 GHz	FCC 15.209 / 15 E	50.6dBµV/m @ 11338.6MHz (-3.4dB)	

Modifications Made During Testing

No modifications were made to the EUT during testing

Deviations From The Standard

No deviations were made from the requirements of the standard.

Client:	Nextivity Inc	Job Number:	J86441
Model:	CELFI-RS225CU & CELFI-RS225WU	T-Log Number:	T86797
		Account Manager:	Sheareen Washington
Contact:	Steve van Skike		
Standard:	FCC 15B & 15E, RSS-210	Class:	N/A

Test Procedure Comments:

Unless otherwise noted, average measurements above 1GHz were performed as documented in FCC KDB 789033 G) 6) d) Method VB

Antenna: connected.
Duty Cycle: 100%

Client:	Nextivity Inc	Job Number:	J86441
Model:	CELF-RS225CU & CELF-RS225WU	T-Log Number:	T86797
Contact:	Steve van Skike	Account Manager:	Sheareen Washington
Standard:	FCC 15B & 15E, RSS-210	Class:	N/A

Run #1, Radiated Spurious Emissions, 30 - 40,000 MHz. Operation in the 5470-5725 MHz Band

Date of Test: 4/6/2012
 Test Engineer: Rafael Varelas
 Test Location: FT4

Run #1a: Low Channel @ 5525 MHz

5350-5460 MHz Restricted Band Edge Signal Radiated Field Strength

Frequency	Level	Pol	FCC 15.209		Detector	Azimuth	Height	Comments
MHz	dB μ V/m	v/h	Limit	Margin	Pk/QP/Avg	degrees	meters	
5455.200	51.5	V	54.0	-2.5	AVG	55	1.0	RB 1 MHz;VB 10 Hz;Pk
5454.730	62.6	V	74.0	-11.4	PK	55	1.0	RB 1 MHz;VB 3 MHz;Pk
5456.200	46.8	H	54.0	-7.2	AVG	200	1.1	RB 1 MHz;VB 10 Hz;Pk
5450.870	57.8	H	74.0	-16.2	PK	200	1.1	RB 1 MHz;VB 3 MHz;Pk

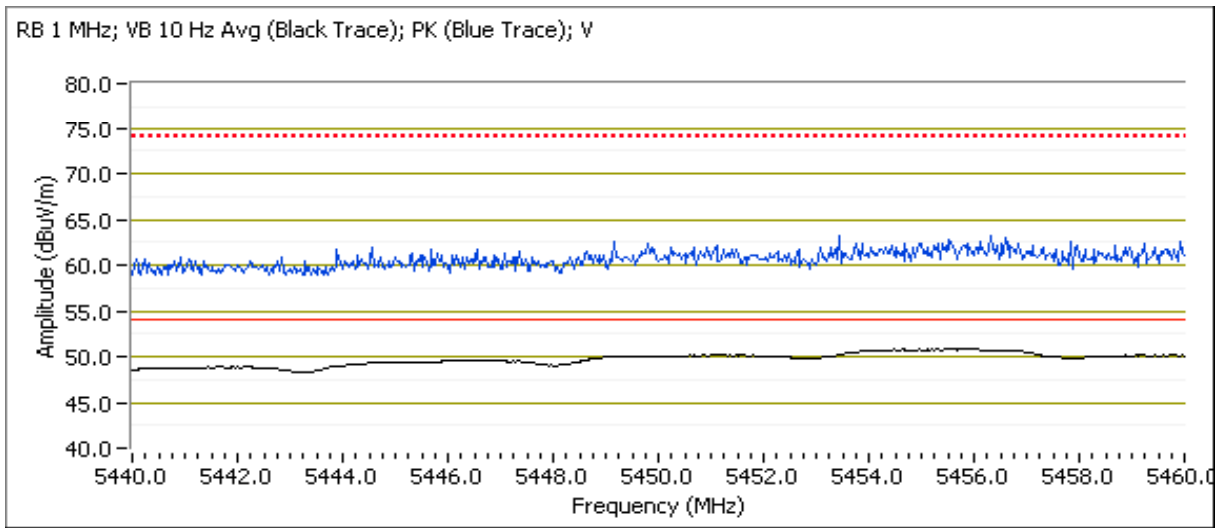

Client:	Nextivity Inc	Job Number:	J86441
Model:	CELFI-RS225CU & CELFI-RS225WU	T-Log Number:	T86797
Contact:	Steve van Skike	Account Manager:	Sheareen Washington
Standard:	FCC 15B & 15E, RSS-210	Class:	N/A

Date of Test: 4/11/2012
 Test Engineer: John Caizzi
 Test Location: FT3

5460-5470 MHz Restricted Band Edge Radiated Field Strength

Frequency MHz	Level dB μ V/m	Pol v/h	FCC 15.209		Detector Pk/QP/Avg	Azimuth degrees	Height meters	Comments
			Limit	Margin				
5469.680	65.1	V	68.3	-3.2	PK	333	1.30	
5468.820	58.2	H	68.3	-10.1	PK	205	1.32	

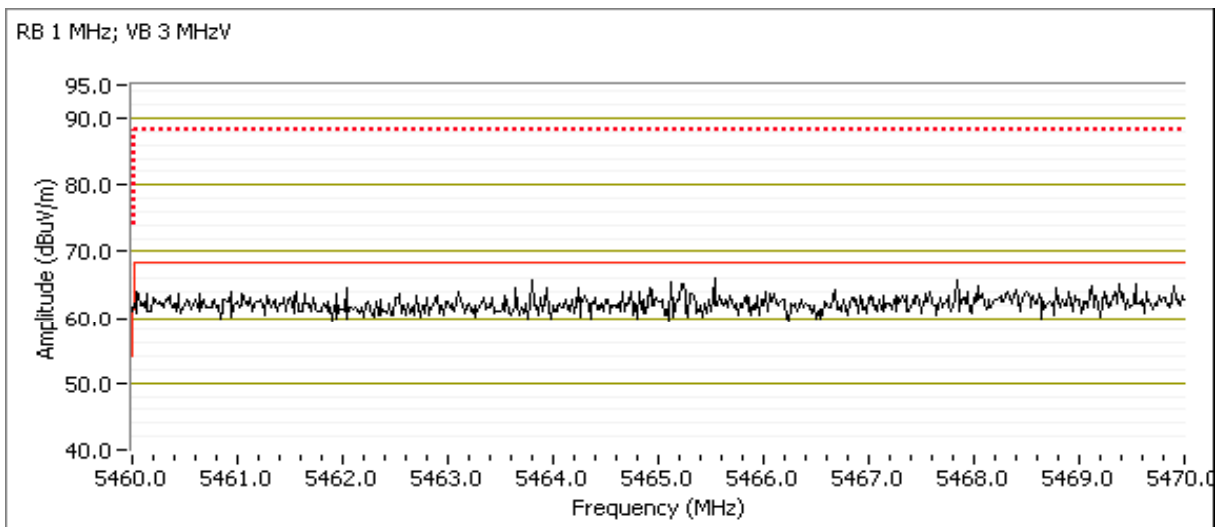

Client:	Nextivity Inc	Job Number:	J86441
Model:	CELF1-RS225CU & CELF1-RS225WU	T-Log Number:	T86797
Contact:	Steve van Skike	Account Manager:	Sheareen Washington
Standard:	FCC 15B & 15E, RSS-210	Class:	N/A

Spurious Radiated Emissions:

Frequency	Level	Pol	15.209 / 15E		Detector	Azimuth	Height	Comments
MHz	dB μ V/m	v/h	Limit	Margin	PK/QP/Avg	degrees	meters	
No emissions observed above the noise floor								

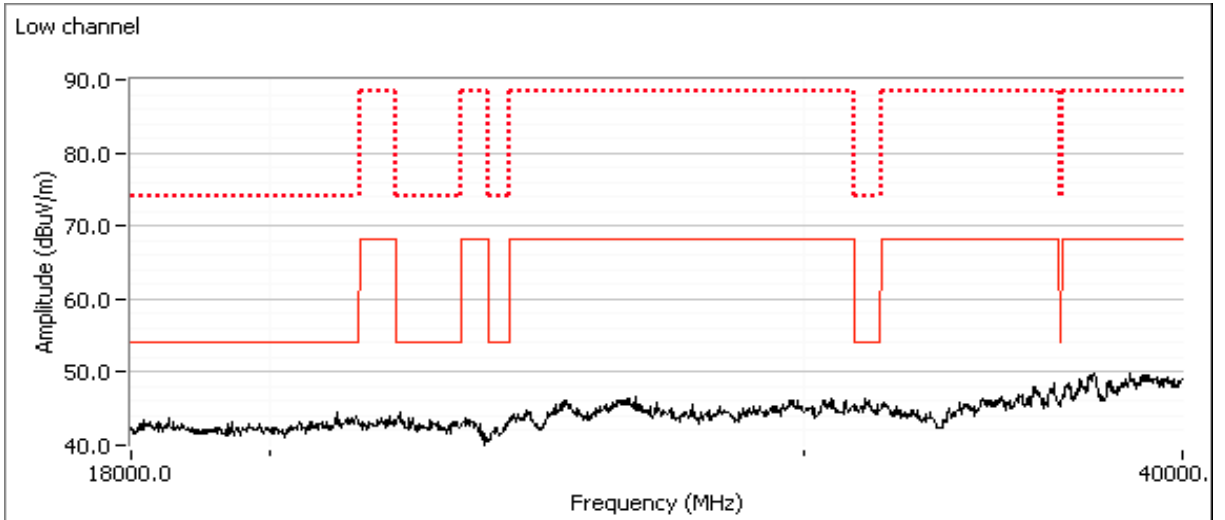
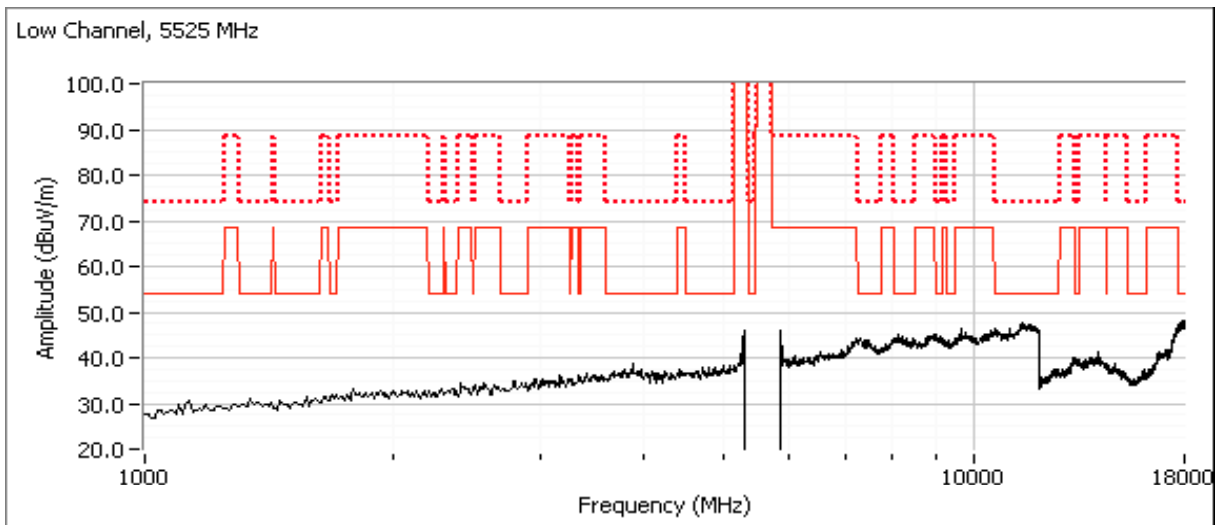

Client:	Nextivity Inc	Job Number:	J86441
Model:	CELFI-RS225CU & CELFI-RS225WU	T-Log Number:	T86797
		Account Manager:	Sheareen Washington
Contact:	Steve van Skike		
Standard:	FCC 15B & 15E, RSS-210	Class:	N/A

Date of Test: 4/25/2012
 Test Engineer: Conrad Chu
 Test Location: FT7

Preliminary readings

Frequency MHz	Level dB μ V/m	Pol v/h	FCC 15.209		Detector Pk/QP/Avg	Azimuth degrees	Height meters	Comments
			Limit	Margin				
48.628	26.2	V	40.0	-13.8	QP	23	1.0	QP (1.00s)
127.695	16.3	H	43.5	-27.2	QP	52	2.3	QP (1.00s)
90.511	15.0	H	43.5	-28.5	QP	82	2.5	QP (1.00s)
60.438	21.5	V	40.0	-18.5	QP	111	1.4	QP (1.00s)
69.461	21.0	V	40.0	-19.0	QP	189	1.0	QP (1.00s)
40.721	33.6	V	40.0	-6.4	QP	313	1.1	QP (1.00s)

Maximized readings

Frequency MHz	Level dB μ V/m	Pol v/h	FCC 15.209		Detector Pk/QP/Avg	Azimuth degrees	Height meters	Comments
			Limit	Margin				
40.721	33.7	V	40.0	-6.3	QP	305	1.0	QP (1.00s)
48.628	27.8	V	40.0	-12.2	QP	23	1.0	QP (1.00s)
60.438	21.5	V	40.0	-18.5	QP	111	1.4	QP (1.00s)
69.461	21.0	V	40.0	-19.0	QP	189	1.0	QP (1.00s)
127.695	16.9	H	43.5	-26.6	QP	64	2.5	QP (1.00s)
90.511	15.0	H	43.5	-28.5	QP	82	2.5	QP (1.00s)

Note 1: No emissions related to the transmitter were observed between 30 and 1000 MHz.

Client:	Nextivity Inc	Job Number:	J86441
Model:	CELFI-RS225CU & CELFI-RS225WU	T-Log Number:	T86797
Contact:	Steve van Skike	Account Manager:	Sheareen Washington
Standard:	FCC 15B & 15E, RSS-210	Class:	N/A

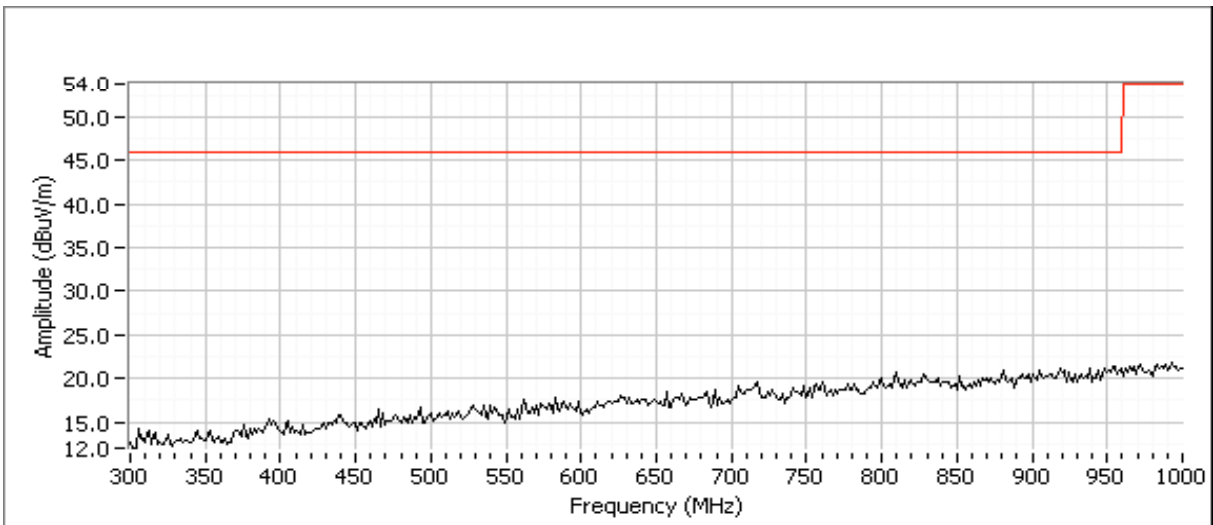
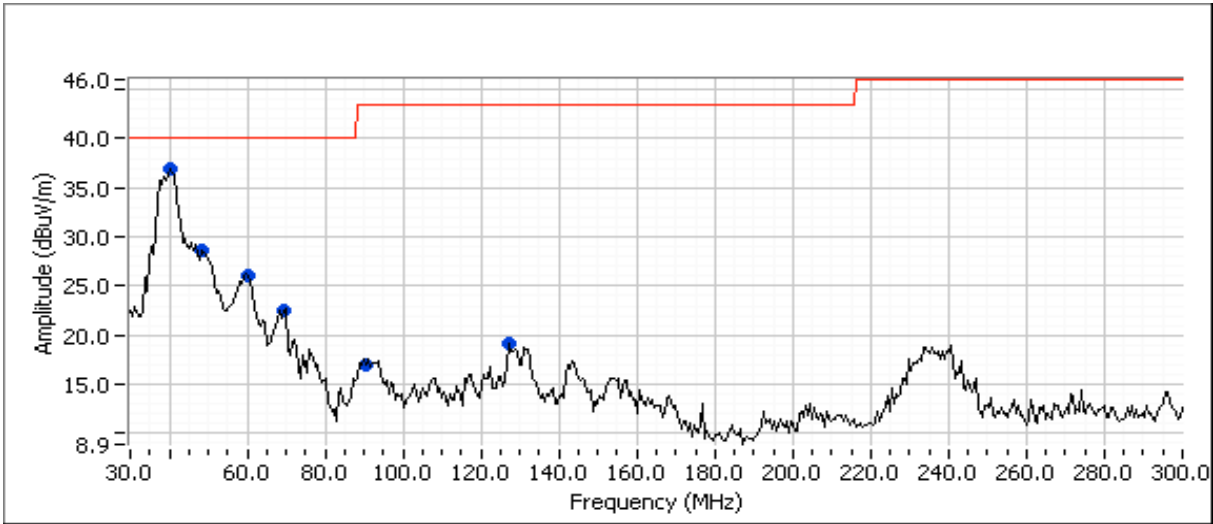

Client:	Nextivity Inc	Job Number:	J86441
Model:	CELFI-RS225CU & CELFI-RS225WU	T-Log Number:	T86797
Contact:	Steve van Skike	Account Manager:	Sheareen Washington
Standard:	FCC 15B & 15E, RSS-210	Class:	N/A

Run #1b: Center Channel @ 5580 MHz

Spurious Radiated Emissions:

Frequency MHz	Level dB μ V/m	Pol v/h	15.209 / 15E		Detector Pk/QP/Avg	Azimuth degrees	Height meters	Comments
			Limit	Margin				
11160.490	46.1	V	54.0	-7.9	AVG	181	1.1	RB 1 MHz;VB 10 Hz;Pk
11160.890	57.8	V	74.0	-16.2	PK	181	1.1	RB 1 MHz;VB 3 MHz;Pk

- Note 1: For emissions in restricted bands, the limit of 15.209 was used which requires average and peak measurements.
- Note 2: For emissions outside of the restricted bands the limit is -27dBm/MHz eirp (68.3dBuV/m). The measurement method required is a peak measurement (RB=1MHz, VB \geq 3MHz, peak detector).

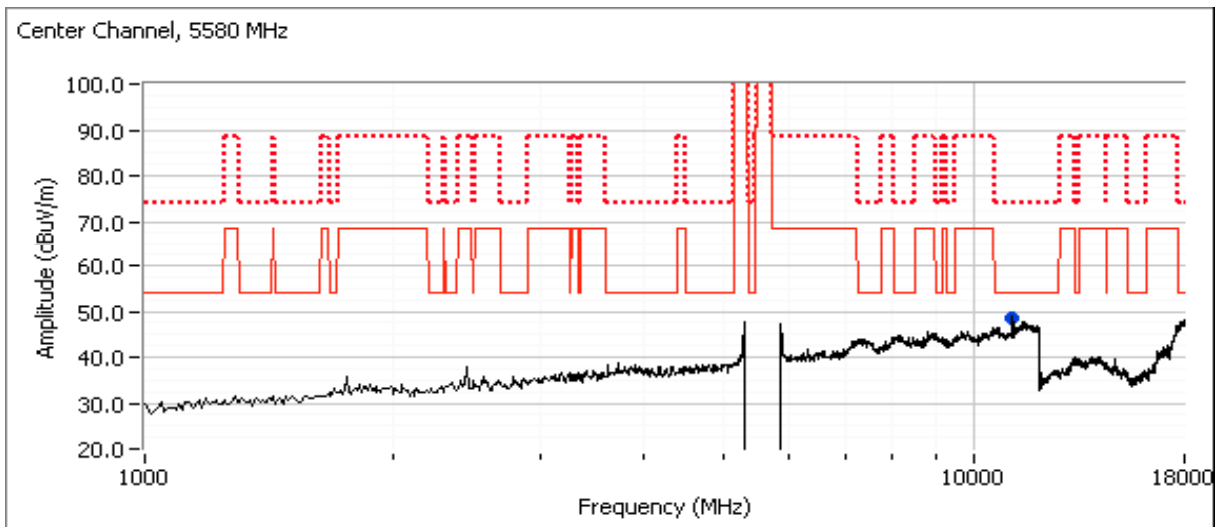

Client:	Nextivity Inc	Job Number:	J86441
Model:	CELFI-RS225CU & CELFI-RS225WU	T-Log Number:	T86797
Contact:	Steve van Skike	Account Manager:	Sheareen Washington
Standard:	FCC 15B & 15E, RSS-210	Class:	N/A

Run #1c: High Channel

Spurious Radiated Emissions:

Frequency MHz	Level dB μ V/m	Pol v/h	15.209 / 15E		Detector Pk/QP/Avg	Azimuth degrees	Height meters	Comments
			Limit	Margin				
11338.550	50.6	V	54.0	-3.4	AVG	257	1.2	RB 1 MHz;VB 10 Hz;Pk
11338.550	62.5	V	74.0	-11.5	PK	257	1.2	RB 1 MHz;VB 3 MHz;Pk

Note 1: For emissions in restricted bands, the limit of 15.209 was used which requires average and peak measurements.

Note 2: For emissions outside of the restricted bands the limit is -27dBm/MHz eirp (68.3dBuV/m). The measurement method required is a peak measurement (RB=1MHz, VB \geq 3MHz, peak detector).

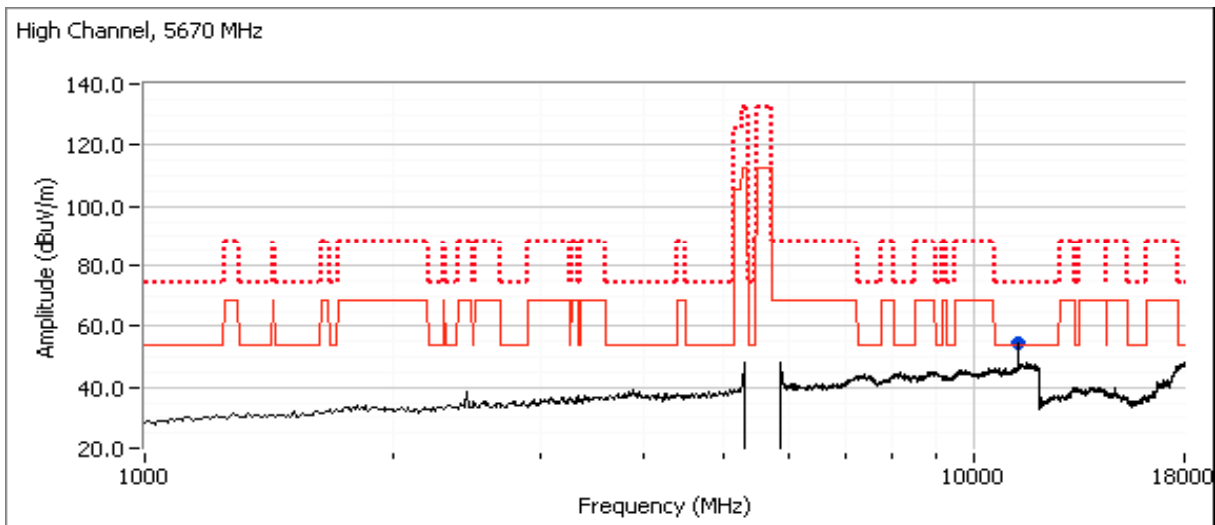

Client:	Nextivity Inc	Job Number:	J86441
Model:	CELFI-RS225CU & CELFI-RS225WU	T-Log Number:	T86797
Contact:	Steve van Skike	Account Manager:	Sheareen Washington
Standard:	FCC 15B & 15E, RSS-210	Class:	N/A

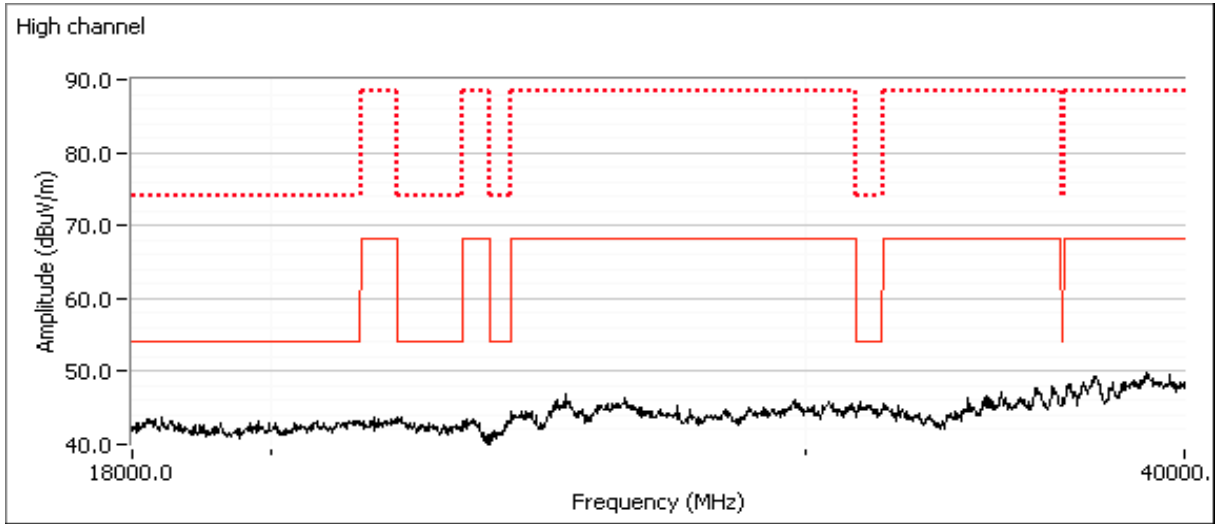

Client:	Nextivity Inc	Job Number:	J86441
Model:	CELF1-RS225CU & CELFI-RS225WU	T-Log Number:	T86797
Contact:	Steve van Skike	Account Manager:	Sheareen Washington
Standard:	FCC 15B & 15E, RSS-210	Class:	N/A

Date of Test: 4/11/2012
 Test Engineer: John Caizzi
 Test Location: FT3

5725 MHz Restricted Band Edge Radiated Field Strength

Frequency	Level	Pol	FCC 15.209		Detector	Azimuth	Height	Comments
MHz	dB μ V/m	v/h	Limit	Margin	PK/QP/Avg	degrees	meters	
5725.000	64.9	V	68.3	-3.4	PK	203	1.34	

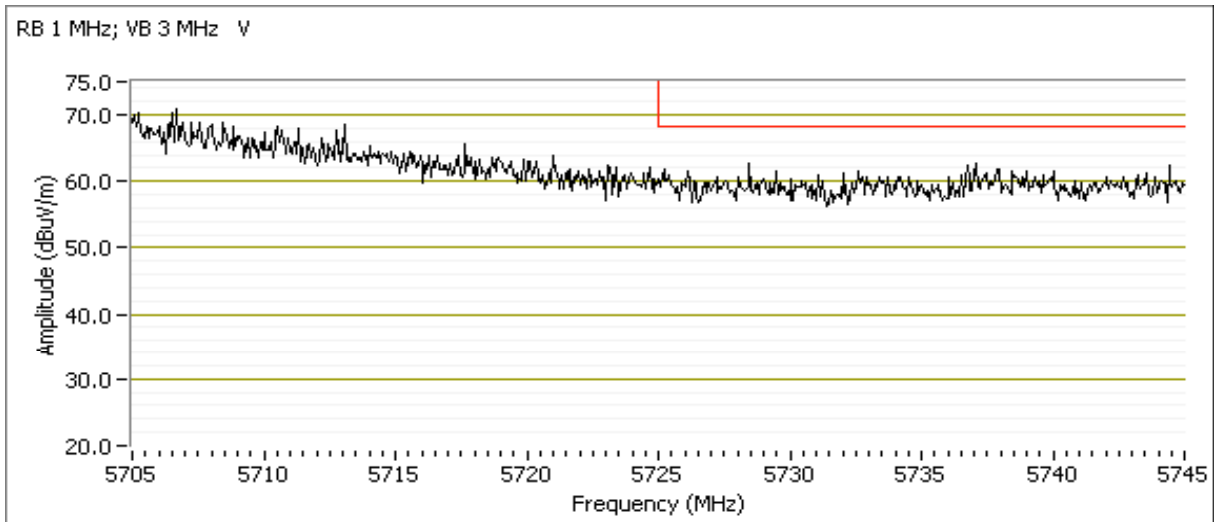

Client:	Nextivity Inc	Job Number:	J86441
Model:	CELFI-RS225CU & CELFI-RS225WU	T-Log Number:	T86797
		Account Manager:	Sheareen Washington
Contact:	Steve van Skike		
Standard:	FCC 15B & 15E, RSS-210	Class:	-

Conducted Emissions

(Elliott Laboratories Fremont Facility, Semi-Anechoic Chamber)

Test Specific Details

Objective: The objective of this test session is to perform final qualification testing of the EUT with respect to the specification listed above.

Date of Test: 3/20/2012	Config. Used: 1
Test Engineer: Peter Sales	Config Change: None
Test Location: Fremont Chamber #5	EUT Voltage: 120V/60Hz

General Test Configuration

For tabletop equipment, the EUT was located on a wooden table inside the semi-anechoic chamber, 40 cm from a vertical coupling plane and 80cm from the LISN. A second LISN was used for all local support equipment. Remote support equipment was located outside of the semi-anechoic chamber. Any cables running to remote support equipment were routed through metal conduit and when possible passed through a ferrite clamp upon exiting the chamber.

Ambient Conditions:	Temperature:	21 °C
	Rel. Humidity:	32 %

Summary of Results

Run #	Test Performed	Limit	Result	Margin
1	CE, AC Power, 120V/60Hz, Coverage Unit	Class B	Pass	44.0 dB μ V @ 0.179 MHz (-20.5 dB)
2	CE, AC Power, 120V/60Hz, Window Unit	Class B	Pass	50.1 dB μ V @ 0.153 MHz (-15.7 dB)

Modifications Made During Testing

No modifications were made to the EUT during testing

Deviations From The Standard

No deviations were made from the requirements of the standard.

Client: Nextivity Inc	Job Number: J86441
Model: CELFI-RS225CU & CELFI-RS225WU	T-Log Number: T86797
Contact: Steve van Skike	Account Manager: Sheareen Washington
Standard: FCC 15B & 15E, RSS-210	Class: -

Run #1: AC Power Port Conducted Emissions, 0.15 - 30MHz, 230V/50Hz
CU

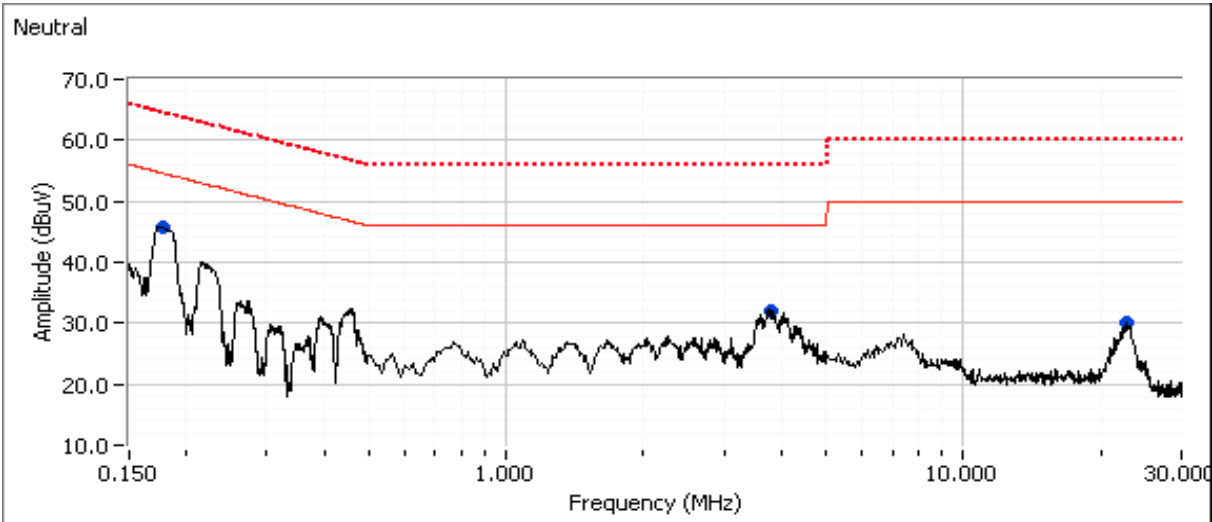
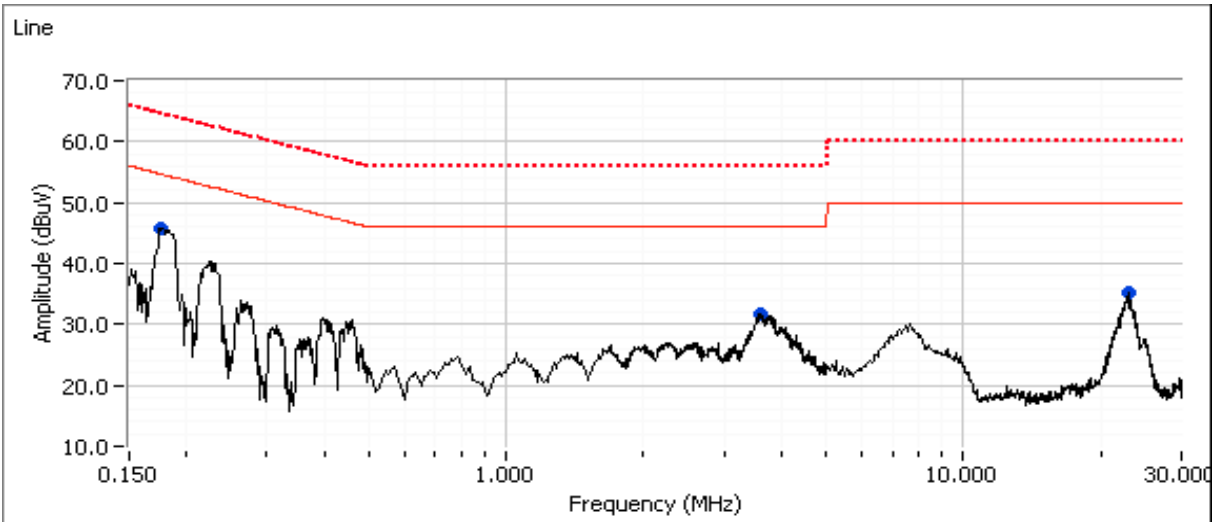

Continue Run #1 next page...

Client:	Nextivity Inc	Job Number:	J86441
Model:	CELFI-RS225CU & CELFI-RS225WU	T-Log Number:	T86797
Contact:	Steve van Skike	Account Manager:	Sheareen Washington
Standard:	FCC 15B & 15E, RSS-210	Class:	-

Run #1: AC Power Port Conducted Emissions, 0.15 - 30MHz, 230V/50Hz (continue)

Preliminary peak readings captured during pre-scan (peak readings vs. average limit)

Frequency MHz	Level dB μ V	AC Line	Class B		Detector QP/Ave	Comments
			Limit	Margin		
0.179	45.8	Neutral	54.6	-8.8	Peak	
0.177	45.7	Line 1	54.7	-9.0	Peak	
3.784	31.9	Neutral	46.0	-14.1	Peak	
3.597	31.7	Line 1	46.0	-14.3	Peak	
23.154	35.3	Line 1	50.0	-14.7	Peak	
22.721	30.0	Neutral	50.0	-20.0	Peak	

Final quasi-peak and average readings

Frequency MHz	Level dB μ V	AC Line	Class B		Detector QP/Ave	Comments
			Limit	Margin		
0.179	44.0	Neutral	64.5	-20.5	QP	QP (1.00s)
0.177	43.6	Line 1	64.6	-21.0	QP	QP (1.00s)
0.179	32.6	Neutral	54.5	-21.9	AVG	AVG (0.10s)
3.597	20.9	Line 1	46.0	-25.1	AVG	AVG (0.10s)
0.177	29.0	Line 1	54.6	-25.6	AVG	AVG (0.10s)
3.784	20.3	Neutral	46.0	-25.7	AVG	AVG (0.10s)
23.154	22.7	Line 1	50.0	-27.3	AVG	AVG (0.10s)
3.784	26.6	Neutral	56.0	-29.4	QP	QP (1.00s)
3.597	26.4	Line 1	56.0	-29.6	QP	QP (1.00s)
23.154	28.4	Line 1	60.0	-31.6	QP	QP (1.00s)
22.721	16.5	Neutral	50.0	-33.5	AVG	AVG (0.10s)
22.721	23.2	Neutral	60.0	-36.8	QP	QP (1.00s)

Client: Nextivity Inc	Job Number: J86441
Model: CELFI-RS225CU & CELFI-RS225WU	T-Log Number: T86797
Contact: Steve van Skike	Account Manager: Sheareen Washington
Standard: FCC 15B & 15E, RSS-210	Class: -

Run #2: AC Power Port Conducted Emissions, 0.15 - 30MHz, 120V/60Hz
WU

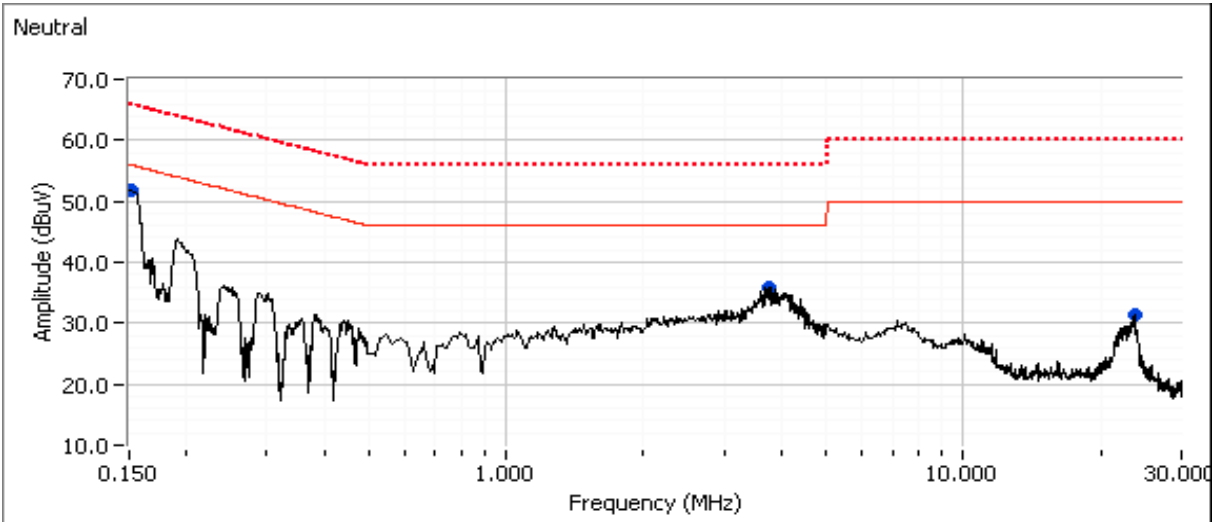
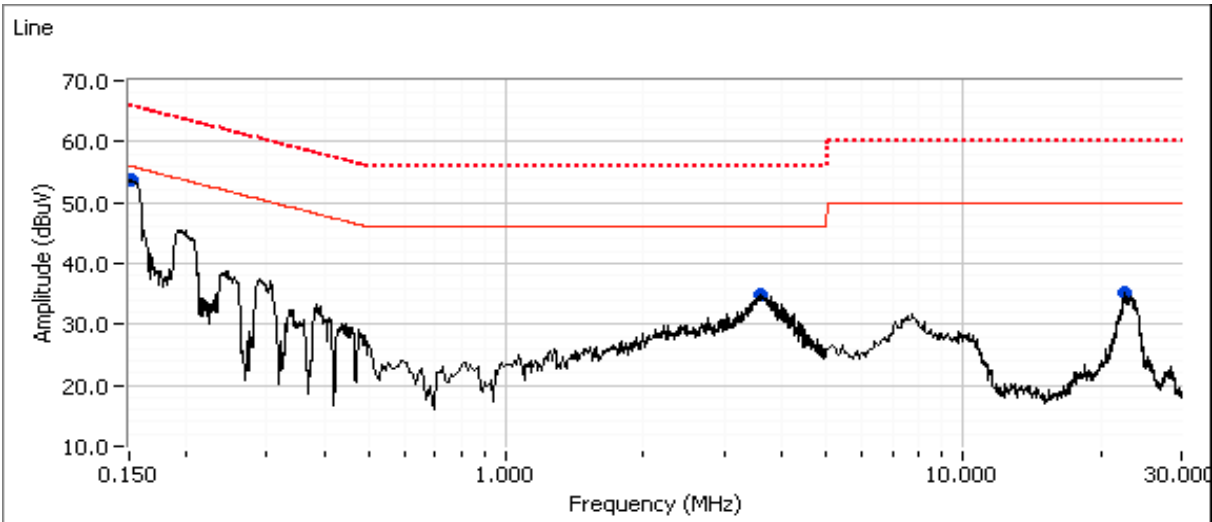

Continue Run #2 next page...

Client:	Nextivity Inc	Job Number:	J86441
Model:	CELFI-RS225CU & CELFI-RS225WU	T-Log Number:	T86797
Contact:	Steve van Skike	Account Manager:	Sheareen Washington
Standard:	FCC 15B & 15E, RSS-210	Class:	-

Run #2: AC Power Port Conducted Emissions, 0.15 - 30MHz, 120V/60Hz (continue)

Preliminary peak readings captured during pre-scan (peak readings vs. average limit)

Frequency MHz	Level dB μ V	AC Line	Class B		Detector QP/Ave	Comments
			Limit	Margin		
0.153	53.6	Line 1	55.9	-2.3	Peak	
0.153	51.9	Neutral	55.9	-4.0	Peak	
3.784	35.8	Neutral	46.0	-10.2	Peak	
3.588	34.8	Line 1	46.0	-11.2	Peak	
22.404	35.3	Line 1	50.0	-14.7	Peak	
23.702	31.3	Neutral	50.0	-18.7	Peak	

Final quasi-peak and average readings

Frequency MHz	Level dB μ V	AC Line	Class B		Detector QP/Ave	Comments
			Limit	Margin		
0.153	50.1	Line 1	65.8	-15.7	QP	QP (1.00s)
0.153	49.0	Neutral	65.8	-16.8	QP	QP (1.00s)
0.153	34.1	Neutral	55.8	-21.7	AVG	AVG (0.10s)
3.588	23.3	Line 1	46.0	-22.7	AVG	AVG (0.10s)
0.153	32.9	Line 1	55.8	-22.9	AVG	AVG (0.10s)
3.588	32.2	Line 1	56.0	-23.8	QP	QP (1.00s)
3.784	21.6	Neutral	46.0	-24.4	AVG	AVG (0.10s)
3.784	30.9	Neutral	56.0	-25.1	QP	QP (1.00s)
22.404	22.4	Line 1	50.0	-27.6	AVG	AVG (0.10s)
22.404	28.5	Line 1	60.0	-31.5	QP	QP (1.00s)
23.702	15.5	Neutral	50.0	-34.5	AVG	AVG (0.10s)
23.702	23.3	Neutral	60.0	-36.7	QP	QP (1.00s)

End of Report

This page is intentionally blank and marks the last page of this test report.