

## TEST REPORT

*Covering the  
DYNAMIC FREQUENCY SELECTION (DFS)  
REQUIREMENTS  
OF  
FCC Part 15 Subpart E (UNII), RSS-210 Annex 9*

*Nextivity, Inc.  
Model(s): CELFi-RS224WU and CELFi-RS224CU*

COMPANY: Nextivity, Inc.  
12230 World Trade Drive Suite 250  
San Diego, CA, 92128

TEST SITE: NTS Silicon Valley  
41039 Boyce Road  
Fremont, CA 94538

REPORT DATE: December 20, 2012

FINAL TEST DATE: November 19, 20, 2012

TEST ENGINEER: Wayne Fisher

PROGRAM MGR /  
TECHNICAL REVIEWER:



---

David Bare  
Chief Engineer

QUALITY ASSURANCE DELEGATE /  
FINAL REPORT PREPARER:



---

Wayne Fisher  
Engineering Team Lead



NTS Silicon Valley is accredited by the A2LA, certificate number 0214.26, to perform the test(s) listed in this report, except where noted otherwise. This report and the information contained herein represent the results of testing test articles identified and selected by the client performed to specifications and/or procedures selected by the client. National Technical Systems (NTS) makes no representations, expressed or implied, that such testing is adequate (or inadequate) to demonstrate efficiency, performance, reliability, or any other characteristic of the articles being tested, or similar products. This report should not be relied upon as an endorsement or certification by NTS of the equipment tested, nor does it represent any statement whatsoever as to its merchantability or fitness of the test article, or similar products, for a particular purpose. This report shall not be reproduced except in full

**REVISION HISTORY**

Rev #	Date	Comments	Modified By
1.0		Initial Release	-

**TABLE OF CONTENTS**

**REVISION HISTORY .....2**

**TABLE OF CONTENTS .....3**

**LIST OF TABLES.....3**

**LIST OF FIGURES.....6**

**SCOPE.....8**

**OBJECTIVE.....8**

**STATEMENT OF COMPLIANCE.....8**

**DEVIATIONS FROM THE STANDARD.....8**

**TEST RESULTS.....9**

    TEST RESULTS SUMMARY – FCC PART 15, MASTER DEVICE .....9

    MEASUREMENT UNCERTAINTIES.....13

**EQUIPMENT UNDER TEST (EUT) DETAILS.....14**

    GENERAL.....14

    ENCLOSURE.....15

    MODIFICATIONS.....15

    SUPPORT EQUIPMENT.....15

    EUT INTERFACE PORTS .....16

    EUT OPERATION .....16

**RADAR WAVEFORMS.....17**

**DFS TEST METHODS.....18**

    RADIATED TEST METHOD .....18

**DFS MEASUREMENT INSTRUMENTATION.....20**

    RADAR GENERATION SYSTEM .....20

    CHANNEL MONITORING SYSTEM.....21

**DFS MEASUREMENT METHODS .....22**

    DFS RADAR DETECTION BANDWIDTH .....22

    DFS – CHANNEL CLOSING TRANSMISSION TIME AND CHANNEL MOVE TIME .....22

    DFS – CHANNEL NON-OCCUPANCY AND VERIFICATION OF PASSIVE SCANNING.....22

    DFS CHANNEL AVAILABILITY CHECK TIME.....23

    UNIFORM LOADING.....23

    TRANSMIT POWER CONTROL (TPC) .....23

**SAMPLE CALCULATIONS .....24**

    DETECTION PROBABILITY / SUCCESS RATE .....24

    THRESHOLD LEVEL .....24

**APPENDIX A TEST EQUIPMENT CALIBRATION DATA .....25**

**APPENDIX B TEST DATA TABLES FOR RADAR DETECTION PROBABILITY .....26**

**APPENDIX C TEST DATA TABLES AND PLOTS FOR CHANNEL CLOSING .....190**

    FCC PART 15 SUBPART E CHANNEL CLOSING MEASUREMENTS .....190

**APPENDIX D TEST DATA – CHANNEL AVAILABILITY CHECK.....204**

    5250- 5350 MHZ, 5470 – 5725 MHZ .....204

**APPENDIX E ANTENNA SPECIFICATION .....207**

**APPENDIX F TEST CONFIGURATION PHOTOGRAPH(S) .....215**

**APPENDIX G DFS IMPLEMENTATION PROPOSAL FOR CEL-FI U-NII LINK.....217**

**LIST OF TABLES**

Table 1 FCC Part 15 Subpart E Master Device Test Result Summary – WU (CU Synchronization Mode)  
Fl ..... 9

Table 2 FCC Part 15 Subpart E Master Device Test Result Summary – WU (CU Synchronization Mode)  
Fh ..... 10

---

Table 3 FCC Part 15 Subpart E Master Device Test Result Summary – CU (Steady State Mode) Fl ..... 11

Table 4 FCC Part 15 Subpart E Master Device Test Result Summary – WU (Steady State Mode) Fh ..... 12

Table 5 FCC Short Pulse Radar Test Waveforms..... 17

Table 6 FCC Long Pulse Radar Test Waveforms ..... 17

Table 7 FCC Frequency Hopping Radar Test Waveforms ..... 17

Table 8 –Detection Bandwidth Measurements (Bandwidth: +11MHz /-11MHz)..... 26

Table 9 - Summary of All Results - CU-Acquire Hi-Band..... 27

Table 10 - FCC Short Pulse Radar (Type 1) Results CU-Acquire Hi-Band..... 27

Table 11 - FCC Short Pulse Radar (Type 2) Results CU-Acquire Hi-Band..... 29

Table 12 - FCC Short Pulse Radar (Type 3) Results CU-Acquire Hi-Band..... 30

Table 13 - FCC Short Pulse Radar (Type 4) Results CU-Acquire Hi-Band..... 31

Table 14 - Long Sequence Waveform Summary CU-Acquire Hi-Band ..... 32

Table 15 - CU-Acquire Hi-Band Long Sequence Waveform Trial#1 (Detected) ..... 33

Table 16 - CU-Acquire Hi-Band Long Sequence Waveform Trial#2 (Detected) ..... 34

Table 17 - CU-Acquire Hi-Band Long Sequence Waveform Trial#3 (Detected) ..... 34

Table 18 - CU-Acquire Hi-Band Long Sequence Waveform Trial#4 (Detected) ..... 34

Table 19 - CU-Acquire Hi-Band Long Sequence Waveform Trial#5 (Detected) ..... 35

Table 20 - CU-Acquire Hi-Band Long Sequence Waveform Trial#6 (Detected) ..... 35

Table 21 - CU-Acquire Hi-Band Long Sequence Waveform Trial#7 (Detected) ..... 35

Table 22 - CU-Acquire Hi-Band Long Sequence Waveform Trial#8 (Detected) ..... 36

Table 23 - CU-Acquire Hi-Band Long Sequence Waveform Trial#9 (Detected) ..... 36

Table 24 - CU-Acquire Hi-Band Long Sequence Waveform Trial#10 (Detected) ..... 36

Table 25 - CU-Acquire Hi-Band Long Sequence Waveform Trial#11 (Detected) ..... 37

Table 26 - CU-Acquire Hi-Band Long Sequence Waveform Trial#12 (Detected) ..... 37

Table 27 - CU-Acquire Hi-Band Long Sequence Waveform Trial#13 (Detected) ..... 38

Table 28 - CU-Acquire Hi-Band Long Sequence Waveform Trial#14 (Detected) ..... 38

Table 29 - CU-Acquire Hi-Band Long Sequence Waveform Trial#15 (Detected) ..... 38

Table 30 - CU-Acquire Hi-Band Long Sequence Waveform Trial#16 (Detected) ..... 39

Table 31 - CU-Acquire Hi-Band Long Sequence Waveform Trial#17 (Detected) ..... 39

Table 32 - CU-Acquire Hi-Band Long Sequence Waveform Trial#18 (Detected) ..... 39

Table 33 - CU-Acquire Hi-Band Long Sequence Waveform Trial#19 (Detected) ..... 40

Table 34 - CU-Acquire Hi-Band Long Sequence Waveform Trial#20 (Detected) ..... 40

Table 35 - CU-Acquire Hi-Band Long Sequence Waveform Trial#21 (Detected) ..... 40

Table 36 - CU-Acquire Hi-Band Long Sequence Waveform Trial#22 (Detected) ..... 41

Table 37 - CU-Acquire Hi-Band Long Sequence Waveform Trial#23 (Detected) ..... 41

Table 38 - CU-Acquire Hi-Band Long Sequence Waveform Trial#24 (Detected) ..... 42

Table 39 - CU-Acquire Hi-Band Long Sequence Waveform Trial#25 (Detected) ..... 42

Table 40 - CU-Acquire Hi-Band Long Sequence Waveform Trial#26 (Detected) ..... 42

Table 41 - CU-Acquire Hi-Band Long Sequence Waveform Trial#27 (Detected) ..... 43

Table 42 - CU-Acquire Hi-Band Long Sequence Waveform Trial#28 (Detected) ..... 43

Table 43 - CU-Acquire Hi-Band Long Sequence Waveform Trial#29 (Detected) ..... 44

Table 44 - CU-Acquire Hi-Band Long Sequence Waveform Trial#30 (Detected) ..... 44

Table 45 - FCC frequency hopping radar (Type 6) Results CU-Acquire Hi-Band ..... 44

Table 46 - Summary of All Results - CU-Acquire Low-Band ..... 68

Table 47 - FCC Short Pulse Radar (Type 1) Results CU-Acquire Low-Band ..... 68

Table 48 - FCC Short Pulse Radar (Type 2) Results CU-Acquire Low-Band ..... 69

Table 49 - FCC Short Pulse Radar (Type 3) Results CU-Acquire Low-Band ..... 70

Table 50 - FCC Short Pulse Radar (Type 4) Results CU-Acquire Low-Band ..... 71

Table 51 - Long Sequence Waveform Summary CU-Acquire Low-Band ..... 74

Table 52 - CU-Acquire Low-Band Long Sequence Waveform Trial#1 (Detected) ..... 75

Table 53 - CU-Acquire Low-Band Long Sequence Waveform Trial#2 (Detected) ..... 75

Table 54 - CU-Acquire Low-Band Long Sequence Waveform Trial#3 (Detected) ..... 75

Table 55 - CU-Acquire Low-Band Long Sequence Waveform Trial#4 (Detected) ..... 76

Table 56 - CU-Acquire Low-Band Long Sequence Waveform Trial#5 (Detected) ..... 76

Table 57 - CU-Acquire Low-Band Long Sequence Waveform Trial#6 (Detected) ..... 76

---

---

Table 58 - CU-Acquire Low-Band Long Sequence Waveform Trial#7 (Detected) .....	77
Table 59 - CU-Acquire Low-Band Long Sequence Waveform Trial#8 (Detected) .....	77
Table 60 - CU-Acquire Low-Band Long Sequence Waveform Trial#9 (Detected) .....	77
Table 61 - CU-Acquire Low-Band Long Sequence Waveform Trial#10 (Detected) .....	78
Table 62 - CU-Acquire Low-Band Long Sequence Waveform Trial#11 (Detected) .....	78
Table 63 - CU-Acquire Low-Band Long Sequence Waveform Trial#12 (Detected) .....	78
Table 64 - CU-Acquire Low-Band Long Sequence Waveform Trial#13 (Detected) .....	79
Table 65 - CU-Acquire Low-Band Long Sequence Waveform Trial#14 (Detected) .....	79
Table 66 - CU-Acquire Low-Band Long Sequence Waveform Trial#15 (Detected) .....	79
Table 67 - CU-Acquire Low-Band Long Sequence Waveform Trial#16 (Detected) .....	80
Table 68 - CU-Acquire Low-Band Long Sequence Waveform Trial#17 (Detected) .....	80
Table 69 - CU-Acquire Low-Band Long Sequence Waveform Trial#18 (Detected) .....	81
Table 70 - CU-Acquire Low-Band Long Sequence Waveform Trial#19 (Detected) .....	81
Table 71 - CU-Acquire Low-Band Long Sequence Waveform Trial#20 (Detected) .....	82
Table 72 - CU-Acquire Low-Band Long Sequence Waveform Trial#21 (Detected) .....	82
Table 73 - CU-Acquire Low-Band Long Sequence Waveform Trial#22 (Detected) .....	82
Table 74 - CU-Acquire Low-Band Long Sequence Waveform Trial#23 (Detected) .....	83
Table 75 - CU-Acquire Low-Band Long Sequence Waveform Trial#24 (Detected) .....	83
Table 76 - CU-Acquire Low-Band Long Sequence Waveform Trial#25 (Detected) .....	83
Table 77 - CU-Acquire Low-Band Long Sequence Waveform Trial#26 (Detected) .....	84
Table 78 - CU-Acquire Low-Band Long Sequence Waveform Trial#27 (Detected) .....	84
Table 79 - CU-Acquire Low-Band Long Sequence Waveform Trial#28 (Detected) .....	84
Table 80 - CU-Acquire Low-Band Long Sequence Waveform Trial#29 (Detected) .....	85
Table 81 - CU-Acquire Low-Band Long Sequence Waveform Trial#30 (Detected) .....	85
Table 82 - CU-Acquire Low-Band Long Sequence Waveform Trial#31 (Detected) .....	85
Table 83 - FCC frequency hopping radar (Type 6) Results CU-Acquire Low-Band .....	86
Table 84 - Summary of All Results - WU-Steady State High-Band.....	109
Table 85 - FCC Short Pulse Radar (Type 1) Results WU-Steady State High-Band.....	109
Table 86 - FCC Short Pulse Radar (Type 2) Results WU-Steady State High-Band.....	110
Table 87 - FCC Short Pulse Radar (Type 3) Results WU-Steady State High-Band.....	111
Table 88 - FCC Short Pulse Radar (Type 4) Results WU-Steady State High-Band.....	112
Table 89 - Long Sequence Waveform Summary WU-Steady State High-Band .....	114
Table 90 - WU-Steady State High-Band Long Sequence Waveform Trial#1 (Detected) .....	115
Table 91 - WU-Steady State High-Band Long Sequence Waveform Trial#2 (Detected) .....	115
Table 92 - WU-Steady State High-Band Long Sequence Waveform Trial#3 (Detected) .....	116
Table 93 - WU-Steady State High-Band Long Sequence Waveform Trial#4 (Detected) .....	116
Table 94 - WU-Steady State High-Band Long Sequence Waveform Trial#5 (Detected) .....	116
Table 95 - WU-Steady State High-Band Long Sequence Waveform Trial#6 (Detected) .....	117
Table 96 - WU-Steady State High-Band Long Sequence Waveform Trial#7 (Detected) .....	117
Table 97 - WU-Steady State High-Band Long Sequence Waveform Trial#8 (Detected) .....	118
Table 98 - WU-Steady State High-Band Long Sequence Waveform Trial#9 (Detected) .....	118
Table 99 - WU-Steady State High-Band Long Sequence Waveform Trial#10 (Detected) .....	118
Table 100 - WU-Steady State High-Band Long Sequence Waveform Trial#11 (Detected) .....	119
Table 101 - WU-Steady State High-Band Long Sequence Waveform Trial#12 (Detected) .....	119
Table 102 - WU-Steady State High-Band Long Sequence Waveform Trial#13 (Detected) .....	119
Table 103 - WU-Steady State High-Band Long Sequence Waveform Trial#14 (Detected) .....	120
Table 104 - WU-Steady State High-Band Long Sequence Waveform Trial#15 (Detected) .....	120
Table 105 - WU-Steady State High-Band Long Sequence Waveform Trial#16 (Detected) .....	120
Table 106 - WU-Steady State High-Band Long Sequence Waveform Trial#17 (Detected) .....	121
Table 107 - WU-Steady State High-Band Long Sequence Waveform Trial#18 (Detected) .....	121
Table 108 - WU-Steady State High-Band Long Sequence Waveform Trial#19 (Detected) .....	121
Table 109 - WU-Steady State High-Band Long Sequence Waveform Trial#20 (Detected) .....	122
Table 110 - WU-Steady State High-Band Long Sequence Waveform Trial#21 (Detected) .....	122
Table 111 - WU-Steady State High-Band Long Sequence Waveform Trial#22 (Detected) .....	123
Table 112 - WU-Steady State High-Band Long Sequence Waveform Trial#23 (Detected) .....	123

Table 113 - WU-Steady State High-Band Long Sequence Waveform Trial#24 (Detected) ..... 123

Table 114 - WU-Steady State High-Band Long Sequence Waveform Trial#25 (Detected) ..... 124

Table 115 - WU-Steady State High-Band Long Sequence Waveform Trial#26 (Detected) ..... 124

Table 116 - WU-Steady State High-Band Long Sequence Waveform Trial#27 (Detected) ..... 124

Table 117 - WU-Steady State High-Band Long Sequence Waveform Trial#28 (Detected) ..... 125

Table 118 - WU-Steady State High-Band Long Sequence Waveform Trial#29 (Detected) ..... 125

Table 119 - WU-Steady State High-Band Long Sequence Waveform Trial#30 (Detected) ..... 126

Table 120 - FCC frequency hopping radar (Type 6) Results WU-Steady State High-Band ..... 126

Table 121 - Summary of All Results - CU-Steady State Low-Band ..... 150

Table 122 - FCC Short Pulse Radar (Type 1) Results CU-Steady State Low-Band ..... 150

Table 123 - FCC Short Pulse Radar (Type 2) Results CU-Steady State Low-Band ..... 151

Table 124 - FCC Short Pulse Radar (Type 3) Results CU-Steady State Low-Band ..... 152

Table 125 - FCC Short Pulse Radar (Type 4) Results CU-Steady State Low-Band ..... 153

Table 126 - Long Sequence Waveform Summary CU-Steady State Low-Band ..... 155

Table 127 - CU-Steady State Low-Band Long Sequence Waveform Trial#1 (Detected) ..... 156

Table 128 - CU-Steady State Low-Band Long Sequence Waveform Trial#2 (Detected) ..... 156

Table 129 - CU-Steady State Low-Band Long Sequence Waveform Trial#3 (Detected) ..... 157

Table 130 - CU-Steady State Low-Band Long Sequence Waveform Trial#4 (Detected) ..... 157

Table 131 - CU-Steady State Low-Band Long Sequence Waveform Trial#5 (Detected) ..... 157

Table 132 - CU-Steady State Low-Band Long Sequence Waveform Trial#6 (Detected) ..... 157

Table 133 - CU-Steady State Low-Band Long Sequence Waveform Trial#7 (Detected) ..... 158

Table 134 - CU-Steady State Low-Band Long Sequence Waveform Trial#8 (Detected) ..... 158

Table 135 - CU-Steady State Low-Band Long Sequence Waveform Trial#9 (Detected) ..... 159

Table 136 - CU-Steady State Low-Band Long Sequence Waveform Trial#10 (Detected) ..... 159

Table 137 - CU-Steady State Low-Band Long Sequence Waveform Trial#11 (Detected) ..... 159

Table 138 - CU-Steady State Low-Band Long Sequence Waveform Trial#12 (Detected) ..... 160

Table 139 - CU-Steady State Low-Band Long Sequence Waveform Trial#13 (Detected) ..... 160

Table 140 - CU-Steady State Low-Band Long Sequence Waveform Trial#14 (Detected) ..... 160

Table 141 - CU-Steady State Low-Band Long Sequence Waveform Trial#15 (Detected) ..... 161

Table 142 - CU-Steady State Low-Band Long Sequence Waveform Trial#16 (Detected) ..... 161

Table 143 - CU-Steady State Low-Band Long Sequence Waveform Trial#17 (Detected) ..... 161

Table 144 - CU-Steady State Low-Band Long Sequence Waveform Trial#18 (Detected) ..... 162

Table 145 - CU-Steady State Low-Band Long Sequence Waveform Trial#19 (Detected) ..... 162

Table 146 - CU-Steady State Low-Band Long Sequence Waveform Trial#20 (Detected) ..... 162

Table 147 - CU-Steady State Low-Band Long Sequence Waveform Trial#21 (Detected) ..... 163

Table 148 - CU-Steady State Low-Band Long Sequence Waveform Trial#22 (Detected) ..... 163

Table 149 - CU-Steady State Low-Band Long Sequence Waveform Trial#23 (Detected) ..... 163

Table 150 - CU-Steady State Low-Band Long Sequence Waveform Trial#24 (Detected) ..... 164

Table 151 - CU-Steady State Low-Band Long Sequence Waveform Trial#25 (Detected) ..... 164

Table 152 - CU-Steady State Low-Band Long Sequence Waveform Trial#26 (Detected) ..... 164

Table 153 - CU-Steady State Low-Band Long Sequence Waveform Trial#27 (Detected) ..... 165

Table 154 - CU-Steady State Low-Band Long Sequence Waveform Trial#28 (Detected) ..... 165

Table 155 - CU-Steady State Low-Band Long Sequence Waveform Trial#29 (Detected) ..... 166

Table 156 - CU-Steady State Low-Band Long Sequence Waveform Trial#30 (Detected) ..... 166

Table 157 - FCC frequency hopping radar (Type 6) Results CU-Steady State Low-Band ..... 166

Table 158 FCC Part 15 Subpart E Channel Closing Test Results ..... 190

**LIST OF FIGURES**

Figure 1 Test Configuration for radiated Measurement Method ..... 18

Figure 2 Channel Closing Time and Channel Move Time – 40 second plot, Type 1 Radar, Low Band, CU Steady State..... 191

Figure 3 Close-Up of Transmissions Occurring More Than 200ms After The End of Radar, Type 1 Radar, Low Band, CU Steady State ..... 192

---

Figure 4 Channel Closing Time and Channel Move Time – 40 second plot, Long Pulse Radar, Low Band, CU Steady State .....	193
Figure 5 Close-Up of Transmissions Occurring More Than 200ms After The End of Radar, Long Pulse Radar, Low Band, CU Steady State .....	194
Figure 6 Channel Closing Time and Channel Move Time – 40 second plot, Type 1 Radar, High Band, WU Steady State .....	195
Figure 7 Close-Up of Transmissions Occurring More Than 200ms After The End of Radar, Type 1 Radar, High Band, WU Steady State.....	196
Figure 8 Channel Closing Time and Channel Move Time – 40 second plot, Long Pulse Radar, High Band, WU Steady State .....	197
Figure 9 Close-Up of Transmissions Occurring More Than 200ms After The End of Radar, Long Pulse Radar, High Band, WU Steady State .....	198
Figure 10 Channel Closing Time and Channel Move Time – 40 second plot, Type 1 Radar, Low Band, WU, CU Acquire Mode .....	199
Figure 11 Close-Up of Transmissions Occurring More Than 200ms After The End of Radar, Type 1 Radar, Low Band, WU, CU Acquire Mode .....	200
Figure 12 Channel Closing Time and Channel Move Time – 40 second plot, Long Pulse Radar, Low Band, WU, CU Acquire Mode.....	201
Figure 13 Close-Up of Transmissions Occurring More Than 200ms After The End of Radar, Long Pulse Radar, Low Band, WU, CU Acquire Mode .....	202
Figure 14 Radar Channel Non-Occupancy Plot.....	203
Figure 15 Plot of EUT Start-Up After CAC .....	204
Figure 16 Radar Applied At Start of CAC.....	205
Figure 17 Radar Applied At End of CAC.....	206

### **SCOPE**

Test data has been taken pursuant to the relevant DFS requirements of the following standard(s):

- FCC Part 15 Subpart E Unlicensed National Information Infrastructure (U-NII) Devices.
- RSS-210 Annex 9 Local Area Network Devices.

Tests were performed in accordance with these standards together with the current published versions of the basic standards referenced therein as outlined in NTS Silicon Valley test procedures. The test results recorded herein are based on a single type test of the Nextivity, Inc. models CELFI-RS224WU, CELFI-RS224CU and therefore apply only to the tested samples. The samples were selected and prepared by Michael Lotter of Nextivity, Inc.

### **OBJECTIVE**

The objective of the manufacturer is to comply with the standards identified in the previous section. In order to demonstrate compliance, the manufacturer or a contracted laboratory makes measurements and takes the necessary steps to ensure that the equipment complies with the appropriate technical standards. Compliance with some DFS features is covered through a manufacturer statement or through observation of the device.

### **STATEMENT OF COMPLIANCE**

The tested samples of the Nextivity, Inc. models CELFI-RS224WU, CELFI-RS224CU complied with the DFS requirements of FCC Part 15.407(h)(2), RSS-210 Annex 9.3.

Maintenance of compliance is the responsibility of the manufacturer. Any modifications to the product should be assessed to determine their potential impact on the compliance status of the device with respect to the standards detailed in this test report.

### **DEVIATIONS FROM THE STANDARD**

No deviations were made from the test methods and requirements covered by the scope of this report.



**TEST RESULTS**

**TEST RESULTS SUMMARY – FCC Part 15, MASTER DEVICE**

<b>Table 1 FCC Part 15 Subpart E Master Device Test Result Summary – WU (CU Synchronization Mode) F1</b>						
Description	Radar Type	EUT Frequency	Measured Value	Requirement	Test Data	Status
Channel Availability Check (CAC) Time	Type 1	5284.8MHz	60S	≥ 60s	Appendix D	Pass
CAC Detection Threshold	Type 1	5284.8MHz	-62dBm	-62dBm (See note 2)	Appendix D	Pass
In-Service Monitoring Detection Threshold	Type 1 Type 2 Type 3 Type 4 Type 5 Type 6	5284.8MHz	-64 dBm (note 2)	-62dBm (See note 2)	Appendix B	Pass
Bandwidth Detection	Type 1	Varies	23 MHz	80% of the 99% BW	-	Pass
Channel closing transmission time	Type 1 Type 5	5284.8 MHz	0ms 0ms	≤ 260ms	Appendix C	Pass
Channel move time	Type 1 Type 5	5284.8 MHz	-9ms 0ms	≤ 10s	Appendix C	Pass
Uniform Loading		-	-	Uniform Loading	Refer to operational description	-

1) Tests were performed using the radiated test method.  
 2) The measured detection threshold is based on testing the master device using the radiated test method when connected to an antenna with a nominal gain of 5.5 dBi. The limit is based on an eirp of less than 23 dBm.  
 3) The in-service monitoring detection threshold and detection probability measurements were made with the device operating in the 5250 – 5350 MHz band.

<b>Table 2 FCC Part 15 Subpart E Master Device Test Result Summary – WU (CU Synchronization Mode) Fh</b>						
Description	Radar Type	EUT Frequency	Measured Value	Requirement	Test Data	Status
Channel Availability Check (CAC) Time	Type 1	5284.8 MHz 5563.2 MHz	>60s	≥ 60s	Appendix D	Pass
CAC Detection Threshold	Type 1	-	-64dBm	-62dBm (See note 2)	Appendix D	Pass
In-Service Monitoring Detection Threshold	Type 1 Type 2 Type 3 Type 4 Type 5 Type 6	5563.2MHz	-64 dBm (note 2)	-62dBm (See note 2)	Appendix B	Pass
Bandwidth Detection	Type 1	Not required in this mode per DFS Implementation Proposal				
Channel closing transmission time	Type 1 Type 5					
Channel move time	Type 1 Type 5					
Non-occupancy period	-	5563.2 MHz	> 30 minutes	> 30 minutes	Appendix C	Pass
Uniform Loading		-	-	Uniform Loading	Refer to operational description	-
1) Tests were performed using the radiated test method. 2) The measured detection threshold is based on testing the master device using the radiated test method when connected to an antenna with a nominal gain of 5.5 dBi. The limit is based on an eirp of less than 23 dBm. 3) The in-service monitoring detection threshold and detection probability measurements were made with the device operating in the 5500-5700 MHz band.						

<b>Table 3 FCC Part 15 Subpart E Master Device Test Result Summary – CU (Steady State Mode) F1</b>						
Description	Radar Type	EUT Frequency	Measured Value	Requirement	Test Data	Status
Channel Availability Check (CAC) Time	Type 1	N/A – CU does not perform CAC				
CAC Detection Threshold	Type 1					
In-Service Monitoring Detection Threshold	Type 1 Type 2 Type 3 Type 4 Type 5 Type 6	5284.8 MHz	-61 dBm (note 2)	-62dBm (See note 2)	Appendix B	Pass
Bandwidth Detection	Type 1	Varies	23 MHz	80% of the 99% BW	-	Pass
Channel closing transmission time	Type 1 Type 5	5284.8 MHz	0ms 0ms	≤ 260ms	Appendix C	Pass
Channel move time	Type 1 Type 5	5284.8 MHz	1ms 0ms	≤ 10s	Appendix C	Pass
Uniform Loading		-	-	Uniform Loading	Refer to operational description	-
<p>4) Tests were performed using the radiated test method.</p> <p>5) The measured detection threshold is based on testing the master device using the radiated test method when connected to an antenna with a nominal gain of 5.5 dBi. The limit is based on an eirp of less than 23 dBm. The limit is -62 dBm but a relaxation of 1 dB is allowed</p> <p>6) The in-service monitoring detection threshold and detection probability measurements were made with the device operating in the 5250 – 5350 MHz band.</p>						

<b>Table 4 FCC Part 15 Subpart E Master Device Test Result Summary – WU (Steady State Mode) Fh</b>						
Description	Radar Type	EUT Frequency	Measured Value	Requirement	Test Data	Status
Channel Availability Check (CAC) Time	Type 1	N/A – No start up in this mode				
In-Service Monitoring Detection Threshold	Type 1 Type 2 Type 3 Type 4 Type 5 Type 6	5563.2MHz	-62 dBm (note 2)	-62dBm (See note 2)	Appendix B	Pass
Bandwidth Detection	Type 1	Varies	+/-11MHz	80% of the 99% BW	-	Pass
Channel closing transmission time	Type 1 Type 5	5580MHz 5525MHz	0ms 0ms	≤ 260ms	Appendix C	Pass
Channel move time	Type 1 Type 5	5580MHz 5525MHz	148ms 0ms	≤ 10s	Appendix C	Pass
Non-occupancy period	-	5563.2 MHz	> 30 minutes	> 30 minutes	Appendix C	Pass
Uniform Loading		-	-	Uniform Loading	Refer to operational description	-
7) Tests were performed using the radiated test method. 8) The measured detection threshold is based on testing the master device using the radiated test method when connected to an antenna with a nominal gain of 5.5 dBi. The limit is based on an eirp of less than 23 dBm. 9) The in-service monitoring detection threshold and detection probability measurements were made with the device operating in the 5500-5700 MHz band.						

**MEASUREMENT UNCERTAINTIES**

ISO/IEC 17025 requires that an estimate of the measurement uncertainties associated with the emissions test results be included in the report. The measurement uncertainties given below are based on a 95% confidence level, with a coverage factor (k=2) and were calculated in accordance with UKAS document LAB 34.

Measurement	Measurement Unit	Expanded Uncertainty
Timing (Channel move time, aggregate transmission time)	ms	Timing resolution +/- 0.24%
Timing (non occupancy period)	seconds	5 seconds
DFS Threshold (radiated)	dBm	1.6
DFS Threshold (conducted)	dBm	1.2

**EQUIPMENT UNDER TEST (EUT) DETAILS**

**GENERAL**

The Nextivity, Inc. models CELFI-RS224WU, CELFI-RS224CU comprise a WCDMA Cellular Repeater for indoor residential use. The system is composed of two units, the Window Unit (WU) and the Coverage Unit (CU) that connect wirelessly over a full-duplex wireless link in the RLAN band using a mixed OFDM and muxed cellular signal (up to three 5MHz cellular channels) over a 30 MHz channel in each direction. The Cel-Fi WU transmits and receives Cellular signals from the base station and operates similar to a cellular handset. The Cel-Fi CU transmits and receives signals with the cellular handset and operates on frequencies similar to the cellular base station. The WU is responsible for allocating the duplex channels for both the WU and CU. It performs the Channel Availability Check (CAC). To satisfy the uniform loading requirement, the WU scans all U-NII channels to perform a RSSI measurement prior to channel selection. The pair of selected channels are randomly chosen from among those whose RSSI value is below a specified threshold. Those channels whose nominal bandwidth occupies the 5600-5650 MHz band may be omitted from the list of usable channels during initial power up. Accordingly, the WU will omit channels occupying 5600-5650 MHz during initial channel selection.

The EUT was treated as table-top equipment during testing to most closely simulate the end-user environment. The electrical rating of the EUT is 12 Volts DC, 1.5A. The AC Adapter rating is 100-240V, 0.7A (Max), 47-63 Hz.

The sample was received on November 19, 2012 and tested on November 19, 20, 2012. The EUT consisted of the following component(s):

Manufacturer	Model	Description	Serial Number
Nextivity, Inc.	CELFi-RS224WU	CelFi Window Unit	159246000012
Nextivity, Inc.	CELFi-RS224CU	CelFi Coverage Unit	159246000012
Nextivity, Inc.	-	AC/DC Adapter(x2)	None

The manufacturer declared values for the EUT operational receive characteristics that affect DFS are as follows:

**Operating Modes (5250 – 5350 MHz, 5470 – 5725 MHz) CELFI-RS224WU**

Master Device 5470-5725 MHz (excluding 5600-5650 MHz)

The WU does CAC only in the 5250-5350 MHz band

**Operating Modes (5250 – 5350 MHz) CELFI-RS224CU**

Master Device 5250-5350 MHz

Note that the CU transmits in the 5470-5725 MHz band and the WU transmits in the 5150-5350 MHz bands.

**Antenna Gains / EIRP (5250 – 5350 MHz)**

Window Unit (WU)	5250 – 5350 MHz	5470 – 5725 MHz
Lowest Antenna Gain (dBi)	5.5	5.5
Highest Antenna Gain (dBi)	5.5	5.5
EIRP Output Power (dBm)	22.3	

**Antenna Gains / EIRP (5470 – 5725 MHz)**

Coverage Unit (CU)	5250 – 5350 MHz	5470 – 5725 MHz
Lowest Antenna Gain (dBi)	5.5	5.5
Highest Antenna Gain (dBi)	5.5	5.5
EIRP Output Power (dBm)		22.2

Note – The WU does not transmit in the 5470-5725 MHz band but does receive in this band. The CU does not transmit in the 5250-5350 MHz band but does receive in this band.

DFS testing was performed with the EUT oriented in the direction of highest antenna gain.

**Channel Protocol**

- IP Based
- Frame Based

***ENCLOSURE***

The EUT WU enclosure measures approximately 157mm high x 145mm wide x 58mm deep. It is primarily constructed of uncoated coated plastic.

The EUT CU enclosure measures primarily constructed of plastic. It measures approximately 157mm high x 145mm wide x 58mm deep

***MODIFICATIONS***

The EUT did not require modifications during testing in order to comply with the requirements of the standard(s) referenced in this test report.

***SUPPORT EQUIPMENT***

The following equipment was used as local support equipment for testing:

Manufacturer	Model	Description	Serial Number	FCC ID
Nokia	C6-01	Cell Phone on AT&T Network	353758042532560	PYARM-801
Dell	Latitude D630	Laptop	-	DoC
Nextivity Inc.	CELF1-RS224 WU	Window Unit	159246000012	YETCELF1-RS224CU
Nextivity Inc.	CELF1-RS224 CU	Coverage Unit	159246000005	YETCELF1-RS224WU

The WU and the CU are both Master devices during normal operation in their respective bands.

**EUT INTERFACE PORTS**

The I/O cabling configuration during testing was as follows:

Port	Connected To	Cable(s)		
		Description	Shielded or Unshielded	Length (m)
USB	Laptop USB	Multi-wire	Shielded	3
AC Adapter Power	AC Mains	-	-	-
DC Power	AC Adapter	Two wire	Unshielded	2

**EUT OPERATION**

The EUT was operating with the following software. The software is secured by encryption to prevent the user from disabling the DFS function.

Master Device: 700N029-001-015

Client Device: 700N029-001-015

The manufacturer provided special software that over-rode the non-occupancy mechanism (allowing return to the same channel) for the purposes of determining the probability of detection. This test feature was disabled and the normal operating software enabled for verifying the 30-minute non-occupancy period and channel move time.

The start of the Channel Availability Check was the instant the command to change channel was sent.

During the tests the system was configured as described in the Nextivity DFS Implementation Proposal document for each of the modes tested.

In the CU Synchronization Mode, the WU traffic on the channel is set at 50% duty cycle in software. In Steady State mode, the traffic on the channel is continuous on FL for the WU and on FH for the CU. In Steady State mode, the WU is only receiving on FH and the CU is only receiving on FL. Refer to refer to Figure 3 in Appendix B.



**RADAR WAVEFORMS**

<b>Table 5 FCC Short Pulse Radar Test Waveforms</b>					
Radar Type	Pulse Width (μsec)	PRI (μsec)	Pulses / burst	Minimum Detection Percentage	Minimum Number of Trials
1	1	1428	18	60%	30
2	1-5	150-230	23-29	60%	30
3	6-10	200-500	16-18	60%	30
4	11-20	200-500	12-16	60%	30
Aggregate (Radar Types 1-4)				80%	120

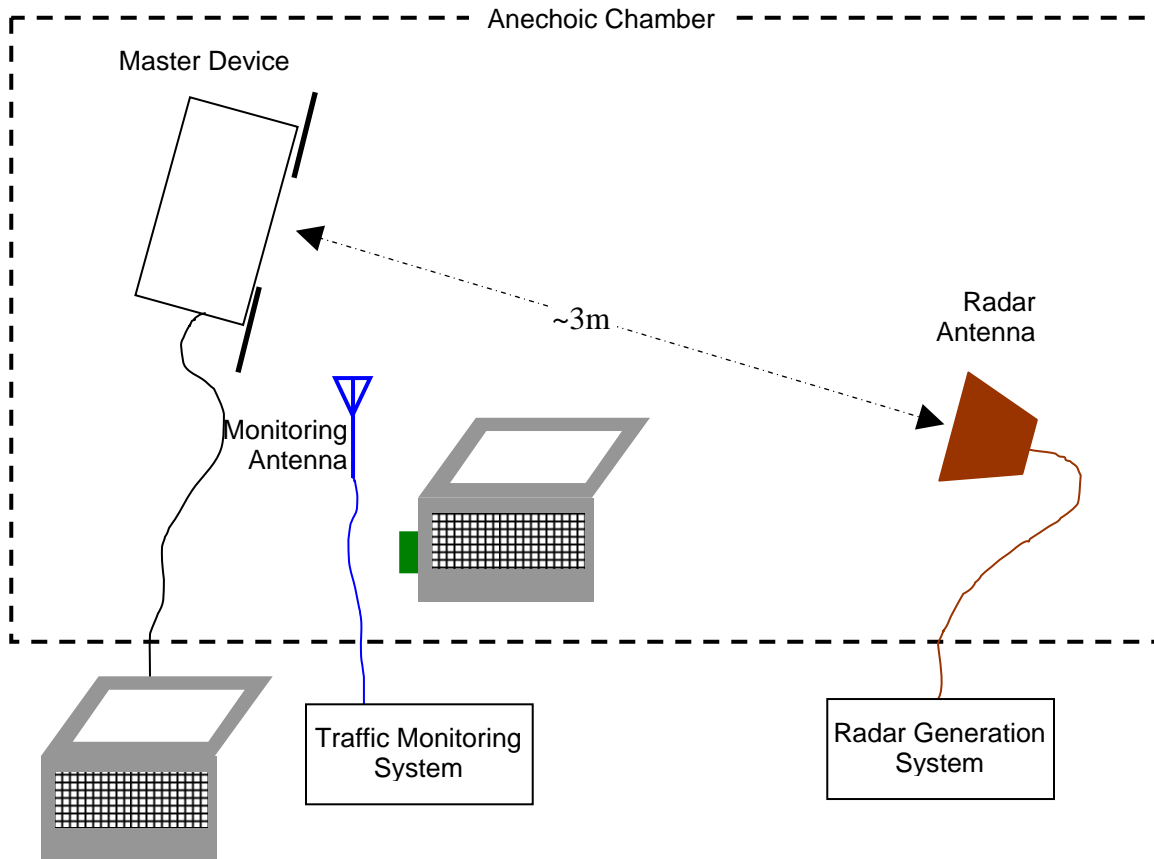
<b>Table 6 FCC Long Pulse Radar Test Waveforms</b>							
Radar Type	Pulse Width (μsec)	Chirp Width (MHz)	PRI (μsec)	Pulses / burst	Number of Bursts	Minimum Detection Percentage	Minimum Number of Trials
5	50-100	5-20	1000-2000	1-3	8-20	80%	30

<b>Table 7 FCC Frequency Hopping Radar Test Waveforms</b>							
Radar Type	Pulse Width (μsec)	PRI (μsec)	Pulses / hop	Hopping Rate (kHz)	Hopping Sequence Length (msec)	Minimum Detection Percentage	Minimum Number of Trials
6	1	333	9	0.333	300	70%	30

**DFS TEST METHODS**

**RADIATED TEST METHOD**

The combination of master and slave devices is located in an anechoic chamber. The simulated radar waveform is transmitted from a directional horn antenna (typically an EMCO 3115) toward the unit performing the radar detection (radar detection device, RDD). Every effort is made to ensure that the main beam of the EUT's antenna is aligned with the radar-generating antenna.



**Figure 1 Test Configuration for radiated Measurement Method**

The signal level of the simulated waveform is set to a reference level equal to the threshold level (plus 1dB if testing against FCC requirements). Lower levels may also be applied on request of the manufacturer. The level reported is the level at the RDD antenna and so it is not corrected for the RDD's antenna gain. The RDD is configured with the lowest gain antenna assembly intended for use with the device.

The signal level is verified by measuring the CW signal level from the radar generation system using a reference antenna of gain  $G_{REF}$  (dBi). The radar signal level is calculated from the measured level,  $R$  (dBm), and any cable loss,  $L$  (dB), between the reference antenna and the measuring instrument:

$$\text{Applied level (dBm)} = R - G_{REF} + L$$

If both master and client devices have radar detection capability then the device not under test is positioned with absorbing material between its antenna and the radar generating antenna, and the radar level at the non RDD is verified to be at least 20dB below the threshold level to ensure that any responses are due to the RDD detecting radar.

The antenna connected to the channel monitoring subsystem is positioned to allow both master and client transmissions to be observed, with the level of the EUT's transmissions between 6 and 10dB higher than those from the other device.

## **DFS MEASUREMENT INSTRUMENTATION**

### **RADAR GENERATION SYSTEM**

An Agilent PSG is used as the radar-generating source. The integral arbitrary waveform generators are programmed using Agilent's "Pulse Building" software and NTS Silicon Valley custom software to produce the required waveforms, with the capability to produce both un-modulated and modulated (FM Chirp) pulses. Where there are multiple values for a specific radar parameter then the software selects a value at random and, for FCC tests, the software verifies that the resulting waveform is truly unique.

With the exception of the hopping waveforms required by the FCC's rules (see below), the radar generator is set to a single frequency within the radar detection bandwidth of the EUT. The frequency is varied from trial to trial by stepping in 5MHz steps.

Frequency hopping radar waveforms are simulated using a time domain model. A randomly hopping sequence algorithm (which uses each channel in the hopping radar's range once in a hopping sequence) generates a hop sequence. A segment of the first 100 elements of the hop sequence are then examined to determine if it contains one or more frequencies within the radar detection bandwidth of the EUT. If it does not then the first element of the segment is discarded and the next frequency in the sequence is added. The process repeats until a valid segment is produced. The radar system is then programmed to produce bursts at time slots coincident with the frequencies within the segment that fall in the detection bandwidth. The frequency of the generator is stepped in 1 MHz increments across the EUT's detection range.

The radar signal level is verified during testing using a CW signal with the AGC function switched on. Correction factors to account for the fact that pulses are generated with the AGC functions switched off are measured annually and an offset is used to account for this in the software.

The generator output is connected to the coupling port of the conducted set-up or to the radar-generating antenna.

**CHANNEL MONITORING SYSTEM**

Channel monitoring is achieved using a spectrum analyzer and digital storage oscilloscope. The analyzer is configured in a zero-span mode, center frequency set to the radar waveform's frequency or the center frequency of the EUT's operating channel. The IF output of the analyzer is connected to one input of the oscilloscope.

A signal generator output is set to send either the modulating signal directly or a pulse gate with an output pulse co-incident with each radar pulse. This output is connected to a second input on the oscilloscope and the oscilloscope displays both the channel traffic (via the if input) and the radar pulses on its display.

For in service monitoring tests the analyzer sweep time is set to > 20 seconds and the oscilloscope is configured with a data record length of 10 seconds for the short duration and frequency hopping waveforms, 20 seconds for the long duration waveforms. Both instruments are set for a single acquisition sequence. The analyzer is triggered 500ms before the start of the waveform and the oscilloscope is triggered directly by the modulating pulse train. Timing measurements for aggregate channel transmission time and channel move time are made from the oscilloscope data, with the end of the waveform clearly identified by the pulse train on one trace. The analyzer trace data is used to confirm that the last transmission occurred within the 10-second record of the oscilloscope. If necessary the record length of the oscilloscope is expanded to capture the last transmission on the channel prior to the channel move.

Channel availability check time timing plots are made using the analyzer. The analyzer is triggered at start of the EUT's channel availability check and used to verify that the EUT does not transmit when radar is applied during the check time.

The analyzer detector and oscilloscope sampling mode is set to peak detect for all plots.

## ***DFS MEASUREMENT METHODS***

### ***DFS RADAR DETECTION BANDWIDTH***

The radar detection bandwidth is determined by using FCC radar waveform 1 and applying radar pulses at offsets from the center channel frequency by multiples of 1MHz. These bursts are applied with no traffic on the channel. The first frequencies above and below the center channel frequency that have a detection rate below 90% define the radar bandwidth, the actual range being 1MHz below the upper frequency and 1MHz above the lower frequency.

### ***DFS – CHANNEL CLOSING TRANSMISSION TIME AND CHANNEL MOVE TIME***

Channel clearing and closing times are measured by applying a burst of radar with the device configured to change channel and by observing the channel for transmissions. The time between the end of the applied radar waveform and the final transmission on the channel is the channel move time.

The aggregate transmission closing time is measured in the following way:

FCC/KCC Notice No. 2010-48 – the total time of all individual transmissions from the EUT that are observed starting 200ms at the end of the last radar pulse in the waveform. This value is required to be less than 60ms.

### ***DFS – CHANNEL NON-OCCUPANCY AND VERIFICATION OF PASSIVE SCANNING***

The channel that was in use prior to radar detection by the master is additionally monitored for 30 minutes to ensure no transmissions on the vacated channel over the required non-occupancy period. This is achieved by tuning the spectrum analyzer to the vacated channel in zero-span mode and connecting the IF output to an oscilloscope. The oscilloscope is triggered by the radar pulse and set to provide a single sweep (in peak detect mode) that lasts for at least 30 minutes after the end of the channel move time.

For devices with a client-mode that are being evaluated against FCC rules the manufacturer must supply an attestation letter stating that the client device does not employ any active scanning techniques (i.e. does not transmit in the DFS bands without authorization from a Master device).

*DFS CHANNEL AVAILABILITY CHECK TIME*

It is preferred that the EUT report when it starts the radar channel availability check. If the EUT does not report the start of the check time, then the time to start transmitting on a channel after switching the device on is measured to approximate the time from power-on to the end of the channel availability check. The start of the channel availability check is assumed to be 60 seconds prior to the first transmission on the channel.

To evaluate the channel availability check, a single burst of one radar type is applied within the first 2 seconds of the start of the channel availability check and it is verified that the device does not use the channel by continuing to monitor the channel for a period of at least 60 seconds. The test is repeated by applying a burst of radar in the last 2 seconds (i.e. between 58 and 60 seconds after the start of CAC when evaluating a 60-second CAC) of the channel availability check.

*UNIFORM LOADING*

Compliance with the FCC's channel loading requirement is demonstrated through the manufacturer's operational description for the device under test.

*TRANSMIT POWER CONTROL (TPC)*

Compliance with the transmit power control requirements for devices is demonstrated through measurements showing multiple power levels and manufacturer statements explaining how the power control is implemented.

## **SAMPLE CALCULATIONS**

### **DETECTION PROBABILITY / SUCCESS RATE**

The detection probability, or success rate, for any one radar waveform equals the number of successful trials divided by the total number of trials for that waveform.

In the case of the FCC requirements, for radar waveform types 1 through 4 an additional calculation is made to determine the average detection probability over all four radar waveform types. This calculation is the arithmetic mean of the four individual probabilities.

### **THRESHOLD LEVEL**

The threshold level is the level of the simulated radar waveform at the EUT's antenna. If the test is performed in a conducted fashion then the level at the rf input equals the level at the antenna plus the gain of the antenna assembly, in dBi. The gain of the antenna assembly equals the gain of the antenna minus the loss of the cabling between the rf input and the antenna. The lowest gain value for all antenna assemblies intended for use with the device is used when making this calculation.

If the test is performed using the radiated method then the threshold level is the level at the antenna.



**Appendix A Test Equipment Calibration Data**

<b><u>Manufacturer</u></b>	<b><u>Description</u></b>	<b><u>Model #</u></b>	<b><u>Asset #</u></b>	<b><u>Cal Due</u></b>
Hewlett Packard	EMC Spectrum Analyzer, 9 kHz - 6.5 GHz	8595EM	780	25-Jan-13
EMCO	Antenna, Horn, 1-18 GHz (SA40-Blu)	3115	1386	26-Sep-14
EMCO	Antenna, Horn, 1-18 GHz	3117	1662	25-May-14
Agilent	PSG Vector Signal Generator (250kHz - 20GHz)	E8267C	1877	11-May-13
Tektronix	500MHz, 2CH, 5GS/s Scope	TDS5052B	2118	22-Oct-13

**Appendix B Test Data Tables for Radar Detection Probability**

The traffic was generated by an active cell phone call with random voice traffic per the Nextivity DFS Implementation Proposal for Cel-Fi U-NII Link.

**Table 8 –Detection Bandwidth Measurements (Bandwidth: +11MHz /-11MHz)**

EUT Frequency	Radar Type	Radar Frequency	# Detected	# Not Detected	Success (%)
5284.80 MHz	FCC Short Pulse Radar (Type 1)	5272.80 MHz	5	3	62
5284.80 MHz	FCC Short Pulse Radar (Type 1)	5273.80 MHz	10	0	100
5284.80 MHz	FCC Short Pulse Radar (Type 1)	5274.80 MHz	10	0	100
5284.80 MHz	FCC Short Pulse Radar (Type 1)	5275.80 MHz	10	0	100
5284.80 MHz	FCC Short Pulse Radar (Type 1)	5276.80 MHz	10	0	100
5284.80 MHz	FCC Short Pulse Radar (Type 1)	5277.80 MHz	10	0	100
5284.80 MHz	FCC Short Pulse Radar (Type 1)	5278.80 MHz	10	0	100
5284.80 MHz	FCC Short Pulse Radar (Type 1)	5279.80 MHz	10	0	100
5284.80 MHz	FCC Short Pulse Radar (Type 1)	5280.80 MHz	10	0	100
5284.80 MHz	FCC Short Pulse Radar (Type 1)	5281.80 MHz	10	0	100
5284.80 MHz	FCC Short Pulse Radar (Type 1)	5282.80 MHz	10	0	100
5284.80 MHz	FCC Short Pulse Radar (Type 1)	5283.80 MHz	10	0	100
5284.80 MHz	FCC Short Pulse Radar (Type 1)	5284.80 MHz	10	0	100
5284.80 MHz	FCC Short Pulse Radar (Type 1)	5285.80 MHz	10	0	100
5284.80 MHz	FCC Short Pulse Radar (Type 1)	5286.80 MHz	10	0	100
5284.80 MHz	FCC Short Pulse Radar	5287.80 MHz	10	0	100

	(Type 1)				
5284.80 MHz	FCC Short Pulse Radar (Type 1)	5288.80 MHz	10	0	100
5284.80 MHz	FCC Short Pulse Radar (Type 1)	5289.80 MHz	10	0	100
5284.80 MHz	FCC Short Pulse Radar (Type 1)	5290.80 MHz	10	0	100
5284.80 MHz	FCC Short Pulse Radar (Type 1)	5291.80 MHz	10	0	100
5284.80 MHz	FCC Short Pulse Radar (Type 1)	5292.80 MHz	10	0	100
5284.80 MHz	FCC Short Pulse Radar (Type 1)	5293.80 MHz	10	0	100
5284.80 MHz	FCC Short Pulse Radar (Type 1)	5294.80 MHz	10	0	100
5284.80 MHz	FCC Short Pulse Radar (Type 1)	5295.80 MHz	10	0	100
5284.80 MHz	FCC Short Pulse Radar (Type 1)	5296.80 MHz	1	3	25

WU as Master CU-Acquire Mode, High Band

Table 9 - Summary of All Results - CU-Acquire Hi-Band				
Waveform Name	Pd (%)	Pd Required (%)	Number of Trials	Status
FCC Short Pulse Radar (Type 1)	100.0 %	60.0 %	30	PASSED
FCC Short Pulse Radar (Type 2)	100.0 %	60.0 %	30	PASSED
FCC Short Pulse Radar (Type 3)	100.0 %	60.0 %	30	PASSED
FCC Short Pulse Radar (Type 4)	93.3 %	60.0 %	30	PASSED
Aggregate of above results	98.3 %	80.0 %	120	PASSED
Long Sequence	100.0 %	80.0 %	30	PASSED
FCC frequency hopping radar (Type 6)	93.5 %	70.0 %	46	PASSED

Table 10 - FCC Short Pulse Radar (Type 1) Results CU-Acquire Hi-Band						
Trial #	Pulses/Burst	Pulse Width (us)	PRI (us)	Detected	Fr (MHz) and level (dBm)	Burst Information
1	18	1.0	1428.0	Yes	5563.2MHz, -64.0dBm	Single burst (11/19/2012 09:29:49 AM)
2	18	1.0	1428.0	Yes	5558.2MHz, -64.0dBm	Single burst (11/19/2012 09:29:57 AM)
3	18	1.0	1428.0	Yes	5568.2MHz, -64.0dBm	Single burst (11/19/2012 09:30:05 AM)
4	18	1.0	1428.0	Yes	5563.2MHz, -64.0dBm	Single burst (11/19/2012 09:30:15 AM)

**Table 10 - FCC Short Pulse Radar (Type 1) Results CU-Acquire Hi-Band**

Trial #	Pulses/ Burst	Pulse Width (us)	PRI (us)	Detected	Fr (MHz) and level (dBm)	Burst Information
5	18	1.0	1428.0	Yes	5558.2MHz, -64.0dBm	Single burst (11/19/2012 09:32:41 AM)
6	18	1.0	1428.0	Yes	5568.2MHz, -64.0dBm	Single burst (11/19/2012 09:32:54 AM)
7	18	1.0	1428.0	Yes	5563.2MHz, -64.0dBm	Single burst (11/19/2012 09:33:14 AM)
8	18	1.0	1428.0	Yes	5558.2MHz, -64.0dBm	Single burst (11/19/2012 09:33:27 AM)
9	18	1.0	1428.0	Yes	5568.2MHz, -64.0dBm	Single burst (11/19/2012 09:33:36 AM)
10	18	1.0	1428.0	Yes	5563.2MHz, -64.0dBm	Single burst (11/19/2012 09:33:43 AM)
11	18	1.0	1428.0	Yes	5558.2MHz, -64.0dBm	Single burst (11/19/2012 09:33:51 AM)
12	18	1.0	1428.0	Yes	5568.2MHz, -64.0dBm	Single burst (11/19/2012 09:34:01 AM)
13	18	1.0	1428.0	Yes	5563.2MHz, -64.0dBm	Single burst (11/19/2012 09:34:12 AM)
14	18	1.0	1428.0	Yes	5558.2MHz, -64.0dBm	Single burst (11/19/2012 09:34:23 AM)
15	18	1.0	1428.0	Yes	5568.2MHz, -64.0dBm	Single burst (11/19/2012 09:34:31 AM)
16	18	1.0	1428.0	Yes	5563.2MHz, -64.0dBm	Single burst (11/19/2012 09:34:43 AM)
17	18	1.0	1428.0	Yes	5558.2MHz, -64.0dBm	Single burst (11/19/2012 09:34:53 AM)
18	18	1.0	1428.0	Yes	5568.2MHz, -64.0dBm	Single burst (11/19/2012 09:35:05 AM)
19	18	1.0	1428.0	Yes	5563.2MHz, -64.0dBm	Single burst (11/19/2012 09:35:17 AM)
20	18	1.0	1428.0	Yes	5558.2MHz, -64.0dBm	Single burst (11/19/2012 09:35:28 AM)
21	18	1.0	1428.0	Yes	5568.2MHz, -64.0dBm	Single burst (11/19/2012 09:35:38 AM)
22	18	1.0	1428.0	Yes	5563.2MHz, -64.0dBm	Single burst (11/19/2012 09:35:54 AM)
23	18	1.0	1428.0	Yes	5558.2MHz, -64.0dBm	Single burst (11/19/2012 09:36:05 AM)
24	18	1.0	1428.0	Yes	5568.2MHz, -64.0dBm	Single burst (11/19/2012 09:36:15 AM)
25	18	1.0	1428.0	Yes	5563.2MHz, -64.0dBm	Single burst (11/19/2012 09:36:23 AM)
26	18	1.0	1428.0	Yes	5558.2MHz, -64.0dBm	Single burst (11/19/2012 09:36:41 AM)
27	18	1.0	1428.0	Yes	5568.2MHz, -64.0dBm	Single burst (11/19/2012 09:36:53 AM)
28	18	1.0	1428.0	Yes	5563.2MHz, -64.0dBm	Single burst (11/19/2012 09:37:10 AM)
29	18	1.0	1428.0	Yes	5558.2MHz, -64.0dBm	Single burst (11/19/2012 09:37:23 AM)
30	18	1.0	1428.0	Yes	5568.2MHz, -64.0dBm	Single burst (11/19/2012 09:37:40 AM)

**Table 11 - FCC Short Pulse Radar (Type 2) Results CU-Acquire Hi-Band**

Trial #	Pulses/ Burst	Pulse Width (us)	PRI (us)	Detected	Fr (MHz) and level (dBm)	Burst Information
1	27	1.2	216.0	Yes	5563.2MHz, -64.0dBm	Single burst (11/19/2012 09:39:15 AM)
2	28	2.3	159.0	Yes	5558.2MHz, -64.0dBm	Single burst (11/19/2012 09:39:31 AM)
3	28	1.4	201.0	Yes	5568.2MHz, -64.0dBm	Single burst (11/19/2012 09:39:45 AM)
4	24	3.1	172.0	Yes	5563.2MHz, -64.0dBm	Single burst (11/19/2012 09:39:59 AM)
5	23	2.8	204.0	Yes	5558.2MHz, -64.0dBm	Single burst (11/19/2012 09:40:14 AM)
6	25	3.4	179.0	Yes	5568.2MHz, -64.0dBm	Single burst (11/19/2012 09:40:22 AM)
7	27	3.4	156.0	Yes	5563.2MHz, -64.0dBm	Single burst (11/19/2012 09:40:30 AM)
8	28	3.4	193.0	Yes	5558.2MHz, -64.0dBm	Single burst (11/19/2012 09:40:37 AM)
9	26	1.0	165.0	Yes	5568.2MHz, -64.0dBm	Single burst (11/19/2012 09:40:45 AM)
10	23	3.7	227.0	Yes	5563.2MHz, -64.0dBm	Single burst (11/19/2012 09:40:52 AM)
11	24	3.6	189.0	Yes	5558.2MHz, -64.0dBm	Single burst (11/19/2012 09:41:02 AM)
12	26	4.0	207.0	Yes	5568.2MHz, -64.0dBm	Single burst (11/19/2012 09:41:10 AM)
13	25	1.6	160.0	Yes	5563.2MHz, -64.0dBm	Single burst (11/19/2012 09:41:18 AM)
14	26	3.1	203.0	Yes	5558.2MHz, -64.0dBm	Single burst (11/19/2012 09:41:26 AM)
15	27	3.9	171.0	Yes	5568.2MHz, -64.0dBm	Single burst (11/19/2012 09:41:37 AM)
16	28	1.8	207.0	Yes	5563.2MHz, -64.0dBm	Single burst (11/19/2012 09:41:47 AM)
17	28	3.0	204.0	Yes	5558.2MHz, -64.0dBm	Single burst (11/19/2012 09:42:00 AM)
18	24	3.7	217.0	Yes	5568.2MHz, -64.0dBm	Single burst (11/19/2012 09:42:08 AM)
19	23	3.1	197.0	Yes	5563.2MHz, -64.0dBm	Single burst (11/19/2012 09:42:24 AM)
20	23	2.9	200.0	Yes	5558.2MHz, -64.0dBm	Single burst (11/19/2012 09:42:38 AM)
21	27	1.3	181.0	Yes	5568.2MHz, -64.0dBm	Single burst (11/19/2012 09:42:46 AM)
22	26	1.9	175.0	Yes	5563.2MHz, -64.0dBm	Single burst (11/19/2012 09:42:54 AM)
23	28	1.8	218.0	Yes	5558.2MHz, -64.0dBm	Single burst (11/19/2012 09:43:03 AM)
24	29	2.7	197.0	Yes	5568.2MHz, -64.0dBm	Single burst (11/19/2012 09:43:11 AM)
25	24	1.1	154.0	Yes	5563.2MHz, -64.0dBm	Single burst (11/19/2012 09:43:22 AM)
26	23	3.1	178.0	Yes	5558.2MHz, -64.0dBm	Single burst (11/19/2012 09:43:53 AM)
27	26	2.9	215.0	Yes	5568.2MHz, -64.0dBm	Single burst (11/19/2012 09:44:13 AM)

<b>Table 11 - FCC Short Pulse Radar (Type 2) Results CU-Acquire Hi-Band</b>						
Trial #	Pulses/ Burst	Pulse Width (us)	PRI (us)	Detected	Fr (MHz) and level (dBm)	Burst Information
28	24	3.8	196.0	Yes	5563.2MHz, -64.0dBm	Single burst (11/19/2012 09:44:23 AM)
29	27	1.4	207.0	Yes	5558.2MHz, -64.0dBm	Single burst (11/19/2012 09:44:33 AM)
30	25	2.2	230.0	Yes	5568.2MHz, -64.0dBm	Single burst (11/19/2012 09:44:43 AM)

<b>Table 12 - FCC Short Pulse Radar (Type 3) Results CU-Acquire Hi-Band</b>						
Trial #	Pulses/ Burst	Pulse Width (us)	PRI (us)	Detected	Fr (MHz) and level (dBm)	Burst Information
1	17	8.6	469.0	Yes	5563.2MHz, -64.0dBm	Single burst (11/19/2012 09:45:27 AM)
2	18	6.4	329.0	Yes	5558.2MHz, -64.0dBm	Single burst (11/19/2012 09:45:36 AM)
3	17	7.5	434.0	Yes	5568.2MHz, -64.0dBm	Single burst (11/19/2012 09:45:47 AM)
4	17	9.7	244.0	Yes	5563.2MHz, -64.0dBm	Single burst (11/19/2012 09:45:55 AM)
5	17	7.4	462.0	Yes	5558.2MHz, -64.0dBm	Single burst (11/19/2012 09:46:45 AM)
6	17	7.4	424.0	Yes	5568.2MHz, -64.0dBm	Single burst (11/19/2012 09:46:53 AM)
7	18	9.4	251.0	Yes	5563.2MHz, -64.0dBm	Single burst (11/19/2012 09:47:24 AM)
8	17	6.9	412.0	Yes	5558.2MHz, -64.0dBm	Single burst (11/19/2012 09:47:32 AM)
9	16	9.9	427.0	Yes	5568.2MHz, -64.0dBm	Single burst (11/19/2012 09:47:40 AM)
10	16	9.6	482.0	Yes	5563.2MHz, -64.0dBm	Single burst (11/19/2012 09:47:48 AM)
11	17	9.9	482.0	Yes	5558.2MHz, -64.0dBm	Single burst (11/19/2012 09:47:55 AM)
12	17	8.7	407.0	Yes	5568.2MHz, -64.0dBm	Single burst (11/19/2012 09:48:04 AM)
13	17	8.2	294.0	Yes	5563.2MHz, -64.0dBm	Single burst (11/19/2012 09:48:23 AM)
14	17	7.2	307.0	Yes	5558.2MHz, -64.0dBm	Single burst (11/19/2012 09:48:31 AM)
15	17	6.9	466.0	Yes	5568.2MHz, -64.0dBm	Single burst (11/19/2012 09:49:03 AM)
16	17	7.4	433.0	Yes	5563.2MHz, -64.0dBm	Single burst (11/19/2012 09:49:11 AM)
17	17	7.7	394.0	Yes	5558.2MHz, -64.0dBm	Single burst (11/19/2012 09:49:25 AM)
18	17	7.6	207.0	Yes	5568.2MHz, -64.0dBm	Single burst (11/19/2012 09:49:32 AM)
19	16	9.2	201.0	Yes	5563.2MHz, -64.0dBm	Single burst (11/19/2012 09:49:39 AM)
20	18	7.8	263.0	Yes	5558.2MHz, -64.0dBm	Single burst (11/19/2012 09:49:47 AM)
21	16	7.0	253.0	Yes	5568.2MHz, -64.0dBm	Single burst (11/19/2012 09:49:54 AM)

<b>Table 12 - FCC Short Pulse Radar (Type 3) Results CU-Acquire Hi-Band</b>						
Trial #	Pulses/ Burst	Pulse Width (us)	PRI (us)	Detected	Fr (MHz) and level (dBm)	Burst Information
22	17	9.1	350.0	Yes	5563.2MHz, -64.0dBm	Single burst (11/19/2012 09:50:03 AM)
23	16	8.6	272.0	Yes	5558.2MHz, -64.0dBm	Single burst (11/19/2012 09:50:11 AM)
24	17	7.1	206.0	Yes	5568.2MHz, -64.0dBm	Single burst (11/19/2012 09:50:19 AM)
25	16	9.9	424.0	Yes	5563.2MHz, -64.0dBm	Single burst (11/19/2012 09:50:26 AM)
26	17	7.5	454.0	Yes	5558.2MHz, -64.0dBm	Single burst (11/19/2012 09:50:33 AM)
27	17	9.8	306.0	Yes	5568.2MHz, -64.0dBm	Single burst (11/19/2012 09:50:39 AM)
28	16	8.1	475.0	Yes	5563.2MHz, -64.0dBm	Single burst (11/19/2012 09:50:46 AM)
29	16	7.3	470.0	Yes	5558.2MHz, -64.0dBm	Single burst (11/19/2012 09:50:52 AM)
30	16	9.4	294.0	Yes	5568.2MHz, -64.0dBm	Single burst (11/19/2012 09:50:59 AM)

<b>Table 13 - FCC Short Pulse Radar (Type 4) Results CU-Acquire Hi-Band</b>						
Trial #	Pulses/ Burst	Pulse Width (us)	PRI (us)	Detected	Fr (MHz) and level (dBm)	Burst Information
1	15	16.0	205.0	Yes	5563.2MHz, -64.0dBm	Single burst (11/19/2012 10:06:33 AM)
2	13	17.4	404.0	Yes	5558.2MHz, -64.0dBm	Single burst (11/19/2012 10:06:43 AM)
3	16	15.2	330.0	Yes	5568.2MHz, -64.0dBm	Single burst (11/19/2012 10:06:50 AM)
4	15	19.1	248.0	Yes	5563.2MHz, -64.0dBm	Single burst (11/19/2012 10:06:57 AM)
5	15	16.6	349.0	Yes	5558.2MHz, -64.0dBm	Single burst (11/19/2012 10:07:04 AM)
6	15	12.9	201.0	No	5568.2MHz, -64.0dBm	Single burst (11/19/2012 10:07:11 AM)
7	15	14.0	426.0	Yes	5563.2MHz, -64.0dBm	Single burst (11/19/2012 10:07:28 AM)
8	15	12.7	212.0	Yes	5558.2MHz, -64.0dBm	Single burst (11/19/2012 10:07:36 AM)
9	15	16.0	380.0	Yes	5568.2MHz, -64.0dBm	Single burst (11/19/2012 10:07:43 AM)
10	15	11.5	255.0	No	5563.2MHz, -64.0dBm	Single burst (11/19/2012 10:07:50 AM)
11	14	13.4	466.0	Yes	5558.2MHz, -64.0dBm	Single burst (11/19/2012 10:08:02 AM)
12	16	12.1	322.0	Yes	5568.2MHz, -64.0dBm	Single burst (11/19/2012 10:08:11 AM)
13	15	13.7	416.0	Yes	5563.2MHz, -64.0dBm	Single burst (11/19/2012 10:08:18 AM)
14	14	15.7	451.0	Yes	5558.2MHz, -64.0dBm	Single burst (11/19/2012 10:08:25 AM)
15	12	16.2	418.0	Yes	5568.2MHz, -64.0dBm	Single burst (11/19/2012 10:08:32 AM)

<b>Table 13 - FCC Short Pulse Radar (Type 4) Results CU-Acquire Hi-Band</b>						
Trial #	Pulses/ Burst	Pulse Width (us)	PRI (us)	Detected	Fr (MHz) and level (dBm)	Burst Information
16	12	12.3	338.0	Yes	5563.2MHz, -64.0dBm	Single burst (11/19/2012 10:08:39 AM)
17	13	12.1	493.0	Yes	5558.2MHz, -64.0dBm	Single burst (11/19/2012 10:08:45 AM)
18	13	12.3	480.0	Yes	5568.2MHz, -64.0dBm	Single burst (11/19/2012 10:08:52 AM)
19	12	16.3	408.0	Yes	5563.2MHz, -64.0dBm	Single burst (11/19/2012 10:08:59 AM)
20	15	12.9	281.0	Yes	5558.2MHz, -64.0dBm	Single burst (11/19/2012 10:09:06 AM)
21	15	15.2	285.0	Yes	5568.2MHz, -64.0dBm	Single burst (11/19/2012 10:09:13 AM)
22	15	13.9	254.0	Yes	5563.2MHz, -64.0dBm	Single burst (11/19/2012 10:09:19 AM)
23	15	15.9	444.0	Yes	5558.2MHz, -64.0dBm	Single burst (11/19/2012 10:09:28 AM)
24	16	14.8	332.0	Yes	5568.2MHz, -64.0dBm	Single burst (11/19/2012 10:09:40 AM)
25	13	14.9	445.0	Yes	5563.2MHz, -64.0dBm	Single burst (11/19/2012 10:09:51 AM)
26	13	18.4	360.0	Yes	5558.2MHz, -64.0dBm	Single burst (11/19/2012 10:09:59 AM)
27	14	11.7	491.0	Yes	5568.2MHz, -64.0dBm	Single burst (11/19/2012 10:10:07 AM)
28	14	19.3	314.0	Yes	5563.2MHz, -64.0dBm	Single burst (11/19/2012 10:10:14 AM)
29	15	11.2	321.0	Yes	5558.2MHz, -64.0dBm	Single burst (11/19/2012 10:10:22 AM)
30	12	16.4	388.0	Yes	5568.2MHz, -64.0dBm	Single burst (11/19/2012 10:10:33 AM)

<b>Table 14 - Long Sequence Waveform Summary CU-Acquire Hi-Band</b>		
Long Sequence Trial	Result	Radar Frequency / Amplitude
Trial #1	Detected	5563.2MHz, -64.0dBm
Trial #2	Detected	5558.2MHz, -64.0dBm
Trial #3	Detected	5568.2MHz, -64.0dBm
Trial #4	Detected	5563.2MHz, -64.0dBm
Trial #5	Detected	5558.2MHz, -64.0dBm
Trial #6	Detected	5568.2MHz, -64.0dBm
Trial #7	Detected	5563.2MHz, -64.0dBm
Trial #8	Detected	5558.2MHz, -64.0dBm
Trial #9	Detected	5568.2MHz, -64.0dBm



Table 14 - Long Sequence Waveform Summary CU-Acquire Hi-Band		
Long Sequence Trial	Result	Radar Frequency / Amplitude
Trial #10	Detected	5563.2MHz, -64.0dBm
Trial #11	Detected	5558.2MHz, -64.0dBm
Trial #12	Detected	5568.2MHz, -64.0dBm
Trial #13	Detected	5563.2MHz, -64.0dBm
Trial #14	Detected	5558.2MHz, -64.0dBm
Trial #15	Detected	5568.2MHz, -64.0dBm
Trial #16	Detected	5563.2MHz, -64.0dBm
Trial #17	Detected	5558.2MHz, -64.0dBm
Trial #18	Detected	5568.2MHz, -64.0dBm
Trial #19	Detected	5563.2MHz, -64.0dBm
Trial #20	Detected	5558.2MHz, -64.0dBm
Trial #21	Detected	5568.2MHz, -64.0dBm
Trial #22	Detected	5563.2MHz, -64.0dBm
Trial #23	Detected	5558.2MHz, -64.0dBm
Trial #24	Detected	5568.2MHz, -64.0dBm
Trial #25	Detected	5563.2MHz, -64.0dBm
Trial #26	Detected	5558.2MHz, -64.0dBm
Trial #27	Detected	5568.2MHz, -64.0dBm
Trial #28	Detected	5563.2MHz, -64.0dBm
Trial #29	Detected	5558.2MHz, -64.0dBm
Trial #30	Detected	5568.2MHz, -64.0dBm

Table 15 - CU-Acquire Hi-Band Long Sequence Waveform Trial#1 (Detected)						
Burst #	# Pulses	Pulse Width (us)	Chirp (MHz)	Interval 1 to 2 (us)	Interval 2 to 3 (us)	Start time (s)
1	2	58.3	10	1619.0	-	0.996684
2	2	92.6	11	1732.0	-	1.629652
3	2	84.1	14	1097.0	-	3.208930
4	2	64.1	14	1784.0	-	5.787419
5	2	60.2	11	1922.0	-	6.063659
6	2	63.8	17	1641.0	-	7.939443
7	1	51.8	7	-	-	10.453938

<b>Table 15 - CU-Acquire Hi-Band Long Sequence Waveform Trial#1 (Detected)</b>						
Burst #	# Pulses	Pulse Width (us)	Chirp (MHz)	Interval 1 to 2 (us)	Interval 2 to 3 (us)	Start time (s)
8	3	58.4	8	1417.0	1805.0	11.701296

<b>Table 16 - CU-Acquire Hi-Band Long Sequence Waveform Trial#2 (Detected)</b>						
Burst #	# Pulses	Pulse Width (us)	Chirp (MHz)	Interval 1 to 2 (us)	Interval 2 to 3 (us)	Start time (s)
1	3	99.5	13	1258.0	1107.0	0.240248
2	1	75.1	13	-	-	1.541707
3	2	53.1	14	1357.0	-	2.198050
4	1	89.5	12	-	-	2.507276
5	3	67.5	7	1662.0	1181.0	3.335861
6	2	64.6	15	1073.0	-	4.274229
7	2	60.2	6	1083.0	-	5.459509
8	1	72.1	19	-	-	5.904411
9	1	98.4	11	-	-	7.081078
10	1	75.1	15	-	-	7.465140
11	2	54.4	11	1617.0	-	8.581798
12	2	71.0	10	1521.0	-	9.031864
13	2	67.0	16	1777.0	-	9.865826
14	1	50.9	15	-	-	10.664353
15	2	77.9	8	1879.0	-	11.276911

<b>Table 17 - CU-Acquire Hi-Band Long Sequence Waveform Trial#3 (Detected)</b>						
Burst #	# Pulses	Pulse Width (us)	Chirp (MHz)	Interval 1 to 2 (us)	Interval 2 to 3 (us)	Start time (s)
1	2	82.0	10	1547.0	-	0.273361
2	2	53.1	12	1526.0	-	1.021327
3	3	53.1	18	1122.0	1871.0	1.960243
4	1	69.8	12	-	-	2.898588
5	3	96.7	8	1068.0	1776.0	4.089531
6	2	50.7	14	1836.0	-	4.606134
7	2	68.8	8	1442.0	-	5.800117
8	1	98.1	20	-	-	6.471539
9	3	56.9	12	1865.0	1191.0	7.013071
10	1	78.2	9	-	-	8.499280
11	3	96.0	9	1814.0	1957.0	9.086593
12	2	56.3	12	1232.0	-	10.067744
13	2	77.9	14	1619.0	-	10.682465
14	3	80.6	9	1902.0	1276.0	11.655646

<b>Table 18 - CU-Acquire Hi-Band Long Sequence Waveform Trial#4 (Detected)</b>						
Burst #	# Pulses	Pulse Width (us)	Chirp (MHz)	Interval 1 to 2 (us)	Interval 2 to 3 (us)	Start time (s)
1	3	82.6	5	1530.0	1919.0	0.278406
2	2	74.6	16	1379.0	-	1.132106
3	1	90.9	10	-	-	1.500931
4	2	76.9	17	1559.0	-	2.275871
5	3	73.5	15	1347.0	1603.0	3.600761
6	2	91.3	9	1246.0	-	3.888537
7	3	51.4	8	1546.0	1506.0	4.923383

Burst #	# Pulses	Pulse Width (us)	Chirp (MHz)	Interval 1 to 2 (us)	Interval 2 to 3 (us)	Start time (s)
8	3	87.4	13	1044.0	1733.0	5.613837
9	3	76.9	8	1553.0	1589.0	6.220527
10	2	98.3	8	1495.0	-	7.375373
11	2	73.9	16	1644.0	-	7.786814
12	2	67.8	14	1226.0	-	8.760061
13	3	94.5	10	1142.0	1094.0	9.428738
14	3	59.1	17	1051.0	1075.0	9.802748
15	2	96.1	11	1923.0	-	10.790513
16	2	59.6	15	1026.0	-	11.915536

Burst #	# Pulses	Pulse Width (us)	Chirp (MHz)	Interval 1 to 2 (us)	Interval 2 to 3 (us)	Start time (s)
1	2	53.2	13	1832.0	-	0.311960
2	2	64.4	5	1605.0	-	1.346592
3	1	87.6	16	-	-	3.470272
4	1	78.0	15	-	-	4.813561
5	2	91.6	7	1380.0	-	6.431291
6	1	80.5	19	-	-	7.967452
7	2	75.7	19	1167.0	-	8.355253
8	3	70.6	12	1941.0	1512.0	10.008312
9	2	69.9	9	1592.0	-	10.858258

Burst #	# Pulses	Pulse Width (us)	Chirp (MHz)	Interval 1 to 2 (us)	Interval 2 to 3 (us)	Start time (s)
1	3	61.5	17	1587.0	1014.0	0.481309
2	3	89.9	15	1943.0	1214.0	1.397252
3	2	67.0	15	1429.0	-	2.365975
4	2	60.3	11	1556.0	-	2.711056
5	3	73.4	6	1752.0	1503.0	3.397088
6	2	58.5	9	1244.0	-	4.469753
7	2	93.9	8	1306.0	-	4.866928
8	3	92.0	8	1562.0	1448.0	5.713569
9	2	53.9	17	1206.0	-	7.028374
10	2	50.5	7	1419.0	-	7.755941
11	1	74.9	16	-	-	8.191549
12	1	88.8	10	-	-	8.819547
13	1	59.7	14	-	-	9.615316
14	2	98.5	13	1160.0	-	10.726758
15	3	61.5	8	1715.0	1646.0	11.428215

Burst #	# Pulses	Pulse Width (us)	Chirp (MHz)	Interval 1 to 2 (us)	Interval 2 to 3 (us)	Start time (s)
1	1	84.1	9	-	-	0.455689
2	2	88.1	12	1791.0	-	0.833174
3	2	95.2	9	1048.0	-	1.520851
4	1	99.3	8	-	-	1.965687

<b>Table 21 - CU-Acquire Hi-Band Long Sequence Waveform Trial#7 (Detected)</b>						
Burst #	# Pulses	Pulse Width (us)	Chirp (MHz)	Interval 1 to 2 (us)	Interval 2 to 3 (us)	Start time (s)
5	3	70.1	17	1625.0	1594.0	2.697981
6	3	95.9	16	1124.0	1395.0	3.250683
7	2	69.0	18	1149.0	-	3.845055
8	2	78.7	13	1428.0	-	4.447679
9	1	50.0	9	-	-	4.976788
10	2	96.6	19	1331.0	-	5.429660
11	3	69.3	11	1486.0	1245.0	6.460810
12	3	69.7	9	1115.0	1739.0	6.664765
13	3	58.6	9	1086.0	1283.0	7.757111
14	2	70.4	19	1145.0	-	8.034820
15	1	69.4	10	-	-	8.496123
16	2	58.2	11	1477.0	-	9.346108
17	1	77.6	16	-	-	9.867759
18	3	60.5	13	1522.0	1785.0	10.523791
19	2	54.6	18	1766.0	-	11.031601
20	2	77.0	17	1249.0	-	11.470675

<b>Table 22 - CU-Acquire Hi-Band Long Sequence Waveform Trial#8 (Detected)</b>						
Burst #	# Pulses	Pulse Width (us)	Chirp (MHz)	Interval 1 to 2 (us)	Interval 2 to 3 (us)	Start time (s)
1	2	55.6	10	1920.0	-	0.377778
2	2	94.3	18	1806.0	-	2.044351
3	1	73.1	6	-	-	2.898442
4	1	52.0	18	-	-	4.633173
5	3	51.6	13	1664.0	1779.0	6.308768
6	2	57.0	16	1762.0	-	7.337020
7	2	63.3	13	1029.0	-	9.211234
8	3	58.6	7	1259.0	1622.0	10.199533
9	1	65.4	18	-	-	11.819888

<b>Table 23 - CU-Acquire Hi-Band Long Sequence Waveform Trial#9 (Detected)</b>						
Burst #	# Pulses	Pulse Width (us)	Chirp (MHz)	Interval 1 to 2 (us)	Interval 2 to 3 (us)	Start time (s)
1	1	94.2	12	-	-	0.846669
2	3	80.9	10	1635.0	1237.0	0.930090
3	1	87.9	17	-	-	2.713124
4	3	51.6	15	1414.0	1921.0	2.870822
5	1	61.2	9	-	-	3.720114
6	2	63.5	12	1888.0	-	4.743000
7	2	51.8	7	1193.0	-	6.080682
8	3	60.5	16	1681.0	1169.0	6.996101
9	3	60.0	6	1421.0	1168.0	8.057381
10	1	94.0	14	-	-	9.057510
11	2	81.3	8	1880.0	-	9.328816
12	2	73.6	17	1213.0	-	10.427286
13	2	92.5	19	1962.0	-	11.720747

<b>Table 24 - CU-Acquire Hi-Band Long Sequence Waveform Trial#10 (Detected)</b>						
---	--	--	--	--	--	--

Burst #	# Pulses	Pulse Width (us)	Chirp (MHz)	Interval 1 to 2 (us)	Interval 2 to 3 (us)	Start time (s)
1	3	86.0	12	1692.0	1755.0	0.550808
2	1	59.7	11	-	-	1.295709
3	1	92.2	10	-	-	1.781441
4	1	98.5	14	-	-	2.768949
5	2	75.2	16	1709.0	-	3.192311
6	2	69.7	17	1740.0	-	3.953526
7	3	77.3	18	1090.0	1168.0	5.166671
8	3	87.1	13	1623.0	1764.0	5.493191
9	2	89.1	17	1393.0	-	6.055551
10	2	60.5	13	1884.0	-	6.799818
11	2	83.0	7	1481.0	-	7.612463
12	2	62.6	9	1094.0	-	8.703694
13	2	76.2	6	1349.0	-	9.715318
14	3	88.9	7	1916.0	1609.0	9.958556
15	1	87.5	7	-	-	10.586869
16	3	95.5	15	1563.0	1101.0	11.584094

**Table 25 - CU-Acquire Hi-Band Long Sequence Waveform Trial#11 (Detected)**

Burst #	# Pulses	Pulse Width (us)	Chirp (MHz)	Interval 1 to 2 (us)	Interval 2 to 3 (us)	Start time (s)
1	2	66.5	17	1398.0	-	0.957619
2	2	98.0	14	1700.0	-	1.487018
3	2	84.5	13	1347.0	-	2.374962
4	2	88.5	14	1592.0	-	3.596260
5	2	60.9	11	1228.0	-	4.436678
6	1	75.2	16	-	-	5.636911
7	2	76.9	8	1788.0	-	7.091992
8	2	92.7	8	1949.0	-	8.519728
9	3	80.1	16	1343.0	1727.0	9.786802
10	2	94.3	7	1327.0	-	10.321391
11	2	89.8	18	1531.0	-	11.960344

**Table 26 - CU-Acquire Hi-Band Long Sequence Waveform Trial#12 (Detected)**

Burst #	# Pulses	Pulse Width (us)	Chirp (MHz)	Interval 1 to 2 (us)	Interval 2 to 3 (us)	Start time (s)
1	2	76.1	19	1277.0	-	0.055094
2	3	74.2	18	1739.0	1459.0	1.236470
3	1	58.0	8	-	-	1.623790
4	2	89.4	15	1699.0	-	2.402657
5	2	78.0	12	1129.0	-	3.898190
6	2	64.1	17	1347.0	-	4.452451
7	1	86.6	8	-	-	4.862614
8	3	85.8	12	1811.0	1038.0	5.909093
9	1	91.7	20	-	-	6.531273
10	1	81.0	11	-	-	7.424417
11	1	58.0	17	-	-	8.688421
12	2	56.3	17	1354.0	-	9.277401
13	2	79.7	6	1072.0	-	10.204807
14	3	81.8	19	1240.0	1759.0	10.894635
15	2	56.4	17	1063.0	-	11.850705

<b>Table 27 - CU-Acquire Hi-Band Long Sequence Waveform Trial#13 (Detected)</b>						
Burst #	# Pulses	Pulse Width (us)	Chirp (MHz)	Interval 1 to 2 (us)	Interval 2 to 3 (us)	Start time (s)
1	1	60.2	7	-	-	0.100386
2	2	72.3	7	1227.0	-	1.954421
3	1	86.5	7	-	-	2.473328
4	2	59.4	5	1011.0	-	4.047166
5	3	58.0	19	1818.0	1792.0	5.368482
6	3	77.6	14	1640.0	1973.0	6.120354
7	3	92.3	10	1825.0	1065.0	6.697574
8	1	86.9	16	-	-	8.529935
9	2	68.3	15	1370.0	-	9.067211
10	1	68.9	17	-	-	10.539145
11	2	70.4	18	1912.0	-	11.252136

<b>Table 28 - CU-Acquire Hi-Band Long Sequence Waveform Trial#14 (Detected)</b>						
Burst #	# Pulses	Pulse Width (us)	Chirp (MHz)	Interval 1 to 2 (us)	Interval 2 to 3 (us)	Start time (s)
1	1	88.2	9	-	-	0.054061
2	2	88.1	10	1389.0	-	0.838195
3	2	98.6	17	1929.0	-	1.914991
4	2	93.3	11	1445.0	-	2.362148
5	1	58.7	12	-	-	2.949306
6	2	63.2	18	1390.0	-	3.358449
7	2	63.0	12	1701.0	-	4.311635
8	2	92.2	12	1656.0	-	4.841770
9	2	65.5	13	1807.0	-	5.722895
10	3	67.2	10	1661.0	1274.0	6.168637
11	3	54.5	16	1139.0	1581.0	6.855599
12	3	97.5	17	1984.0	1810.0	7.959974
13	2	53.3	14	1433.0	-	8.057329
14	3	90.8	16	1956.0	1286.0	8.666687
15	1	67.6	5	-	-	9.361411
16	3	57.5	6	1324.0	1464.0	10.183962
17	1	84.1	7	-	-	10.706468
18	2	92.4	19	1642.0	-	11.723273

<b>Table 29 - CU-Acquire Hi-Band Long Sequence Waveform Trial#15 (Detected)</b>						
Burst #	# Pulses	Pulse Width (us)	Chirp (MHz)	Interval 1 to 2 (us)	Interval 2 to 3 (us)	Start time (s)
1	3	59.3	9	1195.0	1938.0	0.703575
2	1	87.0	16	-	-	1.298902
3	2	75.8	10	1853.0	-	2.406324
4	2	98.8	15	1197.0	-	3.573473
5	2	66.5	14	1693.0	-	4.390121
6	1	93.6	14	-	-	5.745366
7	1	96.8	13	-	-	6.401121
8	2	95.8	11	1402.0	-	7.457117
9	2	62.3	9	1594.0	-	8.436589
10	2	71.1	12	1644.0	-	9.015524
11	3	62.9	16	1002.0	1609.0	10.586481
12	2	97.3	5	1094.0	-	11.629015

Burst #	# Pulses	Pulse Width (us)	Chirp (MHz)	Interval 1 to 2 (us)	Interval 2 to 3 (us)	Start time (s)
1	1	52.3	20	-	-	0.222871
2	2	69.2	6	1490.0	-	1.361431
3	2	97.9	16	1949.0	-	1.873960
4	2	68.3	6	1408.0	-	2.959950
5	1	75.2	11	-	-	3.453131
6	2	78.4	17	1391.0	-	4.170880
7	1	92.9	15	-	-	4.984706
8	2	63.9	12	1722.0	-	5.585067
9	1	60.7	6	-	-	6.674466
10	2	62.3	14	1286.0	-	6.960239
11	2	96.8	12	1739.0	-	7.860424
12	2	80.6	15	1814.0	-	8.776451
13	2	57.4	15	1957.0	-	9.582070
14	2	51.7	8	1196.0	-	9.837874
15	2	64.8	19	1591.0	-	11.119814
16	2	67.5	7	1832.0	-	11.760958

Burst #	# Pulses	Pulse Width (us)	Chirp (MHz)	Interval 1 to 2 (us)	Interval 2 to 3 (us)	Start time (s)
1	3	80.9	8	1501.0	1497.0	0.256874
2	2	96.5	7	1614.0	-	1.944880
3	2	82.6	16	1927.0	-	3.250569
4	3	79.4	19	1772.0	1317.0	3.675721
5	2	78.0	12	1889.0	-	5.219418
6	2	98.2	6	1869.0	-	6.660909
7	2	50.5	14	1379.0	-	8.127561
8	2	53.5	18	1894.0	-	9.046995
9	2	71.4	16	1965.0	-	10.040256
10	3	82.3	13	1274.0	1395.0	11.964541

Burst #	# Pulses	Pulse Width (us)	Chirp (MHz)	Interval 1 to 2 (us)	Interval 2 to 3 (us)	Start time (s)
1	3	82.4	16	1387.0	1533.0	0.366776
2	3	72.5	14	1706.0	1664.0	1.062906
3	2	93.4	7	1553.0	-	1.586557
4	3	92.4	12	1624.0	1093.0	1.949764
5	2	60.8	8	1419.0	-	2.958204
6	2	56.7	12	1467.0	-	3.053812
7	1	58.3	16	-	-	3.857528
8	2	58.8	7	1856.0	-	4.322878
9	2	52.2	10	1003.0	-	5.289549
10	3	97.0	18	1666.0	1799.0	5.996009
11	3	61.0	17	1616.0	1309.0	6.054368
12	2	64.9	17	1829.0	-	7.143578
13	2	87.6	10	1493.0	-	7.335200
14	2	95.8	15	1943.0	-	8.290959
15	2	86.7	16	1282.0	-	8.917142
16	1	89.7	13	-	-	9.405900

<b>Table 32 - CU-Acquire Hi-Band Long Sequence Waveform Trial#18 (Detected)</b>						
Burst #	# Pulses	Pulse Width (us)	Chirp (MHz)	Interval 1 to 2 (us)	Interval 2 to 3 (us)	Start time (s)
17	1	50.3	12	-	-	9.759975
18	2	53.9	8	1692.0	-	10.256418
19	1	96.6	11	-	-	11.315506
20	2	92.6	17	1954.0	-	11.784615

<b>Table 33 - CU-Acquire Hi-Band Long Sequence Waveform Trial#19 (Detected)</b>						
Burst #	# Pulses	Pulse Width (us)	Chirp (MHz)	Interval 1 to 2 (us)	Interval 2 to 3 (us)	Start time (s)
1	3	51.7	18	1175.0	1010.0	0.245838
2	2	91.7	16	1351.0	-	1.324325
3	2	99.3	7	1019.0	-	1.923580
4	2	83.6	14	1724.0	-	2.792751
5	2	87.9	20	1764.0	-	3.678082
6	2	55.8	11	1342.0	-	4.081329
7	3	59.2	17	1108.0	1396.0	5.228782
8	1	50.6	7	-	-	5.398933
9	2	66.5	15	1766.0	-	6.281897
10	3	92.8	18	1560.0	1414.0	7.249906
11	3	96.1	20	1973.0	1862.0	7.714568
12	3	56.0	19	1530.0	1015.0	8.769927
13	1	86.0	16	-	-	9.722949
14	2	100.0	6	1923.0	-	10.497159
15	3	52.5	8	1430.0	1701.0	11.211207
16	2	53.1	17	1843.0	-	11.613503

<b>Table 34 - CU-Acquire Hi-Band Long Sequence Waveform Trial#20 (Detected)</b>						
Burst #	# Pulses	Pulse Width (us)	Chirp (MHz)	Interval 1 to 2 (us)	Interval 2 to 3 (us)	Start time (s)
1	2	67.8	16	1812.0	-	0.287221
2	1	87.5	9	-	-	0.864758
3	1	62.7	18	-	-	2.013866
4	3	95.7	19	1744.0	1257.0	2.930109
5	2	79.5	15	1313.0	-	3.677562
6	2	84.7	14	1951.0	-	4.143438
7	2	89.5	9	1603.0	-	4.867645
8	2	67.6	13	1866.0	-	6.112536
9	1	57.0	6	-	-	6.573942
10	2	85.1	16	1117.0	-	7.616567
11	2	86.7	13	1024.0	-	8.308251
12	3	75.7	18	1295.0	1080.0	8.971949
13	2	96.0	7	1752.0	-	10.302141
14	2	99.9	8	1194.0	-	11.073978
15	2	79.5	7	1157.0	-	11.620021

<b>Table 35 - CU-Acquire Hi-Band Long Sequence Waveform Trial#21 (Detected)</b>						
Burst #	# Pulses	Pulse Width (us)	Chirp (MHz)	Interval 1 to 2 (us)	Interval 2 to 3 (us)	Start time (s)
1	2	90.9	7	1331.0	-	0.425399
2	2	62.8	15	1047.0	-	0.636681



<b>Table 35 - CU-Acquire Hi-Band Long Sequence Waveform Trial#21 (Detected)</b>						
Burst #	# Pulses	Pulse Width (us)	Chirp (MHz)	Interval 1 to 2 (us)	Interval 2 to 3 (us)	Start time (s)
3	2	78.5	8	1034.0	-	1.735210
4	1	53.0	6	-	-	1.867626
5	3	61.8	6	1910.0	1677.0	2.809532
6	2	94.8	18	1963.0	-	3.245696
7	1	65.0	8	-	-	4.049438
8	2	88.2	16	1814.0	-	4.269013
9	1	82.8	13	-	-	4.885422
10	1	70.9	11	-	-	5.530915
11	1	61.2	13	-	-	6.107608
12	3	79.0	18	1768.0	1143.0	7.180282
13	3	68.8	9	1123.0	1056.0	7.323276
14	3	78.0	10	1304.0	1816.0	8.138416
15	3	91.1	9	1523.0	1804.0	8.858322
16	2	51.6	6	1323.0	-	9.076653
17	1	81.9	13	-	-	9.733225
18	1	79.0	5	-	-	10.632445
19	3	94.4	15	1865.0	1260.0	11.206714
20	1	82.9	14	-	-	11.859372

<b>Table 36 - CU-Acquire Hi-Band Long Sequence Waveform Trial#22 (Detected)</b>						
Burst #	# Pulses	Pulse Width (us)	Chirp (MHz)	Interval 1 to 2 (us)	Interval 2 to 3 (us)	Start time (s)
1	3	68.0	14	1805.0	1728.0	0.843078
2	2	84.6	17	1722.0	-	1.957884
3	2	78.0	14	1648.0	-	2.615810
4	3	57.9	8	1025.0	1497.0	3.326012
5	3	59.3	8	1844.0	1820.0	4.891970
6	1	72.4	9	-	-	5.071395
7	2	59.2	14	1738.0	-	6.108610
8	2	78.1	9	1717.0	-	7.373792
9	1	66.5	5	-	-	8.969661
10	2	65.6	12	1525.0	-	9.225633
11	2	75.4	6	1275.0	-	10.577567
12	2	95.0	19	1276.0	-	11.647852

<b>Table 37 - CU-Acquire Hi-Band Long Sequence Waveform Trial#23 (Detected)</b>						
Burst #	# Pulses	Pulse Width (us)	Chirp (MHz)	Interval 1 to 2 (us)	Interval 2 to 3 (us)	Start time (s)
1	2	77.9	11	1303.0	-	0.391127
2	1	65.1	18	-	-	0.788936
3	1	71.4	13	-	-	1.724665
4	2	70.6	11	1988.0	-	1.926046
5	3	99.6	14	1363.0	1248.0	2.696671
6	2	71.4	5	1410.0	-	3.479713
7	2	50.7	8	1438.0	-	4.317817
8	1	94.4	12	-	-	4.811250
9	1	69.2	14	-	-	5.285135
10	1	52.4	15	-	-	6.235743
11	2	79.1	6	1742.0	-	6.553758
12	2	70.3	7	1841.0	-	7.226227

<b>Table 37 - CU-Acquire Hi-Band Long Sequence Waveform Trial#23 (Detected)</b>						
Burst #	# Pulses	Pulse Width (us)	Chirp (MHz)	Interval 1 to 2 (us)	Interval 2 to 3 (us)	Start time (s)
13	2	67.4	8	1435.0	-	8.004059
14	2	54.7	6	1873.0	-	8.329202
15	3	100.0	9	1439.0	1078.0	8.855389
16	1	62.0	18	-	-	9.592757
17	3	54.2	10	1497.0	1251.0	10.601767
18	2	83.2	10	1686.0	-	11.017963
19	2	99.8	20	1042.0	-	11.823417

<b>Table 38 - CU-Acquire Hi-Band Long Sequence Waveform Trial#24 (Detected)</b>						
Burst #	# Pulses	Pulse Width (us)	Chirp (MHz)	Interval 1 to 2 (us)	Interval 2 to 3 (us)	Start time (s)
1	2	54.8	6	1467.0	-	0.678368
2	3	62.3	5	1650.0	1431.0	2.145148
3	2	87.9	15	1214.0	-	2.447890
4	2	58.7	5	1961.0	-	4.191172
5	3	76.2	19	1341.0	1241.0	5.248047
6	2	80.0	14	1995.0	-	6.287588
7	1	60.4	13	-	-	7.679475
8	2	74.2	8	1443.0	-	8.673375
9	2	85.8	11	1470.0	-	10.530274
10	1	93.6	18	-	-	11.330681

<b>Table 39 - CU-Acquire Hi-Band Long Sequence Waveform Trial#25 (Detected)</b>						
Burst #	# Pulses	Pulse Width (us)	Chirp (MHz)	Interval 1 to 2 (us)	Interval 2 to 3 (us)	Start time (s)
1	2	95.2	15	1066.0	-	0.495569
2	1	89.7	13	-	-	1.254309
3	2	87.7	19	1726.0	-	2.124683
4	2	72.5	18	1908.0	-	2.901926
5	2	85.9	17	1550.0	-	3.604559
6	2	58.3	11	1909.0	-	4.022273
7	3	66.1	17	1252.0	1395.0	5.110445
8	2	94.0	18	1889.0	-	5.536609
9	2	90.7	15	1515.0	-	6.400471
10	3	75.3	9	1725.0	1379.0	7.266395
11	2	71.4	11	1848.0	-	8.193143
12	3	71.0	14	1445.0	1641.0	8.543075
13	2	66.2	7	1017.0	-	9.104799
14	2	69.8	13	1240.0	-	9.898609
15	2	69.6	8	1762.0	-	10.893501
16	2	87.9	18	1189.0	-	11.666373

<b>Table 40 - CU-Acquire Hi-Band Long Sequence Waveform Trial#26 (Detected)</b>						
Burst #	# Pulses	Pulse Width (us)	Chirp (MHz)	Interval 1 to 2 (us)	Interval 2 to 3 (us)	Start time (s)
1	3	55.7	18	1936.0	1285.0	0.096678
2	2	82.0	15	1106.0	-	1.017810
3	1	98.0	12	-	-	2.722899
4	1	85.6	12	-	-	3.203258

<b>Table 40 - CU-Acquire Hi-Band Long Sequence Waveform Trial#26 (Detected)</b>						
Burst #	# Pulses	Pulse Width (us)	Chirp (MHz)	Interval 1 to 2 (us)	Interval 2 to 3 (us)	Start time (s)
5	3	59.3	18	1894.0	1934.0	4.835888
6	1	92.1	16	-	-	5.973638
7	2	85.0	10	1747.0	-	6.348968
8	1	85.4	7	-	-	7.521229
9	1	97.3	19	-	-	8.758456
10	2	63.9	7	1767.0	-	9.776512
11	2	72.2	16	1336.0	-	10.673235
12	1	79.4	19	-	-	11.733549

<b>Table 41 - CU-Acquire Hi-Band Long Sequence Waveform Trial#27 (Detected)</b>						
Burst #	# Pulses	Pulse Width (us)	Chirp (MHz)	Interval 1 to 2 (us)	Interval 2 to 3 (us)	Start time (s)
1	2	67.5	15	1480.0	-	0.470818
2	3	63.0	17	1749.0	1757.0	1.323376
3	2	74.1	16	1291.0	-	2.322360
4	3	69.5	16	1785.0	1661.0	3.563391
5	2	78.0	10	1040.0	-	4.156339
6	3	62.2	17	1810.0	1090.0	4.652453
7	3	82.0	19	1380.0	1448.0	6.013281
8	2	92.2	10	1977.0	-	7.050998
9	3	61.0	12	1247.0	1060.0	8.057728
10	2	76.8	11	1429.0	-	8.431016
11	1	87.6	15	-	-	10.093237
12	2	99.9	12	1218.0	-	10.568115
13	1	69.4	11	-	-	11.749799

<b>Table 42 - CU-Acquire Hi-Band Long Sequence Waveform Trial#28 (Detected)</b>						
Burst #	# Pulses	Pulse Width (us)	Chirp (MHz)	Interval 1 to 2 (us)	Interval 2 to 3 (us)	Start time (s)
1	2	53.2	13	1180.0	-	0.182061
2	1	55.6	10	-	-	1.192212
3	3	80.2	16	1875.0	1873.0	1.628767
4	1	68.6	14	-	-	1.948100
5	2	53.0	13	1277.0	-	2.850703
6	2	87.5	7	1377.0	-	3.302505
7	2	57.5	5	1041.0	-	4.386871
8	3	73.8	14	1681.0	1039.0	4.930879
9	1	87.6	19	-	-	5.369131
10	1	61.2	13	-	-	6.064188
11	3	96.4	11	1043.0	1281.0	6.483684
12	3	97.7	16	1286.0	1598.0	7.065719
13	1	83.6	18	-	-	7.980124
14	1	89.0	11	-	-	8.795327
15	2	77.9	12	1949.0	-	9.088800
16	2	88.8	16	1589.0	-	9.775104
17	2	63.6	11	1460.0	-	10.550849
18	2	59.9	9	1186.0	-	11.357584
19	2	56.7	9	1350.0	-	11.742234

<b>Table 43 - CU-Acquire Hi-Band Long Sequence Waveform Trial#29 (Detected)</b>						
Burst #	# Pulses	Pulse Width (us)	Chirp (MHz)	Interval 1 to 2 (us)	Interval 2 to 3 (us)	Start time (s)
1	2	54.7	18	1187.0	-	0.679076
2	1	88.7	14	-	-	1.521010
3	2	54.6	9	1267.0	-	2.340616
4	2	56.2	7	1045.0	-	2.455791
5	3	59.0	14	1395.0	1623.0	3.804277
6	2	58.8	17	1729.0	-	4.089678
7	1	93.8	6	-	-	5.558924
8	2	50.9	6	1812.0	-	5.695487
9	2	93.1	14	1425.0	-	7.044662
10	2	88.0	17	1896.0	-	7.554249
11	2	68.4	16	1437.0	-	8.020412
12	2	93.5	10	1343.0	-	9.184239
13	3	99.0	6	1105.0	1261.0	10.131538
14	3	79.9	14	1697.0	1052.0	10.844592
15	2	51.0	20	1597.0	-	11.935760

<b>Table 44 - CU-Acquire Hi-Band Long Sequence Waveform Trial#30 (Detected)</b>						
Burst #	# Pulses	Pulse Width (us)	Chirp (MHz)	Interval 1 to 2 (us)	Interval 2 to 3 (us)	Start time (s)
1	3	67.9	19	1281.0	1263.0	0.833193
2	1	58.1	5	-	-	1.427731
3	1	50.9	6	-	-	1.793712
4	3	68.2	20	1329.0	1169.0	3.088327
5	1	90.2	6	-	-	4.024579
6	2	53.8	20	1756.0	-	5.087086
7	2	67.3	20	1867.0	-	5.170421
8	2	75.0	9	1401.0	-	6.450266
9	3	57.4	18	1312.0	1686.0	7.099642
10	3	96.8	13	1121.0	1723.0	7.931025
11	2	61.4	7	1770.0	-	9.339173
12	2	68.6	13	1917.0	-	9.735546
13	2	87.8	14	1796.0	-	11.094729
14	1	94.2	14	-	-	11.941169

<b>Table 45 - FCC frequency hopping radar (Type 6) Results CU-Acquire Hi-Band</b>						
Trial #	Pulses/Burst	Pulse Width (us)	PRI (us)	Detected	Fr (MHz) and level (dBm)	Burst Information

Table 45 - FCC frequency hopping radar (Type 6) Results CU-Acquire Hi-Band						
Trial #	Pulses/ Burst	Pulse Width (us)	PRI (us)	Detected	Fr (MHz) and level (dBm)	Burst Information
1	9	1.0	333.0	Yes	5572.2MHz, -64.0dBm	Hop sequence: 5353, 5257, 5562, 5309, 5659, 5672, 5494, 5520, 5369, 5521, 5490, 5341, 5556, 5321, 5511, 5474, 5616, 5607, 5406, 5426, 5274, 5632, 5355, 5361, 5403, 5620, 5362, 5597, 5547, 5571, 5648, 5599, 5326, 5569, 5379, 5288, 5440, 5407, 5681, 5514, 5548, 5705, 5713, 5540, 5264, 5633, 5253, 5637, 5592, 5529, 5323, 5388, 5397, 5506, 5454, 5665, 5452, 5664, 5496, 5300, 5262, 5534, 5693, 5377, 5459, 5566, 5480, 5387, 5348, 5422, 5695, 5330, 5446, 5680, 5400, 5327, 5424, 5335, 5624, 5306, 5395, 5565, 5541, 5287, 5528, 5442, 5495, 5602, 5279, 5542, 5720, 5517, 5315, 5310, 5515, 5500, 5505, 5265, 5638, 5389 (6 hits) (11/19/2012 10:31:39 AM)
2	9	1.0	333.0	Yes	5573.2MHz, -64.0dBm	Hop sequence: 5297, 5535, 5364, 5363, 5325, 5408, 5309, 5614, 5307, 5496, 5497, 5454, 5427, 5409, 5258, 5650, 5399, 5717, 5528, 5609, 5499, 5627, 5696, 5464, 5473, 5651, 5641, 5308, 5442, 5344, 5272, 5329, 5520, 5597, 5255, 5542, 5447, 5636, 5619, 5607, 5582, 5690, 5525, 5392, 5299, 5477, 5277, 5422, 5366, 5276, 5665, 5266, 5444, 5372, 5647, 5688, 5360, 5397, 5697, 5618, 5455, 5509, 5481, 5331, 5502, 5679, 5663, 5463, 5668, 5268, 5523, 5453, 5462, 5338, 5501, 5415, 5603, 5322, 5353, 5362, 5479, 5386, 5341, 5612, 5550, 5662, 5450, 5594, 5358, 5254, 5639, 5294, 5324, 5583, 5551, 5608, 5515, 5578, 5521, 5556 (1 hits) (11/19/2012 10:31:59 AM)

Table 45 - FCC frequency hopping radar (Type 6) Results CU-Acquire Hi-Band						
Trial #	Pulses/ Burst	Pulse Width (us)	PRI (us)	Detected	Fr (MHz) and level (dBm)	Burst Information
3	9	1.0	333.0	Yes	5553.2MHz, -64.0dBm	Hop sequence: 5341, 5574, 5283, 5595, 5600, 5294, 5634, 5291, 5315, 5392, 5454, 5478, 5696, 5256, 5349, 5486, 5525, 5578, 5277, 5354, 5598, 5469, 5715, 5643, 5555, 5421, 5479, 5370, 5285, 5356, 5377, 5369, 5664, 5365, 5408, 5630, 5497, 5368, 5384, 5330, 5363, 5580, 5332, 5581, 5342, 5693, 5446, 5343, 5452, 5723, 5304, 5527, 5367, 5353, 5566, 5374, 5660, 5259, 5279, 5704, 5625, 5652, 5654, 5599, 5546, 5261, 5647, 5362, 5520, 5570, 5322, 5529, 5357, 5709, 5540, 5505, 5588, 5420, 5253, 5603, 5442, 5499, 5679, 5513, 5325, 5388, 5449, 5719, 5567, 5568, 5252, 5272, 5632, 5477, 5414, 5358, 5432, 5508, 5385, 5627 (5 hits) (11/19/2012 10:32:07 AM)
4	9	1.0	333.0	Yes	5554.2MHz, -64.0dBm	Hop sequence: 5684, 5590, 5538, 5291, 5690, 5483, 5348, 5292, 5479, 5307, 5508, 5314, 5252, 5371, 5611, 5441, 5318, 5286, 5285, 5627, 5264, 5351, 5417, 5490, 5484, 5688, 5626, 5324, 5710, 5272, 5495, 5257, 5536, 5635, 5709, 5546, 5355, 5676, 5335, 5604, 5294, 5344, 5720, 5717, 5659, 5293, 5695, 5712, 5347, 5686, 5605, 5718, 5472, 5366, 5329, 5456, 5454, 5266, 5476, 5656, 5574, 5584, 5701, 5501, 5492, 5636, 5262, 5370, 5512, 5560, 5518, 5665, 5453, 5300, 5723, 5389, 5566, 5666, 5696, 5357, 5642, 5618, 5382, 5670, 5255, 5331, 5679, 5706, 5702, 5327, 5725, 5446, 5449, 5273, 5416, 5616, 5567, 5556, 5253, 5343 (4 hits) (11/19/2012 10:32:58 AM)

Table 45 - FCC frequency hopping radar (Type 6) Results CU-Acquire Hi-Band						
Trial #	Pulses/ Burst	Pulse Width (us)	PRI (us)	Detected	Fr (MHz) and level (dBm)	Burst Information
5	9	1.0	333.0	Yes	5555.2MHz, -64.0dBm	Hop sequence: 5313, 5403, 5414, 5363, 5537, 5690, 5654, 5723, 5541, 5706, 5379, 5251, 5704, 5253, 5434, 5494, 5580, 5681, 5331, 5665, 5719, 5618, 5326, 5335, 5502, 5272, 5292, 5280, 5448, 5435, 5323, 5359, 5531, 5577, 5700, 5347, 5549, 5392, 5558, 5668, 5699, 5498, 5532, 5691, 5586, 5278, 5510, 5402, 5340, 5617, 5603, 5437, 5595, 5476, 5364, 5553, 5562, 5611, 5410, 5683, 5560, 5273, 5521, 5387, 5525, 5442, 5718, 5492, 5360, 5343, 5568, 5346, 5593, 5479, 5298, 5460, 5534, 5701, 5652, 5503, 5514, 5308, 5530, 5552, 5422, 5724, 5533, 5697, 5653, 5341, 5556, 5561, 5651, 5672, 5391, 5529, 5496, 5513, 5485, 5500 (6 hits) (11/19/2012 10:33:07 AM)
6	9	1.0	333.0	Yes	5556.2MHz, -64.0dBm	Hop sequence: 5605, 5477, 5501, 5631, 5460, 5710, 5714, 5571, 5521, 5450, 5683, 5624, 5662, 5479, 5313, 5426, 5358, 5278, 5566, 5505, 5511, 5471, 5642, 5356, 5648, 5672, 5396, 5708, 5420, 5563, 5299, 5650, 5611, 5401, 5543, 5671, 5469, 5373, 5559, 5342, 5570, 5649, 5360, 5579, 5430, 5324, 5304, 5478, 5350, 5597, 5659, 5524, 5437, 5362, 5705, 5595, 5285, 5446, 5372, 5618, 5531, 5528, 5620, 5432, 5568, 5590, 5516, 5451, 5701, 5291, 5287, 5400, 5675, 5581, 5602, 5368, 5334, 5560, 5453, 5344, 5535, 5284, 5361, 5483, 5398, 5417, 5610, 5260, 5704, 5327, 5305, 5338, 5253, 5639, 5464, 5629, 5660, 5300, 5424, 5447 (7 hits) (11/19/2012 10:33:17 AM)

Table 45 - FCC frequency hopping radar (Type 6) Results CU-Acquire Hi-Band						
Trial #	Pulses/ Burst	Pulse Width (us)	PRI (us)	Detected	Fr (MHz) and level (dBm)	Burst Information
7	9	1.0	333.0	Yes	5557.2MHz, -64.0dBm	Hop sequence: 5667, 5710, 5540, 5708, 5286, 5524, 5596, 5560, 5716, 5451, 5374, 5269, 5522, 5369, 5692, 5311, 5299, 5705, 5583, 5668, 5465, 5580, 5627, 5324, 5440, 5500, 5505, 5614, 5599, 5384, 5255, 5264, 5262, 5401, 5301, 5409, 5697, 5588, 5696, 5511, 5291, 5675, 5490, 5721, 5468, 5434, 5594, 5469, 5538, 5456, 5642, 5654, 5386, 5414, 5609, 5572, 5282, 5521, 5658, 5344, 5263, 5615, 5448, 5316, 5361, 5405, 5273, 5629, 5574, 5392, 5376, 5556, 5391, 5703, 5530, 5552, 5610, 5314, 5587, 5417, 5471, 5515, 5501, 5496, 5548, 5462, 5425, 5507, 5337, 5397, 5323, 5691, 5508, 5612, 5513, 5649, 5680, 5432, 5460, 5619 (3 hits) (11/19/2012 10:33:28 AM)
8	9	1.0	333.0	Yes	5558.2MHz, -64.0dBm	Hop sequence: 5671, 5661, 5401, 5454, 5439, 5411, 5409, 5490, 5560, 5274, 5696, 5592, 5588, 5304, 5425, 5383, 5475, 5432, 5570, 5426, 5552, 5516, 5365, 5664, 5343, 5678, 5396, 5705, 5272, 5586, 5261, 5591, 5568, 5558, 5689, 5639, 5559, 5379, 5393, 5423, 5443, 5600, 5466, 5573, 5518, 5613, 5595, 5481, 5717, 5251, 5434, 5419, 5703, 5683, 5387, 5652, 5699, 5543, 5626, 5319, 5252, 5437, 5258, 5606, 5537, 5706, 5440, 5484, 5305, 5644, 5548, 5279, 5621, 5562, 5282, 5398, 5630, 5320, 5617, 5451, 5255, 5358, 5368, 5250, 5397, 5529, 5362, 5549, 5679, 5538, 5431, 5353, 5356, 5665, 5698, 5572, 5533, 5407, 5535, 5500 (8 hits) (11/19/2012 10:33:35 AM)



Table 45 - FCC frequency hopping radar (Type 6) Results CU-Acquire Hi-Band						
Trial #	Pulses/ Burst	Pulse Width (us)	PRI (us)	Detected	Fr (MHz) and level (dBm)	Burst Information
9	9	1.0	333.0	Yes	5559.2MHz, -64.0dBm	Hop sequence: 5466, 5450, 5710, 5275, 5429, 5452, 5361, 5310, 5675, 5717, 5265, 5436, 5719, 5534, 5549, 5720, 5655, 5382, 5324, 5388, 5561, 5368, 5438, 5272, 5372, 5539, 5358, 5379, 5516, 5623, 5546, 5386, 5619, 5705, 5432, 5369, 5607, 5407, 5397, 5547, 5469, 5636, 5637, 5434, 5646, 5673, 5359, 5350, 5380, 5566, 5402, 5327, 5318, 5650, 5548, 5594, 5309, 5444, 5256, 5292, 5609, 5421, 5353, 5342, 5305, 5563, 5497, 5653, 5520, 5376, 5491, 5697, 5277, 5435, 5620, 5492, 5564, 5375, 5270, 5698, 5506, 5701, 5708, 5461, 5262, 5355, 5632, 5599, 5456, 5271, 5691, 5426, 5656, 5253, 5311, 5371, 5586, 5449, 5273, 5316 (4 hits) (11/19/2012 10:33:44 AM)
10	9	1.0	333.0	Yes	5560.2MHz, -64.0dBm	Hop sequence: 5365, 5678, 5655, 5705, 5630, 5411, 5568, 5429, 5588, 5625, 5271, 5400, 5425, 5628, 5420, 5596, 5412, 5629, 5447, 5604, 5404, 5642, 5490, 5577, 5683, 5520, 5512, 5586, 5481, 5486, 5343, 5450, 5672, 5659, 5685, 5482, 5360, 5333, 5506, 5331, 5546, 5723, 5605, 5639, 5294, 5329, 5320, 5503, 5712, 5489, 5631, 5652, 5280, 5352, 5664, 5255, 5564, 5266, 5719, 5491, 5279, 5369, 5408, 5345, 5472, 5540, 5599, 5500, 5263, 5576, 5367, 5363, 5431, 5426, 5646, 5601, 5636, 5560, 5474, 5339, 5583, 5252, 5608, 5528, 5548, 5410, 5597, 5287, 5544, 5269, 5321, 5680, 5277, 5598, 5286, 5382, 5660, 5519, 5376, 5658 (3 hits) (11/19/2012 10:33:51 AM)

Table 45 - FCC frequency hopping radar (Type 6) Results CU-Acquire Hi-Band						
Trial #	Pulses/ Burst	Pulse Width (us)	PRI (us)	Detected	Fr (MHz) and level (dBm)	Burst Information
11	9	1.0	333.0	No	5561.2MHz, -64.0dBm	Hop sequence: 5708, 5255, 5324, 5600, 5721, 5269, 5250, 5256, 5610, 5519, 5265, 5456, 5307, 5432, 5470, 5663, 5444, 5659, 5328, 5579, 5540, 5433, 5668, 5277, 5303, 5640, 5501, 5270, 5331, 5554, 5719, 5274, 5257, 5353, 5381, 5614, 5329, 5325, 5351, 5581, 5541, 5679, 5701, 5426, 5633, 5646, 5339, 5680, 5692, 5697, 5275, 5678, 5496, 5670, 5689, 5559, 5440, 5521, 5691, 5306, 5481, 5495, 5672, 5605, 5430, 5530, 5438, 5259, 5423, 5649, 5412, 5341, 5624, 5416, 5630, 5295, 5706, 5300, 5489, 5343, 5514, 5613, 5507, 5549, 5285, 5361, 5420, 5399, 5417, 5296, 5575, 5494, 5508, 5332, 5450, 5346, 5503, 5658, 5628, 5589 (2 hits) (11/19/2012 10:33:59 AM)
12	9	1.0	333.0	Yes	5562.2MHz, -64.0dBm	Hop sequence: 5561, 5502, 5519, 5560, 5613, 5330, 5635, 5278, 5707, 5470, 5288, 5583, 5283, 5633, 5569, 5695, 5305, 5406, 5296, 5426, 5673, 5641, 5693, 5350, 5507, 5393, 5550, 5685, 5383, 5420, 5587, 5415, 5642, 5586, 5649, 5709, 5640, 5713, 5387, 5498, 5476, 5348, 5477, 5280, 5648, 5478, 5380, 5638, 5272, 5254, 5577, 5611, 5397, 5627, 5610, 5581, 5443, 5510, 5647, 5671, 5316, 5253, 5496, 5373, 5565, 5690, 5667, 5439, 5474, 5721, 5396, 5492, 5285, 5375, 5310, 5704, 5723, 5675, 5630, 5619, 5347, 5710, 5595, 5591, 5355, 5462, 5614, 5293, 5428, 5315, 5333, 5329, 5482, 5725, 5331, 5530, 5459, 5580, 5615, 5360 (4 hits) (11/19/2012 10:34:16 AM)

Table 45 - FCC frequency hopping radar (Type 6) Results CU-Acquire Hi-Band						
Trial #	Pulses/ Burst	Pulse Width (us)	PRI (us)	Detected	Fr (MHz) and level (dBm)	Burst Information
13	9	1.0	333.0	Yes	5563.2MHz, -64.0dBm	Hop sequence: 5387, 5313, 5526, 5498, 5261, 5456, 5606, 5352, 5549, 5415, 5301, 5278, 5275, 5290, 5581, 5314, 5596, 5430, 5298, 5420, 5490, 5652, 5592, 5522, 5653, 5416, 5626, 5598, 5289, 5383, 5462, 5723, 5321, 5497, 5641, 5720, 5295, 5318, 5488, 5302, 5390, 5479, 5648, 5258, 5629, 5631, 5440, 5694, 5548, 5391, 5578, 5451, 5408, 5642, 5662, 5316, 5568, 5412, 5689, 5463, 5355, 5544, 5328, 5499, 5385, 5579, 5700, 5447, 5393, 5542, 5511, 5459, 5508, 5434, 5268, 5326, 5613, 5432, 5392, 5647, 5583, 5724, 5532, 5595, 5510, 5492, 5500, 5608, 5687, 5273, 5496, 5327, 5276, 5586, 5706, 5719, 5454, 5320, 5435, 5409 (1 hits) (11/19/2012 10:34:23 AM)
14	9	1.0	333.0	Yes	5564.2MHz, -64.0dBm	Hop sequence: 5421, 5515, 5581, 5694, 5327, 5325, 5508, 5255, 5398, 5685, 5468, 5510, 5527, 5328, 5335, 5346, 5525, 5275, 5670, 5712, 5417, 5287, 5580, 5447, 5304, 5367, 5413, 5465, 5426, 5446, 5634, 5282, 5566, 5579, 5452, 5451, 5522, 5569, 5720, 5648, 5299, 5652, 5333, 5555, 5311, 5439, 5310, 5383, 5314, 5411, 5607, 5600, 5528, 5339, 5291, 5586, 5524, 5496, 5536, 5617, 5308, 5543, 5437, 5297, 5646, 5454, 5644, 5553, 5684, 5473, 5633, 5584, 5257, 5259, 5615, 5404, 5552, 5612, 5680, 5535, 5666, 5285, 5334, 5466, 5534, 5563, 5686, 5516, 5717, 5343, 5419, 5363, 5572, 5627, 5455, 5462, 5703, 5526, 5487, 5337 (5 hits) (11/19/2012 10:34:33 AM)

Table 45 - FCC frequency hopping radar (Type 6) Results CU-Acquire Hi-Band						
Trial #	Pulses/ Burst	Pulse Width (us)	PRI (us)	Detected	Fr (MHz) and level (dBm)	Burst Information
15	9	1.0	333.0	Yes	5565.2MHz, -64.0dBm	Hop sequence: 5635, 5438, 5260, 5564, 5627, 5263, 5487, 5692, 5420, 5599, 5361, 5709, 5551, 5595, 5711, 5324, 5625, 5342, 5521, 5694, 5370, 5710, 5661, 5471, 5603, 5559, 5426, 5674, 5417, 5687, 5309, 5458, 5489, 5368, 5615, 5306, 5698, 5608, 5316, 5609, 5681, 5613, 5415, 5555, 5636, 5591, 5320, 5337, 5387, 5562, 5664, 5549, 5386, 5587, 5363, 5577, 5419, 5541, 5255, 5712, 5298, 5374, 5283, 5510, 5399, 5382, 5308, 5519, 5572, 5514, 5683, 5691, 5250, 5685, 5657, 5325, 5679, 5522, 5276, 5535, 5612, 5477, 5338, 5301, 5352, 5633, 5388, 5604, 5265, 5488, 5662, 5518, 5296, 5725, 5618, 5396, 5481, 5718, 5467, 5557 (6 hits) (11/19/2012 10:34:43 AM)
16	9	1.0	333.0	Yes	5566.2MHz, -64.0dBm	Hop sequence: 5467, 5399, 5662, 5470, 5690, 5695, 5272, 5572, 5666, 5558, 5255, 5518, 5378, 5641, 5616, 5273, 5403, 5334, 5668, 5418, 5653, 5579, 5335, 5253, 5347, 5593, 5353, 5580, 5422, 5329, 5356, 5534, 5714, 5661, 5316, 5582, 5401, 5282, 5614, 5491, 5314, 5680, 5458, 5275, 5391, 5529, 5499, 5678, 5489, 5595, 5660, 5520, 5402, 5413, 5395, 5581, 5514, 5655, 5412, 5619, 5463, 5450, 5277, 5606, 5612, 5638, 5724, 5503, 5543, 5650, 5361, 5254, 5325, 5484, 5605, 5448, 5443, 5630, 5686, 5430, 5511, 5441, 5265, 5493, 5466, 5263, 5310, 5416, 5512, 5544, 5257, 5259, 5375, 5586, 5411, 5532, 5425, 5349, 5380, 5405 (2 hits) (11/19/2012 10:34:50 AM)

Table 45 - FCC frequency hopping radar (Type 6) Results CU-Acquire Hi-Band						
Trial #	Pulses/ Burst	Pulse Width (us)	PRI (us)	Detected	Fr (MHz) and level (dBm)	Burst Information
17	9	1.0	333.0	Yes	5567.2MHz, -64.0dBm	Hop sequence: 5480, 5502, 5640, 5431, 5280, 5263, 5309, 5393, 5376, 5649, 5315, 5438, 5531, 5542, 5388, 5471, 5284, 5316, 5298, 5719, 5666, 5479, 5474, 5620, 5409, 5386, 5397, 5662, 5586, 5645, 5682, 5358, 5475, 5435, 5332, 5325, 5670, 5516, 5563, 5461, 5402, 5400, 5689, 5578, 5368, 5338, 5254, 5594, 5437, 5300, 5568, 5687, 5265, 5489, 5532, 5416, 5695, 5494, 5301, 5518, 5572, 5618, 5319, 5369, 5477, 5415, 5406, 5501, 5310, 5556, 5553, 5290, 5625, 5321, 5500, 5546, 5329, 5379, 5590, 5473, 5429, 5677, 5317, 5651, 5606, 5257, 5272, 5718, 5724, 5715, 5441, 5311, 5697, 5453, 5377, 5356, 5513, 5275, 5611, 5336 (4 hits) (11/19/2012 10:35:05 AM)
18	9	1.0	333.0	Yes	5568.2MHz, -64.0dBm	Hop sequence: 5673, 5427, 5391, 5686, 5388, 5504, 5612, 5491, 5377, 5413, 5706, 5357, 5403, 5660, 5654, 5585, 5533, 5354, 5606, 5646, 5538, 5591, 5396, 5351, 5515, 5289, 5652, 5638, 5629, 5653, 5669, 5395, 5331, 5323, 5535, 5447, 5335, 5293, 5573, 5621, 5462, 5539, 5348, 5436, 5549, 5598, 5392, 5266, 5670, 5374, 5516, 5254, 5455, 5541, 5608, 5309, 5401, 5260, 5461, 5524, 5507, 5400, 5416, 5651, 5565, 5611, 5552, 5720, 5431, 5556, 5422, 5362, 5560, 5700, 5482, 5294, 5387, 5514, 5694, 5397, 5270, 5318, 5428, 5590, 5586, 5337, 5708, 5329, 5336, 5465, 5342, 5540, 5575, 5300, 5474, 5562, 5521, 5252, 5506, 5597 (5 hits) (11/19/2012 10:35:14 AM)

Table 45 - FCC frequency hopping radar (Type 6) Results CU-Acquire Hi-Band						
Trial #	Pulses/ Burst	Pulse Width (us)	PRI (us)	Detected	Fr (MHz) and level (dBm)	Burst Information
19	9	1.0	333.0	Yes	5569.2MHz, -64.0dBm	Hop sequence: 5629, 5466, 5441, 5323, 5344, 5567, 5521, 5699, 5594, 5332, 5596, 5608, 5628, 5262, 5278, 5685, 5539, 5552, 5440, 5546, 5554, 5283, 5716, 5307, 5412, 5424, 5259, 5560, 5701, 5458, 5375, 5505, 5533, 5630, 5577, 5437, 5438, 5320, 5490, 5499, 5643, 5703, 5420, 5515, 5495, 5317, 5536, 5648, 5516, 5347, 5694, 5706, 5626, 5543, 5378, 5285, 5559, 5617, 5621, 5483, 5470, 5656, 5333, 5286, 5462, 5346, 5704, 5566, 5357, 5636, 5574, 5313, 5377, 5289, 5352, 5720, 5664, 5284, 5292, 5674, 5298, 5644, 5334, 5606, 5349, 5676, 5464, 5279, 5309, 5328, 5361, 5691, 5618, 5365, 5575, 5715, 5582, 5684, 5392, 5479 (5 hits) (11/19/2012 10:35:23 AM)
20	9	1.0	333.0	No	5570.2MHz, -64.0dBm	Hop sequence: 5613, 5418, 5651, 5604, 5328, 5549, 5376, 5292, 5303, 5320, 5313, 5596, 5490, 5395, 5425, 5503, 5281, 5277, 5504, 5421, 5387, 5291, 5437, 5678, 5481, 5256, 5705, 5340, 5501, 5365, 5258, 5459, 5656, 5619, 5334, 5411, 5310, 5621, 5330, 5353, 5530, 5515, 5327, 5557, 5690, 5513, 5528, 5595, 5586, 5539, 5252, 5354, 5461, 5430, 5471, 5662, 5673, 5368, 5628, 5496, 5603, 5455, 5510, 5526, 5381, 5374, 5485, 5687, 5495, 5538, 5393, 5661, 5317, 5283, 5261, 5448, 5474, 5465, 5726, 5579, 5695, 5403, 5713, 5545, 5694, 5297, 5606, 5415, 5505, 5654, 5544, 5404, 5445, 5524, 5587, 5271, 5280, 5498, 5478, 5382 (1 hits) (11/19/2012 10:35:30 AM)

Table 45 - FCC frequency hopping radar (Type 6) Results CU-Acquire Hi-Band						
Trial #	Pulses/ Burst	Pulse Width (us)	PRI (us)	Detected	Fr (MHz) and level (dBm)	Burst Information
21	9	1.0	333.0	Yes	5571.2MHz, -64.0dBm	Hop sequence: 5582, 5288, 5285, 5603, 5389, 5567, 5535, 5675, 5403, 5586, 5647, 5365, 5454, 5592, 5419, 5333, 5657, 5450, 5544, 5639, 5297, 5553, 5455, 5367, 5642, 5602, 5618, 5712, 5351, 5413, 5533, 5613, 5660, 5295, 5350, 5558, 5412, 5605, 5597, 5271, 5428, 5473, 5287, 5724, 5258, 5575, 5459, 5292, 5571, 5316, 5326, 5509, 5548, 5439, 5280, 5260, 5377, 5410, 5626, 5452, 5520, 5300, 5283, 5539, 5682, 5379, 5286, 5405, 5688, 5464, 5620, 5633, 5606, 5490, 5683, 5479, 5662, 5599, 5430, 5636, 5458, 5394, 5498, 5404, 5700, 5546, 5640, 5261, 5421, 5711, 5504, 5564, 5489, 5416, 5338, 5481, 5398, 5308, 5340, 5696 (4 hits) (11/19/2012 10:35:50 AM)
22	9	1.0	333.0	Yes	5572.2MHz, -64.0dBm	Hop sequence: 5344, 5299, 5677, 5706, 5331, 5330, 5473, 5391, 5470, 5360, 5612, 5701, 5564, 5498, 5459, 5670, 5554, 5293, 5413, 5566, 5390, 5305, 5631, 5365, 5295, 5431, 5712, 5280, 5279, 5430, 5349, 5467, 5264, 5643, 5525, 5676, 5559, 5550, 5642, 5443, 5384, 5578, 5454, 5492, 5555, 5535, 5435, 5388, 5603, 5432, 5401, 5683, 5666, 5297, 5723, 5691, 5556, 5275, 5400, 5296, 5421, 5690, 5415, 5532, 5617, 5600, 5515, 5304, 5546, 5587, 5480, 5406, 5567, 5383, 5405, 5367, 5547, 5281, 5588, 5545, 5403, 5357, 5323, 5601, 5705, 5654, 5447, 5272, 5495, 5510, 5576, 5324, 5389, 5616, 5673, 5373, 5393, 5326, 5289, 5540 (7 hits) (11/19/2012 10:36:00 AM)

Table 45 - FCC frequency hopping radar (Type 6) Results CU-Acquire Hi-Band						
Trial #	Pulses/ Burst	Pulse Width (us)	PRI (us)	Detected	Fr (MHz) and level (dBm)	Burst Information
23	9	1.0	333.0	Yes	5573.2MHz, -64.0dBm	Hop sequence: 5253, 5449, 5585, 5264, 5302, 5567, 5653, 5678, 5486, 5450, 5663, 5504, 5580, 5410, 5289, 5533, 5706, 5493, 5564, 5346, 5518, 5260, 5429, 5625, 5361, 5463, 5298, 5571, 5553, 5412, 5446, 5525, 5288, 5424, 5721, 5521, 5656, 5579, 5465, 5487, 5334, 5297, 5495, 5494, 5563, 5332, 5323, 5394, 5510, 5389, 5665, 5623, 5526, 5657, 5388, 5712, 5476, 5316, 5415, 5695, 5588, 5499, 5505, 5364, 5711, 5581, 5347, 5685, 5718, 5714, 5662, 5280, 5509, 5479, 5474, 5542, 5277, 5501, 5592, 5283, 5469, 5373, 5596, 5382, 5314, 5378, 5276, 5301, 5255, 5619, 5708, 5535, 5407, 5679, 5282, 5287, 5281, 5577, 5651, 5411 (4 hits) (11/19/2012 10:36:12 AM)
24	9	1.0	333.0	Yes	5553.2MHz, -64.0dBm	Hop sequence: 5664, 5302, 5620, 5600, 5663, 5697, 5586, 5487, 5546, 5701, 5273, 5578, 5634, 5652, 5575, 5623, 5303, 5396, 5291, 5609, 5718, 5260, 5428, 5454, 5537, 5392, 5481, 5391, 5533, 5525, 5712, 5566, 5614, 5347, 5561, 5596, 5685, 5259, 5519, 5498, 5485, 5653, 5629, 5309, 5393, 5539, 5615, 5310, 5671, 5342, 5643, 5497, 5444, 5366, 5402, 5656, 5301, 5613, 5418, 5364, 5371, 5468, 5666, 5499, 5255, 5430, 5648, 5438, 5482, 5488, 5429, 5641, 5283, 5654, 5368, 5357, 5644, 5642, 5394, 5691, 5520, 5515, 5421, 5585, 5476, 5592, 5711, 5286, 5464, 5435, 5564, 5601, 5716, 5461, 5432, 5509, 5646, 5496, 5316, 5518 (3 hits) (11/19/2012 10:36:22 AM)



Table 45 - FCC frequency hopping radar (Type 6) Results CU-Acquire Hi-Band						
Trial #	Pulses/ Burst	Pulse Width (us)	PRI (us)	Detected	Fr (MHz) and level (dBm)	Burst Information
25	9	1.0	333.0	Yes	5554.2MHz, -64.0dBm	Hop sequence: 5313, 5604, 5517, 5284, 5570, 5431, 5358, 5328, 5677, 5575, 5371, 5719, 5318, 5618, 5287, 5309, 5310, 5400, 5294, 5441, 5425, 5526, 5347, 5543, 5377, 5463, 5257, 5460, 5551, 5286, 5283, 5519, 5404, 5403, 5645, 5260, 5715, 5437, 5285, 5351, 5601, 5427, 5274, 5262, 5659, 5666, 5491, 5434, 5681, 5454, 5523, 5636, 5417, 5600, 5579, 5317, 5397, 5456, 5289, 5258, 5508, 5265, 5515, 5552, 5668, 5595, 5299, 5477, 5647, 5342, 5392, 5494, 5663, 5455, 5698, 5533, 5585, 5680, 5614, 5503, 5673, 5401, 5360, 5250, 5277, 5654, 5568, 5566, 5383, 5346, 5655, 5472, 5411, 5251, 5724, 5554, 5587, 5439, 5708, 5493 (4 hits) (11/19/2012 10:36:36 AM)
26	9	1.0	333.0	Yes	5555.2MHz, -64.0dBm	Hop sequence: 5506, 5261, 5518, 5598, 5464, 5345, 5533, 5505, 5306, 5659, 5478, 5309, 5574, 5613, 5473, 5649, 5399, 5581, 5311, 5490, 5624, 5330, 5480, 5352, 5529, 5503, 5717, 5610, 5576, 5346, 5252, 5423, 5545, 5445, 5375, 5342, 5361, 5324, 5449, 5395, 5327, 5558, 5701, 5348, 5639, 5358, 5479, 5277, 5439, 5410, 5634, 5485, 5673, 5289, 5413, 5318, 5645, 5313, 5279, 5474, 5406, 5377, 5451, 5382, 5652, 5568, 5683, 5424, 5488, 5599, 5307, 5532, 5308, 5412, 5647, 5579, 5716, 5621, 5644, 5628, 5254, 5496, 5367, 5447, 5297, 5275, 5700, 5455, 5655, 5562, 5388, 5369, 5648, 5483, 5552, 5489, 5332, 5714, 5607, 5396 (3 hits) (11/19/2012 10:36:49 AM)

Table 45 - FCC frequency hopping radar (Type 6) Results CU-Acquire Hi-Band						
Trial #	Pulses/ Burst	Pulse Width (us)	PRI (us)	Detected	Fr (MHz) and level (dBm)	Burst Information
27	9	1.0	333.0	Yes	5556.2MHz, -64.0dBm	Hop sequence: 5515, 5254, 5507, 5538, 5525, 5399, 5573, 5329, 5308, 5485, 5410, 5723, 5312, 5430, 5396, 5701, 5615, 5579, 5572, 5608, 5335, 5368, 5310, 5337, 5634, 5563, 5318, 5445, 5540, 5436, 5361, 5680, 5644, 5398, 5369, 5402, 5486, 5478, 5336, 5528, 5333, 5434, 5313, 5364, 5355, 5636, 5720, 5568, 5614, 5580, 5589, 5561, 5559, 5663, 5567, 5686, 5613, 5514, 5275, 5287, 5611, 5314, 5302, 5643, 5722, 5470, 5394, 5617, 5531, 5405, 5535, 5346, 5519, 5641, 5551, 5662, 5672, 5598, 5652, 5305, 5417, 5454, 5534, 5465, 5259, 5367, 5712, 5255, 5684, 5266, 5541, 5441, 5321, 5630, 5585, 5495, 5451, 5290, 5625, 5639 (7 hits) (11/19/2012 10:36:59 AM)
28	9	1.0	333.0	Yes	5557.2MHz, -64.0dBm	Hop sequence: 5463, 5709, 5705, 5327, 5649, 5558, 5564, 5568, 5699, 5374, 5326, 5668, 5255, 5412, 5383, 5296, 5565, 5674, 5718, 5724, 5366, 5385, 5661, 5376, 5321, 5400, 5680, 5309, 5334, 5427, 5377, 5546, 5671, 5355, 5516, 5675, 5392, 5448, 5548, 5702, 5454, 5640, 5256, 5434, 5566, 5340, 5268, 5621, 5390, 5570, 5379, 5522, 5491, 5714, 5291, 5512, 5253, 5495, 5440, 5513, 5636, 5723, 5269, 5497, 5441, 5292, 5474, 5342, 5422, 5313, 5589, 5439, 5298, 5538, 5311, 5369, 5590, 5695, 5328, 5594, 5635, 5415, 5646, 5653, 5280, 5547, 5299, 5416, 5652, 5523, 5301, 5505, 5587, 5579, 5339, 5332, 5631, 5672, 5607, 5484 (6 hits) (11/19/2012 10:37:09 AM)

Table 45 - FCC frequency hopping radar (Type 6) Results CU-Acquire Hi-Band						
Trial #	Pulses/ Burst	Pulse Width (us)	PRI (us)	Detected	Fr (MHz) and level (dBm)	Burst Information
29	9	1.0	333.0	Yes	5558.2MHz, -64.0dBm	Hop sequence: 5513, 5611, 5551, 5505, 5459, 5531, 5726, 5377, 5424, 5715, 5339, 5411, 5559, 5473, 5481, 5694, 5566, 5617, 5608, 5662, 5698, 5560, 5262, 5470, 5565, 5305, 5287, 5337, 5440, 5285, 5700, 5710, 5563, 5525, 5606, 5690, 5316, 5622, 5689, 5719, 5385, 5297, 5603, 5433, 5548, 5430, 5302, 5491, 5600, 5361, 5259, 5527, 5493, 5528, 5417, 5686, 5434, 5557, 5270, 5575, 5398, 5496, 5499, 5283, 5530, 5476, 5594, 5672, 5520, 5577, 5342, 5705, 5599, 5657, 5699, 5681, 5714, 5418, 5425, 5613, 5448, 5390, 5439, 5388, 5362, 5447, 5300, 5517, 5432, 5679, 5713, 5482, 5267, 5450, 5320, 5413, 5252, 5708, 5279, 5653 (6 hits) (11/19/2012 10:37:21 AM)
30	9	1.0	333.0	No	5559.2MHz, -64.0dBm	Hop sequence: 5362, 5503, 5609, 5279, 5542, 5383, 5428, 5655, 5531, 5695, 5709, 5505, 5403, 5426, 5618, 5642, 5397, 5680, 5715, 5691, 5416, 5411, 5258, 5251, 5627, 5602, 5406, 5676, 5533, 5725, 5453, 5254, 5308, 5698, 5361, 5277, 5615, 5294, 5662, 5537, 5507, 5578, 5659, 5720, 5605, 5272, 5608, 5303, 5694, 5596, 5519, 5355, 5597, 5707, 5701, 5692, 5664, 5547, 5516, 5552, 5455, 5488, 5454, 5714, 5515, 5440, 5494, 5483, 5656, 5623, 5572, 5675, 5718, 5681, 5370, 5486, 5377, 5539, 5315, 5389, 5629, 5632, 5252, 5466, 5592, 5302, 5687, 5585, 5521, 5326, 5418, 5366, 5273, 5512, 5484, 5300, 5348, 5381, 5576, 5684 (1 hits) (11/19/2012 10:37:34 AM)

Table 45 - FCC frequency hopping radar (Type 6) Results CU-Acquire Hi-Band						
Trial #	Pulses/ Burst	Pulse Width (us)	PRI (us)	Detected	Fr (MHz) and level (dBm)	Burst Information
31	9	1.0	333.0	Yes	5560.2MHz, -64.0dBm	Hop sequence: 5657, 5607, 5572, 5595, 5672, 5560, 5550, 5696, 5406, 5342, 5376, 5457, 5450, 5414, 5651, 5316, 5714, 5325, 5456, 5366, 5683, 5259, 5381, 5307, 5482, 5437, 5715, 5604, 5380, 5526, 5646, 5475, 5629, 5610, 5569, 5449, 5583, 5697, 5339, 5640, 5304, 5712, 5588, 5539, 5433, 5402, 5292, 5542, 5460, 5622, 5578, 5631, 5500, 5384, 5598, 5551, 5649, 5287, 5483, 5559, 5268, 5620, 5547, 5416, 5663, 5555, 5538, 5691, 5688, 5618, 5676, 5426, 5721, 5319, 5553, 5355, 5546, 5561, 5515, 5466, 5257, 5492, 5498, 5411, 5332, 5630, 5485, 5517, 5673, 5580, 5545, 5638, 5467, 5563, 5513, 5286, 5251, 5591, 5596, 5435 (7 hits) (11/19/2012 10:38:00 AM)
32	9	1.0	333.0	Yes	5561.2MHz, -64.0dBm	Hop sequence: 5395, 5562, 5410, 5305, 5561, 5282, 5512, 5547, 5310, 5407, 5594, 5422, 5582, 5262, 5483, 5458, 5408, 5317, 5446, 5555, 5309, 5320, 5388, 5398, 5558, 5556, 5449, 5355, 5503, 5278, 5530, 5257, 5720, 5465, 5656, 5705, 5251, 5329, 5552, 5276, 5360, 5385, 5270, 5303, 5311, 5459, 5383, 5358, 5586, 5600, 5622, 5686, 5642, 5551, 5363, 5543, 5568, 5665, 5334, 5460, 5596, 5425, 5525, 5507, 5463, 5721, 5654, 5603, 5252, 5620, 5487, 5506, 5346, 5712, 5315, 5318, 5604, 5569, 5590, 5557, 5685, 5312, 5331, 5666, 5655, 5673, 5549, 5391, 5490, 5639, 5650, 5489, 5402, 5427, 5440, 5631, 5578, 5598, 5274, 5638 (8 hits) (11/19/2012 10:39:25 AM)

Table 45 - FCC frequency hopping radar (Type 6) Results CU-Acquire Hi-Band						
Trial #	Pulses/ Burst	Pulse Width (us)	PRI (us)	Detected	Fr (MHz) and level (dBm)	Burst Information
33	9	1.0	333.0	Yes	5562.2MHz, -64.0dBm	Hop sequence: 5615, 5516, 5253, 5675, 5563, 5639, 5282, 5391, 5426, 5429, 5263, 5530, 5376, 5535, 5670, 5413, 5400, 5500, 5277, 5543, 5320, 5596, 5610, 5381, 5333, 5348, 5669, 5457, 5501, 5427, 5636, 5478, 5654, 5559, 5518, 5588, 5602, 5477, 5590, 5553, 5283, 5295, 5285, 5687, 5375, 5378, 5425, 5513, 5512, 5573, 5471, 5431, 5394, 5254, 5415, 5650, 5710, 5476, 5423, 5541, 5323, 5704, 5511, 5690, 5389, 5629, 5488, 5369, 5706, 5552, 5417, 5509, 5708, 5474, 5362, 5377, 5490, 5407, 5352, 5605, 5422, 5503, 5316, 5433, 5284, 5447, 5324, 5276, 5439, 5294, 5609, 5725, 5597, 5499, 5656, 5640, 5472, 5676, 5616, 5547 (3 hits) (11/19/2012 10:39:34 AM)
34	9	1.0	333.0	Yes	5563.2MHz, -64.0dBm	Hop sequence: 5559, 5357, 5641, 5331, 5399, 5449, 5303, 5288, 5715, 5713, 5294, 5536, 5586, 5649, 5558, 5617, 5299, 5495, 5475, 5473, 5554, 5285, 5421, 5385, 5595, 5271, 5275, 5412, 5539, 5384, 5520, 5326, 5305, 5411, 5691, 5306, 5696, 5398, 5456, 5687, 5550, 5314, 5584, 5605, 5572, 5644, 5565, 5726, 5469, 5400, 5562, 5722, 5515, 5660, 5390, 5717, 5277, 5650, 5615, 5575, 5458, 5626, 5621, 5341, 5551, 5320, 5345, 5451, 5557, 5466, 5300, 5477, 5537, 5343, 5256, 5482, 5613, 5484, 5372, 5422, 5322, 5340, 5527, 5416, 5309, 5350, 5407, 5647, 5316, 5553, 5661, 5645, 5619, 5669, 5418, 5318, 5360, 5476, 5262, 5574 (7 hits) (11/19/2012 10:39:42 AM)

Table 45 - FCC frequency hopping radar (Type 6) Results CU-Acquire Hi-Band						
Trial #	Pulses/ Burst	Pulse Width (us)	PRI (us)	Detected	Fr (MHz) and level (dBm)	Burst Information
35	9	1.0	333.0	Yes	5564.2MHz, -64.0dBm	Hop sequence: 5470, 5437, 5720, 5432, 5449, 5411, 5549, 5719, 5402, 5503, 5372, 5298, 5479, 5633, 5316, 5711, 5714, 5707, 5596, 5296, 5408, 5370, 5460, 5464, 5660, 5725, 5631, 5289, 5706, 5474, 5469, 5499, 5586, 5412, 5326, 5307, 5527, 5702, 5302, 5723, 5409, 5341, 5620, 5709, 5500, 5564, 5591, 5459, 5715, 5279, 5667, 5439, 5505, 5322, 5639, 5644, 5570, 5378, 5722, 5380, 5291, 5592, 5429, 5430, 5384, 5536, 5537, 5392, 5438, 5600, 5417, 5405, 5573, 5566, 5533, 5665, 5509, 5254, 5508, 5287, 5416, 5295, 5456, 5685, 5713, 5383, 5406, 5309, 5285, 5598, 5680, 5431, 5395, 5349, 5328, 5616, 5397, 5374, 5609, 5565 (5 hits) (11/19/2012 10:39:52 AM)
36	9	1.0	333.0	Yes	5565.2MHz, -64.0dBm	Hop sequence: 5396, 5470, 5598, 5439, 5692, 5265, 5331, 5605, 5353, 5262, 5570, 5430, 5303, 5569, 5281, 5500, 5468, 5330, 5716, 5494, 5309, 5553, 5639, 5498, 5333, 5665, 5649, 5678, 5311, 5475, 5441, 5547, 5515, 5373, 5655, 5314, 5463, 5647, 5419, 5710, 5466, 5390, 5368, 5658, 5591, 5544, 5513, 5511, 5473, 5412, 5268, 5345, 5438, 5260, 5398, 5635, 5615, 5542, 5661, 5408, 5455, 5448, 5560, 5579, 5512, 5361, 5414, 5629, 5632, 5435, 5367, 5670, 5628, 5428, 5558, 5467, 5499, 5684, 5388, 5425, 5474, 5691, 5312, 5431, 5723, 5611, 5302, 5387, 5657, 5505, 5477, 5399, 5656, 5594, 5576, 5604, 5667, 5671, 5584, 5325 (4 hits) (11/19/2012 10:40:03 AM)

Table 45 - FCC frequency hopping radar (Type 6) Results CU-Acquire Hi-Band						
Trial #	Pulses/ Burst	Pulse Width (us)	PRI (us)	Detected	Fr (MHz) and level (dBm)	Burst Information
37	9	1.0	333.0	Yes	5566.2MHz, -64.0dBm	Hop sequence: 5443, 5703, 5285, 5342, 5379, 5452, 5666, 5354, 5410, 5490, 5324, 5562, 5707, 5408, 5723, 5725, 5720, 5461, 5645, 5262, 5414, 5602, 5554, 5595, 5393, 5284, 5431, 5511, 5255, 5567, 5550, 5352, 5630, 5509, 5610, 5651, 5497, 5344, 5358, 5469, 5364, 5405, 5341, 5713, 5485, 5465, 5498, 5640, 5636, 5580, 5404, 5299, 5717, 5518, 5435, 5637, 5257, 5603, 5600, 5421, 5661, 5608, 5716, 5370, 5472, 5566, 5710, 5444, 5561, 5423, 5520, 5590, 5599, 5430, 5377, 5409, 5462, 5448, 5547, 5396, 5569, 5673, 5456, 5267, 5581, 5457, 5422, 5615, 5568, 5258, 5519, 5540, 5613, 5436, 5582, 5653, 5699, 5546, 5412, 5679 (7 hits) (11/19/2012 10:40:14 AM)
38	9	1.0	333.0	Yes	5567.2MHz, -64.0dBm	Hop sequence: 5658, 5278, 5484, 5549, 5315, 5505, 5428, 5526, 5708, 5480, 5379, 5660, 5312, 5470, 5621, 5618, 5560, 5251, 5682, 5679, 5256, 5316, 5648, 5597, 5662, 5547, 5347, 5272, 5275, 5436, 5458, 5471, 5482, 5394, 5676, 5257, 5337, 5616, 5722, 5414, 5334, 5440, 5647, 5360, 5573, 5454, 5493, 5670, 5311, 5307, 5292, 5710, 5718, 5449, 5532, 5499, 5435, 5637, 5445, 5650, 5697, 5425, 5629, 5424, 5483, 5355, 5376, 5293, 5600, 5548, 5680, 5538, 5456, 5400, 5338, 5558, 5438, 5539, 5671, 5420, 5415, 5533, 5572, 5659, 5634, 5633, 5555, 5289, 5703, 5695, 5655, 5585, 5378, 5352, 5472, 5399, 5712, 5287, 5371, 5716 (5 hits) (11/19/2012 10:40:25 AM)

Table 45 - FCC frequency hopping radar (Type 6) Results CU-Acquire Hi-Band						
Trial #	Pulses/ Burst	Pulse Width (us)	PRI (us)	Detected	Fr (MHz) and level (dBm)	Burst Information
39	9	1.0	333.0	Yes	5568.2MHz, -64.0dBm	Hop sequence: 5494, 5398, 5624, 5565, 5514, 5303, 5362, 5365, 5294, 5643, 5445, 5263, 5549, 5604, 5400, 5324, 5474, 5666, 5298, 5268, 5337, 5272, 5528, 5353, 5393, 5614, 5363, 5422, 5315, 5519, 5269, 5453, 5687, 5374, 5255, 5441, 5416, 5583, 5467, 5718, 5617, 5470, 5715, 5405, 5726, 5347, 5525, 5487, 5700, 5489, 5696, 5265, 5480, 5503, 5507, 5378, 5670, 5318, 5709, 5373, 5356, 5685, 5674, 5581, 5665, 5267, 5538, 5564, 5361, 5589, 5336, 5466, 5634, 5594, 5694, 5723, 5252, 5385, 5477, 5551, 5611, 5697, 5471, 5463, 5633, 5638, 5414, 5328, 5458, 5547, 5508, 5450, 5520, 5664, 5364, 5721, 5261, 5649, 5411, 5668 (2 hits) (11/19/2012 10:40:35 AM)
40	9	1.0	333.0	Yes	5569.2MHz, -64.0dBm	Hop sequence: 5659, 5596, 5499, 5404, 5402, 5282, 5687, 5279, 5472, 5519, 5397, 5636, 5488, 5407, 5438, 5360, 5568, 5664, 5429, 5452, 5336, 5552, 5624, 5280, 5399, 5486, 5378, 5406, 5572, 5319, 5281, 5350, 5692, 5364, 5460, 5542, 5515, 5277, 5294, 5284, 5355, 5413, 5326, 5433, 5369, 5379, 5403, 5678, 5703, 5598, 5565, 5289, 5337, 5346, 5606, 5316, 5255, 5371, 5468, 5508, 5510, 5313, 5578, 5653, 5588, 5466, 5500, 5518, 5278, 5725, 5597, 5667, 5261, 5648, 5411, 5455, 5301, 5531, 5686, 5485, 5262, 5396, 5530, 5637, 5641, 5647, 5512, 5394, 5484, 5577, 5303, 5296, 5392, 5274, 5604, 5691, 5389, 5643, 5412, 5436 (3 hits) (11/19/2012 10:40:43 AM)



Table 45 - FCC frequency hopping radar (Type 6) Results CU-Acquire Hi-Band						
Trial #	Pulses/ Burst	Pulse Width (us)	PRI (us)	Detected	Fr (MHz) and level (dBm)	Burst Information
41	9	1.0	333.0	Yes	5570.2MHz, -64.0dBm	Hop sequence: 5373, 5391, 5649, 5539, 5575, 5387, 5698, 5459, 5289, 5623, 5632, 5498, 5407, 5363, 5641, 5611, 5278, 5589, 5454, 5334, 5604, 5501, 5518, 5621, 5416, 5418, 5385, 5443, 5617, 5483, 5489, 5599, 5582, 5282, 5603, 5509, 5402, 5526, 5687, 5684, 5724, 5517, 5598, 5340, 5379, 5624, 5348, 5613, 5364, 5591, 5333, 5354, 5453, 5409, 5420, 5497, 5376, 5559, 5717, 5429, 5446, 5722, 5257, 5627, 5597, 5645, 5304, 5412, 5252, 5608, 5685, 5319, 5410, 5647, 5494, 5310, 5581, 5701, 5650, 5642, 5524, 5638, 5557, 5714, 5287, 5423, 5588, 5691, 5470, 5468, 5609, 5576, 5491, 5549, 5656, 5531, 5462, 5564, 5405, 5473 (3 hits) (11/19/2012 10:40:51 AM)
42	9	1.0	333.0	Yes	5571.2MHz, -64.0dBm	Hop sequence: 5438, 5304, 5387, 5679, 5452, 5381, 5404, 5690, 5721, 5300, 5296, 5347, 5421, 5467, 5513, 5716, 5529, 5251, 5338, 5331, 5589, 5687, 5351, 5287, 5428, 5368, 5449, 5562, 5359, 5385, 5413, 5516, 5699, 5569, 5494, 5585, 5543, 5521, 5430, 5654, 5324, 5581, 5369, 5447, 5481, 5446, 5544, 5329, 5367, 5415, 5707, 5588, 5256, 5457, 5596, 5695, 5536, 5341, 5532, 5425, 5393, 5582, 5639, 5713, 5693, 5685, 5568, 5503, 5666, 5270, 5418, 5340, 5373, 5653, 5498, 5440, 5322, 5501, 5609, 5392, 5264, 5273, 5277, 5520, 5303, 5651, 5272, 5668, 5330, 5416, 5678, 5479, 5664, 5515, 5289, 5487, 5386, 5383, 5402, 5271 (3 hits) (11/19/2012 10:41:10 AM)

Table 45 - FCC frequency hopping radar (Type 6) Results CU-Acquire Hi-Band						
Trial #	Pulses/ Burst	Pulse Width (us)	PRI (us)	Detected	Fr (MHz) and level (dBm)	Burst Information
43	9	1.0	333.0	Yes	5573.2MHz, -64.0dBm	Hop sequence: 5397, 5307, 5445, 5596, 5573, 5256, 5631, 5720, 5544, 5555, 5407, 5462, 5299, 5498, 5640, 5359, 5701, 5558, 5432, 5687, 5649, 5583, 5634, 5668, 5539, 5700, 5270, 5650, 5478, 5613, 5350, 5469, 5403, 5489, 5570, 5519, 5443, 5363, 5550, 5302, 5433, 5390, 5524, 5581, 5455, 5266, 5401, 5724, 5420, 5367, 5693, 5606, 5571, 5628, 5626, 5456, 5276, 5327, 5477, 5658, 5348, 5376, 5608, 5504, 5259, 5641, 5255, 5442, 5616, 5541, 5380, 5281, 5398, 5698, 5268, 5488, 5491, 5366, 5708, 5577, 5347, 5534, 5607, 5460, 5712, 5579, 5352, 5412, 5465, 5434, 5551, 5374, 5436, 5252, 5552, 5682, 5669, 5311, 5360, 5336 (5 hits) (11/19/2012 10:42:01 AM)
44	9	1.0	333.0	Yes	5574.2MHz, -64.0dBm	Hop sequence: 5675, 5410, 5283, 5491, 5718, 5684, 5531, 5409, 5647, 5486, 5618, 5446, 5593, 5627, 5623, 5481, 5287, 5295, 5464, 5487, 5346, 5463, 5460, 5710, 5490, 5704, 5580, 5648, 5321, 5286, 5504, 5497, 5485, 5364, 5714, 5462, 5688, 5279, 5634, 5358, 5425, 5461, 5520, 5436, 5297, 5644, 5413, 5343, 5615, 5697, 5608, 5407, 5470, 5427, 5653, 5254, 5320, 5390, 5348, 5385, 5458, 5306, 5493, 5665, 5526, 5539, 5592, 5557, 5340, 5449, 5564, 5614, 5513, 5411, 5555, 5327, 5450, 5597, 5402, 5444, 5622, 5709, 5500, 5588, 5298, 5722, 5673, 5533, 5337, 5290, 5572, 5341, 5317, 5546, 5550, 5705, 5559, 5418, 5586, 5689 (5 hits) (11/19/2012 10:42:56 AM)

Table 45 - FCC frequency hopping radar (Type 6) Results CU-Acquire Hi-Band						
Trial #	Pulses/ Burst	Pulse Width (us)	PRI (us)	Detected	Fr (MHz) and level (dBm)	Burst Information
45	9	1.0	333.0	Yes	5552.2MHz, -64.0dBm	Hop sequence: 5308, 5554, 5708, 5539, 5709, 5484, 5318, 5659, 5373, 5273, 5260, 5663, 5486, 5292, 5594, 5595, 5549, 5423, 5393, 5293, 5266, 5389, 5514, 5533, 5605, 5593, 5515, 5529, 5504, 5713, 5255, 5700, 5397, 5365, 5323, 5459, 5510, 5430, 5415, 5451, 5431, 5335, 5548, 5654, 5483, 5531, 5282, 5507, 5565, 5352, 5270, 5369, 5526, 5671, 5513, 5454, 5474, 5701, 5601, 5271, 5413, 5520, 5475, 5319, 5398, 5330, 5324, 5443, 5698, 5586, 5383, 5629, 5346, 5570, 5343, 5275, 5724, 5391, 5635, 5267, 5272, 5342, 5311, 5660, 5674, 5576, 5315, 5407, 5263, 5524, 5558, 5447, 5349, 5339, 5276, 5478, 5301, 5508, 5525, 5427 (4 hits) (11/19/2012 10:46:24 AM)
46	9	1.0	333.0	Yes	5574.2MHz, -64.0dBm	Hop sequence: 5394, 5529, 5270, 5494, 5558, 5371, 5649, 5693, 5359, 5534, 5470, 5277, 5447, 5609, 5719, 5356, 5407, 5257, 5681, 5712, 5671, 5723, 5549, 5298, 5641, 5632, 5457, 5276, 5500, 5416, 5480, 5366, 5498, 5564, 5311, 5372, 5511, 5528, 5484, 5469, 5587, 5347, 5679, 5336, 5586, 5599, 5636, 5574, 5428, 5466, 5350, 5508, 5333, 5628, 5374, 5710, 5703, 5348, 5285, 5547, 5314, 5517, 5346, 5548, 5502, 5381, 5518, 5409, 5280, 5318, 5690, 5391, 5256, 5419, 5689, 5291, 5383, 5439, 5635, 5453, 5305, 5432, 5557, 5440, 5329, 5362, 5572, 5563, 5644, 5489, 5485, 5438, 5307, 5313, 5685, 5510, 5299, 5653, 5284, 5486 (6 hits) (11/19/2012 10:46:38 AM)

WU as master CU-Acquire Mode, Low Band

Table 46 - Summary of All Results - CU-Acquire Low-Band				
Waveform Name	Pd (%)	Pd Required (%)	Number of Trials	Status
FCC Short Pulse Radar (Type 1)	100.0 %	60.0 %	30	PASSED
FCC Short Pulse Radar (Type 2)	100.0 %	60.0 %	30	PASSED
FCC Short Pulse Radar (Type 3)	100.0 %	60.0 %	30	PASSED
FCC Short Pulse Radar (Type 4)	90.0 %	60.0 %	30	PASSED
Aggregate of above results	97.5 %	80.0 %	120	PASSED
Long Sequence	100.0 %	80.0 %	31	PASSED
FCC frequency hopping radar (Type 6)	95.7 %	70.0 %	46	PASSED

Table 47 - FCC Short Pulse Radar (Type 1) Results CU-Acquire Low-Band						
Trial #	Pulses/Burst	Pulse Width (us)	PRI (us)	Detected	Fr (MHz) and level (dBm)	Burst Information
1	18	1.0	1428.0	Yes	5284.8MHz, -64.0dBm	Single burst (11/19/2012 10:53:23 AM)
2	18	1.0	1428.0	Yes	5279.8MHz, -64.0dBm	Single burst (11/19/2012 10:54:07 AM)
3	18	1.0	1428.0	Yes	5289.8MHz, -64.0dBm	Single burst (11/19/2012 10:54:19 AM)
4	18	1.0	1428.0	Yes	5284.8MHz, -64.0dBm	Single burst (11/19/2012 10:54:27 AM)
5	18	1.0	1428.0	Yes	5279.8MHz, -64.0dBm	Single burst (11/19/2012 10:54:36 AM)
6	18	1.0	1428.0	Yes	5289.8MHz, -64.0dBm	Single burst (11/19/2012 10:55:10 AM)
7	18	1.0	1428.0	Yes	5284.8MHz, -64.0dBm	Single burst (11/19/2012 10:55:18 AM)
8	18	1.0	1428.0	Yes	5279.8MHz, -64.0dBm	Single burst (11/19/2012 10:55:29 AM)
9	18	1.0	1428.0	Yes	5289.8MHz, -64.0dBm	Single burst (11/19/2012 10:55:37 AM)
10	18	1.0	1428.0	Yes	5284.8MHz, -64.0dBm	Single burst (11/19/2012 10:55:55 AM)
11	18	1.0	1428.0	Yes	5279.8MHz, -64.0dBm	Single burst (11/19/2012 10:56:04 AM)
12	18	1.0	1428.0	Yes	5289.8MHz, -64.0dBm	Single burst (11/19/2012 10:56:11 AM)
13	18	1.0	1428.0	Yes	5284.8MHz, -64.0dBm	Single burst (11/19/2012 10:56:18 AM)
14	18	1.0	1428.0	Yes	5279.8MHz, -64.0dBm	Single burst (11/19/2012 10:56:27 AM)
15	18	1.0	1428.0	Yes	5289.8MHz, -64.0dBm	Single burst (11/19/2012 10:56:36 AM)
16	18	1.0	1428.0	Yes	5284.8MHz, -64.0dBm	Single burst (11/19/2012 10:56:45 AM)
17	18	1.0	1428.0	Yes	5279.8MHz, -64.0dBm	Single burst (11/19/2012 10:56:52 AM)
18	18	1.0	1428.0	Yes	5289.8MHz, -64.0dBm	Single burst (11/19/2012 10:56:59 AM)
19	18	1.0	1428.0	Yes	5284.8MHz, -64.0dBm	Single burst (11/19/2012 10:57:05 AM)

<b>Table 47 - FCC Short Pulse Radar (Type 1) Results CU-Acquire Low-Band</b>						
Trial #	Pulses/ Burst	Pulse Width (us)	PRI (us)	Detected	Fr (MHz) and level (dBm)	Burst Information
20	18	1.0	1428.0	Yes	5279.8MHz, -64.0dBm	Single burst (11/19/2012 10:57:14 AM)
21	18	1.0	1428.0	Yes	5289.8MHz, -64.0dBm	Single burst (11/19/2012 10:57:23 AM)
22	18	1.0	1428.0	Yes	5284.8MHz, -64.0dBm	Single burst (11/19/2012 10:57:32 AM)
23	18	1.0	1428.0	Yes	5279.8MHz, -64.0dBm	Single burst (11/19/2012 10:57:39 AM)
24	18	1.0	1428.0	Yes	5289.8MHz, -64.0dBm	Single burst (11/19/2012 10:57:47 AM)
25	18	1.0	1428.0	Yes	5284.8MHz, -64.0dBm	Single burst (11/19/2012 10:57:54 AM)
26	18	1.0	1428.0	Yes	5279.8MHz, -64.0dBm	Single burst (11/19/2012 10:58:12 AM)
27	18	1.0	1428.0	Yes	5289.8MHz, -64.0dBm	Single burst (11/19/2012 10:58:20 AM)
28	18	1.0	1428.0	Yes	5284.8MHz, -64.0dBm	Single burst (11/19/2012 10:58:27 AM)
29	18	1.0	1428.0	Yes	5279.8MHz, -64.0dBm	Single burst (11/19/2012 10:58:35 AM)
30	18	1.0	1428.0	Yes	5289.8MHz, -64.0dBm	Single burst (11/19/2012 10:58:42 AM)

<b>Table 48 - FCC Short Pulse Radar (Type 2) Results CU-Acquire Low-Band</b>						
Trial #	Pulses/ Burst	Pulse Width (us)	PRI (us)	Detected	Fr (MHz) and level (dBm)	Burst Information
1	25	1.6	209.0	Yes	5284.8MHz, -64.0dBm	Single burst (11/19/2012 11:00:52 AM)
2	26	2.5	181.0	Yes	5279.8MHz, -64.0dBm	Single burst (11/19/2012 11:01:00 AM)
3	24	4.0	163.0	Yes	5289.8MHz, -64.0dBm	Single burst (11/19/2012 11:01:08 AM)
4	25	4.8	178.0	Yes	5284.8MHz, -64.0dBm	Single burst (11/19/2012 11:01:15 AM)
5	28	4.0	227.0	Yes	5279.8MHz, -64.0dBm	Single burst (11/19/2012 11:01:23 AM)
6	28	3.5	222.0	Yes	5289.8MHz, -64.0dBm	Single burst (11/19/2012 11:01:34 AM)
7	27	2.0	209.0	Yes	5284.8MHz, -64.0dBm	Single burst (11/19/2012 11:01:43 AM)
8	25	3.9	194.0	Yes	5279.8MHz, -64.0dBm	Single burst (11/19/2012 11:03:05 AM)
9	27	1.6	167.0	Yes	5289.8MHz, -64.0dBm	Single burst (11/19/2012 11:03:12 AM)
10	24	4.0	202.0	Yes	5284.8MHz, -64.0dBm	Single burst (11/19/2012 11:03:19 AM)
11	25	3.1	194.0	Yes	5279.8MHz, -64.0dBm	Single burst (11/19/2012 11:03:26 AM)
12	25	1.3	222.0	Yes	5289.8MHz, -64.0dBm	Single burst (11/19/2012 11:03:34 AM)
13	24	3.0	184.0	Yes	5284.8MHz, -64.0dBm	Single burst (11/19/2012 11:03:44 AM)

Trial #	Pulses/ Burst	Pulse Width (us)	PRI (us)	Detected	Fr (MHz) and level (dBm)	Burst Information
14	24	1.6	167.0	Yes	5279.8MHz, -64.0dBm	Single burst (11/19/2012 11:03:53 AM)
15	24	1.3	224.0	Yes	5289.8MHz, -64.0dBm	Single burst (11/19/2012 11:04:00 AM)
16	25	4.7	175.0	Yes	5284.8MHz, -64.0dBm	Single burst (11/19/2012 11:04:08 AM)
17	24	4.5	228.0	Yes	5279.8MHz, -64.0dBm	Single burst (11/19/2012 11:04:21 AM)
18	29	1.7	154.0	Yes	5289.8MHz, -64.0dBm	Single burst (11/19/2012 11:04:31 AM)
19	23	2.9	188.0	Yes	5284.8MHz, -64.0dBm	Single burst (11/19/2012 11:04:40 AM)
20	29	4.9	176.0	Yes	5279.8MHz, -64.0dBm	Single burst (11/19/2012 11:04:48 AM)
21	26	3.8	154.0	Yes	5289.8MHz, -64.0dBm	Single burst (11/19/2012 11:04:55 AM)
22	26	4.9	164.0	Yes	5284.8MHz, -64.0dBm	Single burst (11/19/2012 11:05:02 AM)
23	28	3.4	213.0	Yes	5279.8MHz, -64.0dBm	Single burst (11/19/2012 11:05:10 AM)
24	29	3.5	204.0	Yes	5289.8MHz, -64.0dBm	Single burst (11/19/2012 11:05:18 AM)
25	28	4.4	174.0	Yes	5284.8MHz, -64.0dBm	Single burst (11/19/2012 11:05:26 AM)
26	26	3.2	173.0	Yes	5279.8MHz, -64.0dBm	Single burst (11/19/2012 11:05:34 AM)
27	23	4.9	172.0	Yes	5289.8MHz, -64.0dBm	Single burst (11/19/2012 11:05:41 AM)
28	26	1.9	217.0	Yes	5284.8MHz, -64.0dBm	Single burst (11/19/2012 11:05:48 AM)
29	26	4.9	187.0	Yes	5279.8MHz, -64.0dBm	Single burst (11/19/2012 11:05:57 AM)
30	24	3.9	171.0	Yes	5289.8MHz, -64.0dBm	Single burst (11/19/2012 11:06:04 AM)

Trial #	Pulses/ Burst	Pulse Width (us)	PRI (us)	Detected	Fr (MHz) and level (dBm)	Burst Information
1	18	7.4	417.0	Yes	5284.8MHz, -64.0dBm	Single burst (11/19/2012 11:08:53 AM)
2	17	6.1	206.0	Yes	5279.8MHz, -64.0dBm	Single burst (11/19/2012 11:09:06 AM)
3	17	9.6	331.0	Yes	5289.8MHz, -64.0dBm	Single burst (11/19/2012 11:09:16 AM)
4	16	8.0	340.0	Yes	5284.8MHz, -64.0dBm	Single burst (11/19/2012 11:09:30 AM)
5	16	8.6	203.0	Yes	5279.8MHz, -64.0dBm	Single burst (11/19/2012 11:09:38 AM)
6	17	8.3	308.0	Yes	5289.8MHz, -64.0dBm	Single burst (11/19/2012 11:09:45 AM)
7	18	9.8	244.0	Yes	5284.8MHz, -64.0dBm	Single burst (11/19/2012 11:10:46 AM)

<b>Table 49 - FCC Short Pulse Radar (Type 3) Results CU-Acquire Low-Band</b>						
Trial #	Pulses/ Burst	Pulse Width (us)	PRI (us)	Detected	Fr (MHz) and level (dBm)	Burst Information
8	17	9.7	406.0	Yes	5279.8MHz, -64.0dBm	Single burst (11/19/2012 11:10:56 AM)
9	18	8.6	286.0	Yes	5289.8MHz, -64.0dBm	Single burst (11/19/2012 11:11:07 AM)
10	18	10.0	480.0	Yes	5284.8MHz, -64.0dBm	Single burst (11/19/2012 11:11:16 AM)
11	17	6.2	267.0	Yes	5279.8MHz, -64.0dBm	Single burst (11/19/2012 11:11:24 AM)
12	17	6.5	455.0	Yes	5289.8MHz, -64.0dBm	Single burst (11/19/2012 11:11:31 AM)
13	17	9.6	324.0	Yes	5284.8MHz, -64.0dBm	Single burst (11/19/2012 11:11:39 AM)
14	17	7.3	238.0	Yes	5279.8MHz, -64.0dBm	Single burst (11/19/2012 11:11:46 AM)
15	16	9.6	210.0	Yes	5289.8MHz, -64.0dBm	Single burst (11/19/2012 11:11:54 AM)
16	18	7.3	228.0	Yes	5284.8MHz, -64.0dBm	Single burst (11/19/2012 11:12:11 AM)
17	17	6.3	495.0	Yes	5279.8MHz, -64.0dBm	Single burst (11/19/2012 11:12:17 AM)
18	18	10.0	265.0	Yes	5289.8MHz, -64.0dBm	Single burst (11/19/2012 11:12:25 AM)
19	17	8.0	390.0	Yes	5284.8MHz, -64.0dBm	Single burst (11/19/2012 11:12:32 AM)
20	18	9.7	381.0	Yes	5279.8MHz, -64.0dBm	Single burst (11/19/2012 11:12:39 AM)
21	17	8.3	427.0	Yes	5289.8MHz, -64.0dBm	Single burst (11/19/2012 11:12:46 AM)
22	16	8.1	377.0	Yes	5284.8MHz, -64.0dBm	Single burst (11/19/2012 11:12:54 AM)
23	17	7.9	444.0	Yes	5279.8MHz, -64.0dBm	Single burst (11/19/2012 11:13:04 AM)
24	16	8.4	423.0	Yes	5289.8MHz, -64.0dBm	Single burst (11/19/2012 11:13:11 AM)
25	18	9.0	234.0	Yes	5284.8MHz, -64.0dBm	Single burst (11/19/2012 11:13:18 AM)
26	17	8.8	349.0	Yes	5279.8MHz, -64.0dBm	Single burst (11/19/2012 11:13:30 AM)
27	16	6.8	368.0	Yes	5289.8MHz, -64.0dBm	Single burst (11/19/2012 11:13:47 AM)
28	16	8.6	201.0	Yes	5284.8MHz, -64.0dBm	Single burst (11/19/2012 11:13:56 AM)
29	17	6.8	397.0	Yes	5279.8MHz, -64.0dBm	Single burst (11/19/2012 11:14:04 AM)
30	17	7.2	402.0	Yes	5289.8MHz, -64.0dBm	Single burst (11/19/2012 11:14:12 AM)

<b>Table 50 - FCC Short Pulse Radar (Type 4) Results CU-Acquire Low-Band</b>						
Trial #	Pulses/ Burst	Pulse Width (us)	PRI (us)	Detected	Fr (MHz) and level (dBm)	Burst Information
1	15	17.0	465.0	Yes	5284.8MHz, -64.0dBm	Single burst (11/19/2012 11:14:51 AM)

Table 50 - FCC Short Pulse Radar (Type 4) Results CU-Acquire Low-Band						
Trial #	Pulses/ Burst	Pulse Width (us)	PRI (us)	Detected	Fr (MHz) and level (dBm)	Burst Information
2	14	12.0	480.0	Yes	5279.8MHz, -64.0dBm	Single burst (11/19/2012 11:14:59 AM)
3	12	13.3	228.0	Yes	5289.8MHz, -64.0dBm	Single burst (11/19/2012 11:15:06 AM)
4	13	16.8	281.0	Yes	5284.8MHz, -64.0dBm	Single burst (11/19/2012 11:15:13 AM)
5	14	15.1	381.0	Yes	5279.8MHz, -64.0dBm	Single burst (11/19/2012 11:15:20 AM)
6	12	15.9	400.0	Yes	5289.8MHz, -64.0dBm	Single burst (11/19/2012 11:15:27 AM)
7	15	19.3	394.0	Yes	5284.8MHz, -64.0dBm	Single burst (11/19/2012 11:15:34 AM)
8	14	15.8	396.0	Yes	5279.8MHz, -64.0dBm	Single burst (11/19/2012 11:15:42 AM)
9	13	16.8	323.0	Yes	5289.8MHz, -64.0dBm	Single burst (11/19/2012 11:15:49 AM)
10	15	12.4	486.0	Yes	5284.8MHz, -64.0dBm	Single burst (11/19/2012 11:15:55 AM)
11	12	18.9	219.0	No	5279.8MHz, -64.0dBm	Single burst (11/19/2012 11:16:02 AM)
12	14	18.9	459.0	Yes	5289.8MHz, -64.0dBm	Single burst (11/19/2012 11:16:12 AM)
13	15	17.9	300.0	Yes	5284.8MHz, -64.0dBm	Single burst (11/19/2012 11:16:20 AM)
14	15	13.3	390.0	Yes	5279.8MHz, -64.0dBm	Single burst (11/19/2012 11:16:29 AM)
15	14	13.6	461.0	Yes	5289.8MHz, -64.0dBm	Single burst (11/19/2012 11:16:37 AM)
16	13	18.1	398.0	Yes	5284.8MHz, -64.0dBm	Single burst (11/19/2012 11:17:48 AM)
17	14	19.9	263.0	Yes	5279.8MHz, -64.0dBm	Single burst (11/19/2012 11:17:55 AM)
18	14	17.8	255.0	Yes	5289.8MHz, -64.0dBm	Single burst (11/19/2012 11:18:02 AM)
19	14	17.9	460.0	Yes	5284.8MHz, -64.0dBm	Single burst (11/19/2012 11:18:09 AM)
20	14	16.0	358.0	Yes	5279.8MHz, -64.0dBm	Single burst (11/19/2012 11:18:16 AM)
21	14	15.2	390.0	Yes	5289.8MHz, -64.0dBm	Single burst (11/19/2012 11:18:24 AM)
22	15	17.9	208.0	Yes	5284.8MHz, -64.0dBm	Single burst (11/19/2012 11:18:31 AM)
23	12	11.5	248.0	No	5279.8MHz, -64.0dBm	Single burst (11/19/2012 11:18:37 AM)
24	16	14.2	393.0	Yes	5289.8MHz, -64.0dBm	Single burst (11/19/2012 11:18:49 AM)
25	16	13.0	417.0	Yes	5284.8MHz, -64.0dBm	Single burst (11/19/2012 11:18:57 AM)
26	15	18.6	339.0	Yes	5279.8MHz, -64.0dBm	Single burst (11/19/2012 11:19:04 AM)
27	14	19.4	303.0	Yes	5289.8MHz, -64.0dBm	Single burst (11/19/2012 11:19:12 AM)
28	14	17.3	488.0	Yes	5284.8MHz, -64.0dBm	Single burst (11/19/2012 11:19:55 AM)



<b>Table 50 - FCC Short Pulse Radar (Type 4) Results CU-Acquire Low-Band</b>						
Trial #	Pulses/ Burst	Pulse Width (us)	PRI (us)	Detected	Fr (MHz) and level (dBm)	Burst Information
29	13	19.3	290.0	No	5279.8MHz, -64.0dBm	Single burst (11/19/2012 11:20:22 AM)
30	12	15.1	418.0	Yes	5289.8MHz, -64.0dBm	Single burst (11/19/2012 11:20:36 AM)

<b>Table 51 - Long Sequence Waveform Summary CU-Acquire Low-Band</b>		
Long Sequence Trial	Result	Radar Frequency / Amplitude
Trial #1	Detected	5284.8MHz, -64.0dBm
Trial #2	Detected	5279.8MHz, -64.0dBm
Trial #3	Detected	5289.8MHz, -64.0dBm
Trial #4	Detected	5284.8MHz, -64.0dBm
Trial #5	Detected	5279.8MHz, -64.0dBm
Trial #6	Detected	5289.8MHz, -64.0dBm
Trial #7	Detected	5284.8MHz, -64.0dBm
Trial #8	Detected	5279.8MHz, -64.0dBm
Trial #9	Detected	5289.8MHz, -64.0dBm
Trial #10	Detected	5284.8MHz, -64.0dBm
Trial #11	Detected	5279.8MHz, -64.0dBm
Trial #12	Detected	5289.8MHz, -64.0dBm
Trial #13	Detected	5284.8MHz, -64.0dBm
Trial #14	Detected	5279.8MHz, -64.0dBm
Trial #15	Detected	5289.8MHz, -64.0dBm
Trial #16	Detected	5284.8MHz, -64.0dBm
Trial #17	Detected	5279.8MHz, -64.0dBm
Trial #18	Detected	5289.8MHz, -64.0dBm
Trial #19	Detected	5284.8MHz, -64.0dBm
Trial #20	Detected	5279.8MHz, -64.0dBm
Trial #21	Detected	5289.8MHz, -64.0dBm
Trial #22	Detected	5284.8MHz, -64.0dBm
Trial #23	Detected	5279.8MHz, -64.0dBm
Trial #24	Detected	5289.8MHz, -64.0dBm
Trial #25	Detected	5284.8MHz, -64.0dBm
Trial #26	Detected	5279.8MHz, -64.0dBm

Table 51 - Long Sequence Waveform Summary CU-Acquire Low-Band		
Long Sequence Trial	Result	Radar Frequency / Amplitude
Trial #27	Detected	5289.8MHz, -64.0dBm
Trial #28	Detected	5284.8MHz, -64.0dBm
Trial #29	Detected	5279.8MHz, -64.0dBm
Trial #30	Detected	5289.8MHz, -64.0dBm
Trial #31	Detected	5284.8MHz, -64.0dBm

Table 52 - CU-Acquire Low-Band Long Sequence Waveform Trial#1 (Detected)						
Burst #	# Pulses	Pulse Width (us)	Chirp (MHz)	Interval 1 to 2 (us)	Interval 2 to 3 (us)	Start time (s)
1	2	51.2	5	1023.0	-	0.741185
2	2	71.4	10	1554.0	-	1.123521
3	2	71.7	5	1397.0	-	2.149537
4	2	76.5	12	1283.0	-	2.646304
5	2	73.0	9	1705.0	-	4.186999
6	2	81.6	19	1712.0	-	4.622301
7	2	88.2	19	1209.0	-	5.708925
8	2	82.5	11	1672.0	-	6.190623
9	2	58.2	17	1621.0	-	7.281140
10	3	92.0	9	1334.0	1822.0	8.319620
11	2	53.6	16	1354.0	-	8.881918
12	1	80.3	17	-	-	10.258431
13	1	75.4	14	-	-	10.560567
14	2	70.1	10	1993.0	-	11.874822

Table 53 - CU-Acquire Low-Band Long Sequence Waveform Trial#2 (Detected)						
Burst #	# Pulses	Pulse Width (us)	Chirp (MHz)	Interval 1 to 2 (us)	Interval 2 to 3 (us)	Start time (s)
1	2	54.1	17	1340.0	-	0.004023
2	3	78.1	19	1642.0	1780.0	1.295700
3	3	99.6	16	1574.0	1864.0	3.129253
4	2	55.1	15	1075.0	-	3.932858
5	2	99.9	11	1404.0	-	4.877924
6	2	91.6	12	1421.0	-	6.465732
7	2	75.5	17	1300.0	-	6.690910
8	2	89.3	8	1846.0	-	8.663740
9	2	62.9	7	1645.0	-	8.892960
10	2	87.6	17	1599.0	-	10.260983
11	1	62.9	10	-	-	11.805925

Table 54 - CU-Acquire Low-Band Long Sequence Waveform Trial#3 (Detected)						
Burst #	# Pulses	Pulse Width (us)	Chirp (MHz)	Interval 1 to 2 (us)	Interval 2 to 3 (us)	Start time (s)
1	2	65.0	14	1332.0	-	1.016037
2	3	85.3	13	1112.0	1113.0	2.311256
3	2	55.2	14	1881.0	-	3.104909

<b>Table 54 - CU-Acquire Low-Band Long Sequence Waveform Trial#3 (Detected)</b>						
Burst #	# Pulses	Pulse Width (us)	Chirp (MHz)	Interval 1 to 2 (us)	Interval 2 to 3 (us)	Start time (s)
4	2	56.5	13	1451.0	-	4.895485
5	1	52.3	18	-	-	5.900499
6	1	87.5	13	-	-	7.973315
7	1	99.2	16	-	-	8.087480
8	2	60.2	16	1520.0	-	9.930219
9	1	70.3	12	-	-	11.923600

<b>Table 55 - CU-Acquire Low-Band Long Sequence Waveform Trial#4 (Detected)</b>						
Burst #	# Pulses	Pulse Width (us)	Chirp (MHz)	Interval 1 to 2 (us)	Interval 2 to 3 (us)	Start time (s)
1	3	81.0	13	1634.0	1163.0	0.771788
2	3	84.0	15	1334.0	1426.0	1.381385
3	1	72.6	9	-	-	1.717421
4	3	81.2	14	1506.0	1684.0	2.899678
5	2	54.4	8	1145.0	-	3.853828
6	2	99.5	17	1982.0	-	4.466851
7	3	75.9	10	1096.0	1862.0	4.917826
8	2	58.0	6	1089.0	-	6.248828
9	3	59.8	8	1796.0	1532.0	6.591228
10	1	86.6	16	-	-	7.655770
11	2	50.1	9	1597.0	-	8.794060
12	3	56.0	8	1866.0	1939.0	9.359636
13	1	90.6	10	-	-	9.952373
14	2	70.8	18	1576.0	-	10.767651
15	3	98.8	13	1177.0	1578.0	11.543917

<b>Table 56 - CU-Acquire Low-Band Long Sequence Waveform Trial#5 (Detected)</b>						
Burst #	# Pulses	Pulse Width (us)	Chirp (MHz)	Interval 1 to 2 (us)	Interval 2 to 3 (us)	Start time (s)
1	1	60.6	12	-	-	0.010349
2	2	81.8	10	1429.0	-	1.726023
3	2	58.1	14	1041.0	-	2.741486
4	2	90.5	17	1582.0	-	3.532367
5	2	60.0	8	1630.0	-	4.303105
6	2	73.4	7	1600.0	-	5.482680
7	2	63.8	17	1059.0	-	5.545881
8	2	98.3	20	1954.0	-	7.000202
9	2	97.7	10	1656.0	-	8.243555
10	1	82.8	19	-	-	8.319677
11	2	92.9	16	1280.0	-	10.051093
12	1	87.1	18	-	-	10.499084
13	2	85.6	7	1188.0	-	11.513111

<b>Table 57 - CU-Acquire Low-Band Long Sequence Waveform Trial#6 (Detected)</b>						
Burst #	# Pulses	Pulse Width (us)	Chirp (MHz)	Interval 1 to 2 (us)	Interval 2 to 3 (us)	Start time (s)
1	2	52.8	8	1720.0	-	0.057021
2	2	79.7	11	1460.0	-	2.060422
3	1	82.0	7	-	-	3.923058

Burst #	# Pulses	Pulse Width (us)	Chirp (MHz)	Interval 1 to 2 (us)	Interval 2 to 3 (us)	Start time (s)
4	2	85.9	18	1259.0	-	4.632676
5	2	83.4	6	1148.0	-	6.171251
6	2	84.8	6	1796.0	-	7.578771
7	2	84.0	20	1593.0	-	8.032630
8	2	59.9	13	1863.0	-	9.481968
9	1	84.3	11	-	-	10.713890

Burst #	# Pulses	Pulse Width (us)	Chirp (MHz)	Interval 1 to 2 (us)	Interval 2 to 3 (us)	Start time (s)
1	1	61.5	13	-	-	0.485788
2	2	60.1	18	1287.0	-	1.604611
3	2	74.6	6	1934.0	-	2.906759
4	2	78.5	8	1367.0	-	4.259580
5	3	85.2	14	1652.0	1525.0	5.371132
6	1	54.3	10	-	-	5.601159
7	2	68.2	11	1926.0	-	6.803153
8	3	92.5	8	1467.0	1343.0	8.404229
9	3	80.4	7	1815.0	1681.0	8.967719
10	2	72.7	6	1993.0	-	10.326435
11	2	75.0	6	1932.0	-	11.413692

Burst #	# Pulses	Pulse Width (us)	Chirp (MHz)	Interval 1 to 2 (us)	Interval 2 to 3 (us)	Start time (s)
1	2	69.7	11	1028.0	-	0.528026
2	1	98.5	6	-	-	1.669011
3	3	53.1	15	1856.0	1102.0	2.833457
4	3	84.9	16	1578.0	1584.0	5.196579
5	2	71.6	14	1281.0	-	6.059020
6	2	71.1	12	1237.0	-	6.996766
7	3	98.1	17	1212.0	1110.0	8.358657
8	3	92.9	12	1575.0	1609.0	9.941101
9	2	69.5	17	1781.0	-	11.158905

Burst #	# Pulses	Pulse Width (us)	Chirp (MHz)	Interval 1 to 2 (us)	Interval 2 to 3 (us)	Start time (s)
1	2	55.6	19	1407.0	-	0.806052
2	1	78.0	12	-	-	1.401761
3	1	93.1	18	-	-	2.613959
4	3	93.2	17	1255.0	1344.0	3.799117
5	1	55.9	6	-	-	4.906530
6	2	72.2	18	1746.0	-	6.506578
7	2	99.3	15	1805.0	-	6.599093
8	1	56.5	6	-	-	8.025854
9	2	50.2	7	1880.0	-	9.678761
10	2	55.6	6	1021.0	-	10.078746
11	1	84.7	19	-	-	11.303158

<b>Table 61 - CU-Acquire Low-Band Long Sequence Waveform Trial#10 (Detected)</b>						
Burst #	# Pulses	Pulse Width (us)	Chirp (MHz)	Interval 1 to 2 (us)	Interval 2 to 3 (us)	Start time (s)
1	2	59.4	18	1809.0	-	0.395643
2	2	91.0	14	1212.0	-	1.293530
3	2	93.0	10	1662.0	-	2.238592
4	2	62.9	10	1882.0	-	3.916448
5	2	69.5	13	1093.0	-	4.385337
6	2	71.6	11	1897.0	-	5.581968
7	2	80.3	19	1350.0	-	6.304726
8	1	86.7	7	-	-	7.266833
9	1	62.9	8	-	-	8.776726
10	2	82.3	16	1943.0	-	9.217443
11	2	68.5	9	1168.0	-	10.254564
12	1	87.5	10	-	-	11.341226

<b>Table 62 - CU-Acquire Low-Band Long Sequence Waveform Trial#11 (Detected)</b>						
Burst #	# Pulses	Pulse Width (us)	Chirp (MHz)	Interval 1 to 2 (us)	Interval 2 to 3 (us)	Start time (s)
1	2	65.3	20	1153.0	-	0.131903
2	2	79.5	8	1398.0	-	0.873587
3	3	62.3	18	1226.0	1289.0	1.215246
4	1	63.0	6	-	-	2.375873
5	2	55.2	12	1025.0	-	2.415771
6	1	64.7	17	-	-	3.329127
7	2	74.1	19	1036.0	-	3.672938
8	2	68.2	11	1497.0	-	4.781416
9	1	56.3	12	-	-	5.251023
10	1	53.0	7	-	-	5.774649
11	2	97.9	11	1693.0	-	6.449806
12	2	59.4	5	1029.0	-	6.700117
13	3	99.2	14	1913.0	1518.0	7.564856
14	3	93.6	13	1009.0	1816.0	8.176292
15	3	53.2	15	1018.0	1367.0	8.937764
16	2	74.4	6	1932.0	-	9.577797
17	2	90.9	19	1610.0	-	10.005998
18	1	97.5	12	-	-	10.501916
19	2	75.4	9	1704.0	-	10.823497
20	2	83.6	9	1471.0	-	11.681148

<b>Table 63 - CU-Acquire Low-Band Long Sequence Waveform Trial#12 (Detected)</b>						
Burst #	# Pulses	Pulse Width (us)	Chirp (MHz)	Interval 1 to 2 (us)	Interval 2 to 3 (us)	Start time (s)
1	3	90.2	10	1414.0	1524.0	0.191396
2	1	62.7	15	-	-	0.984915
3	2	99.3	18	1018.0	-	1.666747
4	2	92.1	9	1509.0	-	2.750822
5	2	98.5	12	1127.0	-	3.143501
6	2	61.7	10	1976.0	-	3.963508
7	3	70.1	17	1239.0	1478.0	4.468307
8	3	91.2	7	1441.0	1860.0	5.629619
9	2	75.2	18	1725.0	-	5.853198

<b>Table 63 - CU-Acquire Low-Band Long Sequence Waveform Trial#12 (Detected)</b>						
Burst #	# Pulses	Pulse Width (us)	Chirp (MHz)	Interval 1 to 2 (us)	Interval 2 to 3 (us)	Start time (s)
10	2	97.6	12	1174.0	-	6.807086
11	2	59.7	15	1969.0	-	7.240895
12	1	71.8	15	-	-	7.796619
13	1	60.8	17	-	-	9.049767
14	2	63.0	14	1495.0	-	9.644851
15	2	67.9	18	1372.0	-	10.125277
16	2	78.6	13	1046.0	-	10.770778
17	3	61.5	17	1862.0	1390.0	11.365547

<b>Table 64 - CU-Acquire Low-Band Long Sequence Waveform Trial#13 (Detected)</b>						
Burst #	# Pulses	Pulse Width (us)	Chirp (MHz)	Interval 1 to 2 (us)	Interval 2 to 3 (us)	Start time (s)
1	2	96.5	20	1015.0	-	0.306320
2	2	90.9	17	1412.0	-	0.807887
3	2	78.1	16	1085.0	-	1.754125
4	3	88.7	9	1093.0	1211.0	1.922742
5	2	83.7	12	1213.0	-	2.525347
6	2	70.4	6	1354.0	-	3.525685
7	2	57.1	12	1582.0	-	3.672054
8	3	70.4	17	1583.0	1421.0	4.518047
9	2	95.6	17	1568.0	-	5.292679
10	1	73.5	14	-	-	5.563909
11	2	61.4	18	1678.0	-	6.281966
12	3	59.5	14	1548.0	1583.0	7.036915
13	1	52.5	9	-	-	7.441820
14	1	78.3	7	-	-	8.390482
15	2	50.3	12	1959.0	-	8.772853
16	1	64.8	15	-	-	9.351543
17	1	88.0	17	-	-	9.958038
18	2	64.6	7	1056.0	-	10.584814
19	2	64.7	7	1971.0	-	10.957042
20	1	78.1	7	-	-	11.957187

<b>Table 65 - CU-Acquire Low-Band Long Sequence Waveform Trial#14 (Detected)</b>						
Burst #	# Pulses	Pulse Width (us)	Chirp (MHz)	Interval 1 to 2 (us)	Interval 2 to 3 (us)	Start time (s)
1	2	85.6	19	1693.0	-	0.840096
2	1	74.1	11	-	-	1.583064
3	2	86.2	12	1548.0	-	2.399712
4	2	72.6	7	1182.0	-	3.748907
5	1	51.5	13	-	-	5.126713
6	1	91.4	19	-	-	6.320436
7	3	68.8	5	1653.0	1079.0	6.590114
8	2	80.3	19	1570.0	-	7.718407
9	2	67.0	11	1315.0	-	9.528825
10	1	92.0	5	-	-	10.369380
11	1	74.0	13	-	-	11.174623

<b>Table 66 - CU-Acquire Low-Band Long Sequence Waveform Trial#15 (Detected)</b>						
--	--	--	--	--	--	--

Burst #	# Pulses	Pulse Width (us)	Chirp (MHz)	Interval 1 to 2 (us)	Interval 2 to 3 (us)	Start time (s)
1	1	93.8	17	-	-	0.262236
2	1	87.5	16	-	-	0.844482
3	3	58.9	16	1351.0	1637.0	1.344681
4	2	99.2	18	1428.0	-	2.087140
5	2	65.7	20	1963.0	-	2.912032
6	3	77.2	17	1457.0	1144.0	3.539781
7	2	71.5	18	1161.0	-	4.539585
8	2	51.0	6	1305.0	-	4.667194
9	2	89.1	16	1609.0	-	5.613739
10	2	64.8	14	1674.0	-	6.173184
11	3	75.0	9	1820.0	1875.0	6.715896
12	3	58.7	14	1947.0	1064.0	7.633709
13	2	88.0	7	1783.0	-	8.077443
14	2	97.9	6	1398.0	-	8.827916
15	3	78.0	14	1042.0	1775.0	9.594421
16	3	89.3	15	1267.0	1355.0	10.067143
17	1	66.8	6	-	-	10.781377
18	3	69.9	7	1913.0	1325.0	11.982523

**Table 67 - CU-Acquire Low-Band Long Sequence Waveform Trial#16 (Detected)**

Burst #	# Pulses	Pulse Width (us)	Chirp (MHz)	Interval 1 to 2 (us)	Interval 2 to 3 (us)	Start time (s)
1	3	64.8	7	1141.0	1945.0	0.259968
2	2	81.9	14	1482.0	-	0.864534
3	3	89.8	7	1765.0	1639.0	2.033279
4	2	54.0	8	1229.0	-	2.132009
5	1	94.2	6	-	-	2.867997
6	2	80.1	7	1435.0	-	3.750112
7	2	74.3	17	1351.0	-	4.664239
8	2	92.0	12	1643.0	-	5.617156
9	3	58.5	12	1830.0	1001.0	5.875847
10	1	89.2	15	-	-	6.603209
11	2	94.1	9	1190.0	-	7.399897
12	2	83.3	15	1468.0	-	8.231817
13	1	50.4	15	-	-	9.111324
14	2	79.8	5	1984.0	-	9.780586
15	1	90.9	12	-	-	10.129514
16	2	55.1	20	1013.0	-	11.185336
17	1	71.3	11	-	-	11.341794

**Table 68 - CU-Acquire Low-Band Long Sequence Waveform Trial#17 (Detected)**

Burst #	# Pulses	Pulse Width (us)	Chirp (MHz)	Interval 1 to 2 (us)	Interval 2 to 3 (us)	Start time (s)
1	2	69.7	9	1901.0	-	0.021717
2	2	65.0	18	1373.0	-	0.642149
3	3	65.4	8	1303.0	1673.0	1.761284
4	3	68.8	17	1688.0	1855.0	2.256303
5	2	92.6	8	1805.0	-	2.899406
6	1	68.3	16	-	-	3.064005
7	3	76.8	13	1041.0	1022.0	3.838511
8	2	83.9	9	1767.0	-	4.219563
9	2	74.2	14	1356.0	-	5.263562



**Table 68 - CU-Acquire Low-Band Long Sequence Waveform Trial#17 (Detected)**

Burst #	# Pulses	Pulse Width (us)	Chirp (MHz)	Interval 1 to 2 (us)	Interval 2 to 3 (us)	Start time (s)
10	3	58.4	9	1897.0	1268.0	5.694735
11	2	55.0	20	1483.0	-	6.383008
12	3	57.0	13	1511.0	1157.0	6.965784
13	3	71.7	15	1382.0	1920.0	7.773114
14	2	71.6	15	1490.0	-	7.812390
15	3	51.0	19	1360.0	1485.0	8.784868
16	3	67.8	14	1306.0	1540.0	9.475993
17	3	84.8	13	1764.0	1859.0	9.760200
18	2	57.3	7	1512.0	-	10.221433
19	1	55.2	18	-	-	10.972797
20	2	75.4	9	1594.0	-	11.905943

**Table 69 - CU-Acquire Low-Band Long Sequence Waveform Trial#18 (Detected)**

Burst #	# Pulses	Pulse Width (us)	Chirp (MHz)	Interval 1 to 2 (us)	Interval 2 to 3 (us)	Start time (s)
1	2	92.9	18	1831.0	-	0.419560
2	2	51.2	10	1807.0	-	1.386723
3	3	51.1	8	1927.0	1671.0	2.216383
4	2	57.3	8	1593.0	-	2.653438
5	3	99.6	9	1012.0	1920.0	3.620714
6	2	95.1	20	1548.0	-	4.797647
7	2	81.4	16	1425.0	-	5.351440
8	3	90.5	7	1532.0	1312.0	5.668587
9	3	81.4	19	1795.0	1282.0	6.596996
10	2	83.7	11	1459.0	-	7.543406
11	1	98.6	13	-	-	8.421906
12	2	87.5	16	1199.0	-	9.168535
13	2	98.7	17	1500.0	-	10.164063
14	2	91.1	10	1906.0	-	10.995826
15	1	72.7	10	-	-	11.853797

**Table 70 - CU-Acquire Low-Band Long Sequence Waveform Trial#19 (Detected)**

Burst #	# Pulses	Pulse Width (us)	Chirp (MHz)	Interval 1 to 2 (us)	Interval 2 to 3 (us)	Start time (s)
1	2	96.8	18	1732.0	-	0.232804
2	2	54.0	9	1706.0	-	0.891257
3	3	77.8	13	1098.0	1390.0	1.666902
4	2	62.0	14	1882.0	-	2.379324
5	2	98.1	15	1132.0	-	2.755426
6	2	84.4	16	1814.0	-	3.698167
7	2	65.5	6	1120.0	-	4.507974
8	3	95.7	9	1590.0	1570.0	4.728727
9	2	81.8	16	1819.0	-	5.462904
10	2	69.9	20	1097.0	-	6.571401
11	2	94.2	11	1790.0	-	7.176953
12	2	56.6	12	1987.0	-	7.526134
13	3	88.3	10	1820.0	1993.0	8.550086
14	1	83.3	18	-	-	8.792658
15	1	89.0	10	-	-	9.964006
16	1	84.8	5	-	-	10.198915

<b>Table 70 - CU-Acquire Low-Band Long Sequence Waveform Trial#19 (Detected)</b>						
Burst #	# Pulses	Pulse Width (us)	Chirp (MHz)	Interval 1 to 2 (us)	Interval 2 to 3 (us)	Start time (s)
17	1	92.8	11	-	-	10.865280
18	2	52.3	17	1980.0	-	11.593461

<b>Table 71 - CU-Acquire Low-Band Long Sequence Waveform Trial#20 (Detected)</b>						
Burst #	# Pulses	Pulse Width (us)	Chirp (MHz)	Interval 1 to 2 (us)	Interval 2 to 3 (us)	Start time (s)
1	2	90.3	9	1717.0	-	0.565793
2	2	72.5	11	1197.0	-	1.471160
3	2	60.0	18	1459.0	-	2.129647
4	1	77.1	14	-	-	2.818449
5	3	87.6	16	1691.0	1872.0	3.810058
6	2	82.6	19	1874.0	-	5.103464
7	2	68.9	17	1171.0	-	5.774280
8	1	92.9	10	-	-	6.198672
9	1	63.8	9	-	-	7.662317
10	3	99.6	13	1684.0	1318.0	7.739519
11	3	91.5	5	1027.0	1561.0	9.241863
12	3	61.7	12	1383.0	1172.0	9.986386
13	2	96.3	16	1373.0	-	11.131927
14	2	81.1	10	1713.0	-	11.552276

<b>Table 72 - CU-Acquire Low-Band Long Sequence Waveform Trial#21 (Detected)</b>						
Burst #	# Pulses	Pulse Width (us)	Chirp (MHz)	Interval 1 to 2 (us)	Interval 2 to 3 (us)	Start time (s)
1	2	98.8	16	1417.0	-	0.629240
2	1	85.2	14	-	-	2.630968
3	1	75.3	12	-	-	3.410001
4	1	64.2	7	-	-	5.301623
5	3	99.7	13	1025.0	1938.0	6.056923
6	2	96.9	19	1117.0	-	8.204268
7	2	50.9	15	1628.0	-	9.365802
8	2	51.0	6	1122.0	-	11.097028

<b>Table 73 - CU-Acquire Low-Band Long Sequence Waveform Trial#22 (Detected)</b>						
Burst #	# Pulses	Pulse Width (us)	Chirp (MHz)	Interval 1 to 2 (us)	Interval 2 to 3 (us)	Start time (s)
1	1	72.2	19	-	-	0.108052
2	2	88.8	13	1428.0	-	1.663943
3	3	52.1	6	1358.0	1736.0	2.563088
4	3	59.8	16	1809.0	1047.0	3.348642
5	2	61.8	16	1223.0	-	3.732213
6	2	89.4	17	1220.0	-	5.121583
7	2	98.2	7	1629.0	-	5.353282
8	1	94.8	11	-	-	6.498667
9	2	56.3	12	1544.0	-	6.957359
10	2	70.0	6	1844.0	-	7.728309
11	1	51.0	19	-	-	8.853190
12	2	59.7	14	1030.0	-	10.027595
13	1	65.4	11	-	-	10.492741

<b>Table 73 - CU-Acquire Low-Band Long Sequence Waveform Trial#22 (Detected)</b>						
Burst #	# Pulses	Pulse Width (us)	Chirp (MHz)	Interval 1 to 2 (us)	Interval 2 to 3 (us)	Start time (s)
14	3	95.9	10	1805.0	1404.0	11.969993

<b>Table 74 - CU-Acquire Low-Band Long Sequence Waveform Trial#23 (Detected)</b>						
Burst #	# Pulses	Pulse Width (us)	Chirp (MHz)	Interval 1 to 2 (us)	Interval 2 to 3 (us)	Start time (s)
1	2	84.6	18	1685.0	-	0.212003
2	1	57.4	17	-	-	1.035081
3	3	87.3	18	1976.0	1611.0	1.823488
4	2	54.9	16	1078.0	-	1.983707
5	2	85.4	16	1456.0	-	2.952075
6	3	94.6	20	1716.0	1169.0	3.214613
7	3	83.2	13	1923.0	1616.0	3.812035
8	2	58.9	16	1580.0	-	4.447553
9	2	80.5	8	1337.0	-	5.634619
10	2	55.9	5	1710.0	-	5.701197
11	1	53.5	12	-	-	6.679653
12	2	62.3	6	1684.0	-	7.217556
13	1	78.3	16	-	-	7.945634
14	2	92.2	17	1656.0	-	8.742006
15	3	88.3	11	1771.0	1923.0	8.959081
16	2	66.6	8	1191.0	-	9.734608
17	2	88.8	15	1595.0	-	10.630281
18	1	88.6	17	-	-	11.072148
19	1	88.3	17	-	-	11.393625

<b>Table 75 - CU-Acquire Low-Band Long Sequence Waveform Trial#24 (Detected)</b>						
Burst #	# Pulses	Pulse Width (us)	Chirp (MHz)	Interval 1 to 2 (us)	Interval 2 to 3 (us)	Start time (s)
1	3	99.0	14	1296.0	1429.0	1.045171
2	3	73.4	9	1348.0	1796.0	2.004590
3	1	94.2	16	-	-	3.918053
4	3	54.8	18	1766.0	1529.0	4.541945
5	2	62.6	15	1709.0	-	6.383645
6	2	69.0	6	1364.0	-	6.893954
7	1	83.3	19	-	-	9.176060
8	3	51.7	19	1316.0	1804.0	9.531376
9	1	66.8	17	-	-	11.965720

<b>Table 76 - CU-Acquire Low-Band Long Sequence Waveform Trial#25 (Detected)</b>						
Burst #	# Pulses	Pulse Width (us)	Chirp (MHz)	Interval 1 to 2 (us)	Interval 2 to 3 (us)	Start time (s)
1	1	64.8	17	-	-	0.270723
2	1	90.6	20	-	-	2.019200
3	3	52.2	12	1419.0	1460.0	3.123181
4	3	98.8	13	1318.0	1624.0	4.434920
5	1	55.2	6	-	-	5.160419
6	2	58.1	6	1751.0	-	6.178873
7	3	80.4	5	1204.0	1494.0	8.048496
8	2	73.1	14	1626.0	-	9.108017

<b>Table 76 - CU-Acquire Low-Band Long Sequence Waveform Trial#25 (Detected)</b>						
Burst #	# Pulses	Pulse Width (us)	Chirp (MHz)	Interval 1 to 2 (us)	Interval 2 to 3 (us)	Start time (s)
9	3	58.0	8	1138.0	1403.0	9.982717
10	2	72.3	12	1377.0	-	11.363353

<b>Table 77 - CU-Acquire Low-Band Long Sequence Waveform Trial#26 (Detected)</b>						
Burst #	# Pulses	Pulse Width (us)	Chirp (MHz)	Interval 1 to 2 (us)	Interval 2 to 3 (us)	Start time (s)
1	3	74.2	19	1091.0	1497.0	0.068020
2	2	89.2	9	1433.0	-	1.233198
3	1	74.4	17	-	-	1.930125
4	2	58.5	9	1206.0	-	2.407325
5	1	97.7	18	-	-	3.141861
6	3	57.0	20	1264.0	1489.0	3.484915
7	3	86.7	11	1250.0	1880.0	4.619945
8	1	92.9	12	-	-	4.743541
9	2	73.1	6	1517.0	-	5.569826
10	2	53.7	18	1057.0	-	6.580204
11	2	93.5	18	1340.0	-	6.776598
12	1	95.8	7	-	-	7.385278
13	3	64.4	5	1943.0	1501.0	8.096642
14	2	72.3	8	1621.0	-	8.810328
15	2	58.3	20	1990.0	-	9.913786
16	1	82.8	10	-	-	10.308854
17	3	93.4	19	1422.0	1463.0	10.928910
18	2	82.6	7	1871.0	-	11.443662

<b>Table 78 - CU-Acquire Low-Band Long Sequence Waveform Trial#27 (Detected)</b>						
Burst #	# Pulses	Pulse Width (us)	Chirp (MHz)	Interval 1 to 2 (us)	Interval 2 to 3 (us)	Start time (s)
1	2	63.3	19	1132.0	-	0.808083
2	2	71.3	15	1095.0	-	1.950779
3	2	50.6	5	1144.0	-	3.991323
4	1	65.0	15	-	-	4.865133
5	3	89.0	17	1151.0	1975.0	6.534735
6	1	88.9	6	-	-	7.681761
7	2	53.2	19	1978.0	-	8.052152
8	2	58.1	9	1211.0	-	9.988150
9	2	60.9	12	1448.0	-	11.685964

<b>Table 79 - CU-Acquire Low-Band Long Sequence Waveform Trial#28 (Detected)</b>						
Burst #	# Pulses	Pulse Width (us)	Chirp (MHz)	Interval 1 to 2 (us)	Interval 2 to 3 (us)	Start time (s)
1	2	56.3	15	1380.0	-	0.858950
2	1	98.5	6	-	-	2.129052
3	2	63.8	14	1636.0	-	3.192630
4	2	91.5	15	1537.0	-	5.265208
5	1	97.1	11	-	-	5.516475
6	1	74.3	9	-	-	7.789479
7	2	68.8	14	1188.0	-	8.882762
8	2	86.2	9	1274.0	-	10.086536

<b>Table 79 - CU-Acquire Low-Band Long Sequence Waveform Trial#28 (Detected)</b>						
Burst #	# Pulses	Pulse Width (us)	Chirp (MHz)	Interval 1 to 2 (us)	Interval 2 to 3 (us)	Start time (s)
9	2	88.5	13	1561.0	-	11.131441

<b>Table 80 - CU-Acquire Low-Band Long Sequence Waveform Trial#29 (Detected)</b>						
Burst #	# Pulses	Pulse Width (us)	Chirp (MHz)	Interval 1 to 2 (us)	Interval 2 to 3 (us)	Start time (s)
1	1	50.1	16	-	-	0.178695
2	2	67.6	8	1221.0	-	1.901978
3	1	57.1	9	-	-	2.994833
4	1	96.9	15	-	-	3.469234
5	2	66.0	18	1592.0	-	4.168200
6	1	66.9	12	-	-	5.966553
7	2	82.4	14	1766.0	-	6.658619
8	2	89.7	13	1541.0	-	7.076216
9	2	56.2	11	1924.0	-	8.806403
10	3	79.1	9	1148.0	1401.0	9.131959
11	3	58.5	15	1298.0	1629.0	10.821586
12	2	67.9	10	1763.0	-	11.304483

<b>Table 81 - CU-Acquire Low-Band Long Sequence Waveform Trial#30 (Detected)</b>						
Burst #	# Pulses	Pulse Width (us)	Chirp (MHz)	Interval 1 to 2 (us)	Interval 2 to 3 (us)	Start time (s)
1	3	95.0	9	1441.0	1248.0	0.375966
2	2	96.3	20	1660.0	-	1.471579
3	2	79.2	8	1197.0	-	2.016098
4	3	68.0	17	1487.0	1856.0	2.985501
5	1	95.6	13	-	-	3.701805
6	2	51.8	7	1137.0	-	4.394395
7	2	91.1	10	1030.0	-	4.981450
8	1	54.2	14	-	-	5.630347
9	2	64.1	15	1755.0	-	6.157020
10	2	74.0	7	1851.0	-	6.795148
11	2	84.2	12	1349.0	-	7.914745
12	2	53.4	10	1325.0	-	8.385007
13	2	84.5	7	1304.0	-	9.669709
14	2	79.6	5	1874.0	-	9.979260
15	3	56.8	10	1483.0	1885.0	10.903935
16	2	58.1	17	1813.0	-	11.686564

<b>Table 82 - CU-Acquire Low-Band Long Sequence Waveform Trial#31 (Detected)</b>						
Burst #	# Pulses	Pulse Width (us)	Chirp (MHz)	Interval 1 to 2 (us)	Interval 2 to 3 (us)	Start time (s)
1	2	94.0	18	1908.0	-	0.217382
2	2	52.9	11	1976.0	-	1.724067
3	3	53.2	11	1959.0	1117.0	2.783822
4	1	59.4	9	-	-	4.205720
5	2	98.9	19	1730.0	-	4.795041
6	2	57.4	12	1857.0	-	5.975396
7	2	76.5	17	1829.0	-	7.028928
8	2	84.2	13	1200.0	-	7.827780

Burst #	# Pulses	Pulse Width (us)	Chirp (MHz)	Interval 1 to 2 (us)	Interval 2 to 3 (us)	Start time (s)
9	2	76.3	12	1198.0	-	9.049941
10	2	53.2	16	1936.0	-	9.889787
11	2	69.5	7	1279.0	-	11.160689

Trial #	Pulses/Burst	Pulse Width (us)	PRI (us)	Detected	Fr (MHz) and level (dBm)	Burst Information
1	9	1.0	333.0	Yes	5294.8MHz, -64.0dBm	Hop sequence: 5475, 5622, 5591, 5444, 5494, 5561, 5252, 5614, 5694, 5362, 5554, 5292, 5274, 5690, 5604, 5572, 5717, 5344, 5277, 5308, 5336, 5586, 5609, 5320, 5699, 5580, 5620, 5437, 5267, 5629, 5675, 5440, 5263, 5443, 5268, 5438, 5661, 5307, 5343, 5393, 5397, 5269, 5435, 5621, 5345, 5590, 5644, 5376, 5605, 5259, 5448, 5453, 5479, 5385, 5403, 5575, 5588, 5470, 5346, 5290, 5432, 5574, 5303, 5478, 5405, 5315, 5474, 5400, 5276, 5705, 5724, 5309, 5449, 5611, 5663, 5711, 5709, 5596, 5451, 5459, 5532, 5284, 5416, 5398, 5617, 5570, 5394, 5396, 5594, 5526, 5419, 5708, 5665, 5618, 5488, 5371, 5392, 5422, 5338, 5589 (6 hits) (11/19/2012 11:42:23 AM)
2	9	1.0	333.0	Yes	5295.8MHz, -64.0dBm	Hop sequence: 5718, 5393, 5518, 5723, 5321, 5688, 5323, 5544, 5263, 5526, 5558, 5525, 5540, 5329, 5377, 5367, 5360, 5569, 5670, 5304, 5400, 5622, 5508, 5265, 5413, 5392, 5309, 5704, 5562, 5522, 5711, 5300, 5556, 5658, 5506, 5313, 5399, 5628, 5378, 5470, 5468, 5606, 5422, 5633, 5411, 5611, 5356, 5517, 5342, 5529, 5394, 5690, 5361, 5675, 5301, 5441, 5567, 5632, 5260, 5474, 5499, 5479, 5669, 5298, 5691, 5616, 5717, 5475, 5678, 5642, 5570, 5337, 5362, 5279, 5320, 5282, 5694, 5697, 5493, 5487, 5452, 5531, 5483, 5699, 5341, 5520, 5683, 5510, 5351, 5349, 5724, 5682, 5719, 5610, 5715, 5641, 5532, 5266, 5461, 5430 (2 hits) (11/19/2012 11:43:08 AM)

Table 83 - FCC frequency hopping radar (Type 6) Results CU-Acquire Low-Band						
Trial #	Pulses/ Burst	Pulse Width (us)	PRI (us)	Detected	Fr (MHz) and level (dBm)	Burst Information
3	9	1.0	333.0	Yes	5273.8MHz, -64.0dBm	Hop sequence: 5348, 5645, 5334, 5409, 5493, 5595, 5323, 5505, 5681, 5609, 5602, 5271, 5422, 5622, 5511, 5711, 5255, 5534, 5305, 5463, 5632, 5558, 5708, 5380, 5541, 5560, 5506, 5387, 5275, 5486, 5641, 5699, 5262, 5530, 5282, 5298, 5297, 5611, 5382, 5718, 5385, 5587, 5689, 5553, 5672, 5517, 5624, 5574, 5504, 5449, 5285, 5401, 5721, 5430, 5269, 5376, 5312, 5266, 5709, 5446, 5566, 5425, 5319, 5639, 5398, 5336, 5518, 5647, 5660, 5606, 5357, 5543, 5588, 5605, 5597, 5667, 5390, 5513, 5525, 5326, 5310, 5292, 5423, 5331, 5300, 5644, 5441, 5519, 5261, 5352, 5306, 5378, 5328, 5629, 5377, 5627, 5502, 5569, 5440, 5489 (4 hits) (11/19/2012 11:43:18 AM)
4	9	1.0	333.0	Yes	5274.8MHz, -64.0dBm	Hop sequence: 5672, 5252, 5360, 5291, 5524, 5679, 5512, 5554, 5518, 5650, 5670, 5618, 5468, 5717, 5661, 5606, 5632, 5410, 5433, 5276, 5514, 5723, 5294, 5475, 5576, 5450, 5451, 5338, 5358, 5676, 5603, 5685, 5301, 5529, 5511, 5532, 5635, 5549, 5260, 5290, 5259, 5591, 5669, 5309, 5474, 5555, 5303, 5461, 5585, 5624, 5286, 5393, 5352, 5701, 5666, 5515, 5476, 5367, 5567, 5462, 5434, 5330, 5411, 5578, 5699, 5273, 5492, 5342, 5544, 5724, 5513, 5633, 5533, 5674, 5531, 5299, 5584, 5536, 5416, 5561, 5485, 5481, 5631, 5331, 5412, 5540, 5251, 5429, 5271, 5302, 5348, 5263, 5452, 5281, 5308, 5493, 5482, 5643, 5333, 5293 (7 hits) (11/19/2012 11:43:40 AM)

Table 83 - FCC frequency hopping radar (Type 6) Results CU-Acquire Low-Band						
Trial #	Pulses/ Burst	Pulse Width (us)	PRI (us)	Detected	Fr (MHz) and level (dBm)	Burst Information
5	9	1.0	333.0	Yes	5275.8MHz, -64.0dBm	Hop sequence: 5314, 5296, 5645, 5539, 5487, 5696, 5519, 5507, 5653, 5599, 5664, 5380, 5443, 5402, 5554, 5396, 5483, 5648, 5678, 5517, 5289, 5277, 5256, 5401, 5374, 5414, 5627, 5588, 5493, 5270, 5619, 5334, 5641, 5706, 5382, 5386, 5703, 5476, 5672, 5478, 5692, 5459, 5625, 5285, 5609, 5515, 5623, 5356, 5415, 5714, 5411, 5409, 5301, 5410, 5690, 5580, 5318, 5540, 5652, 5369, 5451, 5707, 5485, 5479, 5717, 5556, 5614, 5325, 5572, 5608, 5254, 5306, 5574, 5405, 5319, 5621, 5577, 5709, 5361, 5452, 5597, 5403, 5450, 5612, 5604, 5408, 5469, 5339, 5591, 5438, 5637, 5336, 5471, 5569, 5667, 5488, 5392, 5583, 5600, 5367 (3 hits) (11/19/2012 11:44:16 AM)
6	9	1.0	333.0	Yes	5276.8MHz, -64.0dBm	Hop sequence: 5522, 5407, 5376, 5318, 5397, 5566, 5408, 5279, 5632, 5629, 5623, 5399, 5404, 5674, 5295, 5552, 5411, 5715, 5615, 5439, 5343, 5491, 5266, 5319, 5426, 5419, 5345, 5610, 5547, 5721, 5630, 5364, 5724, 5277, 5373, 5372, 5384, 5631, 5455, 5265, 5421, 5636, 5606, 5644, 5253, 5553, 5526, 5586, 5489, 5482, 5637, 5578, 5573, 5478, 5486, 5393, 5335, 5256, 5556, 5587, 5370, 5317, 5476, 5437, 5666, 5427, 5296, 5591, 5471, 5516, 5423, 5639, 5708, 5337, 5643, 5656, 5722, 5299, 5595, 5331, 5585, 5368, 5558, 5428, 5590, 5545, 5594, 5665, 5618, 5625, 5633, 5655, 5605, 5324, 5689, 5380, 5280, 5466, 5456, 5495 (4 hits) (11/19/2012 11:44:26 AM)



Table 83 - FCC frequency hopping radar (Type 6) Results CU-Acquire Low-Band						
Trial #	Pulses/ Burst	Pulse Width (us)	PRI (us)	Detected	Fr (MHz) and level (dBm)	Burst Information
7	9	1.0	333.0	Yes	5277.8MHz, -64.0dBm	Hop sequence: 5384, 5610, 5645, 5611, 5276, 5252, 5261, 5538, 5720, 5599, 5417, 5395, 5493, 5605, 5562, 5530, 5300, 5665, 5653, 5531, 5564, 5659, 5424, 5328, 5451, 5683, 5507, 5582, 5480, 5546, 5452, 5644, 5368, 5295, 5560, 5573, 5602, 5620, 5350, 5587, 5600, 5458, 5403, 5332, 5357, 5511, 5705, 5586, 5710, 5699, 5358, 5366, 5563, 5259, 5716, 5601, 5306, 5580, 5521, 5355, 5370, 5524, 5688, 5310, 5535, 5686, 5496, 5363, 5256, 5340, 5558, 5313, 5440, 5414, 5473, 5433, 5315, 5495, 5667, 5320, 5508, 5471, 5308, 5343, 5615, 5527, 5307, 5612, 5438, 5642, 5569, 5447, 5400, 5671, 5388, 5501, 5668, 5585, 5435, 5651 (2 hits) (11/19/2012 11:44:35 AM)
8	9	1.0	333.0	Yes	5278.8MHz, -64.0dBm	Hop sequence: 5655, 5466, 5310, 5544, 5419, 5456, 5482, 5268, 5438, 5370, 5460, 5366, 5538, 5411, 5557, 5640, 5414, 5380, 5275, 5714, 5372, 5481, 5724, 5348, 5365, 5265, 5542, 5536, 5533, 5488, 5726, 5321, 5580, 5359, 5578, 5291, 5393, 5573, 5313, 5697, 5317, 5301, 5259, 5407, 5387, 5373, 5681, 5639, 5490, 5694, 5550, 5298, 5487, 5408, 5274, 5572, 5315, 5309, 5553, 5570, 5569, 5468, 5398, 5616, 5561, 5718, 5717, 5385, 5287, 5650, 5672, 5418, 5618, 5378, 5355, 5517, 5280, 5687, 5273, 5709, 5451, 5430, 5513, 5598, 5554, 5343, 5412, 5610, 5371, 5656, 5698, 5264, 5501, 5469, 5423, 5654, 5349, 5563, 5492, 5364 (5 hits) (11/19/2012 11:44:52 AM)

Table 83 - FCC frequency hopping radar (Type 6) Results CU-Acquire Low-Band						
Trial #	Pulses/ Burst	Pulse Width (us)	PRI (us)	Detected	Fr (MHz) and level (dBm)	Burst Information
9	9	1.0	333.0	Yes	5279.8MHz, -64.0dBm	Hop sequence: 5519, 5599, 5443, 5375, 5255, 5397, 5314, 5608, 5472, 5690, 5276, 5379, 5616, 5495, 5502, 5415, 5313, 5340, 5713, 5289, 5449, 5571, 5505, 5718, 5360, 5462, 5280, 5323, 5628, 5412, 5480, 5380, 5316, 5258, 5395, 5463, 5389, 5694, 5381, 5667, 5290, 5663, 5262, 5721, 5470, 5489, 5307, 5362, 5689, 5350, 5512, 5271, 5552, 5447, 5341, 5260, 5471, 5408, 5344, 5478, 5556, 5634, 5450, 5602, 5562, 5711, 5490, 5598, 5500, 5630, 5327, 5653, 5647, 5448, 5418, 5492, 5507, 5293, 5263, 5305, 5578, 5451, 5457, 5688, 5353, 5699, 5309, 5484, 5704, 5428, 5283, 5378, 5656, 5370, 5403, 5299, 5328, 5702, 5645, 5466 (6 hits) (11/19/2012 11:45:08 AM)
10	9	1.0	333.0	Yes	5280.8MHz, -64.0dBm	Hop sequence: 5294, 5304, 5463, 5564, 5374, 5413, 5589, 5436, 5433, 5450, 5351, 5591, 5434, 5666, 5660, 5469, 5286, 5547, 5435, 5648, 5563, 5422, 5675, 5587, 5254, 5586, 5390, 5459, 5646, 5340, 5717, 5273, 5634, 5561, 5355, 5360, 5673, 5531, 5540, 5535, 5372, 5718, 5384, 5711, 5283, 5453, 5575, 5325, 5279, 5609, 5458, 5318, 5536, 5641, 5509, 5596, 5366, 5395, 5560, 5479, 5281, 5608, 5592, 5282, 5439, 5411, 5484, 5404, 5403, 5520, 5399, 5713, 5334, 5293, 5278, 5695, 5367, 5537, 5538, 5659, 5725, 5314, 5628, 5568, 5382, 5688, 5451, 5616, 5597, 5606, 5493, 5381, 5312, 5444, 5445, 5480, 5341, 5546, 5501, 5571 (8 hits) (11/19/2012 11:45:28 AM)

Table 83 - FCC frequency hopping radar (Type 6) Results CU-Acquire Low-Band						
Trial #	Pulses/ Burst	Pulse Width (us)	PRI (us)	Detected	Fr (MHz) and level (dBm)	Burst Information
11	9	1.0	333.0	Yes	5281.8MHz, -64.0dBm	Hop sequence: 5714, 5704, 5467, 5293, 5531, 5395, 5327, 5651, 5532, 5431, 5376, 5326, 5402, 5449, 5456, 5553, 5622, 5518, 5580, 5507, 5444, 5575, 5446, 5610, 5565, 5434, 5281, 5407, 5433, 5717, 5409, 5637, 5604, 5660, 5612, 5566, 5483, 5482, 5438, 5422, 5494, 5369, 5555, 5701, 5542, 5715, 5668, 5602, 5600, 5415, 5609, 5252, 5621, 5564, 5694, 5547, 5284, 5597, 5378, 5678, 5355, 5474, 5599, 5698, 5487, 5635, 5466, 5638, 5654, 5365, 5511, 5561, 5377, 5256, 5318, 5552, 5375, 5667, 5680, 5345, 5559, 5579, 5554, 5541, 5716, 5383, 5573, 5630, 5527, 5335, 5470, 5598, 5260, 5459, 5418, 5401, 5679, 5523, 5710, 5308 (3 hits) (11/19/2012 11:45:42 AM)
12	9	1.0	333.0	Yes	5282.8MHz, -64.0dBm	Hop sequence: 5605, 5495, 5679, 5570, 5293, 5578, 5643, 5416, 5560, 5726, 5725, 5453, 5595, 5294, 5528, 5620, 5471, 5640, 5517, 5707, 5433, 5638, 5343, 5706, 5644, 5285, 5419, 5445, 5395, 5349, 5564, 5613, 5627, 5288, 5303, 5683, 5616, 5259, 5546, 5695, 5681, 5630, 5549, 5566, 5519, 5277, 5607, 5512, 5499, 5401, 5685, 5669, 5437, 5451, 5496, 5369, 5609, 5705, 5541, 5539, 5327, 5559, 5633, 5318, 5653, 5665, 5634, 5567, 5687, 5420, 5561, 5573, 5650, 5276, 5376, 5469, 5380, 5371, 5279, 5298, 5398, 5368, 5684, 5700, 5538, 5428, 5505, 5489, 5443, 5701, 5402, 5529, 5360, 5720, 5272, 5466, 5346, 5321, 5358, 5267 (7 hits) (11/19/2012 11:46:23 AM)

Table 83 - FCC frequency hopping radar (Type 6) Results CU-Acquire Low-Band						
Trial #	Pulses/ Burst	Pulse Width (us)	PRI (us)	Detected	Fr (MHz) and level (dBm)	Burst Information
13	9	1.0	333.0	Yes	5283.8MHz, -64.0dBm	Hop sequence: 5327, 5665, 5284, 5603, 5494, 5346, 5563, 5353, 5379, 5253, 5639, 5641, 5577, 5654, 5511, 5527, 5365, 5486, 5710, 5566, 5313, 5400, 5411, 5705, 5312, 5424, 5605, 5333, 5587, 5454, 5586, 5660, 5318, 5266, 5663, 5634, 5558, 5708, 5335, 5263, 5608, 5410, 5615, 5421, 5341, 5624, 5684, 5463, 5470, 5267, 5355, 5395, 5530, 5627, 5674, 5529, 5295, 5625, 5451, 5300, 5316, 5372, 5331, 5520, 5500, 5685, 5612, 5647, 5252, 5651, 5354, 5447, 5317, 5549, 5643, 5536, 5448, 5488, 5435, 5541, 5352, 5523, 5622, 5544, 5698, 5337, 5437, 5375, 5450, 5696, 5626, 5506, 5422, 5548, 5305, 5471, 5539, 5526, 5561, 5709 (2 hits) (11/19/2012 11:46:46 AM)
14	9	1.0	333.0	Yes	5284.8MHz, -64.0dBm	Hop sequence: 5364, 5476, 5519, 5707, 5383, 5388, 5503, 5537, 5311, 5272, 5382, 5602, 5431, 5505, 5695, 5596, 5558, 5552, 5400, 5684, 5530, 5687, 5451, 5704, 5320, 5515, 5559, 5316, 5447, 5283, 5266, 5593, 5499, 5686, 5597, 5352, 5269, 5480, 5420, 5561, 5489, 5411, 5632, 5573, 5271, 5462, 5670, 5279, 5538, 5252, 5344, 5368, 5402, 5615, 5600, 5636, 5618, 5304, 5496, 5298, 5297, 5653, 5308, 5715, 5332, 5608, 5456, 5327, 5708, 5610, 5409, 5379, 5273, 5355, 5620, 5426, 5527, 5453, 5529, 5345, 5693, 5638, 5717, 5346, 5682, 5556, 5336, 5270, 5471, 5611, 5576, 5479, 5287, 5614, 5518, 5650, 5692, 5491, 5474, 5507 (3 hits) (11/19/2012 11:46:59 AM)

Table 83 - FCC frequency hopping radar (Type 6) Results CU-Acquire Low-Band						
Trial #	Pulses/ Burst	Pulse Width (us)	PRI (us)	Detected	Fr (MHz) and level (dBm)	Burst Information
15	9	1.0	333.0	Yes	5285.8MHz, -64.0dBm	Hop sequence: 5706, 5446, 5699, 5716, 5526, 5619, 5725, 5643, 5676, 5668, 5413, 5341, 5605, 5595, 5673, 5638, 5371, 5418, 5684, 5368, 5546, 5447, 5273, 5670, 5331, 5713, 5612, 5286, 5697, 5345, 5327, 5425, 5695, 5414, 5379, 5401, 5580, 5564, 5611, 5717, 5667, 5486, 5529, 5516, 5356, 5456, 5474, 5438, 5264, 5551, 5519, 5340, 5627, 5364, 5644, 5357, 5354, 5681, 5476, 5315, 5632, 5428, 5285, 5343, 5653, 5623, 5532, 5460, 5558, 5369, 5402, 5494, 5445, 5601, 5488, 5318, 5541, 5482, 5427, 5637, 5380, 5633, 5694, 5658, 5322, 5577, 5504, 5443, 5333, 5410, 5400, 5372, 5672, 5718, 5671, 5359, 5407, 5335, 5594, 5362 (2 hits) (11/19/2012 11:47:10 AM)
16	9	1.0	333.0	Yes	5286.8MHz, -64.0dBm	Hop sequence: 5623, 5379, 5369, 5394, 5408, 5273, 5417, 5498, 5585, 5598, 5438, 5410, 5580, 5589, 5530, 5272, 5270, 5261, 5347, 5393, 5639, 5631, 5362, 5475, 5640, 5657, 5388, 5543, 5557, 5401, 5702, 5446, 5698, 5677, 5274, 5712, 5306, 5708, 5511, 5389, 5660, 5593, 5636, 5411, 5684, 5669, 5299, 5256, 5477, 5613, 5361, 5271, 5675, 5517, 5554, 5668, 5519, 5665, 5289, 5703, 5482, 5495, 5463, 5608, 5268, 5503, 5494, 5565, 5426, 5455, 5618, 5617, 5370, 5301, 5583, 5715, 5440, 5429, 5359, 5673, 5266, 5264, 5587, 5297, 5582, 5591, 5390, 5597, 5404, 5526, 5449, 5392, 5365, 5634, 5343, 5716, 5603, 5635, 5367, 5329 (2 hits) (11/19/2012 11:47:21 AM)

Table 83 - FCC frequency hopping radar (Type 6) Results CU-Acquire Low-Band						
Trial #	Pulses/ Burst	Pulse Width (us)	PRI (us)	Detected	Fr (MHz) and level (dBm)	Burst Information
17	9	1.0	333.0	Yes	5287.8MHz, -64.0dBm	Hop sequence: 5366, 5671, 5653, 5463, 5638, 5648, 5602, 5499, 5475, 5545, 5350, 5466, 5717, 5697, 5500, 5357, 5498, 5441, 5676, 5701, 5639, 5527, 5704, 5278, 5284, 5269, 5600, 5339, 5705, 5310, 5427, 5454, 5583, 5488, 5564, 5601, 5383, 5515, 5392, 5662, 5587, 5343, 5328, 5719, 5631, 5399, 5637, 5589, 5523, 5626, 5433, 5534, 5550, 5695, 5548, 5526, 5323, 5688, 5487, 5471, 5371, 5661, 5659, 5270, 5537, 5658, 5476, 5250, 5279, 5421, 5271, 5635, 5470, 5308, 5266, 5398, 5664, 5429, 5267, 5709, 5533, 5591, 5513, 5344, 5320, 5256, 5437, 5391, 5522, 5592, 5568, 5612, 5351, 5439, 5261, 5654, 5549, 5703, 5296, 5354 (3 hits) (11/19/2012 11:47:32 AM)
18	9	1.0	333.0	Yes	5288.8MHz, -64.0dBm	Hop sequence: 5506, 5300, 5630, 5670, 5319, 5332, 5411, 5262, 5589, 5405, 5269, 5703, 5563, 5474, 5287, 5436, 5261, 5666, 5268, 5273, 5521, 5452, 5616, 5529, 5507, 5721, 5530, 5651, 5501, 5593, 5688, 5638, 5396, 5709, 5385, 5680, 5412, 5281, 5700, 5640, 5353, 5459, 5415, 5687, 5306, 5313, 5592, 5458, 5535, 5330, 5655, 5511, 5388, 5610, 5577, 5549, 5693, 5478, 5381, 5275, 5534, 5258, 5345, 5298, 5542, 5565, 5479, 5357, 5375, 5369, 5265, 5324, 5515, 5485, 5552, 5291, 5573, 5679, 5641, 5611, 5723, 5447, 5282, 5551, 5607, 5556, 5444, 5294, 5331, 5303, 5510, 5644, 5377, 5614, 5431, 5363, 5648, 5333, 5417, 5464 (6 hits) (11/19/2012 11:47:40 AM)

Table 83 - FCC frequency hopping radar (Type 6) Results CU-Acquire Low-Band						
Trial #	Pulses/ Burst	Pulse Width (us)	PRI (us)	Detected	Fr (MHz) and level (dBm)	Burst Information
19	9	1.0	333.0	Yes	5289.8MHz, -64.0dBm	Hop sequence: 5439, 5695, 5491, 5501, 5638, 5661, 5423, 5386, 5516, 5325, 5463, 5644, 5521, 5270, 5541, 5574, 5295, 5414, 5330, 5268, 5654, 5602, 5658, 5500, 5569, 5271, 5589, 5282, 5366, 5633, 5434, 5464, 5656, 5341, 5348, 5362, 5466, 5331, 5457, 5552, 5544, 5712, 5461, 5309, 5428, 5667, 5410, 5255, 5335, 5645, 5265, 5333, 5531, 5525, 5508, 5258, 5540, 5539, 5675, 5704, 5504, 5487, 5290, 5273, 5502, 5683, 5274, 5394, 5673, 5515, 5548, 5535, 5680, 5708, 5317, 5591, 5413, 5319, 5637, 5361, 5511, 5304, 5674, 5600, 5360, 5381, 5488, 5636, 5615, 5376, 5296, 5577, 5307, 5370, 5368, 5628, 5339, 5468, 5431, 5554 (4 hits) (11/19/2012 11:47:47 AM)
20	9	1.0	333.0	Yes	5290.8MHz, -64.0dBm	Hop sequence: 5637, 5539, 5446, 5397, 5553, 5492, 5712, 5352, 5582, 5542, 5649, 5395, 5405, 5261, 5687, 5534, 5331, 5591, 5530, 5498, 5622, 5343, 5258, 5273, 5596, 5502, 5281, 5302, 5692, 5453, 5664, 5403, 5402, 5483, 5347, 5490, 5477, 5641, 5613, 5465, 5512, 5472, 5667, 5476, 5716, 5298, 5569, 5563, 5513, 5305, 5419, 5377, 5386, 5438, 5427, 5339, 5489, 5589, 5440, 5615, 5568, 5685, 5668, 5297, 5301, 5666, 5336, 5308, 5577, 5328, 5533, 5516, 5378, 5401, 5406, 5324, 5413, 5636, 5382, 5501, 5353, 5680, 5507, 5566, 5271, 5600, 5722, 5496, 5548, 5318, 5479, 5659, 5676, 5356, 5451, 5311, 5470, 5655, 5436, 5721 (1 hits) (11/19/2012 11:48:07 AM)

Table 83 - FCC frequency hopping radar (Type 6) Results CU-Acquire Low-Band						
Trial #	Pulses/ Burst	Pulse Width (us)	PRI (us)	Detected	Fr (MHz) and level (dBm)	Burst Information
21	9	1.0	333.0	Yes	5291.8MHz, -64.0dBm	Hop sequence: 5603, 5571, 5280, 5452, 5583, 5359, 5319, 5509, 5705, 5300, 5341, 5503, 5536, 5549, 5387, 5424, 5502, 5525, 5260, 5568, 5290, 5683, 5519, 5388, 5416, 5276, 5504, 5371, 5396, 5693, 5461, 5640, 5408, 5524, 5582, 5556, 5672, 5707, 5718, 5369, 5421, 5354, 5348, 5592, 5510, 5715, 5422, 5254, 5505, 5651, 5308, 5574, 5551, 5274, 5484, 5722, 5363, 5666, 5602, 5415, 5596, 5724, 5318, 5699, 5331, 5711, 5611, 5412, 5606, 5668, 5258, 5634, 5661, 5434, 5314, 5639, 5284, 5533, 5578, 5399, 5531, 5480, 5470, 5266, 5506, 5604, 5622, 5501, 5599, 5635, 5566, 5382, 5710, 5682, 5482, 5362, 5694, 5587, 5301, 5678 (5 hits) (11/19/2012 11:48:19 AM)
22	9	1.0	333.0	Yes	5292.8MHz, -64.0dBm	Hop sequence: 5516, 5602, 5540, 5423, 5711, 5301, 5407, 5408, 5613, 5595, 5616, 5347, 5373, 5668, 5473, 5370, 5369, 5557, 5400, 5508, 5624, 5691, 5465, 5271, 5420, 5446, 5611, 5348, 5519, 5282, 5317, 5575, 5651, 5572, 5498, 5702, 5696, 5505, 5714, 5527, 5666, 5316, 5581, 5428, 5294, 5336, 5580, 5353, 5267, 5330, 5532, 5520, 5526, 5382, 5406, 5322, 5385, 5430, 5261, 5468, 5699, 5254, 5507, 5463, 5523, 5642, 5567, 5448, 5356, 5272, 5292, 5600, 5587, 5379, 5544, 5627, 5599, 5308, 5592, 5257, 5433, 5650, 5515, 5606, 5464, 5391, 5649, 5311, 5667, 5455, 5546, 5422, 5537, 5597, 5323, 5304, 5327, 5577, 5255, 5674 (3 hits) (11/19/2012 11:48:35 AM)



Table 83 - FCC frequency hopping radar (Type 6) Results CU-Acquire Low-Band						
Trial #	Pulses/ Burst	Pulse Width (us)	PRI (us)	Detected	Fr (MHz) and level (dBm)	Burst Information
23	9	1.0	333.0	No	5293.8MHz, -64.0dBm	Hop sequence: 5442, 5417, 5581, 5648, 5367, 5663, 5361, 5614, 5672, 5499, 5313, 5458, 5624, 5700, 5524, 5418, 5626, 5338, 5322, 5572, 5599, 5416, 5411, 5350, 5495, 5609, 5548, 5698, 5610, 5579, 5272, 5514, 5437, 5719, 5546, 5622, 5511, 5569, 5312, 5684, 5265, 5290, 5379, 5428, 5480, 5681, 5360, 5370, 5676, 5658, 5677, 5352, 5443, 5332, 5334, 5394, 5357, 5252, 5616, 5680, 5407, 5715, 5638, 5503, 5551, 5566, 5575, 5600, 5697, 5373, 5469, 5447, 5320, 5553, 5570, 5512, 5695, 5723, 5513, 5619, 5659, 5253, 5555, 5329, 5330, 5544, 5483, 5716, 5501, 5682, 5317, 5594, 5639, 5714, 5686, 5431, 5316, 5632, 5540, 5661 (1 hits) (11/19/2012 11:48:52 AM)
24	9	1.0	333.0	Yes	5294.8MHz, -64.0dBm	Hop sequence: 5381, 5411, 5451, 5428, 5592, 5398, 5322, 5366, 5388, 5353, 5277, 5267, 5535, 5409, 5278, 5549, 5632, 5486, 5683, 5538, 5572, 5295, 5449, 5272, 5724, 5412, 5459, 5470, 5695, 5525, 5515, 5281, 5689, 5700, 5495, 5434, 5354, 5296, 5651, 5688, 5361, 5682, 5479, 5313, 5649, 5347, 5367, 5672, 5490, 5665, 5573, 5341, 5438, 5620, 5342, 5330, 5266, 5505, 5701, 5712, 5443, 5351, 5472, 5376, 5292, 5321, 5487, 5570, 5558, 5662, 5636, 5285, 5726, 5498, 5623, 5519, 5380, 5466, 5375, 5391, 5312, 5404, 5410, 5265, 5707, 5542, 5253, 5690, 5643, 5540, 5408, 5332, 5642, 5378, 5421, 5601, 5357, 5517, 5386, 5717 (6 hits) (11/19/2012 11:49:10 AM)

Table 83 - FCC frequency hopping radar (Type 6) Results CU-Acquire Low-Band						
Trial #	Pulses/ Burst	Pulse Width (us)	PRI (us)	Detected	Fr (MHz) and level (dBm)	Burst Information
25	9	1.0	333.0	Yes	5295.8MHz, -64.0dBm	Hop sequence: 5260, 5549, 5552, 5486, 5652, 5409, 5397, 5622, 5492, 5375, 5515, 5670, 5630, 5631, 5697, 5723, 5461, 5262, 5709, 5471, 5480, 5348, 5420, 5442, 5386, 5505, 5297, 5617, 5641, 5484, 5377, 5577, 5355, 5591, 5564, 5691, 5632, 5496, 5578, 5430, 5462, 5602, 5655, 5724, 5676, 5716, 5405, 5417, 5317, 5557, 5558, 5327, 5435, 5410, 5571, 5324, 5661, 5459, 5611, 5279, 5680, 5595, 5268, 5596, 5358, 5663, 5576, 5419, 5460, 5588, 5554, 5349, 5424, 5685, 5721, 5569, 5425, 5285, 5357, 5494, 5668, 5254, 5270, 5329, 5320, 5485, 5353, 5635, 5483, 5583, 5403, 5532, 5328, 5333, 5261, 5498, 5511, 5520, 5575, 5296 (2 hits) (11/19/2012 11:49:21 AM)
26	9	1.0	333.0	Yes	5273.8MHz, -64.0dBm	Hop sequence: 5366, 5474, 5334, 5402, 5642, 5289, 5371, 5383, 5676, 5500, 5286, 5467, 5370, 5572, 5575, 5677, 5426, 5387, 5317, 5651, 5703, 5614, 5611, 5300, 5664, 5613, 5665, 5629, 5464, 5457, 5489, 5586, 5270, 5592, 5658, 5263, 5323, 5563, 5551, 5660, 5497, 5706, 5573, 5630, 5393, 5367, 5293, 5420, 5549, 5417, 5400, 5468, 5403, 5709, 5296, 5628, 5430, 5684, 5384, 5711, 5644, 5507, 5381, 5565, 5345, 5267, 5272, 5485, 5525, 5546, 5282, 5696, 5433, 5466, 5619, 5392, 5449, 5589, 5428, 5447, 5440, 5571, 5302, 5284, 5335, 5699, 5564, 5258, 5513, 5406, 5670, 5368, 5333, 5574, 5360, 5626, 5340, 5266, 5578, 5256 (5 hits) (11/19/2012 11:49:38 AM)

Table 83 - FCC frequency hopping radar (Type 6) Results CU-Acquire Low-Band						
Trial #	Pulses/ Burst	Pulse Width (us)	PRI (us)	Detected	Fr (MHz) and level (dBm)	Burst Information
27	9	1.0	333.0	Yes	5274.8MHz, -64.0dBm	Hop sequence: 5569, 5314, 5700, 5340, 5666, 5586, 5681, 5673, 5349, 5510, 5449, 5480, 5425, 5337, 5356, 5321, 5682, 5427, 5559, 5566, 5277, 5271, 5634, 5667, 5365, 5578, 5670, 5496, 5284, 5366, 5488, 5595, 5562, 5628, 5256, 5397, 5724, 5661, 5513, 5295, 5704, 5464, 5445, 5300, 5703, 5323, 5267, 5563, 5438, 5412, 5266, 5501, 5550, 5441, 5544, 5389, 5523, 5361, 5675, 5345, 5679, 5657, 5398, 5374, 5342, 5292, 5442, 5497, 5517, 5489, 5632, 5388, 5576, 5327, 5281, 5629, 5474, 5495, 5297, 5308, 5273, 5659, 5439, 5282, 5643, 5381, 5572, 5484, 5418, 5665, 5290, 5527, 5304, 5539, 5564, 5258, 5580, 5663, 5610, 5524 (7 hits) (11/19/2012 11:49:46 AM)
28	9	1.0	333.0	Yes	5275.8MHz, -64.0dBm	Hop sequence: 5560, 5531, 5470, 5700, 5412, 5649, 5324, 5579, 5397, 5568, 5313, 5706, 5580, 5305, 5507, 5626, 5379, 5598, 5474, 5436, 5255, 5311, 5493, 5567, 5599, 5461, 5588, 5323, 5377, 5540, 5440, 5703, 5476, 5418, 5690, 5600, 5725, 5341, 5298, 5490, 5496, 5369, 5677, 5655, 5288, 5570, 5283, 5286, 5259, 5327, 5269, 5336, 5271, 5704, 5702, 5538, 5373, 5266, 5466, 5333, 5550, 5350, 5556, 5282, 5445, 5621, 5460, 5722, 5634, 5345, 5267, 5497, 5421, 5552, 5658, 5399, 5514, 5601, 5709, 5659, 5473, 5619, 5411, 5648, 5270, 5358, 5312, 5710, 5650, 5566, 5651, 5464, 5297, 5694, 5519, 5435, 5410, 5631, 5432, 5450 (4 hits) (11/19/2012 11:50:00 AM)

Table 83 - FCC frequency hopping radar (Type 6) Results CU-Acquire Low-Band						
Trial #	Pulses/ Burst	Pulse Width (us)	PRI (us)	Detected	Fr (MHz) and level (dBm)	Burst Information
29	9	1.0	333.0	Yes	5276.8MHz, -64.0dBm	Hop sequence: 5503, 5333, 5257, 5307, 5424, 5598, 5379, 5453, 5524, 5481, 5624, 5536, 5469, 5696, 5586, 5289, 5296, 5410, 5648, 5683, 5491, 5617, 5366, 5338, 5708, 5530, 5275, 5386, 5681, 5652, 5687, 5721, 5600, 5557, 5480, 5400, 5515, 5440, 5505, 5442, 5618, 5308, 5263, 5644, 5427, 5310, 5364, 5713, 5672, 5459, 5423, 5628, 5329, 5399, 5392, 5456, 5461, 5348, 5288, 5700, 5325, 5381, 5367, 5714, 5422, 5478, 5271, 5634, 5695, 5429, 5264, 5720, 5495, 5498, 5394, 5588, 5354, 5608, 5463, 5473, 5561, 5251, 5294, 5336, 5603, 5359, 5431, 5519, 5281, 5425, 5449, 5321, 5414, 5577, 5724, 5594, 5331, 5569, 5537, 5516 (5 hits) (11/19/2012 11:51:05 AM)
30	9	1.0	333.0	Yes	5277.8MHz, -64.0dBm	Hop sequence: 5583, 5507, 5695, 5420, 5480, 5429, 5520, 5586, 5331, 5635, 5422, 5316, 5585, 5474, 5293, 5600, 5597, 5655, 5463, 5710, 5568, 5667, 5265, 5292, 5481, 5498, 5333, 5684, 5355, 5307, 5266, 5416, 5483, 5323, 5281, 5591, 5690, 5623, 5326, 5500, 5320, 5562, 5699, 5357, 5718, 5685, 5324, 5336, 5702, 5680, 5300, 5310, 5468, 5354, 5408, 5295, 5622, 5378, 5359, 5325, 5580, 5367, 5641, 5296, 5539, 5570, 5362, 5663, 5530, 5360, 5400, 5723, 5608, 5428, 5464, 5708, 5683, 5482, 5259, 5364, 5503, 5496, 5582, 5617, 5311, 5633, 5709, 5277, 5456, 5697, 5531, 5274, 5319, 5502, 5353, 5626, 5572, 5486, 5346, 5454 (6 hits) (11/19/2012 11:51:13 AM)

Table 83 - FCC frequency hopping radar (Type 6) Results CU-Acquire Low-Band						
Trial #	Pulses/ Burst	Pulse Width (us)	PRI (us)	Detected	Fr (MHz) and level (dBm)	Burst Information
31	9	1.0	333.0	Yes	5278.8MHz, -64.0dBm	Hop sequence: 5353, 5269, 5360, 5718, 5635, 5375, 5346, 5469, 5563, 5711, 5676, 5576, 5370, 5570, 5405, 5315, 5641, 5696, 5584, 5470, 5534, 5597, 5457, 5313, 5287, 5643, 5262, 5336, 5488, 5631, 5402, 5383, 5536, 5706, 5364, 5484, 5310, 5609, 5527, 5720, 5424, 5358, 5671, 5698, 5464, 5398, 5423, 5306, 5481, 5406, 5449, 5688, 5292, 5479, 5380, 5634, 5444, 5324, 5549, 5317, 5578, 5465, 5253, 5302, 5587, 5331, 5591, 5265, 5681, 5673, 5329, 5461, 5327, 5725, 5319, 5504, 5610, 5478, 5566, 5560, 5600, 5687, 5595, 5475, 5599, 5305, 5623, 5668, 5675, 5411, 5463, 5275, 5418, 5495, 5637, 5419, 5446, 5335, 5480, 5514 (3 hits) (11/19/2012 11:51:25 AM)
32	9	1.0	333.0	Yes	5279.8MHz, -64.0dBm	Hop sequence: 5549, 5667, 5451, 5326, 5302, 5673, 5546, 5288, 5647, 5555, 5628, 5723, 5683, 5418, 5376, 5458, 5522, 5443, 5614, 5413, 5680, 5289, 5634, 5472, 5446, 5431, 5280, 5382, 5630, 5637, 5726, 5502, 5568, 5567, 5578, 5293, 5386, 5357, 5447, 5684, 5330, 5609, 5393, 5547, 5560, 5403, 5465, 5385, 5270, 5272, 5463, 5492, 5315, 5672, 5309, 5638, 5391, 5692, 5380, 5707, 5506, 5286, 5462, 5557, 5317, 5505, 5454, 5710, 5693, 5328, 5474, 5427, 5417, 5521, 5629, 5347, 5384, 5268, 5500, 5573, 5625, 5301, 5351, 5298, 5597, 5594, 5645, 5442, 5537, 5337, 5517, 5535, 5343, 5615, 5285, 5576, 5515, 5481, 5290, 5657 (7 hits) (11/19/2012 11:51:40 AM)

Table 83 - FCC frequency hopping radar (Type 6) Results CU-Acquire Low-Band						
Trial #	Pulses/ Burst	Pulse Width (us)	PRI (us)	Detected	Fr (MHz) and level (dBm)	Burst Information
33	9	1.0	333.0	Yes	5280.8MHz, -64.0dBm	Hop sequence: 5455, 5663, 5670, 5705, 5459, 5271, 5649, 5542, 5362, 5582, 5559, 5538, 5614, 5662, 5456, 5276, 5492, 5685, 5723, 5704, 5423, 5356, 5299, 5711, 5441, 5328, 5657, 5348, 5383, 5429, 5631, 5272, 5531, 5552, 5717, 5265, 5696, 5520, 5608, 5625, 5517, 5430, 5606, 5719, 5576, 5308, 5397, 5419, 5491, 5577, 5706, 5382, 5304, 5341, 5303, 5537, 5408, 5433, 5692, 5712, 5661, 5636, 5580, 5518, 5534, 5713, 5484, 5440, 5641, 5660, 5602, 5261, 5530, 5505, 5400, 5269, 5342, 5264, 5381, 5560, 5561, 5324, 5720, 5365, 5404, 5687, 5572, 5317, 5494, 5545, 5313, 5462, 5673, 5346, 5385, 5277, 5645, 5541, 5405, 5406 (2 hits) (11/19/2012 11:51:47 AM)
34	9	1.0	333.0	Yes	5281.8MHz, -64.0dBm	Hop sequence: 5647, 5381, 5549, 5700, 5330, 5608, 5499, 5584, 5693, 5454, 5265, 5681, 5377, 5359, 5461, 5684, 5392, 5294, 5677, 5292, 5548, 5410, 5486, 5477, 5353, 5400, 5428, 5451, 5562, 5417, 5712, 5424, 5391, 5705, 5258, 5578, 5343, 5595, 5346, 5365, 5427, 5620, 5293, 5671, 5301, 5462, 5725, 5675, 5378, 5650, 5313, 5519, 5663, 5572, 5363, 5414, 5537, 5366, 5388, 5510, 5285, 5344, 5539, 5457, 5437, 5555, 5433, 5328, 5714, 5415, 5679, 5490, 5385, 5504, 5520, 5544, 5345, 5468, 5358, 5701, 5470, 5514, 5505, 5460, 5639, 5583, 5374, 5348, 5511, 5723, 5320, 5579, 5625, 5473, 5271, 5489, 5602, 5390, 5630, 5565 (4 hits) (11/19/2012 11:51:54 AM)

Table 83 - FCC frequency hopping radar (Type 6) Results CU-Acquire Low-Band						
Trial #	Pulses/ Burst	Pulse Width (us)	PRI (us)	Detected	Fr (MHz) and level (dBm)	Burst Information
35	9	1.0	333.0	Yes	5282.8MHz, -64.0dBm	Hop sequence: 5625, 5614, 5621, 5563, 5271, 5560, 5308, 5529, 5474, 5267, 5547, 5265, 5481, 5503, 5510, 5330, 5690, 5519, 5436, 5618, 5260, 5615, 5675, 5268, 5546, 5648, 5472, 5538, 5464, 5583, 5513, 5724, 5435, 5655, 5412, 5347, 5299, 5506, 5262, 5339, 5491, 5554, 5608, 5604, 5634, 5425, 5658, 5585, 5430, 5405, 5663, 5336, 5337, 5493, 5321, 5602, 5286, 5528, 5424, 5319, 5379, 5629, 5605, 5633, 5701, 5516, 5461, 5685, 5667, 5485, 5374, 5576, 5279, 5558, 5509, 5556, 5637, 5559, 5704, 5541, 5290, 5371, 5289, 5488, 5683, 5495, 5439, 5564, 5403, 5617, 5527, 5606, 5293, 5266, 5388, 5294, 5457, 5520, 5686, 5526 (6 hits) (11/19/2012 11:52:02 AM)
36	9	1.0	333.0	Yes	5283.8MHz, -64.0dBm	Hop sequence: 5632, 5441, 5293, 5287, 5414, 5615, 5359, 5521, 5434, 5277, 5329, 5256, 5512, 5284, 5375, 5321, 5283, 5558, 5668, 5683, 5609, 5305, 5524, 5464, 5551, 5541, 5349, 5530, 5385, 5350, 5528, 5708, 5504, 5334, 5336, 5312, 5545, 5369, 5374, 5533, 5573, 5527, 5431, 5543, 5478, 5333, 5415, 5442, 5592, 5628, 5253, 5559, 5377, 5476, 5448, 5274, 5288, 5698, 5343, 5419, 5508, 5568, 5626, 5539, 5425, 5296, 5461, 5306, 5438, 5270, 5691, 5548, 5276, 5655, 5684, 5585, 5617, 5526, 5474, 5701, 5355, 5289, 5477, 5675, 5264, 5319, 5327, 5313, 5269, 5422, 5443, 5712, 5330, 5341, 5388, 5544, 5310, 5664, 5432, 5371 (9 hits) (11/19/2012 11:52:10 AM)

Table 83 - FCC frequency hopping radar (Type 6) Results CU-Acquire Low-Band						
Trial #	Pulses/ Burst	Pulse Width (us)	PRI (us)	Detected	Fr (MHz) and level (dBm)	Burst Information
37	9	1.0	333.0	Yes	5284.8MHz, -64.0dBm	Hop sequence: 5531, 5459, 5573, 5451, 5325, 5587, 5487, 5550, 5674, 5412, 5627, 5698, 5369, 5583, 5387, 5251, 5501, 5299, 5687, 5622, 5636, 5471, 5335, 5317, 5393, 5522, 5329, 5502, 5602, 5388, 5519, 5688, 5309, 5323, 5671, 5617, 5351, 5286, 5566, 5380, 5661, 5578, 5328, 5648, 5534, 5516, 5347, 5586, 5600, 5485, 5577, 5525, 5270, 5289, 5543, 5296, 5395, 5506, 5324, 5722, 5565, 5311, 5301, 5318, 5580, 5724, 5447, 5704, 5305, 5567, 5523, 5307, 5496, 5477, 5457, 5295, 5621, 5343, 5481, 5483, 5569, 5294, 5625, 5322, 5274, 5378, 5349, 5528, 5331, 5491, 5663, 5556, 5443, 5555, 5678, 5379, 5271, 5635, 5694, 5319 (5 hits) (11/19/2012 11:52:19 AM)
38	9	1.0	333.0	Yes	5285.8MHz, -64.0dBm	Hop sequence: 5356, 5452, 5345, 5277, 5604, 5407, 5649, 5576, 5671, 5542, 5531, 5645, 5441, 5635, 5579, 5385, 5281, 5326, 5667, 5663, 5703, 5712, 5280, 5318, 5489, 5528, 5525, 5585, 5274, 5637, 5616, 5537, 5393, 5266, 5694, 5372, 5454, 5598, 5655, 5271, 5670, 5455, 5414, 5673, 5456, 5701, 5518, 5460, 5500, 5443, 5626, 5374, 5428, 5286, 5710, 5254, 5668, 5621, 5617, 5294, 5367, 5275, 5420, 5432, 5479, 5386, 5644, 5517, 5470, 5593, 5688, 5704, 5256, 5562, 5654, 5674, 5447, 5338, 5491, 5382, 5687, 5310, 5419, 5643, 5524, 5267, 5498, 5471, 5648, 5485, 5261, 5364, 5320, 5540, 5606, 5581, 5341, 5476, 5722, 5532 (7 hits) (11/19/2012 11:52:26 AM)



Table 83 - FCC frequency hopping radar (Type 6) Results CU-Acquire Low-Band						
Trial #	Pulses/ Burst	Pulse Width (us)	PRI (us)	Detected	Fr (MHz) and level (dBm)	Burst Information
39	9	1.0	333.0	Yes	5286.8MHz, -64.0dBm	Hop sequence: 5333, 5382, 5444, 5559, 5418, 5683, 5572, 5257, 5426, 5397, 5447, 5694, 5403, 5594, 5558, 5646, 5317, 5441, 5570, 5612, 5270, 5434, 5379, 5455, 5488, 5635, 5586, 5517, 5561, 5429, 5696, 5385, 5412, 5705, 5571, 5482, 5671, 5550, 5315, 5647, 5309, 5532, 5493, 5684, 5306, 5316, 5489, 5341, 5477, 5378, 5335, 5480, 5528, 5353, 5342, 5399, 5519, 5510, 5675, 5312, 5719, 5295, 5628, 5440, 5360, 5520, 5495, 5584, 5454, 5338, 5449, 5284, 5377, 5300, 5363, 5355, 5592, 5411, 5589, 5717, 5369, 5710, 5458, 5265, 5401, 5350, 5615, 5722, 5327, 5645, 5486, 5362, 5548, 5372, 5450, 5463, 5272, 5640, 5275, 5695 (3 hits) (11/19/2012 11:52:34 AM)
40	9	1.0	333.0	Yes	5287.8MHz, -64.0dBm	Hop sequence: 5499, 5624, 5536, 5637, 5527, 5515, 5484, 5558, 5722, 5630, 5712, 5625, 5278, 5377, 5327, 5643, 5599, 5478, 5574, 5352, 5365, 5275, 5448, 5355, 5523, 5335, 5649, 5306, 5295, 5350, 5372, 5303, 5659, 5607, 5385, 5698, 5719, 5344, 5408, 5495, 5384, 5301, 5458, 5254, 5428, 5324, 5517, 5487, 5606, 5537, 5506, 5359, 5581, 5292, 5501, 5600, 5391, 5279, 5317, 5361, 5427, 5714, 5366, 5362, 5469, 5549, 5262, 5420, 5268, 5452, 5429, 5507, 5445, 5598, 5503, 5559, 5424, 5608, 5388, 5346, 5647, 5566, 5394, 5479, 5432, 5471, 5492, 5316, 5634, 5578, 5381, 5696, 5716, 5543, 5682, 5614, 5430, 5488, 5642, 5416 (5 hits) (11/19/2012 11:52:41 AM)

Table 83 - FCC frequency hopping radar (Type 6) Results CU-Acquire Low-Band						
Trial #	Pulses/ Burst	Pulse Width (us)	PRI (us)	Detected	Fr (MHz) and level (dBm)	Burst Information
41	9	1.0	333.0	No	5288.8MHz, -64.0dBm	Hop sequence: 5677, 5448, 5415, 5597, 5329, 5621, 5602, 5265, 5255, 5269, 5681, 5383, 5510, 5585, 5725, 5466, 5483, 5572, 5563, 5505, 5343, 5698, 5394, 5672, 5564, 5484, 5436, 5422, 5499, 5345, 5409, 5377, 5636, 5388, 5403, 5425, 5595, 5498, 5565, 5470, 5451, 5374, 5584, 5386, 5330, 5410, 5418, 5539, 5488, 5626, 5638, 5494, 5468, 5694, 5341, 5688, 5614, 5701, 5352, 5707, 5676, 5609, 5486, 5590, 5695, 5670, 5634, 5307, 5635, 5357, 5573, 5643, 5444, 5512, 5650, 5561, 5517, 5477, 5566, 5492, 5661, 5353, 5392, 5360, 5413, 5259, 5417, 5669, 5659, 5531, 5514, 5623, 5446, 5306, 5458, 5401, 5526, 5346, 5258, 5281 (1 hits) (11/19/2012 11:52:50 AM)
42	9	1.0	333.0	Yes	5289.8MHz, -64.0dBm	Hop sequence: 5618, 5553, 5598, 5339, 5507, 5662, 5419, 5404, 5652, 5297, 5580, 5353, 5609, 5602, 5611, 5268, 5597, 5401, 5658, 5632, 5643, 5352, 5500, 5675, 5546, 5698, 5434, 5273, 5670, 5396, 5664, 5593, 5265, 5650, 5535, 5513, 5503, 5270, 5521, 5429, 5679, 5668, 5287, 5627, 5592, 5511, 5700, 5526, 5574, 5606, 5491, 5694, 5633, 5403, 5341, 5607, 5516, 5483, 5461, 5251, 5301, 5499, 5266, 5277, 5666, 5321, 5387, 5473, 5455, 5428, 5719, 5288, 5418, 5407, 5530, 5641, 5408, 5260, 5667, 5295, 5646, 5717, 5391, 5484, 5672, 5691, 5644, 5726, 5375, 5443, 5417, 5683, 5555, 5621, 5383, 5422, 5290, 5379, 5377, 5637 (5 hits) (11/19/2012 11:53:02 AM)

Table 83 - FCC frequency hopping radar (Type 6) Results CU-Acquire Low-Band						
Trial #	Pulses/ Burst	Pulse Width (us)	PRI (us)	Detected	Fr (MHz) and level (dBm)	Burst Information
43	9	1.0	333.0	Yes	5290.8MHz, -64.0dBm	Hop sequence: 5359, 5672, 5664, 5650, 5588, 5545, 5612, 5406, 5288, 5499, 5279, 5276, 5662, 5415, 5540, 5609, 5559, 5602, 5578, 5267, 5446, 5348, 5344, 5358, 5293, 5368, 5667, 5269, 5675, 5461, 5268, 5697, 5479, 5532, 5435, 5339, 5595, 5306, 5382, 5584, 5655, 5688, 5715, 5521, 5721, 5686, 5455, 5258, 5501, 5703, 5345, 5616, 5485, 5408, 5629, 5670, 5285, 5682, 5418, 5312, 5445, 5372, 5723, 5489, 5593, 5598, 5478, 5302, 5277, 5586, 5469, 5320, 5462, 5651, 5334, 5384, 5390, 5676, 5506, 5576, 5611, 5468, 5305, 5537, 5444, 5621, 5526, 5556, 5263, 5504, 5370, 5680, 5705, 5278, 5476, 5615, 5466, 5644, 5474, 5517 (7 hits) (11/19/2012 11:53:09 AM)
44	9	1.0	333.0	Yes	5291.8MHz, -64.0dBm	Hop sequence: 5539, 5294, 5419, 5700, 5518, 5559, 5409, 5720, 5568, 5694, 5704, 5478, 5709, 5442, 5290, 5498, 5571, 5695, 5633, 5507, 5414, 5609, 5400, 5255, 5542, 5465, 5705, 5455, 5363, 5392, 5624, 5549, 5377, 5563, 5512, 5484, 5450, 5680, 5305, 5689, 5673, 5718, 5580, 5257, 5264, 5658, 5666, 5435, 5697, 5367, 5486, 5693, 5599, 5314, 5570, 5521, 5337, 5358, 5530, 5585, 5547, 5712, 5399, 5362, 5375, 5260, 5394, 5348, 5692, 5534, 5401, 5327, 5721, 5420, 5675, 5364, 5446, 5519, 5602, 5403, 5509, 5415, 5489, 5576, 5564, 5490, 5608, 5600, 5354, 5297, 5569, 5644, 5440, 5385, 5402, 5577, 5481, 5643, 5384, 5374 (2 hits) (11/19/2012 11:53:23 AM)

Table 83 - FCC frequency hopping radar (Type 6) Results CU-Acquire Low-Band						
Trial #	Pulses/ Burst	Pulse Width (us)	PRI (us)	Detected	Fr (MHz) and level (dBm)	Burst Information
45	9	1.0	333.0	Yes	5292.8MHz, -64.0dBm	Hop sequence: 5525, 5252, 5369, 5466, 5416, 5439, 5671, 5502, 5508, 5362, 5517, 5382, 5388, 5306, 5421, 5420, 5272, 5685, 5460, 5351, 5411, 5318, 5269, 5720, 5354, 5520, 5495, 5590, 5273, 5648, 5593, 5434, 5346, 5299, 5464, 5543, 5513, 5395, 5297, 5267, 5331, 5332, 5613, 5459, 5342, 5257, 5490, 5355, 5509, 5446, 5392, 5529, 5499, 5700, 5606, 5310, 5399, 5657, 5256, 5366, 5519, 5467, 5664, 5260, 5415, 5330, 5655, 5445, 5721, 5539, 5505, 5535, 5534, 5378, 5533, 5442, 5419, 5719, 5507, 5588, 5646, 5347, 5370, 5450, 5546, 5447, 5409, 5336, 5531, 5465, 5610, 5620, 5298, 5570, 5611, 5561, 5582, 5317, 5360, 5274 (1 hits) (11/19/2012 11:53:30 AM)
46	9	1.0	333.0	Yes	5293.8MHz, -64.0dBm	Hop sequence: 5288, 5306, 5530, 5694, 5307, 5639, 5520, 5364, 5441, 5603, 5652, 5329, 5671, 5276, 5709, 5452, 5470, 5467, 5677, 5451, 5498, 5697, 5606, 5427, 5412, 5545, 5303, 5342, 5479, 5690, 5448, 5398, 5649, 5426, 5326, 5712, 5472, 5461, 5299, 5653, 5525, 5655, 5395, 5588, 5264, 5604, 5489, 5706, 5270, 5592, 5308, 5424, 5263, 5371, 5295, 5658, 5394, 5340, 5253, 5516, 5380, 5508, 5535, 5630, 5465, 5297, 5320, 5477, 5656, 5328, 5300, 5386, 5327, 5468, 5638, 5691, 5488, 5443, 5571, 5341, 5359, 5266, 5268, 5500, 5660, 5578, 5632, 5363, 5420, 5265, 5569, 5494, 5352, 5627, 5262, 5391, 5593, 5596, 5668, 5598 (3 hits) (11/19/2012 11:53:47 AM)

WU Steady-State High Band

Table 84 - Summary of All Results - WU-Steady State High-Band				
Waveform Name	Pd (%)	Pd Required (%)	Number of Trials	Status
FCC Short Pulse Radar (Type 1)	96.7 %	60.0 %	30	PASSED
FCC Short Pulse Radar (Type 2)	100.0 %	60.0 %	30	PASSED
FCC Short Pulse Radar (Type 3)	100.0 %	60.0 %	30	PASSED
FCC Short Pulse Radar (Type 4)	100.0 %	60.0 %	30	PASSED
Aggregate of above results	99.2 %	80.0 %	120	PASSED
Long Sequence	100.0 %	80.0 %	30	PASSED
FCC frequency hopping radar (Type 6)	100.0 %	70.0 %	46	PASSED

Table 85 - FCC Short Pulse Radar (Type 1) Results WU-Steady State High-Band						
Trial #	Pulses/Burst	Pulse Width (us)	PRI (us)	Detected	Fr (MHz) and level (dBm)	Burst Information
1	18	1.0	1428.0	Yes	5563.2MHz, -62.0dBm	Single burst (11/19/2012 01:49:25 PM)
2	18	1.0	1428.0	Yes	5558.2MHz, -62.0dBm	Single burst (11/19/2012 01:49:38 PM)
3	18	1.0	1428.0	Yes	5568.2MHz, -62.0dBm	Single burst (11/19/2012 01:50:09 PM)
4	18	1.0	1428.0	Yes	5563.2MHz, -62.0dBm	Single burst (11/19/2012 01:50:17 PM)
5	18	1.0	1428.0	Yes	5558.2MHz, -62.0dBm	Single burst (11/19/2012 01:50:24 PM)
6	18	1.0	1428.0	Yes	5568.2MHz, -62.0dBm	Single burst (11/19/2012 01:50:31 PM)
7	18	1.0	1428.0	Yes	5563.2MHz, -62.0dBm	Single burst (11/19/2012 01:50:38 PM)
8	18	1.0	1428.0	Yes	5558.2MHz, -62.0dBm	Single burst (11/19/2012 01:50:45 PM)
9	18	1.0	1428.0	Yes	5568.2MHz, -62.0dBm	Single burst (11/19/2012 01:50:53 PM)
10	18	1.0	1428.0	Yes	5563.2MHz, -62.0dBm	Single burst (11/19/2012 01:51:01 PM)
11	18	1.0	1428.0	Yes	5558.2MHz, -62.0dBm	Single burst (11/19/2012 01:51:10 PM)
12	18	1.0	1428.0	Yes	5568.2MHz, -62.0dBm	Single burst (11/19/2012 01:51:18 PM)
13	18	1.0	1428.0	Yes	5563.2MHz, -62.0dBm	Single burst (11/19/2012 01:51:27 PM)
14	18	1.0	1428.0	Yes	5558.2MHz, -62.0dBm	Single burst (11/19/2012 01:51:37 PM)
15	18	1.0	1428.0	Yes	5568.2MHz, -62.0dBm	Single burst (11/19/2012 01:51:43 PM)
16	18	1.0	1428.0	No	5563.2MHz, -62.0dBm	Single burst (11/19/2012 01:51:50 PM)
17	18	1.0	1428.0	Yes	5558.2MHz, -62.0dBm	Single burst (11/19/2012 01:52:00 PM)
18	18	1.0	1428.0	Yes	5568.2MHz, -62.0dBm	Single burst (11/19/2012 01:52:16 PM)
19	18	1.0	1428.0	Yes	5563.2MHz, -62.0dBm	Single burst (11/19/2012 01:52:24 PM)

<b>Table 85 - FCC Short Pulse Radar (Type 1) Results WU-Steady State High-Band</b>						
Trial #	Pulses/ Burst	Pulse Width (us)	PRI (us)	Detected	Fr (MHz) and level (dBm)	Burst Information
20	18	1.0	1428.0	Yes	5558.2MHz, -62.0dBm	Single burst (11/19/2012 01:52:31 PM)
21	18	1.0	1428.0	Yes	5568.2MHz, -62.0dBm	Single burst (11/19/2012 01:52:39 PM)
22	18	1.0	1428.0	Yes	5563.2MHz, -62.0dBm	Single burst (11/19/2012 01:52:51 PM)
23	18	1.0	1428.0	Yes	5558.2MHz, -62.0dBm	Single burst (11/19/2012 01:53:04 PM)
24	18	1.0	1428.0	Yes	5568.2MHz, -62.0dBm	Single burst (11/19/2012 01:53:26 PM)
25	18	1.0	1428.0	Yes	5563.2MHz, -62.0dBm	Single burst (11/19/2012 01:53:37 PM)
26	18	1.0	1428.0	Yes	5558.2MHz, -62.0dBm	Single burst (11/19/2012 01:53:45 PM)
27	18	1.0	1428.0	Yes	5568.2MHz, -62.0dBm	Single burst (11/19/2012 01:53:53 PM)
28	18	1.0	1428.0	Yes	5563.2MHz, -62.0dBm	Single burst (11/19/2012 01:54:05 PM)
29	18	1.0	1428.0	Yes	5558.2MHz, -62.0dBm	Single burst (11/19/2012 01:54:30 PM)
30	18	1.0	1428.0	Yes	5568.2MHz, -62.0dBm	Single burst (11/19/2012 01:54:38 PM)

<b>Table 86 - FCC Short Pulse Radar (Type 2) Results WU-Steady State High-Band</b>						
Trial #	Pulses/ Burst	Pulse Width (us)	PRI (us)	Detected	Fr (MHz) and level (dBm)	Burst Information
1	24	3.6	216.0	Yes	5563.2MHz, -62.0dBm	Single burst (11/19/2012 01:55:35 PM)
2	27	3.4	163.0	Yes	5558.2MHz, -62.0dBm	Single burst (11/19/2012 01:55:43 PM)
3	29	2.7	203.0	Yes	5568.2MHz, -62.0dBm	Single burst (11/19/2012 01:55:51 PM)
4	29	2.5	224.0	Yes	5563.2MHz, -62.0dBm	Single burst (11/19/2012 01:55:59 PM)
5	27	3.1	169.0	Yes	5558.2MHz, -62.0dBm	Single burst (11/19/2012 01:56:07 PM)
6	25	1.5	199.0	Yes	5568.2MHz, -62.0dBm	Single burst (11/19/2012 01:56:15 PM)
7	26	4.6	191.0	Yes	5563.2MHz, -62.0dBm	Single burst (11/19/2012 01:56:22 PM)
8	23	4.6	223.0	Yes	5558.2MHz, -62.0dBm	Single burst (11/19/2012 01:56:30 PM)
9	23	3.0	155.0	Yes	5568.2MHz, -62.0dBm	Single burst (11/19/2012 01:56:38 PM)
10	27	1.8	180.0	Yes	5563.2MHz, -62.0dBm	Single burst (11/19/2012 01:56:46 PM)
11	25	2.6	172.0	Yes	5558.2MHz, -62.0dBm	Single burst (11/19/2012 01:56:54 PM)
12	25	2.8	153.0	Yes	5568.2MHz, -62.0dBm	Single burst (11/19/2012 01:57:01 PM)
13	27	1.6	228.0	Yes	5563.2MHz, -62.0dBm	Single burst (11/19/2012 01:57:12 PM)

<b>Table 86 - FCC Short Pulse Radar (Type 2) Results WU-Steady State High-Band</b>						
Trial #	Pulses/ Burst	Pulse Width (us)	PRI (us)	Detected	Fr (MHz) and level (dBm)	Burst Information
14	27	2.4	177.0	Yes	5558.2MHz, -62.0dBm	Single burst (11/19/2012 01:57:20 PM)
15	23	1.1	177.0	Yes	5568.2MHz, -62.0dBm	Single burst (11/19/2012 01:57:28 PM)
16	24	3.4	191.0	Yes	5563.2MHz, -62.0dBm	Single burst (11/19/2012 01:57:35 PM)
17	24	1.5	183.0	Yes	5558.2MHz, -62.0dBm	Single burst (11/19/2012 01:57:42 PM)
18	28	3.6	153.0	Yes	5568.2MHz, -62.0dBm	Single burst (11/19/2012 01:57:51 PM)
19	25	3.0	165.0	Yes	5563.2MHz, -62.0dBm	Single burst (11/19/2012 01:58:00 PM)
20	27	2.8	174.0	Yes	5558.2MHz, -62.0dBm	Single burst (11/19/2012 01:58:08 PM)
21	29	1.2	195.0	Yes	5568.2MHz, -62.0dBm	Single burst (11/19/2012 01:58:15 PM)
22	24	1.1	227.0	Yes	5563.2MHz, -62.0dBm	Single burst (11/19/2012 01:58:25 PM)
23	26	2.3	204.0	Yes	5558.2MHz, -62.0dBm	Single burst (11/19/2012 01:58:34 PM)
24	26	2.9	224.0	Yes	5568.2MHz, -62.0dBm	Single burst (11/19/2012 01:58:42 PM)
25	24	5.0	189.0	Yes	5563.2MHz, -62.0dBm	Single burst (11/19/2012 01:58:50 PM)
26	25	1.4	216.0	Yes	5558.2MHz, -62.0dBm	Single burst (11/19/2012 01:58:57 PM)
27	25	4.5	162.0	Yes	5568.2MHz, -62.0dBm	Single burst (11/19/2012 01:59:04 PM)
28	24	3.2	158.0	Yes	5563.2MHz, -62.0dBm	Single burst (11/19/2012 01:59:13 PM)
29	24	1.3	170.0	Yes	5558.2MHz, -62.0dBm	Single burst (11/19/2012 01:59:22 PM)
30	26	3.3	219.0	Yes	5568.2MHz, -62.0dBm	Single burst (11/19/2012 01:59:29 PM)

<b>Table 87 - FCC Short Pulse Radar (Type 3) Results WU-Steady State High-Band</b>						
Trial #	Pulses/ Burst	Pulse Width (us)	PRI (us)	Detected	Fr (MHz) and level (dBm)	Burst Information
1	16	8.9	348.0	Yes	5563.2MHz, -62.0dBm	Single burst (11/19/2012 01:59:52 PM)
2	18	7.8	279.0	Yes	5558.2MHz, -62.0dBm	Single burst (11/19/2012 01:59:59 PM)
3	17	6.8	272.0	Yes	5568.2MHz, -62.0dBm	Single burst (11/19/2012 02:00:06 PM)
4	17	7.5	313.0	Yes	5563.2MHz, -62.0dBm	Single burst (11/19/2012 02:00:17 PM)
5	18	8.8	249.0	Yes	5558.2MHz, -62.0dBm	Single burst (11/19/2012 02:00:25 PM)
6	17	9.8	298.0	Yes	5568.2MHz, -62.0dBm	Single burst (11/19/2012 02:00:32 PM)
7	17	6.3	369.0	Yes	5563.2MHz, -62.0dBm	Single burst (11/19/2012 02:00:39 PM)

<b>Table 87 - FCC Short Pulse Radar (Type 3) Results WU-Steady State High-Band</b>						
Trial #	Pulses/ Burst	Pulse Width (us)	PRI (us)	Detected	Fr (MHz) and level (dBm)	Burst Information
8	17	7.3	448.0	Yes	5558.2MHz, -62.0dBm	Single burst (11/19/2012 02:00:45 PM)
9	16	9.0	463.0	Yes	5568.2MHz, -62.0dBm	Single burst (11/19/2012 02:00:54 PM)
10	16	6.6	218.0	Yes	5563.2MHz, -62.0dBm	Single burst (11/19/2012 02:01:02 PM)
11	17	8.9	409.0	Yes	5558.2MHz, -62.0dBm	Single burst (11/19/2012 02:01:09 PM)
12	17	7.1	441.0	Yes	5568.2MHz, -62.0dBm	Single burst (11/19/2012 02:01:17 PM)
13	17	7.2	225.0	Yes	5563.2MHz, -62.0dBm	Single burst (11/19/2012 02:01:24 PM)
14	17	7.5	455.0	Yes	5558.2MHz, -62.0dBm	Single burst (11/19/2012 02:01:36 PM)
15	17	7.2	462.0	Yes	5568.2MHz, -62.0dBm	Single burst (11/19/2012 02:01:44 PM)
16	16	6.6	347.0	Yes	5563.2MHz, -62.0dBm	Single burst (11/19/2012 02:01:56 PM)
17	17	9.8	378.0	Yes	5558.2MHz, -62.0dBm	Single burst (11/19/2012 02:02:06 PM)
18	17	6.6	462.0	Yes	5568.2MHz, -62.0dBm	Single burst (11/19/2012 02:02:16 PM)
19	16	6.7	290.0	Yes	5563.2MHz, -62.0dBm	Single burst (11/19/2012 02:02:26 PM)
20	17	8.1	470.0	Yes	5558.2MHz, -62.0dBm	Single burst (11/19/2012 02:02:35 PM)
21	16	9.9	286.0	Yes	5568.2MHz, -62.0dBm	Single burst (11/19/2012 02:02:44 PM)
22	16	6.9	460.0	Yes	5563.2MHz, -62.0dBm	Single burst (11/19/2012 02:02:52 PM)
23	17	7.5	239.0	Yes	5558.2MHz, -62.0dBm	Single burst (11/19/2012 02:03:01 PM)
24	16	6.7	220.0	Yes	5568.2MHz, -62.0dBm	Single burst (11/19/2012 02:03:12 PM)
25	18	7.7	404.0	Yes	5563.2MHz, -62.0dBm	Single burst (11/19/2012 02:03:21 PM)
26	16	8.4	315.0	Yes	5558.2MHz, -62.0dBm	Single burst (11/19/2012 02:03:29 PM)
27	17	9.7	496.0	Yes	5568.2MHz, -62.0dBm	Single burst (11/19/2012 02:03:37 PM)
28	16	6.0	326.0	Yes	5563.2MHz, -62.0dBm	Single burst (11/19/2012 02:03:45 PM)
29	18	8.9	480.0	Yes	5558.2MHz, -62.0dBm	Single burst (11/19/2012 02:03:52 PM)
30	17	9.7	326.0	Yes	5568.2MHz, -62.0dBm	Single burst (11/19/2012 02:04:00 PM)

<b>Table 88 - FCC Short Pulse Radar (Type 4) Results WU-Steady State High-Band</b>						
Trial #	Pulses/ Burst	Pulse Width (us)	PRI (us)	Detected	Fr (MHz) and level (dBm)	Burst Information
1	12	19.0	244.0	Yes	5563.2MHz, -62.0dBm	Single burst (11/19/2012 02:05:34 PM)



Table 88 - FCC Short Pulse Radar (Type 4) Results WU-Steady State High-Band						
Trial #	Pulses/ Burst	Pulse Width (us)	PRI (us)	Detected	Fr (MHz) and level (dBm)	Burst Information
2	14	14.9	403.0	Yes	5558.2MHz, -62.0dBm	Single burst (11/19/2012 02:05:44 PM)
3	14	16.8	424.0	Yes	5568.2MHz, -62.0dBm	Single burst (11/19/2012 02:05:59 PM)
4	15	18.5	232.0	Yes	5563.2MHz, -62.0dBm	Single burst (11/19/2012 02:06:07 PM)
5	15	12.3	449.0	Yes	5558.2MHz, -62.0dBm	Single burst (11/19/2012 02:06:15 PM)
6	16	19.2	440.0	Yes	5568.2MHz, -62.0dBm	Single burst (11/19/2012 02:06:25 PM)
7	15	11.7	326.0	Yes	5563.2MHz, -62.0dBm	Single burst (11/19/2012 02:06:33 PM)
8	15	19.0	294.0	Yes	5558.2MHz, -62.0dBm	Single burst (11/19/2012 02:06:44 PM)
9	15	16.5	322.0	Yes	5568.2MHz, -62.0dBm	Single burst (11/19/2012 02:06:51 PM)
10	14	15.7	399.0	Yes	5563.2MHz, -62.0dBm	Single burst (11/19/2012 02:07:08 PM)
11	14	12.0	276.0	Yes	5558.2MHz, -62.0dBm	Single burst (11/19/2012 02:07:20 PM)
12	14	12.4	468.0	Yes	5568.2MHz, -62.0dBm	Single burst (11/19/2012 02:07:29 PM)
13	15	11.5	308.0	Yes	5563.2MHz, -62.0dBm	Single burst (11/19/2012 02:07:36 PM)
14	14	12.5	499.0	Yes	5558.2MHz, -62.0dBm	Single burst (11/19/2012 02:07:46 PM)
15	16	12.8	339.0	Yes	5568.2MHz, -62.0dBm	Single burst (11/19/2012 02:07:54 PM)
16	15	13.6	403.0	Yes	5563.2MHz, -62.0dBm	Single burst (11/19/2012 02:08:06 PM)
17	16	19.9	281.0	Yes	5558.2MHz, -62.0dBm	Single burst (11/19/2012 02:08:13 PM)
18	13	13.9	391.0	Yes	5568.2MHz, -62.0dBm	Single burst (11/19/2012 02:08:20 PM)
19	14	17.9	345.0	Yes	5563.2MHz, -62.0dBm	Single burst (11/19/2012 02:08:36 PM)
20	12	13.8	331.0	Yes	5558.2MHz, -62.0dBm	Single burst (11/19/2012 02:08:46 PM)
21	16	18.4	311.0	Yes	5568.2MHz, -62.0dBm	Single burst (11/19/2012 02:08:56 PM)
22	16	12.0	430.0	Yes	5563.2MHz, -62.0dBm	Single burst (11/19/2012 02:09:05 PM)
23	15	15.5	305.0	Yes	5558.2MHz, -62.0dBm	Single burst (11/19/2012 02:09:19 PM)
24	14	12.2	234.0	Yes	5568.2MHz, -62.0dBm	Single burst (11/19/2012 02:09:26 PM)
25	14	14.9	281.0	Yes	5563.2MHz, -62.0dBm	Single burst (11/19/2012 02:09:43 PM)
26	14	11.1	433.0	Yes	5558.2MHz, -62.0dBm	Single burst (11/19/2012 02:10:02 PM)
27	14	17.2	290.0	Yes	5568.2MHz, -62.0dBm	Single burst (11/19/2012 02:10:10 PM)
28	13	17.4	357.0	Yes	5563.2MHz, -62.0dBm	Single burst (11/19/2012 02:10:17 PM)

<b>Table 88 - FCC Short Pulse Radar (Type 4) Results WU-Steady State High-Band</b>						
Trial #	Pulses/ Burst	Pulse Width (us)	PRI (us)	Detected	Fr (MHz) and level (dBm)	Burst Information
29	16	17.0	275.0	Yes	5558.2MHz, -62.0dBm	Single burst (11/19/2012 02:10:30 PM)
30	12	16.4	202.0	Yes	5568.2MHz, -62.0dBm	Single burst (11/19/2012 02:10:53 PM)

<b>Table 89 - Long Sequence Waveform Summary WU-Steady State High-Band</b>		
Long Sequence Trial	Result	Radar Frequency / Amplitude
Trial #1	Detected	5563.2MHz, -62.0dBm
Trial #2	Detected	5558.2MHz, -62.0dBm
Trial #3	Detected	5568.2MHz, -62.0dBm
Trial #4	Detected	5563.2MHz, -62.0dBm
Trial #5	Detected	5558.2MHz, -62.0dBm
Trial #6	Detected	5568.2MHz, -62.0dBm
Trial #7	Detected	5563.2MHz, -62.0dBm
Trial #8	Detected	5558.2MHz, -62.0dBm
Trial #9	Detected	5568.2MHz, -62.0dBm
Trial #10	Detected	5563.2MHz, -62.0dBm
Trial #11	Detected	5558.2MHz, -62.0dBm
Trial #12	Detected	5568.2MHz, -62.0dBm
Trial #13	Detected	5563.2MHz, -62.0dBm
Trial #14	Detected	5558.2MHz, -62.0dBm
Trial #15	Detected	5568.2MHz, -62.0dBm
Trial #16	Detected	5563.2MHz, -62.0dBm
Trial #17	Detected	5558.2MHz, -62.0dBm
Trial #18	Detected	5568.2MHz, -62.0dBm
Trial #19	Detected	5563.2MHz, -62.0dBm
Trial #20	Detected	5558.2MHz, -62.0dBm
Trial #21	Detected	5568.2MHz, -62.0dBm
Trial #22	Detected	5563.2MHz, -62.0dBm

<b>Table 89 - Long Sequence Waveform Summary WU-Steady State High-Band</b>		
Long Sequence Trial	Result	Radar Frequency / Amplitude
Trial #23	Detected	5558.2MHz, -62.0dBm
Trial #24	Detected	5568.2MHz, -62.0dBm
Trial #25	Detected	5563.2MHz, -62.0dBm
Trial #26	Detected	5558.2MHz, -62.0dBm
Trial #27	Detected	5568.2MHz, -62.0dBm
Trial #28	Detected	5563.2MHz, -62.0dBm
Trial #29	Detected	5558.2MHz, -62.0dBm
Trial #30	Detected	5568.2MHz, -62.0dBm

<b>Table 90 - WU-Steady State High-Band Long Sequence Waveform Trial#1 (Detected)</b>						
Burst #	# Pulses	Pulse Width (us)	Chirp (MHz)	Interval 1 to 2 (us)	Interval 2 to 3 (us)	Start time (s)
1	1	60.4	6	-	-	0.435008
2	3	92.1	12	1617.0	1432.0	1.371255
3	1	57.8	19	-	-	1.572534
4	1	69.7	12	-	-	2.598499
5	3	50.9	14	1279.0	1190.0	3.302761
6	1	80.2	5	-	-	4.420089
7	1	51.1	17	-	-	4.557868
8	2	98.9	18	1838.0	-	5.731968
9	2	81.5	9	1439.0	-	6.721307
10	2	70.6	9	1907.0	-	6.760425
11	2	73.0	8	1305.0	-	8.184470
12	2	53.8	10	1983.0	-	8.538158
13	2	54.5	7	1452.0	-	9.108720
14	2	68.3	10	1522.0	-	10.327331
15	2	92.6	6	2000.0	-	11.150933
16	2	68.0	9	1645.0	-	11.750212

<b>Table 91 - WU-Steady State High-Band Long Sequence Waveform Trial#2 (Detected)</b>						
Burst #	# Pulses	Pulse Width (us)	Chirp (MHz)	Interval 1 to 2 (us)	Interval 2 to 3 (us)	Start time (s)
1	1	55.5	13	-	-	0.519523
2	2	84.9	16	1568.0	-	1.170365
3	1	57.2	20	-	-	1.979601
4	2	92.1	10	1547.0	-	2.879989
5	2	98.0	6	1683.0	-	3.336136
6	2	75.6	14	1658.0	-	3.916143
7	2	81.7	14	1608.0	-	5.116728
8	3	93.2	16	1850.0	1180.0	5.827362
9	3	65.7	11	1373.0	1264.0	6.396086
10	2	70.9	14	1895.0	-	6.870362
11	2	97.9	12	1433.0	-	8.092390
12	3	75.9	12	1227.0	1293.0	8.687401

<b>Table 91 - WU-Steady State High-Band Long Sequence Waveform Trial#2 (Detected)</b>						
Burst #	# Pulses	Pulse Width (us)	Chirp (MHz)	Interval 1 to 2 (us)	Interval 2 to 3 (us)	Start time (s)
13	2	68.3	11	1617.0	-	9.720588
14	3	65.2	12	1727.0	1004.0	9.778962
15	3	68.5	6	1795.0	1179.0	11.176444
16	2	70.1	18	1657.0	-	11.348165

<b>Table 92 - WU-Steady State High-Band Long Sequence Waveform Trial#3 (Detected)</b>						
Burst #	# Pulses	Pulse Width (us)	Chirp (MHz)	Interval 1 to 2 (us)	Interval 2 to 3 (us)	Start time (s)
1	3	95.1	11	1479.0	1831.0	0.659854
2	1	72.6	18	-	-	0.884737
3	3	56.3	19	1787.0	1539.0	1.495911
4	1	53.6	14	-	-	2.136306
5	2	87.4	19	1576.0	-	2.766233
6	2	89.2	11	1994.0	-	3.463831
7	2	97.1	9	1607.0	-	4.101090
8	3	75.6	8	1441.0	1488.0	5.040090
9	3	67.2	12	1538.0	1682.0	5.776023
10	3	96.6	7	1135.0	1469.0	6.278813
11	3	81.9	12	1732.0	1561.0	6.868505
12	1	86.9	8	-	-	7.588640
13	3	97.9	19	1448.0	1265.0	8.091242
14	1	72.4	11	-	-	8.673787
15	3	54.9	17	1235.0	1936.0	9.585665
16	3	92.2	5	1467.0	1015.0	10.415042
17	1	68.3	16	-	-	11.017893
18	2	59.5	11	1125.0	-	11.648099

<b>Table 93 - WU-Steady State High-Band Long Sequence Waveform Trial#4 (Detected)</b>						
Burst #	# Pulses	Pulse Width (us)	Chirp (MHz)	Interval 1 to 2 (us)	Interval 2 to 3 (us)	Start time (s)
1	2	85.0	16	1385.0	-	0.741362
2	1	51.7	7	-	-	1.148550
3	1	99.0	15	-	-	1.857003
4	2	96.4	13	1220.0	-	3.152884
5	1	72.9	6	-	-	4.018661
6	3	75.7	12	1966.0	1609.0	5.152890
7	3	72.3	19	1080.0	1223.0	6.031368
8	2	51.7	20	1588.0	-	6.631723
9	1	57.9	11	-	-	7.753163
10	1	72.0	11	-	-	8.988711
11	2	58.8	8	1452.0	-	9.494323
12	2	89.9	8	1527.0	-	10.810120
13	2	64.2	8	1303.0	-	11.738187

<b>Table 94 - WU-Steady State High-Band Long Sequence Waveform Trial#5 (Detected)</b>						
Burst #	# Pulses	Pulse Width (us)	Chirp (MHz)	Interval 1 to 2 (us)	Interval 2 to 3 (us)	Start time (s)
1	2	58.2	18	1770.0	-	0.642368
2	3	96.6	16	1261.0	1029.0	0.786004

<b>Table 94 - WU-Steady State High-Band Long Sequence Waveform Trial#5 (Detected)</b>						
Burst #	# Pulses	Pulse Width (us)	Chirp (MHz)	Interval 1 to 2 (us)	Interval 2 to 3 (us)	Start time (s)
3	2	62.1	11	1518.0	-	2.051733
4	1	91.1	7	-	-	2.173357
5	1	69.1	8	-	-	3.218338
6	2	72.3	14	1341.0	-	3.651705
7	3	91.4	8	1867.0	1646.0	4.580221
8	1	64.5	15	-	-	5.404828
9	1	74.2	9	-	-	6.267112
10	2	90.2	17	1489.0	-	6.743883
11	2	56.8	11	1966.0	-	7.516358
12	2	76.4	12	1564.0	-	7.900855
13	3	68.8	14	1142.0	1387.0	8.606310
14	2	68.4	15	1135.0	-	9.565270
15	1	52.8	12	-	-	10.296481
16	1	75.2	14	-	-	10.694225
17	3	82.3	16	1618.0	1652.0	11.888699

<b>Table 95 - WU-Steady State High-Band Long Sequence Waveform Trial#6 (Detected)</b>						
Burst #	# Pulses	Pulse Width (us)	Chirp (MHz)	Interval 1 to 2 (us)	Interval 2 to 3 (us)	Start time (s)
1	2	91.2	15	1902.0	-	0.786611
2	1	93.4	17	-	-	1.536869
3	3	89.5	6	1064.0	1497.0	2.218727
4	2	88.1	8	1226.0	-	2.963076
5	2	90.8	14	1645.0	-	4.320539
6	3	69.1	11	1240.0	1777.0	5.365609
7	2	59.7	17	1089.0	-	6.161617
8	2	62.6	16	1245.0	-	6.983714
9	2	94.8	16	1868.0	-	8.268194
10	2	84.9	9	1941.0	-	9.176450
11	1	82.1	8	-	-	9.827487
12	1	53.4	10	-	-	10.216554
13	2	72.1	14	1135.0	-	11.914901

<b>Table 96 - WU-Steady State High-Band Long Sequence Waveform Trial#7 (Detected)</b>						
Burst #	# Pulses	Pulse Width (us)	Chirp (MHz)	Interval 1 to 2 (us)	Interval 2 to 3 (us)	Start time (s)
1	2	91.4	5	1182.0	-	0.349062
2	1	70.5	8	-	-	0.708017
3	1	74.5	8	-	-	1.414162
4	2	59.8	16	1998.0	-	2.098322
5	3	87.8	6	1812.0	1774.0	3.052543
6	2	90.6	8	1389.0	-	3.434590
7	3	68.9	11	1734.0	1311.0	4.255065
8	2	79.0	8	1784.0	-	4.626743
9	2	69.1	5	1657.0	-	5.193284
10	1	88.4	9	-	-	6.023542
11	2	91.4	8	1128.0	-	6.649188
12	2	75.6	14	1977.0	-	7.305204
13	2	60.9	12	1887.0	-	7.753181
14	3	61.7	16	1372.0	1954.0	8.288187

<b>Table 96 - WU-Steady State High-Band Long Sequence Waveform Trial#7 (Detected)</b>						
Burst #	# Pulses	Pulse Width (us)	Chirp (MHz)	Interval 1 to 2 (us)	Interval 2 to 3 (us)	Start time (s)
15	2	54.8	10	1465.0	-	9.248762
16	3	57.5	9	1326.0	1870.0	9.827142
17	2	74.5	10	1199.0	-	10.280784
18	2	90.4	19	1656.0	-	11.038645
19	2	96.9	13	1259.0	-	11.538427

<b>Table 97 - WU-Steady State High-Band Long Sequence Waveform Trial#8 (Detected)</b>						
Burst #	# Pulses	Pulse Width (us)	Chirp (MHz)	Interval 1 to 2 (us)	Interval 2 to 3 (us)	Start time (s)
1	2	57.6	7	1017.0	-	0.921688
2	2	77.8	15	1020.0	-	1.887563
3	2	83.0	15	1534.0	-	3.074523
4	2	77.2	11	1826.0	-	4.124784
5	2	52.3	15	1909.0	-	4.741192
6	2	94.0	15	1060.0	-	6.015605
7	2	86.0	13	1243.0	-	7.570531
8	2	98.7	20	1871.0	-	8.229026
9	1	89.2	20	-	-	8.956410
10	2	70.8	16	1660.0	-	10.472605
11	2	73.8	14	1289.0	-	11.814798

<b>Table 98 - WU-Steady State High-Band Long Sequence Waveform Trial#9 (Detected)</b>						
Burst #	# Pulses	Pulse Width (us)	Chirp (MHz)	Interval 1 to 2 (us)	Interval 2 to 3 (us)	Start time (s)
1	2	53.8	15	1516.0	-	0.376925
2	2	75.2	16	1096.0	-	2.339733
3	2	70.6	17	1882.0	-	2.784837
4	3	68.3	19	1397.0	1082.0	4.027277
5	3	97.7	11	1396.0	1960.0	5.715680
6	2	74.3	9	1996.0	-	7.063866
7	3	52.0	11	1125.0	1736.0	9.012898
8	2	85.3	17	1328.0	-	10.546498
9	2	65.7	17	1526.0	-	10.870038

<b>Table 99 - WU-Steady State High-Band Long Sequence Waveform Trial#10 (Detected)</b>						
Burst #	# Pulses	Pulse Width (us)	Chirp (MHz)	Interval 1 to 2 (us)	Interval 2 to 3 (us)	Start time (s)
1	2	75.5	10	1630.0	-	0.561521
2	1	82.6	9	-	-	1.437727
3	2	73.6	7	1477.0	-	2.883883
4	2	81.5	8	1091.0	-	3.000298
5	1	98.3	6	-	-	4.789466
6	2	50.7	7	1599.0	-	5.338964
7	1	70.2	10	-	-	6.824817
8	1	68.2	11	-	-	7.188902
9	1	71.0	8	-	-	8.594234
10	2	98.2	18	1327.0	-	9.600953
11	1	82.5	12	-	-	10.748700
12	2	89.2	15	1198.0	-	11.063330

**Table 100 - WU-Steady State High-Band Long Sequence Waveform Trial#11 (Detected)**

Burst #	# Pulses	Pulse Width (us)	Chirp (MHz)	Interval 1 to 2 (us)	Interval 2 to 3 (us)	Start time (s)
1	3	85.3	20	1509.0	1446.0	0.277380
2	3	75.9	15	1262.0	1308.0	0.934933
3	1	99.7	14	-	-	1.307806
4	3	56.9	8	1011.0	1757.0	1.879770
5	3	87.1	18	1076.0	1855.0	2.842160
6	2	50.2	16	1547.0	-	3.296571
7	2	73.5	13	1859.0	-	3.735712
8	2	75.6	12	1013.0	-	4.626164
9	3	88.2	6	1559.0	1557.0	5.022024
10	1	64.7	8	-	-	5.518078
11	1	64.8	19	-	-	6.030974
12	2	68.1	7	1983.0	-	6.986467
13	2	97.4	10	1700.0	-	7.770070
14	1	61.6	13	-	-	8.179208
15	3	94.0	12	1847.0	1992.0	8.950084
16	2	69.0	14	1962.0	-	9.476849
17	2	88.1	12	1527.0	-	9.819024
18	2	72.2	12	1616.0	-	10.652305
19	1	86.6	18	-	-	11.214707
20	1	88.7	14	-	-	11.746426

**Table 101 - WU-Steady State High-Band Long Sequence Waveform Trial#12 (Detected)**

Burst #	# Pulses	Pulse Width (us)	Chirp (MHz)	Interval 1 to 2 (us)	Interval 2 to 3 (us)	Start time (s)
1	2	73.3	11	1171.0	-	0.706260
2	2	59.4	13	1164.0	-	1.332986
3	2	54.1	12	1684.0	-	1.993521
4	3	87.9	7	1228.0	1997.0	3.685392
5	2	85.6	5	1933.0	-	4.156250
6	2	71.3	7	1333.0	-	5.010423
7	2	96.0	11	1285.0	-	5.698973
8	1	93.3	8	-	-	7.080764
9	2	64.8	14	1153.0	-	7.777220
10	3	69.6	10	1533.0	1464.0	8.375978
11	2	59.8	9	1823.0	-	9.940617
12	1	86.1	6	-	-	10.598146
13	2	94.9	18	1259.0	-	11.647230

**Table 102 - WU-Steady State High-Band Long Sequence Waveform Trial#13 (Detected)**

Burst #	# Pulses	Pulse Width (us)	Chirp (MHz)	Interval 1 to 2 (us)	Interval 2 to 3 (us)	Start time (s)
1	2	53.3	14	1531.0	-	0.448321
2	1	82.5	7	-	-	1.047731
3	2	75.5	19	1287.0	-	2.271510
4	2	53.4	6	1974.0	-	3.389024
5	3	65.4	18	1486.0	1831.0	4.593926
6	2	84.7	12	1749.0	-	5.003044
7	1	59.6	9	-	-	6.107536
8	3	88.2	5	1558.0	1661.0	6.495677

<b>Table 102 - WU-Steady State High-Band Long Sequence Waveform Trial#13 (Detected)</b>						
Burst #	# Pulses	Pulse Width (us)	Chirp (MHz)	Interval 1 to 2 (us)	Interval 2 to 3 (us)	Start time (s)
9	2	56.1	12	1659.0	-	7.601835
10	2	86.1	7	1998.0	-	8.748915
11	1	89.3	9	-	-	10.117784
12	2	64.3	16	1733.0	-	10.663744
13	2	59.7	13	1745.0	-	11.677723

<b>Table 103 - WU-Steady State High-Band Long Sequence Waveform Trial#14 (Detected)</b>						
Burst #	# Pulses	Pulse Width (us)	Chirp (MHz)	Interval 1 to 2 (us)	Interval 2 to 3 (us)	Start time (s)
1	3	55.7	12	1393.0	1508.0	0.139955
2	3	86.8	11	1880.0	1913.0	1.464326
3	3	73.2	16	1405.0	1872.0	3.085802
4	3	81.3	15	1814.0	1115.0	3.562165
5	2	85.1	18	1081.0	-	5.071508
6	2	52.0	10	1586.0	-	5.733469
7	2	84.3	17	1467.0	-	6.929568
8	2	58.3	19	1797.0	-	8.009054
9	2	50.7	12	1136.0	-	8.873293
10	3	67.3	11	1886.0	1375.0	10.864530
11	1	60.2	16	-	-	11.082454

<b>Table 104 - WU-Steady State High-Band Long Sequence Waveform Trial#15 (Detected)</b>						
Burst #	# Pulses	Pulse Width (us)	Chirp (MHz)	Interval 1 to 2 (us)	Interval 2 to 3 (us)	Start time (s)
1	1	84.4	7	-	-	0.450248
2	2	69.7	16	1721.0	-	1.255381
3	2	93.8	6	1306.0	-	1.363286
4	3	53.2	17	1010.0	1662.0	2.557144
5	3	68.9	13	1599.0	1885.0	3.249985
6	2	82.1	12	1268.0	-	3.899523
7	3	78.8	8	1774.0	1447.0	4.605801
8	1	97.0	13	-	-	5.278449
9	2	66.1	13	1298.0	-	5.858941
10	3	81.3	18	1121.0	1777.0	6.424470
11	2	53.6	20	1766.0	-	6.780156
12	2	71.7	8	1226.0	-	7.558948
13	3	82.6	6	1982.0	1088.0	8.336881
14	3	75.8	7	1638.0	1022.0	8.973664
15	2	69.3	11	1120.0	-	9.877624
16	2	74.6	20	1272.0	-	10.117608
17	3	53.2	18	1141.0	1723.0	11.090467
18	2	88.9	14	1980.0	-	11.967610

<b>Table 105 - WU-Steady State High-Band Long Sequence Waveform Trial#16 (Detected)</b>						
Burst #	# Pulses	Pulse Width (us)	Chirp (MHz)	Interval 1 to 2 (us)	Interval 2 to 3 (us)	Start time (s)
1	1	79.6	10	-	-	0.521018
2	2	85.6	6	1603.0	-	1.014059
3	2	69.3	17	1258.0	-	1.866427



<b>Table 105 - WU-Steady State High-Band Long Sequence Waveform Trial#16 (Detected)</b>						
Burst #	# Pulses	Pulse Width (us)	Chirp (MHz)	Interval 1 to 2 (us)	Interval 2 to 3 (us)	Start time (s)
4	1	54.4	20	-	-	2.447911
5	3	54.1	9	1501.0	1453.0	2.691964
6	2	60.8	19	1010.0	-	3.515957
7	1	86.8	18	-	-	4.020257
8	3	70.9	11	1741.0	1845.0	5.046876
9	2	79.2	14	1522.0	-	5.097566
10	2	65.1	15	1741.0	-	6.010189
11	2	82.8	9	1974.0	-	6.458578
12	2	98.5	7	1004.0	-	7.106566
13	2	69.8	10	1797.0	-	7.818612
14	3	71.1	12	1437.0	1922.0	8.241337
15	2	84.6	16	1392.0	-	9.461412
16	2	66.2	13	1153.0	-	9.934453
17	2	59.0	9	1688.0	-	10.251269
18	1	86.3	10	-	-	11.312167
19	2	79.6	19	1479.0	-	11.374690

<b>Table 106 - WU-Steady State High-Band Long Sequence Waveform Trial#17 (Detected)</b>						
Burst #	# Pulses	Pulse Width (us)	Chirp (MHz)	Interval 1 to 2 (us)	Interval 2 to 3 (us)	Start time (s)
1	2	67.6	16	1958.0	-	0.205229
2	2	75.8	19	1471.0	-	1.367269
3	1	50.7	8	-	-	2.221280
4	2	58.2	19	1666.0	-	3.444615
5	2	69.3	13	1796.0	-	3.998840
6	2	82.4	10	1821.0	-	5.205578
7	2	72.1	19	1664.0	-	6.272527
8	3	79.1	13	1552.0	1356.0	7.368866
9	2	50.6	13	1270.0	-	7.659249
10	1	86.6	7	-	-	8.861664
11	3	84.7	13	1623.0	1438.0	9.939809
12	3	84.1	12	1418.0	1530.0	10.174654
13	1	50.3	17	-	-	11.457158

<b>Table 107 - WU-Steady State High-Band Long Sequence Waveform Trial#18 (Detected)</b>						
Burst #	# Pulses	Pulse Width (us)	Chirp (MHz)	Interval 1 to 2 (us)	Interval 2 to 3 (us)	Start time (s)
1	1	59.1	7	-	-	1.245497
2	1	52.3	13	-	-	1.989993
3	1	87.2	19	-	-	3.914338
4	3	64.2	8	1538.0	1761.0	5.340851
5	2	80.1	10	1642.0	-	6.183251
6	2	78.7	19	1737.0	-	7.951037
7	2	52.4	9	1854.0	-	9.317331
8	3	59.1	5	1347.0	1381.0	10.600131

<b>Table 108 - WU-Steady State High-Band Long Sequence Waveform Trial#19 (Detected)</b>						
Burst #	# Pulses	Pulse Width (us)	Chirp (MHz)	Interval 1 to 2 (us)	Interval 2 to 3 (us)	Start time (s)

<b>Table 108 - WU-Steady State High-Band Long Sequence Waveform Trial#19 (Detected)</b>						
Burst #	# Pulses	Pulse Width (us)	Chirp (MHz)	Interval 1 to 2 (us)	Interval 2 to 3 (us)	Start time (s)
1	3	95.2	15	1895.0	1268.0	0.875169
2	3	93.5	16	1118.0	1102.0	1.328769
3	1	66.1	11	-	-	2.559037
4	2	54.8	7	1346.0	-	3.103541
5	2	59.7	19	1848.0	-	3.886312
6	2	98.7	15	1227.0	-	5.326932
7	2	88.7	12	1959.0	-	5.612042
8	2	83.5	7	1767.0	-	6.526629
9	2	61.0	13	1013.0	-	8.103707
10	3	89.5	16	1329.0	1165.0	8.571453
11	1	60.6	12	-	-	9.881631
12	1	94.6	13	-	-	10.687260
13	2	74.6	16	1521.0	-	11.427664

<b>Table 109 - WU-Steady State High-Band Long Sequence Waveform Trial#20 (Detected)</b>						
Burst #	# Pulses	Pulse Width (us)	Chirp (MHz)	Interval 1 to 2 (us)	Interval 2 to 3 (us)	Start time (s)
1	1	51.6	16	-	-	0.169663
2	3	70.4	11	1826.0	1791.0	1.013638
3	2	81.7	7	1063.0	-	1.667698
4	3	70.1	11	1492.0	1887.0	2.168810
5	2	92.8	6	1223.0	-	3.212947
6	2	50.9	13	1832.0	-	3.926620
7	1	50.9	14	-	-	4.539345
8	1	91.6	12	-	-	4.989267
9	2	86.5	17	1830.0	-	5.714980
10	2	95.1	5	1548.0	-	6.451310
11	1	99.1	20	-	-	7.041950
12	1	97.5	20	-	-	7.853522
13	2	78.0	10	1056.0	-	8.290332
14	2	76.2	14	1655.0	-	8.671225
15	1	78.4	11	-	-	9.926830
16	3	72.8	12	1931.0	1565.0	10.641139
17	2	87.2	10	1913.0	-	11.297532
18	2	70.9	7	1136.0	-	11.805231

<b>Table 110 - WU-Steady State High-Band Long Sequence Waveform Trial#21 (Detected)</b>						
Burst #	# Pulses	Pulse Width (us)	Chirp (MHz)	Interval 1 to 2 (us)	Interval 2 to 3 (us)	Start time (s)
1	3	50.5	9	1419.0	1243.0	1.324135
2	2	60.6	8	1659.0	-	2.540514
3	1	55.9	10	-	-	3.885015
4	2	69.2	7	1481.0	-	4.678462
5	2	81.2	8	1405.0	-	5.969741
6	2	86.7	16	1686.0	-	7.106603
7	2	95.7	10	1711.0	-	9.042390
8	2	94.3	16	1002.0	-	9.794045
9	2	79.7	13	1382.0	-	10.712832

Burst #	# Pulses	Pulse Width (us)	Chirp (MHz)	Interval 1 to 2 (us)	Interval 2 to 3 (us)	Start time (s)
1	2	62.3	17	1506.0	-	0.621487
2	2	96.6	8	1851.0	-	2.585176
3	2	89.6	18	1250.0	-	3.360940
4	3	99.9	17	1391.0	1483.0	5.054392
5	2	74.5	14	1268.0	-	7.411948
6	2	78.2	10	1662.0	-	8.067551
7	3	54.8	7	1391.0	1746.0	10.359098
8	2	70.2	10	1895.0	-	11.889350

Burst #	# Pulses	Pulse Width (us)	Chirp (MHz)	Interval 1 to 2 (us)	Interval 2 to 3 (us)	Start time (s)
1	2	83.0	15	1696.0	-	0.061862
2	1	91.1	14	-	-	0.839195
3	2	77.7	12	1273.0	-	1.572051
4	2	64.6	16	1978.0	-	2.169992
5	2	87.9	8	1044.0	-	2.934157
6	2	79.4	19	1244.0	-	3.725518
7	2	73.6	8	1164.0	-	4.037212
8	1	99.4	8	-	-	4.980194
9	2	68.3	16	1699.0	-	5.338822
10	2	60.6	7	1978.0	-	6.308109
11	2	83.0	7	1483.0	-	6.625184
12	3	90.8	19	1210.0	1203.0	7.476348
13	2	59.2	7	1963.0	-	7.767841
14	2	87.6	19	1181.0	-	8.386142
15	2	58.6	9	1026.0	-	9.289186
16	2	80.9	15	1381.0	-	9.758439
17	3	63.8	8	1102.0	1992.0	10.589635
18	2	55.4	10	1250.0	-	10.821561
19	2	79.7	17	1360.0	-	11.733670

Burst #	# Pulses	Pulse Width (us)	Chirp (MHz)	Interval 1 to 2 (us)	Interval 2 to 3 (us)	Start time (s)
1	1	53.3	7	-	-	0.358319
2	2	50.1	11	1233.0	-	1.158620
3	1	68.3	14	-	-	1.529440
4	2	59.6	6	1997.0	-	2.626272
5	3	58.9	16	1995.0	1164.0	3.038644
6	2	74.3	12	1274.0	-	3.557445
7	1	56.5	8	-	-	4.447314
8	2	97.0	6	1114.0	-	5.255147
9	3	81.6	11	1871.0	1884.0	5.880920
10	1	66.0	12	-	-	6.552746
11	2	90.2	7	1423.0	-	6.857373
12	2	62.3	8	1934.0	-	7.511704
13	2	92.4	13	1789.0	-	8.591423
14	2	58.4	15	1042.0	-	8.752534
15	2	65.4	14	1666.0	-	9.511612

<b>Table 113 - WU-Steady State High-Band Long Sequence Waveform Trial#24 (Detected)</b>						
Burst #	# Pulses	Pulse Width (us)	Chirp (MHz)	Interval 1 to 2 (us)	Interval 2 to 3 (us)	Start time (s)
16	1	92.9	15	-	-	10.297079
17	3	98.5	9	1327.0	1287.0	11.257126
18	2	62.8	16	1044.0	-	11.930018

<b>Table 114 - WU-Steady State High-Band Long Sequence Waveform Trial#25 (Detected)</b>						
Burst #	# Pulses	Pulse Width (us)	Chirp (MHz)	Interval 1 to 2 (us)	Interval 2 to 3 (us)	Start time (s)
1	1	51.6	15	-	-	0.447937
2	1	54.5	6	-	-	0.952356
3	2	57.4	8	1249.0	-	1.620423
4	3	94.5	11	1239.0	1613.0	2.935790
5	2	56.7	9	1954.0	-	3.589560
6	2	67.2	15	1706.0	-	4.188143
7	2	61.5	15	1379.0	-	5.219569
8	1	53.5	14	-	-	5.628815
9	2	52.3	11	1647.0	-	6.411555
10	1	98.2	18	-	-	7.513933
11	3	51.3	13	1095.0	1795.0	8.644515
12	3	64.4	13	1329.0	1318.0	9.151443
13	2	80.5	6	1320.0	-	10.131985
14	1	85.3	8	-	-	10.796508
15	3	87.9	6	1245.0	1433.0	11.364792

<b>Table 115 - WU-Steady State High-Band Long Sequence Waveform Trial#26 (Detected)</b>						
Burst #	# Pulses	Pulse Width (us)	Chirp (MHz)	Interval 1 to 2 (us)	Interval 2 to 3 (us)	Start time (s)
1	2	78.2	11	1648.0	-	0.460802
2	3	79.7	11	1555.0	1755.0	0.656476
3	3	80.3	10	1770.0	1455.0	1.594004
4	1	74.7	8	-	-	2.451817
5	3	70.1	8	1011.0	1898.0	2.804222
6	3	86.5	19	1575.0	1543.0	3.163409
7	2	99.0	10	1986.0	-	4.337797
8	2	61.4	10	1770.0	-	4.862392
9	2	94.7	12	1198.0	-	5.357461
10	2	55.2	19	1911.0	-	5.954225
11	3	52.5	19	1213.0	1454.0	6.845165
12	1	78.2	10	-	-	7.187631
13	3	50.5	16	1288.0	1643.0	7.922047
14	1	82.5	14	-	-	8.401780
15	2	74.2	7	1094.0	-	9.367686
16	3	89.5	16	1957.0	1078.0	9.625333
17	2	78.9	8	1852.0	-	10.140863
18	2	83.9	6	1303.0	-	11.217366
19	2	98.4	10	1634.0	-	11.981436

<b>Table 116 - WU-Steady State High-Band Long Sequence Waveform Trial#27 (Detected)</b>						
Burst #	# Pulses	Pulse Width (us)	Chirp (MHz)	Interval 1 to 2 (us)	Interval 2 to 3 (us)	Start time (s)

Burst #	# Pulses	Pulse Width (us)	Chirp (MHz)	Interval 1 to 2 (us)	Interval 2 to 3 (us)	Start time (s)
1	1	95.3	9	-	-	1.272569
2	2	88.9	18	1336.0	-	2.240534
3	1	97.7	6	-	-	4.065714
4	2	93.3	18	1110.0	-	4.903131
5	2	57.8	20	1404.0	-	6.753272
6	2	76.3	12	1748.0	-	8.403264
7	2	91.5	15	1190.0	-	9.078013
8	1	95.5	10	-	-	10.531732

Burst #	# Pulses	Pulse Width (us)	Chirp (MHz)	Interval 1 to 2 (us)	Interval 2 to 3 (us)	Start time (s)
1	1	94.8	6	-	-	0.622884
2	1	93.5	11	-	-	0.750720
3	3	78.8	19	1819.0	1686.0	1.431682
4	1	81.2	9	-	-	1.911302
5	1	97.2	18	-	-	2.684443
6	2	57.5	20	1339.0	-	3.711895
7	2	67.2	15	1738.0	-	4.402708
8	2	87.3	19	1373.0	-	4.553306
9	2	57.2	12	1493.0	-	5.431191
10	1	88.9	9	-	-	5.961677
11	1	99.4	6	-	-	6.749635
12	2	72.0	11	1183.0	-	7.182241
13	2	74.9	10	1418.0	-	8.061028
14	2	69.6	7	1446.0	-	8.779313
15	3	79.3	14	1674.0	1990.0	8.973432
16	2	65.6	6	1780.0	-	9.909752
17	3	93.9	9	1455.0	1265.0	10.279117
18	2	95.5	8	1037.0	-	11.182946
19	3	65.6	18	1610.0	1156.0	11.399379

Burst #	# Pulses	Pulse Width (us)	Chirp (MHz)	Interval 1 to 2 (us)	Interval 2 to 3 (us)	Start time (s)
1	1	96.2	15	-	-	0.181900
2	1	55.7	16	-	-	1.158182
3	3	71.8	17	1614.0	1895.0	1.842243
4	3	66.9	10	1041.0	1586.0	2.993124
5	2	80.2	14	1659.0	-	3.622249
6	1	51.2	7	-	-	4.572278
7	3	84.5	10	1055.0	1741.0	5.570413
8	2	97.8	20	1819.0	-	6.122968
9	3	85.7	12	1628.0	1158.0	6.601206
10	2	85.5	17	1840.0	-	7.493765
11	1	51.2	7	-	-	8.319781
12	3	98.2	19	1323.0	1308.0	9.036059
13	2	78.7	6	1573.0	-	10.061250
14	3	50.2	5	1340.0	1348.0	10.651832
15	1	85.7	17	-	-	11.297609

<b>Table 119 - WU-Steady State High-Band Long Sequence Waveform Trial#30 (Detected)</b>						
Burst #	# Pulses	Pulse Width (us)	Chirp (MHz)	Interval 1 to 2 (us)	Interval 2 to 3 (us)	Start time (s)
1	3	59.3	20	1834.0	1221.0	0.158372
2	2	52.3	12	1297.0	-	0.855100
3	3	73.9	14	1027.0	1179.0	2.003046
4	1	51.5	12	-	-	2.449879
5	2	89.4	15	1222.0	-	3.462510
6	3	77.0	8	1337.0	1484.0	4.599791
7	3	51.8	9	1921.0	1968.0	4.944478
8	3	59.3	14	1341.0	1957.0	6.206280
9	1	83.3	13	-	-	7.151532
10	3	62.3	9	1515.0	1825.0	7.649665
11	3	91.3	7	1200.0	1849.0	8.573394
12	2	66.9	6	1135.0	-	9.206514
13	1	68.8	12	-	-	9.752125
14	3	80.8	6	1988.0	1096.0	11.078536
15	3	96.4	11	1682.0	1433.0	11.990501

<b>Table 120 - FCC frequency hopping radar (Type 6) Results WU-Steady State High-Band</b>						
Trial #	Pulses/Burst	Pulse Width (us)	PRI (us)	Detected	Fr (MHz) and level (dBm)	Burst Information
1	9	1.0	333.0	Yes	5573.2MHz, -62.0dBm	Hop sequence: 5714, 5371, 5377, 5515, 5297, 5516, 5344, 5423, 5322, 5699, 5451, 5326, 5514, 5651, 5365, 5619, 5502, 5556, 5449, 5443, 5723, 5652, 5358, 5345, 5628, 5411, 5471, 5513, 5340, 5417, 5290, 5269, 5683, 5277, 5432, 5250, 5527, 5349, 5684, 5540, 5638, 5278, 5460, 5251, 5294, 5264, 5444, 5593, 5291, 5386, 5288, 5719, 5494, 5670, 5337, 5650, 5324, 5505, 5533, 5532, 5336, 5370, 5709, 5504, 5673, 5523, 5611, 5581, 5428, 5361, 5257, 5661, 5561, 5373, 5544, 5455, 5667, 5466, 5315, 5375, 5448, 5696, 5644, 5372, 5512, 5480, 5351, 5317, 5279, 5489, 5389, 5295, 5548, 5519, 5328, 5306, 5710, 5390, 5366, 5617 (2 hits) (11/19/2012 02:24:18 PM)

Table 120 - FCC frequency hopping radar (Type 6) Results WU-Steady State High-Band						
Trial #	Pulses/ Burst	Pulse Width (us)	PRI (us)	Detected	Fr (MHz) and level (dBm)	Burst Information
2	9	1.0	333.0	Yes	5574.2MHz, -62.0dBm	Hop sequence: 5638, 5511, 5345, 5253, 5283, 5580, 5565, 5582, 5348, 5655, 5685, 5524, 5720, 5521, 5444, 5307, 5449, 5296, 5332, 5255, 5251, 5623, 5292, 5586, 5346, 5299, 5632, 5466, 5589, 5427, 5282, 5440, 5596, 5564, 5694, 5691, 5598, 5577, 5417, 5726, 5706, 5432, 5408, 5600, 5676, 5322, 5458, 5570, 5515, 5391, 5664, 5257, 5701, 5357, 5560, 5406, 5517, 5606, 5531, 5660, 5657, 5525, 5389, 5541, 5646, 5433, 5446, 5519, 5710, 5473, 5522, 5254, 5505, 5530, 5608, 5351, 5617, 5682, 5616, 5707, 5481, 5656, 5549, 5621, 5585, 5533, 5629, 5697, 5484, 5436, 5611, 5693, 5385, 5687, 5460, 5321, 5438, 5467, 5545, 5507 (4 hits) (11/19/2012 02:24:32 PM)
3	9	1.0	333.0	Yes	5552.2MHz, -62.0dBm	Hop sequence: 5452, 5598, 5713, 5486, 5443, 5395, 5648, 5721, 5283, 5707, 5387, 5589, 5498, 5313, 5576, 5430, 5539, 5716, 5392, 5417, 5433, 5276, 5654, 5354, 5594, 5346, 5301, 5420, 5614, 5651, 5507, 5461, 5374, 5538, 5446, 5310, 5609, 5551, 5285, 5385, 5616, 5270, 5696, 5630, 5345, 5327, 5481, 5449, 5673, 5505, 5671, 5606, 5426, 5415, 5294, 5390, 5663, 5489, 5628, 5259, 5625, 5336, 5499, 5665, 5527, 5474, 5299, 5463, 5414, 5675, 5316, 5317, 5531, 5644, 5425, 5445, 5685, 5401, 5435, 5642, 5536, 5650, 5615, 5722, 5413, 5645, 5530, 5482, 5511, 5591, 5318, 5350, 5632, 5692, 5451, 5624, 5528, 5669, 5309, 5555 (1 hits) (11/19/2012 02:24:42 PM)

Table 120 - FCC frequency hopping radar (Type 6) Results WU-Steady State High-Band						
Trial #	Pulses/ Burst	Pulse Width (us)	PRI (us)	Detected	Fr (MHz) and level (dBm)	Burst Information
4	9	1.0	333.0	Yes	5553.2MHz, -62.0dBm	Hop sequence: 5510, 5525, 5427, 5632, 5649, 5551, 5274, 5599, 5633, 5480, 5553, 5664, 5609, 5366, 5295, 5671, 5464, 5518, 5648, 5308, 5592, 5403, 5306, 5660, 5620, 5279, 5261, 5629, 5481, 5578, 5283, 5497, 5297, 5517, 5255, 5583, 5485, 5409, 5330, 5462, 5471, 5598, 5452, 5286, 5572, 5722, 5260, 5379, 5437, 5285, 5589, 5484, 5641, 5715, 5322, 5405, 5536, 5656, 5502, 5707, 5612, 5317, 5360, 5552, 5298, 5680, 5457, 5616, 5407, 5348, 5333, 5523, 5703, 5547, 5469, 5495, 5568, 5474, 5692, 5618, 5539, 5606, 5507, 5705, 5365, 5670, 5445, 5617, 5399, 5376, 5573, 5436, 5574, 5309, 5466, 5567, 5451, 5503, 5546, 5644 (6 hits) (11/19/2012 02:24:54 PM)
5	9	1.0	333.0	Yes	5554.2MHz, -62.0dBm	Hop sequence: 5547, 5652, 5510, 5604, 5617, 5552, 5501, 5328, 5410, 5646, 5545, 5634, 5303, 5550, 5289, 5417, 5449, 5253, 5381, 5464, 5579, 5386, 5450, 5622, 5368, 5606, 5659, 5276, 5549, 5439, 5485, 5428, 5624, 5435, 5387, 5306, 5605, 5526, 5352, 5262, 5649, 5443, 5554, 5420, 5334, 5661, 5357, 5296, 5557, 5255, 5277, 5456, 5599, 5256, 5600, 5699, 5316, 5254, 5609, 5440, 5344, 5372, 5314, 5446, 5503, 5529, 5482, 5691, 5717, 5320, 5685, 5402, 5302, 5574, 5493, 5455, 5286, 5462, 5541, 5324, 5288, 5509, 5373, 5568, 5623, 5668, 5594, 5434, 5628, 5486, 5399, 5551, 5406, 5335, 5571, 5475, 5722, 5700, 5376, 5315 (5 hits) (11/19/2012 02:25:04 PM)



<b>Table 120 - FCC frequency hopping radar (Type 6) Results WU-Steady State High-Band</b>						
Trial #	Pulses/ Burst	Pulse Width (us)	PRI (us)	Detected	Fr (MHz) and level (dBm)	Burst Information
6	9	1.0	333.0	Yes	5555.2MHz, -62.0dBm	Hop sequence: 5322, 5415, 5710, 5437, 5608, 5604, 5665, 5365, 5574, 5364, 5428, 5478, 5568, 5573, 5313, 5272, 5456, 5383, 5485, 5624, 5629, 5261, 5357, 5722, 5610, 5708, 5536, 5457, 5441, 5290, 5588, 5507, 5429, 5525, 5628, 5496, 5556, 5264, 5716, 5367, 5645, 5445, 5431, 5625, 5659, 5312, 5630, 5368, 5547, 5464, 5348, 5418, 5721, 5620, 5623, 5667, 5621, 5503, 5442, 5318, 5262, 5653, 5387, 5670, 5447, 5538, 5616, 5490, 5405, 5333, 5566, 5539, 5516, 5353, 5309, 5311, 5725, 5583, 5688, 5703, 5292, 5724, 5397, 5356, 5254, 5417, 5396, 5334, 5593, 5650, 5462, 5517, 5327, 5720, 5487, 5681, 5461, 5597, 5308, 5602 (5 hits) (11/19/2012 02:25:12 PM)
7	9	1.0	333.0	Yes	5556.2MHz, -62.0dBm	Hop sequence: 5608, 5721, 5626, 5322, 5566, 5598, 5573, 5425, 5713, 5423, 5681, 5511, 5502, 5710, 5694, 5668, 5357, 5345, 5479, 5308, 5254, 5545, 5272, 5649, 5267, 5600, 5444, 5374, 5346, 5659, 5335, 5445, 5433, 5434, 5630, 5260, 5307, 5402, 5567, 5588, 5647, 5717, 5422, 5250, 5436, 5643, 5331, 5671, 5674, 5692, 5368, 5607, 5437, 5625, 5718, 5555, 5289, 5535, 5409, 5382, 5561, 5569, 5540, 5605, 5463, 5438, 5421, 5622, 5410, 5623, 5646, 5601, 5593, 5519, 5708, 5279, 5321, 5488, 5349, 5292, 5678, 5380, 5549, 5386, 5662, 5562, 5482, 5404, 5578, 5283, 5405, 5336, 5496, 5504, 5558, 5376, 5298, 5418, 5534, 5432 (8 hits) (11/19/2012 02:25:21 PM)

<b>Table 120 - FCC frequency hopping radar (Type 6) Results WU-Steady State High-Band</b>						
Trial #	Pulses/ Burst	Pulse Width (us)	PRI (us)	Detected	Fr (MHz) and level (dBm)	Burst Information
8	9	1.0	333.0	Yes	5557.2MHz, -62.0dBm	Hop sequence: 5715, 5315, 5285, 5550, 5352, 5724, 5404, 5308, 5518, 5366, 5268, 5328, 5306, 5565, 5284, 5570, 5416, 5723, 5483, 5414, 5642, 5339, 5313, 5291, 5253, 5293, 5499, 5496, 5461, 5614, 5460, 5481, 5292, 5609, 5540, 5613, 5436, 5627, 5304, 5418, 5604, 5345, 5443, 5709, 5394, 5722, 5672, 5332, 5489, 5467, 5680, 5287, 5529, 5679, 5554, 5678, 5677, 5690, 5318, 5575, 5713, 5646, 5380, 5433, 5260, 5563, 5611, 5437, 5326, 5681, 5435, 5583, 5438, 5586, 5336, 5566, 5453, 5333, 5705, 5559, 5465, 5434, 5472, 5699, 5628, 5657, 5264, 5693, 5501, 5551, 5476, 5464, 5381, 5516, 5324, 5633, 5444, 5300, 5449, 5358 (6 hits) (11/19/2012 02:25:28 PM)
9	9	1.0	333.0	Yes	5558.2MHz, -62.0dBm	Hop sequence: 5296, 5697, 5421, 5590, 5626, 5522, 5287, 5267, 5266, 5426, 5262, 5579, 5355, 5382, 5259, 5723, 5614, 5560, 5385, 5339, 5289, 5571, 5251, 5272, 5329, 5428, 5712, 5510, 5258, 5570, 5605, 5629, 5661, 5572, 5658, 5584, 5268, 5288, 5480, 5524, 5438, 5512, 5651, 5353, 5345, 5433, 5514, 5650, 5315, 5410, 5693, 5707, 5449, 5386, 5504, 5435, 5559, 5324, 5553, 5374, 5300, 5444, 5491, 5294, 5695, 5336, 5408, 5613, 5630, 5279, 5250, 5721, 5701, 5687, 5581, 5337, 5569, 5281, 5641, 5282, 5643, 5548, 5691, 5509, 5655, 5354, 5592, 5604, 5648, 5368, 5668, 5505, 5482, 5718, 5351, 5705, 5612, 5265, 5270, 5597 (7 hits) (11/19/2012 02:25:39 PM)

Table 120 - FCC frequency hopping radar (Type 6) Results WU-Steady State High-Band						
Trial #	Pulses/ Burst	Pulse Width (us)	PRI (us)	Detected	Fr (MHz) and level (dBm)	Burst Information
10	9	1.0	333.0	Yes	5559.2MHz, -62.0dBm	Hop sequence: 5600, 5331, 5687, 5264, 5298, 5413, 5591, 5678, 5441, 5423, 5686, 5636, 5405, 5455, 5581, 5416, 5428, 5624, 5502, 5267, 5449, 5404, 5271, 5489, 5336, 5611, 5439, 5384, 5283, 5327, 5569, 5400, 5650, 5306, 5671, 5372, 5348, 5391, 5554, 5355, 5512, 5597, 5507, 5558, 5409, 5447, 5312, 5643, 5453, 5652, 5461, 5259, 5390, 5403, 5683, 5696, 5466, 5388, 5586, 5677, 5364, 5714, 5330, 5251, 5682, 5275, 5684, 5709, 5305, 5486, 5711, 5717, 5286, 5664, 5316, 5500, 5346, 5539, 5550, 5425, 5351, 5531, 5350, 5399, 5570, 5618, 5309, 5534, 5296, 5277, 5269, 5540, 5584, 5392, 5555, 5440, 5326, 5254, 5474, 5637 (5 hits) (11/19/2012 02:25:46 PM)
11	9	1.0	333.0	Yes	5560.2MHz, -62.0dBm	Hop sequence: 5273, 5575, 5495, 5388, 5568, 5453, 5608, 5554, 5462, 5710, 5500, 5691, 5496, 5400, 5490, 5285, 5286, 5653, 5492, 5565, 5599, 5561, 5278, 5628, 5557, 5579, 5583, 5512, 5641, 5537, 5319, 5605, 5669, 5502, 5586, 5360, 5509, 5709, 5351, 5403, 5477, 5358, 5539, 5357, 5363, 5503, 5337, 5378, 5637, 5381, 5391, 5553, 5570, 5479, 5686, 5602, 5288, 5393, 5419, 5640, 5313, 5399, 5259, 5591, 5423, 5335, 5473, 5417, 5339, 5667, 5328, 5654, 5471, 5524, 5705, 5398, 5258, 5440, 5485, 5350, 5578, 5275, 5573, 5649, 5660, 5295, 5681, 5717, 5261, 5299, 5618, 5558, 5646, 5460, 5540, 5712, 5269, 5516, 5307, 5425 (9 hits) (11/19/2012 02:25:55 PM)

<b>Table 120 - FCC frequency hopping radar (Type 6) Results WU-Steady State High-Band</b>						
Trial #	Pulses/ Burst	Pulse Width (us)	PRI (us)	Detected	Fr (MHz) and level (dBm)	Burst Information
12	9	1.0	333.0	Yes	5561.2MHz, -62.0dBm	Hop sequence: 5717, 5658, 5366, 5480, 5688, 5378, 5340, 5609, 5454, 5364, 5615, 5323, 5444, 5395, 5635, 5637, 5258, 5682, 5265, 5401, 5716, 5528, 5543, 5505, 5425, 5371, 5407, 5293, 5475, 5490, 5319, 5442, 5624, 5639, 5657, 5287, 5592, 5614, 5448, 5356, 5284, 5724, 5668, 5449, 5704, 5522, 5585, 5552, 5260, 5529, 5487, 5544, 5333, 5305, 5259, 5321, 5575, 5698, 5669, 5582, 5617, 5506, 5271, 5415, 5588, 5621, 5368, 5335, 5501, 5499, 5530, 5484, 5283, 5569, 5373, 5313, 5610, 5715, 5642, 5479, 5554, 5339, 5612, 5459, 5456, 5640, 5523, 5549, 5661, 5590, 5440, 5461, 5304, 5409, 5418, 5517, 5390, 5256, 5483, 5467 (2 hits) (11/19/2012 02:26:02 PM)
13	9	1.0	333.0	Yes	5562.2MHz, -62.0dBm	Hop sequence: 5702, 5324, 5278, 5284, 5680, 5531, 5530, 5502, 5589, 5331, 5302, 5622, 5442, 5319, 5625, 5296, 5322, 5465, 5367, 5562, 5629, 5463, 5557, 5395, 5574, 5451, 5628, 5644, 5570, 5678, 5424, 5565, 5559, 5316, 5295, 5396, 5593, 5403, 5602, 5493, 5277, 5283, 5380, 5469, 5642, 5456, 5572, 5264, 5549, 5317, 5588, 5382, 5610, 5261, 5455, 5364, 5474, 5679, 5583, 5560, 5637, 5342, 5259, 5327, 5459, 5499, 5479, 5556, 5663, 5311, 5529, 5423, 5288, 5489, 5648, 5666, 5505, 5662, 5709, 5639, 5446, 5406, 5597, 5706, 5466, 5604, 5612, 5645, 5432, 5667, 5523, 5669, 5561, 5600, 5409, 5595, 5704, 5634, 5575, 5279 (10 hits) (11/19/2012 02:26:10 PM)

Table 120 - FCC frequency hopping radar (Type 6) Results WU-Steady State High-Band						
Trial #	Pulses/ Burst	Pulse Width (us)	PRI (us)	Detected	Fr (MHz) and level (dBm)	Burst Information
14	9	1.0	333.0	Yes	5563.2MHz, -62.0dBm	Hop sequence: 5356, 5473, 5607, 5622, 5453, 5689, 5685, 5323, 5379, 5517, 5341, 5677, 5636, 5568, 5300, 5274, 5520, 5257, 5559, 5436, 5695, 5561, 5438, 5661, 5643, 5567, 5340, 5382, 5710, 5526, 5310, 5575, 5460, 5665, 5328, 5670, 5383, 5602, 5716, 5501, 5543, 5553, 5698, 5497, 5294, 5554, 5334, 5606, 5318, 5679, 5638, 5443, 5619, 5266, 5315, 5515, 5528, 5338, 5388, 5519, 5439, 5719, 5392, 5523, 5647, 5368, 5611, 5365, 5714, 5578, 5703, 5324, 5486, 5674, 5701, 5414, 5595, 5302, 5529, 5408, 5477, 5490, 5590, 5407, 5531, 5312, 5330, 5261, 5325, 5425, 5468, 5428, 5362, 5621, 5598, 5370, 5482, 5454, 5476, 5282 (6 hits) (11/19/2012 02:26:18 PM)
15	9	1.0	333.0	Yes	5564.2MHz, -62.0dBm	Hop sequence: 5314, 5718, 5444, 5549, 5352, 5463, 5583, 5496, 5384, 5645, 5546, 5579, 5265, 5490, 5483, 5509, 5261, 5446, 5716, 5703, 5596, 5433, 5592, 5708, 5705, 5698, 5355, 5473, 5591, 5574, 5315, 5304, 5598, 5425, 5622, 5548, 5421, 5531, 5264, 5683, 5563, 5322, 5476, 5251, 5277, 5435, 5691, 5614, 5313, 5451, 5656, 5620, 5404, 5432, 5441, 5411, 5680, 5405, 5723, 5511, 5426, 5465, 5477, 5538, 5658, 5605, 5542, 5724, 5396, 5541, 5590, 5481, 5669, 5593, 5449, 5330, 5570, 5398, 5647, 5545, 5651, 5687, 5685, 5340, 5638, 5335, 5377, 5397, 5692, 5533, 5643, 5273, 5455, 5480, 5617, 5400, 5295, 5372, 5657, 5659 (3 hits) (11/19/2012 02:26:25 PM)

Table 120 - FCC frequency hopping radar (Type 6) Results WU-Steady State High-Band						
Trial #	Pulses/ Burst	Pulse Width (us)	PRI (us)	Detected	Fr (MHz) and level (dBm)	Burst Information
16	9	1.0	333.0	Yes	5565.2MHz, -62.0dBm	Hop sequence: 5719, 5420, 5621, 5613, 5391, 5637, 5615, 5667, 5369, 5517, 5465, 5499, 5706, 5364, 5646, 5250, 5407, 5633, 5693, 5524, 5413, 5604, 5483, 5711, 5292, 5581, 5287, 5254, 5628, 5523, 5360, 5423, 5265, 5551, 5560, 5439, 5316, 5349, 5505, 5675, 5263, 5274, 5362, 5375, 5315, 5707, 5485, 5440, 5680, 5590, 5550, 5597, 5508, 5716, 5701, 5270, 5278, 5663, 5313, 5650, 5314, 5383, 5301, 5696, 5542, 5304, 5385, 5537, 5546, 5510, 5572, 5677, 5351, 5386, 5608, 5725, 5330, 5504, 5547, 5323, 5288, 5595, 5636, 5482, 5476, 5703, 5700, 5598, 5566, 5480, 5329, 5347, 5513, 5253, 5289, 5656, 5643, 5498, 5630, 5422 (3 hits) (11/19/2012 02:26:33 PM)
17	9	1.0	333.0	Yes	5566.2MHz, -62.0dBm	Hop sequence: 5274, 5431, 5614, 5572, 5707, 5384, 5666, 5463, 5397, 5298, 5449, 5472, 5640, 5602, 5424, 5717, 5648, 5583, 5340, 5611, 5433, 5302, 5725, 5258, 5335, 5423, 5404, 5296, 5560, 5658, 5461, 5418, 5411, 5653, 5603, 5324, 5553, 5545, 5280, 5617, 5558, 5541, 5289, 5347, 5527, 5497, 5692, 5704, 5300, 5301, 5722, 5456, 5515, 5499, 5421, 5623, 5333, 5710, 5291, 5318, 5581, 5616, 5650, 5696, 5586, 5315, 5359, 5287, 5386, 5448, 5718, 5513, 5524, 5537, 5512, 5407, 5535, 5577, 5351, 5644, 5271, 5609, 5337, 5393, 5588, 5563, 5462, 5388, 5642, 5437, 5615, 5550, 5489, 5394, 5700, 5251, 5600, 5396, 5450, 5466 (5 hits) (11/19/2012 02:26:48 PM)

Table 120 - FCC frequency hopping radar (Type 6) Results WU-Steady State High-Band						
Trial #	Pulses/ Burst	Pulse Width (us)	PRI (us)	Detected	Fr (MHz) and level (dBm)	Burst Information
18	9	1.0	333.0	Yes	5567.2MHz, -62.0dBm	Hop sequence: 5599, 5568, 5519, 5664, 5360, 5696, 5323, 5423, 5386, 5461, 5624, 5636, 5613, 5431, 5539, 5308, 5479, 5674, 5547, 5668, 5563, 5346, 5265, 5301, 5642, 5372, 5534, 5595, 5618, 5720, 5503, 5467, 5270, 5399, 5683, 5472, 5540, 5283, 5661, 5278, 5524, 5687, 5345, 5409, 5672, 5337, 5290, 5287, 5516, 5289, 5388, 5373, 5597, 5426, 5348, 5710, 5459, 5708, 5391, 5655, 5666, 5484, 5716, 5517, 5441, 5434, 5315, 5658, 5381, 5580, 5390, 5267, 5374, 5319, 5562, 5600, 5367, 5515, 5543, 5329, 5437, 5489, 5704, 5616, 5607, 5343, 5500, 5570, 5279, 5415, 5359, 5311, 5295, 5490, 5693, 5602, 5631, 5648, 5363, 5645 (4 hits) (11/19/2012 02:26:55 PM)
19	9	1.0	333.0	Yes	5568.2MHz, -62.0dBm	Hop sequence: 5297, 5365, 5444, 5454, 5305, 5616, 5338, 5677, 5405, 5468, 5329, 5368, 5534, 5641, 5608, 5278, 5577, 5615, 5602, 5460, 5310, 5347, 5540, 5331, 5582, 5432, 5720, 5592, 5506, 5255, 5595, 5626, 5483, 5550, 5320, 5409, 5357, 5714, 5413, 5511, 5267, 5647, 5526, 5466, 5539, 5535, 5630, 5680, 5710, 5447, 5633, 5293, 5569, 5402, 5396, 5657, 5644, 5292, 5269, 5367, 5726, 5699, 5530, 5675, 5525, 5418, 5705, 5268, 5427, 5438, 5451, 5485, 5693, 5606, 5439, 5288, 5661, 5354, 5273, 5371, 5669, 5252, 5707, 5524, 5307, 5660, 5594, 5410, 5698, 5504, 5425, 5260, 5270, 5609, 5492, 5308, 5556, 5419, 5335, 5350 (2 hits) (11/19/2012 02:27:02 PM)

Table 120 - FCC frequency hopping radar (Type 6) Results WU-Steady State High-Band						
Trial #	Pulses/ Burst	Pulse Width (us)	PRI (us)	Detected	Fr (MHz) and level (dBm)	Burst Information
20	9	1.0	333.0	Yes	5569.2MHz, -62.0dBm	Hop sequence: 5475, 5311, 5483, 5571, 5656, 5547, 5381, 5573, 5572, 5410, 5640, 5551, 5568, 5362, 5622, 5637, 5281, 5463, 5599, 5693, 5505, 5317, 5471, 5578, 5718, 5544, 5684, 5361, 5319, 5426, 5502, 5459, 5532, 5723, 5260, 5633, 5473, 5262, 5452, 5646, 5629, 5665, 5660, 5403, 5269, 5265, 5511, 5717, 5320, 5508, 5330, 5380, 5616, 5274, 5408, 5696, 5307, 5425, 5531, 5706, 5687, 5273, 5581, 5283, 5598, 5332, 5448, 5297, 5490, 5376, 5499, 5556, 5565, 5296, 5690, 5464, 5465, 5591, 5467, 5378, 5704, 5431, 5603, 5671, 5725, 5627, 5720, 5349, 5286, 5477, 5506, 5609, 5657, 5523, 5309, 5415, 5437, 5346, 5647, 5451 (6 hits) (11/19/2012 02:27:10 PM)
21	9	1.0	333.0	Yes	5570.2MHz, -62.0dBm	Hop sequence: 5514, 5572, 5423, 5429, 5251, 5446, 5713, 5260, 5250, 5299, 5353, 5466, 5270, 5359, 5294, 5625, 5513, 5562, 5574, 5593, 5542, 5313, 5424, 5283, 5649, 5672, 5651, 5525, 5503, 5611, 5441, 5698, 5302, 5697, 5717, 5599, 5420, 5289, 5689, 5345, 5577, 5715, 5376, 5325, 5409, 5488, 5339, 5554, 5627, 5614, 5312, 5610, 5511, 5644, 5535, 5523, 5567, 5667, 5432, 5573, 5690, 5578, 5459, 5548, 5254, 5368, 5408, 5517, 5519, 5722, 5703, 5392, 5607, 5543, 5354, 5560, 5317, 5372, 5450, 5633, 5507, 5656, 5624, 5532, 5364, 5403, 5674, 5362, 5318, 5382, 5637, 5536, 5326, 5393, 5263, 5726, 5618, 5350, 5444, 5261 (7 hits) (11/19/2012 02:27:21 PM)



Table 120 - FCC frequency hopping radar (Type 6) Results WU-Steady State High-Band						
Trial #	Pulses/ Burst	Pulse Width (us)	PRI (us)	Detected	Fr (MHz) and level (dBm)	Burst Information
22	9	1.0	333.0	Yes	5571.2MHz, -62.0dBm	Hop sequence: 5572, 5298, 5620, 5426, 5687, 5573, 5451, 5281, 5334, 5367, 5412, 5307, 5414, 5580, 5595, 5602, 5271, 5316, 5403, 5395, 5441, 5562, 5711, 5656, 5435, 5294, 5721, 5343, 5498, 5535, 5651, 5565, 5655, 5624, 5571, 5282, 5662, 5513, 5372, 5524, 5269, 5579, 5626, 5718, 5438, 5411, 5390, 5577, 5313, 5544, 5385, 5637, 5279, 5556, 5317, 5250, 5521, 5484, 5272, 5699, 5363, 5713, 5470, 5312, 5462, 5323, 5681, 5545, 5505, 5488, 5302, 5667, 5634, 5254, 5330, 5494, 5442, 5443, 5646, 5366, 5475, 5526, 5584, 5474, 5678, 5715, 5613, 5362, 5551, 5473, 5490, 5657, 5673, 5593, 5596, 5445, 5720, 5297, 5283, 5559 (7 hits) (11/19/2012 02:27:32 PM)
23	9	1.0	333.0	Yes	5572.2MHz, -62.0dBm	Hop sequence: 5642, 5708, 5277, 5470, 5591, 5399, 5643, 5314, 5649, 5495, 5311, 5279, 5695, 5582, 5318, 5423, 5280, 5519, 5300, 5532, 5360, 5446, 5663, 5284, 5421, 5382, 5361, 5659, 5315, 5383, 5261, 5722, 5289, 5266, 5709, 5313, 5593, 5509, 5345, 5660, 5674, 5705, 5725, 5488, 5529, 5594, 5540, 5656, 5576, 5535, 5444, 5571, 5518, 5386, 5472, 5678, 5613, 5622, 5308, 5460, 5514, 5291, 5693, 5556, 5416, 5630, 5588, 5264, 5706, 5402, 5299, 5337, 5334, 5698, 5359, 5485, 5451, 5483, 5351, 5342, 5419, 5517, 5527, 5670, 5395, 5343, 5435, 5377, 5573, 5536, 5329, 5547, 5690, 5282, 5379, 5422, 5548, 5699, 5691, 5293 (3 hits) (11/19/2012 02:27:40 PM)

<b>Table 120 - FCC frequency hopping radar (Type 6) Results WU-Steady State High-Band</b>						
Trial #	Pulses/ Burst	Pulse Width (us)	PRI (us)	Detected	Fr (MHz) and level (dBm)	Burst Information
24	9	1.0	333.0	Yes	5573.2MHz, -62.0dBm	Hop sequence: 5696, 5554, 5337, 5370, 5545, 5298, 5373, 5432, 5396, 5620, 5583, 5369, 5689, 5311, 5590, 5619, 5488, 5722, 5278, 5706, 5316, 5551, 5611, 5526, 5375, 5610, 5439, 5679, 5303, 5254, 5710, 5264, 5329, 5596, 5531, 5643, 5259, 5260, 5681, 5485, 5318, 5331, 5640, 5646, 5302, 5378, 5546, 5491, 5505, 5543, 5285, 5557, 5587, 5325, 5280, 5575, 5389, 5556, 5295, 5340, 5517, 5304, 5501, 5377, 5494, 5601, 5512, 5425, 5309, 5511, 5500, 5535, 5279, 5399, 5683, 5402, 5602, 5558, 5448, 5519, 5532, 5335, 5573, 5688, 5585, 5498, 5345, 5380, 5436, 5560, 5362, 5670, 5684, 5466, 5397, 5473, 5271, 5514, 5332, 5395 (6 hits) (11/19/2012 02:27:48 PM)
25	9	1.0	333.0	Yes	5574.2MHz, -62.0dBm	Hop sequence: 5616, 5628, 5283, 5504, 5345, 5569, 5410, 5290, 5536, 5340, 5515, 5284, 5336, 5704, 5498, 5351, 5579, 5538, 5531, 5275, 5329, 5533, 5446, 5459, 5333, 5643, 5638, 5654, 5709, 5317, 5402, 5708, 5432, 5591, 5397, 5387, 5294, 5424, 5298, 5319, 5396, 5476, 5384, 5467, 5690, 5539, 5377, 5434, 5567, 5253, 5356, 5521, 5684, 5604, 5462, 5550, 5512, 5495, 5713, 5280, 5419, 5472, 5590, 5326, 5355, 5365, 5276, 5281, 5679, 5491, 5353, 5545, 5707, 5470, 5551, 5273, 5614, 5369, 5549, 5386, 5620, 5574, 5664, 5649, 5334, 5368, 5680, 5258, 5342, 5659, 5611, 5633, 5693, 5644, 5423, 5686, 5496, 5261, 5415, 5304 (3 hits) (11/19/2012 02:27:55 PM)

Table 120 - FCC frequency hopping radar (Type 6) Results WU-Steady State High-Band						
Trial #	Pulses/ Burst	Pulse Width (us)	PRI (us)	Detected	Fr (MHz) and level (dBm)	Burst Information
26	9	1.0	333.0	Yes	5552.2MHz, -62.0dBm	Hop sequence: 5514, 5492, 5609, 5567, 5447, 5665, 5699, 5639, 5329, 5380, 5644, 5356, 5572, 5262, 5549, 5720, 5643, 5585, 5344, 5574, 5718, 5648, 5539, 5435, 5301, 5655, 5453, 5692, 5388, 5637, 5565, 5300, 5538, 5310, 5414, 5463, 5517, 5618, 5456, 5379, 5518, 5556, 5347, 5472, 5578, 5607, 5558, 5597, 5369, 5481, 5725, 5309, 5363, 5560, 5666, 5417, 5684, 5509, 5282, 5408, 5625, 5430, 5523, 5564, 5589, 5306, 5636, 5261, 5449, 5704, 5658, 5499, 5311, 5405, 5617, 5319, 5275, 5622, 5283, 5691, 5395, 5425, 5462, 5502, 5562, 5675, 5471, 5498, 5681, 5293, 5577, 5367, 5416, 5434, 5454, 5394, 5551, 5719, 5294, 5299 (9 hits) (11/19/2012 02:28:02 PM)
27	9	1.0	333.0	Yes	5553.2MHz, -62.0dBm	Hop sequence: 5454, 5642, 5613, 5403, 5659, 5597, 5254, 5267, 5701, 5355, 5719, 5528, 5272, 5275, 5508, 5418, 5599, 5548, 5541, 5386, 5444, 5553, 5591, 5481, 5412, 5527, 5417, 5516, 5600, 5589, 5652, 5677, 5510, 5432, 5521, 5718, 5337, 5682, 5421, 5273, 5569, 5630, 5395, 5373, 5685, 5251, 5694, 5315, 5469, 5282, 5310, 5410, 5305, 5622, 5438, 5351, 5287, 5293, 5662, 5456, 5308, 5387, 5277, 5258, 5547, 5291, 5582, 5570, 5350, 5635, 5661, 5726, 5656, 5486, 5666, 5675, 5617, 5397, 5489, 5259, 5446, 5487, 5262, 5512, 5605, 5519, 5445, 5419, 5559, 5550, 5335, 5478, 5537, 5270, 5665, 5292, 5408, 5376, 5279, 5503 (4 hits) (11/19/2012 02:28:11 PM)

Table 120 - FCC frequency hopping radar (Type 6) Results WU-Steady State High-Band						
Trial #	Pulses/ Burst	Pulse Width (us)	PRI (us)	Detected	Fr (MHz) and level (dBm)	Burst Information
28	9	1.0	333.0	Yes	5554.2MHz, -62.0dBm	Hop sequence: 5566, 5462, 5294, 5621, 5514, 5407, 5282, 5276, 5505, 5268, 5602, 5544, 5692, 5525, 5280, 5661, 5715, 5437, 5542, 5295, 5504, 5277, 5644, 5575, 5494, 5597, 5353, 5691, 5299, 5342, 5527, 5293, 5647, 5632, 5271, 5707, 5446, 5552, 5598, 5524, 5406, 5423, 5587, 5392, 5517, 5329, 5688, 5591, 5534, 5346, 5609, 5643, 5550, 5698, 5603, 5548, 5559, 5370, 5613, 5430, 5334, 5252, 5412, 5648, 5258, 5491, 5383, 5398, 5435, 5570, 5531, 5256, 5410, 5481, 5501, 5367, 5584, 5593, 5411, 5274, 5404, 5285, 5684, 5585, 5455, 5259, 5263, 5557, 5330, 5317, 5703, 5382, 5394, 5679, 5716, 5610, 5424, 5580, 5693, 5701 (4 hits) (11/19/2012 02:28:19 PM)
29	9	1.0	333.0	Yes	5555.2MHz, -62.0dBm	Hop sequence: 5604, 5606, 5287, 5438, 5368, 5560, 5710, 5458, 5334, 5546, 5517, 5264, 5291, 5313, 5455, 5478, 5362, 5613, 5331, 5364, 5437, 5718, 5302, 5611, 5329, 5506, 5584, 5405, 5449, 5471, 5343, 5654, 5699, 5603, 5540, 5647, 5450, 5622, 5406, 5371, 5457, 5251, 5272, 5357, 5483, 5488, 5352, 5543, 5617, 5573, 5578, 5393, 5572, 5663, 5539, 5556, 5349, 5711, 5633, 5284, 5489, 5662, 5412, 5439, 5335, 5679, 5532, 5358, 5706, 5262, 5529, 5695, 5444, 5294, 5467, 5389, 5381, 5345, 5374, 5656, 5491, 5484, 5635, 5265, 5519, 5472, 5365, 5678, 5666, 5409, 5322, 5445, 5522, 5547, 5482, 5653, 5717, 5461, 5623, 5644 (4 hits) (11/19/2012 02:28:30 PM)

Table 120 - FCC frequency hopping radar (Type 6) Results WU-Steady State High-Band						
Trial #	Pulses/ Burst	Pulse Width (us)	PRI (us)	Detected	Fr (MHz) and level (dBm)	Burst Information
30	9	1.0	333.0	Yes	5556.2MHz, -62.0dBm	Hop sequence: 5664, 5265, 5676, 5550, 5331, 5467, 5573, 5645, 5705, 5337, 5646, 5286, 5340, 5524, 5482, 5409, 5442, 5632, 5382, 5650, 5592, 5465, 5461, 5349, 5726, 5698, 5474, 5469, 5431, 5379, 5391, 5400, 5568, 5306, 5497, 5688, 5596, 5438, 5569, 5310, 5269, 5416, 5556, 5674, 5381, 5695, 5365, 5425, 5330, 5624, 5589, 5343, 5703, 5372, 5271, 5527, 5690, 5313, 5484, 5594, 5693, 5421, 5652, 5683, 5533, 5522, 5526, 5389, 5591, 5435, 5263, 5599, 5451, 5696, 5551, 5515, 5485, 5720, 5374, 5255, 5257, 5593, 5702, 5384, 5344, 5342, 5511, 5626, 5254, 5694, 5704, 5649, 5660, 5543, 5536, 5325, 5606, 5481, 5503, 5314 (4 hits) (11/19/2012 02:28:46 PM)
31	9	1.0	333.0	Yes	5557.2MHz, -62.0dBm	Hop sequence: 5303, 5578, 5301, 5658, 5569, 5542, 5292, 5655, 5691, 5630, 5659, 5522, 5518, 5346, 5369, 5705, 5509, 5300, 5708, 5540, 5503, 5274, 5480, 5671, 5354, 5306, 5372, 5320, 5679, 5323, 5676, 5272, 5577, 5521, 5594, 5650, 5607, 5449, 5419, 5611, 5544, 5675, 5685, 5620, 5646, 5703, 5284, 5333, 5289, 5638, 5418, 5499, 5382, 5525, 5384, 5460, 5461, 5501, 5537, 5386, 5481, 5373, 5443, 5360, 5396, 5294, 5574, 5591, 5610, 5603, 5517, 5415, 5437, 5634, 5428, 5625, 5297, 5353, 5438, 5535, 5298, 5613, 5572, 5600, 5349, 5618, 5448, 5257, 5702, 5551, 5352, 5604, 5424, 5345, 5434, 5253, 5368, 5677, 5528, 5678 (3 hits) (11/19/2012 02:29:09 PM)

Table 120 - FCC frequency hopping radar (Type 6) Results WU-Steady State High-Band						
Trial #	Pulses/ Burst	Pulse Width (us)	PRI (us)	Detected	Fr (MHz) and level (dBm)	Burst Information
32	9	1.0	333.0	Yes	5558.2MHz, -62.0dBm	Hop sequence: 5476, 5540, 5700, 5272, 5347, 5604, 5260, 5702, 5549, 5484, 5315, 5254, 5569, 5721, 5496, 5519, 5459, 5545, 5443, 5465, 5468, 5517, 5284, 5607, 5348, 5614, 5673, 5400, 5307, 5678, 5621, 5431, 5667, 5525, 5597, 5502, 5278, 5444, 5518, 5536, 5463, 5420, 5412, 5723, 5719, 5408, 5712, 5325, 5611, 5492, 5313, 5376, 5717, 5274, 5637, 5630, 5452, 5560, 5361, 5453, 5605, 5665, 5304, 5324, 5393, 5411, 5251, 5477, 5638, 5353, 5319, 5538, 5681, 5416, 5414, 5434, 5369, 5334, 5615, 5326, 5706, 5651, 5471, 5704, 5713, 5598, 5495, 5657, 5501, 5617, 5687, 5559, 5350, 5504, 5302, 5534, 5635, 5438, 5335, 5312 (3 hits) (11/19/2012 02:29:22 PM)
33	9	1.0	333.0	Yes	5559.2MHz, -62.0dBm	Hop sequence: 5276, 5676, 5591, 5389, 5542, 5395, 5288, 5390, 5438, 5611, 5572, 5609, 5328, 5282, 5579, 5319, 5449, 5690, 5298, 5310, 5458, 5294, 5383, 5553, 5372, 5370, 5464, 5343, 5268, 5269, 5332, 5421, 5665, 5640, 5643, 5687, 5350, 5410, 5325, 5518, 5366, 5674, 5415, 5530, 5719, 5589, 5544, 5581, 5429, 5411, 5708, 5397, 5501, 5691, 5483, 5662, 5333, 5264, 5290, 5446, 5485, 5322, 5270, 5330, 5515, 5426, 5574, 5655, 5664, 5443, 5683, 5503, 5487, 5442, 5583, 5450, 5567, 5475, 5476, 5474, 5300, 5558, 5545, 5598, 5513, 5251, 5492, 5367, 5302, 5460, 5681, 5301, 5465, 5444, 5280, 5484, 5663, 5360, 5718, 5616 (5 hits) (11/19/2012 02:29:34 PM)

Table 120 - FCC frequency hopping radar (Type 6) Results WU-Steady State High-Band						
Trial #	Pulses/ Burst	Pulse Width (us)	PRI (us)	Detected	Fr (MHz) and level (dBm)	Burst Information
34	9	1.0	333.0	Yes	5560.2MHz, -62.0dBm	Hop sequence: 5426, 5496, 5606, 5444, 5438, 5443, 5277, 5605, 5706, 5721, 5332, 5512, 5274, 5508, 5455, 5342, 5296, 5591, 5671, 5499, 5487, 5431, 5584, 5333, 5607, 5452, 5436, 5311, 5341, 5509, 5613, 5513, 5574, 5678, 5384, 5348, 5369, 5263, 5636, 5628, 5702, 5583, 5515, 5715, 5486, 5564, 5592, 5349, 5532, 5580, 5668, 5498, 5485, 5652, 5481, 5324, 5352, 5282, 5325, 5673, 5467, 5558, 5697, 5271, 5618, 5688, 5303, 5595, 5542, 5367, 5371, 5428, 5535, 5266, 5488, 5343, 5406, 5675, 5397, 5561, 5603, 5254, 5298, 5398, 5402, 5294, 5701, 5353, 5344, 5295, 5537, 5601, 5338, 5458, 5478, 5507, 5335, 5500, 5719, 5377 (4 hits) (11/19/2012 02:29:52 PM)
35	9	1.0	333.0	Yes	5561.2MHz, -62.0dBm	Hop sequence: 5400, 5271, 5617, 5394, 5607, 5289, 5317, 5256, 5251, 5478, 5262, 5452, 5470, 5426, 5684, 5609, 5640, 5385, 5608, 5598, 5391, 5285, 5295, 5550, 5363, 5354, 5303, 5527, 5275, 5654, 5440, 5414, 5717, 5693, 5667, 5280, 5422, 5415, 5382, 5290, 5565, 5507, 5424, 5408, 5383, 5393, 5412, 5475, 5601, 5418, 5278, 5399, 5531, 5387, 5624, 5442, 5494, 5551, 5330, 5504, 5568, 5711, 5345, 5321, 5651, 5451, 5597, 5406, 5532, 5432, 5539, 5477, 5692, 5315, 5616, 5576, 5561, 5525, 5357, 5495, 5339, 5491, 5533, 5297, 5513, 5720, 5485, 5563, 5351, 5618, 5599, 5467, 5662, 5499, 5569, 5606, 5370, 5325, 5549, 5261 (5 hits) (11/19/2012 02:30:08 PM)

Table 120 - FCC frequency hopping radar (Type 6) Results WU-Steady State High-Band						
Trial #	Pulses/ Burst	Pulse Width (us)	PRI (us)	Detected	Fr (MHz) and level (dBm)	Burst Information
36	9	1.0	333.0	Yes	5562.2MHz, -62.0dBm	Hop sequence: 5616, 5720, 5494, 5379, 5264, 5432, 5461, 5578, 5426, 5526, 5384, 5429, 5469, 5330, 5341, 5410, 5606, 5569, 5413, 5289, 5614, 5587, 5309, 5347, 5721, 5615, 5550, 5591, 5314, 5684, 5513, 5688, 5669, 5491, 5572, 5303, 5308, 5262, 5266, 5280, 5358, 5660, 5460, 5324, 5636, 5343, 5443, 5375, 5486, 5676, 5441, 5377, 5649, 5474, 5269, 5594, 5444, 5463, 5411, 5405, 5482, 5565, 5313, 5353, 5425, 5631, 5468, 5297, 5633, 5653, 5507, 5618, 5555, 5440, 5542, 5600, 5457, 5442, 5563, 5340, 5656, 5300, 5344, 5338, 5253, 5438, 5434, 5270, 5608, 5574, 5619, 5558, 5678, 5497, 5500, 5348, 5605, 5638, 5637, 5544 (7 hits) (11/19/2012 02:30:19 PM)
37	9	1.0	333.0	Yes	5563.2MHz, -62.0dBm	Hop sequence: 5708, 5638, 5314, 5700, 5365, 5462, 5573, 5453, 5289, 5299, 5648, 5626, 5721, 5690, 5388, 5535, 5673, 5572, 5558, 5435, 5449, 5467, 5675, 5532, 5272, 5379, 5564, 5339, 5368, 5358, 5629, 5670, 5530, 5576, 5286, 5334, 5452, 5726, 5348, 5601, 5614, 5331, 5543, 5687, 5431, 5328, 5472, 5695, 5361, 5305, 5288, 5426, 5624, 5637, 5689, 5490, 5680, 5698, 5658, 5506, 5340, 5494, 5281, 5355, 5290, 5367, 5685, 5430, 5380, 5588, 5569, 5418, 5349, 5722, 5582, 5492, 5338, 5266, 5476, 5259, 5705, 5511, 5434, 5429, 5285, 5278, 5612, 5398, 5344, 5609, 5342, 5498, 5546, 5656, 5671, 5707, 5439, 5464, 5567, 5352 (6 hits) (11/19/2012 02:30:30 PM)



Table 120 - FCC frequency hopping radar (Type 6) Results WU-Steady State High-Band						
Trial #	Pulses/ Burst	Pulse Width (us)	PRI (us)	Detected	Fr (MHz) and level (dBm)	Burst Information
38	9	1.0	333.0	Yes	5564.2MHz, -62.0dBm	Hop sequence: 5363, 5680, 5383, 5346, 5495, 5622, 5681, 5292, 5453, 5606, 5641, 5254, 5311, 5566, 5491, 5301, 5367, 5449, 5701, 5272, 5598, 5595, 5724, 5591, 5300, 5577, 5704, 5492, 5454, 5698, 5326, 5561, 5401, 5710, 5630, 5413, 5418, 5633, 5544, 5714, 5499, 5670, 5378, 5359, 5343, 5477, 5588, 5334, 5471, 5281, 5472, 5512, 5565, 5429, 5552, 5537, 5667, 5494, 5355, 5400, 5496, 5286, 5365, 5444, 5302, 5619, 5405, 5440, 5480, 5643, 5573, 5467, 5655, 5533, 5484, 5690, 5485, 5329, 5673, 5387, 5345, 5335, 5722, 5274, 5459, 5627, 5483, 5374, 5542, 5310, 5481, 5530, 5716, 5547, 5629, 5317, 5298, 5468, 5541, 5452 (4 hits) (11/19/2012 02:30:51 PM)
39	9	1.0	333.0	Yes	5565.2MHz, -62.0dBm	Hop sequence: 5435, 5440, 5398, 5625, 5711, 5278, 5525, 5595, 5359, 5500, 5514, 5718, 5311, 5369, 5707, 5282, 5353, 5587, 5570, 5297, 5526, 5474, 5350, 5644, 5517, 5394, 5414, 5690, 5565, 5276, 5370, 5487, 5522, 5441, 5585, 5530, 5477, 5689, 5396, 5320, 5642, 5265, 5263, 5679, 5545, 5349, 5512, 5449, 5413, 5481, 5515, 5656, 5661, 5593, 5584, 5566, 5281, 5544, 5635, 5489, 5697, 5652, 5698, 5726, 5588, 5372, 5445, 5655, 5607, 5637, 5262, 5327, 5405, 5422, 5546, 5583, 5662, 5692, 5699, 5518, 5622, 5490, 5550, 5547, 5511, 5337, 5316, 5542, 5724, 5335, 5308, 5678, 5402, 5364, 5430, 5536, 5383, 5640, 5386, 5704 (3 hits) (11/19/2012 02:31:00 PM)

Table 120 - FCC frequency hopping radar (Type 6) Results WU-Steady State High-Band						
Trial #	Pulses/ Burst	Pulse Width (us)	PRI (us)	Detected	Fr (MHz) and level (dBm)	Burst Information
40	9	1.0	333.0	Yes	5566.2MHz, -62.0dBm	Hop sequence: 5684, 5311, 5682, 5532, 5697, 5473, 5545, 5330, 5418, 5513, 5575, 5717, 5431, 5588, 5695, 5351, 5459, 5638, 5553, 5694, 5395, 5355, 5366, 5608, 5617, 5253, 5354, 5618, 5417, 5639, 5595, 5290, 5647, 5386, 5686, 5307, 5691, 5284, 5626, 5363, 5487, 5263, 5464, 5541, 5308, 5544, 5679, 5525, 5476, 5468, 5651, 5367, 5648, 5616, 5337, 5714, 5723, 5485, 5520, 5598, 5340, 5629, 5517, 5576, 5656, 5289, 5514, 5522, 5674, 5701, 5447, 5320, 5561, 5478, 5590, 5658, 5426, 5338, 5594, 5593, 5409, 5265, 5350, 5707, 5645, 5454, 5496, 5382, 5335, 5428, 5304, 5722, 5625, 5600, 5451, 5282, 5719, 5556, 5293, 5449 (3 hits) (11/19/2012 02:31:09 PM)
41	9	1.0	333.0	Yes	5567.2MHz, -62.0dBm	Hop sequence: 5505, 5341, 5277, 5331, 5675, 5435, 5557, 5496, 5715, 5286, 5322, 5292, 5658, 5279, 5415, 5477, 5441, 5483, 5541, 5608, 5268, 5313, 5560, 5612, 5401, 5385, 5370, 5282, 5532, 5499, 5308, 5531, 5330, 5274, 5558, 5550, 5346, 5710, 5419, 5635, 5662, 5545, 5290, 5395, 5275, 5547, 5394, 5555, 5482, 5294, 5651, 5399, 5303, 5404, 5582, 5667, 5301, 5312, 5605, 5606, 5440, 5425, 5287, 5391, 5281, 5626, 5679, 5702, 5310, 5493, 5622, 5676, 5321, 5428, 5552, 5628, 5411, 5579, 5289, 5306, 5469, 5457, 5443, 5506, 5693, 5316, 5592, 5586, 5327, 5450, 5648, 5649, 5680, 5504, 5631, 5717, 5684, 5554, 5716, 5627 (5 hits) (11/19/2012 02:31:19 PM)

Table 120 - FCC frequency hopping radar (Type 6) Results WU-Steady State High-Band						
Trial #	Pulses/ Burst	Pulse Width (us)	PRI (us)	Detected	Fr (MHz) and level (dBm)	Burst Information
42	9	1.0	333.0	Yes	5568.2MHz, -62.0dBm	Hop sequence: 5377, 5665, 5544, 5569, 5691, 5664, 5526, 5595, 5327, 5420, 5552, 5407, 5704, 5313, 5464, 5476, 5496, 5725, 5435, 5699, 5636, 5711, 5344, 5672, 5351, 5371, 5721, 5641, 5289, 5467, 5305, 5608, 5687, 5693, 5499, 5398, 5627, 5300, 5660, 5531, 5575, 5649, 5556, 5561, 5577, 5656, 5278, 5367, 5473, 5723, 5405, 5418, 5357, 5404, 5679, 5555, 5380, 5707, 5258, 5621, 5567, 5606, 5652, 5685, 5366, 5568, 5453, 5604, 5689, 5251, 5410, 5498, 5386, 5488, 5566, 5597, 5314, 5279, 5726, 5582, 5364, 5447, 5645, 5637, 5508, 5333, 5336, 5633, 5469, 5434, 5295, 5448, 5671, 5436, 5562, 5538, 5444, 5346, 5640, 5675 (8 hits) (11/19/2012 02:31:42 PM)
43	9	1.0	333.0	Yes	5569.2MHz, -62.0dBm	Hop sequence: 5270, 5402, 5355, 5612, 5646, 5412, 5473, 5596, 5276, 5520, 5320, 5595, 5365, 5656, 5543, 5322, 5293, 5356, 5484, 5358, 5384, 5386, 5408, 5379, 5304, 5265, 5475, 5472, 5516, 5704, 5527, 5546, 5682, 5535, 5337, 5624, 5332, 5269, 5584, 5302, 5343, 5547, 5252, 5291, 5576, 5471, 5436, 5428, 5658, 5504, 5636, 5482, 5376, 5331, 5585, 5579, 5327, 5401, 5271, 5664, 5569, 5388, 5367, 5666, 5422, 5615, 5489, 5683, 5650, 5490, 5409, 5378, 5410, 5628, 5549, 5677, 5268, 5317, 5554, 5521, 5680, 5385, 5501, 5688, 5557, 5510, 5429, 5480, 5571, 5531, 5555, 5635, 5530, 5713, 5723, 5662, 5522, 5640, 5258, 5325 (5 hits) (11/19/2012 02:32:05 PM)

<b>Table 120 - FCC frequency hopping radar (Type 6) Results WU-Steady State High-Band</b>						
Trial #	Pulses/ Burst	Pulse Width (us)	PRI (us)	Detected	Fr (MHz) and level (dBm)	Burst Information
44	9	1.0	333.0	Yes	5570.2MHz, -62.0dBm	Hop sequence: 5694, 5535, 5459, 5700, 5725, 5364, 5304, 5651, 5669, 5585, 5253, 5327, 5492, 5565, 5646, 5719, 5607, 5285, 5250, 5418, 5597, 5647, 5474, 5578, 5409, 5360, 5681, 5258, 5610, 5380, 5693, 5615, 5381, 5508, 5312, 5277, 5576, 5604, 5297, 5650, 5334, 5662, 5357, 5441, 5291, 5688, 5589, 5659, 5413, 5690, 5513, 5543, 5562, 5332, 5709, 5634, 5583, 5723, 5506, 5336, 5256, 5283, 5403, 5643, 5620, 5695, 5533, 5383, 5514, 5524, 5715, 5252, 5549, 5396, 5338, 5598, 5484, 5447, 5706, 5490, 5425, 5377, 5400, 5526, 5314, 5677, 5491, 5295, 5599, 5499, 5670, 5572, 5616, 5348, 5401, 5430, 5489, 5303, 5699, 5621 (3 hits) (11/19/2012 02:32:27 PM)
45	9	1.0	333.0	Yes	5571.2MHz, -62.0dBm	Hop sequence: 5270, 5404, 5705, 5408, 5529, 5412, 5523, 5478, 5311, 5626, 5617, 5296, 5267, 5605, 5580, 5379, 5501, 5562, 5449, 5266, 5410, 5534, 5486, 5690, 5666, 5474, 5279, 5320, 5608, 5665, 5314, 5685, 5576, 5330, 5513, 5393, 5273, 5278, 5317, 5328, 5344, 5623, 5719, 5659, 5533, 5250, 5607, 5374, 5338, 5362, 5495, 5483, 5364, 5475, 5566, 5698, 5261, 5382, 5717, 5540, 5444, 5725, 5395, 5673, 5340, 5470, 5494, 5506, 5360, 5535, 5627, 5336, 5454, 5648, 5265, 5688, 5589, 5427, 5596, 5585, 5372, 5693, 5591, 5426, 5480, 5499, 5496, 5402, 5697, 5321, 5592, 5479, 5654, 5708, 5586, 5629, 5384, 5411, 5363, 5721 (2 hits) (11/19/2012 02:32:39 PM)

Table 120 - FCC frequency hopping radar (Type 6) Results WU-Steady State High-Band						
Trial #	Pulses/ Burst	Pulse Width (us)	PRI (us)	Detected	Fr (MHz) and level (dBm)	Burst Information
46	9	1.0	333.0	Yes	5572.2MHz, -62.0dBm	Hop sequence: 5459, 5306, 5445, 5421, 5659, 5281, 5534, 5454, 5698, 5292, 5433, 5405, 5636, 5585, 5412, 5484, 5413, 5357, 5314, 5273, 5368, 5284, 5415, 5605, 5477, 5430, 5411, 5505, 5709, 5548, 5685, 5641, 5332, 5726, 5600, 5424, 5320, 5322, 5537, 5561, 5299, 5364, 5466, 5711, 5352, 5660, 5346, 5481, 5644, 5707, 5575, 5647, 5409, 5697, 5470, 5286, 5598, 5618, 5394, 5619, 5453, 5514, 5532, 5422, 5582, 5517, 5562, 5491, 5333, 5608, 5604, 5706, 5654, 5261, 5375, 5676, 5620, 5285, 5456, 5431, 5625, 5400, 5324, 5348, 5617, 5283, 5683, 5483, 5599, 5705, 5443, 5304, 5587, 5564, 5372, 5661, 5588, 5425, 5633, 5725 (3 hits) (11/19/2012 02:32:54 PM)

CU Steady State Low Band

Table 121 - Summary of All Results - CU-Steady State Low-Band				
Waveform Name	Pd (%)	Pd Required (%)	Number of Trials	Status
FCC Short Pulse Radar (Type 1)	96.9 %	60.0 %	32	PASSED
FCC Short Pulse Radar (Type 2)	100.0 %	60.0 %	30	PASSED
FCC Short Pulse Radar (Type 3)	100.0 %	60.0 %	30	PASSED
FCC Short Pulse Radar (Type 4)	96.7 %	60.0 %	30	PASSED
Aggregate of above results	98.4 %	80.0 %	122	PASSED
Long Sequence	100.0 %	80.0 %	30	PASSED
FCC frequency hopping radar (Type 6)	100.0 %	70.0 %	46	PASSED

Table 122 - FCC Short Pulse Radar (Type 1) Results CU-Steady State Low-Band						
Trial #	Pulses/Burst	Pulse Width (us)	PRI (us)	Detected	Fr (MHz) and level (dBm)	Burst Information
1	18	1.0	1428.0	Yes	5284.8MHz, -61.0dBm	Single burst (11/19/2012 05:23:56 PM)
2	18	1.0	1428.0	Yes	5279.8MHz, -61.0dBm	Single burst (11/19/2012 05:24:07 PM)
3	18	1.0	1428.0	Yes	5289.8MHz, -61.0dBm	Single burst (11/19/2012 05:24:14 PM)
4	18	1.0	1428.0	Yes	5284.8MHz, -61.0dBm	Single burst (11/19/2012 05:24:22 PM)
5	18	1.0	1428.0	Yes	5279.8MHz, -61.0dBm	Single burst (11/19/2012 05:24:29 PM)
6	18	1.0	1428.0	Yes	5289.8MHz, -61.0dBm	Single burst (11/19/2012 05:24:39 PM)
7	18	1.0	1428.0	Yes	5284.8MHz, -61.0dBm	Single burst (11/19/2012 05:24:51 PM)
8	18	1.0	1428.0	Yes	5279.8MHz, -61.0dBm	Single burst (11/19/2012 05:24:58 PM)
9	18	1.0	1428.0	Yes	5289.8MHz, -61.0dBm	Single burst (11/19/2012 05:25:07 PM)
10	18	1.0	1428.0	Yes	5284.8MHz, -61.0dBm	Single burst (11/19/2012 05:25:18 PM)
11	18	1.0	1428.0	Yes	5279.8MHz, -61.0dBm	Single burst (11/19/2012 05:25:26 PM)
12	18	1.0	1428.0	Yes	5289.8MHz, -61.0dBm	Single burst (11/19/2012 05:25:34 PM)
13	18	1.0	1428.0	Yes	5284.8MHz, -61.0dBm	Single burst (11/19/2012 05:25:41 PM)
14	18	1.0	1428.0	Yes	5279.8MHz, -61.0dBm	Single burst (11/19/2012 05:25:48 PM)
15	18	1.0	1428.0	Yes	5289.8MHz, -61.0dBm	Single burst (11/19/2012 05:25:55 PM)
16	18	1.0	1428.0	Yes	5284.8MHz, -61.0dBm	Single burst (11/19/2012 05:26:02 PM)
17	18	1.0	1428.0	Yes	5279.8MHz, -61.0dBm	Single burst (11/19/2012 05:26:10 PM)
18	18	1.0	1428.0	Yes	5289.8MHz, -61.0dBm	Single burst (11/19/2012 05:26:18 PM)
19	18	1.0	1428.0	Yes	5284.8MHz, -61.0dBm	Single burst (11/19/2012 05:26:25 PM)

<b>Table 122 - FCC Short Pulse Radar (Type 1) Results CU-Steady State Low-Band</b>						
Trial #	Pulses/ Burst	Pulse Width (us)	PRI (us)	Detected	Fr (MHz) and level (dBm)	Burst Information
20	18	1.0	1428.0	Yes	5279.8MHz, -61.0dBm	Single burst (11/19/2012 05:26:33 PM)
21	18	1.0	1428.0	Yes	5289.8MHz, -61.0dBm	Single burst (11/19/2012 05:26:40 PM)
22	18	1.0	1428.0	Yes	5284.8MHz, -61.0dBm	Single burst (11/19/2012 05:26:54 PM)
23	18	1.0	1428.0	Yes	5279.8MHz, -61.0dBm	Single burst (11/19/2012 05:27:05 PM)
24	18	1.0	1428.0	Yes	5289.8MHz, -61.0dBm	Single burst (11/19/2012 05:27:13 PM)
25	18	1.0	1428.0	Yes	5284.8MHz, -61.0dBm	Single burst (11/19/2012 05:27:21 PM)
26	18	1.0	1428.0	No	5279.8MHz, -61.0dBm	Single burst (11/19/2012 05:27:31 PM)
27	18	1.0	1428.0	Yes	5289.8MHz, -61.0dBm	Single burst (11/19/2012 05:28:07 PM)
28	18	1.0	1428.0	Yes	5284.8MHz, -61.0dBm	Single burst (11/19/2012 05:28:16 PM)
29	18	1.0	1428.0	Yes	5279.8MHz, -61.0dBm	Single burst (11/19/2012 05:28:28 PM)
30	18	1.0	1428.0	Yes	5289.8MHz, -61.0dBm	Single burst (11/19/2012 05:28:44 PM)
31	18	1.0	1428.0	Yes	5284.8MHz, -61.0dBm	Single burst (11/19/2012 05:28:54 PM)
32	18	1.0	1428.0	Yes	5279.8MHz, -61.0dBm	Single burst (11/19/2012 05:29:02 PM)

<b>Table 123 - FCC Short Pulse Radar (Type 2) Results CU-Steady State Low-Band</b>						
Trial #	Pulses/ Burst	Pulse Width (us)	PRI (us)	Detected	Fr (MHz) and level (dBm)	Burst Information
1	29	2.0	168.0	Yes	5284.8MHz, -61.0dBm	Single burst (11/19/2012 05:30:38 PM)
2	28	4.9	220.0	Yes	5279.8MHz, -61.0dBm	Single burst (11/19/2012 05:30:49 PM)
3	24	4.3	207.0	Yes	5289.8MHz, -61.0dBm	Single burst (11/19/2012 05:30:56 PM)
4	27	1.3	210.0	Yes	5284.8MHz, -61.0dBm	Single burst (11/19/2012 05:31:06 PM)
5	25	2.0	188.0	Yes	5279.8MHz, -61.0dBm	Single burst (11/19/2012 05:31:13 PM)
6	24	1.8	177.0	Yes	5289.8MHz, -61.0dBm	Single burst (11/19/2012 05:31:20 PM)
7	23	4.5	230.0	Yes	5284.8MHz, -61.0dBm	Single burst (11/19/2012 05:31:30 PM)
8	24	1.3	179.0	Yes	5279.8MHz, -61.0dBm	Single burst (11/19/2012 05:31:37 PM)
9	27	1.7	179.0	Yes	5289.8MHz, -61.0dBm	Single burst (11/19/2012 05:31:44 PM)
10	29	1.6	181.0	Yes	5284.8MHz, -61.0dBm	Single burst (11/19/2012 05:31:51 PM)
11	25	4.3	190.0	Yes	5279.8MHz, -61.0dBm	Single burst (11/19/2012 05:32:00 PM)

<b>Table 123 - FCC Short Pulse Radar (Type 2) Results CU-Steady State Low-Band</b>						
Trial #	Pulses/ Burst	Pulse Width (us)	PRI (us)	Detected	Fr (MHz) and level (dBm)	Burst Information
12	29	3.4	204.0	Yes	5289.8MHz, -61.0dBm	Single burst (11/19/2012 05:32:07 PM)
13	24	1.8	227.0	Yes	5284.8MHz, -61.0dBm	Single burst (11/19/2012 05:32:21 PM)
14	28	3.7	226.0	Yes	5279.8MHz, -61.0dBm	Single burst (11/19/2012 05:33:18 PM)
15	24	1.0	161.0	Yes	5289.8MHz, -61.0dBm	Single burst (11/19/2012 05:33:29 PM)
16	25	2.8	177.0	Yes	5284.8MHz, -61.0dBm	Single burst (11/19/2012 05:33:42 PM)
17	24	4.8	193.0	Yes	5279.8MHz, -61.0dBm	Single burst (11/19/2012 05:35:10 PM)
18	26	1.5	152.0	Yes	5289.8MHz, -61.0dBm	Single burst (11/19/2012 05:35:18 PM)
19	25	1.1	199.0	Yes	5284.8MHz, -61.0dBm	Single burst (11/19/2012 05:35:29 PM)
20	25	1.1	180.0	Yes	5279.8MHz, -61.0dBm	Single burst (11/19/2012 05:35:40 PM)
21	25	3.5	203.0	Yes	5289.8MHz, -61.0dBm	Single burst (11/19/2012 05:35:53 PM)
22	28	1.8	199.0	Yes	5284.8MHz, -61.0dBm	Single burst (11/19/2012 05:36:04 PM)
23	25	4.1	154.0	Yes	5279.8MHz, -61.0dBm	Single burst (11/19/2012 05:36:17 PM)
24	27	3.1	178.0	Yes	5289.8MHz, -61.0dBm	Single burst (11/19/2012 05:36:24 PM)
25	26	2.8	203.0	Yes	5284.8MHz, -61.0dBm	Single burst (11/19/2012 05:36:31 PM)
26	23	1.1	198.0	Yes	5279.8MHz, -61.0dBm	Single burst (11/19/2012 05:36:48 PM)
27	28	1.0	184.0	Yes	5289.8MHz, -61.0dBm	Single burst (11/19/2012 05:37:00 PM)
28	26	4.2	169.0	Yes	5284.8MHz, -61.0dBm	Single burst (11/19/2012 05:37:13 PM)
29	24	3.7	200.0	Yes	5279.8MHz, -61.0dBm	Single burst (11/19/2012 05:37:23 PM)
30	24	3.3	208.0	Yes	5289.8MHz, -61.0dBm	Single burst (11/19/2012 05:37:40 PM)

<b>Table 124 - FCC Short Pulse Radar (Type 3) Results CU-Steady State Low-Band</b>						
Trial #	Pulses/ Burst	Pulse Width (us)	PRI (us)	Detected	Fr (MHz) and level (dBm)	Burst Information
1	18	9.8	485.0	Yes	5284.8MHz, -61.0dBm	Single burst (11/19/2012 05:38:18 PM)
2	17	9.9	208.0	Yes	5279.8MHz, -61.0dBm	Single burst (11/19/2012 05:38:25 PM)
3	17	9.9	306.0	Yes	5289.8MHz, -61.0dBm	Single burst (11/19/2012 05:38:34 PM)
4	16	7.1	369.0	Yes	5284.8MHz, -61.0dBm	Single burst (11/19/2012 05:38:41 PM)
5	18	9.1	289.0	Yes	5279.8MHz, -61.0dBm	Single burst (11/19/2012 05:38:47 PM)



<b>Table 124 - FCC Short Pulse Radar (Type 3) Results CU-Steady State Low-Band</b>						
Trial #	Pulses/ Burst	Pulse Width (us)	PRI (us)	Detected	Fr (MHz) and level (dBm)	Burst Information
6	17	9.7	457.0	Yes	5289.8MHz, -61.0dBm	Single burst (11/19/2012 05:38:54 PM)
7	17	7.8	332.0	Yes	5284.8MHz, -61.0dBm	Single burst (11/19/2012 05:39:00 PM)
8	17	9.5	391.0	Yes	5279.8MHz, -61.0dBm	Single burst (11/19/2012 05:39:09 PM)
9	16	8.0	241.0	Yes	5289.8MHz, -61.0dBm	Single burst (11/19/2012 05:39:16 PM)
10	18	7.4	315.0	Yes	5284.8MHz, -61.0dBm	Single burst (11/19/2012 05:39:23 PM)
11	17	7.9	461.0	Yes	5279.8MHz, -61.0dBm	Single burst (11/19/2012 05:39:30 PM)
12	17	8.1	422.0	Yes	5289.8MHz, -61.0dBm	Single burst (11/19/2012 05:39:37 PM)
13	17	7.2	379.0	Yes	5284.8MHz, -61.0dBm	Single burst (11/19/2012 05:39:45 PM)
14	16	8.1	274.0	Yes	5279.8MHz, -61.0dBm	Single burst (11/19/2012 05:39:53 PM)
15	17	8.9	318.0	Yes	5289.8MHz, -61.0dBm	Single burst (11/19/2012 05:40:01 PM)
16	16	8.6	457.0	Yes	5284.8MHz, -61.0dBm	Single burst (11/19/2012 05:40:08 PM)
17	17	7.8	365.0	Yes	5279.8MHz, -61.0dBm	Single burst (11/19/2012 05:40:15 PM)
18	17	9.9	209.0	Yes	5289.8MHz, -61.0dBm	Single burst (11/19/2012 05:40:23 PM)
19	16	9.2	357.0	Yes	5284.8MHz, -61.0dBm	Single burst (11/19/2012 05:40:30 PM)
20	18	9.8	481.0	Yes	5279.8MHz, -61.0dBm	Single burst (11/19/2012 05:40:37 PM)
21	18	6.3	341.0	Yes	5289.8MHz, -61.0dBm	Single burst (11/19/2012 05:40:45 PM)
22	17	8.0	340.0	Yes	5284.8MHz, -61.0dBm	Single burst (11/19/2012 05:41:02 PM)
23	16	7.7	208.0	Yes	5279.8MHz, -61.0dBm	Single burst (11/19/2012 05:41:10 PM)
24	18	8.0	226.0	Yes	5289.8MHz, -61.0dBm	Single burst (11/19/2012 05:41:17 PM)
25	18	9.0	253.0	Yes	5284.8MHz, -61.0dBm	Single burst (11/19/2012 05:41:24 PM)
26	18	7.0	336.0	Yes	5279.8MHz, -61.0dBm	Single burst (11/19/2012 05:41:30 PM)
27	18	7.8	477.0	Yes	5289.8MHz, -61.0dBm	Single burst (11/19/2012 05:41:38 PM)
28	16	6.8	278.0	Yes	5284.8MHz, -61.0dBm	Single burst (11/19/2012 05:41:45 PM)
29	17	8.5	325.0	Yes	5279.8MHz, -61.0dBm	Single burst (11/19/2012 05:41:52 PM)
30	18	9.8	288.0	Yes	5289.8MHz, -61.0dBm	Single burst (11/19/2012 05:42:01 PM)

**Table 125 - FCC Short Pulse Radar (Type 4) Results CU-Steady State Low-Band**

Trial #	Pulses/ Burst	Pulse Width (us)	PRI (us)	Detected	Fr (MHz) and level (dBm)	Burst Information
1	12	12.9	249.0	Yes	5284.8MHz, -61.0dBm	Single burst (11/19/2012 05:42:29 PM)
2	15	13.0	388.0	Yes	5279.8MHz, -61.0dBm	Single burst (11/19/2012 05:42:39 PM)
3	13	12.6	468.0	Yes	5289.8MHz, -61.0dBm	Single burst (11/19/2012 05:42:47 PM)
4	15	16.9	317.0	Yes	5284.8MHz, -61.0dBm	Single burst (11/19/2012 05:42:57 PM)
5	13	17.3	245.0	Yes	5279.8MHz, -61.0dBm	Single burst (11/19/2012 05:43:05 PM)
6	14	17.1	210.0	Yes	5289.8MHz, -61.0dBm	Single burst (11/19/2012 05:43:13 PM)
7	13	12.3	422.0	No	5284.8MHz, -61.0dBm	Single burst (11/19/2012 05:43:21 PM)
8	16	19.6	232.0	Yes	5279.8MHz, -61.0dBm	Single burst (11/19/2012 05:43:48 PM)
9	16	15.4	439.0	Yes	5289.8MHz, -61.0dBm	Single burst (11/19/2012 05:43:57 PM)
10	16	15.0	413.0	Yes	5284.8MHz, -61.0dBm	Single burst (11/19/2012 05:44:05 PM)
11	13	19.5	293.0	Yes	5279.8MHz, -61.0dBm	Single burst (11/19/2012 05:44:11 PM)
12	12	11.9	335.0	Yes	5289.8MHz, -61.0dBm	Single burst (11/19/2012 05:44:19 PM)
13	15	17.8	320.0	Yes	5284.8MHz, -61.0dBm	Single burst (11/19/2012 05:44:25 PM)
14	13	15.6	226.0	Yes	5279.8MHz, -61.0dBm	Single burst (11/19/2012 05:44:32 PM)
15	14	13.5	483.0	Yes	5289.8MHz, -61.0dBm	Single burst (11/19/2012 05:44:38 PM)
16	16	13.5	299.0	Yes	5284.8MHz, -61.0dBm	Single burst (11/19/2012 05:44:45 PM)
17	13	16.6	255.0	Yes	5279.8MHz, -61.0dBm	Single burst (11/19/2012 05:44:52 PM)
18	12	18.8	329.0	Yes	5289.8MHz, -61.0dBm	Single burst (11/19/2012 05:44:58 PM)
19	14	15.1	264.0	Yes	5284.8MHz, -61.0dBm	Single burst (11/19/2012 05:45:06 PM)
20	13	19.9	316.0	Yes	5279.8MHz, -61.0dBm	Single burst (11/19/2012 05:45:15 PM)
21	16	18.5	373.0	Yes	5289.8MHz, -61.0dBm	Single burst (11/19/2012 05:45:22 PM)
22	16	15.8	235.0	Yes	5284.8MHz, -61.0dBm	Single burst (11/19/2012 05:45:29 PM)
23	16	19.2	231.0	Yes	5279.8MHz, -61.0dBm	Single burst (11/19/2012 05:45:37 PM)
24	16	18.9	461.0	Yes	5289.8MHz, -61.0dBm	Single burst (11/19/2012 05:45:45 PM)
25	14	19.1	261.0	Yes	5284.8MHz, -61.0dBm	Single burst (11/19/2012 05:45:53 PM)
26	14	14.2	216.0	Yes	5279.8MHz, -61.0dBm	Single burst (11/19/2012 05:46:00 PM)
27	13	14.1	460.0	Yes	5289.8MHz, -61.0dBm	Single burst (11/19/2012 05:46:06 PM)
28	13	18.4	324.0	Yes	5284.8MHz, -61.0dBm	Single burst (11/19/2012 05:46:14 PM)

<b>Table 125 - FCC Short Pulse Radar (Type 4) Results CU-Steady State Low-Band</b>						
Trial #	Pulses/ Burst	Pulse Width (us)	PRI (us)	Detected	Fr (MHz) and level (dBm)	Burst Information
29	14	15.2	299.0	Yes	5279.8MHz, -61.0dBm	Single burst (11/19/2012 05:46:21 PM)
30	14	13.2	300.0	Yes	5289.8MHz, -61.0dBm	Single burst (11/19/2012 05:46:29 PM)

<b>Table 126 - Long Sequence Waveform Summary CU-Steady State Low-Band</b>		
Long Sequence Trial	Result	Radar Frequency / Amplitude
Trial #1	Detected	5284.8MHz, -61.0dBm
Trial #2	Detected	5279.8MHz, -61.0dBm
Trial #3	Detected	5289.8MHz, -61.0dBm
Trial #4	Detected	5284.8MHz, -61.0dBm
Trial #5	Detected	5279.8MHz, -61.0dBm
Trial #6	Detected	5289.8MHz, -61.0dBm
Trial #7	Detected	5284.8MHz, -61.0dBm
Trial #8	Detected	5279.8MHz, -61.0dBm
Trial #9	Detected	5289.8MHz, -61.0dBm
Trial #10	Detected	5284.8MHz, -61.0dBm
Trial #11	Detected	5279.8MHz, -61.0dBm
Trial #12	Detected	5289.8MHz, -61.0dBm
Trial #13	Detected	5284.8MHz, -61.0dBm
Trial #14	Detected	5279.8MHz, -61.0dBm
Trial #15	Detected	5289.8MHz, -61.0dBm
Trial #16	Detected	5284.8MHz, -61.0dBm
Trial #17	Detected	5279.8MHz, -61.0dBm
Trial #18	Detected	5289.8MHz, -61.0dBm
Trial #19	Detected	5284.8MHz, -61.0dBm
Trial #20	Detected	5279.8MHz, -61.0dBm
Trial #21	Detected	5289.8MHz, -61.0dBm
Trial #22	Detected	5284.8MHz, -61.0dBm

Table 126 - Long Sequence Waveform Summary CU-Steady State Low-Band		
Long Sequence Trial	Result	Radar Frequency / Amplitude
Trial #23	Detected	5279.8MHz, -61.0dBm
Trial #24	Detected	5289.8MHz, -61.0dBm
Trial #25	Detected	5284.8MHz, -61.0dBm
Trial #26	Detected	5279.8MHz, -61.0dBm
Trial #27	Detected	5289.8MHz, -61.0dBm
Trial #28	Detected	5284.8MHz, -61.0dBm
Trial #29	Detected	5279.8MHz, -61.0dBm
Trial #30	Detected	5289.8MHz, -61.0dBm

Table 127 - CU-Steady State Low-Band Long Sequence Waveform Trial#1 (Detected)						
Burst #	# Pulses	Pulse Width (us)	Chirp (MHz)	Interval 1 to 2 (us)	Interval 2 to 3 (us)	Start time (s)
1	1	87.2	15	-	-	0.511694
2	3	58.1	15	1894.0	1371.0	1.785781
3	1	96.2	19	-	-	3.187245
4	2	84.4	7	1348.0	-	3.728253
5	2	98.2	10	1590.0	-	5.196644
6	2	73.5	6	1500.0	-	6.082825
7	2	86.4	7	1380.0	-	6.790222
8	3	84.6	5	1966.0	1004.0	8.108789
9	3	96.7	19	1222.0	1968.0	9.180165
10	3	98.2	15	1977.0	1911.0	10.730615
11	2	95.0	16	1918.0	-	11.348605

Table 128 - CU-Steady State Low-Band Long Sequence Waveform Trial#2 (Detected)						
Burst #	# Pulses	Pulse Width (us)	Chirp (MHz)	Interval 1 to 2 (us)	Interval 2 to 3 (us)	Start time (s)
1	1	69.9	13	-	-	0.067177
2	2	91.8	13	1652.0	-	0.859698
3	2	71.1	15	1355.0	-	2.215745
4	1	94.4	20	-	-	2.803488
5	2	91.5	14	1773.0	-	3.475199
6	2	99.4	9	1924.0	-	4.332596
7	2	51.3	17	1224.0	-	4.586890
8	3	64.9	19	1733.0	1218.0	5.852223
9	2	81.7	17	1917.0	-	6.625927
10	3	86.6	15	1268.0	1940.0	6.983435
11	1	60.4	16	-	-	7.982195
12	2	92.2	7	1956.0	-	8.545737
13	2	90.1	20	1045.0	-	9.043409
14	3	57.1	13	1380.0	1079.0	9.956450
15	2	50.6	19	1382.0	-	10.809946
16	1	92.0	16	-	-	11.434924

<b>Table 129 - CU-Steady State Low-Band Long Sequence Waveform Trial#3 (Detected)</b>						
Burst #	# Pulses	Pulse Width (us)	Chirp (MHz)	Interval 1 to 2 (us)	Interval 2 to 3 (us)	Start time (s)
1	1	95.2	15	-	-	0.578780
2	2	99.5	17	1946.0	-	1.386402
3	2	98.5	20	1086.0	-	1.697454
4	1	62.4	6	-	-	2.466852
5	3	93.1	20	1848.0	1214.0	3.001584
6	3	63.8	6	1754.0	1426.0	3.860618
7	2	67.1	15	1610.0	-	4.589195
8	3	69.4	12	1787.0	1857.0	5.422633
9	2	55.7	6	1420.0	-	6.201202
10	2	78.1	15	1229.0	-	6.383258
11	2	60.4	13	1041.0	-	7.191667
12	3	67.2	16	1635.0	1170.0	7.991245
13	2	51.8	9	1242.0	-	9.072004
14	1	66.4	12	-	-	9.272439
15	1	86.9	18	-	-	10.256151
16	1	66.2	12	-	-	11.281449
17	2	85.3	11	1578.0	-	11.476066

<b>Table 130 - CU-Steady State Low-Band Long Sequence Waveform Trial#4 (Detected)</b>						
Burst #	# Pulses	Pulse Width (us)	Chirp (MHz)	Interval 1 to 2 (us)	Interval 2 to 3 (us)	Start time (s)
1	1	66.3	12	-	-	0.124057
2	2	71.7	10	1078.0	-	1.456548
3	2	86.2	17	1553.0	-	3.809364
4	1	82.3	11	-	-	4.066611
5	1	74.0	19	-	-	6.290069
6	1	72.8	17	-	-	6.669781
7	2	93.1	18	1052.0	-	9.091179
8	2	56.2	13	1226.0	-	9.404659
9	2	63.7	16	1643.0	-	11.416675

<b>Table 131 - CU-Steady State Low-Band Long Sequence Waveform Trial#5 (Detected)</b>						
Burst #	# Pulses	Pulse Width (us)	Chirp (MHz)	Interval 1 to 2 (us)	Interval 2 to 3 (us)	Start time (s)
1	1	74.0	15	-	-	0.802557
2	2	52.7	11	1933.0	-	2.049355
3	3	96.0	15	1204.0	1779.0	3.163399
4	2	76.5	20	1989.0	-	3.748337
5	1	56.2	16	-	-	5.992266
6	2	75.2	18	1362.0	-	6.407383
7	2	86.8	14	1592.0	-	8.227494
8	2	57.4	13	1272.0	-	8.452297
9	3	66.3	9	1418.0	1545.0	10.269374
10	2	92.9	5	1174.0	-	11.811028

<b>Table 132 - CU-Steady State Low-Band Long Sequence Waveform Trial#6 (Detected)</b>						
Burst #	# Pulses	Pulse Width (us)	Chirp (MHz)	Interval 1 to 2 (us)	Interval 2 to 3 (us)	Start time (s)
1	3	56.8	15	1454.0	1268.0	0.040263

Burst #	# Pulses	Pulse Width (us)	Chirp (MHz)	Interval 1 to 2 (us)	Interval 2 to 3 (us)	Start time (s)
2	1	89.4	14	-	-	1.555777
3	2	56.7	13	1634.0	-	2.554281
4	3	66.6	13	1186.0	1965.0	2.935570
5	1	81.5	12	-	-	3.822284
6	2	85.6	6	1852.0	-	5.290409
7	3	58.1	18	1213.0	1008.0	6.234377
8	1	68.1	17	-	-	6.966479
9	2	95.2	8	1548.0	-	8.074130
10	2	51.8	11	1526.0	-	8.639559
11	3	63.7	14	1355.0	1333.0	9.232874
12	2	71.9	13	1545.0	-	11.038222
13	1	58.4	6	-	-	11.149861

Burst #	# Pulses	Pulse Width (us)	Chirp (MHz)	Interval 1 to 2 (us)	Interval 2 to 3 (us)	Start time (s)
1	3	97.0	19	1152.0	1088.0	0.046077
2	2	98.1	6	1909.0	-	1.214616
3	3	68.7	18	1580.0	1076.0	1.479988
4	1	73.8	19	-	-	2.783973
5	1	84.0	20	-	-	3.331879
6	2	75.3	17	1088.0	-	4.112123
7	2	85.5	19	1844.0	-	4.310356
8	2	57.5	10	1324.0	-	5.405135
9	2	60.0	15	1151.0	-	6.096270
10	2	93.8	13	1271.0	-	6.930574
11	2	63.0	18	1212.0	-	7.524040
12	1	88.6	16	-	-	8.322436
13	3	71.3	12	1687.0	1567.0	8.484127
14	2	61.1	8	1329.0	-	9.752520
15	2	84.4	14	1835.0	-	10.284911
16	2	86.3	12	1539.0	-	11.184837
17	2	83.2	5	1325.0	-	11.971403

Burst #	# Pulses	Pulse Width (us)	Chirp (MHz)	Interval 1 to 2 (us)	Interval 2 to 3 (us)	Start time (s)
1	3	84.1	6	1508.0	1791.0	1.018897
2	3	85.7	13	1514.0	1013.0	1.204267
3	2	58.2	14	1795.0	-	2.462734
4	2	62.1	6	1047.0	-	3.595005
5	1	58.7	20	-	-	5.314435
6	2	74.3	18	1739.0	-	6.235364
7	3	64.0	13	1310.0	1769.0	6.855792
8	3	93.1	17	1517.0	1665.0	7.859276
9	2	59.5	16	1208.0	-	9.565292
10	2	66.2	15	1721.0	-	10.470502
11	2	90.2	20	1749.0	-	11.723441

<b>Table 135 - CU-Steady State Low-Band Long Sequence Waveform Trial#9 (Detected)</b>						
Burst #	# Pulses	Pulse Width (us)	Chirp (MHz)	Interval 1 to 2 (us)	Interval 2 to 3 (us)	Start time (s)
1	1	66.2	15	-	-	0.786215
2	2	61.8	8	1177.0	-	1.536103
3	2	83.1	16	1191.0	-	2.553571
4	3	56.5	14	1621.0	1357.0	3.188518
5	1	53.0	7	-	-	4.132780
6	2	70.6	16	1775.0	-	5.092032
7	2	98.3	8	1069.0	-	5.143243
8	3	64.9	14	1905.0	1821.0	6.032482
9	3	53.4	7	1190.0	1160.0	7.639003
10	3	50.3	7	1553.0	1265.0	8.026124
11	2	79.3	20	1199.0	-	9.155672
12	1	72.5	19	-	-	9.712700
13	2	55.9	5	1330.0	-	10.654965
14	2	59.5	9	1580.0	-	11.149566

<b>Table 136 - CU-Steady State Low-Band Long Sequence Waveform Trial#10 (Detected)</b>						
Burst #	# Pulses	Pulse Width (us)	Chirp (MHz)	Interval 1 to 2 (us)	Interval 2 to 3 (us)	Start time (s)
1	1	81.6	15	-	-	0.463892
2	2	88.3	10	1689.0	-	0.772658
3	2	84.7	15	1738.0	-	1.339347
4	2	58.4	8	1072.0	-	2.253727
5	2	53.0	17	1196.0	-	2.742777
6	1	97.5	13	-	-	3.395303
7	1	97.2	19	-	-	4.126193
8	2	78.3	11	1256.0	-	4.578811
9	3	58.1	8	1758.0	1258.0	4.850568
10	2	65.3	17	1112.0	-	5.755156
11	1	87.9	17	-	-	6.569111
12	3	98.8	13	1961.0	1496.0	6.876460
13	2	98.9	6	1493.0	-	7.709026
14	1	83.3	18	-	-	8.018432
15	1	97.3	10	-	-	8.905515
16	2	99.9	8	1353.0	-	9.201380
17	1	99.7	8	-	-	9.942457
18	2	85.5	7	1974.0	-	10.652003
19	1	68.7	7	-	-	10.989373
20	2	50.4	19	1106.0	-	11.493581

<b>Table 137 - CU-Steady State Low-Band Long Sequence Waveform Trial#11 (Detected)</b>						
Burst #	# Pulses	Pulse Width (us)	Chirp (MHz)	Interval 1 to 2 (us)	Interval 2 to 3 (us)	Start time (s)
1	2	51.7	15	1738.0	-	1.162282
2	3	57.5	7	1332.0	1174.0	1.648498
3	3	62.2	13	1323.0	1679.0	2.696666
4	2	94.9	15	1365.0	-	4.290968
5	1	97.1	16	-	-	5.708132
6	2	60.7	14	1938.0	-	6.197659
7	3	82.3	11	1535.0	1382.0	7.777530
8	3	52.4	17	1362.0	1088.0	8.993743

Burst #	# Pulses	Pulse Width (us)	Chirp (MHz)	Interval 1 to 2 (us)	Interval 2 to 3 (us)	Start time (s)
9	2	67.1	12	1800.0	-	9.764127
10	2	95.9	6	1757.0	-	10.911476

Burst #	# Pulses	Pulse Width (us)	Chirp (MHz)	Interval 1 to 2 (us)	Interval 2 to 3 (us)	Start time (s)
1	3	73.8	8	1802.0	1975.0	0.304424
2	2	95.4	7	1237.0	-	1.783739
3	2	60.5	20	1820.0	-	2.525660
4	1	53.8	7	-	-	3.358195
5	1	74.6	19	-	-	4.803457
6	2	64.9	11	1952.0	-	6.265214
7	3	59.5	6	1034.0	1783.0	6.765674
8	3	67.9	13	1055.0	1664.0	7.924071
9	3	86.9	16	1625.0	1202.0	8.740234
10	2	77.8	13	1894.0	-	10.204249
11	3	84.5	6	1062.0	1197.0	11.859884

Burst #	# Pulses	Pulse Width (us)	Chirp (MHz)	Interval 1 to 2 (us)	Interval 2 to 3 (us)	Start time (s)
1	2	68.2	15	1524.0	-	0.393483
2	1	52.9	18	-	-	0.905870
3	2	96.1	5	1038.0	-	1.291189
4	3	98.7	12	1776.0	1199.0	1.896971
5	3	73.9	19	1775.0	1132.0	2.600708
6	1	59.3	5	-	-	3.541814
7	3	79.7	8	1504.0	1060.0	3.641705
8	1	90.6	5	-	-	4.389774
9	2	57.5	10	1687.0	-	5.353239
10	1	86.0	9	-	-	5.993480
11	3	97.8	13	1769.0	1817.0	6.268549
12	1	53.5	16	-	-	6.749026
13	3	70.6	15	1839.0	1006.0	7.507417
14	3	65.9	12	1772.0	1588.0	7.991487
15	1	96.2	8	-	-	8.551702
16	1	86.2	6	-	-	9.129101
17	2	85.1	11	1102.0	-	10.064411
18	2	96.8	17	1324.0	-	10.598061
19	2	80.5	15	1673.0	-	11.070612
20	3	85.9	10	1636.0	1223.0	11.871917

Burst #	# Pulses	Pulse Width (us)	Chirp (MHz)	Interval 1 to 2 (us)	Interval 2 to 3 (us)	Start time (s)
1	3	77.7	11	1353.0	1496.0	0.358596
2	3	71.8	7	1881.0	1405.0	1.337767
3	2	77.9	15	1963.0	-	2.311651
4	2	69.9	10	1212.0	-	4.088410



<b>Table 140 - CU-Steady State Low-Band Long Sequence Waveform Trial#14 (Detected)</b>						
Burst #	# Pulses	Pulse Width (us)	Chirp (MHz)	Interval 1 to 2 (us)	Interval 2 to 3 (us)	Start time (s)
5	2	95.9	5	1640.0	-	5.101265
6	3	90.7	10	1839.0	1844.0	5.685332
7	2	84.4	10	1608.0	-	7.516367
8	1	95.3	16	-	-	8.168439
9	1	53.5	14	-	-	9.539867
10	2	81.7	7	1206.0	-	10.626543
11	1	70.6	12	-	-	11.983471

<b>Table 141 - CU-Steady State Low-Band Long Sequence Waveform Trial#15 (Detected)</b>						
Burst #	# Pulses	Pulse Width (us)	Chirp (MHz)	Interval 1 to 2 (us)	Interval 2 to 3 (us)	Start time (s)
1	2	93.9	10	1597.0	-	0.644370
2	3	59.6	6	1636.0	1935.0	1.327765
3	2	71.7	9	1058.0	-	1.617715
4	1	94.2	9	-	-	2.521400
5	2	61.5	7	1665.0	-	3.204985
6	2	75.2	8	1659.0	-	4.067494
7	3	59.3	7	1805.0	1346.0	4.521260
8	2	59.3	9	1929.0	-	5.555584
9	2	75.8	19	1262.0	-	6.021848
10	1	70.0	12	-	-	6.355981
11	1	90.8	20	-	-	7.510598
12	2	82.1	7	1704.0	-	7.990105
13	3	67.7	12	1540.0	1351.0	8.658798
14	2	96.8	17	1834.0	-	9.328064
15	2	84.4	17	1201.0	-	10.333673
16	2	95.9	14	1349.0	-	10.895118
17	2	85.9	20	1449.0	-	11.915680

<b>Table 142 - CU-Steady State Low-Band Long Sequence Waveform Trial#16 (Detected)</b>						
Burst #	# Pulses	Pulse Width (us)	Chirp (MHz)	Interval 1 to 2 (us)	Interval 2 to 3 (us)	Start time (s)
1	2	75.0	11	1739.0	-	0.248346
2	3	76.2	8	1718.0	1717.0	1.449503
3	3	56.1	10	1328.0	1328.0	2.378883
4	2	99.7	19	1182.0	-	4.311075
5	2	51.7	17	1455.0	-	4.397104
6	1	73.1	14	-	-	5.768922
7	3	92.0	18	1319.0	1242.0	7.275167
8	2	78.3	16	1894.0	-	7.776501
9	1	97.5	14	-	-	9.445021
10	2	80.6	6	1643.0	-	10.349812
11	3	62.1	7	1727.0	1250.0	11.179188

<b>Table 143 - CU-Steady State Low-Band Long Sequence Waveform Trial#17 (Detected)</b>						
Burst #	# Pulses	Pulse Width (us)	Chirp (MHz)	Interval 1 to 2 (us)	Interval 2 to 3 (us)	Start time (s)
1	3	74.1	11	1990.0	1492.0	0.183043
2	2	57.0	5	1466.0	-	1.428518

<b>Table 143 - CU-Steady State Low-Band Long Sequence Waveform Trial#17 (Detected)</b>						
Burst #	# Pulses	Pulse Width (us)	Chirp (MHz)	Interval 1 to 2 (us)	Interval 2 to 3 (us)	Start time (s)
3	2	75.6	17	1859.0	-	1.882893
4	2	57.0	17	1228.0	-	3.028033
5	1	70.6	9	-	-	3.347774
6	3	80.2	7	1666.0	1443.0	4.746427
7	1	72.9	7	-	-	5.441849
8	3	80.3	16	1983.0	1003.0	5.796989
9	3	69.5	13	1937.0	1103.0	7.187531
10	2	67.1	17	1819.0	-	7.803302
11	1	76.2	10	-	-	8.758287
12	2	54.6	18	1754.0	-	9.013997
13	2	55.0	17	1389.0	-	9.680309
14	2	64.8	15	1556.0	-	11.061133
15	2	62.8	18	1286.0	-	11.496827

<b>Table 144 - CU-Steady State Low-Band Long Sequence Waveform Trial#18 (Detected)</b>						
Burst #	# Pulses	Pulse Width (us)	Chirp (MHz)	Interval 1 to 2 (us)	Interval 2 to 3 (us)	Start time (s)
1	2	77.1	13	1351.0	-	0.390683
2	1	88.2	10	-	-	1.625423
3	2	95.1	13	1198.0	-	2.412268
4	3	92.1	15	1672.0	1896.0	3.399139
5	2	65.3	11	1935.0	-	4.500073
6	2	65.5	8	1957.0	-	5.459012
7	2	68.4	8	1055.0	-	5.731662
8	2	50.8	16	1591.0	-	7.033150
9	1	73.1	16	-	-	7.759632
10	2	78.7	5	1758.0	-	9.178936
11	2	75.7	17	1893.0	-	9.883581
12	1	94.5	19	-	-	10.909531
13	1	64.1	14	-	-	11.504107

<b>Table 145 - CU-Steady State Low-Band Long Sequence Waveform Trial#19 (Detected)</b>						
Burst #	# Pulses	Pulse Width (us)	Chirp (MHz)	Interval 1 to 2 (us)	Interval 2 to 3 (us)	Start time (s)
1	3	73.8	15	1193.0	1020.0	0.022587
2	1	83.8	6	-	-	1.592785
3	2	90.0	8	1550.0	-	2.951537
4	2	83.2	10	1813.0	-	3.962910
5	1	65.6	16	-	-	4.802761
6	2	55.1	15	1310.0	-	5.030531
7	3	95.1	20	1918.0	1016.0	6.043787
8	2	74.1	11	1878.0	-	7.592774
9	2	96.7	17	1609.0	-	8.334678
10	1	98.5	17	-	-	9.941843
11	2	83.7	6	1276.0	-	10.771546
12	2	64.2	14	1736.0	-	11.585150

<b>Table 146 - CU-Steady State Low-Band Long Sequence Waveform Trial#20 (Detected)</b>						
--	--	--	--	--	--	--

Burst #	# Pulses	Pulse Width (us)	Chirp (MHz)	Interval 1 to 2 (us)	Interval 2 to 3 (us)	Start time (s)
1	1	57.2	9	-	-	0.658429
2	1	69.0	14	-	-	1.834480
3	2	60.6	18	1978.0	-	2.491041
4	2	52.3	7	1517.0	-	2.852758
5	2	76.9	11	1520.0	-	3.923929
6	1	75.0	15	-	-	4.989275
7	3	79.3	16	1323.0	1905.0	6.353340
8	3	99.4	20	1851.0	1519.0	6.690548
9	2	70.7	16	1433.0	-	7.806939
10	1	59.2	13	-	-	8.350067
11	2	57.7	9	1342.0	-	9.762168
12	2	91.9	10	1874.0	-	10.182433
13	2	94.5	11	1511.0	-	11.817197

**Table 147 - CU-Steady State Low-Band Long Sequence Waveform Trial#21 (Detected)**

Burst #	# Pulses	Pulse Width (us)	Chirp (MHz)	Interval 1 to 2 (us)	Interval 2 to 3 (us)	Start time (s)
1	2	94.8	10	1808.0	-	1.039663
2	1	59.4	14	-	-	2.225072
3	1	83.8	15	-	-	3.584101
4	2	95.9	17	1784.0	-	4.520883
5	2	50.5	7	1508.0	-	5.020117
6	1	80.7	20	-	-	6.407494
7	2	78.1	16	1572.0	-	7.904504
8	3	71.9	14	1205.0	1143.0	9.422099
9	2	60.1	12	1593.0	-	9.934673
10	3	84.3	15	1548.0	1355.0	11.615464

**Table 148 - CU-Steady State Low-Band Long Sequence Waveform Trial#22 (Detected)**

Burst #	# Pulses	Pulse Width (us)	Chirp (MHz)	Interval 1 to 2 (us)	Interval 2 to 3 (us)	Start time (s)
1	3	57.2	10	1138.0	1148.0	0.369596
2	3	50.1	19	1807.0	1251.0	1.905578
3	1	69.4	13	-	-	4.209547
4	2	87.4	6	1110.0	-	4.544062
5	3	69.4	18	1483.0	1399.0	6.926839
6	3	74.4	18	1724.0	1768.0	8.398396
7	2	95.7	16	1823.0	-	9.768442
8	3	98.6	17	1193.0	1136.0	11.011558

**Table 149 - CU-Steady State Low-Band Long Sequence Waveform Trial#23 (Detected)**

Burst #	# Pulses	Pulse Width (us)	Chirp (MHz)	Interval 1 to 2 (us)	Interval 2 to 3 (us)	Start time (s)
1	1	84.5	6	-	-	0.858340
2	2	62.2	9	1601.0	-	1.202947
3	3	93.0	11	1483.0	1408.0	2.476268
4	3	68.7	6	1163.0	1122.0	3.016082
5	3	53.9	17	1173.0	1984.0	4.212911
6	1	89.1	12	-	-	5.876141
7	1	71.7	6	-	-	6.502892
8	3	88.2	9	1369.0	1360.0	7.885767

Burst #	# Pulses	Pulse Width (us)	Chirp (MHz)	Interval 1 to 2 (us)	Interval 2 to 3 (us)	Start time (s)
9	2	82.6	13	1500.0	-	8.807793
10	1	63.2	10	-	-	9.906764
11	2	66.6	9	1861.0	-	10.666956
12	1	60.9	10	-	-	11.575247

Burst #	# Pulses	Pulse Width (us)	Chirp (MHz)	Interval 1 to 2 (us)	Interval 2 to 3 (us)	Start time (s)
1	3	63.1	19	1830.0	1567.0	0.203753
2	2	86.1	6	1321.0	-	1.144904
3	1	67.6	15	-	-	1.796583
4	2	55.6	13	1596.0	-	2.417442
5	3	86.1	11	1984.0	1931.0	3.400889
6	3	78.0	14	1291.0	1102.0	4.137293
7	2	99.0	8	1716.0	-	4.619573
8	3	59.1	10	1168.0	1380.0	5.929600
9	2	68.7	19	1931.0	-	6.349231
10	1	80.6	15	-	-	6.942550
11	2	65.1	8	1923.0	-	8.202181
12	1	60.6	12	-	-	8.480110
13	2	69.2	14	1770.0	-	9.454830
14	1	56.4	10	-	-	9.857821
15	1	51.3	14	-	-	10.791189
16	2	79.2	18	1368.0	-	11.707554

Burst #	# Pulses	Pulse Width (us)	Chirp (MHz)	Interval 1 to 2 (us)	Interval 2 to 3 (us)	Start time (s)
1	3	53.5	17	1459.0	1275.0	0.695673
2	1	85.8	10	-	-	1.774967
3	2	76.4	20	1199.0	-	2.027369
4	2	56.5	15	1337.0	-	2.891530
5	2	86.4	17	1578.0	-	4.448780
6	2	60.3	16	1260.0	-	5.096312
7	3	63.1	6	1625.0	1805.0	5.674781
8	3	93.8	9	1825.0	1582.0	6.639613
9	1	51.3	20	-	-	7.937472
10	3	64.2	16	1553.0	1972.0	9.046122
11	2	83.2	19	1476.0	-	9.416740
12	2	65.2	12	1312.0	-	10.517292
13	3	93.4	11	1987.0	1177.0	11.834342

Burst #	# Pulses	Pulse Width (us)	Chirp (MHz)	Interval 1 to 2 (us)	Interval 2 to 3 (us)	Start time (s)
1	1	73.2	17	-	-	0.834130
2	1	56.0	9	-	-	1.356368
3	2	81.4	10	1460.0	-	2.027443
4	2	89.2	13	1354.0	-	3.157039

Burst #	# Pulses	Pulse Width (us)	Chirp (MHz)	Interval 1 to 2 (us)	Interval 2 to 3 (us)	Start time (s)
5	3	98.9	17	1191.0	1796.0	4.930206
6	2	95.3	5	1588.0	-	5.104446
7	1	92.5	15	-	-	6.170731
8	2	93.4	10	1967.0	-	7.289868
9	3	85.3	17	1073.0	1254.0	8.789562
10	3	71.3	11	1793.0	1170.0	9.187774
11	2	64.5	8	1548.0	-	10.846451
12	3	92.2	6	1259.0	1664.0	11.582539

Burst #	# Pulses	Pulse Width (us)	Chirp (MHz)	Interval 1 to 2 (us)	Interval 2 to 3 (us)	Start time (s)
1	2	78.6	12	1038.0	-	0.041518
2	2	56.6	10	1397.0	-	0.956152
3	2	76.2	7	1299.0	-	1.375744
4	3	58.7	13	1110.0	1347.0	2.210287
5	3	53.5	14	1670.0	1676.0	3.110643
6	3	75.7	12	1764.0	1724.0	3.171359
7	1	98.8	14	-	-	4.127687
8	1	62.8	19	-	-	4.742278
9	1	88.7	11	-	-	5.135234
10	1	74.4	12	-	-	6.119601
11	1	78.3	8	-	-	6.540824
12	1	90.7	16	-	-	7.517603
13	3	55.0	17	1072.0	1609.0	7.693034
14	3	78.1	13	1142.0	1967.0	8.794573
15	2	94.3	9	1625.0	-	9.165251
16	1	69.5	14	-	-	10.042271
17	2	66.3	6	1673.0	-	10.284890
18	2	62.4	19	1854.0	-	10.814034
19	1	58.5	15	-	-	11.989227

Burst #	# Pulses	Pulse Width (us)	Chirp (MHz)	Interval 1 to 2 (us)	Interval 2 to 3 (us)	Start time (s)
1	2	94.9	16	1927.0	-	0.341147
2	2	62.9	7	1915.0	-	1.212443
3	2	98.3	6	1509.0	-	1.609499
4	2	75.5	14	1390.0	-	3.121791
5	1	83.7	10	-	-	3.241433
6	1	79.5	10	-	-	4.427526
7	2	74.0	8	1636.0	-	5.438758
8	2	76.5	18	1800.0	-	5.759253
9	1	82.2	14	-	-	6.664828
10	2	59.8	16	1488.0	-	7.983587
11	3	81.5	17	1255.0	1555.0	8.034807
12	1	99.6	19	-	-	9.057257
13	2	69.5	5	1564.0	-	10.348699
14	2	66.4	16	1579.0	-	11.195650
15	2	73.3	15	1875.0	-	11.905835

Burst #	# Pulses	Pulse Width (us)	Chirp (MHz)	Interval 1 to 2 (us)	Interval 2 to 3 (us)	Start time (s)
1	1	76.9	16	-	-	0.511743
2	2	72.5	16	1212.0	-	1.042802
3	2	75.3	11	1263.0	-	1.632916
4	2	52.7	14	1862.0	-	2.080723
5	2	56.9	16	1323.0	-	2.753230
6	1	54.5	14	-	-	3.650555
7	2	75.6	18	1292.0	-	3.841697
8	3	95.5	18	1397.0	1049.0	4.714275
9	3	52.6	18	1848.0	1189.0	5.278260
10	2	52.4	5	1455.0	-	5.915481
11	2	68.2	13	1756.0	-	6.826193
12	3	72.9	17	1088.0	1848.0	7.440711
13	2	98.9	6	1850.0	-	8.079372
14	2	80.7	7	1043.0	-	8.751729
15	3	78.9	17	1502.0	1246.0	8.996150
16	3	92.7	7	1429.0	1310.0	9.481093
17	2	93.0	18	1565.0	-	10.236337
18	2	53.4	14	1427.0	-	10.773999
19	1	67.8	10	-	-	11.830221

Burst #	# Pulses	Pulse Width (us)	Chirp (MHz)	Interval 1 to 2 (us)	Interval 2 to 3 (us)	Start time (s)
1	2	77.0	6	1497.0	-	0.400837
2	2	64.1	8	1042.0	-	1.491920
3	2	76.5	5	1673.0	-	2.340079
4	2	84.0	11	1477.0	-	2.784004
5	1	63.9	10	-	-	3.274193
6	1	83.8	11	-	-	4.242059
7	2	57.6	12	1063.0	-	5.552758
8	2	98.7	8	1810.0	-	5.937997
9	1	63.0	17	-	-	7.175379
10	1	58.6	8	-	-	7.719130
11	1	57.0	14	-	-	8.122134
12	3	82.5	20	1001.0	1808.0	9.426958
13	2	89.3	6	1601.0	-	10.218038
14	1	86.3	19	-	-	10.662994
15	3	93.3	12	1150.0	1730.0	11.363588

Trial #	Pulses/Burst	Pulse Width (us)	PRI (us)	Detected	Fr (MHz) and level (dBm)	Burst Information
---------	--------------	------------------	----------	----------	--------------------------	-------------------

Table 157 - FCC frequency hopping radar (Type 6) Results CU-Steady State Low-Band						
Trial #	Pulses/ Burst	Pulse Width (us)	PRI (us)	Detected	Fr (MHz) and level (dBm)	Burst Information
1	9	1.0	333.0	Yes	5294.8MHz, -61.0dBm	Hop sequence: 5638, 5575, 5351, 5291, 5337, 5648, 5665, 5720, 5641, 5583, 5683, 5724, 5458, 5346, 5528, 5601, 5494, 5640, 5363, 5593, 5376, 5294, 5668, 5260, 5457, 5571, 5572, 5584, 5422, 5387, 5506, 5339, 5331, 5504, 5334, 5718, 5658, 5549, 5395, 5622, 5558, 5695, 5685, 5444, 5465, 5687, 5420, 5589, 5632, 5596, 5367, 5385, 5300, 5443, 5699, 5474, 5374, 5688, 5535, 5559, 5464, 5315, 5541, 5449, 5647, 5322, 5312, 5629, 5365, 5595, 5677, 5662, 5341, 5604, 5371, 5709, 5318, 5499, 5557, 5678, 5649, 5347, 5307, 5412, 5381, 5287, 5537, 5357, 5319, 5545, 5483, 5353, 5680, 5394, 5433, 5663, 5704, 5368, 5643, 5599 (3 hits) (11/19/2012 05:58:38 PM)
2	9	1.0	333.0	Yes	5295.8MHz, -61.0dBm	Hop sequence: 5360, 5370, 5452, 5662, 5673, 5685, 5578, 5426, 5463, 5696, 5567, 5412, 5277, 5333, 5312, 5269, 5573, 5518, 5267, 5633, 5453, 5644, 5457, 5343, 5630, 5713, 5459, 5365, 5316, 5324, 5305, 5601, 5716, 5610, 5392, 5374, 5549, 5434, 5355, 5537, 5581, 5647, 5509, 5279, 5366, 5271, 5320, 5386, 5521, 5599, 5348, 5476, 5560, 5450, 5326, 5265, 5417, 5540, 5629, 5606, 5626, 5395, 5678, 5568, 5404, 5387, 5701, 5383, 5603, 5594, 5261, 5648, 5676, 5257, 5639, 5658, 5571, 5414, 5318, 5598, 5416, 5445, 5675, 5527, 5435, 5632, 5317, 5595, 5660, 5525, 5280, 5358, 5421, 5391, 5336, 5456, 5465, 5661, 5719, 5372 (3 hits) (11/19/2012 05:58:47 PM)

Table 157 - FCC frequency hopping radar (Type 6) Results CU-Steady State Low-Band						
Trial #	Pulses/ Burst	Pulse Width (us)	PRI (us)	Detected	Fr (MHz) and level (dBm)	Burst Information
3	9	1.0	333.0	Yes	5273.8MHz, -61.0dBm	Hop sequence: 5346, 5671, 5492, 5695, 5341, 5566, 5674, 5290, 5487, 5639, 5273, 5368, 5347, 5441, 5425, 5581, 5334, 5257, 5429, 5605, 5464, 5715, 5705, 5305, 5543, 5407, 5411, 5431, 5428, 5371, 5610, 5536, 5574, 5422, 5398, 5268, 5684, 5447, 5628, 5544, 5522, 5523, 5500, 5298, 5393, 5401, 5262, 5264, 5718, 5497, 5300, 5274, 5494, 5607, 5271, 5421, 5558, 5608, 5458, 5498, 5496, 5446, 5589, 5578, 5545, 5708, 5479, 5594, 5284, 5596, 5723, 5460, 5570, 5675, 5688, 5403, 5632, 5382, 5595, 5310, 5621, 5571, 5508, 5311, 5355, 5410, 5312, 5480, 5553, 5391, 5472, 5330, 5356, 5539, 5375, 5399, 5474, 5281, 5692, 5637 (4 hits) (11/19/2012 05:58:54 PM)
4	9	1.0	333.0	Yes	5274.8MHz, -61.0dBm	Hop sequence: 5519, 5344, 5387, 5421, 5356, 5655, 5694, 5717, 5413, 5480, 5298, 5539, 5353, 5328, 5624, 5258, 5428, 5683, 5263, 5471, 5439, 5590, 5678, 5715, 5441, 5609, 5675, 5504, 5270, 5526, 5464, 5618, 5347, 5451, 5544, 5650, 5550, 5517, 5482, 5648, 5430, 5638, 5593, 5455, 5416, 5582, 5644, 5397, 5462, 5604, 5334, 5446, 5456, 5375, 5527, 5584, 5278, 5695, 5647, 5542, 5373, 5556, 5595, 5688, 5649, 5415, 5718, 5636, 5643, 5572, 5275, 5301, 5603, 5509, 5600, 5340, 5322, 5467, 5339, 5589, 5521, 5378, 5617, 5372, 5497, 5541, 5327, 5414, 5422, 5466, 5632, 5622, 5587, 5633, 5319, 5716, 5443, 5671, 5304, 5259 (2 hits) (11/19/2012 05:59:01 PM)



Table 157 - FCC frequency hopping radar (Type 6) Results CU-Steady State Low-Band						
Trial #	Pulses/ Burst	Pulse Width (us)	PRI (us)	Detected	Fr (MHz) and level (dBm)	Burst Information
5	9	1.0	333.0	Yes	5275.8MHz, -61.0dBm	Hop sequence: 5562, 5449, 5620, 5667, 5475, 5440, 5413, 5388, 5632, 5345, 5316, 5336, 5424, 5642, 5399, 5686, 5426, 5624, 5725, 5605, 5594, 5366, 5568, 5658, 5657, 5396, 5433, 5577, 5569, 5695, 5421, 5625, 5340, 5530, 5270, 5311, 5601, 5492, 5602, 5404, 5579, 5509, 5607, 5456, 5508, 5482, 5623, 5281, 5427, 5582, 5678, 5534, 5513, 5634, 5444, 5376, 5532, 5589, 5545, 5452, 5604, 5537, 5525, 5481, 5693, 5272, 5575, 5499, 5652, 5647, 5511, 5405, 5663, 5410, 5418, 5422, 5654, 5428, 5455, 5377, 5703, 5591, 5706, 5637, 5416, 5356, 5659, 5454, 5310, 5264, 5533, 5502, 5493, 5645, 5474, 5592, 5430, 5471, 5538, 5718 (1 hits) (11/19/2012 05:59:09 PM)
6	9	1.0	333.0	Yes	5276.8MHz, -61.0dBm	Hop sequence: 5676, 5404, 5600, 5500, 5470, 5461, 5632, 5298, 5445, 5385, 5443, 5255, 5324, 5678, 5711, 5475, 5310, 5722, 5465, 5577, 5644, 5439, 5524, 5488, 5474, 5514, 5252, 5356, 5405, 5466, 5485, 5591, 5606, 5427, 5483, 5550, 5395, 5511, 5545, 5583, 5596, 5571, 5585, 5347, 5382, 5323, 5498, 5718, 5349, 5714, 5366, 5436, 5350, 5314, 5655, 5409, 5484, 5605, 5322, 5669, 5379, 5284, 5568, 5408, 5528, 5458, 5597, 5664, 5400, 5590, 5658, 5333, 5699, 5555, 5386, 5371, 5536, 5359, 5426, 5336, 5674, 5630, 5377, 5534, 5646, 5354, 5390, 5530, 5613, 5642, 5721, 5720, 5448, 5367, 5441, 5389, 5501, 5645, 5580, 5704 (1 hits) (11/19/2012 05:59:17 PM)

Table 157 - FCC frequency hopping radar (Type 6) Results CU-Steady State Low-Band						
Trial #	Pulses/ Burst	Pulse Width (us)	PRI (us)	Detected	Fr (MHz) and level (dBm)	Burst Information
7	9	1.0	333.0	Yes	5277.8MHz, -61.0dBm	Hop sequence: 5334, 5649, 5394, 5399, 5487, 5405, 5540, 5427, 5264, 5412, 5392, 5562, 5410, 5709, 5335, 5671, 5716, 5700, 5642, 5447, 5590, 5544, 5591, 5550, 5428, 5408, 5717, 5703, 5588, 5512, 5579, 5355, 5615, 5563, 5448, 5647, 5477, 5368, 5446, 5293, 5371, 5406, 5509, 5596, 5451, 5322, 5297, 5459, 5476, 5528, 5472, 5526, 5606, 5370, 5628, 5502, 5515, 5572, 5611, 5678, 5541, 5307, 5565, 5560, 5668, 5398, 5569, 5533, 5465, 5374, 5319, 5466, 5520, 5366, 5582, 5711, 5375, 5552, 5605, 5299, 5401, 5253, 5474, 5626, 5635, 5302, 5365, 5429, 5385, 5455, 5332, 5632, 5484, 5386, 5501, 5510, 5445, 5351, 5503, 5360 (1 hits) (11/19/2012 05:59:26 PM)
8	9	1.0	333.0	Yes	5278.8MHz, -61.0dBm	Hop sequence: 5690, 5307, 5364, 5655, 5299, 5551, 5717, 5277, 5251, 5505, 5618, 5611, 5278, 5531, 5421, 5480, 5605, 5512, 5471, 5636, 5275, 5521, 5386, 5294, 5306, 5665, 5289, 5292, 5380, 5667, 5333, 5436, 5272, 5325, 5264, 5444, 5642, 5367, 5700, 5673, 5448, 5336, 5385, 5658, 5575, 5695, 5519, 5284, 5267, 5569, 5470, 5513, 5635, 5492, 5662, 5627, 5511, 5493, 5260, 5663, 5309, 5640, 5506, 5450, 5314, 5582, 5574, 5426, 5557, 5265, 5552, 5615, 5502, 5372, 5483, 5411, 5525, 5320, 5452, 5594, 5527, 5621, 5402, 5462, 5723, 5263, 5274, 5467, 5708, 5624, 5577, 5345, 5503, 5606, 5629, 5647, 5614, 5701, 5589, 5616 (8 hits) (11/19/2012 05:59:33 PM)

Table 157 - FCC frequency hopping radar (Type 6) Results CU-Steady State Low-Band						
Trial #	Pulses/ Burst	Pulse Width (us)	PRI (us)	Detected	Fr (MHz) and level (dBm)	Burst Information
9	9	1.0	333.0	Yes	5279.8MHz, -61.0dBm	Hop sequence: 5259, 5467, 5287, 5372, 5626, 5343, 5545, 5697, 5706, 5393, 5359, 5318, 5519, 5533, 5401, 5358, 5669, 5620, 5445, 5557, 5701, 5278, 5376, 5277, 5512, 5480, 5331, 5256, 5567, 5559, 5423, 5645, 5363, 5308, 5477, 5518, 5494, 5654, 5655, 5575, 5552, 5563, 5305, 5253, 5320, 5720, 5409, 5611, 5451, 5370, 5537, 5532, 5597, 5505, 5692, 5648, 5591, 5511, 5399, 5298, 5279, 5592, 5487, 5588, 5602, 5403, 5280, 5640, 5687, 5339, 5529, 5397, 5716, 5350, 5627, 5495, 5653, 5398, 5670, 5635, 5646, 5341, 5573, 5677, 5500, 5548, 5395, 5683, 5444, 5562, 5587, 5461, 5337, 5682, 5406, 5498, 5503, 5554, 5252, 5283 (6 hits) (11/19/2012 05:59:44 PM)
10	9	1.0	333.0	Yes	5280.8MHz, -61.0dBm	Hop sequence: 5337, 5421, 5546, 5330, 5484, 5596, 5511, 5620, 5528, 5370, 5478, 5320, 5487, 5584, 5258, 5661, 5629, 5316, 5600, 5602, 5681, 5624, 5535, 5394, 5630, 5578, 5601, 5373, 5263, 5592, 5302, 5673, 5319, 5353, 5443, 5720, 5295, 5567, 5300, 5682, 5548, 5543, 5270, 5366, 5509, 5649, 5550, 5269, 5692, 5525, 5285, 5318, 5439, 5449, 5463, 5310, 5716, 5472, 5398, 5356, 5385, 5555, 5338, 5557, 5383, 5677, 5713, 5363, 5323, 5531, 5254, 5448, 5585, 5436, 5273, 5465, 5391, 5622, 5328, 5547, 5289, 5590, 5502, 5537, 5670, 5433, 5390, 5266, 5494, 5524, 5518, 5275, 5707, 5559, 5689, 5251, 5504, 5662, 5284, 5664 (5 hits) (11/19/2012 05:59:51 PM)

Table 157 - FCC frequency hopping radar (Type 6) Results CU-Steady State Low-Band						
Trial #	Pulses/ Burst	Pulse Width (us)	PRI (us)	Detected	Fr (MHz) and level (dBm)	Burst Information
11	9	1.0	333.0	Yes	5281.8MHz, -61.0dBm	Hop sequence: 5566, 5517, 5469, 5303, 5667, 5609, 5477, 5544, 5713, 5505, 5588, 5274, 5412, 5413, 5401, 5658, 5530, 5492, 5302, 5630, 5427, 5397, 5454, 5447, 5295, 5376, 5610, 5378, 5404, 5277, 5333, 5434, 5605, 5603, 5309, 5441, 5308, 5619, 5613, 5470, 5435, 5306, 5353, 5599, 5698, 5265, 5345, 5584, 5552, 5506, 5312, 5476, 5481, 5269, 5398, 5540, 5335, 5551, 5709, 5521, 5688, 5578, 5697, 5674, 5541, 5444, 5518, 5300, 5527, 5291, 5563, 5419, 5374, 5513, 5443, 5437, 5712, 5325, 5684, 5711, 5547, 5482, 5701, 5721, 5472, 5464, 5562, 5520, 5659, 5724, 5590, 5550, 5461, 5432, 5408, 5564, 5504, 5446, 5607, 5666 (4 hits) (11/19/2012 05:59:58 PM)
12	9	1.0	333.0	Yes	5282.8MHz, -61.0dBm	Hop sequence: 5632, 5685, 5279, 5502, 5582, 5513, 5411, 5634, 5686, 5373, 5720, 5272, 5702, 5331, 5566, 5693, 5577, 5385, 5288, 5396, 5531, 5409, 5537, 5581, 5435, 5591, 5317, 5623, 5413, 5644, 5463, 5377, 5567, 5524, 5329, 5613, 5256, 5262, 5442, 5260, 5330, 5265, 5287, 5336, 5478, 5657, 5337, 5638, 5705, 5616, 5462, 5276, 5574, 5294, 5365, 5589, 5571, 5603, 5346, 5699, 5617, 5283, 5611, 5560, 5494, 5320, 5269, 5624, 5622, 5458, 5466, 5641, 5667, 5712, 5407, 5503, 5341, 5509, 5252, 5378, 5520, 5357, 5486, 5353, 5355, 5498, 5650, 5664, 5399, 5403, 5491, 5515, 5628, 5461, 5437, 5356, 5698, 5333, 5416, 5402 (6 hits) (11/19/2012 06:00:13 PM)

Table 157 - FCC frequency hopping radar (Type 6) Results CU-Steady State Low-Band						
Trial #	Pulses/ Burst	Pulse Width (us)	PRI (us)	Detected	Fr (MHz) and level (dBm)	Burst Information
13	9	1.0	333.0	Yes	5283.8MHz, -61.0dBm	Hop sequence: 5302, 5460, 5333, 5639, 5499, 5485, 5286, 5363, 5322, 5686, 5372, 5654, 5287, 5530, 5638, 5513, 5381, 5276, 5452, 5536, 5491, 5695, 5458, 5677, 5576, 5672, 5495, 5676, 5254, 5466, 5380, 5375, 5561, 5340, 5627, 5473, 5518, 5470, 5656, 5547, 5314, 5351, 5347, 5637, 5296, 5268, 5670, 5570, 5365, 5377, 5451, 5475, 5687, 5642, 5343, 5562, 5646, 5357, 5430, 5632, 5390, 5544, 5285, 5255, 5329, 5706, 5494, 5345, 5648, 5546, 5545, 5416, 5267, 5449, 5715, 5471, 5502, 5403, 5713, 5608, 5341, 5560, 5408, 5564, 5388, 5354, 5364, 5559, 5379, 5273, 5662, 5468, 5517, 5541, 5297, 5616, 5563, 5355, 5300, 5633 (4 hits) (11/19/2012 06:00:21 PM)
14	9	1.0	333.0	Yes	5284.8MHz, -61.0dBm	Hop sequence: 5526, 5406, 5504, 5621, 5439, 5361, 5334, 5593, 5287, 5534, 5311, 5438, 5253, 5586, 5371, 5387, 5433, 5710, 5456, 5310, 5711, 5402, 5428, 5269, 5578, 5704, 5386, 5452, 5485, 5629, 5317, 5565, 5662, 5486, 5473, 5299, 5542, 5692, 5454, 5280, 5567, 5378, 5300, 5719, 5545, 5606, 5482, 5481, 5653, 5392, 5431, 5470, 5450, 5599, 5254, 5384, 5463, 5351, 5444, 5427, 5614, 5557, 5709, 5346, 5521, 5251, 5702, 5411, 5323, 5722, 5656, 5336, 5256, 5633, 5347, 5496, 5561, 5510, 5506, 5584, 5477, 5307, 5661, 5434, 5268, 5266, 5518, 5333, 5294, 5550, 5350, 5615, 5581, 5605, 5632, 5352, 5464, 5445, 5430, 5396 (3 hits) (11/19/2012 06:00:28 PM)

Table 157 - FCC frequency hopping radar (Type 6) Results CU-Steady State Low-Band						
Trial #	Pulses/ Burst	Pulse Width (us)	PRI (us)	Detected	Fr (MHz) and level (dBm)	Burst Information
15	9	1.0	333.0	Yes	5285.8MHz, -61.0dBm	Hop sequence: 5545, 5653, 5282, 5636, 5394, 5712, 5531, 5479, 5633, 5602, 5643, 5366, 5258, 5581, 5640, 5298, 5382, 5687, 5617, 5444, 5448, 5494, 5433, 5277, 5353, 5489, 5666, 5261, 5371, 5502, 5542, 5412, 5385, 5462, 5352, 5257, 5427, 5453, 5332, 5468, 5630, 5538, 5454, 5680, 5585, 5429, 5269, 5629, 5572, 5628, 5609, 5668, 5597, 5361, 5356, 5711, 5516, 5562, 5304, 5418, 5540, 5401, 5434, 5618, 5623, 5662, 5619, 5319, 5276, 5334, 5534, 5590, 5313, 5420, 5546, 5710, 5724, 5455, 5610, 5260, 5374, 5527, 5474, 5445, 5415, 5649, 5522, 5471, 5721, 5656, 5373, 5526, 5416, 5285, 5689, 5419, 5682, 5478, 5459, 5375 (4 hits) (11/19/2012 06:00:38 PM)
16	9	1.0	333.0	Yes	5286.8MHz, -61.0dBm	Hop sequence: 5593, 5579, 5539, 5536, 5477, 5324, 5513, 5494, 5651, 5658, 5282, 5618, 5347, 5267, 5504, 5625, 5659, 5522, 5335, 5311, 5688, 5631, 5389, 5254, 5465, 5343, 5256, 5699, 5341, 5426, 5645, 5409, 5418, 5334, 5683, 5269, 5705, 5372, 5312, 5471, 5711, 5502, 5284, 5275, 5488, 5652, 5414, 5547, 5350, 5377, 5516, 5681, 5415, 5562, 5394, 5527, 5641, 5274, 5479, 5437, 5387, 5302, 5532, 5318, 5555, 5391, 5469, 5633, 5677, 5251, 5714, 5650, 5609, 5403, 5637, 5384, 5656, 5657, 5421, 5706, 5445, 5404, 5638, 5553, 5417, 5675, 5316, 5567, 5411, 5294, 5260, 5356, 5632, 5451, 5413, 5279, 5277, 5482, 5492, 5687 (7 hits) (11/19/2012 06:00:45 PM)

Table 157 - FCC frequency hopping radar (Type 6) Results CU-Steady State Low-Band						
Trial #	Pulses/ Burst	Pulse Width (us)	PRI (us)	Detected	Fr (MHz) and level (dBm)	Burst Information
17	9	1.0	333.0	Yes	5287.8MHz, -61.0dBm	Hop sequence: 5570, 5360, 5668, 5371, 5653, 5403, 5487, 5423, 5648, 5644, 5698, 5318, 5717, 5704, 5635, 5359, 5720, 5538, 5459, 5660, 5256, 5382, 5250, 5291, 5634, 5525, 5721, 5521, 5441, 5633, 5460, 5656, 5629, 5284, 5632, 5681, 5666, 5511, 5507, 5701, 5506, 5269, 5404, 5393, 5307, 5320, 5448, 5370, 5611, 5465, 5383, 5651, 5314, 5615, 5417, 5492, 5293, 5476, 5473, 5683, 5311, 5712, 5670, 5555, 5623, 5401, 5275, 5556, 5369, 5377, 5673, 5512, 5638, 5513, 5385, 5262, 5622, 5298, 5295, 5304, 5282, 5607, 5253, 5711, 5297, 5664, 5279, 5708, 5559, 5281, 5258, 5259, 5340, 5674, 5553, 5439, 5631, 5541, 5319, 5493 (8 hits) (11/19/2012 06:00:53 PM)
18	9	1.0	333.0	Yes	5288.8MHz, -61.0dBm	Hop sequence: 5373, 5609, 5484, 5522, 5631, 5375, 5321, 5473, 5691, 5292, 5309, 5347, 5502, 5578, 5253, 5278, 5583, 5296, 5532, 5418, 5627, 5506, 5468, 5481, 5315, 5456, 5536, 5365, 5444, 5495, 5722, 5713, 5352, 5398, 5298, 5316, 5537, 5678, 5563, 5441, 5667, 5498, 5425, 5453, 5719, 5598, 5367, 5358, 5467, 5378, 5304, 5717, 5451, 5265, 5681, 5607, 5311, 5590, 5274, 5553, 5519, 5411, 5562, 5440, 5428, 5621, 5679, 5615, 5574, 5286, 5589, 5317, 5639, 5269, 5452, 5416, 5257, 5471, 5283, 5392, 5549, 5557, 5344, 5604, 5386, 5499, 5328, 5610, 5540, 5509, 5374, 5395, 5560, 5349, 5603, 5626, 5335, 5371, 5258, 5339 (5 hits) (11/19/2012 06:01:01 PM)

<b>Table 157 - FCC frequency hopping radar (Type 6) Results CU-Steady State Low-Band</b>						
Trial #	Pulses/ Burst	Pulse Width (us)	PRI (us)	Detected	Fr (MHz) and level (dBm)	Burst Information
19	9	1.0	333.0	Yes	5289.8MHz, -61.0dBm	Hop sequence: 5618, 5509, 5492, 5476, 5381, 5512, 5421, 5345, 5506, 5606, 5673, 5298, 5720, 5701, 5255, 5686, 5366, 5277, 5430, 5676, 5397, 5646, 5559, 5495, 5432, 5388, 5315, 5396, 5478, 5704, 5260, 5684, 5653, 5286, 5404, 5273, 5542, 5724, 5373, 5460, 5359, 5632, 5374, 5339, 5317, 5560, 5531, 5611, 5568, 5710, 5350, 5389, 5279, 5642, 5670, 5513, 5655, 5706, 5711, 5709, 5354, 5689, 5666, 5470, 5280, 5296, 5473, 5336, 5556, 5325, 5507, 5468, 5375, 5411, 5465, 5505, 5314, 5328, 5253, 5595, 5661, 5304, 5265, 5677, 5334, 5696, 5368, 5586, 5550, 5455, 5316, 5299, 5303, 5693, 5656, 5393, 5493, 5508, 5441, 5481 (4 hits) (11/19/2012 06:01:08 PM)
20	9	1.0	333.0	Yes	5290.8MHz, -61.0dBm	Hop sequence: 5656, 5584, 5401, 5645, 5340, 5473, 5371, 5594, 5694, 5414, 5471, 5395, 5484, 5716, 5591, 5504, 5529, 5438, 5680, 5626, 5453, 5320, 5631, 5428, 5309, 5535, 5479, 5429, 5633, 5319, 5289, 5548, 5466, 5354, 5359, 5613, 5590, 5263, 5670, 5300, 5493, 5411, 5637, 5659, 5490, 5494, 5654, 5474, 5435, 5314, 5444, 5566, 5285, 5283, 5714, 5684, 5482, 5291, 5574, 5662, 5608, 5266, 5343, 5658, 5328, 5446, 5618, 5306, 5517, 5602, 5342, 5614, 5469, 5664, 5587, 5362, 5510, 5644, 5722, 5636, 5418, 5567, 5634, 5257, 5665, 5312, 5353, 5578, 5547, 5603, 5616, 5386, 5640, 5600, 5496, 5692, 5682, 5564, 5551, 5350 (4 hits) (11/19/2012 06:01:15 PM)



Table 157 - FCC frequency hopping radar (Type 6) Results CU-Steady State Low-Band						
Trial #	Pulses/ Burst	Pulse Width (us)	PRI (us)	Detected	Fr (MHz) and level (dBm)	Burst Information
21	9	1.0	333.0	Yes	5291.8MHz, -61.0dBm	Hop sequence: 5599, 5600, 5358, 5336, 5398, 5422, 5354, 5524, 5613, 5513, 5608, 5572, 5462, 5660, 5521, 5431, 5652, 5691, 5646, 5664, 5696, 5562, 5460, 5289, 5252, 5553, 5451, 5714, 5375, 5506, 5569, 5260, 5256, 5575, 5271, 5395, 5344, 5405, 5327, 5477, 5644, 5442, 5651, 5445, 5333, 5399, 5551, 5542, 5630, 5699, 5552, 5631, 5407, 5342, 5471, 5485, 5331, 5393, 5397, 5268, 5611, 5661, 5278, 5559, 5512, 5715, 5446, 5628, 5687, 5337, 5436, 5275, 5639, 5622, 5301, 5543, 5528, 5311, 5625, 5723, 5531, 5284, 5426, 5588, 5564, 5568, 5430, 5515, 5544, 5597, 5408, 5692, 5479, 5368, 5389, 5509, 5567, 5574, 5621, 5541 (4 hits) (11/19/2012 06:01:23 PM)
22	9	1.0	333.0	Yes	5292.8MHz, -61.0dBm	Hop sequence: 5312, 5341, 5573, 5385, 5483, 5284, 5591, 5681, 5584, 5496, 5711, 5353, 5474, 5304, 5647, 5435, 5595, 5658, 5331, 5258, 5479, 5566, 5481, 5569, 5468, 5544, 5274, 5689, 5260, 5265, 5434, 5497, 5471, 5522, 5388, 5365, 5575, 5519, 5701, 5643, 5616, 5439, 5639, 5553, 5710, 5579, 5633, 5463, 5551, 5441, 5333, 5358, 5651, 5487, 5546, 5629, 5345, 5599, 5500, 5386, 5379, 5334, 5475, 5457, 5653, 5324, 5652, 5279, 5381, 5320, 5261, 5307, 5550, 5561, 5470, 5461, 5489, 5703, 5645, 5428, 5342, 5438, 5650, 5708, 5574, 5453, 5372, 5432, 5298, 5508, 5397, 5339, 5329, 5532, 5359, 5662, 5263, 5354, 5267, 5578 (3 hits) (11/19/2012 06:01:31 PM)

Table 157 - FCC frequency hopping radar (Type 6) Results CU-Steady State Low-Band						
Trial #	Pulses/ Burst	Pulse Width (us)	PRI (us)	Detected	Fr (MHz) and level (dBm)	Burst Information
23	9	1.0	333.0	Yes	5293.8MHz, -61.0dBm	Hop sequence: 5406, 5434, 5537, 5421, 5720, 5319, 5571, 5668, 5630, 5604, 5359, 5418, 5654, 5468, 5671, 5263, 5432, 5436, 5474, 5503, 5293, 5584, 5661, 5310, 5379, 5563, 5562, 5679, 5641, 5275, 5264, 5475, 5721, 5542, 5576, 5350, 5506, 5405, 5505, 5384, 5508, 5554, 5251, 5723, 5561, 5363, 5519, 5586, 5334, 5481, 5367, 5702, 5408, 5543, 5701, 5485, 5619, 5279, 5472, 5329, 5502, 5591, 5531, 5287, 5695, 5575, 5699, 5657, 5465, 5419, 5518, 5443, 5594, 5653, 5520, 5280, 5528, 5425, 5357, 5551, 5538, 5471, 5712, 5479, 5598, 5482, 5437, 5616, 5655, 5611, 5355, 5674, 5600, 5452, 5317, 5509, 5603, 5309, 5454, 5401 (5 hits) (11/19/2012 06:01:38 PM)
24	9	1.0	333.0	Yes	5294.8MHz, -61.0dBm	Hop sequence: 5263, 5649, 5323, 5330, 5543, 5714, 5501, 5399, 5300, 5455, 5523, 5309, 5456, 5637, 5317, 5636, 5487, 5594, 5552, 5493, 5553, 5482, 5429, 5466, 5443, 5292, 5683, 5283, 5557, 5674, 5307, 5353, 5303, 5717, 5449, 5688, 5305, 5310, 5577, 5657, 5635, 5476, 5391, 5555, 5281, 5530, 5566, 5365, 5401, 5629, 5690, 5513, 5392, 5695, 5373, 5344, 5492, 5473, 5711, 5338, 5721, 5521, 5546, 5708, 5463, 5573, 5582, 5541, 5471, 5333, 5624, 5542, 5460, 5312, 5699, 5654, 5302, 5375, 5372, 5666, 5638, 5356, 5538, 5477, 5701, 5504, 5395, 5469, 5451, 5286, 5284, 5595, 5633, 5409, 5335, 5328, 5659, 5383, 5677, 5439 (5 hits) (11/19/2012 06:01:52 PM)

Table 157 - FCC frequency hopping radar (Type 6) Results CU-Steady State Low-Band						
Trial #	Pulses/ Burst	Pulse Width (us)	PRI (us)	Detected	Fr (MHz) and level (dBm)	Burst Information
25	9	1.0	333.0	Yes	5295.8MHz, -61.0dBm	Hop sequence: 5542, 5358, 5390, 5505, 5546, 5449, 5548, 5340, 5700, 5571, 5335, 5293, 5714, 5418, 5683, 5374, 5339, 5442, 5690, 5586, 5349, 5467, 5466, 5402, 5513, 5469, 5547, 5578, 5298, 5697, 5423, 5337, 5610, 5384, 5657, 5412, 5544, 5494, 5618, 5414, 5350, 5454, 5474, 5446, 5645, 5265, 5456, 5651, 5625, 5643, 5538, 5464, 5500, 5430, 5371, 5279, 5518, 5599, 5330, 5271, 5646, 5597, 5396, 5281, 5515, 5341, 5507, 5499, 5522, 5420, 5565, 5705, 5679, 5530, 5362, 5639, 5543, 5306, 5521, 5608, 5403, 5502, 5539, 5461, 5648, 5407, 5664, 5444, 5356, 5668, 5399, 5332, 5491, 5496, 5318, 5519, 5346, 5642, 5602, 5256 (3 hits) (11/19/2012 06:02:00 PM)
26	9	1.0	333.0	Yes	5273.8MHz, -61.0dBm	Hop sequence: 5377, 5587, 5668, 5649, 5256, 5558, 5254, 5351, 5703, 5650, 5570, 5477, 5432, 5499, 5571, 5588, 5629, 5683, 5370, 5356, 5529, 5285, 5523, 5418, 5696, 5576, 5325, 5382, 5355, 5307, 5568, 5676, 5670, 5337, 5556, 5692, 5483, 5381, 5643, 5618, 5323, 5280, 5607, 5640, 5393, 5613, 5457, 5345, 5260, 5328, 5347, 5367, 5486, 5267, 5298, 5302, 5723, 5623, 5412, 5459, 5264, 5368, 5557, 5553, 5485, 5259, 5560, 5413, 5365, 5438, 5409, 5707, 5414, 5471, 5311, 5565, 5375, 5273, 5559, 5303, 5282, 5293, 5637, 5384, 5291, 5250, 5482, 5270, 5554, 5410, 5630, 5518, 5705, 5398, 5505, 5702, 5480, 5681, 5679, 5366 (5 hits) (11/19/2012 06:02:07 PM)

Table 157 - FCC frequency hopping radar (Type 6) Results CU-Steady State Low-Band						
Trial #	Pulses/ Burst	Pulse Width (us)	PRI (us)	Detected	Fr (MHz) and level (dBm)	Burst Information
27	9	1.0	333.0	Yes	5274.8MHz, -61.0dBm	Hop sequence: 5641, 5276, 5398, 5357, 5260, 5702, 5670, 5269, 5450, 5305, 5253, 5557, 5519, 5308, 5608, 5722, 5382, 5471, 5618, 5658, 5263, 5441, 5256, 5392, 5406, 5434, 5680, 5401, 5610, 5540, 5411, 5726, 5579, 5526, 5549, 5507, 5500, 5370, 5477, 5556, 5439, 5631, 5312, 5408, 5278, 5280, 5334, 5416, 5275, 5574, 5449, 5583, 5665, 5499, 5605, 5319, 5629, 5423, 5725, 5636, 5346, 5268, 5682, 5426, 5607, 5397, 5664, 5599, 5552, 5250, 5438, 5511, 5677, 5273, 5476, 5593, 5530, 5384, 5324, 5531, 5573, 5655, 5343, 5486, 5261, 5570, 5364, 5307, 5679, 5520, 5453, 5541, 5492, 5718, 5517, 5662, 5371, 5478, 5616, 5707 (4 hits) (11/19/2012 06:02:14 PM)
28	9	1.0	333.0	Yes	5275.8MHz, -61.0dBm	Hop sequence: 5329, 5633, 5723, 5662, 5613, 5393, 5710, 5437, 5283, 5284, 5409, 5411, 5348, 5268, 5359, 5527, 5482, 5317, 5653, 5610, 5674, 5296, 5340, 5587, 5644, 5500, 5625, 5388, 5468, 5380, 5385, 5681, 5479, 5656, 5256, 5561, 5371, 5312, 5412, 5399, 5260, 5358, 5614, 5304, 5313, 5405, 5638, 5556, 5429, 5414, 5491, 5607, 5343, 5368, 5424, 5350, 5593, 5295, 5450, 5515, 5531, 5529, 5287, 5276, 5545, 5689, 5341, 5530, 5505, 5426, 5455, 5626, 5516, 5592, 5481, 5454, 5332, 5586, 5672, 5490, 5715, 5428, 5651, 5495, 5394, 5526, 5519, 5349, 5577, 5436, 5439, 5253, 5433, 5639, 5569, 5314, 5251, 5497, 5584, 5546 (5 hits) (11/19/2012 06:02:21 PM)

Table 157 - FCC frequency hopping radar (Type 6) Results CU-Steady State Low-Band						
Trial #	Pulses/ Burst	Pulse Width (us)	PRI (us)	Detected	Fr (MHz) and level (dBm)	Burst Information
29	9	1.0	333.0	Yes	5276.8MHz, -61.0dBm	Hop sequence: 5289, 5668, 5405, 5659, 5723, 5583, 5381, 5694, 5695, 5625, 5468, 5404, 5721, 5262, 5486, 5680, 5356, 5545, 5285, 5492, 5352, 5280, 5611, 5541, 5535, 5646, 5332, 5483, 5292, 5597, 5322, 5621, 5350, 5475, 5346, 5546, 5696, 5636, 5473, 5386, 5622, 5308, 5554, 5567, 5619, 5328, 5701, 5672, 5493, 5585, 5394, 5538, 5501, 5555, 5628, 5645, 5449, 5561, 5642, 5693, 5261, 5367, 5624, 5692, 5600, 5305, 5578, 5708, 5319, 5432, 5326, 5298, 5698, 5725, 5627, 5662, 5416, 5384, 5478, 5494, 5495, 5389, 5599, 5593, 5315, 5560, 5562, 5603, 5609, 5316, 5454, 5569, 5287, 5629, 5655, 5263, 5500, 5251, 5681, 5651 (5 hits) (11/19/2012 06:02:30 PM)
30	9	1.0	333.0	Yes	5277.8MHz, -61.0dBm	Hop sequence: 5724, 5437, 5347, 5295, 5370, 5452, 5385, 5275, 5597, 5335, 5503, 5721, 5259, 5484, 5288, 5403, 5493, 5530, 5552, 5351, 5539, 5283, 5529, 5411, 5486, 5500, 5614, 5557, 5453, 5508, 5665, 5553, 5578, 5269, 5474, 5706, 5722, 5570, 5637, 5709, 5332, 5367, 5381, 5308, 5439, 5658, 5674, 5723, 5525, 5617, 5534, 5538, 5537, 5712, 5633, 5533, 5324, 5305, 5701, 5345, 5515, 5429, 5388, 5601, 5631, 5584, 5528, 5708, 5358, 5523, 5355, 5406, 5593, 5322, 5536, 5713, 5652, 5298, 5535, 5572, 5460, 5678, 5488, 5277, 5374, 5400, 5555, 5426, 5285, 5624, 5425, 5402, 5657, 5468, 5587, 5314, 5470, 5438, 5364, 5409 (6 hits) (11/19/2012 06:02:41 PM)

Table 157 - FCC frequency hopping radar (Type 6) Results CU-Steady State Low-Band						
Trial #	Pulses/ Burst	Pulse Width (us)	PRI (us)	Detected	Fr (MHz) and level (dBm)	Burst Information
31	9	1.0	333.0	Yes	5278.8MHz, -61.0dBm	Hop sequence: 5294, 5527, 5671, 5277, 5391, 5320, 5433, 5647, 5431, 5634, 5419, 5686, 5674, 5668, 5270, 5480, 5707, 5398, 5502, 5678, 5396, 5719, 5579, 5378, 5555, 5368, 5254, 5720, 5285, 5725, 5370, 5346, 5676, 5493, 5641, 5291, 5697, 5427, 5503, 5422, 5306, 5298, 5288, 5506, 5389, 5552, 5299, 5373, 5585, 5551, 5469, 5583, 5418, 5534, 5565, 5467, 5251, 5694, 5592, 5343, 5333, 5664, 5318, 5708, 5582, 5408, 5459, 5535, 5335, 5358, 5259, 5631, 5699, 5621, 5482, 5700, 5545, 5473, 5696, 5308, 5497, 5517, 5297, 5692, 5575, 5669, 5441, 5356, 5512, 5661, 5644, 5542, 5434, 5252, 5268, 5624, 5658, 5522, 5518, 5451 (5 hits) (11/19/2012 06:02:49 PM)
32	9	1.0	333.0	Yes	5279.8MHz, -61.0dBm	Hop sequence: 5707, 5454, 5382, 5483, 5466, 5419, 5549, 5710, 5264, 5510, 5499, 5612, 5532, 5500, 5613, 5673, 5429, 5631, 5543, 5712, 5390, 5470, 5554, 5255, 5275, 5442, 5610, 5678, 5558, 5413, 5385, 5271, 5594, 5348, 5574, 5542, 5387, 5642, 5386, 5365, 5285, 5258, 5299, 5424, 5477, 5507, 5280, 5338, 5724, 5641, 5522, 5350, 5674, 5269, 5302, 5701, 5516, 5722, 5301, 5487, 5719, 5263, 5667, 5391, 5518, 5430, 5548, 5322, 5474, 5655, 5565, 5527, 5696, 5273, 5706, 5687, 5626, 5611, 5267, 5514, 5666, 5703, 5423, 5657, 5658, 5533, 5473, 5298, 5713, 5254, 5677, 5270, 5606, 5328, 5509, 5383, 5293, 5435, 5326, 5659 (4 hits) (11/19/2012 06:02:59 PM)

Table 157 - FCC frequency hopping radar (Type 6) Results CU-Steady State Low-Band						
Trial #	Pulses/ Burst	Pulse Width (us)	PRI (us)	Detected	Fr (MHz) and level (dBm)	Burst Information
33	9	1.0	333.0	Yes	5280.8MHz, -61.0dBm	Hop sequence: 5442, 5546, 5553, 5643, 5470, 5708, 5466, 5445, 5303, 5496, 5406, 5718, 5719, 5413, 5379, 5682, 5345, 5550, 5499, 5361, 5268, 5295, 5321, 5605, 5539, 5377, 5460, 5675, 5399, 5453, 5535, 5368, 5571, 5459, 5532, 5438, 5580, 5701, 5393, 5684, 5290, 5451, 5257, 5528, 5300, 5614, 5712, 5312, 5503, 5529, 5462, 5408, 5402, 5557, 5403, 5654, 5498, 5656, 5586, 5354, 5373, 5270, 5365, 5622, 5680, 5285, 5357, 5332, 5355, 5578, 5347, 5416, 5376, 5264, 5336, 5255, 5322, 5482, 5474, 5275, 5663, 5667, 5315, 5436, 5495, 5678, 5265, 5508, 5465, 5703, 5311, 5714, 5289, 5447, 5478, 5272, 5698, 5646, 5696, 5449 (5 hits) (11/19/2012 06:03:07 PM)
34	9	1.0	333.0	Yes	5281.8MHz, -61.0dBm	Hop sequence: 5317, 5463, 5535, 5488, 5464, 5272, 5596, 5337, 5544, 5405, 5719, 5324, 5398, 5369, 5579, 5364, 5587, 5692, 5501, 5354, 5417, 5419, 5414, 5701, 5445, 5605, 5257, 5368, 5526, 5480, 5461, 5715, 5379, 5711, 5622, 5608, 5616, 5342, 5450, 5254, 5326, 5604, 5279, 5307, 5638, 5263, 5712, 5554, 5566, 5491, 5274, 5451, 5273, 5585, 5372, 5675, 5377, 5271, 5457, 5341, 5325, 5267, 5684, 5657, 5296, 5632, 5597, 5717, 5390, 5485, 5574, 5523, 5290, 5456, 5540, 5706, 5725, 5329, 5650, 5304, 5438, 5665, 5320, 5575, 5316, 5508, 5293, 5314, 5531, 5525, 5583, 5705, 5668, 5601, 5387, 5280, 5294, 5498, 5404, 5361 (6 hits) (11/19/2012 06:03:15 PM)

Table 157 - FCC frequency hopping radar (Type 6) Results CU-Steady State Low-Band						
Trial #	Pulses/ Burst	Pulse Width (us)	PRI (us)	Detected	Fr (MHz) and level (dBm)	Burst Information
35	9	1.0	333.0	Yes	5282.8MHz, -61.0dBm	Hop sequence: 5425, 5722, 5564, 5571, 5692, 5312, 5713, 5419, 5599, 5565, 5527, 5720, 5449, 5305, 5427, 5619, 5694, 5462, 5469, 5277, 5632, 5289, 5341, 5701, 5668, 5686, 5678, 5598, 5322, 5546, 5458, 5348, 5401, 5302, 5646, 5631, 5268, 5291, 5407, 5561, 5344, 5679, 5307, 5362, 5440, 5699, 5691, 5522, 5327, 5402, 5540, 5445, 5426, 5365, 5559, 5393, 5685, 5645, 5283, 5293, 5641, 5607, 5548, 5280, 5415, 5489, 5541, 5276, 5399, 5378, 5274, 5448, 5345, 5442, 5587, 5313, 5436, 5497, 5314, 5422, 5652, 5500, 5657, 5606, 5556, 5667, 5581, 5466, 5357, 5304, 5586, 5411, 5494, 5695, 5721, 5381, 5428, 5560, 5551, 5644 (8 hits) (11/19/2012 06:03:23 PM)
36	9	1.0	333.0	Yes	5283.8MHz, -61.0dBm	Hop sequence: 5700, 5388, 5529, 5526, 5661, 5356, 5456, 5496, 5403, 5635, 5637, 5455, 5431, 5475, 5449, 5694, 5621, 5601, 5375, 5479, 5691, 5600, 5471, 5628, 5582, 5538, 5612, 5665, 5448, 5262, 5595, 5425, 5465, 5301, 5696, 5680, 5476, 5569, 5371, 5378, 5462, 5325, 5504, 5414, 5437, 5285, 5275, 5286, 5302, 5639, 5483, 5519, 5304, 5383, 5598, 5360, 5343, 5334, 5685, 5478, 5655, 5541, 5347, 5315, 5457, 5263, 5722, 5376, 5662, 5305, 5614, 5392, 5344, 5682, 5260, 5623, 5522, 5377, 5653, 5565, 5688, 5395, 5672, 5512, 5415, 5553, 5511, 5578, 5654, 5587, 5503, 5489, 5490, 5605, 5510, 5603, 5634, 5306, 5580, 5590 (3 hits) (11/19/2012 06:03:31 PM)



Table 157 - FCC frequency hopping radar (Type 6) Results CU-Steady State Low-Band						
Trial #	Pulses/ Burst	Pulse Width (us)	PRI (us)	Detected	Fr (MHz) and level (dBm)	Burst Information
37	9	1.0	333.0	Yes	5284.8MHz, -61.0dBm	Hop sequence: 5356, 5466, 5443, 5580, 5386, 5719, 5579, 5373, 5542, 5461, 5706, 5465, 5339, 5264, 5581, 5349, 5589, 5481, 5462, 5519, 5285, 5641, 5410, 5523, 5363, 5394, 5284, 5501, 5630, 5313, 5601, 5608, 5572, 5341, 5419, 5318, 5577, 5471, 5548, 5516, 5312, 5573, 5693, 5723, 5479, 5543, 5252, 5697, 5639, 5389, 5450, 5637, 5289, 5308, 5469, 5657, 5257, 5628, 5468, 5435, 5337, 5534, 5547, 5668, 5294, 5445, 5555, 5431, 5261, 5429, 5260, 5621, 5653, 5401, 5296, 5505, 5482, 5385, 5355, 5315, 5353, 5487, 5666, 5332, 5251, 5467, 5376, 5364, 5427, 5304, 5423, 5655, 5276, 5714, 5512, 5565, 5620, 5380, 5703, 5522 (5 hits) (11/19/2012 06:03:41 PM)
38	9	1.0	333.0	Yes	5285.8MHz, -61.0dBm	Hop sequence: 5296, 5359, 5486, 5401, 5294, 5528, 5529, 5370, 5706, 5367, 5647, 5319, 5309, 5484, 5554, 5523, 5430, 5573, 5333, 5577, 5491, 5286, 5371, 5626, 5345, 5422, 5453, 5590, 5524, 5640, 5576, 5362, 5714, 5381, 5721, 5677, 5553, 5617, 5507, 5297, 5393, 5400, 5406, 5449, 5361, 5435, 5563, 5258, 5546, 5373, 5374, 5632, 5514, 5332, 5561, 5304, 5480, 5493, 5471, 5703, 5339, 5587, 5322, 5558, 5652, 5323, 5511, 5438, 5501, 5597, 5441, 5439, 5684, 5475, 5284, 5623, 5402, 5725, 5578, 5377, 5300, 5348, 5386, 5394, 5320, 5353, 5613, 5335, 5603, 5656, 5645, 5685, 5295, 5331, 5434, 5540, 5695, 5690, 5638, 5266 (4 hits) (11/19/2012 06:03:48 PM)

Table 157 - FCC frequency hopping radar (Type 6) Results CU-Steady State Low-Band						
Trial #	Pulses/ Burst	Pulse Width (us)	PRI (us)	Detected	Fr (MHz) and level (dBm)	Burst Information
39	9	1.0	333.0	Yes	5286.8MHz, -61.0dBm	Hop sequence: 5449, 5620, 5688, 5271, 5301, 5416, 5464, 5632, 5545, 5492, 5571, 5607, 5695, 5628, 5426, 5288, 5320, 5334, 5649, 5250, 5519, 5343, 5411, 5396, 5489, 5353, 5693, 5434, 5660, 5453, 5413, 5466, 5260, 5311, 5515, 5435, 5276, 5699, 5548, 5689, 5615, 5461, 5576, 5340, 5429, 5292, 5473, 5344, 5641, 5642, 5252, 5303, 5598, 5368, 5513, 5296, 5444, 5266, 5457, 5370, 5716, 5603, 5674, 5430, 5289, 5415, 5300, 5352, 5395, 5441, 5346, 5338, 5436, 5539, 5447, 5656, 5392, 5538, 5562, 5558, 5536, 5388, 5481, 5595, 5470, 5268, 5357, 5281, 5427, 5386, 5706, 5278, 5685, 5286, 5531, 5613, 5555, 5347, 5297, 5424 (7 hits) (11/19/2012 06:03:58 PM)
40	9	1.0	333.0	Yes	5287.8MHz, -61.0dBm	Hop sequence: 5328, 5527, 5667, 5258, 5702, 5666, 5554, 5490, 5363, 5509, 5293, 5282, 5454, 5375, 5379, 5365, 5493, 5630, 5541, 5542, 5570, 5547, 5353, 5286, 5668, 5316, 5586, 5385, 5643, 5260, 5664, 5261, 5325, 5573, 5615, 5648, 5461, 5669, 5502, 5272, 5323, 5543, 5335, 5253, 5624, 5565, 5251, 5444, 5696, 5437, 5651, 5447, 5412, 5582, 5499, 5301, 5655, 5410, 5438, 5512, 5605, 5255, 5616, 5535, 5330, 5556, 5657, 5712, 5659, 5679, 5374, 5368, 5439, 5340, 5347, 5402, 5263, 5652, 5315, 5415, 5580, 5611, 5588, 5717, 5472, 5538, 5388, 5265, 5300, 5352, 5632, 5466, 5478, 5675, 5406, 5346, 5533, 5628, 5364, 5264 (3 hits) (11/19/2012 06:04:10 PM)

Table 157 - FCC frequency hopping radar (Type 6) Results CU-Steady State Low-Band						
Trial #	Pulses/ Burst	Pulse Width (us)	PRI (us)	Detected	Fr (MHz) and level (dBm)	Burst Information
41	9	1.0	333.0	Yes	5288.8MHz, -61.0dBm	Hop sequence: 5393, 5261, 5305, 5693, 5574, 5610, 5698, 5326, 5345, 5533, 5681, 5331, 5481, 5551, 5536, 5552, 5687, 5578, 5260, 5483, 5627, 5616, 5589, 5577, 5361, 5601, 5643, 5526, 5558, 5497, 5322, 5334, 5568, 5684, 5299, 5403, 5310, 5468, 5365, 5421, 5278, 5493, 5726, 5263, 5283, 5598, 5364, 5494, 5390, 5563, 5634, 5286, 5369, 5330, 5455, 5451, 5419, 5434, 5306, 5680, 5505, 5678, 5443, 5553, 5707, 5672, 5250, 5556, 5673, 5525, 5593, 5582, 5665, 5695, 5404, 5429, 5362, 5296, 5722, 5576, 5280, 5351, 5302, 5309, 5363, 5657, 5339, 5501, 5337, 5661, 5438, 5379, 5605, 5608, 5464, 5415, 5586, 5628, 5397, 5441 (4 hits) (11/19/2012 06:04:18 PM)
42	9	1.0	333.0	Yes	5289.8MHz, -61.0dBm	Hop sequence: 5584, 5319, 5625, 5401, 5371, 5420, 5531, 5291, 5509, 5317, 5524, 5519, 5704, 5603, 5520, 5370, 5456, 5485, 5493, 5662, 5690, 5558, 5632, 5596, 5308, 5657, 5293, 5292, 5381, 5507, 5445, 5402, 5397, 5374, 5593, 5350, 5392, 5452, 5612, 5527, 5609, 5295, 5577, 5539, 5590, 5710, 5572, 5651, 5716, 5454, 5713, 5498, 5547, 5556, 5668, 5644, 5598, 5270, 5455, 5479, 5526, 5272, 5306, 5565, 5522, 5686, 5618, 5515, 5721, 5277, 5398, 5303, 5340, 5269, 5549, 5346, 5661, 5683, 5487, 5276, 5470, 5366, 5313, 5434, 5613, 5413, 5327, 5614, 5336, 5377, 5435, 5274, 5692, 5329, 5383, 5665, 5588, 5691, 5281, 5669 (8 hits) (11/19/2012 06:04:26 PM)

Table 157 - FCC frequency hopping radar (Type 6) Results CU-Steady State Low-Band						
Trial #	Pulses/ Burst	Pulse Width (us)	PRI (us)	Detected	Fr (MHz) and level (dBm)	Burst Information
43	9	1.0	333.0	Yes	5290.8MHz, -61.0dBm	Hop sequence: 5585, 5689, 5572, 5293, 5410, 5692, 5678, 5699, 5362, 5415, 5640, 5672, 5708, 5261, 5583, 5376, 5545, 5620, 5267, 5407, 5522, 5622, 5611, 5464, 5354, 5336, 5281, 5418, 5547, 5717, 5648, 5445, 5562, 5695, 5364, 5467, 5698, 5582, 5543, 5588, 5434, 5396, 5590, 5406, 5426, 5397, 5627, 5263, 5496, 5288, 5355, 5500, 5628, 5368, 5409, 5332, 5660, 5404, 5663, 5286, 5423, 5370, 5442, 5556, 5634, 5481, 5338, 5598, 5586, 5579, 5294, 5486, 5718, 5311, 5563, 5317, 5497, 5432, 5455, 5625, 5282, 5439, 5621, 5581, 5529, 5494, 5322, 5571, 5357, 5531, 5400, 5254, 5448, 5512, 5316, 5492, 5313, 5454, 5693, 5668 (6 hits) (11/19/2012 06:04:35 PM)
44	9	1.0	333.0	Yes	5291.8MHz, -61.0dBm	Hop sequence: 5509, 5686, 5413, 5685, 5461, 5663, 5382, 5697, 5723, 5527, 5332, 5303, 5441, 5351, 5472, 5256, 5500, 5561, 5402, 5569, 5652, 5667, 5323, 5373, 5597, 5271, 5654, 5538, 5283, 5318, 5586, 5308, 5345, 5459, 5282, 5272, 5661, 5593, 5582, 5310, 5452, 5696, 5724, 5449, 5541, 5462, 5532, 5397, 5705, 5495, 5693, 5503, 5627, 5380, 5648, 5599, 5301, 5253, 5489, 5331, 5526, 5445, 5470, 5273, 5309, 5491, 5635, 5713, 5352, 5531, 5399, 5392, 5336, 5588, 5464, 5575, 5385, 5369, 5514, 5616, 5578, 5366, 5577, 5293, 5537, 5295, 5422, 5581, 5672, 5590, 5346, 5457, 5322, 5444, 5450, 5480, 5553, 5406, 5434, 5334 (4 hits) (11/19/2012 06:04:45 PM)

Table 157 - FCC frequency hopping radar (Type 6) Results CU-Steady State Low-Band						
Trial #	Pulses/ Burst	Pulse Width (us)	PRI (us)	Detected	Fr (MHz) and level (dBm)	Burst Information
45	9	1.0	333.0	Yes	5292.8MHz, -61.0dBm	Hop sequence: 5632, 5310, 5307, 5431, 5678, 5453, 5565, 5400, 5278, 5457, 5480, 5502, 5626, 5571, 5476, 5392, 5716, 5272, 5458, 5475, 5564, 5301, 5306, 5342, 5363, 5641, 5298, 5438, 5262, 5379, 5304, 5516, 5385, 5427, 5590, 5543, 5268, 5312, 5486, 5725, 5611, 5269, 5560, 5491, 5664, 5251, 5388, 5330, 5393, 5443, 5259, 5420, 5325, 5614, 5287, 5698, 5557, 5403, 5471, 5396, 5723, 5608, 5616, 5589, 5485, 5326, 5588, 5459, 5300, 5482, 5267, 5599, 5418, 5606, 5585, 5483, 5718, 5421, 5697, 5523, 5271, 5677, 5466, 5332, 5291, 5349, 5261, 5311, 5406, 5620, 5328, 5556, 5454, 5644, 5552, 5596, 5642, 5591, 5426, 5352 (3 hits) (11/19/2012 06:04:57 PM)
46	9	1.0	333.0	Yes	5293.8MHz, -61.0dBm	Hop sequence: 5556, 5326, 5645, 5252, 5360, 5354, 5321, 5318, 5393, 5540, 5636, 5437, 5430, 5683, 5604, 5572, 5492, 5297, 5668, 5693, 5454, 5486, 5635, 5657, 5385, 5647, 5721, 5259, 5606, 5562, 5660, 5619, 5702, 5416, 5561, 5652, 5255, 5257, 5340, 5274, 5496, 5293, 5269, 5479, 5455, 5584, 5477, 5260, 5398, 5290, 5388, 5671, 5589, 5447, 5542, 5469, 5713, 5648, 5263, 5524, 5581, 5714, 5309, 5367, 5706, 5514, 5392, 5289, 5397, 5288, 5349, 5726, 5499, 5724, 5558, 5308, 5575, 5331, 5406, 5501, 5700, 5432, 5292, 5488, 5551, 5666, 5677, 5535, 5676, 5673, 5381, 5296, 5610, 5559, 5640, 5639, 5287, 5272, 5251, 5656 (7 hits) (11/19/2012 06:05:09 PM)

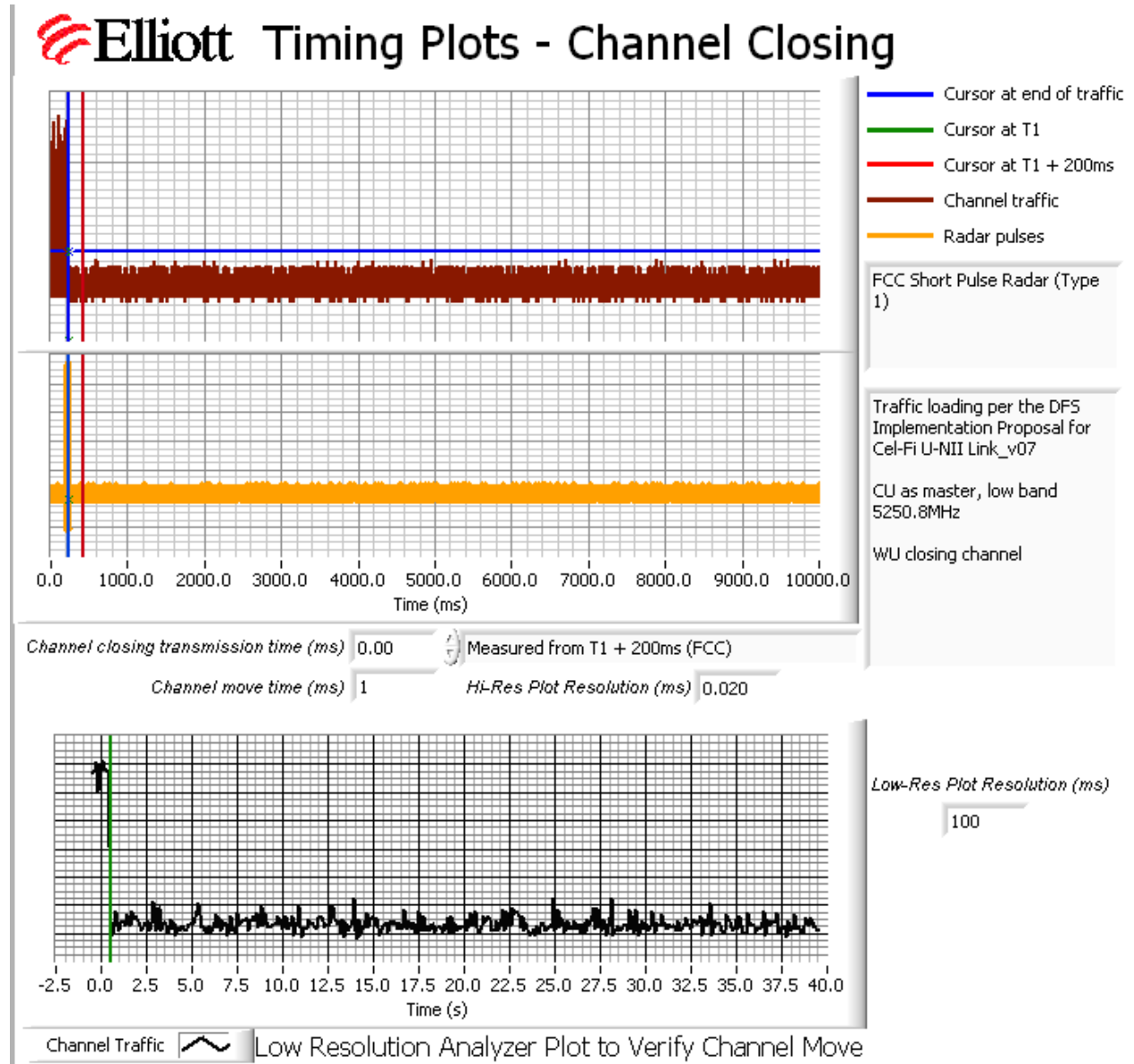
**Appendix C Test Data Tables and Plots for Channel Closing**

**FCC PART 15 SUBPART E Channel Closing Measurements**

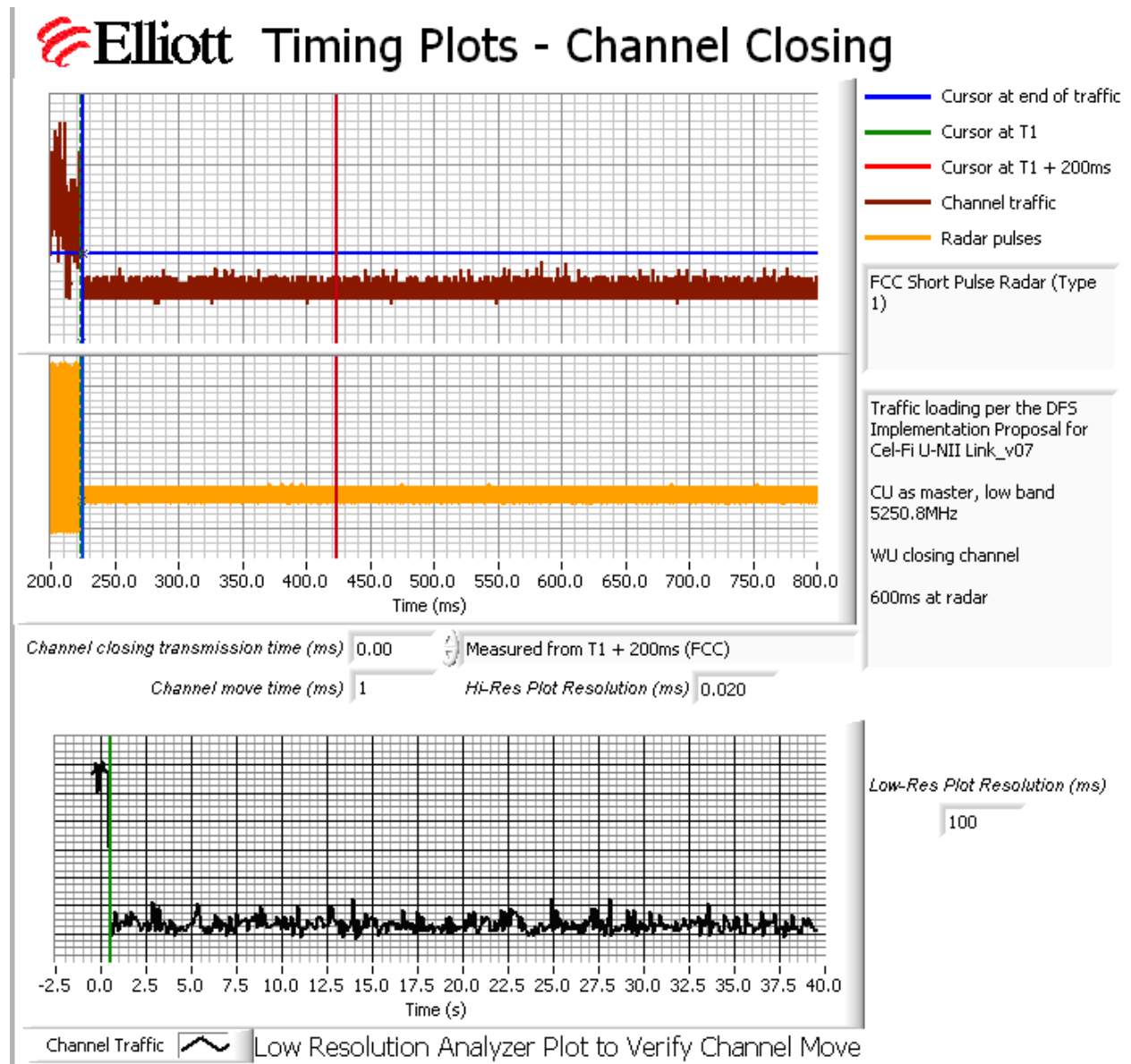
<b>Table 158 FCC Part 15 Subpart E Channel Closing Test Results</b>					
Waveform Type	Channel Closing Transmission Time <sup>1</sup>		Channel Move Time		Result
	Measured	Limit	Measured	Limit	
Radar Type 1, Low Band, CU Steady State	0ms	60 ms	1ms	10 s	Pass
Radar Type 5, Low Band, CU Steady State	0ms	60 ms	0ms	10 s	Pass
Radar Type 1, High Band, WU Steady State	0ms	60 ms	148ms	10 s	Pass
Radar Type 5, High Band, WU Steady State	0ms	60 ms	0ms	10 s	Pass
Radar Type 1, Low Band, WU, CU Acquire (Synchronization) Mode	0ms	60 ms	-9ms	10 s	Pass
Radar Type 5, Low Band, WU, CU Acquire (Synchronization) Mode	0ms	60 ms	0ms	10 s	Pass

After the final channel closing test the channel was monitored for a further 30 minutes. No transmissions occurred on the channel.

<sup>1</sup> Channel closing time for FCC measurements is the aggregate transmission time starting from 200ms after the end of the radar signal to the completion of the channel move.

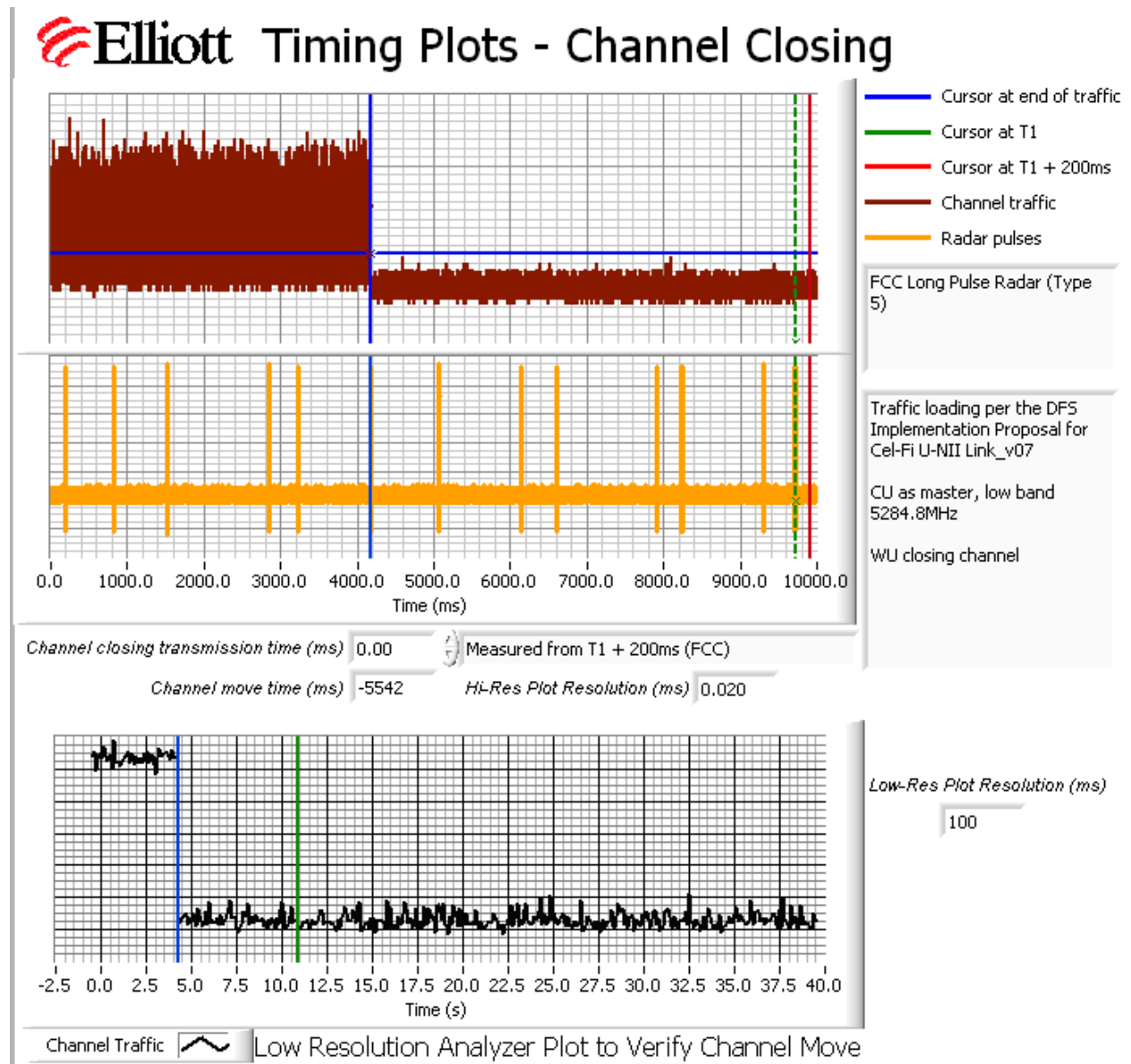


**Figure 2 Channel Closing Time and Channel Move Time – 40 second plot, Type 1 Radar, Low Band, CU Steady State**

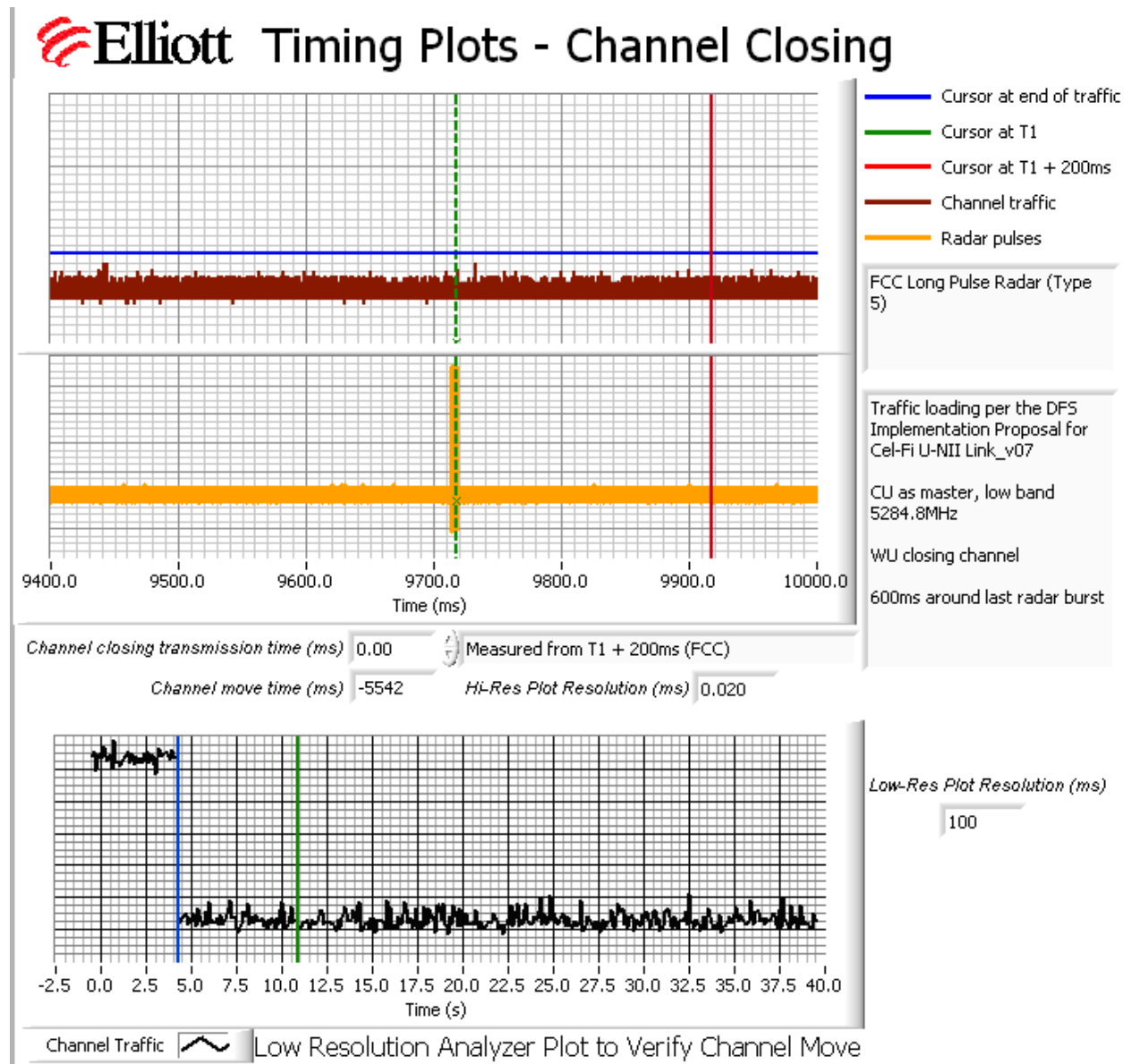


**Figure 3 Close-Up of Transmissions Occurring More Than 200ms After The End of Radar, Type 1 Radar, Low Band, CU Steady State**





**Figure 4 Channel Closing Time and Channel Move Time – 40 second plot, Long Pulse Radar, Low Band, CU Steady State**



**Figure 5 Close-Up of Transmissions Occurring More Than 200ms After The End of Radar, Long Pulse Radar, Low Band, CU Steady State**

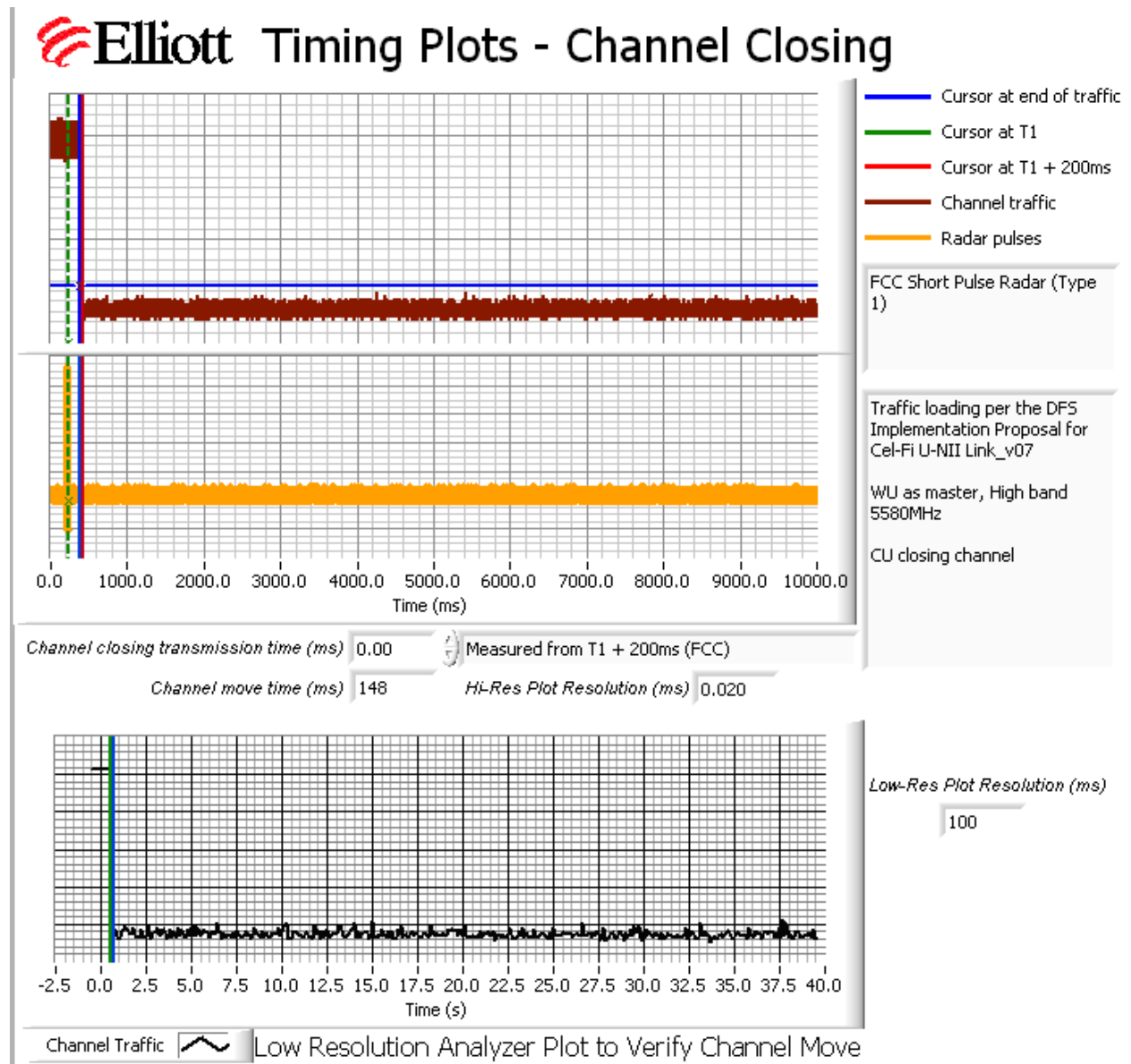
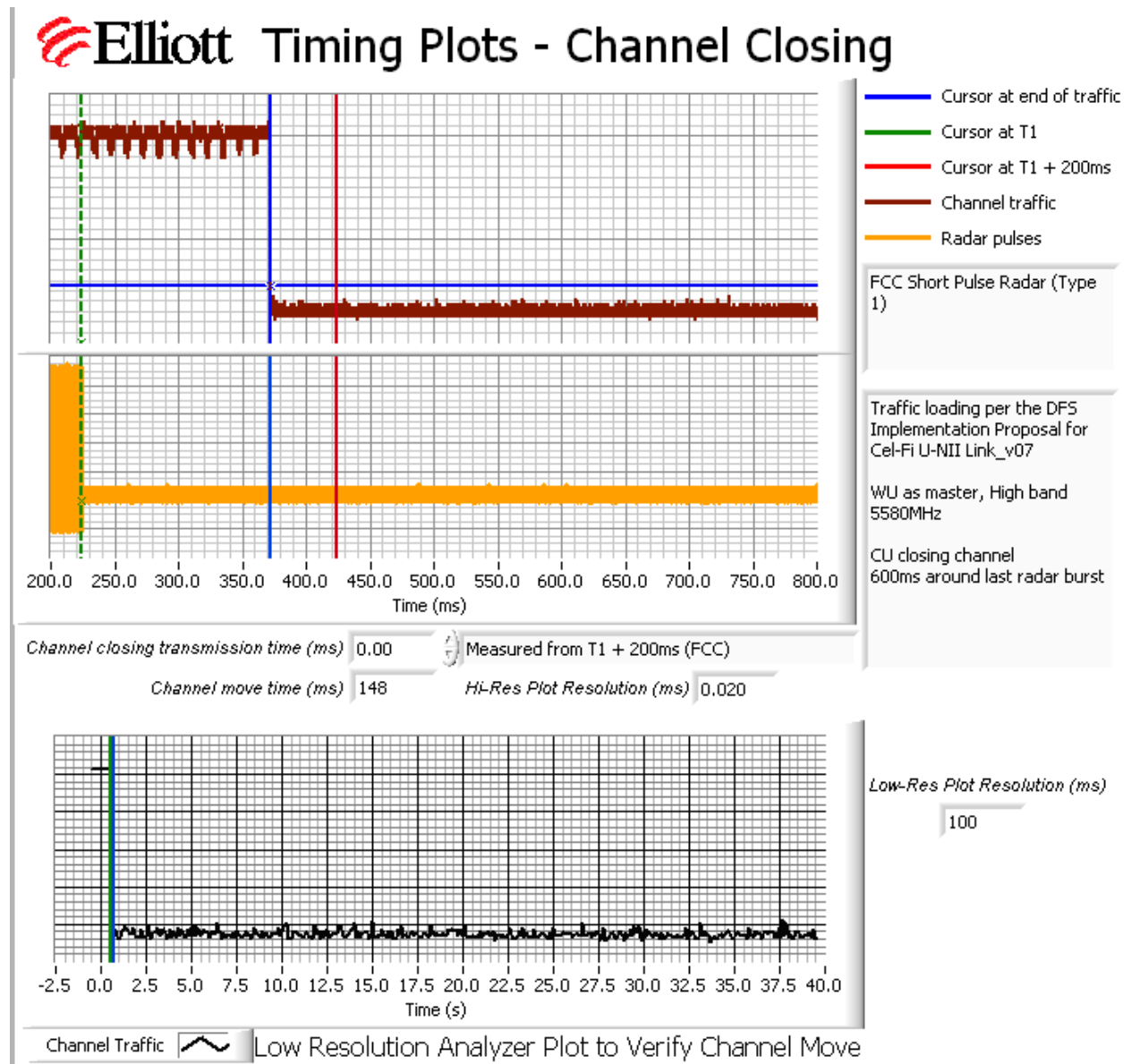
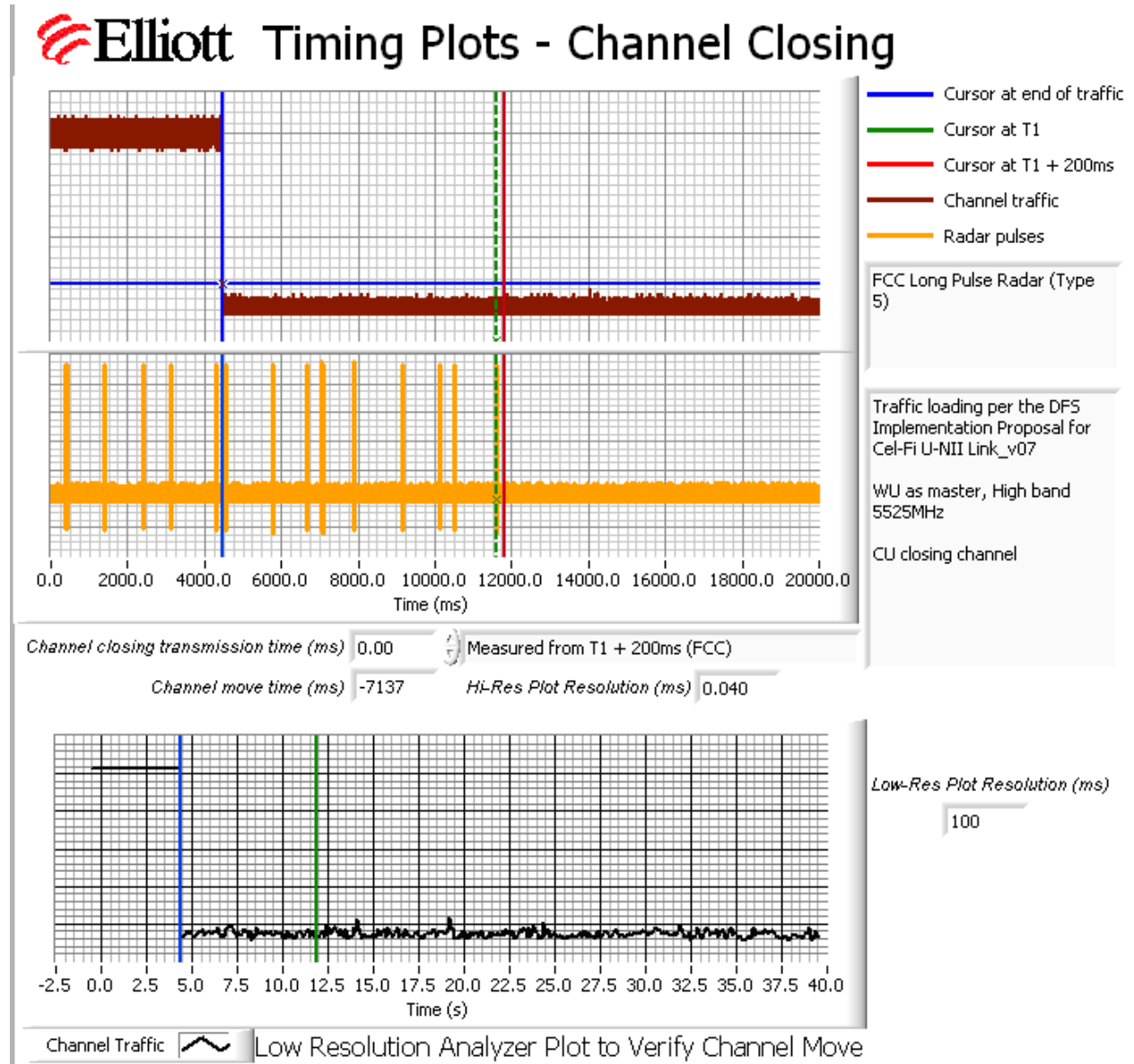


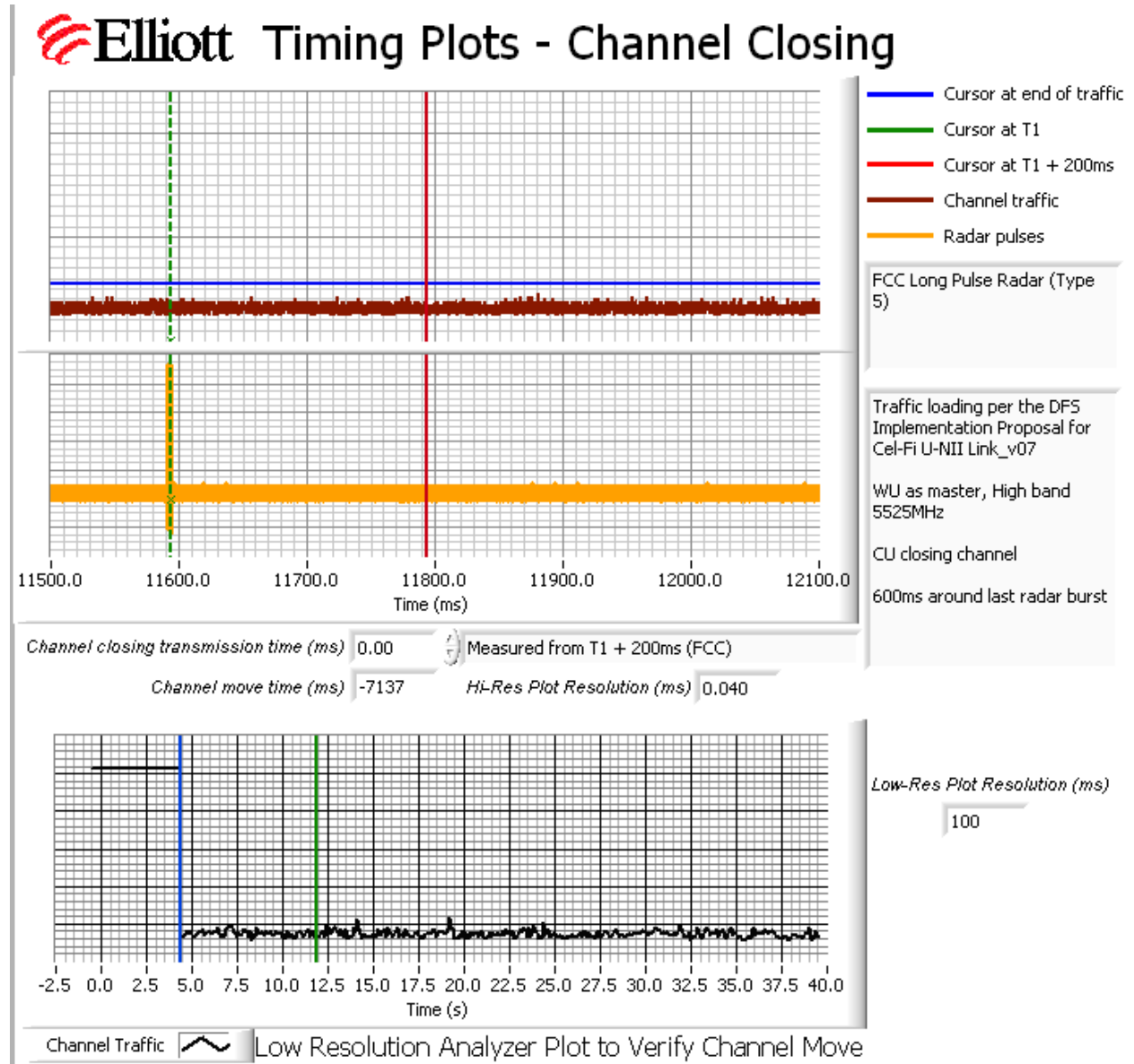
Figure 6 Channel Closing Time and Channel Move Time – 40 second plot, Type 1 Radar, High Band, WU Steady State



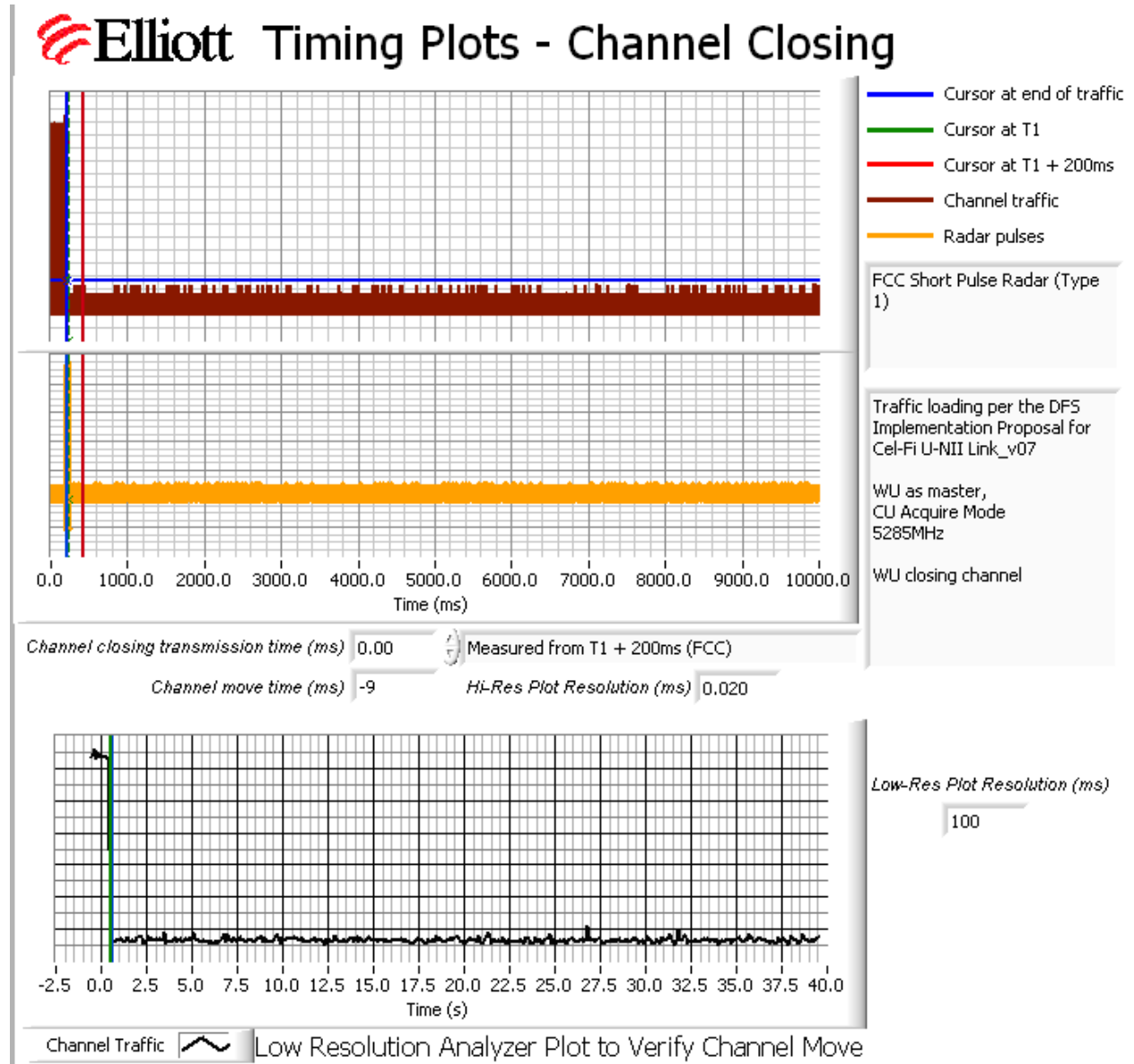
**Figure 7 Close-Up of Transmissions Occurring More Than 200ms After The End of Radar, Type 1 Radar, High Band, WU Steady State**



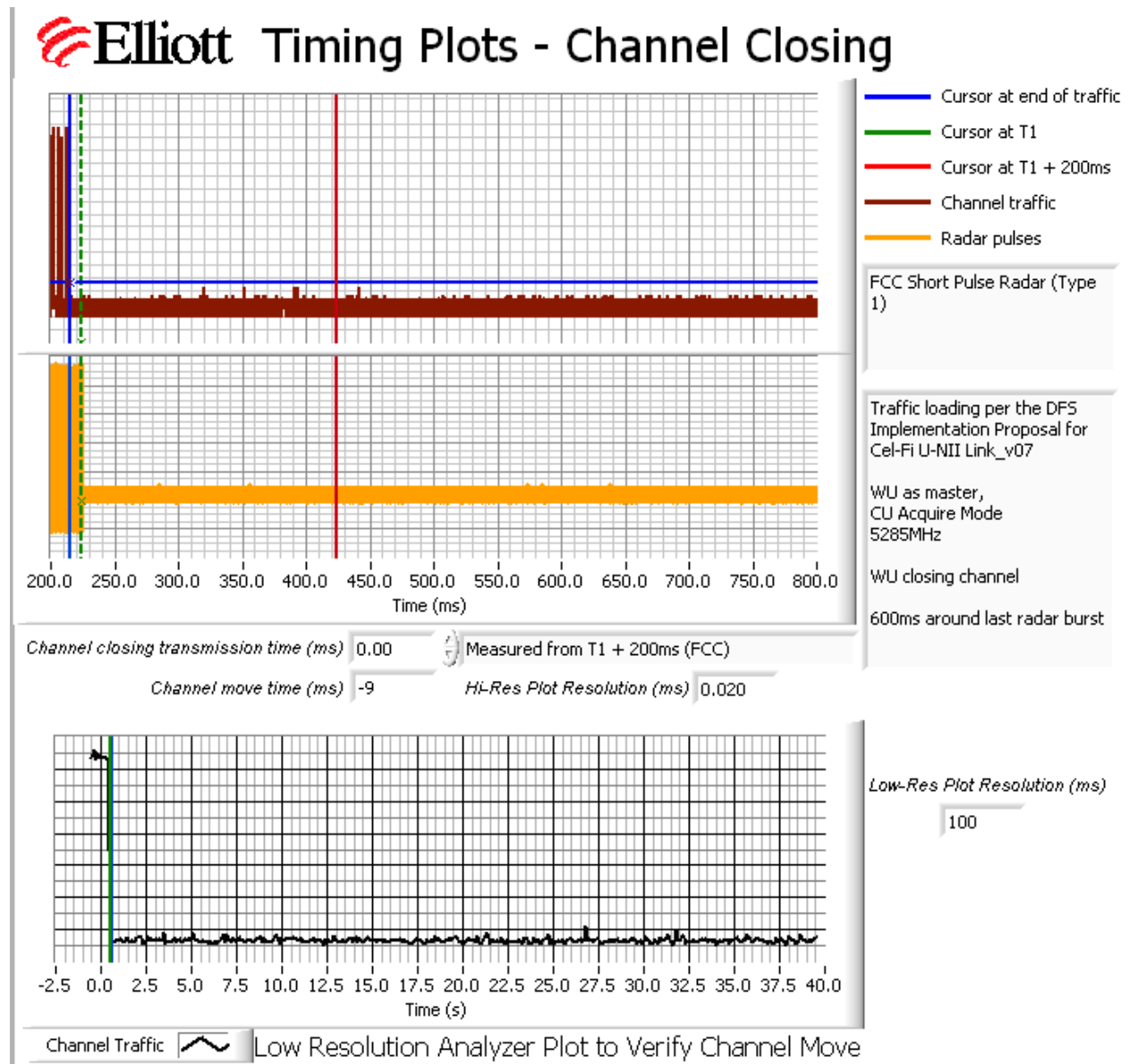
**Figure 8 Channel Closing Time and Channel Move Time – 40 second plot, Long Pulse Radar, High Band, WU Steady State**



**Figure 9 Close-Up of Transmissions Occurring More Than 200ms After The End of Radar, Long Pulse Radar, High Band, WU Steady State**

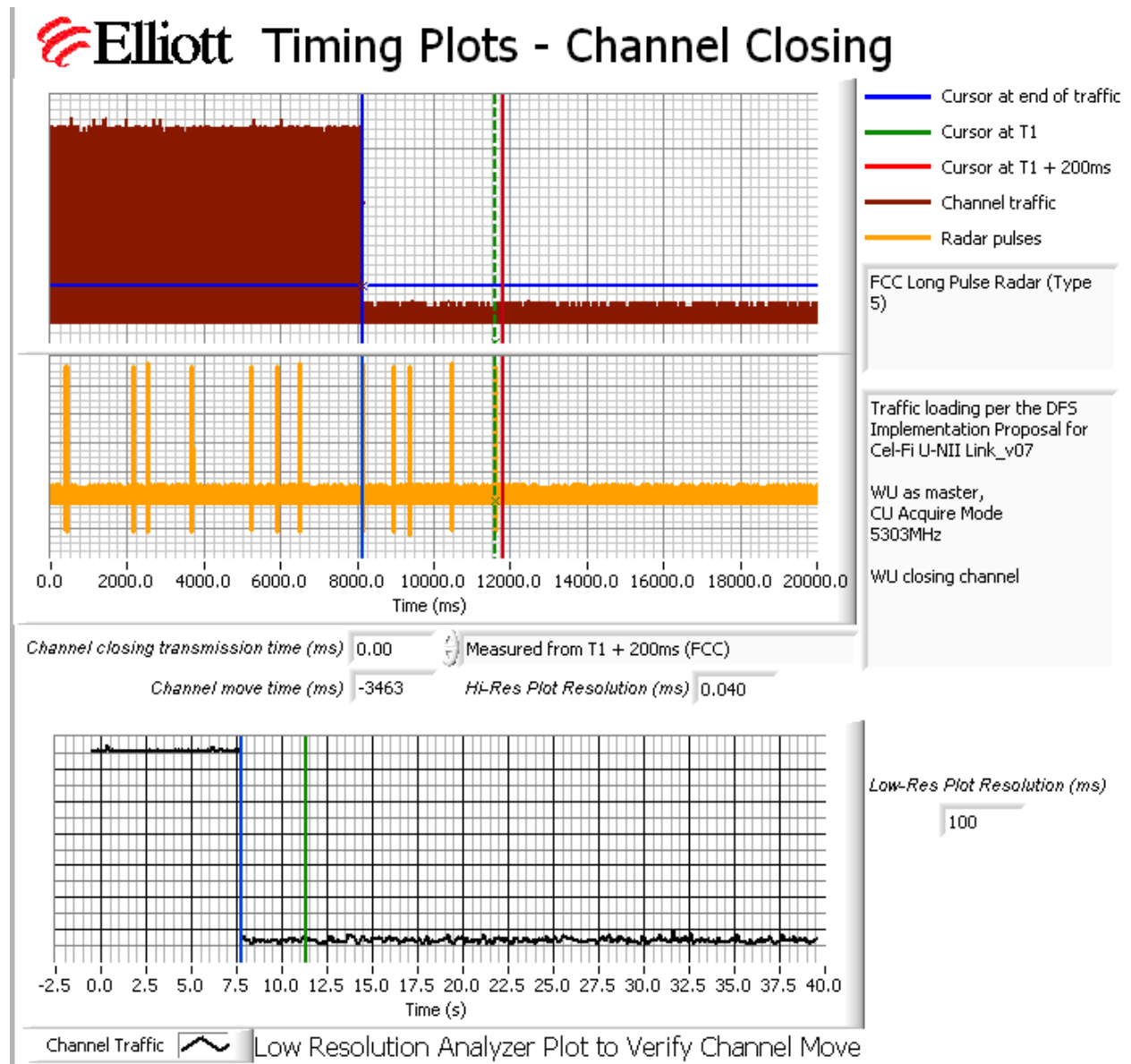


**Figure 10 Channel Closing Time and Channel Move Time – 40 second plot, Type 1 Radar, Low Band, WU, CU Acquire Mode**

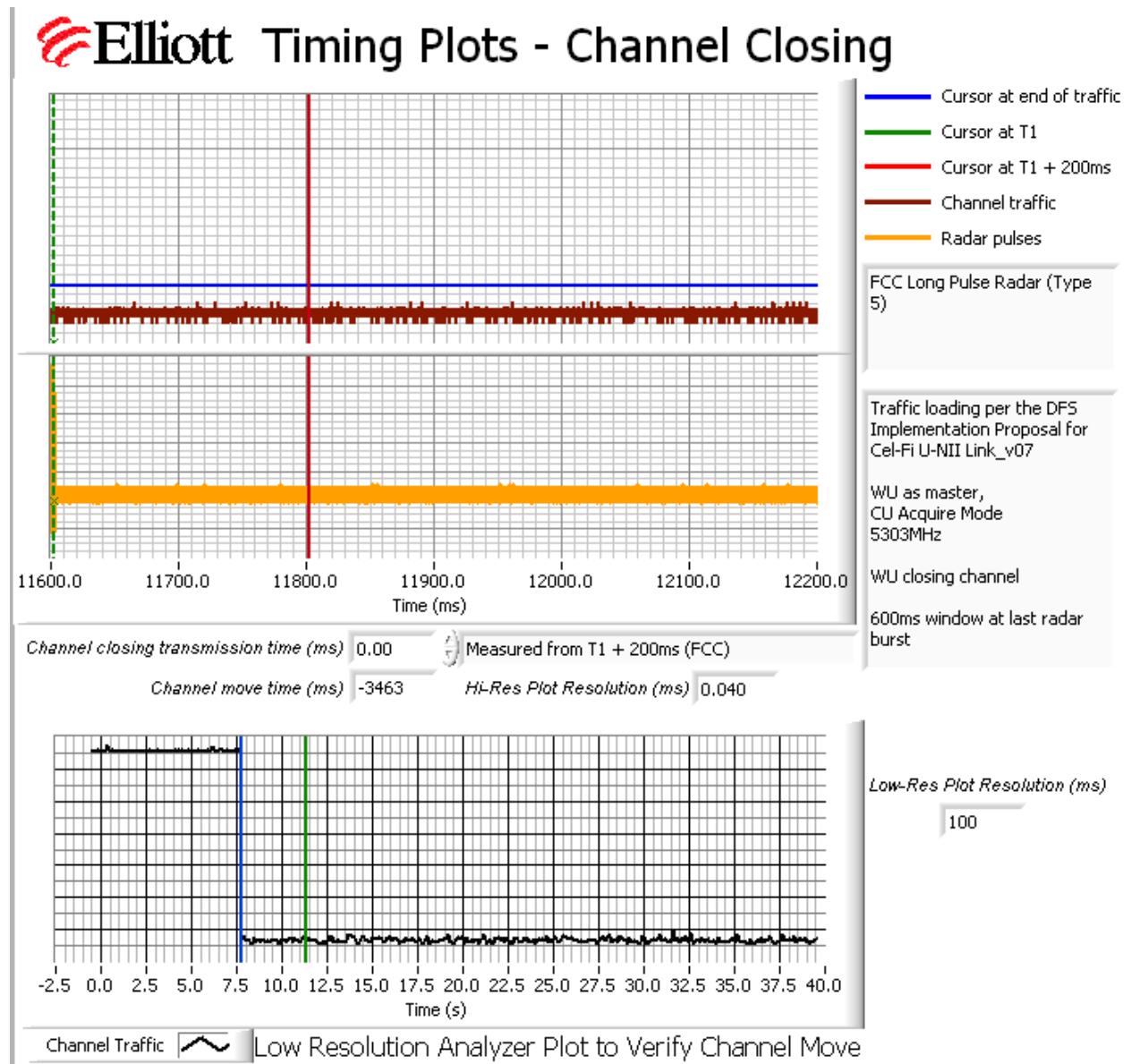


**Figure 11 Close-Up of Transmissions Occurring More Than 200ms After The End of Radar, Type 1 Radar, Low Band, WU, CU Acquire Mode**

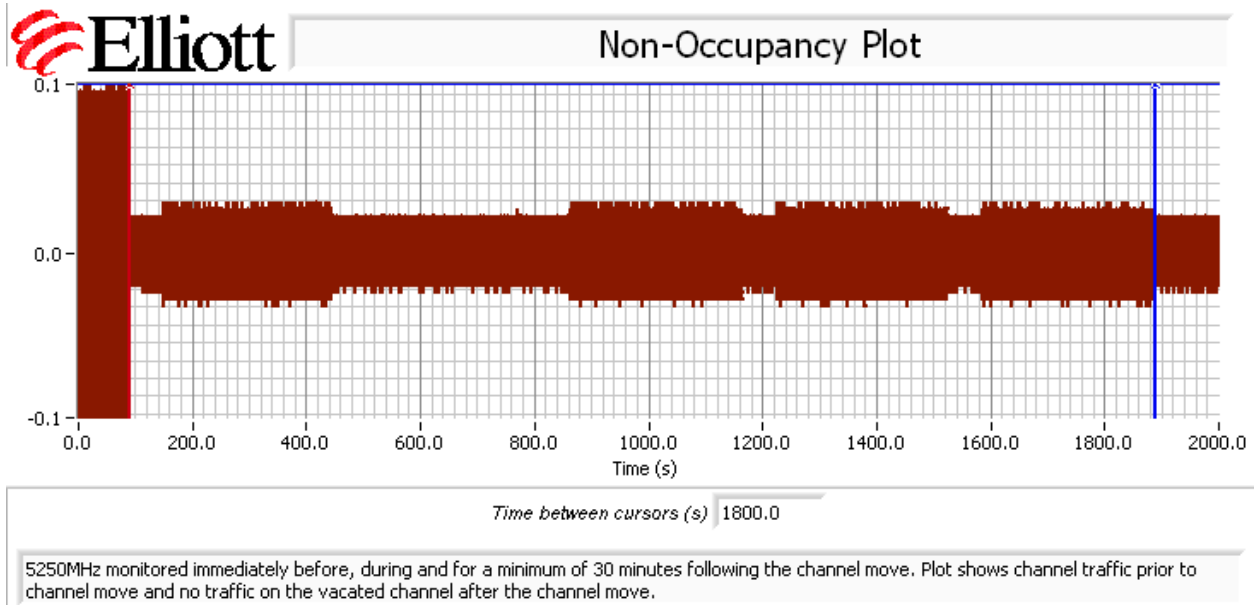




**Figure 12 Channel Closing Time and Channel Move Time – 40 second plot, Long Pulse Radar, Low Band, WU, CU Acquire Mode**



**Figure 13 Close-Up of Transmissions Occurring More Than 200ms After The End of Radar, Long Pulse Radar, Low Band, WU, CU Acquire Mode**



**Figure 14 Radar Channel Non-Occupancy Plot**

The non-occupancy plot was made over a 30-minute time period following the channel move time with the analyzer IF output connected to the scope and tuned to the vacated channel. No transmissions were observed after the channel move had been completed.

After the channel move the client re-associated with the master device on the new channel. After the channel move the client device stopped transmitting.

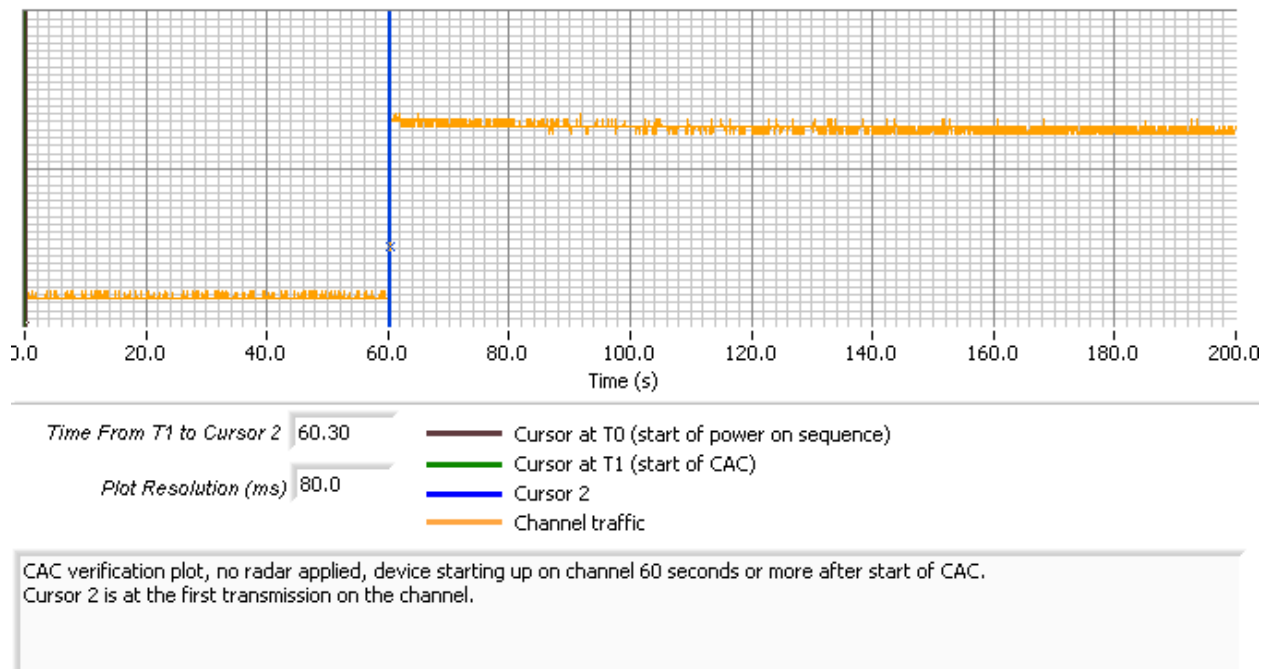
**Appendix D Test Data – Channel Availability Check**

5250- 5350 MHz, 5470 – 5725 MHz

The first plot shows the first transmissions on a channel after restarting/power cycling the master device, with no radar applied during the CAC. The start of CAC is assumed to be 60 seconds before the first transmission as indicated by the green cursor line.



**Timing Plots - Channel Availability Check**



**Figure 15 Plot of EUT Start-Up After CAC**

The channel availability check (CAC) was made by applying type 1 radar during either the first 6 seconds or last 6 seconds of the CAC period.

The level of the radar signal applied was -64dBm. Measurements were made on channel 64 (5284.8 MHz) and also on channel 120 (5563.2 MHz).

The start time is the same for each of the plots and the green cursor is positioned to coincide with the start of the Channel Availability Check period based on the plot taken with no radar applied during the CAC.

The plots show that there were no transmissions on the channel after the radar burst was applied during the CAC, and confirm that the CAC is at least 60 seconds. The description of “Channel Traffic” in the plot legend indicates the transmissions from both the radar system and the EUT on the start-up channel. In all cases only the radar burst is observed. The resolution of the plot is not fine enough to resolve the individual pulses within the burst.



## Timing Plots - Channel Availability Check

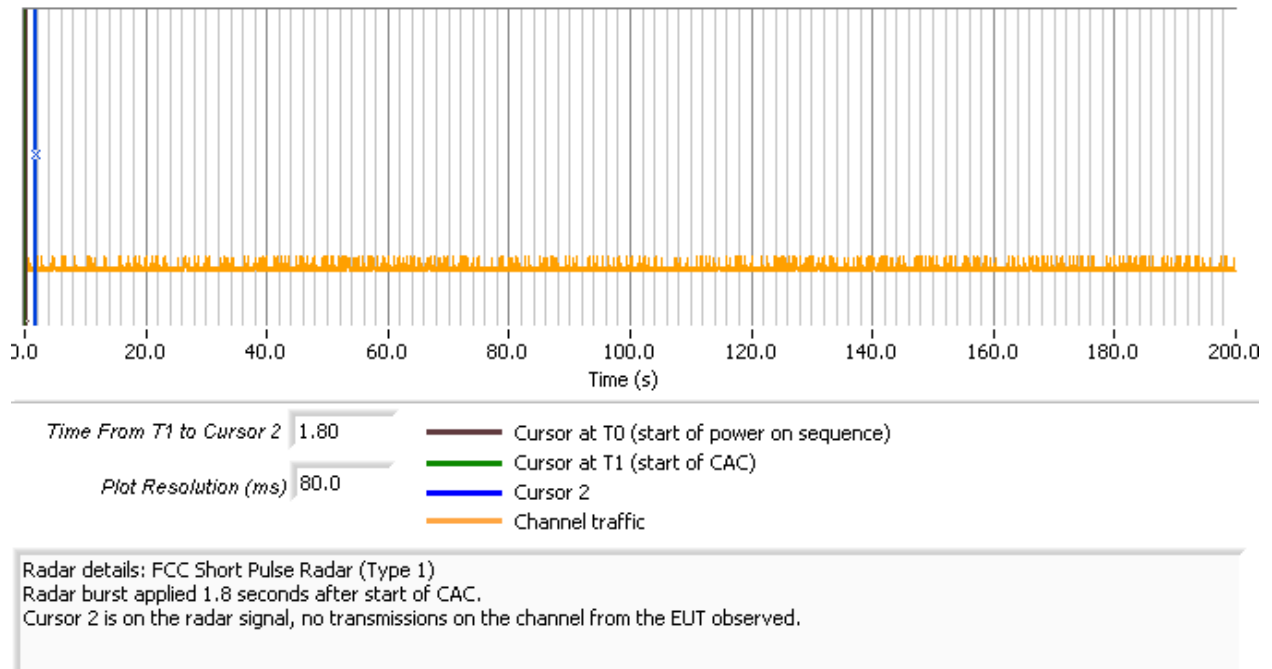


Figure 16 Radar Applied At Start of CAC



## Timing Plots - Channel Availability Check

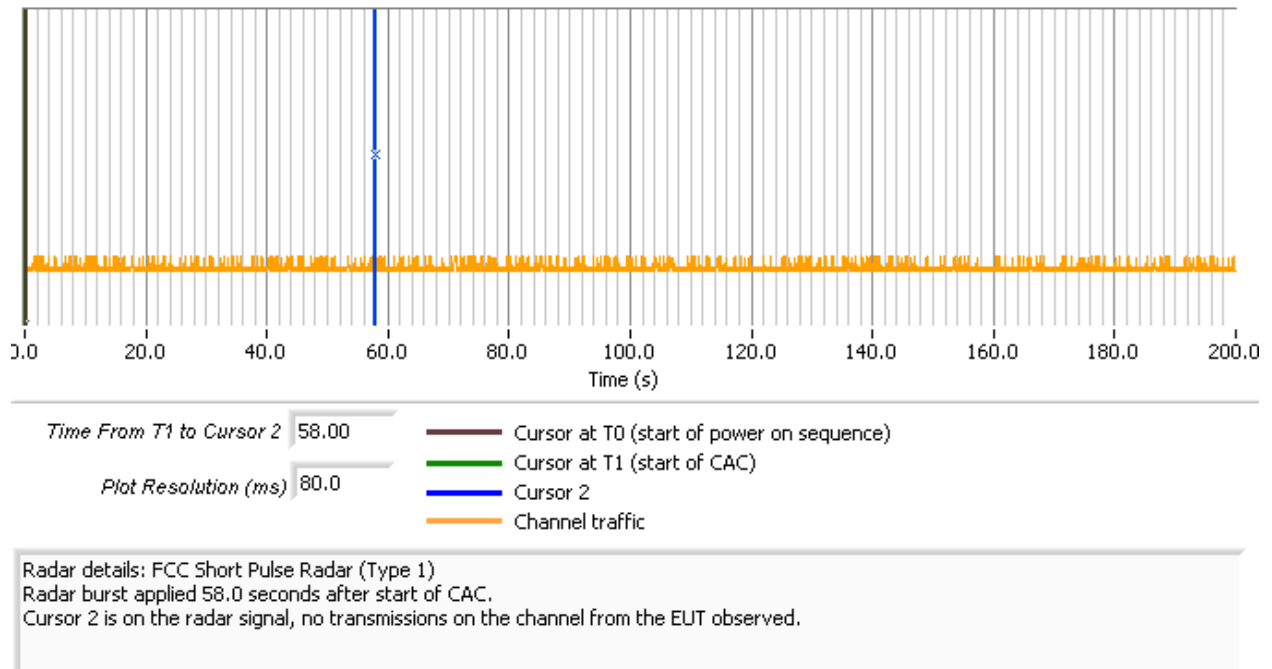


Figure 17 Radar Applied At End of CAC

**Appendix E Antenna Specification**

5250 TX (WU)		5564 TX (CU)	
Angle		Angle	
0	0.3	1	1.3
1	0.2	2	1.6
2	-0.2	3	1.2
3	-0.5	5	1.2
4	-0.9	6	1.7
5	-1.5	7	1.4
6	-0.6	8	1.3
8	-1.9	10	1.3
9	-2.3	11	1.2
10	-1.8	12	1.1
11	-1	13	0
12	-0.8	15	-0.3
14	-0.5	16	-1.5
15	-0.3	17	-1.9
16	0.7	18	-2.5
17	2.3	19	-4
18	2.4	21	-5.5
20	3	22	-5
21	2.8	23	-4.1
22	2.9	24	-3.6
23	3.3	25	-3.2
24	3.3	26	-1.8
25	2.9	28	-1.9
26	3	29	-1.4
28	2	30	-0.5
29	1.6	31	0
30	1.3	33	-0.2
31	0.4	34	0.4
33	-0.5	35	0.2
34	-1.1	36	0.4
35	-1.5	38	0.2
36	-1.6	39	0.2
38	-0.7	40	-0.2
39	-0.6	42	-1.3
40	-1.1	43	-1.1
42	-0.6	44	-1.9
43	0.5	45	-2.5
44	-0.1	47	-3.6
45	0.2	48	-3.9
47	0.4	49	-3.8

---

48	0.1	50	-5.7
49	0.4	51	-7.3
50	0.4	53	-7.6
51	0	54	-8.3
52	-0.4	55	-6.6
53	-0.5	56	-5.3
54	-0.5	57	-3.1
55	-0.2	58	-2.2
56	-0.1	59	-1.4
58	0.8	60	-0.4
59	0.3	61	0.4
60	-0.3	62	1.6
61	0.6	64	2.2
62	0.9	65	2
64	0.7	67	2.8
65	1.1	68	3.3
66	1.8	69	3.7
68	1.6	71	3.9
69	0.9	72	4.2
71	0.6	74	5.2
72	1.1	75	4.6
73	0.3	76	4.9
75	0.2	77	5.2
76	-1.1	78	5.1
77	-0.5	80	5.4
79	-1.6	81	5.2
80	-2.5	82	5.4
81	-2.7	83	5.1
82	-2.8	84	5.2
83	-3.8	85	5.2
84	-3.9	87	5.5
85	-4.2	88	4.9
87	-4.7	89	4.9
88	-4	90	4.3
89	-4.1	91	3.8
90	-4	93	3.9
91	-4.1	94	3.9
93	-4	95	3.5
94	-3.8	96	2.5
95	-4.1	98	3.2
96	-3.8	99	2
98	-3.7	100	1.6
99	-4.2	101	1.6
100	-3.2	103	0.4



---

101	-3.4	104	0.1
103	-3	105	-0.6
104	-4.2	107	-1.4
105	-3.9	108	-2.8
107	-2.6	109	-3.8
108	-2.2	110	-4.8
109	-2.6	112	-6.8
110	-2.6	113	-9.4
112	-1.8	114	-10.3
113	-2.1	115	-11.9
114	-2	117	-17.6
115	-0.7	118	-19.9
117	-0.9	119	-14.6
118	-0.3	120	-9.8
119	-0.2	121	-8
120	0.2	122	-6.5
121	0	123	-5
122	-0.4	124	-4.3
124	0.3	126	-3.2
125	0.7	127	-2.6
126	1	128	-2.4
127	-0.2	130	-0.8
128	0	131	-2.1
130	-0.1	132	-1.7
131	-0.6	134	-2.1
133	-0.7	135	-1.8
134	-0.6	136	-2
135	-0.6	138	-2.9
137	-0.2	139	-3
138	-0.6	140	-3.7
139	-1.4	142	-4
141	-1.6	143	-4.6
142	-1.3	144	-5.4
143	-1.7	145	-6.1
144	-1.3	147	-6.5
146	-1.5	148	-7.6
147	-1.6	149	-7.7
148	-1.5	150	-8.3
149	-2.4	151	-9.5
150	-3.4	152	-10.2
151	-4.1	153	-8.7
152	-4.1	154	-8.3
153	-4.1	156	-7.3
154	-3.8	157	-5.6

---

156	-4.7	158	-4.5
157	-4.6	159	-3
158	-4.7	160	-2.3
159	-4.8	162	-1.5
161	-4.1	163	-1.7
162	-2.6	164	-0.9
163	-1.9	165	-0.7
164	-2.2	167	-0.9
166	-2.2	168	-0.4
167	-1.5	169	-0.3
168	-0.9	171	-0.9
170	-0.2	172	-2.1
171	0	173	-1.4
172	0	175	-1.7
173	-0.2	176	-3.1
175	-0.7	177	-4
176	0	178	-2.9
177	-0.8	180	-4.3
179	0.3	181	-4.1
180	-0.2	182	-3.9
181	-1.4	183	-4.4
182	-2	184	-4.1
183	-1.6	185	-2.7
184	-0.8	187	-1.6
185	-0.2	188	0.4
187	-0.8	189	0.3
188	0.1	190	0.1
189	0.8	192	1.1
190	0.3	193	1.2
192	0	194	1.4
193	0.1	196	2.2
194	0.5	197	2.3
196	-0.3	198	2.9
197	-0.3	199	2.7
198	0	201	2.6
200	-0.3	202	2.7
201	-0.2	203	3.3
202	0.5	204	2.7
203	-0.5	205	2.6
205	0.4	207	3.1
206	1.1	208	2.8
207	1.6	209	2.6
208	1.9	211	3
210	2.1	212	2.4

---

211	2.1	213	2
212	1.8	214	2
213	3.3	215	2.2
214	2.6	216	2
215	2.4	217	1.1
216	1.9	218	0.6
217	1.7	220	0.8
218	2.2	221	0.8
220	2	222	0.2
221	2.5	223	0.3
222	3.2	224	0.3
223	2.3	226	-0.5
225	2.9	227	-0.6
226	3.8	228	-0.4
227	2.7	230	-0.8
229	3.5	231	-0.4
230	3.2	232	-0.9
231	4.2	234	-0.6
233	3.6	235	-0.9
234	3.9	236	-0.8
235	3.8	238	-0.7
237	2.8	239	-0.3
238	2.5	240	0.5
239	2.3	241	0.7
241	2.2	243	1.4
242	1.5	244	1.1
243	1.2	245	1.2
244	1.5	246	0.9
245	1.7	247	1.3
246	2	248	1.8
248	1.9	250	1.2
249	2.7	251	1.4
250	3	252	1.7
251	3.3	253	1.9
253	3.7	254	2.1
254	3.6	256	1.6
255	4.1	257	1.9
256	4	258	1.4
258	4.1	260	2.1
259	4.6	261	2.3
260	4.5	262	1.2
261	4.6	263	1.5
263	4.4	265	0.9
264	4.6	266	0.8

---

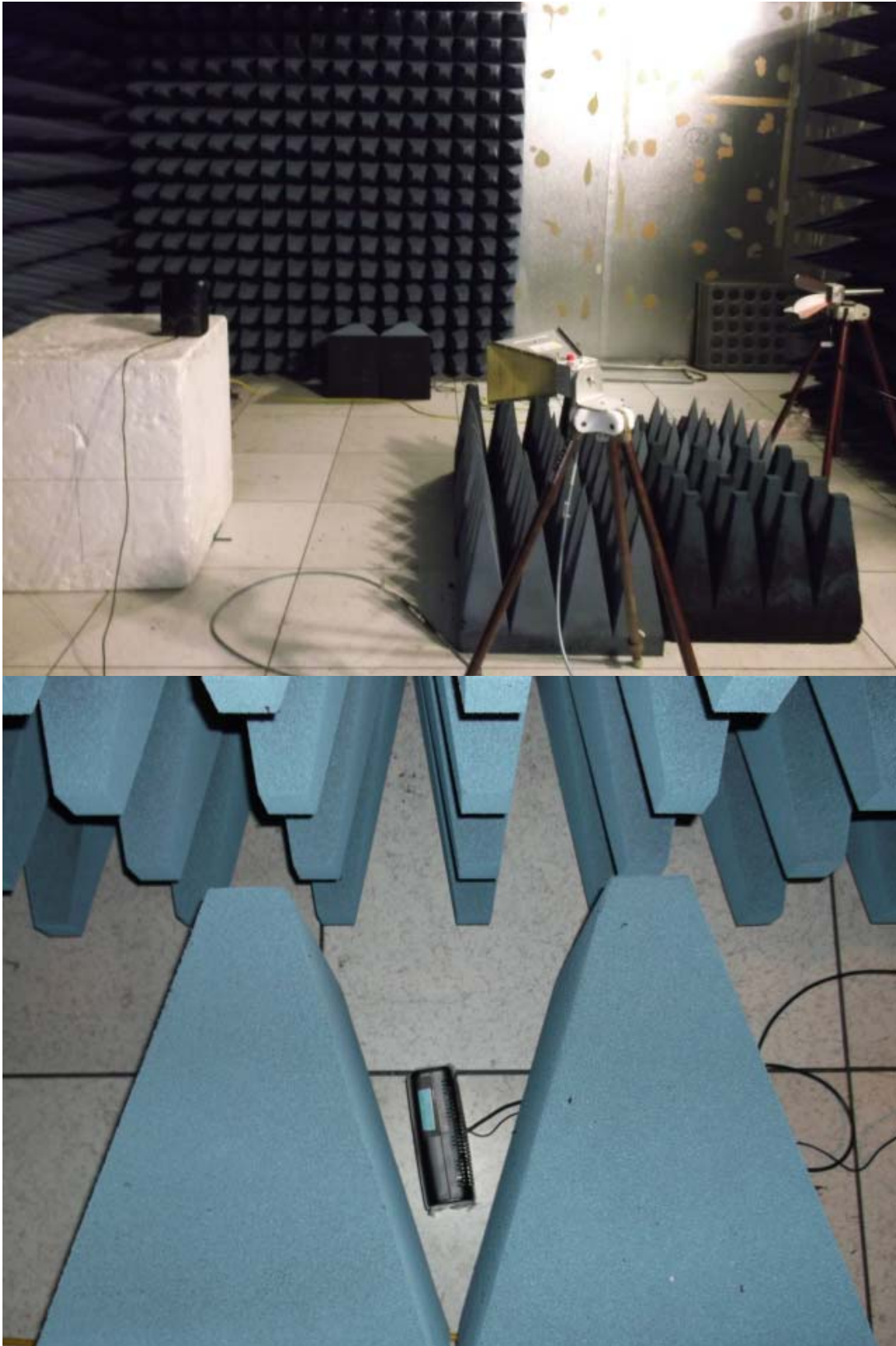
265	4.1	267	1
266	4.7	268	0.8
268	4.5	270	0.1
269	4.6	271	0.4
270	5.4	272	0.1
272	4.8	274	0.3
273	5.5	275	0.2
274	4.9	276	0.9
275	4.9	277	0.6
276	4.7	278	-0.1
277	5.2	279	0.4
279	4.7	280	0.3
280	4.8	281	0.7
281	5	282	0.4
283	4.6	284	0.1
285	4.6	285	1.1
286	3.8	286	1
287	3.6	287	0.5
288	2.8	289	0.2
290	2	290	0.5
291	1.2	292	0.4
292	0.9	293	0.7
294	0.6	294	0.9
295	0	296	0.1
296	-0.7	297	0.2
298	-1	298	0.4
299	-0.4	299	0
300	-1.4	301	0.5
301	-2.2	302	0.2
302	-1.8	303	0.8
304	-2.3	304	1
305	-3.1	305	-0.1
306	-2	307	0.2
307	-2.3	308	-0.3
308	-2.1	309	-0.4
310	-2.4	310	-0.1
311	-0.9	311	0.2
312	-0.5	312	0.1
313	-0.5	314	0.1
314	0.8	315	-0.4
316	1.2	316	-0.2
317	1.5	317	-0.1
318	0.8	318	0.2
319	0.9	320	-0.6

320	1.5	321	-0.3
322	0.7	322	-1
323	0.3	324	-0.2
324	0.5	325	-0.6
326	-0.7	326	0.1
327	-1.1	327	-0.2
328	-0.8	329	-0.4
330	-1.9	330	-0.2
331	-2.5	331	-0.4
332	-3.4	332	0.4
333	-3.3	333	-0.6
334	-4.3	335	0.3
336	-4.7	336	0.4
337	-4.4	337	0.2
338	-4.8	338	0.2
339	-5.8	339	-0.1
340	-5.6	340	0.1
341	-4.4	341	-0.2
342	-4.4	342	-0.2
343	-3.2	343	-0.1
344	-2.6	344	-0.3
345	-1.9	345	-0.4
346	-1.6	346	-0.1
347	-1.1	348	-0.6
348	-0.3	349	-0.6
349	0.5	350	-0.4
351	0.5	351	-0.2
352	0.5	352	0
353	0.1	353	0.4
354	0.4	354	0.5
355	-0.1	355	0.8
356	-0.2	356	1.8
357	-0.4	358	1.2
358	-0.7	359	1.4
359	-1.6		
Min TX	-5.8	-19.9	(Has a notch)
Max TX	5.5	5.5	

5564 RX (WU)			5250 RX (CU)		
Angle	RX Ant 1	RX Ant 2	angle	RX Ant 1	RX Ant 2
0	-1.5	-1	0	0.5	-3
10	-0.5	-2.5	10	-4.5	-1
20	-1.5	-5.5	20	-3	0
30	-2	-8	30	-8	-1
40	-1	-2	40	-8	-0.5
50	-3.5	-2	50	-8	-1.5
60	-5	-1	60	-10	4
70	-2	0	70	-10	-2.5
80	-0.5	-2	80	-7	2.5
90	-4	-8	90	-6	4
100	-4	-3	100	-5	1.5
110	-6	0	110	0	-4
120	-5	1.5	120	0	-2.5
130	-4	-1	130	0	0
140	1	-4	140	2	-1
150	-2	0	150	-1	-3
160	0	-1	160	0	-2
170	-4	0	170	5	-2.5
180	-2	1	180	1	-7
190	0	2	190	3	-7
200	1	-1	200	3	-6.5
210	-1	-1	210	2	-7
220	1	-1	220	0	-7
230	0	1	230	-2	-4
240	1	4	240	-4	-7
250	2.5	3	250	0	-7
260	2	1	260	-3	-7
270	2	-1	270	-6	-4
280	1	2	280	-8	-2
290	-3.5	2	290	-5	0
300	-3	2	300	2	-2
310	1	0	310	-2	-4
320	0	1	320	-1	0
330	1	0	330	-2	-4
340	-2	-1.5	340	2	-1
350	0	-1	350	0	-3
Min RX	-6	-8		-10	-7
Max RX	2.5	4		5	4

Appendix F Test Configuration Photograph(s)

WU as Master



CU as Master





**Appendix G DFS Implementation Proposal for Cel-Fi U-NII Link**



**NEXTIVITY**

**DFS Implementation Proposal for Cel-Fi U-NII Link**

Version 0.7

Monday, 23 February 2009

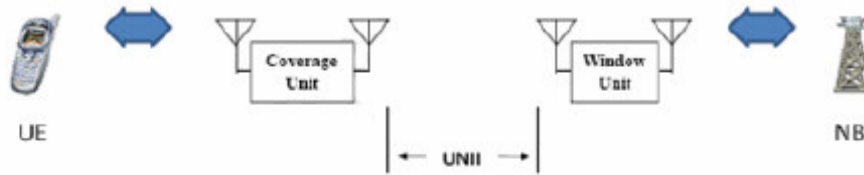
© Copyright Nextivity Inc. 2008, 2009. All Rights Reserved.

Nextivity Inc. Proprietary and Confidential

*The information contained in this document is Nextivity Inc. proprietary and confidential and is the sole property of Nextivity Inc. and shall not be used, copied, reproduced, or disclosed in whole or in part without written consent of Nextivity Inc.*

### 1. INTRODUCTION

Cel-Fi is a new product based on a split three-hop repeater concept designed to provide better indoor cellular coverage (Figure 1).



**Figure 1 - Cel-Fi Three-Hop Repeater System**

Cel-Fi consists of two devices, the Window Unit (WU) and the Coverage Unit (CU). The Window Unit is placed in the area of a home with the strongest signal from a wireless carrier. The WU communicates with the cell tower. The Coverage Unit is placed in the center of the home, communicates wirelessly with the WU and "lights up" the interior of the home with significantly enhanced signal, thus enabling better quality calls and greater download speeds.

### 2. U-NII BAND COMMUNICATION LINK

The Window Unit (WU) and the Coverage Unit (CU) communicate with each other using a proprietary point-to-point link in the U-NII band. The link requires the simultaneous use of two 40 MHz channels, where one is taken from the 5150-5350 MHz band and the other is taken from the 5470-5725 MHz band. This link is a frame-based proprietary system which bears no resemblance to 802.11 WLAN technology. The WU is the master device responsible for selecting both uplink and downlink frequencies, and for initiating transmission on the communication link.

The U-NII link uses MIMO technology to provide spatial diversity on the link. Each unit, WU and CU, has 2 transmit and 2 receive chains. Both WU and CU use identical transceivers, but some of the associated control electronics are different. From a DFS perspective the detection algorithms and receivers are the same.

The remainder of this document provides detail on the proposed DFS implementation for the U-NII link. The goal is to provide DFS functionality that satisfies both FCC and ETSI requirements.

### 3. OPERATIONAL MODES FOR DFS

The Cel-Fi system uses 4 operational modes which allow the two component devices (WU and CU) to synchronize with each other while satisfying DFS radar detection requirements. The modes are illustrated in Figure 2.

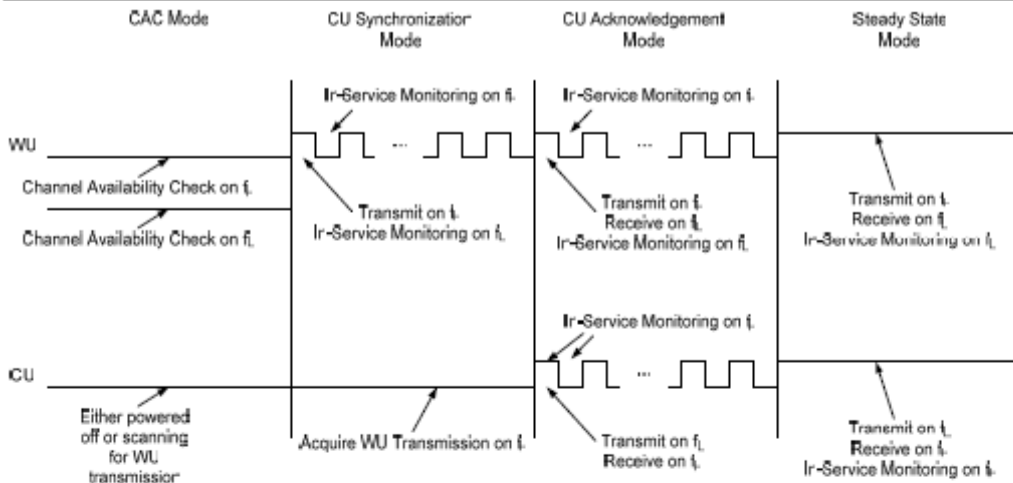


Figure 2 - U-NII Link Operational Modes

### 3.1. CAC Mode

When the WU is powered up, it performs a RSSI scan on all U-NII channels and then selects two of them for the Cel-Fi link ( $f_L$  from the 5150-5350 MHz band and  $f_H$  from the 5470-5725 MHz band). Prior to any transmission over a potential radar occupied channel, the WU will perform a channel availability check for at least 60 seconds. The WU hardware is capable of using the two receive antennas and two radio receivers to perform the CAC **simultaneously** on the selected upper and lower band channels.

In the event that the CU is powered on before the WU, it will not transmit on any U-NII channel, but will continue to scan for WU transmissions.

### 3.2. CU Synchronization Mode

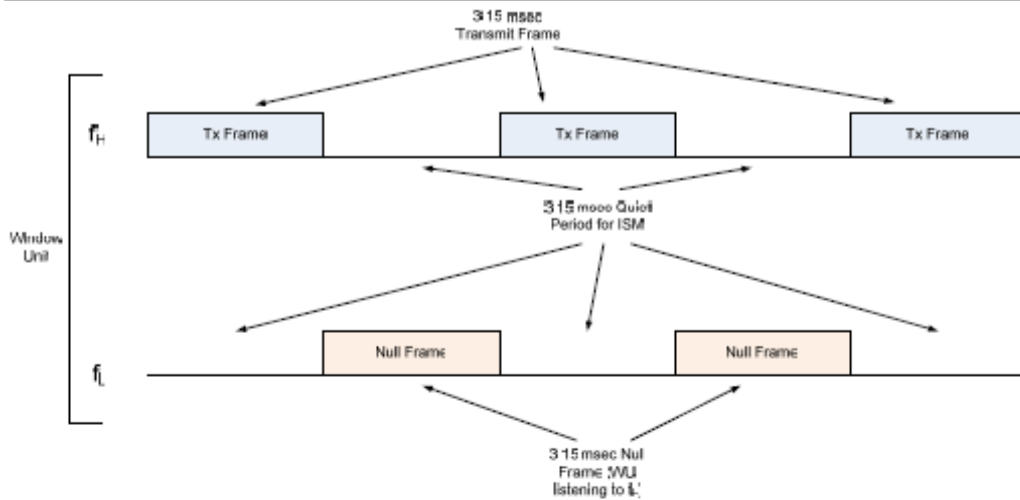
Following a successful CAC on both selected channels ( $f_H$  and  $f_L$ ), the WU will initiate transmission on  $f_H$ . The transmission will be performed using a 3.15 msec frame with a 50% transmit/receive duty cycle. While transmitting on  $f_H$ , the WU will listen for radar on  $f_L$ . When not transmitting, the WU will listen for radar on  $f_H$ . This allows the WU to perform in-service monitoring on both channels simultaneously.

During this period, the CU will normally be powered on and synchronize to the WU transmission on  $f_H$ . A control channel message will specify the frequency to use for  $f_L$ .

If the CU is powered on before the WU, then this mode of operation will typically last for 10-20 msec. If the WU is powered on before the CU, then this mode will last for an arbitrary duration until the CU is powered on.

#### 3.2.1. Proposed Channel Loading Scheme for In-Service Monitoring Tests During CU Synchronization Mode

In-service monitoring tests can be performed during this mode of operation by switching the WU on and leaving the CU switched off. In this mode, the loading on  $f_H$  will always be 50% due to the transmit/receive duty cycle. During this mode, there will never be any Cel-Fi generated traffic on  $f_L$ . However, null frame intervals will occur on  $f_L$  due to the WU receiver listening for radar on  $f_H$ . This would be equivalent to a channel load of 50%. The relevant timing is shown in Figure 3.



**Figure 3 - Channel Loading During CU Synchronization Mode**

In service monitoring tests will be performed on the WU for both  $f_H$  and  $f_L$  channels in this mode. In-service monitoring detection probability tests for all of the radar waveforms will be performed in this mode on the WU. Channel move and channel closing time measurements shall be made for the WU on  $f_H$  using radar types 1 and 5

### 3.3. CU Acknowledgement Mode

Once the CU synchronizes to the WU and determines the frequency of  $f_L$ , it may begin transmission on  $f_L$ . This transmission is performed using 3.15 msec frames with a 50% transmit/receive duty cycle. The transmissions coincide with the periods when the WU is listening on  $f_L$ .

In this mode the CU will begin in-service monitoring on  $f_H$  while the WU is performing in-service monitoring on both  $f_H$  and  $f_L$ .

This mode of operation should last no more than 90 msec. This worst case scenario would occur if the CU synchronizes with the WU but control messages are not correctly exchanged, eventually resulting in a timeout.

#### 3.3.1. Proposed Channel Loading Scheme for In-Service Monitoring Tests During CU Acknowledgment Mode

The Cel-Fi system will implement a DFS test mode that allows the system to be frozen in CU Acknowledgment mode. Although the system is normally in this mode for only a short period of time, it will facilitate evaluation of in-service monitoring performance while in this mode. In all cases, the channel loading will always be at 50% due to the normal Cel-Fi link traffic. The frame structure involved is shown in Figure 4.

As the duration of this mode is short, and as the normal operating mode described in the next section has significantly higher transmitter duty cycle (100%), it is not felt that this mode needs to be evaluated. If considered necessary, in-service monitoring can be performed on  $f_H$  and  $f_L$  at the WU and on  $f_H$  at the CU. If considered necessary, detection probability for radar waveforms 1 and 5 shall be evaluated in this mode just to confirm that in service monitoring does occur.

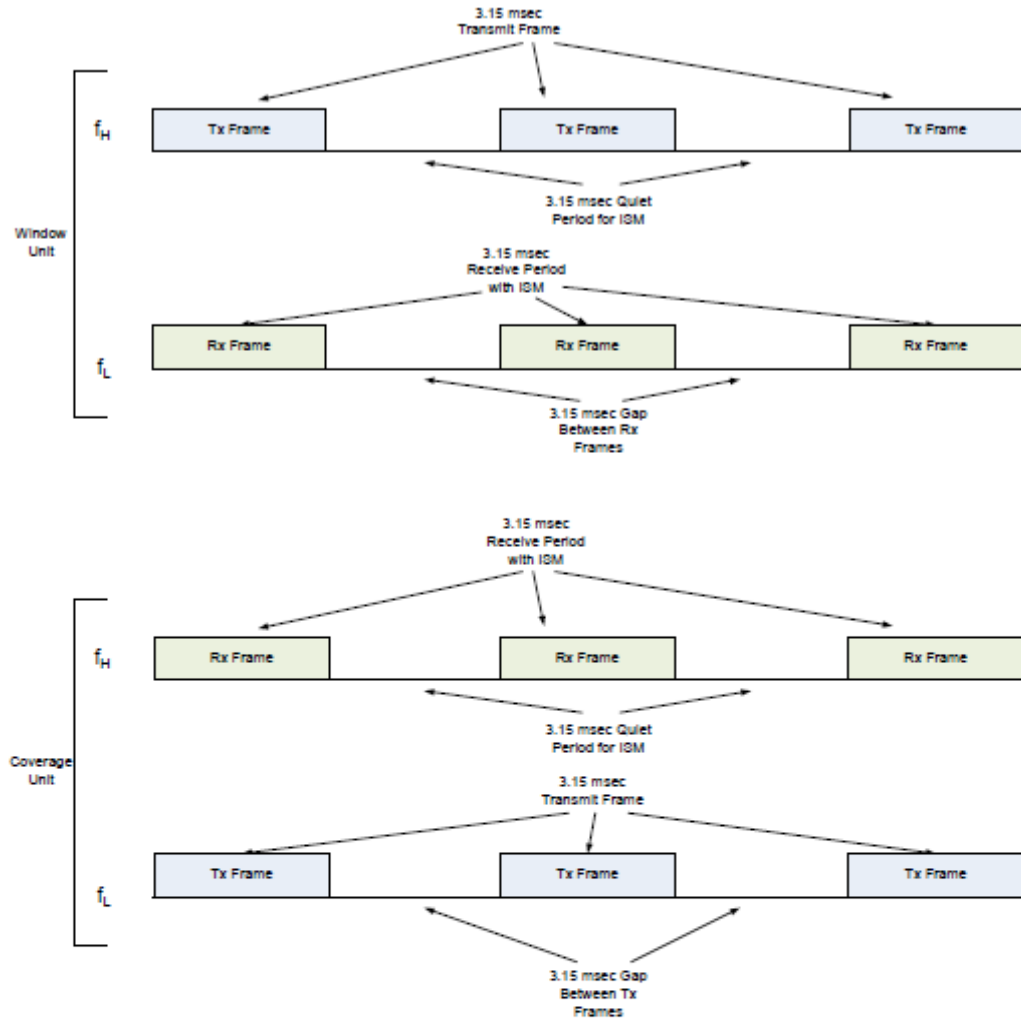
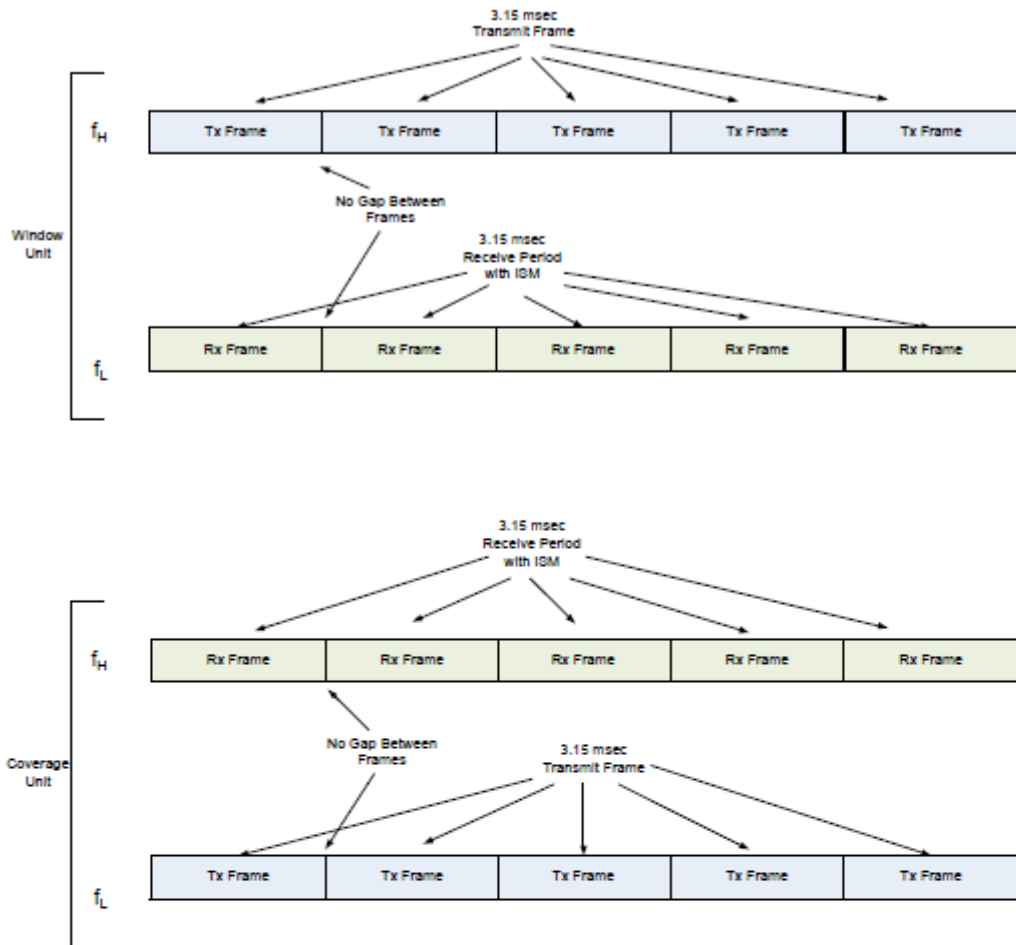


Figure 4 - Channel Loading During CU Acknowledgement Mode

### 3.4. Steady-State Mode

After the link is setup on both channels, the Cel-Fi system is able to switch into steady-state mode. The switch is coordinated between the WU and CU. In this mode the WU transmits continuously on  $f_H$  and listens continuously on  $f_L$ . The WU will be able to detect radar in the presence of the received data signal during in-service monitoring, so it effectively functions as a master for channel  $f_L$ . Similarly, the CU will transmit continuously on  $f_L$  and receive continuously on  $f_H$ . The CU will perform in-service monitoring on  $f_H$  and be the master for that channel. Thus in-service monitoring is being performed on both  $f_H$  and  $f_L$ . The frame structure for this mode is illustrated in Figure 5.



**Figure 5 - Channel Loading During Steady-State Mode**

During this mode, the channel loading is always 100% and does not change whether a cell phone call is active or not. Once the link is established between WU and CU devices, data is constantly streamed between the two so that the mobile phone remains on the network. When no phone call has been established from the user's cell phone to the network through the WU-CU, the channel is loaded with a constant stream of OFDM symbols consisting of control channel information, pilot tones, and randomly generated payload data. The randomly generated payload data required to maintain the WU-CU link is ignored by the receiver.

When a call is established through the WU-CU the randomly generated payload data between WU and CU is replaced with actual cell phone data. There is no way to determine whether a call is in progress through observation of the OFDM signal, as the signal will look identical in both cases.

In-service monitoring detection probability tests for all of the radar waveforms will be performed in this mode on the WU the CU. Channel move and channel closing time measurements shall be made for the WU and CU using radar types 1 and 5. These closing time tests will also evaluate the WU and CU in client mode. For these tests a cell call shall be established through the system using a call emulator rather than relying on the dummy payload packets

## 4. VACATING THE CHANNEL

### 4.1. Channel Move Time

In the event that one of the component Cel-Fi devices detects radar during in service monitoring, it will notify the other device through the reverse channel and cease transmitting in the radar occupied channel.

If for some reason the other device does not receive the message, it will detect that the link has been dropped and cease transmission. The assumption will be that radar has been detected.

The Cel-Fi system will ensure that the channel is vacated within 15 msec, well below the 10 second requirement.

### 4.2. Channel Closing Transmission Time

The worst case channel move time is less than the 60ms FCC and 260ms ETSI channel closing transmission times, so this requirement is automatically satisfied for both the FCC and ETSI.

### 4.3. Non-Occupancy Period

The WU will maintain a database of channels that have been identified as containing radar. These channels will not be used by the Cel-Fi system for the 30-minute non-occupancy period.

## 5. CHANNEL SELECTION

The WU will be responsible for U-NII channel selection for both the uplink and the downlink.

### 5.1. Uniform Loading

In order to satisfy the uniform loading requirement, the WU will scan all U-NII channels to perform a RSSI measurement prior to channel selection. The selected channels will be randomly selected from among those whose RSSI value is below a specified threshold.

### 5.2. 5600-5650 MHz

The initial version of the Cel-Fi system will make use of the 5600-5650 MHz portion of the U-NII band. It is likely that this part of the spectrum will not be used if:

- 1) Future changes in compliance specifications include a 10 minute CAC in the weather radar band.
- 2) Specific governments have blocked usage of these frequencies.

### 5.3. Channel Allocation

The lower U-NII band channels will be centered at 5190, 5210, 5230, 5250, 5270, 5290, and 5310 MHz. This utilizes 80% of the band spanning 5150-5350 MHz.

The upper U-NII band channels will be centered at 5510, 5530, 5550, 5570, 5590, 5610, 5630, 5650, 5670, and 5690 MHz. This utilizes 86% of the band spanning 5470-5725 MHz.

In the event that the 5600-5650 MHz band is not used, the upper band channels will be centered at 5510, 5530, 5550, 5570, 5670, and 5690 MHz. This utilizes 62% of the band spanning 5470-5725 MHz.



## 6. RADAR DETECTION

### 6.1. Detection Bandwidth

Although the U-NII link utilizes channels with a nominal bandwidth of 40 MHz, the occupied channel bandwidth is 33 MHz. The Cel-Fi devices are able to detect radar over approximately 97% of the 99% power bandwidth.

### 6.2. Detection Threshold

Since the Cel-Fi devices will transmit at a level well below 200 mW eirp, the radar detection threshold is -62 dBm.

### 6.3. Transmit Power Control

The Cel-Fi system employs transmit power control in order to keep the received signal level adequately below the radar detection threshold. At no time does the transmit power level become so great that a potential radar signal at or above the detection threshold is masked. The transmit power has a dynamic range of at least 30 dB.

During CU acknowledgement mode the WU will initially transmit at maximum power. The CU uses this information in conjunction with the measured RSSI to determine an appropriate initial transmit power level on  $f_L$ . Once an acknowledgment is received by the WU, the two units will fine tune their transmit power levels prior to switching into steady state mode.

### 6.4. Detection Probability

During CAC, the WU is able to detect 100% of the FCC or ETSI radar test signals. During in service monitoring, the detection rates will exceed those specified for both FCC and ETSI.

## 7. DOCUMENT HISTORY

Table 1 Document History

Date	Revision Number	Description	Author
July 15, 2008	0.1	Initial draft.	Richard Buz
August 1, 2008	0.2	Incorporate comments	
August 8, 2008	0.3	Added more information on the U-NII link and overall system. Elaborated on channel loading during in-service monitoring.	Richard Buz
August 8, 2008	0.4	Incorporated additional comments from Mark Briggs.	Richard Buz
September 24, 2008	0.5	Added detail for the content of Tx packets when there is or isn't a call established in response to a request from the FCC.  Added information that both WU and CU use the same transceivers and same DFS detection hardware and algorithm.  Proposed reduced tests on the CU for in-service monitoring.	Richard Buz Mark Briggs Elliott Labs



DFS Implementation Proposal For Cel-Fi U-NII Link  
Version 0.7 Monday, 23 February 2009



Date	Revision Number	Description	Author
December 16, 2008	0.6	Added detail following CTIA-FCC-Nextivity conference call	Mark Briggs Elliott Labs
February 23, 2009	0.7	<p>Modified document in accordance with NTIA feedback as follows:</p> <p>page 4 of 8, paragraph 1, NTIA requests the following changes to the Version 0.6 document dated December 16, 2008 as shown in redline/strikeout: <i>"In service monitoring tests will be performed on the WU for both <math>f_H</math> and <math>f_L</math> channels in this mode. In-service monitoring detection probability tests for all of the radar waveforms will be performed in this mode on the WU. Channel move and channel closing time measurements shall be made for the WU on <math>f_H</math> using radar types 1 and 5."</i></p> <p>On page 6 of 8, paragraph 3, NTIA requests the following changes to the Version 0.6 document dated December 16, 2008 as shown in redline/strikeout <i>"In-service monitoring detection probability tests for all of the radar waveforms will be performed in this mode on the WU the CU. Channel move and channel closing time measurements shall be made for the WU and CU using radar types 1 and 5. These closing time tests will also evaluate the WU and CU in client mode For these tests a cell call shall be established through the system using a call emulator rather than relying on the dummy payload packets"</i></p>	Mark Briggs Elliott Labs