

Nextivity, Inc.

ADDENDUM TO TEST REPORT 94857-6

**Provider Specific Consumer Signal Booster
Models: CELFI-RS224WU & CELFI-RS224CU**

Tested To The Following Standards:

FCC Part 20.21

Report No.: 94857-6A

Date of issue: February 7, 2014

We strive to create long-term, trust based relationships by providing sound, adaptive, customer first testing services. We embrace each of our customers' unique EMC challenges, not as an interruption to set processes, but rather as the reason we are in business.

TABLE OF CONTENTS

Administrative Information 3

 Test Report Information 3

 Revision History 3

 Report Authorization 3

 Test Facility Information 4

 Software Versions 4

 Site Registration & Accreditation Information 4

 Summary of Results 5

 Conditions During Testing 5

 Equipment Under Test 6

 Peripheral Devices 6

FCC Part 20.21 7

 FCC 20.21(e)(9)(i)(A) Noise Limit 7

 FCC 20.21(e)(9)(i)(B) Bidirectional Capability/ FCC 20.21(e)(3) Frequency Bands 18

 FCC 20.21(e)(9)(i)(C) Booster Gain Limit 31

 FCC 20.21(e)(9)(i)(E) Out of Band Gain 36

 FCC 20.21(e)(9)(i)(F) Out of Band Emission Limits 43

 FCC 20.21(e)(9)(i)(G) Intermodulation 55

 FCC 20.21(e)(9)(i)(I) Transmit Power – Off Mode 61

 FCC 20.21(e)(9)(i)(J) Uplink Inactivity 67

 FCC 20.21(e)(9)(ii)(A) Anti Oscillation Detection 70

ADMINISTRATIVE INFORMATION

Test Report Information

REPORT PREPARED FOR:

Nextivity, Inc.
12230 World Trade Dr.
San Diego, CA 92128

Representative: Michiel Lotter

REPORT PREPARED BY:

Joyce Walker
CKC Laboratories, Inc.
5046 Sierra Pines Drive
Mariposa, CA 95338

Project Number: 94857

DATE OF EQUIPMENT RECEIPT:

September 24, 2013

DATE(S) OF TESTING:

September 24- October 11, 2013

Revision History

Original: Testing of the Provider Specific Consumer Signal Booster, CELFI-RS224WU & CELFI-RS224CU to FCC 20.21.

Addendum A: Report has been revised to address FCC Correspondence Reference Number 45219.

Report Authorization

The test data contained in this report documents the observed testing parameters pertaining to and are relevant for only the sample equipment tested in the agreed upon operational mode(s) and configuration(s) as identified herein. Compliance assessment remains the client's responsibility. This report may not be used to claim product endorsement by A2LA or any government agencies. This test report has been authorized for release under quality control from CKC Laboratories, Inc.



Steve Behm
Director of Quality Assurance & Engineering Services
CKC Laboratories, Inc.

Test Facility Information



Our laboratories are configured to effectively test a wide variety of product types. CKC utilizes first class test equipment, anechoic chambers, data acquisition and information services to create accurate, repeatable and affordable test results.

TEST LOCATION(S):
CKC Laboratories, Inc.
110 Olinda Place
Brea, CA 92823

Software Versions

CKC Laboratories Proprietary Software	Version
EMITest Emissions	5.00.14
Immunity	5.00.07

Site Registration & Accreditation Information

Location	CB #	TAIWAN	CANADA	FCC	JAPAN
Brea A	US0060	SL2-IN-E-1146R	3082D-1	90473	A-0147

SUMMARY OF RESULTS

Standard / Specification: FCC Part 20.21

Description	Test Procedure/Method	Results
Noise Limit	FCC Part 20.21(e)(9)(i)(A)	Pass
Bidirectional Capability	FCC Part 20.21(e)(9)(i)(B)	Pass
Booster Gain Limit	FCC Part 20.21(e)(9)(i)(C)	Pass
Out of Band Gain	FCC Part 20.21(e)(9)(i)(E)	Pass
Out of Band Emission Limits	20.21(e)(9)(i)(F)	Pass
Intermodulation	20.21(e)(9)(i)(G)	Pass
Transmit Power - Off mode	20.21(e)(9)(i)(I)	Pass
Uplink Inactivity	20.21(e)(9)(i)(J)	Pass
Anti-Oscillation Detection	20.21(e)(9)(ii)(A)	Pass

Conditions During Testing

This list is a summary of the conditions noted for or modifications made to the equipment during testing.

Summary of Conditions
None

EQUIPMENT UNDER TEST (EUT)

EQUIPMENT UNDER TEST

Provider Specific Consumer Signal Booster

Manuf: Nextivity, Inc.

Models: CELFI-RS224WU & CELFI-RS224CU

Serial: 159311000046

PERIPHERAL DEVICES

The EUT was not tested with peripheral devices.

FCC PART 20.21

This report contains EMC test results under United States Federal Communications Commission (FCC) §20.21, requirements for Provider-Specific Consumer Signal Boosters.

FCC 20.21(e)(9)(i)(A) Noise Limit

Test Conditions / Setup REV. 0.1 Noise Power

Test Location: CKC Laboratories, Inc. • 110 North Olinda Place • Brea, CA 92823 • 714-993-6112

Customer: **Nextivity, Inc.**

Specification: **20.21(e)(9)(i)(A) Noise Limit**

Work Order #: **94857** Date: 9/24/2013

Test Type: **Conducted Emissions** Time: 08:31:39

Equipment: **Provider Specific Consumer Signal Booster** Sequence#: 1

Manufacturer: Nextivity, Inc. Tested By: E. Wong

Model: CELFI-RS224WU, CELFI-RS224CU 110V 60Hz

S/N: 159311000046, 159311000046

Test Equipment:

ID	Asset #	Description	Model	Calibration Date	Cal Due Date
	AN02869	Spectrum Analyzer	E4440A	2/6/2013	2/6/2015
	AN03418	Signal Generator	Agilent	7/26/2013	7/26/2013
	C00032	Signal Generator	Agilent	9/20/2013	09/20/2013
	AN02946	Cable	Astrolab Inc.	7/31/2013	7/31/2015

Equipment Under Test (* = EUT):

Function	Manufacturer	Model #	S/N
Provider Specific Consumer Signal Booster*	Nextivity, Inc.	CELFIR-S224WU	159311000046
Provider Specific Consumer Signal Booster	Nextivity, Inc.	CELFIR-S224CU	159311000046

Test Conditions / Notes:

The EUT is provider specific signal booster pair consisted of a Window unit (WU) and a Coverage unit (CU) using proprietary 5.8 GHz Wireless interface.

Intended band of operation
 UL= 1850-1910 MHz, 1710-1755MHz
 DL= 1930-1990MHz, 2110-2155MHz.

The EUT is capable operating in 5 MHz segment within the CMRS band by setting the Spectrum Block Filter based on received command. For testing purposes, the Spectrum block filter is set manually using a laptop and test software interface.

Test environment conditions: 22°C, 32% Relative Humidity, 100kPa

Test was performed in accordance with section 7.7 of the FCC document: **935210 D03 Wideband Consumer Signal Booster Measurement Guidance DR04-41516.**

Test Data

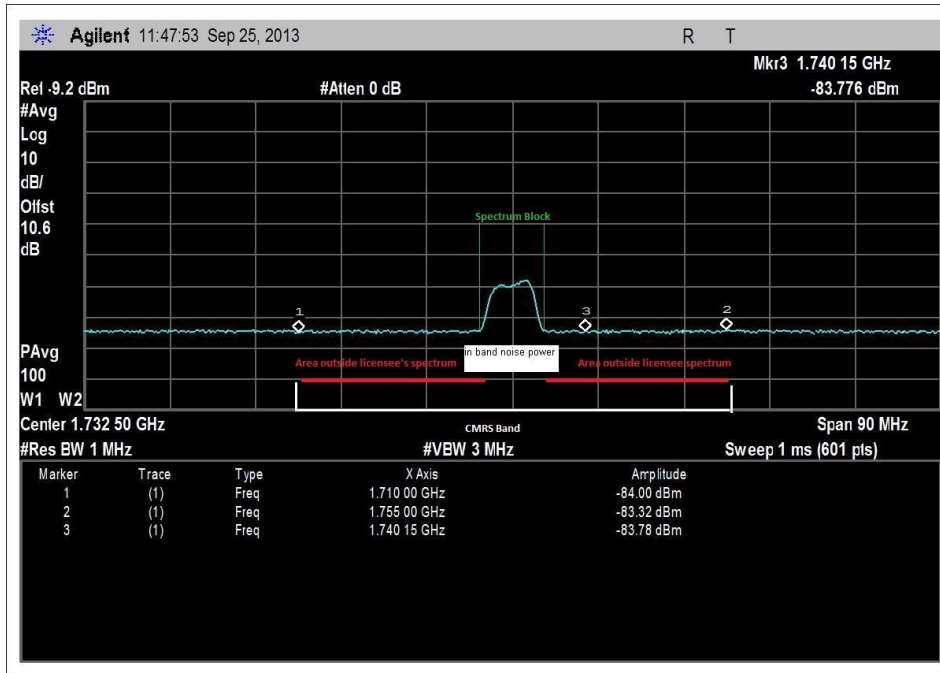

Note: The Booster is designed to boost wideband signal within a preset spectrum block.

To measure Uplink Noise Power outside the licensee's spectrum block in the presence of a Down link Signal, the Center channel was activated, and a 4.1 MHz AWGN DL signal with amplitude set from -90 to -20dBm was set center of the CMRS band. Note that due to the design of this booster, RSSI within the licensee's spectrum block was considered.

The maximum noise level outside the licensee's spectrum block as indicated in red in the above plots was measured with respect to variable RSSI and result presented in the plot below.

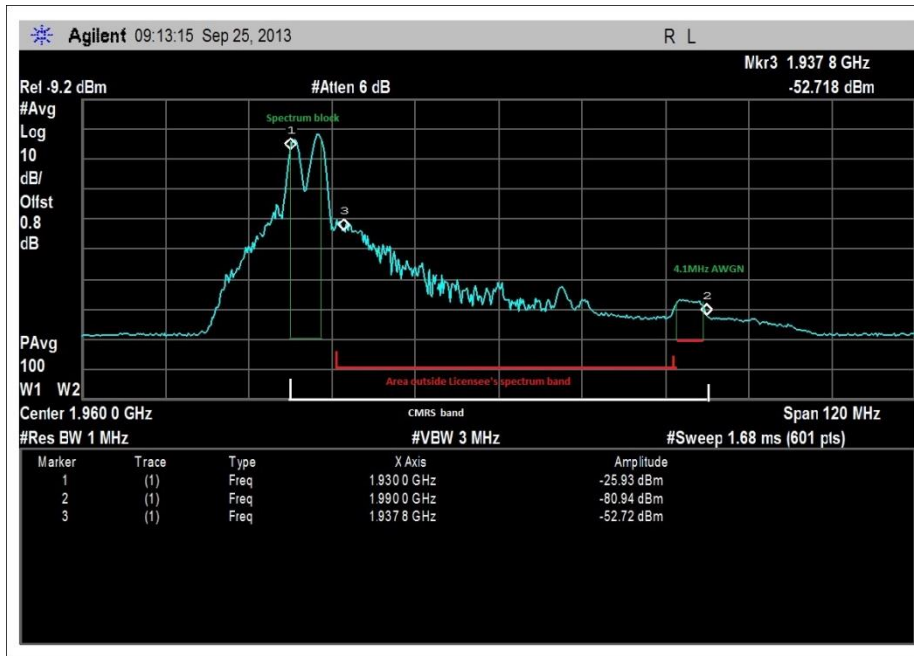

To measure Downlink noise power outside the licensee's spectrum block in the presence of a downlink signal. For this measurement, the lowest channel is activated and a 4.1 MHz AWGN signal with amplitude set from -90 to -20dBm was set at the upper CMRS band, 2.5 MHz away from the CMRS bandedge. The Noise power from between the lower channel band edge and the AWGN was measured. To improve accuracy, a notch filter was used to reduce the Noise level within the activated spectrum block.

The maximum noise level outside the licensee's spectrum block as indicated in red in the above plots was measured with respect to variable RSSI and result presented in the plot below.

Note For this test mode, the EUT is set to continuous operate regardless of RSSI. Another test was later performed with Transmit Power off set at DL RSSI of -40dBm, **the noise power in Transmitter Power Off mode was recorded and included in the following plot.**

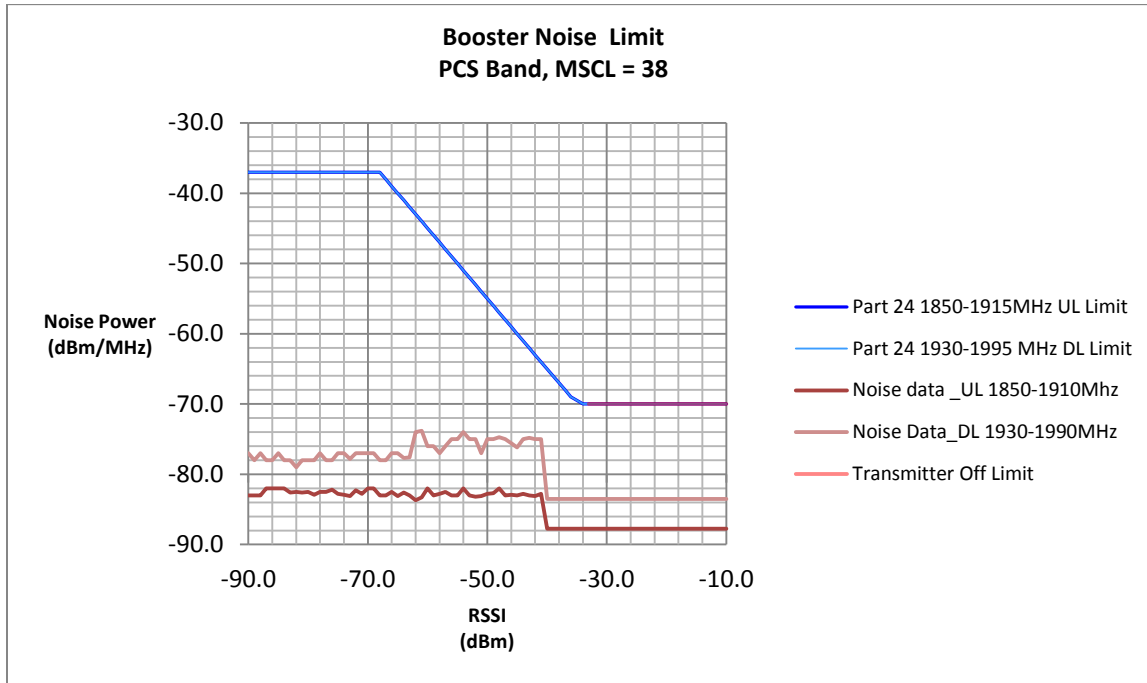

Uplink and Downlink Noise Power Levels with respect to RSSI Levels (PCS Band)

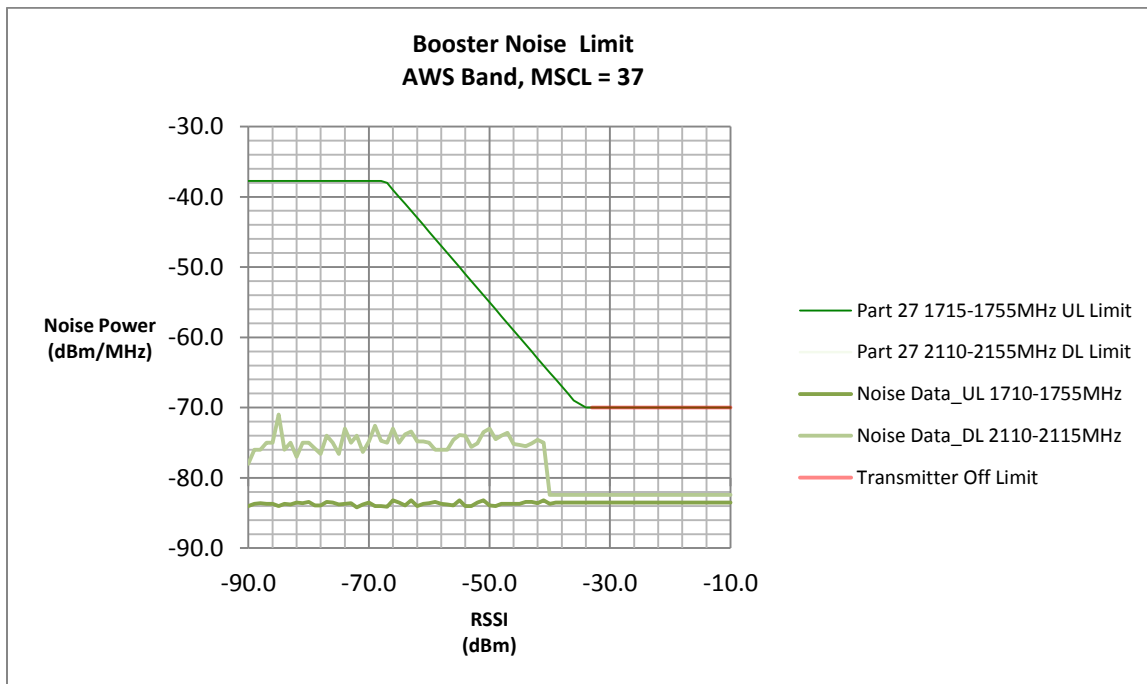

Uplink and Downlink Noise Power Levels with respect to RSSI Levels (AWS Band)

Summary Measurement Table for Noise Limits Test												
RSSI (dBm)	Measured Noise dBm/MHz				Limit Line				Margin			
	UL	DL	UL	DL	UL	DL	UL	DL	UL	DL	UL	DL
RF Off	1882.5	1962.5	1732.5	2132.5	1882.5	1962.5	1732.5	2132.5	1882.5	1962.5	1732.5	2132.5
-90	-83	-77	-84	-78	-37.0	-37.0	-37.7	-37.7	-46.0	-40.0	-46.3	-40.3
-89	-83	-78	-83.7	-76	-37.0	-37.0	-37.7	-37.7	-46.0	-41.0	-46.0	-38.3
-88	-83	-77	-83.6	-76	-37.0	-37.0	-37.7	-37.7	-46.0	-40.0	-45.9	-38.3
-87	-82	-78	-83.7	-75	-37.0	-37.0	-37.7	-37.7	-45.0	-41.0	-46.0	-37.3
-86	-82	-78	-83.7	-75	-37.0	-37.0	-37.7	-37.7	-45.0	-41.0	-46.0	-37.3
-85	-82	-77	-84	-71	-37.0	-37.0	-37.7	-37.7	-45.0	-40.0	-46.3	-33.3
-84	-82	-78	-83.7	-76	-37.0	-37.0	-37.7	-37.7	-45.0	-41.0	-46.0	-38.3
-83	-82.6	-78	-83.8	-75	-37.0	-37.0	-37.7	-37.7	-45.6	-41.0	-46.1	-37.3
-82	-82.5	-79	-83.5	-77	-37.0	-37.0	-37.7	-37.7	-45.5	-42.0	-45.8	-39.3
-81	-82.6	-78	-83.6	-75	-37.0	-37.0	-37.7	-37.7	-45.6	-41.0	-45.9	-37.3
-80	-82.5	-78	-83.4	-75	-37.0	-37.0	-37.7	-37.7	-45.5	-41.0	-45.7	-37.3
-79	-82.9	-78	-83.9	-75.8	-37.0	-37.0	-37.7	-37.7	-45.9	-41.0	-46.2	-38.1
-78	-82.5	-77	-83.9	-76.6	-37.0	-37.0	-37.7	-37.7	-45.5	-40.0	-46.2	-38.9
-77	-82.5	-78	-83.4	-74	-37.0	-37.0	-37.7	-37.7	-45.5	-41.0	-45.7	-36.3
-76	-82.2	-78	-83.5	-75	-37.0	-37.0	-37.7	-37.7	-45.2	-41.0	-45.8	-37.3
-75	-82.8	-77	-83.8	-76.6	-37.0	-37.0	-37.7	-37.7	-45.8	-40.0	-46.1	-38.9
-74	-82.9	-77	-83.7	-73	-37.0	-37.0	-37.7	-37.7	-45.9	-40.0	-46.0	-35.3
-73	-83.1	-77.8	-83.6	-75	-37.0	-37.0	-37.7	-37.7	-46.1	-40.8	-45.9	-37.3
-72	-82.3	-77	-84.2	-74	-37.0	-37.0	-37.7	-37.7	-45.3	-40.0	-46.5	-36.3
-71	-82.8	-77	-83.8	-76.3	-37.0	-37.0	-37.7	-37.7	-45.8	-40.0	-46.1	-38.6
-70	-82	-77	-83.5	-74.8	-37.0	-37.0	-37.7	-37.7	-45.0	-40.0	-45.8	-37.1
-69	-82	-77	-84	-72.6	-37.0	-37.0	-37.7	-37.7	-45.0	-40.0	-46.3	-34.9
-68	-83	-78	-84	-74.7	-37.0	-37.0	-38.0	-38.0	-46.0	-41.0	-46.0	-36.7
-67	-83	-78	-84.1	-75	-38.0	-38.0	-39.0	-39.0	-45.0	-40.0	-45.1	-36.0
-66	-82.5	-77	-83.2	-73	-39.0	-39.0	-40.0	-40.0	-43.5	-38.0	-43.2	-33.0
-65	-83.1	-77	-83.5	-75	-40.0	-40.0	-41.0	-41.0	-43.1	-37.0	-42.5	-34.0
-64	-82.6	-77.7	-83.9	-73.8	-41.0	-41.0	-42.0	-42.0	-41.6	-36.7	-41.9	-31.8
-63	-83	-77.6	-83.2	-73.4	-42.0	-42.0	-43.0	-43.0	-41.0	-35.6	-40.2	-30.4
-62	-83.7	-74	-84	-74.8	-43.0	-43.0	-44.0	-44.0	-40.7	-31.0	-40.0	-30.8
-61	-83.3	-73.8	-83.7	-74.8	-44.0	-44.0	-45.0	-45.0	-39.3	-29.8	-38.7	-29.8
-60	-82	-76	-83.6	-75	-45.0	-45.0	-46.0	-46.0	-37.0	-31.0	-37.6	-29.0
-59	-83	-76	-83.4	-76	-46.0	-46.0	-47.0	-47.0	-37.0	-30.0	-36.4	-29.0
-58	-82.8	-77	-83.7	-76	-47.0	-47.0	-48.0	-48.0	-35.8	-30.0	-35.7	-28.0
-57	-82.5	-76	-83.8	-76	-48.0	-48.0	-49.0	-49.0	-34.5	-28.0	-34.8	-27.0
-56	-83	-75	-83.9	-74.6	-49.0	-49.0	-50.0	-50.0	-34.0	-26.0	-33.9	-24.6
-55	-83	-75	-83.2	-73.9	-50.0	-50.0	-51.0	-51.0	-33.0	-25.0	-32.2	-22.9
-54	-82	-74	-84	-74	-51.0	-51.0	-52.0	-52.0	-31.0	-23.0	-32.0	-22.0
-53	-83	-75	-84	-75.6	-52.0	-52.0	-53.0	-53.0	-31.0	-23.0	-31.0	-22.6
-52	-83.2	-75	-83.5	-75.1	-53.0	-53.0	-54.0	-54.0	-30.2	-22.0	-29.5	-21.1
-51	-83.1	-77	-83.2	-73.5	-54.0	-54.0	-55.0	-55.0	-29.1	-23.0	-28.2	-18.5
-50	-82.8	-75	-83.9	-73	-55.0	-55.0	-56.0	-56.0	-27.8	-20.0	-27.9	-17.0
-49	-82.7	-75	-84	-74.5	-56.0	-56.0	-57.0	-57.0	-26.7	-19.0	-27.0	-17.5
-48	-82	-74.7	-83.7	-74	-57.0	-57.0	-58.0	-58.0	-25.0	-17.7	-25.7	-16.0
-47	-83	-75	-83.7	-73.6	-58.0	-58.0	-59.0	-59.0	-25.0	-17.0	-24.7	-14.6
-46	-82.9	-75.6	-83.7	-75.2	-59.0	-59.0	-60.0	-60.0	-23.9	-16.6	-23.7	-15.2
-45	-83	-76.2	-83.7	-75.3	-60.0	-60.0	-61.0	-61.0	-23.0	-16.2	-22.7	-14.3
-44	-82.8	-75	-83.4	-75.5	-61.0	-61.0	-62.0	-62.0	-21.8	-14.0	-21.4	-13.5
-43	-83	-74.8	-83.4	-75.1	-62.0	-62.0	-63.0	-63.0	-21.0	-12.8	-20.4	-12.1
-42	-83.1	-75	-83.6	-74.6	-63.0	-63.0	-64.0	-64.0	-20.1	-12.0	-19.6	-10.6
-41	-82.8	-75	-83.2	-75	-64.0	-64.0	-65.0	-65.0	-18.8	-11.0	-18.2	-10.0
-40	-87.73	-83.5	-83.7	-82.42	-65.0	-65.0	-66.0	-66.0	-22.7	-18.5	-17.7	-16.4
-39	-87.73	-83.5	-83.5	-82.42	-66.0	-66.0	-67.0	-67.0	-21.7	-17.5	-16.5	-15.4
-38	-87.73	-83.5	-83.5	-82.42	-67.0	-67.0	-68.0	-68.0	-20.7	-16.5	-15.5	-14.4
-37	-87.73	-83.5	-83.5	-82.42	-68.0	-68.0	-69.0	-69.0	-19.7	-15.5	-14.5	-13.4
-36	-87.73	-83.5	-83.5	-82.42	-69.0	-69.0	-70.0	-70.0	-18.7	-14.5	-13.5	-12.4
-34	-87.73	-83.5	-83.5	-82.42	-70.0	-70.0	-70.0	-70.0	-17.7	-13.5	-13.5	-12.4
-33	-87.73	-83.5	-83.5	-82.42	-70.0	-70.0	-70.0	-70.0	-17.7	-13.5	-13.5	-12.4
-32	-87.73	-83.5	-83.5	-82.42	-70.0	-70.0	-70.0	-70.0	-17.7	-13.5	-13.5	-12.4
-31	-87.73	-83.5	-83.5	-82.42	-70.0	-70.0	-70.0	-70.0	-17.7	-13.5	-13.5	-12.4
-30	-87.73	-83.5	-83.5	-82.42	-70.0	-70.0	-70.0	-70.0	-17.7	-13.5	-13.5	-12.4
-29	-87.73	-83.5	-83.5	-82.42	-70.0	-70.0	-70.0	-70.0	-17.7	-13.5	-13.5	-12.4
-28	-87.73	-83.5	-83.5	-82.42	-70.0	-70.0	-70.0	-70.0	-17.7	-13.5	-13.5	-12.4
-27	-87.73	-83.5	-83.5	-82.42	-70.0	-70.0	-70.0	-70.0	-17.7	-13.5	-13.5	-12.4
-26	-87.73	-83.5	-83.5	-82.42	-70.0	-70.0	-70.0	-70.0	-17.7	-13.5	-13.5	-12.4
-25	-87.73	-83.5	-83.5	-82.42	-70.0	-70.0	-70.0	-70.0	-17.7	-13.5	-13.5	-12.4
-24	-87.73	-83.5	-83.5	-82.42	-70.0	-70.0	-70.0	-70.0	-17.7	-13.5	-13.5	-12.4
-23	-87.73	-83.5	-83.5	-82.42	-70.0	-70.0	-70.0	-70.0	-17.7	-13.5	-13.5	-12.4
-22	-87.73	-83.5	-83.5	-82.42	-70.0	-70.0	-70.0	-70.0	-17.7	-13.5	-13.5	-12.4
-21	-87.73	-83.5	-83.5	-82.42	-70.0	-70.0	-70.0	-70.0	-17.7	-13.5	-13.5	-12.4
-20	-87.73	-83.5	-83.5	-82.42	-70.0	-70.0	-70.0	-70.0	-17.7	-13.5	-13.5	-12.4
-19	-87.73	-83.5	-83.5	-82.42	-70.0	-70.0	-70.0	-70.0	-17.7	-13.5	-13.5	-12.4
-18	-87.73	-83.5	-83.5	-82.42	-70.0	-70.0	-70.0	-70.0	-17.7	-13.5	-13.5	-12.4
-17	-87.73	-83.5	-83.5	-82.42	-70.0	-70.0	-70.0	-70.0	-17.7	-13.5	-13.5	-12.4
-16	-87.73	-83.5	-83.5	-82.42	-70.0	-70.0	-70.0	-70.0	-17.7	-13.5	-13.5	-12.4
-15	-87.73	-83.5	-83.5	-82.42	-70.0	-70.0	-70.0	-70.0	-17.7	-13.5	-13.5	-12.4
-14	-87.73	-83.5	-83.5	-82.42	-70.0	-70.0	-70.0	-70.0	-17.7	-13.5	-13.5	-12.4
-13	-87.73	-83.5	-83.5	-82.42	-70.0	-70.0	-70.0	-70.0	-17.7	-13.5	-13.5	-12.4
-12	-87.73	-83.5	-83.5	-82.42	-70.0	-70.0	-70.0	-70.0	-17.7	-13.5	-13.5	-12.4
-11	-87.73	-83.5	-83.5	-82.42	-70.0	-70.0	-70.0	-70.0	-17.7	-13.5	-13.5	-12.4
-10	-87.73	-83.5	-83.5	-82.42	-70.0	-70.0	-70.0	-70.0	-17.7	-13.5	-13.5	-12.4

In accordance with 20.21(e)(9)(i)(A)(1)(ii), boosters with MSCL less than 40 dB, shall reduce the noise output in 20.21(e)(9)(i)(A) by 40dB - MSCL. Therefore, in the case where MSCL is less than 40, the noise power shall not exceed -103 dBm/MHz – RSSI – (40 - MSCL).

Variable Uplink and Downlink Noise Timing

The test was performed in accordance with section 7.7.14 of the FCC document: **935210 D03 Wideband Consumer Signal Booster Measurement Guidance DR04-41516**. The Uplink and Downlink circuit are identical, hence only uplink noise timing is evaluated.

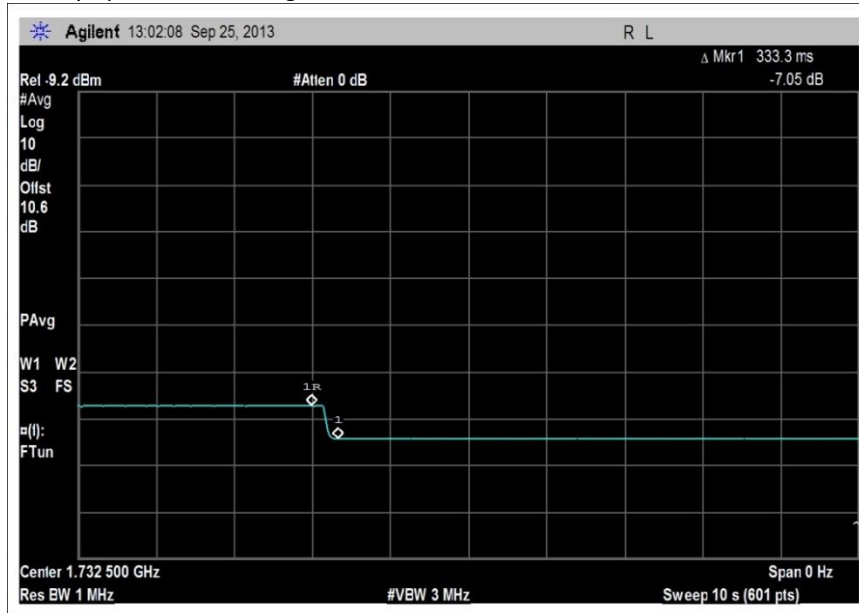

7.7.14 UL Timing_1710-1755MHz

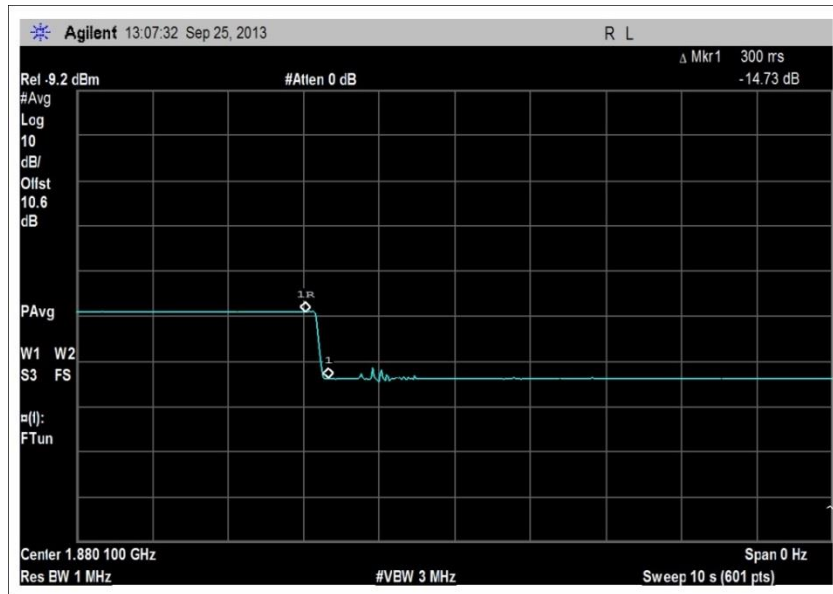

7.7.14 UL Timing_1850-1910MHz

Variable Uplink Noise Timing Summary Table				
UL Band (MHz)	Measured Uplink Timing (sec)	Mobile Limit (sec)	Fixed Limit (sec)	Result
1710-1755	0.3333	< 1	< 3	PASS
1850-1910	0.3	< 1	< 3	PASS

Test Conditions / Setup Power Off --40dBm

Test Location: CKC Laboratories, Inc. • 110 North Olinda Place • Brea, CA 92823 • 714-993-6112

Customer: **Nextivity, Inc.**
 Specification: **Power off at DL signal of --40dBm**
 Work Order #: **94857** Date: 9/24/2013
 Test Type: **Conducted Emissions** Time: 08:31:39
 Equipment: **Provider Specific Consumer Signal Booster** Sequence#: 1
 Manufacturer: Nextivity, Inc. Tested By: E. Wong
 Model: CELFI-RS224WU, CELFI-RS224CU 110V 60Hz
 S/N: 159311000046, 159311000046

Test Equipment:

ID	Asset #	Description	Model	Calibration Date	Cal Due Date
	AN02869	Spectrum Analyzer	E4440A	2/6/2013	2/6/2015
	AN03418	Signal Generator	Agilent	7/26/2013	7/26/2013
	AN02946	Cable	Astrolab Inc.	7/31/2013	7/31/2015

Equipment Under Test (* = EUT):

Function	Manufacturer	Model #	S/N
Provider Specific Consumer Signal Booster*	Nextivity, Inc.	CELFIR-S224WU	159311000046
Provider Specific Consumer Signal Booster	Nextivity, Inc.	CELFIR-S224CU	159311000046

Test Conditions / Notes:

The EUT is provider specific signal booster pair consisted of a Window unit (WU) and a Coverage unit (CU) using proprietary 5.8 GHz Wireless interface.
 Intended band of operation
 UL= 1850-1910 MHz, 1710-1755MHz; DL= 1930-1990MHz, 2110-2155MHz.
 The EUT is capable operating in 5 MHz segment within the CMRS band by setting the Spectrum Block Filter, gain and other operational parameter based on received public land mobile network (PLMN) ID.
 For testing purposes, the Spectrum block filter and operation of the booster is set in test mode using a laptop and test software interface. Test environment conditions: 22°C, 32% Relative Humidity, 100kPa
 This test data is supplementary data to noise limits section 7.7 of the FCC document: 935210 D03 Wideband Consumer Signal Booster Measurement Guidance DR04-41516. The EUT is designed to shut off with an RSSI of -40dBm. This data is included to show that the unit does indeed shut off at -40dBm and when it does, the noise power level is below the limit line of -70 dBm/MHz as called out in 20.21(e)(8)(i)(H).

The Booster is designed to enter power off limit when the DL link power exceeds -40dBm where it does not meet the noise and gain limit.

For testing, due to the unique operation of this booster, the Uplink signal was initially off, a 5MHz WCDMA DL signal at below -40dBm, set at lower band edge was sent to the Booster to initialize operation. The span of the spectrum analyzer was set to capture the CMRS band. A plot was captured, showing the noise power when the booster is active.

The 5MH WCDMA DL signal was then increased to -40dBm, without changing the spectrum analyzer setting, a plot of Transmitter power off was captured to demonstrate when the DL signal reaches -40dBm, the Booster will enter Transmit power off. The same shut down circuit controls the uplink path, hence the Uplink path will shut down as well when the down link signal reaches -40dBm.

Note: A Notch filter was used in the setup to reduce the level of WCDMA signal into the spectrum analyzer.

Test Data

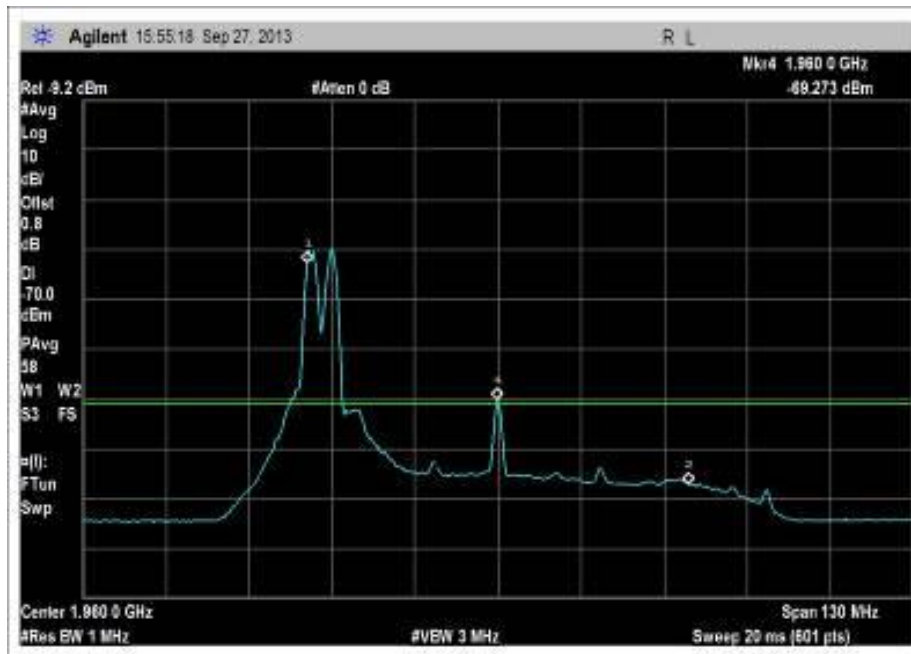

DL 1930-1990MHz, DL WCDMA signal at -41dBm

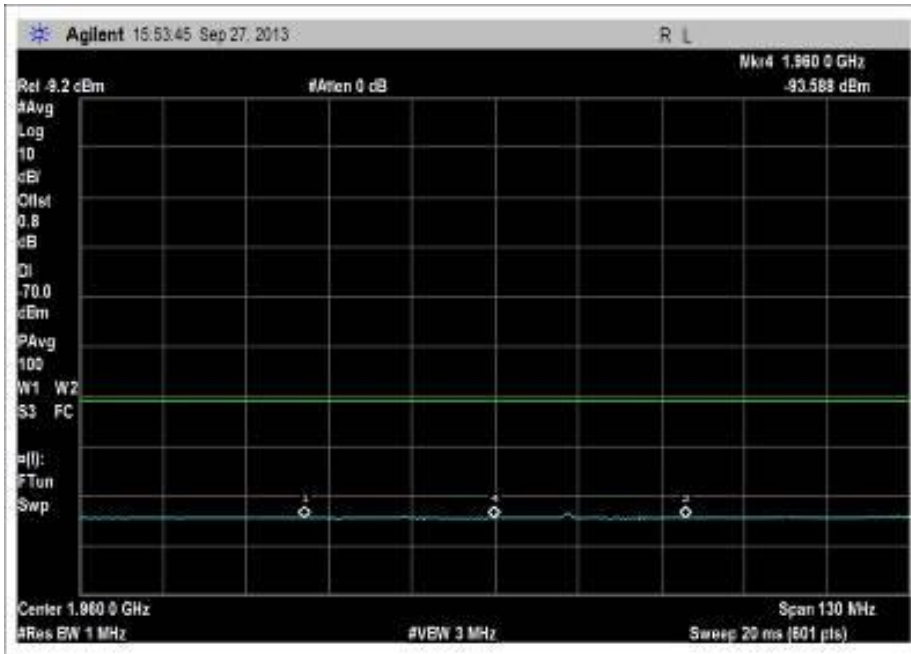

DL 1930-1990MHz, DL WCDMA signal at -40dBm

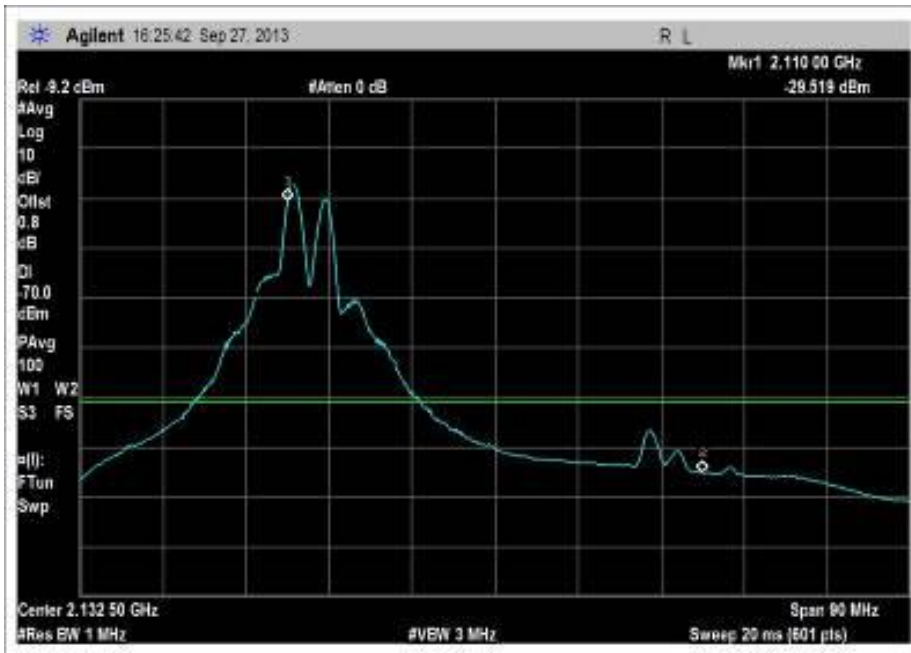

DL 2110-2155MHz, DL WCDMA signal at -41dBm

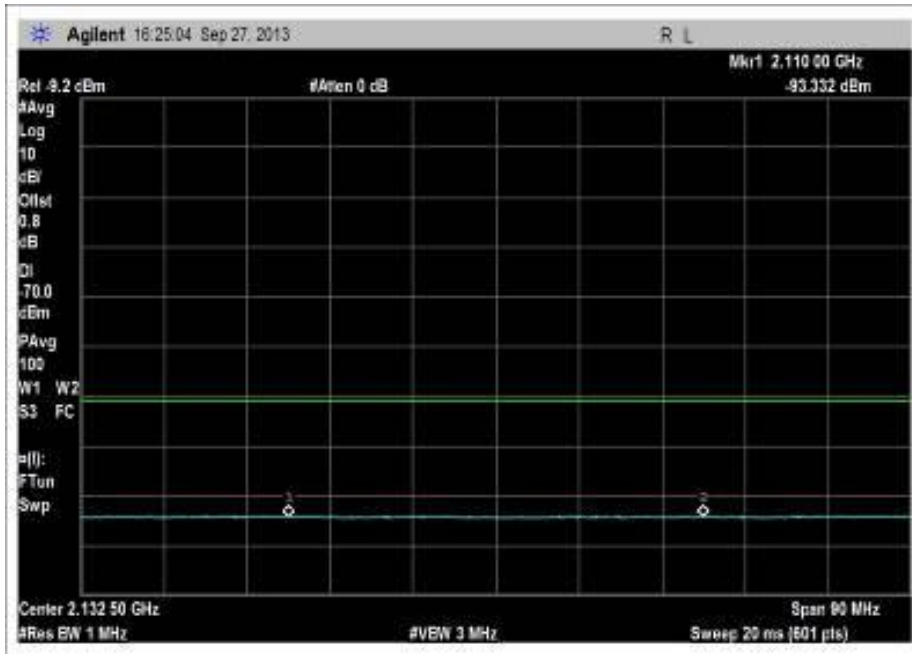

DL 2110-2155MHz, DL WCDMA signal at -40dBm

Test Setup Photos



DL Noise Limit, REV: 01

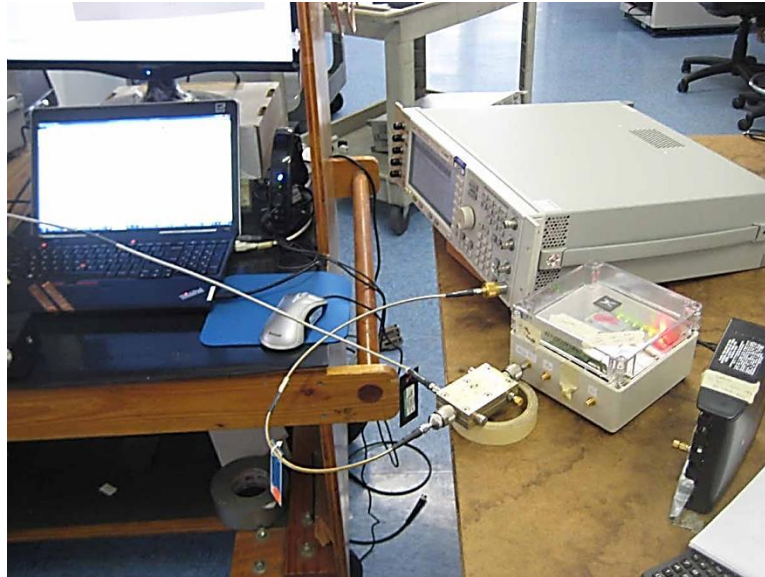

UL Noise Limit, REV. 01

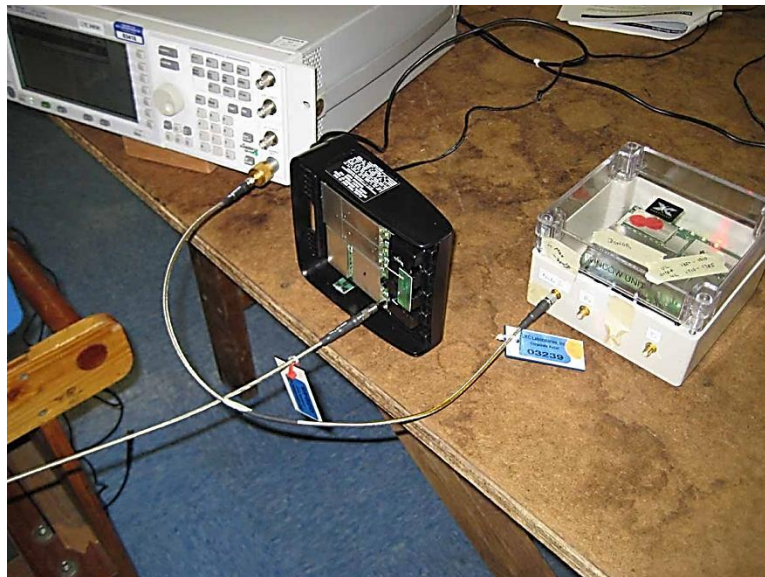

DL Noise Limit, Power Off @ -40dBm

FCC 20.21(e)(9)(i)(B) Bidirectional Capability/ FCC 20.21(e)(3) Frequency Bands

Test Conditions / Setup Band Verification REV. 01

Test Location: CKC Laboratories, Inc. • 110 North Olinda Place • Brea, CA 92823 • 714-993-6112

Customer: **Nextivity, Inc.**

Specification: **Frequency Bands**

Work Order #: **94857** Date: 9/24/2013

Test Type: **Conducted Emissions** Time: 08:31:39

Equipment: **Provider Specific Consumer Signal** Sequence#: 1

Manufacturer: Nextivity, Inc. Tested By: E. Wong

Model: CELFI-RS224WU, CELFI-RS224CU 110V 60Hz

S/N: 159311000046, 159311000046

Test Equipment:

ID	Asset #	Description	Model	Calibration Date	Cal Due Date
	AN02869	Spectrum Analyzer	E4440A	2/6/2013	2/6/2015
	AN03418	Signal Generator	Agilent	7/26/2013	7/26/2013
	AN02946	Cable	Astrolab Inc.	7/31/2013	7/31/2015

Equipment Under Test (* = EUT):

Function	Manufacturer	Model #	S/N
Provider Specific Consumer Signal Booster*	Nextivity, Inc.	CELFY-RS224WU	159311000046
Provider Specific Consumer Signal Booster	Nextivity, Inc.	CELFY-RS224CU	159311000046

Support Devices:

Function	Manufacturer	Model #	S/N

Test Conditions / Notes:

The EUT is provider specific signal booster pair consisted of a Window unit (WU) and a Coverage unit (CU) using proprietary 5.8 GHz Wireless interface.

Intended band of operation
 UL= 1850-1910 MHz, 1710-1755MHz
 DL= 1930-1990MHz, 2110-2155MHz.

The EUT is capable operating in 5 MHz segment within the CMRS band by setting the Spectrum Block Filter, gain and other operational parameter based on received public land mobile network (PLMN) ID.
 For testing purposes, the Spectrum block filter and operation of the booster is set in test mode using a laptop and test software interface.

Test environment conditions: 22°C, 32% Relative Humidity, 100kPa

The test was performed In accordance with section 7.1 of the FCC document: **935210 D03 Wideband Consumer Signal Booster Measurement Guidance DR04-41516** with minor variation due to the unique design of the device.

The Booster is design to boost wideband signal, the measurement was not possible when the input signal was set to CW or 200kHz AWGN sign. An AWGN signal with 99% BW of 4.1MHz was used instead.

The product is capable to operate with one spectrum block and up to a maximum of three spectrum blocks. For this test, three spectrum mask filters were activated, setting at Low, Mid and High band of the CMRS. The Signal generated was just below the AGC point and sweep across the 2X the CMRS band. Plots where further detail is needed at band edge, additional plots are provided for further clarification. The AGC circuit is not intended to receive a portion of wideband signal, causing abnormalities in the plots presentation.

Yellow trace is Max hold, blues trace is the booster noise after the sweeping signal has been removed from the pass band. The plots of three activated Spectrum Block filter demonstrated each spectrum block filter possess identical RF characteristic in the operational band, enabling the evaluation of the product with just one spectrum block filter activated.

Test Data

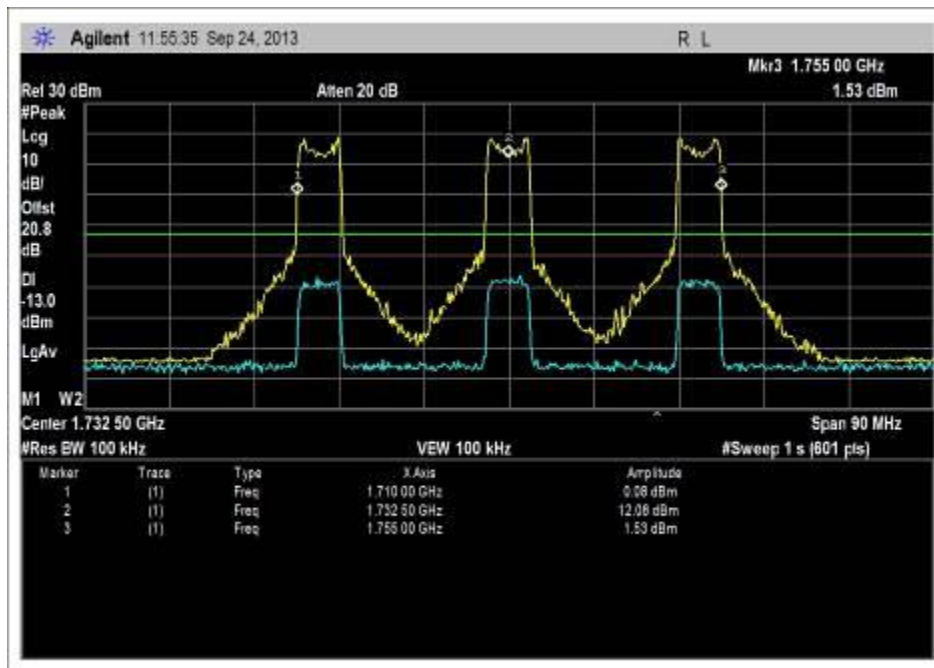

UL:1710-1755MHz band

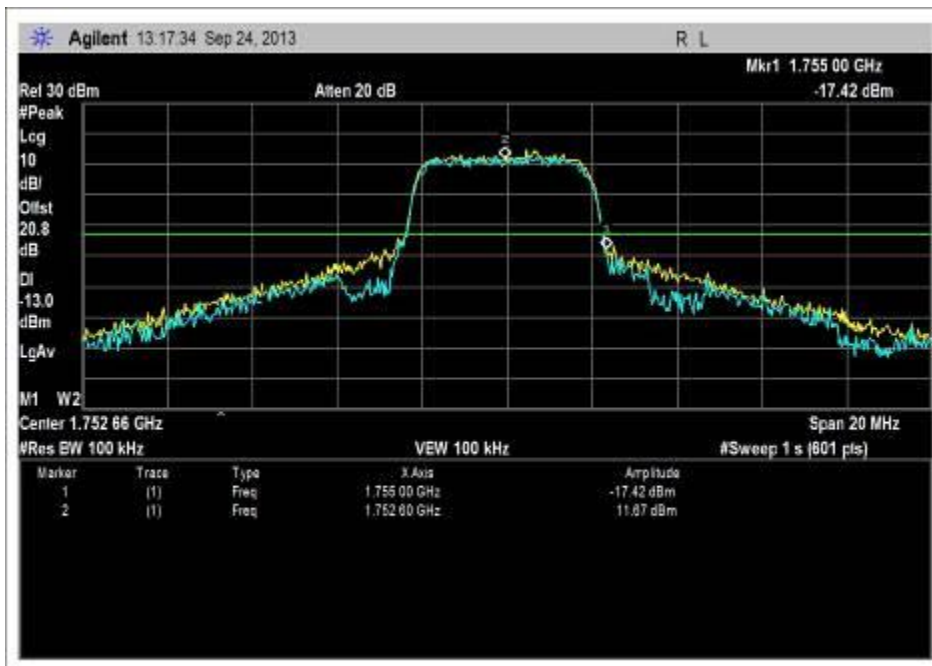
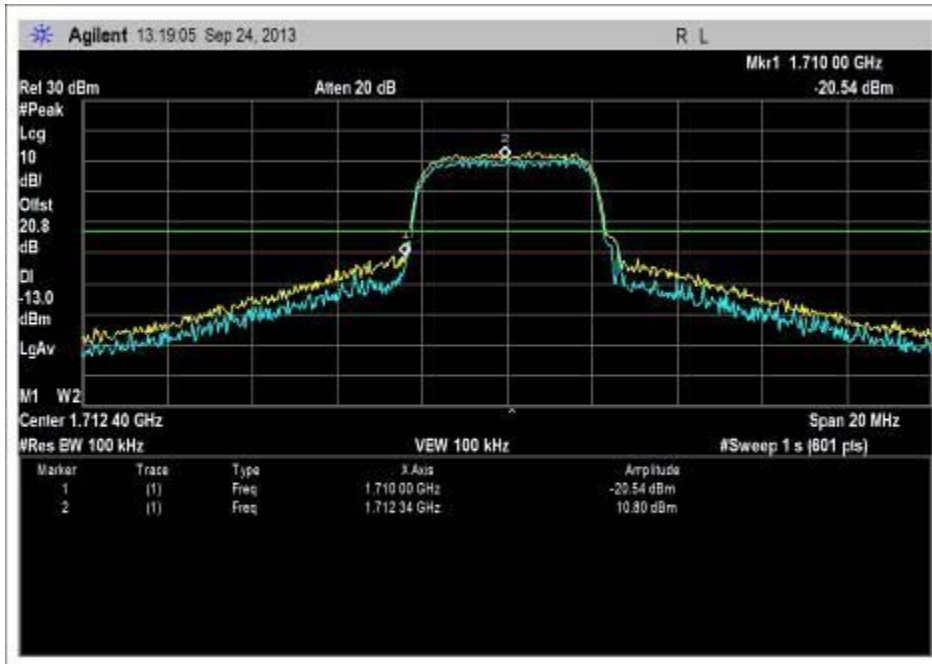

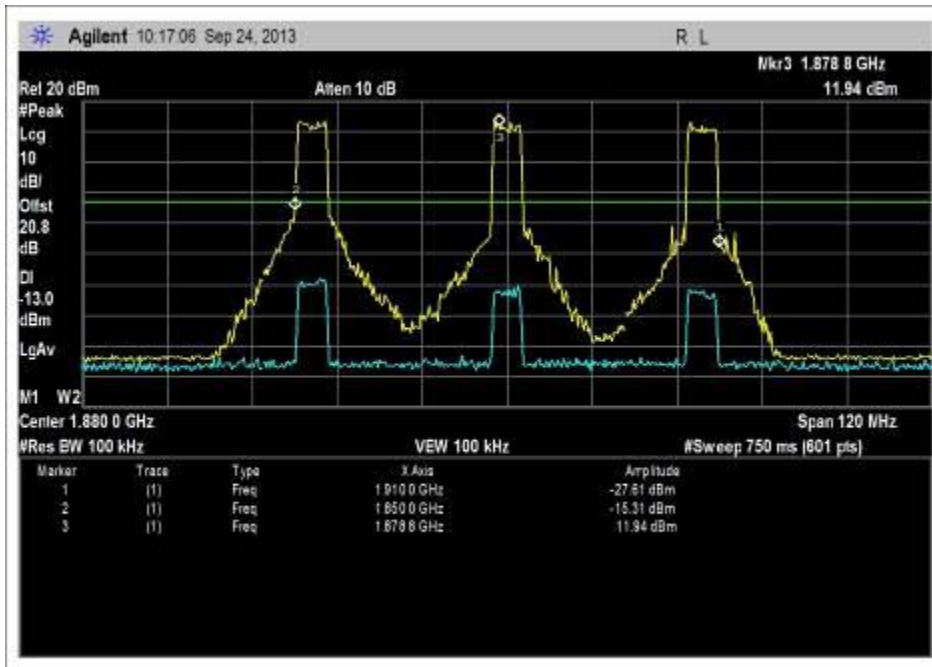

UL: 1850-1910MHz band

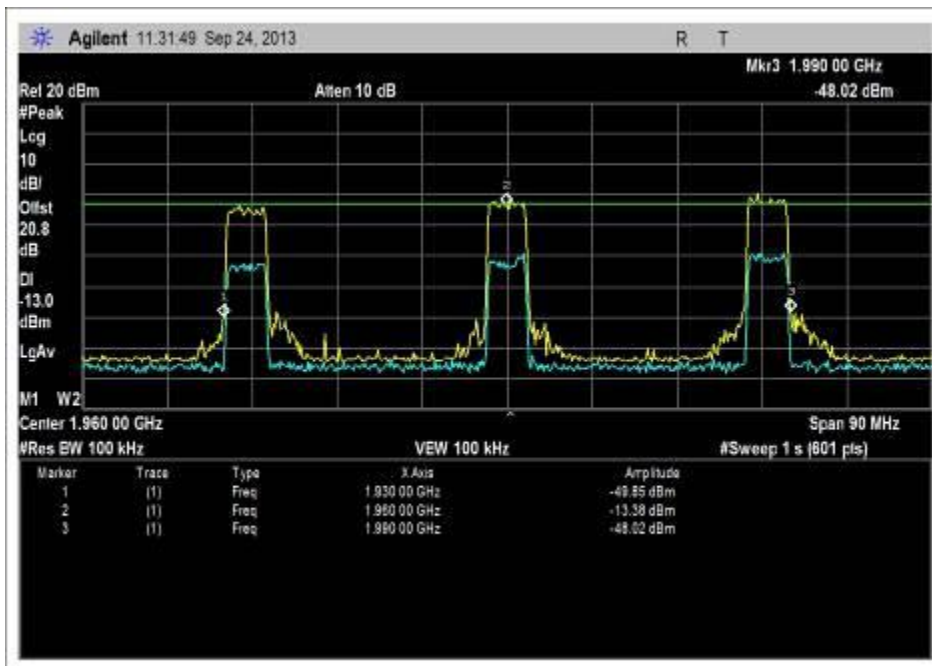

DL: 1930-1990MHz band

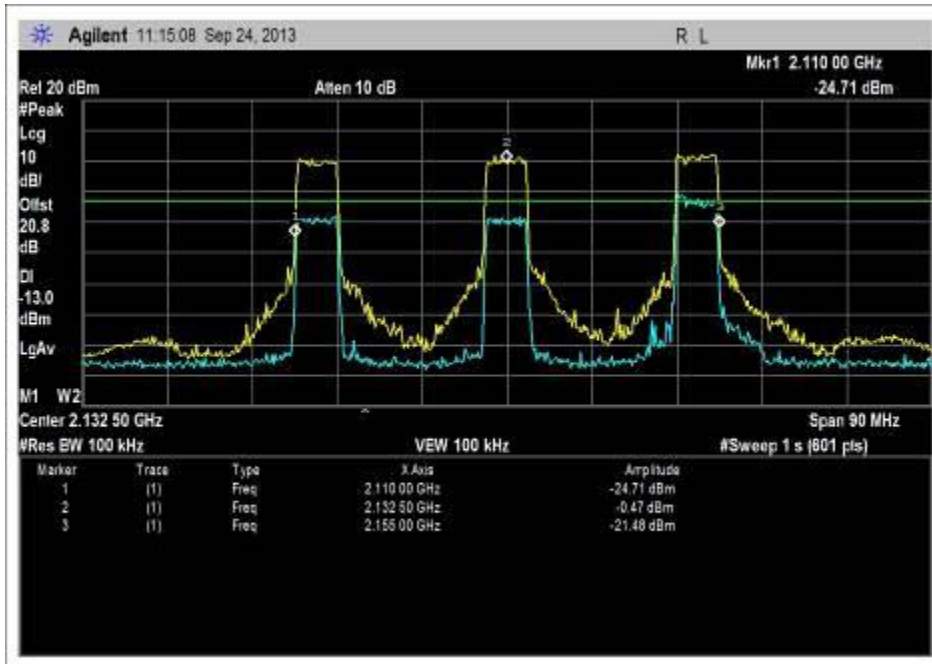

DL: 2110-2155MHz band

The Booster is designed and capable to operate in any authorized spectrum block in accordance with the received public land mobile network (PLMN) ID.

Due to the fact that authorized spectrum for any licensee varies according to each market economy, the uncertainties that the booster may be sold to different licensees and the authorized spectrum block may change ownership in unforeseen circumstances, to facilitate the testing certification of a single product to meet the “Only operated in the licensee’s spectrum block” requirement taking the different possibilities listed above, the following approach was taken into consideration.

Instead of testing each 5MHz channel with in the 1710-1755MHz, 2110-2155MHz, 1850-1915MHz and 1930-1995MHz band, which amount to many different testing cases, the Mobile Network Code (MNC) was used.

Every Licensee is assigned a unique MNC which is embedded in the received PLMN ID. Upon receiving the PLMNID, a provider specific consumer booster would determine if the booster is authorized to operate in the channel. When an unauthorized MNC is received, the booster would not operate.

Test setup Diagram

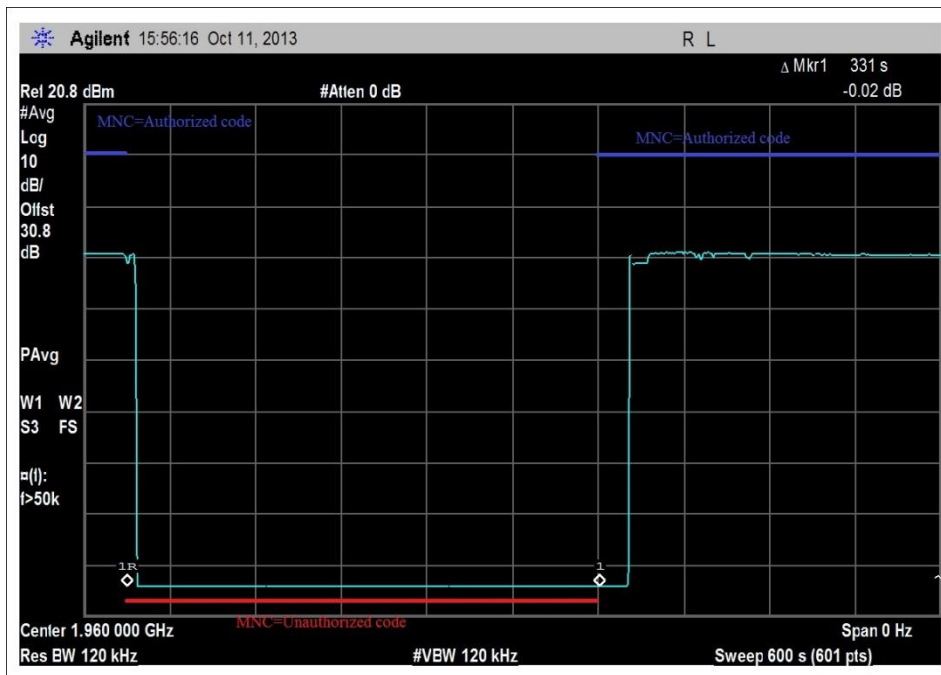
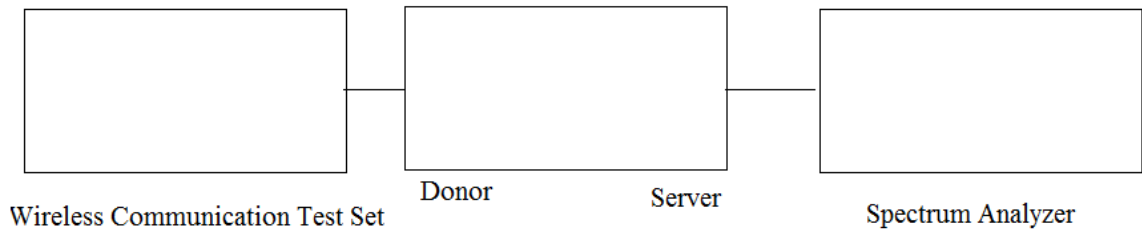

The above plot was captured with the booster initialized with 5MHz WCDMA with embedded authorized MNC, center frequency set at 1960MHz in authorized DL band. Set span =0, sweep time = 600 second. 5 second after sweep was initiated, the Wireless Communication Test Set was reconfigure to send a PLMN ID containing unauthorized MNC and recycle power of the booster. At 5 minutes has past, the manufacturer declared MNC verification time, reconfigure the Wireless Communication Test Set and send an PLMN ID containing unauthorized MNC to the booster and recycle power.

Presented in the above plot, is a plot of booster re-transmitting the DL 5MHz WCDMA signal at the server port when the sweep started. Between the cursor 1R and 1, upon power up, the booster did not transmit the DL signal as the DL 5 MHz WCDMA signal is now containing an unauthorized MNC. From Cursor 1 to the end of the sweep, the booster received authorized MNC and started transmission upon initialization.

The above screen capture is supplemental data to section 20.21(e)(3) Frequency Bands. The contents of the screen capture demonstrates that the provision of ensuring the provider specific consumer booster operates in authorized spectrum block by ONLY TRANSMIT in the presence of authorized MNC is implemented.

FCC 20.21(e)(9)(i)(B) Bidirectional Capability/FCC 20.21(e)(9)(i)(D) Power Limits

Test Location: CKC Laboratories, Inc. • 110 North Olinda Place • Brea, CA 92823• 714-993-6112

Customer: **Nextivity, Inc.**
 Specification: **20.21(e) (9)(i)(B), 20.12(e) (9)(i)(D)**
 Work Order #: **94857** Date: 9/24/2013
 Test Type: **Conducted Emissions** Time: 08:31:39
 Equipment: **Provider Specific Consumer Signal** Sequence#: 1
 Manufacturer: Nextivity, Inc. Tested By: E. Wong
 Model: CELFI-RS224WU, CELFI-RS224CU 110V 60Hz
 S/N: 159311000046, 159311000046

Test Equipment:

ID	Asset #	Description	Model	Calibration Date	Cal Due Date
	AN02869	Spectrum Analyzer	E4440A	2/6/2013	2/6/2015
	AN02946	Cable	Astrolab Inc.	7/31/2013	7/31/2015

Equipment Under Test (* = EUT):

Function	Manufacturer	Model #	S/N
Provider Specific Consumer Signal Booster*	Nextivity, Inc.	CELFY-RS224WU	159311000046
Provider Specific Consumer Signal Booster	Nextivity, Inc.	CELFY-RS224CU	159311000046

Support Equipment

Function	Manufacturer	Model #	S/N
8960 Wireless Communication test set.	Agilent	E5515C	GB47320116

Test Conditions / Notes:

The EUT is provider specific signal booster pair consisted of a Window unit (WU) and a Coverage unit (CU) using proprietary 5.8 GHz Wireless interface.

Intended band of operation

UL= 1850-1910 MHz, 1710-1755MHz; DL= 1930-1990MHz, 2110-2155MHz.

The EUT is capable operating in 5 MHz segment within the CMRS band by setting the Spectrum Block Filter , gain and other operational parameter based on received public land mobile network (PLMN) ID.

For testing purposes, the Spectrum block filter and operation of the booster is set in test mode using a laptop and test software interface.

Test environment conditions: 22°C, 32% Relative Humidity, 100kPa

The Booster is design to boost wideband signal, a 5 MHz WCDMA which necessary configuration to set the booster in Maximum gain. The product is capable to operate with one spectrum block and up to a maximum of three spectrum block. For this test, only one spectrum mask filter was activated, setting at highest power and gain achieved in the band of the CMRS since the emission profile of each spectrum block exhibits identical characteristic in the L.M.H channel within the CMRS.

A Wireless Communication Test Set and set attenuator for simulation of path loss were used to ensure the booster internal power detector, algorithm to compute BSCI, gain control circuit employed were operating as intended.

Test Data

For uplink power measurement

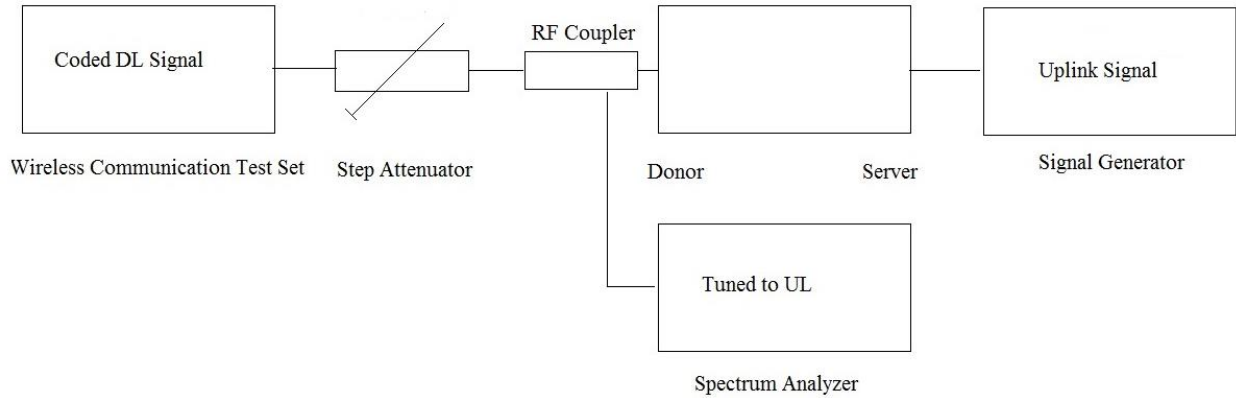

For Downlink Measurement

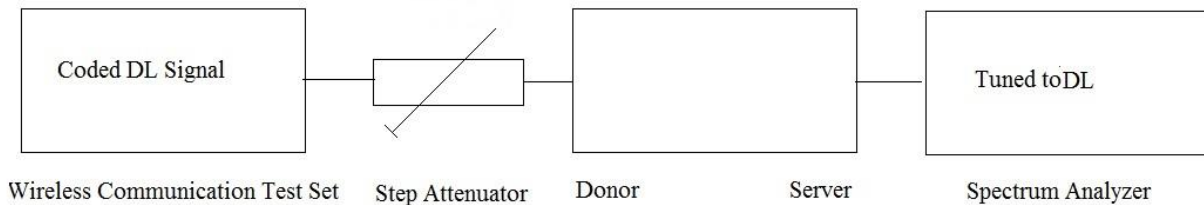

Per 20.21(e)(9)(i)(C)(1), the uplink and downlink gain in dB referenced to its input and output ports shall not exceed $BSCL - 28 \text{ dB} - (40 \text{ dB} - MSCL)$

To achieve max gain of 100dB
 $\text{Max gain} = 130 (BSCL) - 28 - (40-38 \text{ (the MSCL)})$
 $= 100\text{dB}$.

$BSCL = 36$ (base station reporting the pilot at)
 $- (-24)$ (the actual transmission level)
 $+ 70$ (the path loss /attenuator) = 130 dB

The Wireless communication test set was configured for -20dBm total output power
 Attenuator max setting = 70dB
 CPICH Tx power level setting = +36dBm

Per KDB 935210 D03 v01r01 Annex B3, $L_p = 20 \log f + 20 \log d - 27.5$, where L_p =basic free space path loss, f =frequency in MHz, d =separation distance in meters. For $f=1880\text{MHz}$ and $d=1$, $MSCL=38\text{dB}$. $d=1$ is taken from KDB 935210 D03 v01r01 Annex B5.3.

Summary tables for following four plots

	0.5 dB below AGC Point		
Frequency	Input(dBm)	Output (dBm)	Gain (dB)
UL 1850-1910	-79.5	17.0	96.5
UL 1710-1755	-77.2	18.6	95.8
DL 1930-1990	-89.0	7.6	96.6
DL 2110-2155	-89.9	6.1	96.0

Note: Measured Max gain is less than 100db.

UL gain vs DL gain 1850/1930	-0.1
UL gain vs DL gain 1710/2110	-0.2
Limit	9

Freq	Power(dBm)	Ant Gain(dBi)	EIRP (dBm)	P/F	Limit
UL 1850-1910	17.0	4	21.0	P	30
UL 1710-1755	18.6	4	22.6	P	30
DL 1930-1990	7.6	0	7.6	P	17
DL 2110-2155	6.1	0	6.1	P	17

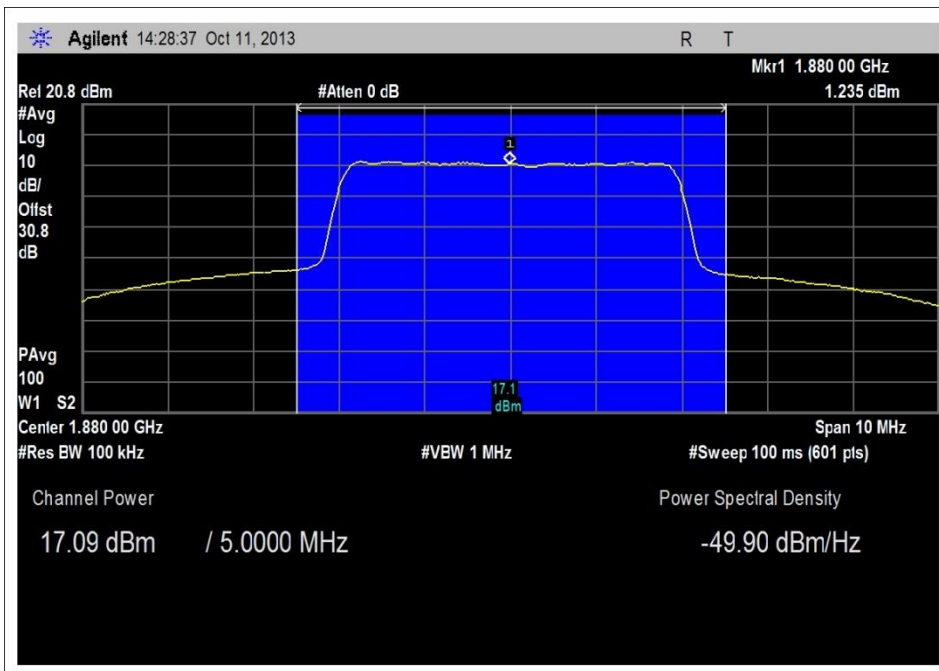
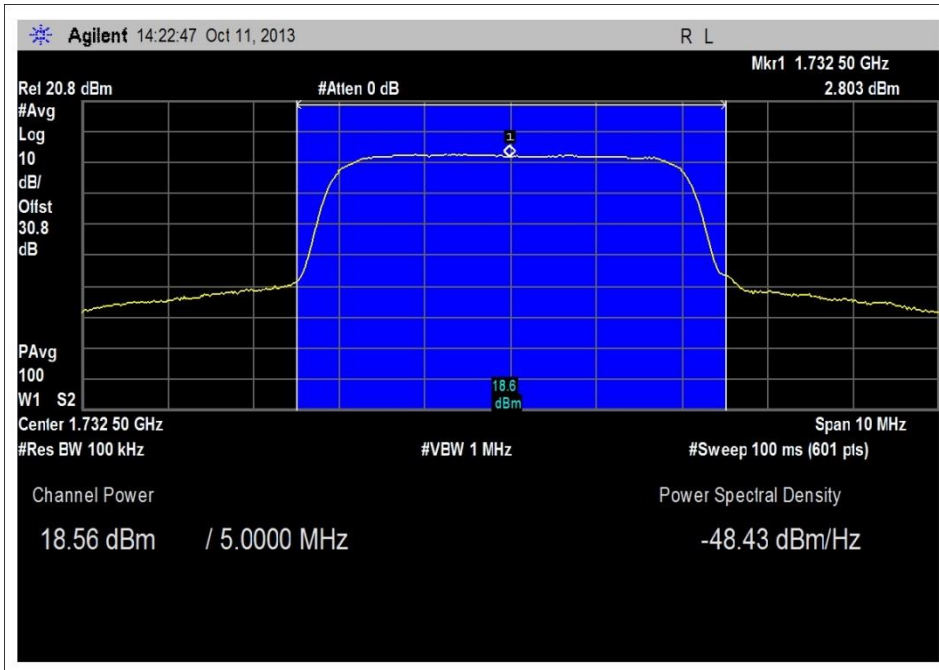

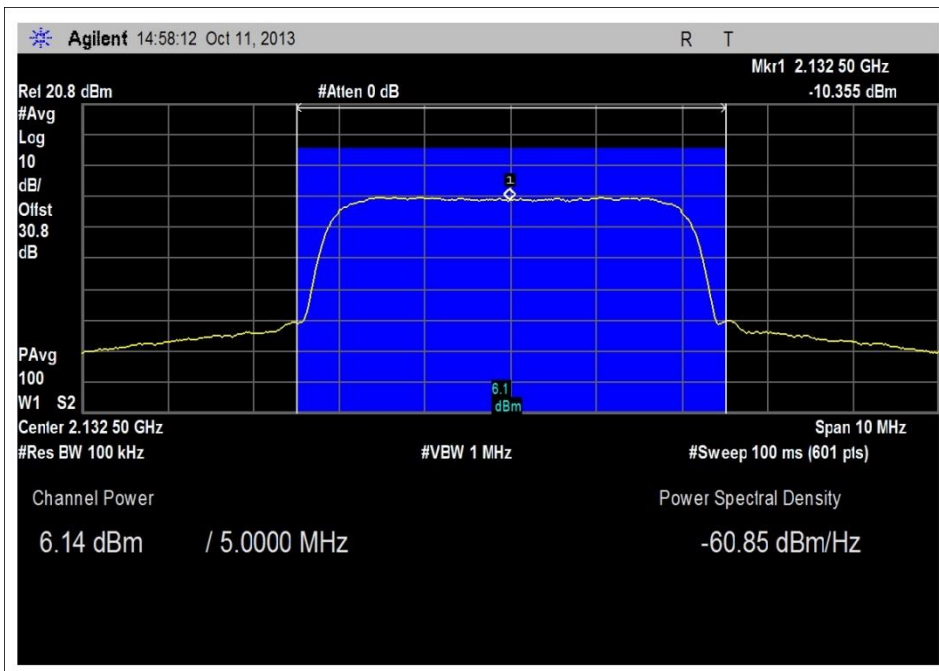
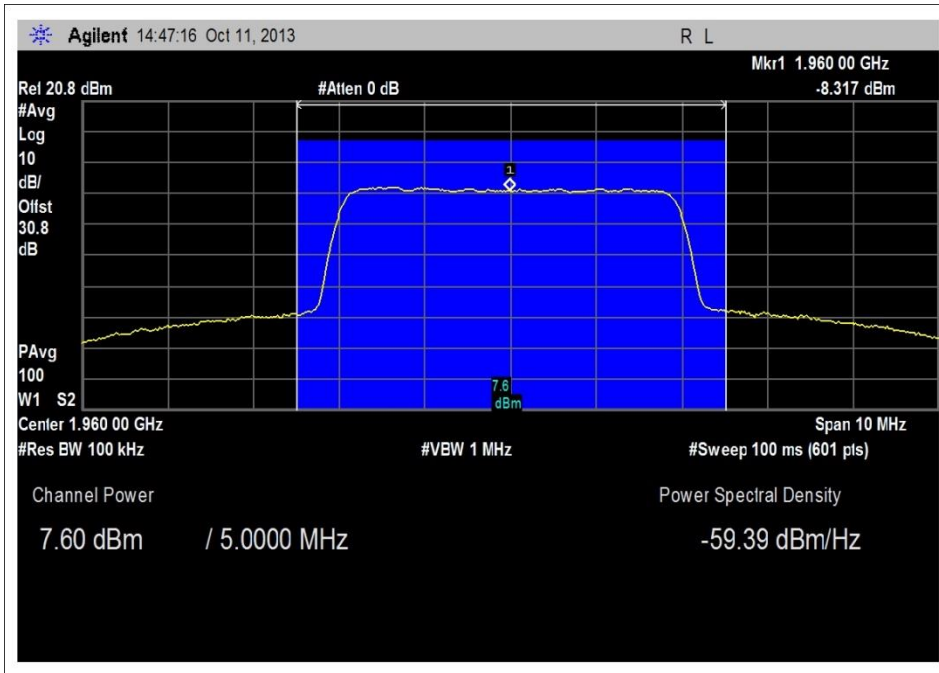

Test Setup Photos

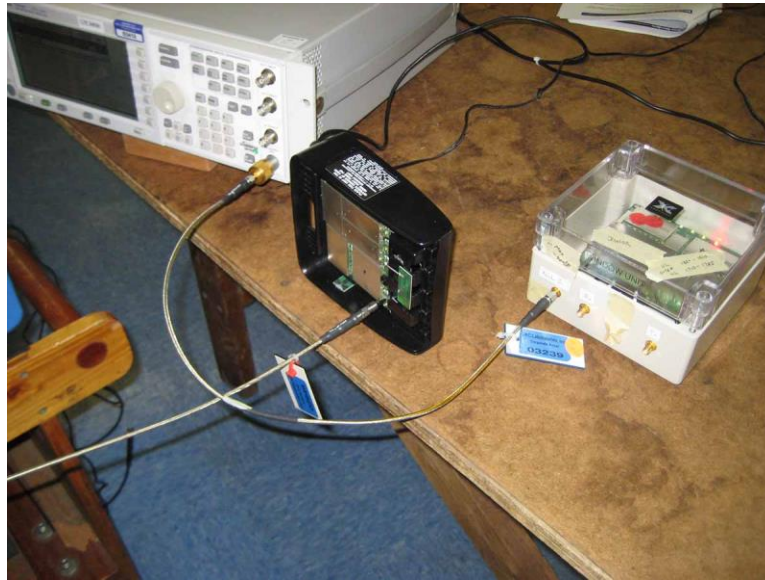

Band Verification REV. 01

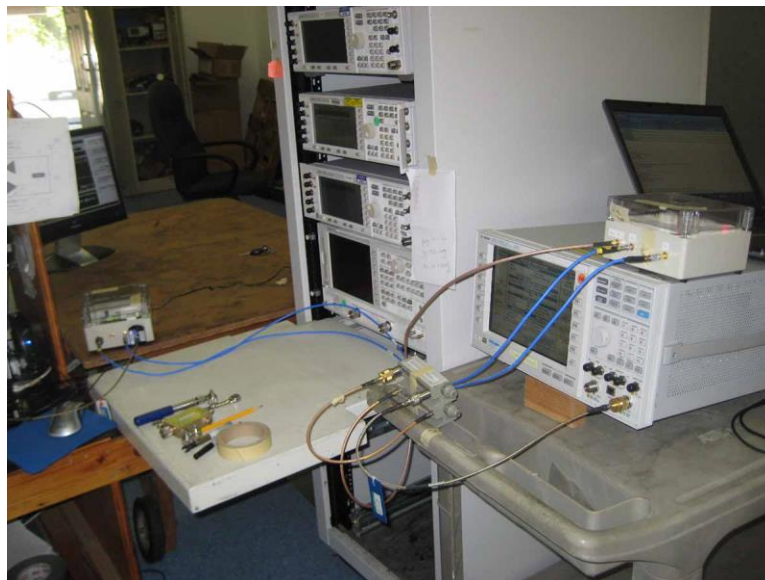

Power and Gain, DL



Power and Gain, UL

FCC 20.21(e)(9)(i)(C) Booster Gain Limit

Test Conditions / Setup

Test Location: CKC Laboratories, Inc. • 110 North Olinda Place • Brea, CA 92823 • 714-993-6112

Customer: **Nextivity, Inc.**
 Specification: **20.21(e)(9)(i)(C) Booster Gain Limit**
 Work Order #: **94857** Date: 9/24/2013
 Test Type: **Conducted Emissions** Time: 08:31:39
 Equipment: **Provider Specific Consumer Signal Booster** Sequence#: 1
 Manufacturer: Nextivity, Inc. Tested By: E. Wong
 Model: CELFI-RS224WU, CELFI-RS224CU 110V 60Hz
 S/N: 159311000046, 159311000046

Test Equipment:

ID	Asset #	Description	Model	Calibration Date	Cal Due Date
	AN02869	Spectrum Analyzer	E4440A	2/6/2013	2/6/2015
	AN03418	Signal Generator	Agilent	7/26/2013	7/26/2013
	C00032	Signal Generator	Agilent	9/20/2013	09/20/2013
	AN02946	Cable	Astrolab Inc.	7/31/2013	7/31/2015

Equipment Under Test (* = EUT):

Function	Manufacturer	Model #	S/N
Provider Specific Consumer Signal Booster*	Nextivity, Inc.	CELFIR-S224WU	159311000046
Provider Specific Consumer Signal Booster	Nextivity, Inc.	CELFIR-S224CU	159311000046

Support Equipment

Function	Manufacturer	Model #	S/N
8960 Wireless Communication test set.	Agilent	E5515C	GB47320116

Test Conditions / Notes:

The EUT is provider specific signal booster pair consisted of a Window unit (WU) and a Coverage unit (CU) using proprietary 5.8 GHz Wireless interface.

Intended band of operation
 UL= 1850-1910 MHz, 1710-1755MHz
 DL= 1930-1990MHz, 2110-2155MHz.

The EUT is capable operating in 5 MHz segment within the CMRS band by setting the Spectrum Block Filter, gain and other operational parameter based on received public land mobile network (PLMN) ID.

For testing purposes, the Spectrum block filter and operation of the booster is set in test mode using a laptop and test software interface.

Test environment conditions: 22°C, 32% Relative Humidity, 100kPa

The test was performed IAW section 7.9 of the FCC document: **935210 D03 Wideband Consumer Signal Booster Measurement Guidance DR04-41516** with slight variation.

The Booster is designed to boost wideband signal within a preset spectrum block. For testing, the booster was operating in **“Normal operation mode”** by which the booster system Gain is controlled by the controller circuit to

conform with limit as a function of Base Station Coupling Loss (BSCL) and MSCL (Mobile Station Coupling Loss).

The Output port of the Wireless Communication Test Set was connected to the Donor port of the booster via an adjustable Step Attenuator. The Power level at RF Output port of the Wireless communication test was encoded in the transmitted 5MHz WCDMA command word sent to the Booster.

For this evaluation, Method 1 of 20.12(e)(9)(i)(C)(1)(ii) was used

BSCL was computed by subtracting the measured Pilot Channel power (the DL 5MHz WCDMA channel power) at the Booster's server port from the reported Pilot Channel Power as defined in the message sent from the Wireless Telecommunication Test Set.

The Step Attenuator functions as the Variable Path Loss for this with Initially Setting of 70dB.

RF Output set at -20dBm at the output of the Wireless Telecommunication Test set (The lowest power setting of the test set used), and Offset of 56 dB was enter into the Wireless Telecommunication Test Set to report CPICH TX power setting +36dBm, Which contributes to -90dBm at the Donor port. The Pilot channel has 4 dB of overhead, resulting in equivalent

$BSCL = 36$ (what the base station says it is transmitting the pilot at) $- (-24)$ (the actual transmission level) $+ 70$ (the path loss setting on the attenuator) $= 130$ dB

The test was performed with equivalent DL power of -90dBm to -20dBm, BSCL of 130 to 60dB (with step attenuator stepping from 70 to 0 dB)

MSCL is calculated as $20 \cdot \log_{10}(4 \cdot \pi / \lambda)$ where $\lambda = \text{wavelength}$ of the lowest uplink transmit frequency. For the AWS band, the lowest uplink transmit frequency is 1710MHz which equates to a MSCL of 37dB. For the PCS band, the MSCL is 38dB. The separation distance in meters of 1 ($d=1$) is taken from KDB 935210 D03 v01r01 Annex B5.3.

Test Data

DL Gain measurement

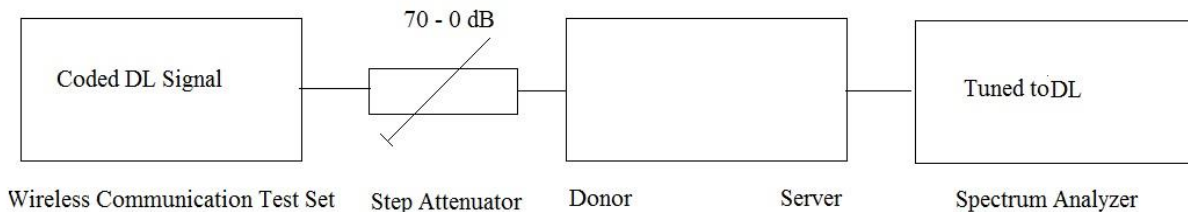

5MHz WCDMA DL from the Wireless Telecommunication test set at 1960 MHz being sent to the Donor port via a set of step attenuators. The Output power of the Wireless Communication test set was at -20dBm. Initial attenuation set at 70 dB. This results in -90dBm of DL power at the Donor port. The Server port is connected to the spectrum analyzer.

DL Gain computation : Measured DL channel Power level at the server port – 5MHz WCDMA DL power level at the Donor port , (while the 5MHz WCDMA DL signal was reduced by reduction of attenuation to simulate BSCL.)

UL Gain Measurement

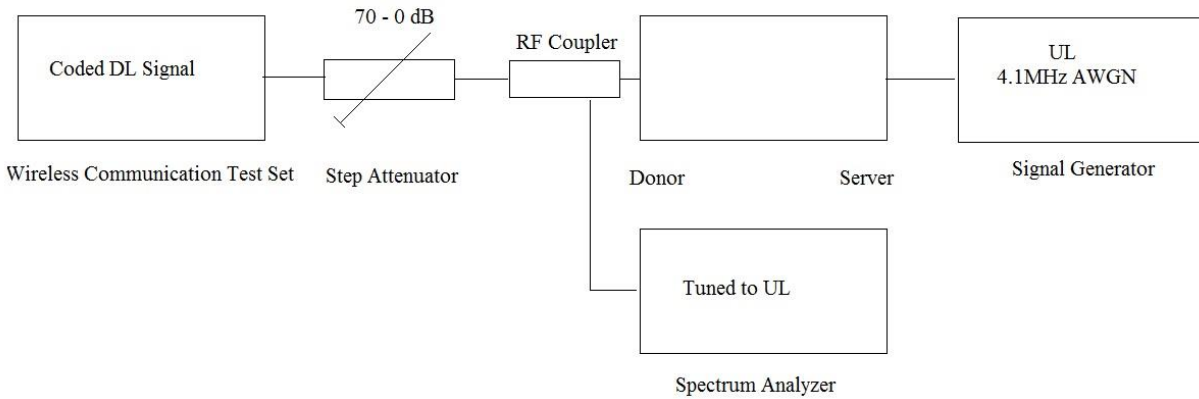

5MHz WCDMA DL from the Wireless Telecommunication test set at 1960 MHz being sent to the Donor port via a set of step attenuators and a directional coupler. The Output power of the Wireless Communication test set was at -20dBm. Initial attenuation set at 70 dB. This results in -90dBm of DL power at the Donor port.

4.1MHz AWGN UL signal set at -35dBm was injected into the server port via a signal generator. The uplink channel power was measured at the Coupler port of the directional coupler.

UL Gain computation: Measured UL channel Power level at the coupled port of the directional coupler – 4.1MHz AWGN UL power level at the Server antenna port (while the 5MHz WCDMA DL signal was reduced by reduction of attenuation to simulate BSCL).

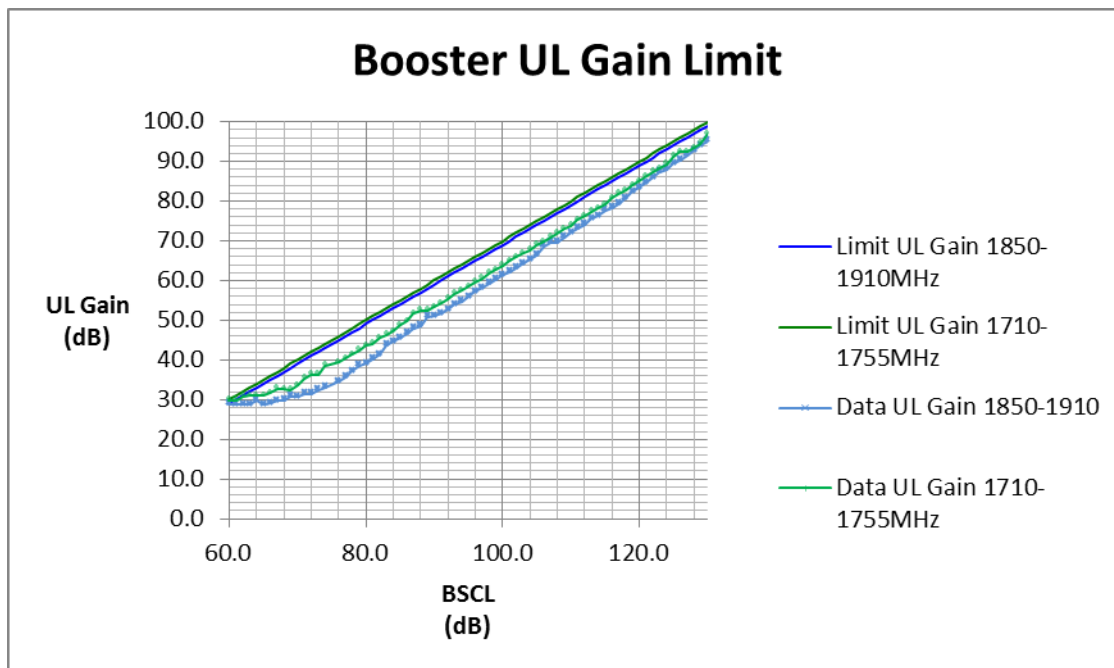
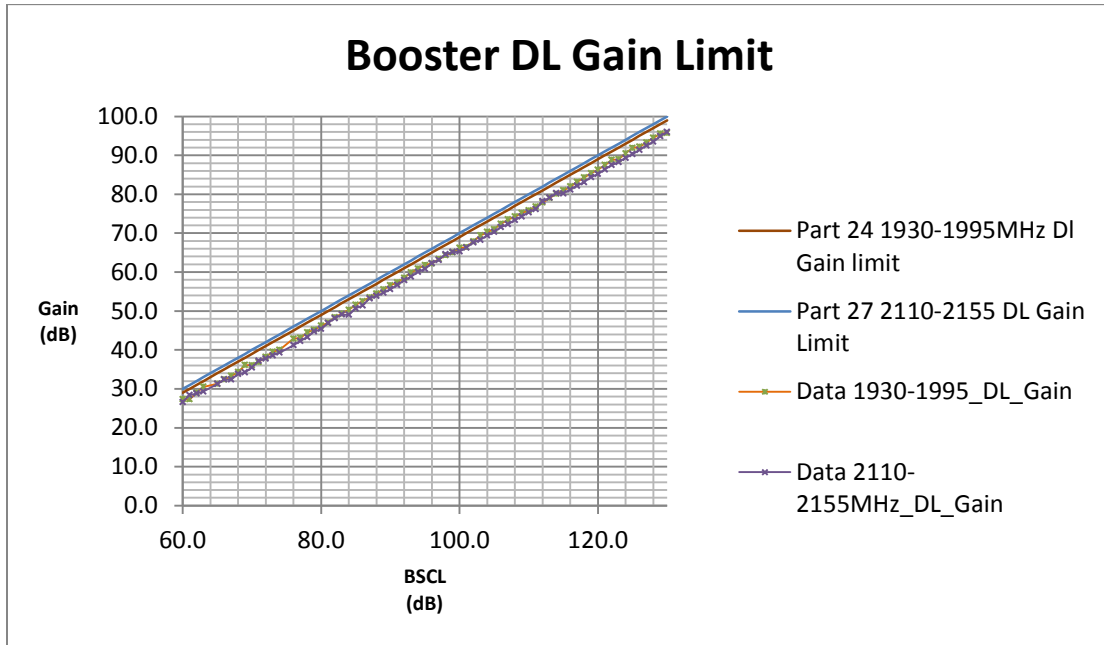

Note: The Booster is designed to perform DL power level check every 24 hours.

Test Setup Photos

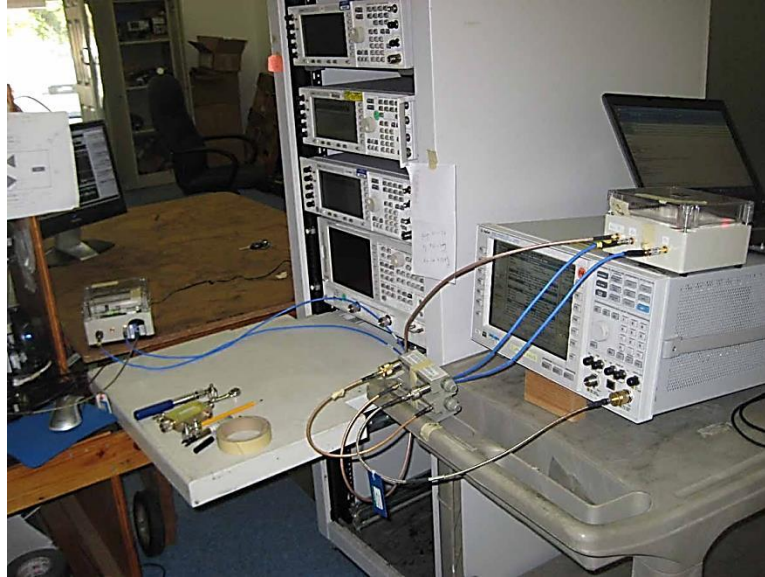

Power Gain DL

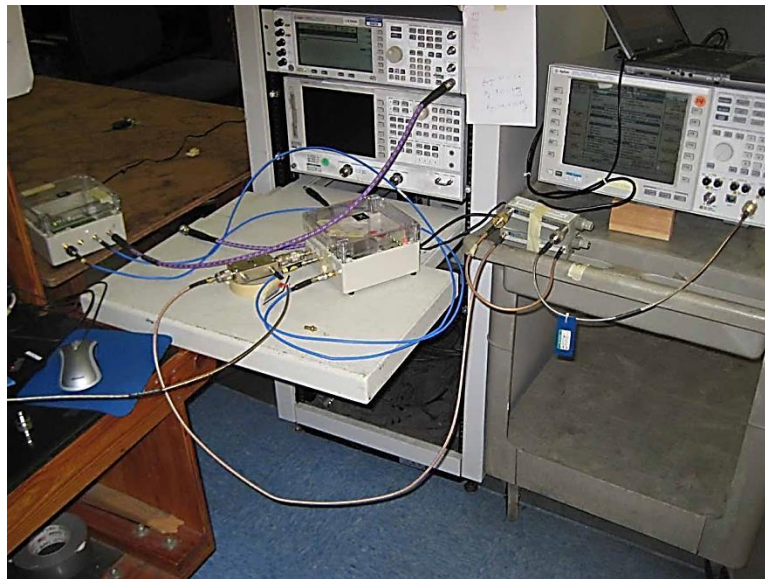

Power Gain UL

FCC 20.21(e)(9)(i)(E) Out of Band Gain

Test Conditions / Setup

Test Location: CKC Laboratories, Inc. • 110 North Olinda Place • Brea, CA 92823 • 714-993-6112

Customer: **Nextivity, Inc.**

Specification: **20.21(e) (9)(i) (E) Out of band gain limit**

Work Order #: **94857** Date: 9/24/2013

Test Type: **Conducted Emissions** Time: 08:31:39

Equipment: **Provider Specific Consumer Signal Booster** Sequence#: 1

Manufacturer: Nextivity, Inc. Tested By: E. Wong

Model: CELFI-RS224WU, CELFI-RS224CU 110V 60Hz

S/N: 159311000046, 159311000046

Test Equipment:

ID	Asset #	Description	Model	Calibration Date	Cal Due Date
	AN02869	Spectrum Analyzer	E4440A	2/6/2013	2/6/2015
	AN03418	Signal Generator	Agilent	7/26/2013	7/26/2013
	AN02946	Cable	Astrolab Inc.	7/31/2013	7/31/2015

Equipment Under Test (* = EUT):

Function	Manufacturer	Model #	S/N
Provider Specific Consumer Signal Booster*	Nextivity, Inc.	CELFIR-S224WU	159311000046
Provider Specific Consumer Signal Booster	Nextivity, Inc.	CELFIR-S224CU	159311000046

Support Equipment

Function	Manufacturer	Model #	S/N
8960 Wireless Communication test set.	Agilent	E5515C	GB47320116

Test Conditions / Notes:

The EUT is provider specific signal booster pair consisted of a Window unit (WU) and a Coverage unit (CU) using proprietary 5.8 GHz Wireless interface.

Intended band of operation
 UL= 1850-1910 MHz, 1710-1755MHz; DL= 1930-1990MHz, 2110-2155MHz.

The EUT is capable operating in 5 MHz segment within the CMRS band by setting the Spectrum Block Filter, gain and other operational parameter based on received public land mobile network (PLMN) ID.

For testing purposes, the Spectrum block filter and operation of the booster is set in test mode using a laptop and test software interface.

Test environment conditions: 22°C, 32% Relative Humidity, 100kPa

The booster is designed to reject CW signal to enable gain measurement meeting the requirement, a wide band signal was utilized for this test.

Out of band gain was evaluating with the booster operate in Normal mode. The Wireless Communication Test was employed to place the booster in operational mode and set the system gain at 80 dB. Test performed by measuring the system gain in the presence of a 15 MHz AWGN signal. Adjacent channel power function of the spectrum analyzer was used.

The 15 MHz AWGN signal was first measured with ACP function ,where integrated signal power of 200kHz segment was measured at the Center of the Spectrum block filter, 2.7 MHz (2.5 MHz + 0.2MHz) and 3.5 MHz (and 2.5 MHz + 1 MHz) offset from the band edge. Keeping the same measurement setting, the UL and DL gain was computed by measuring the 200kHz signal segment with the same frequency off set of the amplified 15MHz AWGN signal in both the uplink and down link path.

Test Data

	Power Level Reference Signal (200kHz segment)				
Frequency	-3MHz	- 0.2MHz	Fc	+0.2MHz	+3MHz
UL1710-1755	-72.27	-72.53	-73.25	-72.92	-73.44
UL1850-1910	-72.86	-72.34	-72.09	-71.76	-71.79
DL 1930-1990	-94.91	-94.87	-94.50	-95.59	-94.89
DL 2110-2155	-95.06	-95.61	-94.90	-94.42	-95.87
	Measured Power Level (200kHz segment)				
	-3MHz	- 0.2MHz	Fc	+0.2MHz	+3MHz
UL1710-1755	-36.28	-32.53	5.73	-28.57	-34.03
UL1850-1910	-36.56	-35.13	4.16	-32.46	-34.71
DL 1930-1990	-57.50	-53.48	-12.06	-55.23	-55.80
DL 2110-2155	-57.73	-49.59	-11.29	-56.38	-58.60
Computation	Gain in 200kHz Segment				
	-3MHz	- 0.2MHz	Fc	+0.2MHz	+3MHz
UL1710-1755	35.99	40.00	78.98	44.35	39.41
UL1850-1910	36.30	37.21	76.25	39.30	37.08
DL 1930-1990	37.41	41.39	82.44	40.36	39.09
DL 2110-2155	37.33	46.02	83.61	38.04	37.27
Limit	45.00	60.00		60.00	45.00

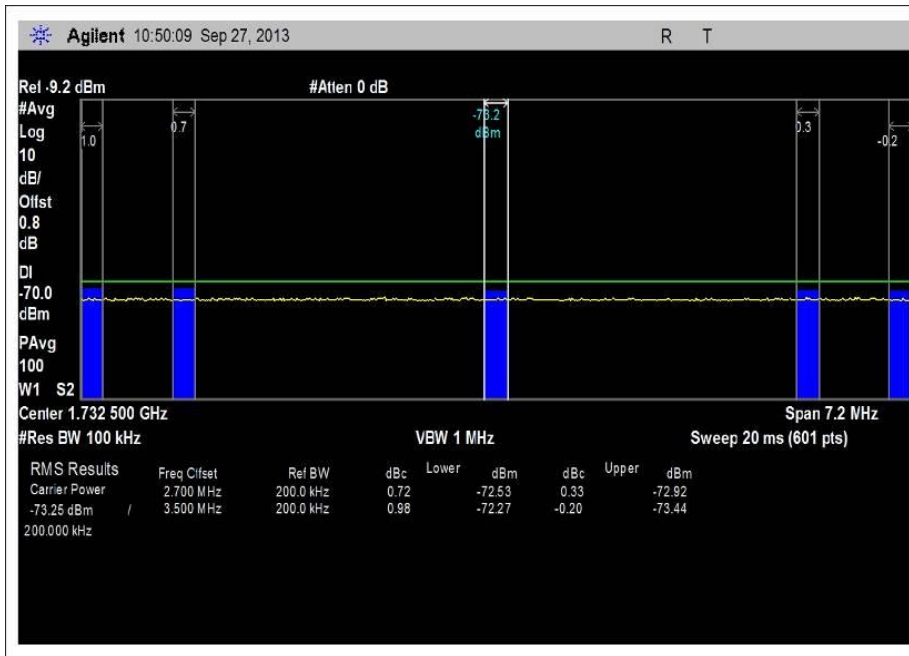

7.20_EW_out of band gain_1710-1755_baseline 15Mhz AWGN -52dBm

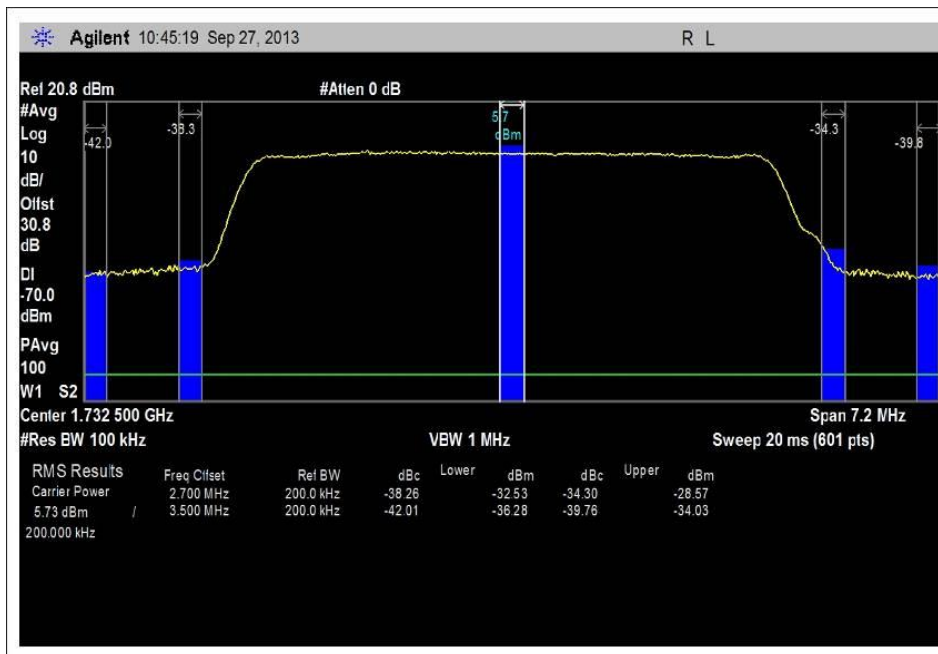

7.20_EW_out of band gain_1710-1755_Signal plot

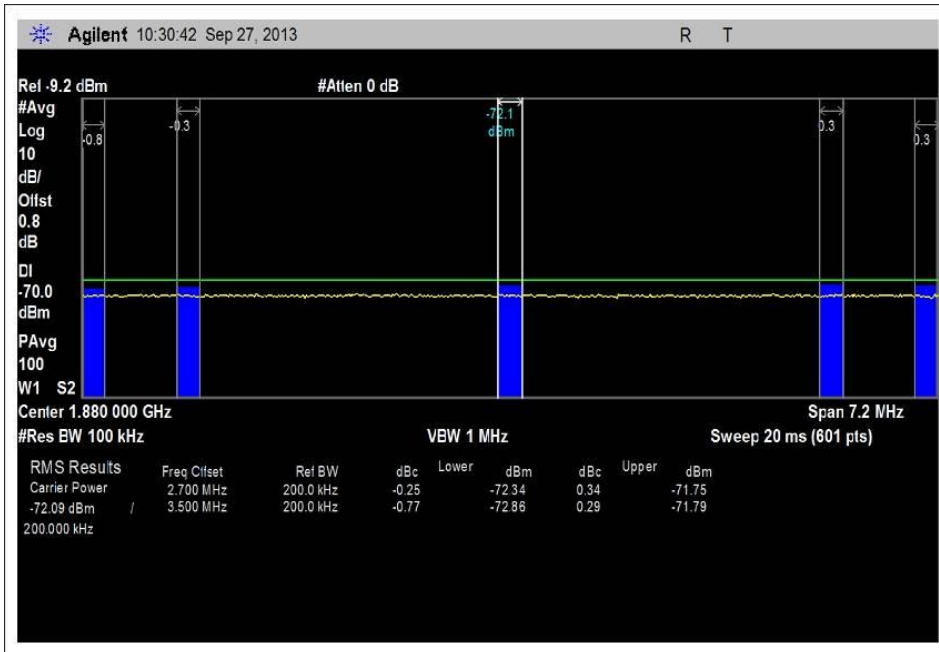

7.20_EW_out of band gain_1850-1910_base line 15MHzAWGN_set at -52dBm

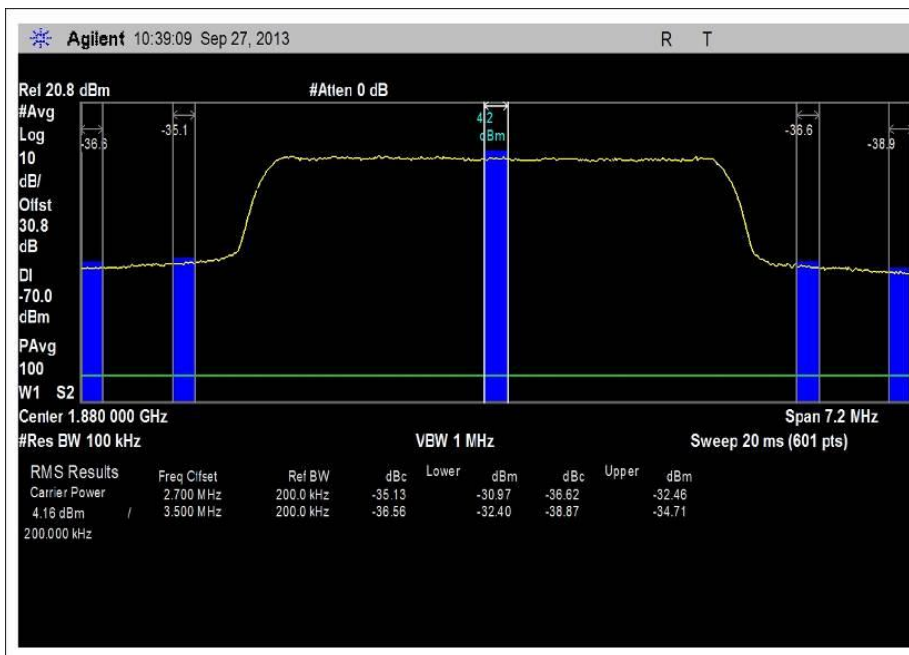

7.20_EW_out of band gain_1850-1910_Signal plot

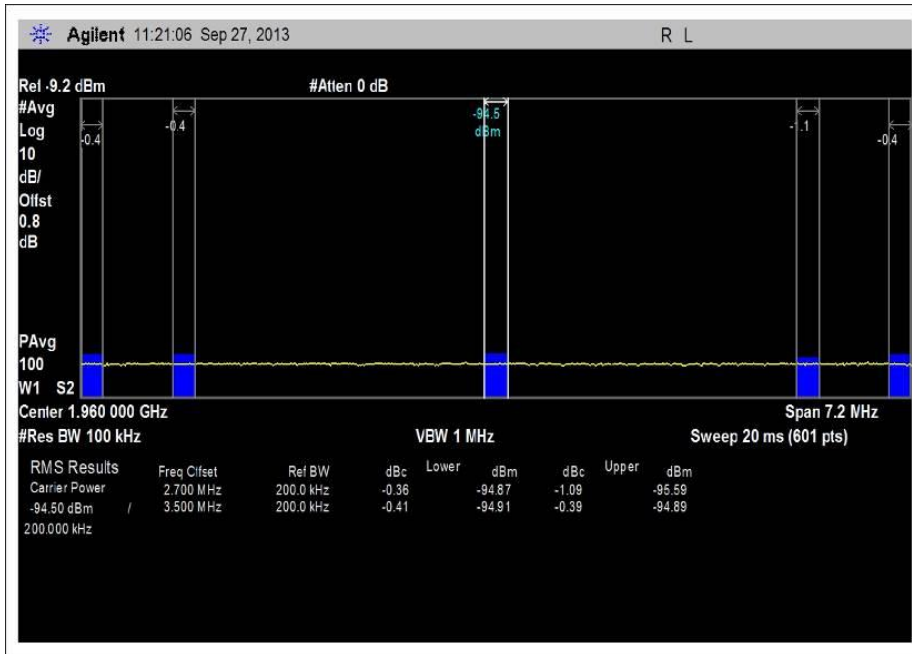

7.20_EW_out of band gain_1930-1990_base line 15MHz awgn set at -75dBm

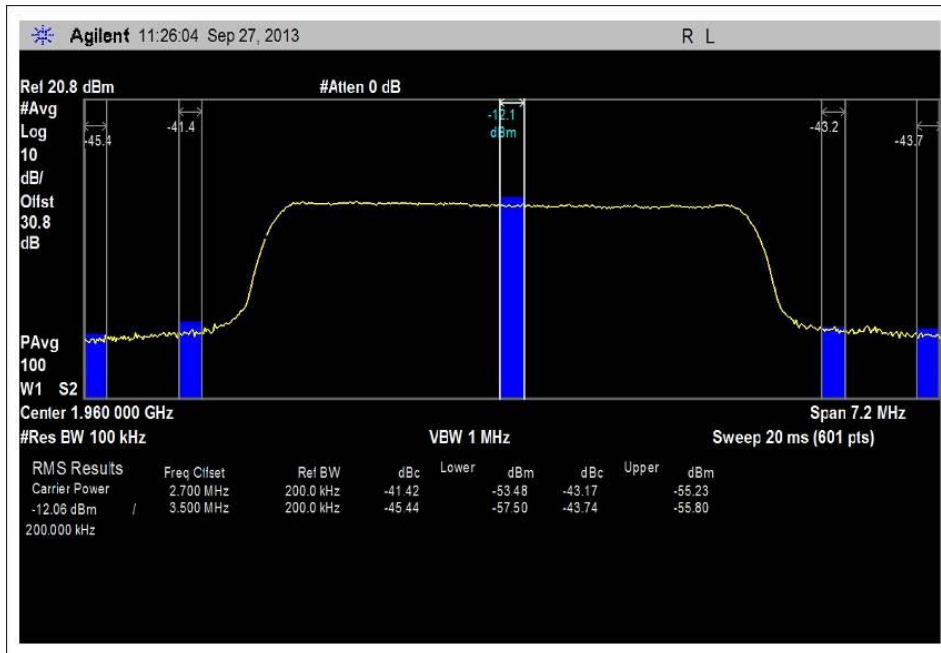

7.20_EW_out of band gain_1930-1990_signal plot B

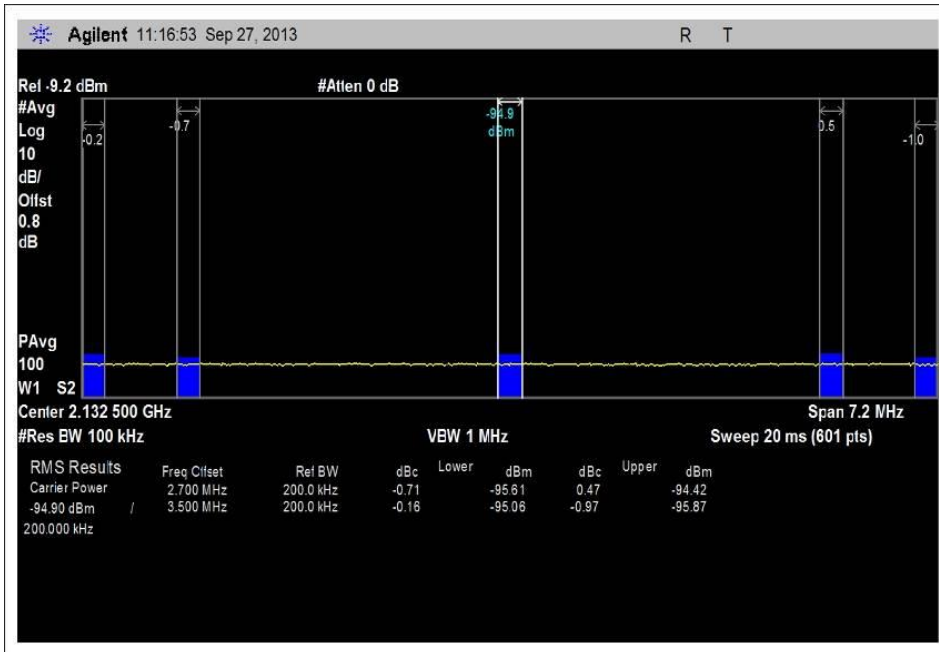

7.20_EW_out of band gain_2110-2155_base line 15Mhz AWGN set at -75dBm

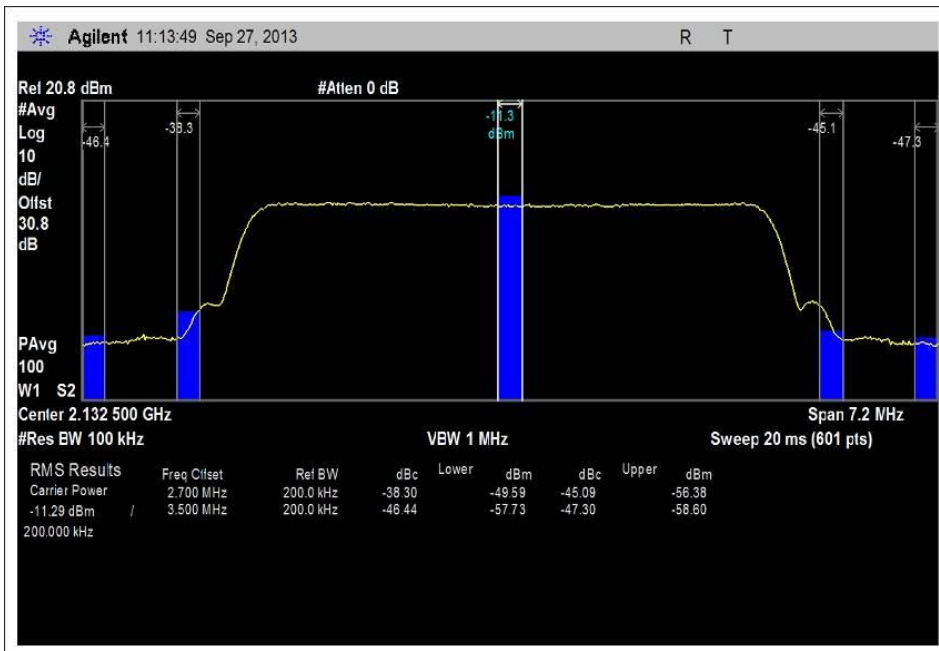

7.20_EW_out of band gain_2110-2155_signal plot

Test Setup Photo



FCC 20.21(e)(9)(i)(F) Out of Band Emission Limits

Test Conditions / Setup

Test Location: CKC Laboratories, Inc. • 110 North Olinda Place • Brea, CA 92823 • 714-993-6112

Customer: **Nextivity, Inc.**

Specification: **20.21(e) (9)(i)(F) Out of Band Emission limits**

Work Order #: **94857** Date: 9/24/2013

Test Type: **Conducted Emissions** Time: 08:31:39

Equipment: **Provider Specific Consumer Signal Booster** Sequence#: 1

Manufacturer: Nextivity, Inc. Tested By: E. Wong

Model: CELFI-RS224WU, CELFI-RS224CU 110V 60Hz

S/N: 159311000046, 159311000046

Test Equipment:

ID	Asset #	Description	Model	Calibration Date	Cal Due Date
	AN02869	Spectrum Analyzer	E4440A	2/6/2013	2/6/2015
	AN03418	Signal Generator	Agilent	7/26/2013	7/26/2013
	AN02946	Cable	Astrolab Inc.	7/31/2013	7/31/2015

Equipment Under Test (* = EUT):

Function	Manufacturer	Model #	S/N
Provider Specific Consumer Signal Booster*	Nextivity, Inc.	CELFIR-S224WU	159311000046
Provider Specific Consumer Signal Booster	Nextivity, Inc.	CELFIR-S224CU	159311000046

Test Conditions / Notes:

The EUT is provider specific signal booster pair consisted of a Window unit (WU) and a Coverage unit (CU) using proprietary 5.8GHz Wireless interface.

Intended band of operation
 UL= 1850-1910 MHz, 1710-1755MHz; DL= 1930-1990MHz, 2110-2155MHz.

The EUT is capable operating in 5 MHz segment within the CMRS band by setting the Spectrum Block Filter, gain and other operational parameter based on received public land mobile network (PLMN) ID.

For testing purposes, the Spectrum block filter and operation of the booster is set in test mode using a laptop and test software interface.

Test environment conditions: 22°C, 32% Relative Humidity, 100kPa

The test was performed In accordance with section 7.5 of the FCC document: **935210 D03 Wideband Consumer Signal Booster Measurement Guidance DR04-41516.**

Using 5 MHz LTE DL signal and 5 MHz LTE UL signal set at 2.5 MHz away from the band edge. Test mode to force the EUT to ignore --40dBm shut off limit.

Test Data

20.21(e)(9)(i)(F) Out Of Band Emissions Summary Table				
Band (MHz)	Input Power (dBm)	Measured Max OOBE Amplitude (dBm)	Limit (dBm)	Result
UL 1710-1755 High Ch	-20	-23	-13	PASS
UL 1710-1755 High Ch	-56	-23.25	-13	PASS
UL 1710-1755 Low Ch	-20	-22.45	-13	PASS
UL 1710-1755 Low Ch	-56	-22	-13	PASS
UL 1850-1910 High Ch	-20	-50.36	-13	PASS
UL 1850-1910 High Ch	-56	-53.36	-13	PASS
UL 1850-1910 Low Ch	-20	-28.07	-13	PASS
UL 1850-1910 Low Ch	-56	-30.1	-13	PASS
DL 1930-1990 High Ch	-20	-60.53	-13	PASS
DL 1930-1990 High Ch	-64	-61.24	-13	PASS
DL 1930-1990 Low Ch	-20	-41.51	-13	PASS
DL 1930-1990 Low Ch	-64	-47.97	-13	PASS
DL 2110-2155 High Ch	-20	-38.89	-13	PASS
DL 2110-2155 High Ch	-64	-37.79	-13	PASS
DL 2110-2155 Low Ch	-20	-37.8	-13	PASS
DL 2110-2155 Low Ch	-64	-36.29	-13	PASS

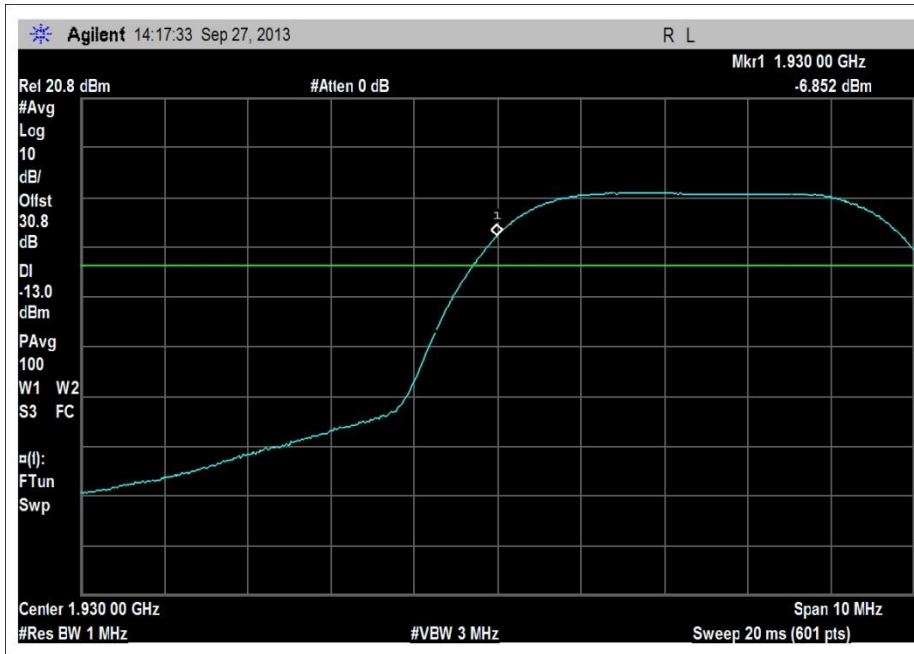

RBW=1MHz

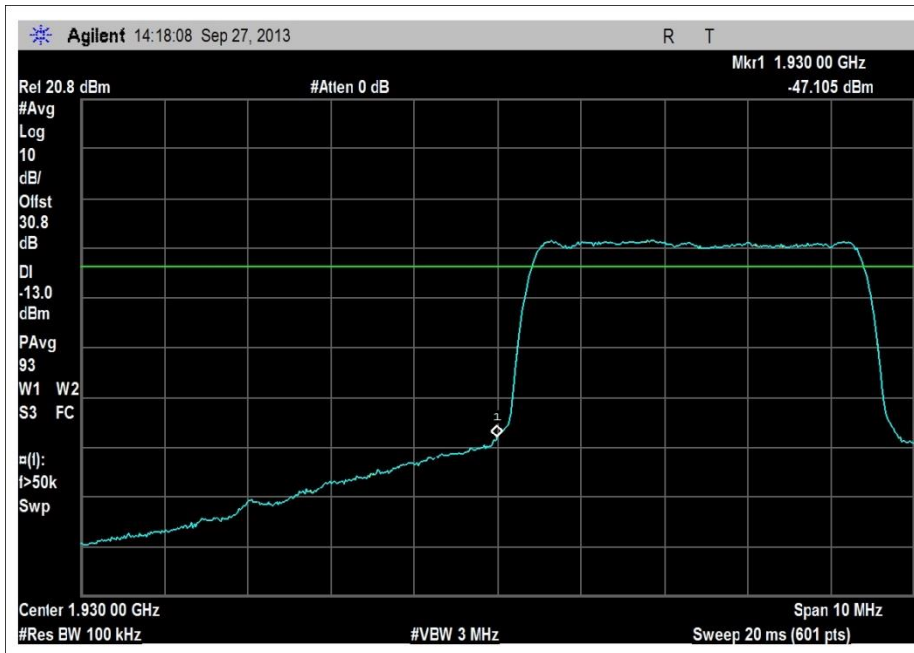

RBW = 100kHz, uncorrected

Due to the nature of the emission, the channel power integration function of the spectrum analyzer was used to integrate emission measured at reduced RBW and summed into 1 MHz as present in the following plots: Out of band emission Power level both at below AGC, and in accordance with 5.4, with Maximum transmitter input level of -20dBm is included. The Yellow line shows the CMRS band, however, Out of band emission 1 MHz immediately outside the licensee’s allocated spectrum is also included in the reported measurement.

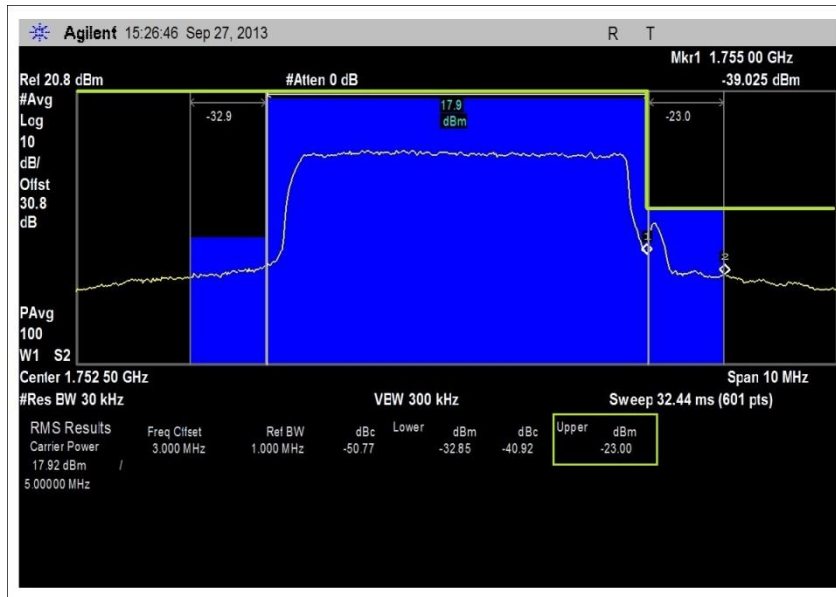

7.6 OEB_1710-1755MHz_H_-20dBm input power

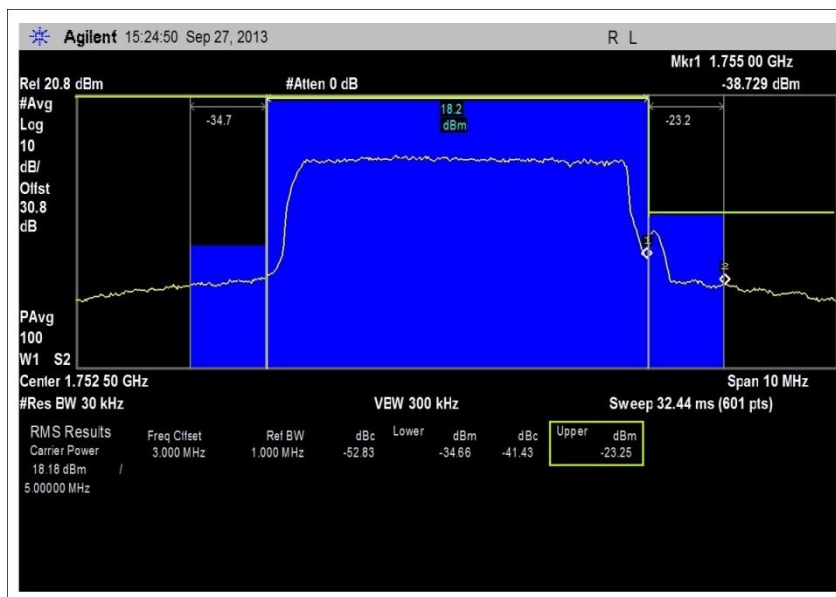

7.6 OEB_1710-1755MHz_H_-56dBm input power

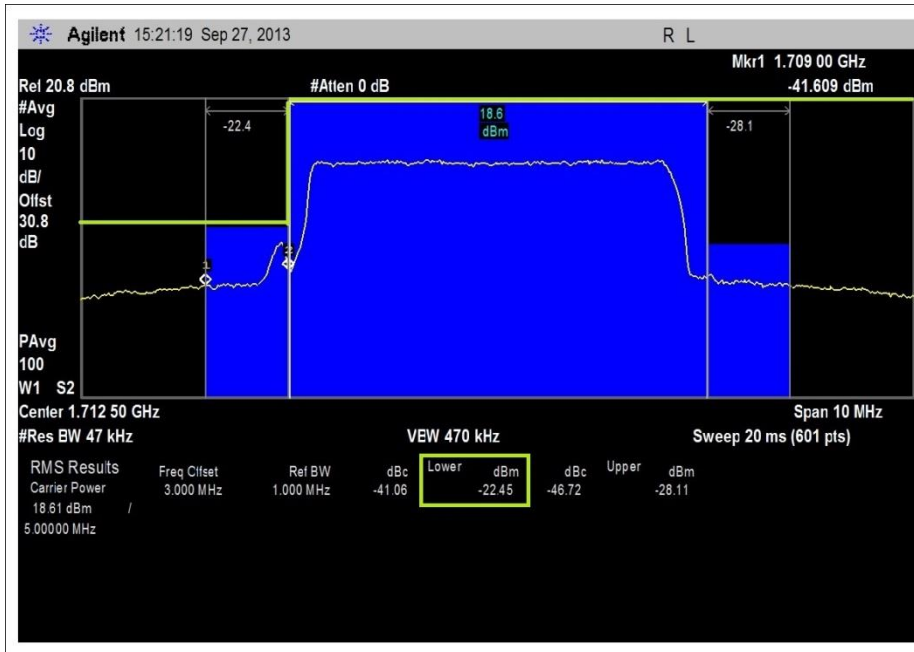

7.6 OEB_1710-1755MHz_L_-20dBm input power

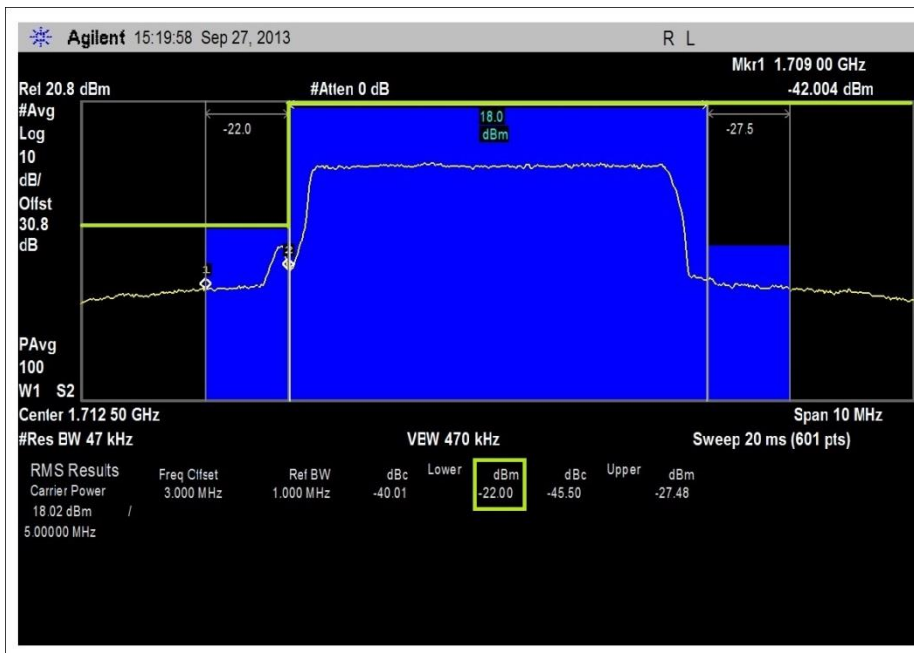

7.6 OEB_1710-1755MHz_L_-56dBm input power

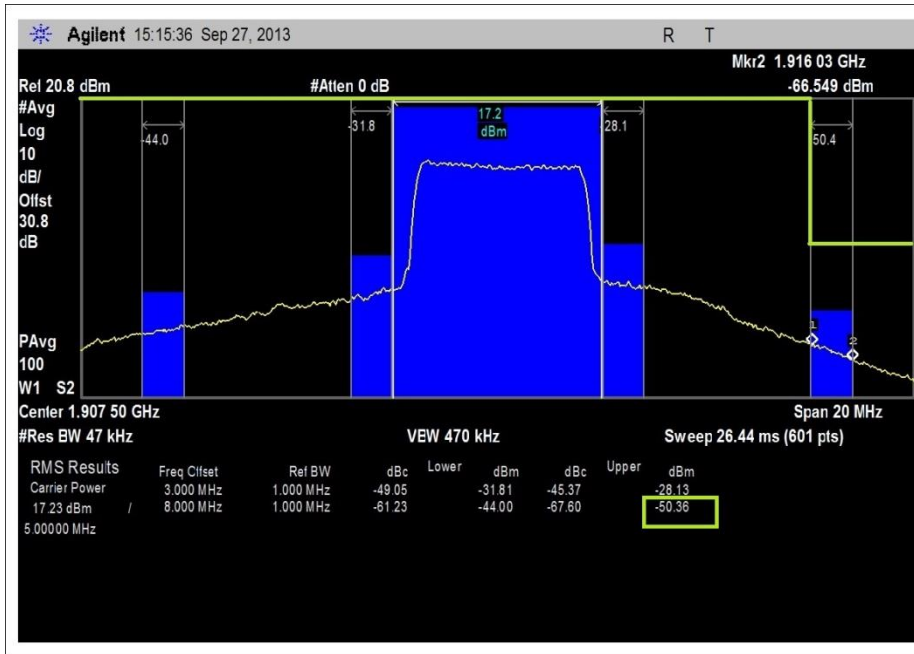

7.6 OEB_1850-1910MHz_H_-20dBm input power

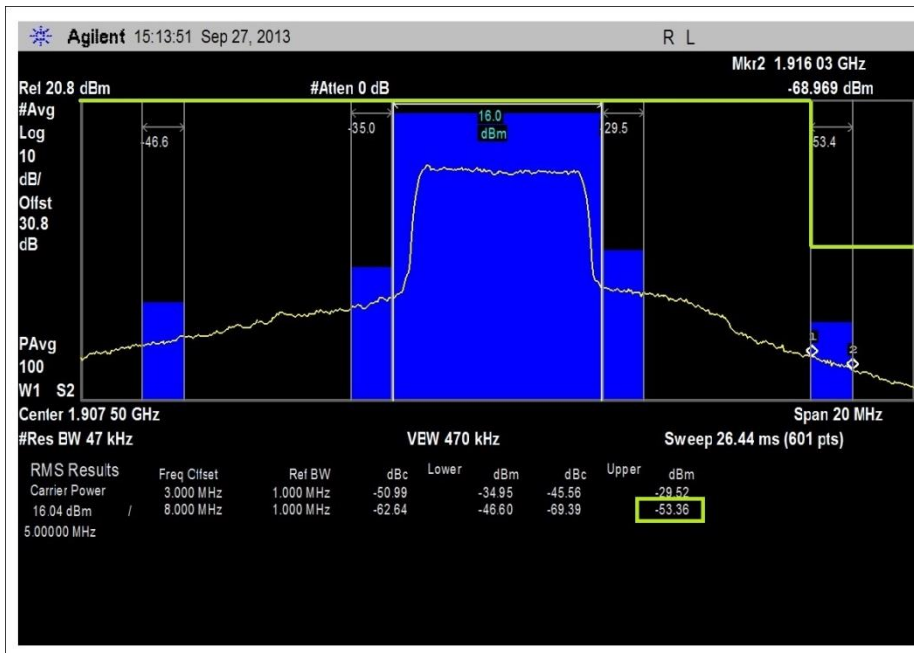

7.6 OEB_1850-1910MHz_H_-56dBm input power

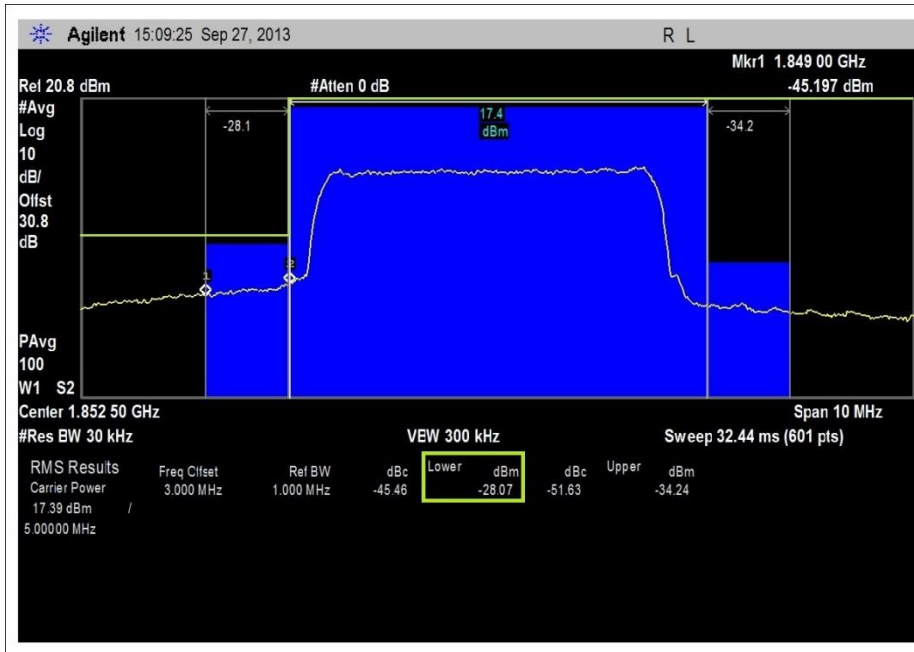

7.6 OEB_1850-1910MHz_L_-20dBm input power

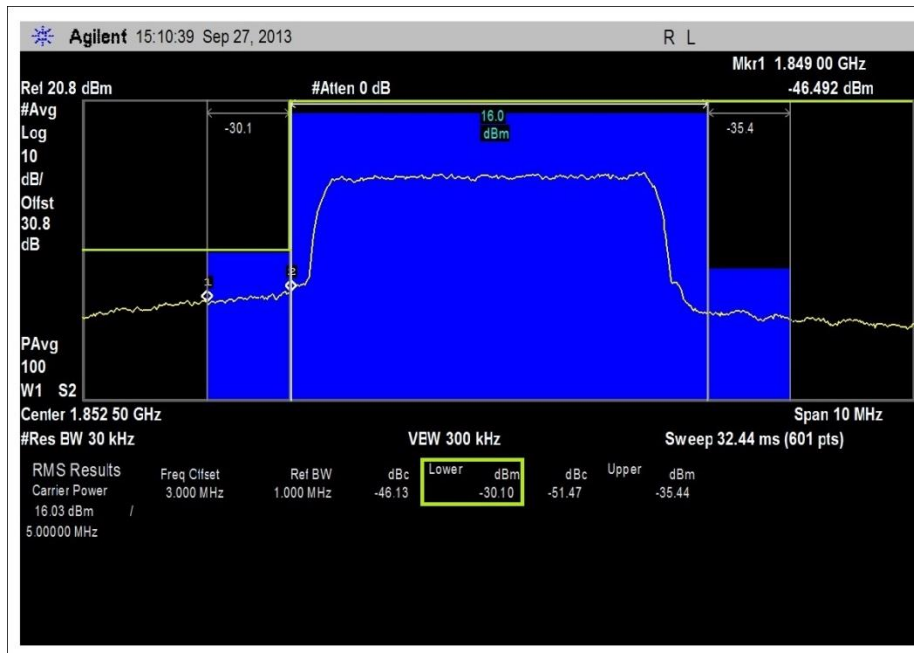

7.6 OEB_1850-1910MHz_L_-56dBm input power

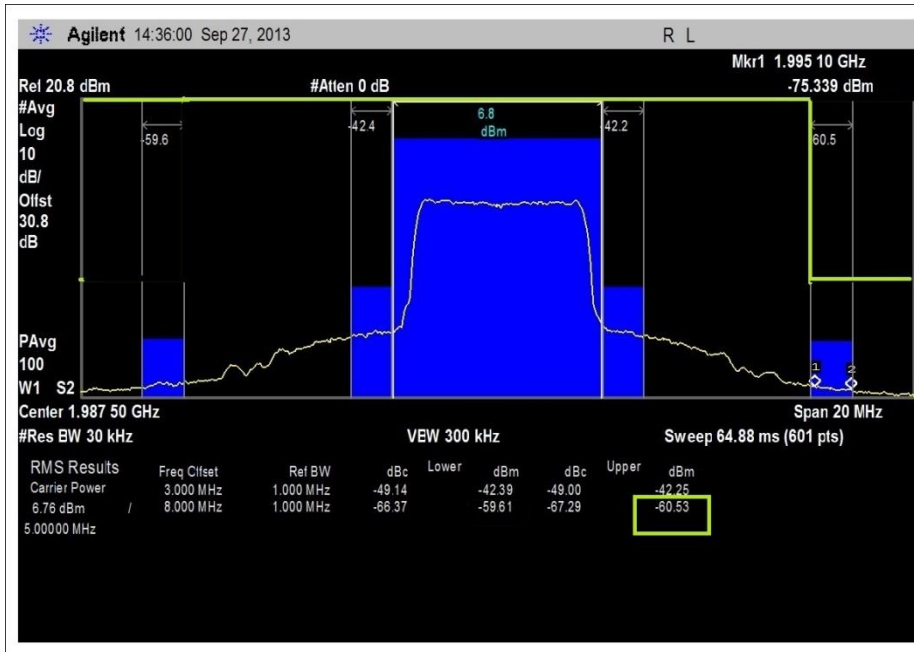

7.6 OEB_1930-1990MHz_H_-20dBm input power

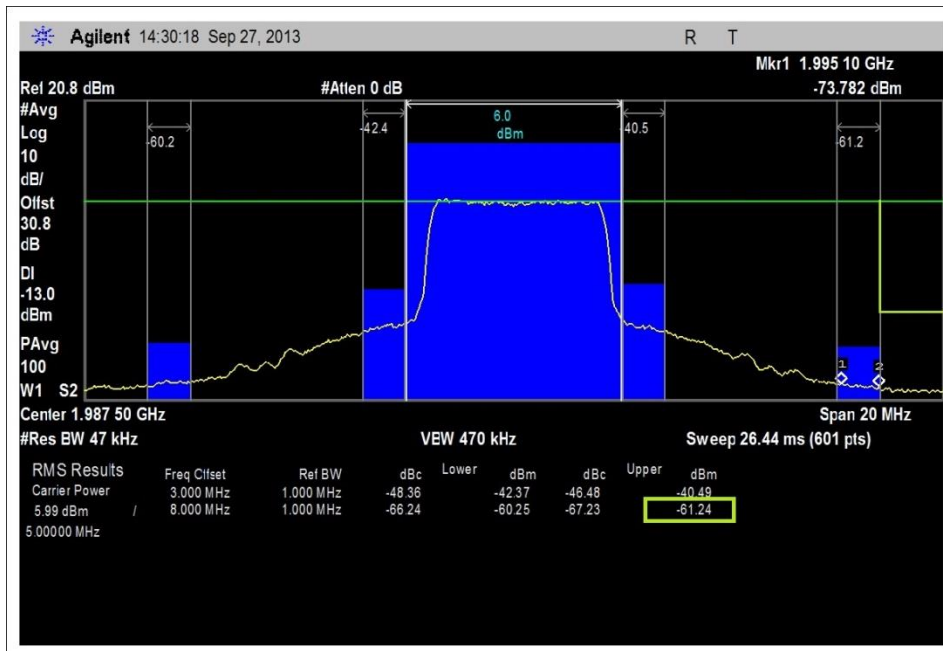

7.6 OEB_1930-1990MHz_H_-64dBm input power

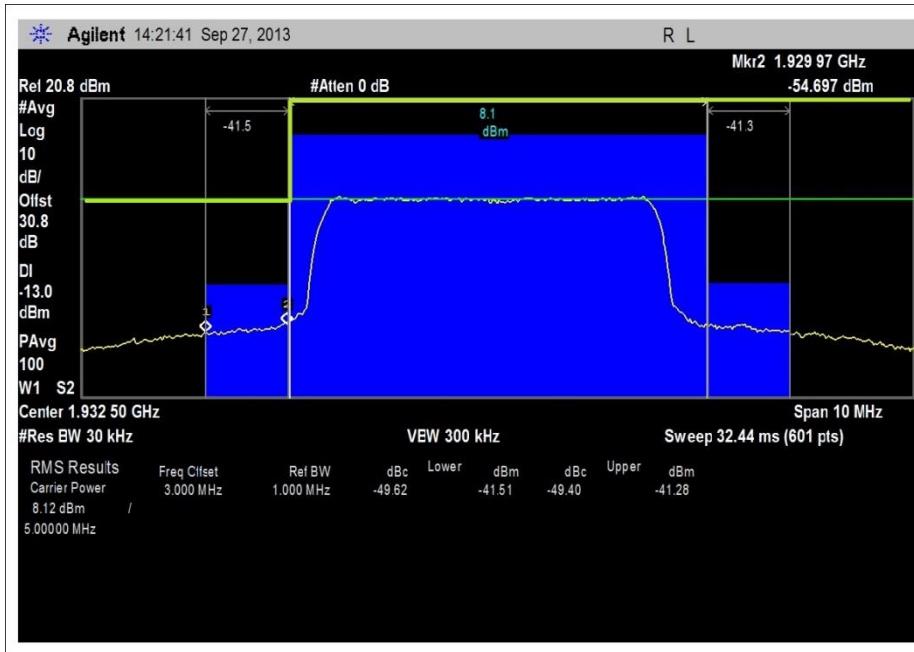

7.6 OEB_1930-1990MHz_L_-20dBm input power

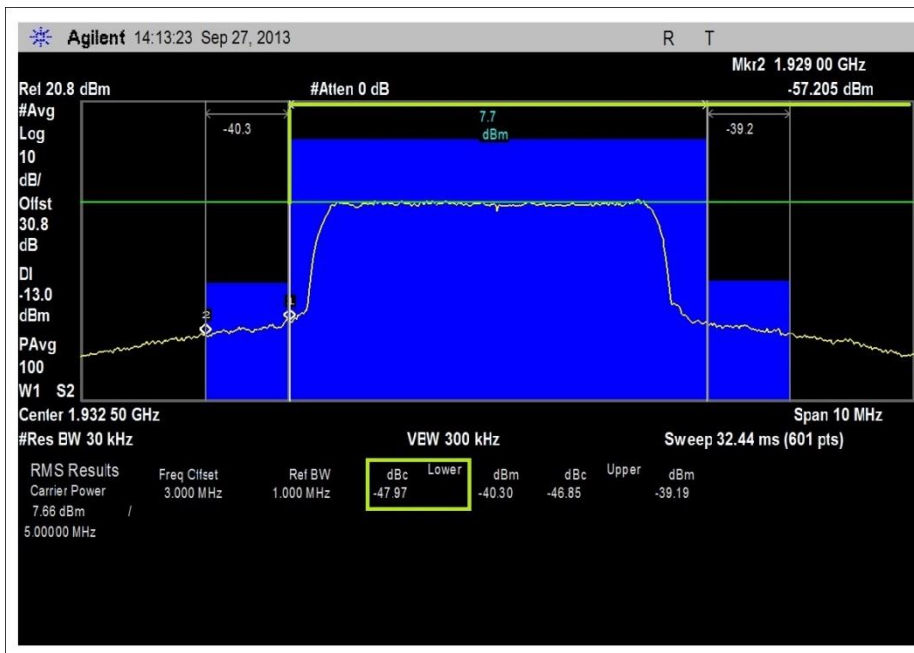

7.6 OEB_1930-1990MHz_L_-64dBm input power

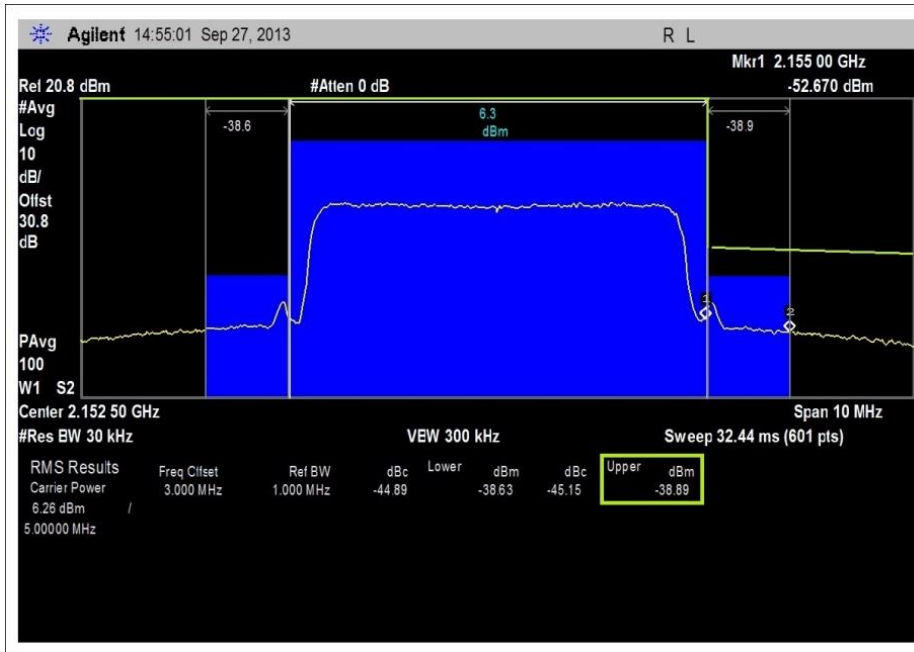

7.6 OEB_2110-2115MHz_H_-20dBm input power

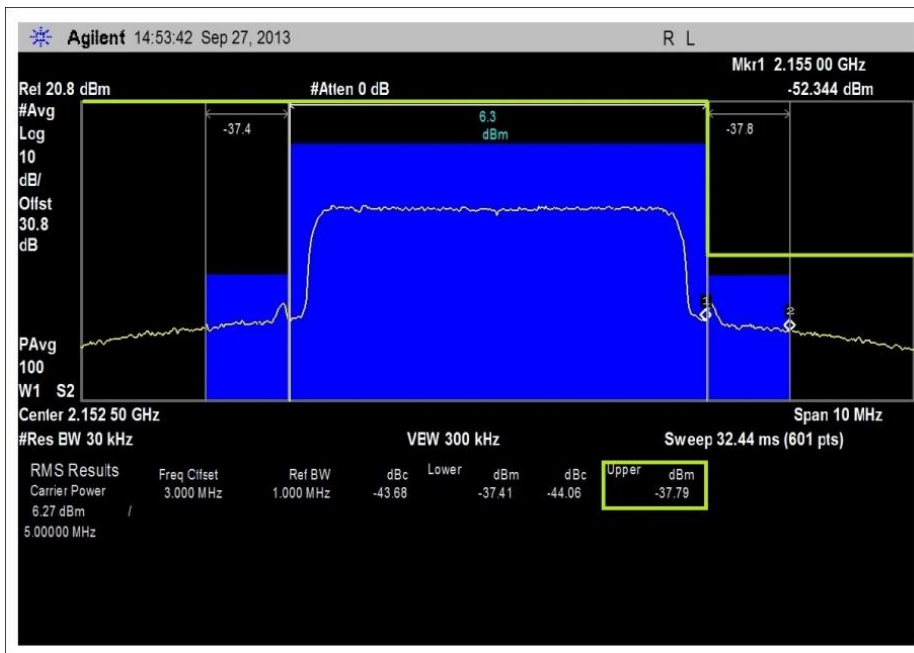

7.6 OEB_2110-2115MHz_H_-64dBm input power

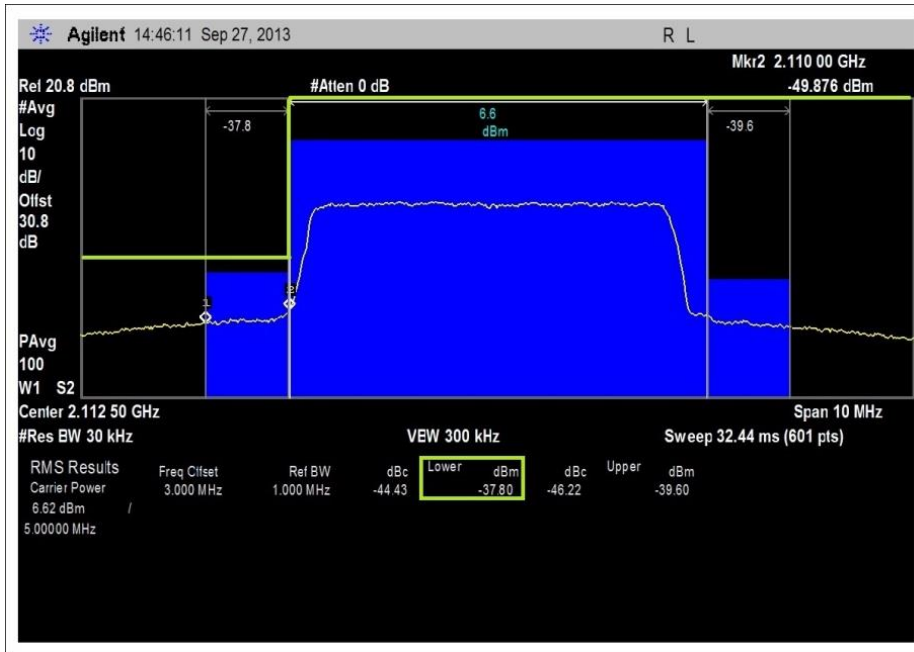

7.6 OEB_2110-2115MHz_L_-20dBm input power

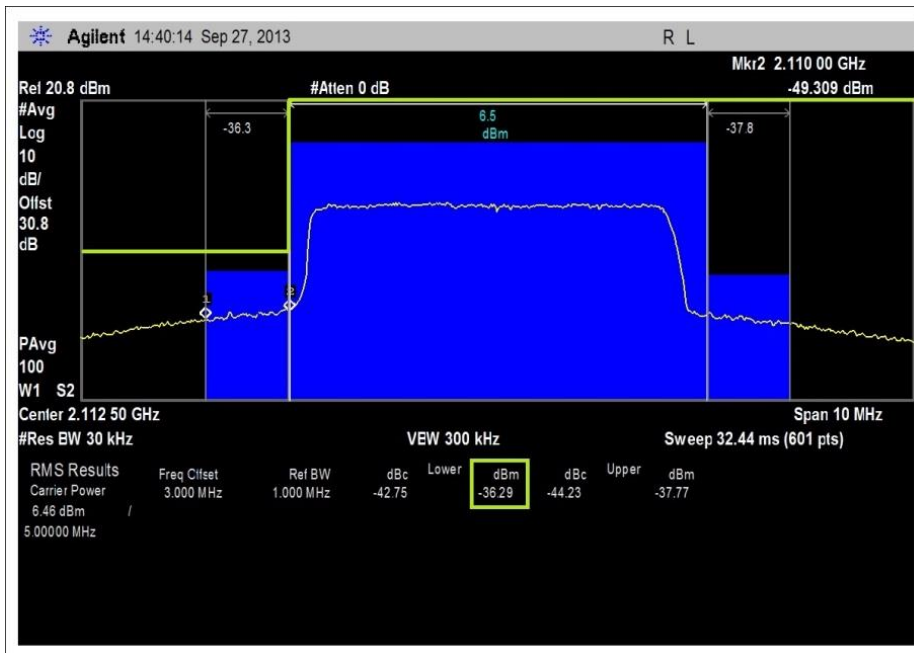

7.6 OEB_2110-2115MHz_L_-64dBm input power

Test Setup Photos



FCC 20.21(e)(9)(i)(G) Intermodulation

Test Conditions / Setup

Test Location: CKC Laboratories, Inc. • 110 North Olinda Place • Brea, CA 92823 • 714-993-6112

Customer: **Nextivity, Inc.**

Specification: **20.21(e) (9)(i)(G) Intermodulation.**

Work Order #: **94857** Date: 9/24/2013

Test Type: **Conducted Emissions** Time: 08:31:39

Equipment: **Provider Specific Consumer Signal Booster** Sequence#: 1

Manufacturer: Nextivity, Inc. Tested By: E. Wong

Model: CELFI-RS224WU, CELFI-RS224CU 110V 60Hz

S/N: 159311000046, 159311000046

Test Equipment:

ID	Asset #	Description	Model	Calibration Date	Cal Due Date
	AN02869	Spectrum Analyzer	E4440A	2/6/2013	2/6/2015
	AN03418	Signal Generator	Agilent	7/26/2013	7/26/2013
	C00032	Signal Generator	Agilent	9/20/2013	9/20/2013
	AN02946	Cable	Astrolab Inc.	7/31/2013	7/31/2015

Equipment Under Test (* = EUT):

Function	Manufacturer	Model #	S/N
Provider Specific Consumer Signal Booster*	Nextivity, Inc.	CELFIR-S224WU	159311000046
Provider Specific Consumer Signal Booster	Nextivity, Inc.	CELFIR-S224CU	159311000046

Test Conditions / Notes:

The EUT is provider specific signal booster pair consisted of a Window unit (WU) and a Coverage unit (CU) using proprietary 5.8 GHz Wireless interface.

Intended band of operation
 UL= 1850-1910 MHz, 1710-1755MHz
 DL= 1930-1990MHz, 2110-2155MHz.

The EUT is capable operating in 5 MHz segment within the CMRS band by setting the Spectrum Block Filter, gain and other operational parameter based on received public land mobile network (PLMN) ID.

For testing purposes, the Spectrum block filter and operation of the booster is set in test mode using a laptop and test software interface.

Test environment conditions: 22°C, 32% Relative Humidity, 100kPa

The test was performed In accordance with section 7.4 of the FCC document: **935210 D03 Wideband Consumer Signal Booster Measurement Guidance DR04-41516.**

Test Data

The Booster is designed to boost wideband signal, the measurement was not possible when the input signal was set to CW or 200kHz AWGN sign due to equipment shut down. Two channels of 4.1MHz AWGN signal would not fit in the intended 5 MHz band. In order to fit two CW into the operational band, the Anti- Oscillation Circuit was disabled for this test.

The limit for the Provider specific Booster is -19 dBm. The test power level of the CW after the combiner was verified with a spectrum analyzer to ensure the injected level is at the correct test level. Additional plots at wider span are included.

Intermodulation Summary Table			
Band (MHz)	Measured Intermodulation Amplitude (dBm)	Limit (dBm)	Result
UL 1710-1755	-19.96	-19	PASS
UL 1850-1910	-50.54	-19	PASS
DL 1930-1990	-38.48	-19	PASS
DL 2110-2155	-30.76	-19	PASS

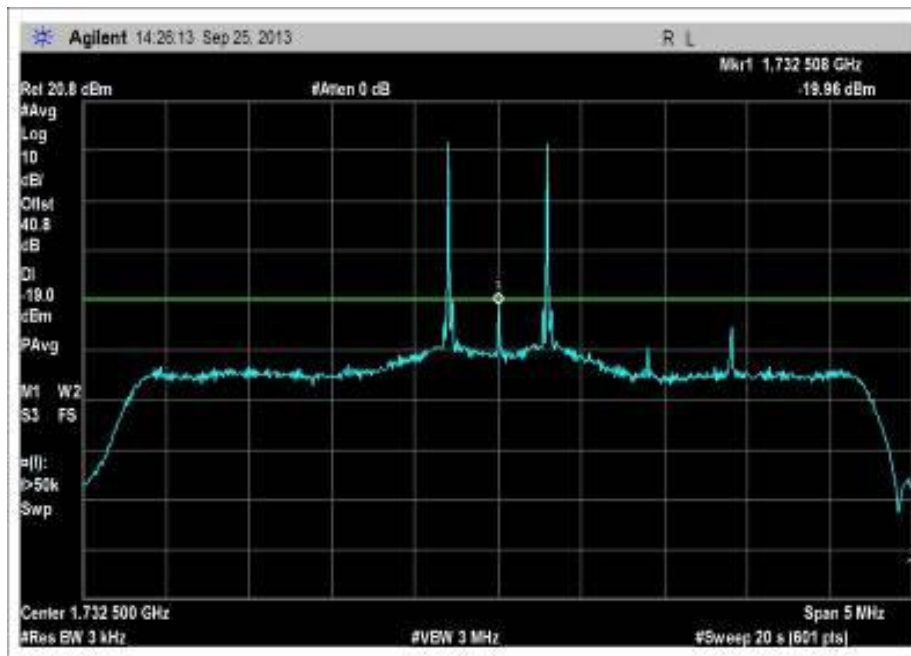

7.4 intermod_1710-1755MHz

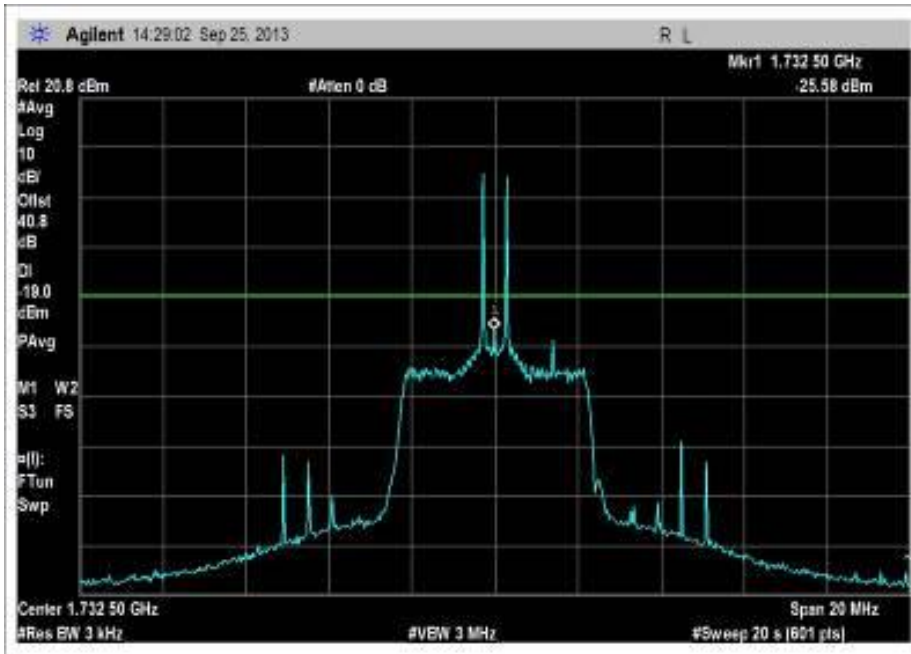

7.4 intermod_1710-1755MHz Span out

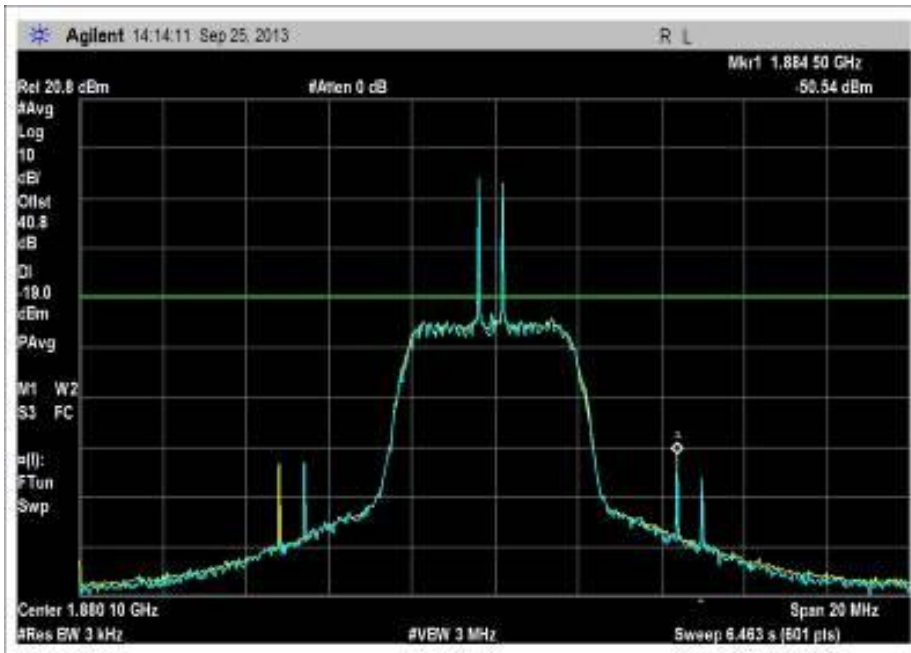

7.4 intermod_1850-1910MHz

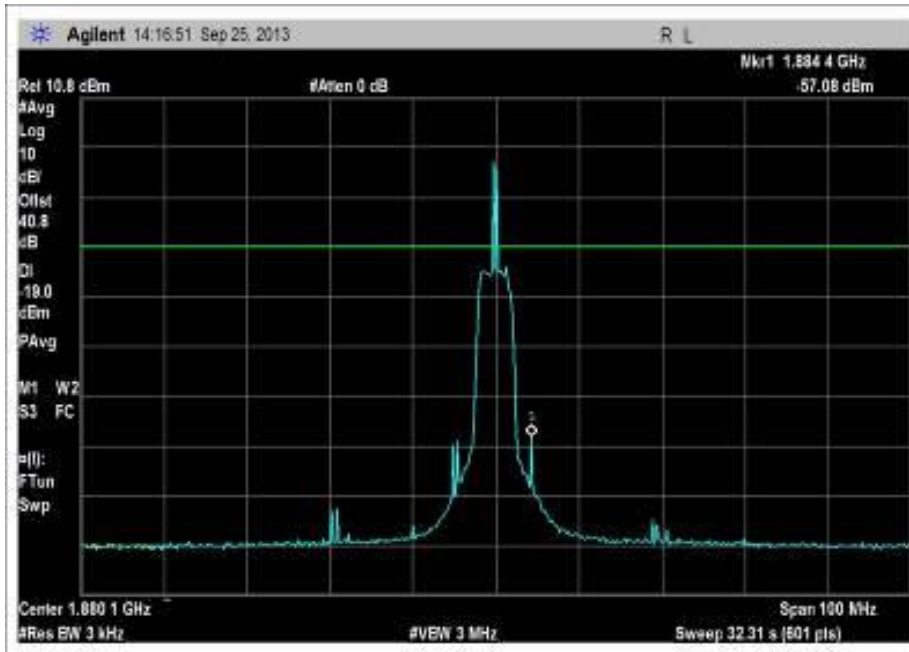

7.4 intermod_1850-1910MHz Span out

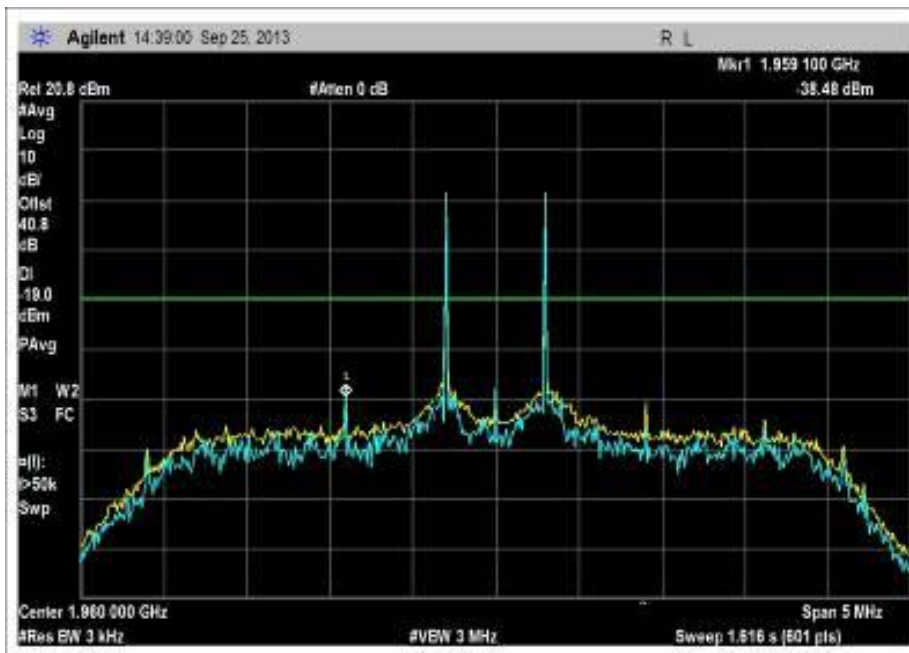

7.4 intermod_1930-1990MHz

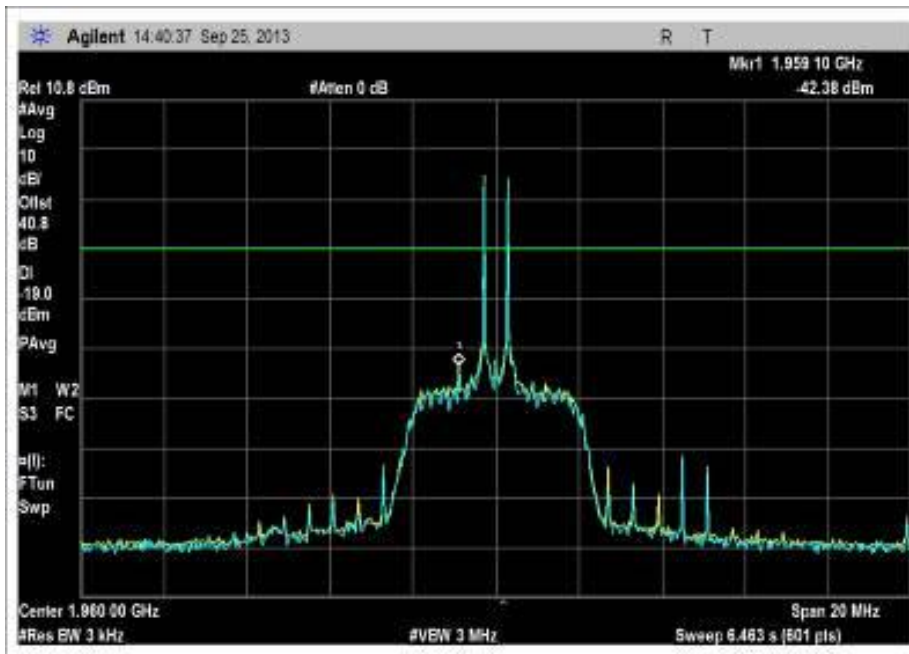

7.4 intermod_1930-1990MHz Span out

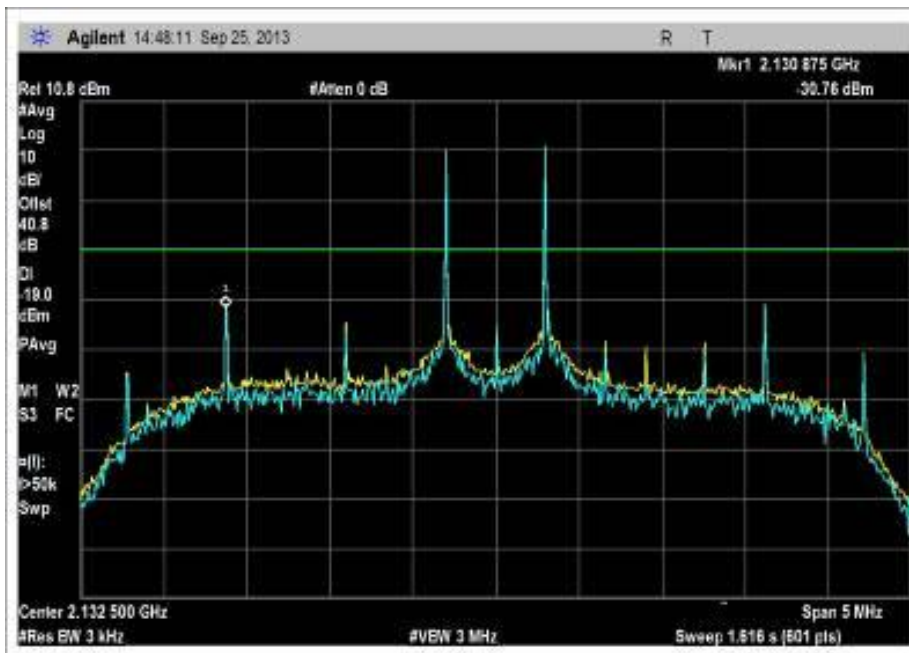

7.4 intermod_2110-2155MHz

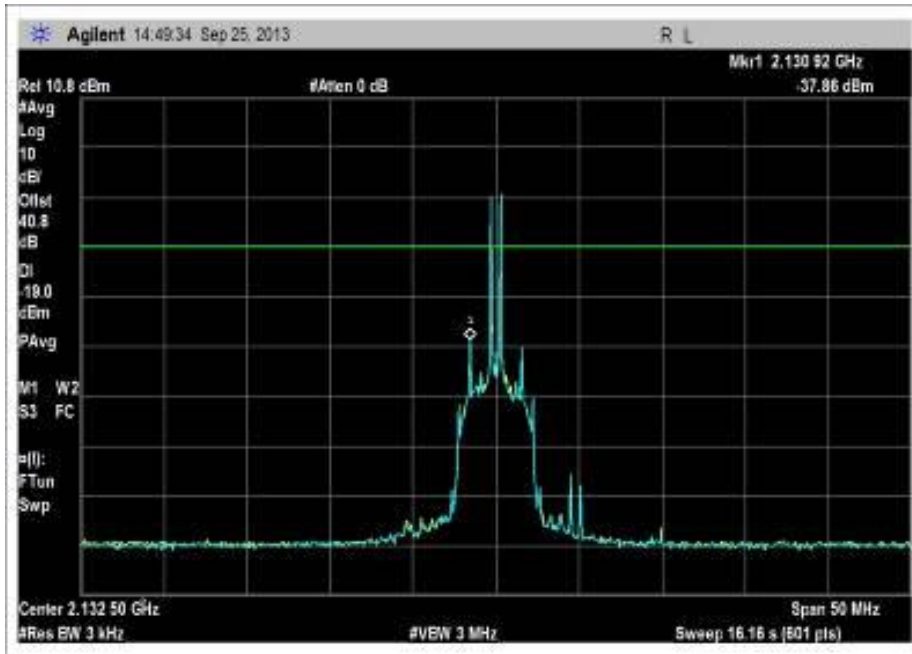

7.4 intermod_2110-2155MHz Span out

Test Setup Photos



FCC 20.21(e)(9)(i)(I) Transmit Power – Off Mode

Test Conditions / Setup

Test Location: CKC Laboratories, Inc. • 110 North Olinda Place • Brea, CA 92823 • 714-993-6112

Customer: **Nextivity, Inc.**
 Specification: **20.21(e) (9)(i)(I) Transmit Power Off mode**

Work Order #: **94857** Date: 9/24/2013
 Test Type: **Conducted Emissions** Time: 08:31:39
 Equipment: **Provider Specific Consumer Signal Booster** Sequence#: 1

Manufacturer: Nextivity, Inc. Tested By: E. Wong
 Model: CELFI-RS224WU, CELFI-RS224CU 110V 60Hz
 S/N: 159311000046, 159311000046

Test Equipment:

ID	Asset #	Description	Model	Calibration Date	Cal Due Date
	AN02869	Spectrum Analyzer	E4440A	2/6/2013	2/6/2015
	AN03418	Signal Generator	Agilent	7/26/2013	7/26/2013
	AN02946	Cable	Astrolab Inc.	7/31/2013	7/31/2015

Equipment Under Test (* = EUT):

Function	Manufacturer	Model #	S/N
Provider Specific Consumer Signal Booster*	Nextivity, Inc.	CELFIR-S224WU	159311000046
Provider Specific Consumer Signal Booster	Nextivity, Inc.	CELFIR-S224CU	159311000046

Test Conditions / Notes:

The EUT is provider specific signal booster pair consisted of a Window unit (WU) and a Coverage unit (CU) using proprietary 5.8 GHz Wireless interface.
 Intended band of operation
 UL= 1850-1910 MHz, 1710-1755MHz
 DL= 1930-1990MHz, 2110-2155MHz.

The EUT is capable operating in 5 MHz segment within the CMRS band by setting the Spectrum Block Filter, gain and other operational parameter based on received public land mobile network (PLMN) ID.
 For testing purposes, the Spectrum block filter and operation of the booster is set in test mode using a laptop and test software interface.
 Test environment conditions: 22°C, 32% Relative Humidity, 100kPa

The test was performed in accordance with section 7.7, figure 4 (with slight variation) of the FCC document: **935210 D03 Wideband Consumer Signal Booster Measurement Guidance DR04-41516**

Test Data

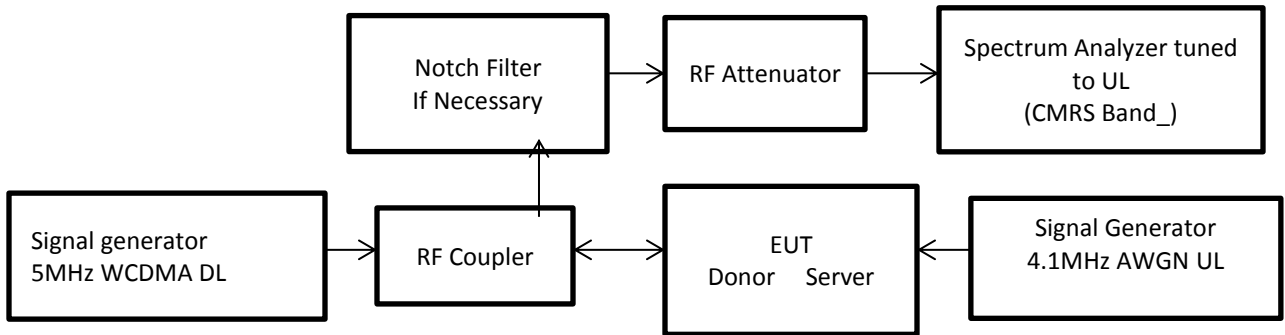

The Booster is designed to enter power off state when the Downlink power exceeds -40dBm where it does not meet the noise and gain limit, and/or in the event Uplink signal is not present at the server port.

This test is to demonstrate the Uplink and down link Noise power is below the -70dBm/MHz limit when the booster is in the Transmit Power Off Mode.

To initiate booster operation:

For this test, due to the unique operation of this booster, the Uplink signal was initially off, a 5MHz WCDMA DL signal is sent to the Booster to initialize operation. After the booster is in operation, an Uplink, 4.1MHz Signal at below AGC level was applied to the EUT to place it in uplink On state. (The booster will shut off the UL Path in the absent of UL signal)

Noise power was captured in transmitter power off mode as presented in the following:
 Measurement was made via a directional coupler, with reverse power connected to the spectrum analyzer, Sig gen was connected to the input port of the directional coupler, and the output of the directional coupler was connected to the Donor port by which the WCDMA DL signal (for initializing purposes) was injected into.
 The UL noise power measurement was made with test procedure described above, with frequency span of the spectrum analyzer set wide enough to cover the CMRS band. Initially with UL signal presence, a trace was captured, then the UL signal was turned off and another trace was captured.

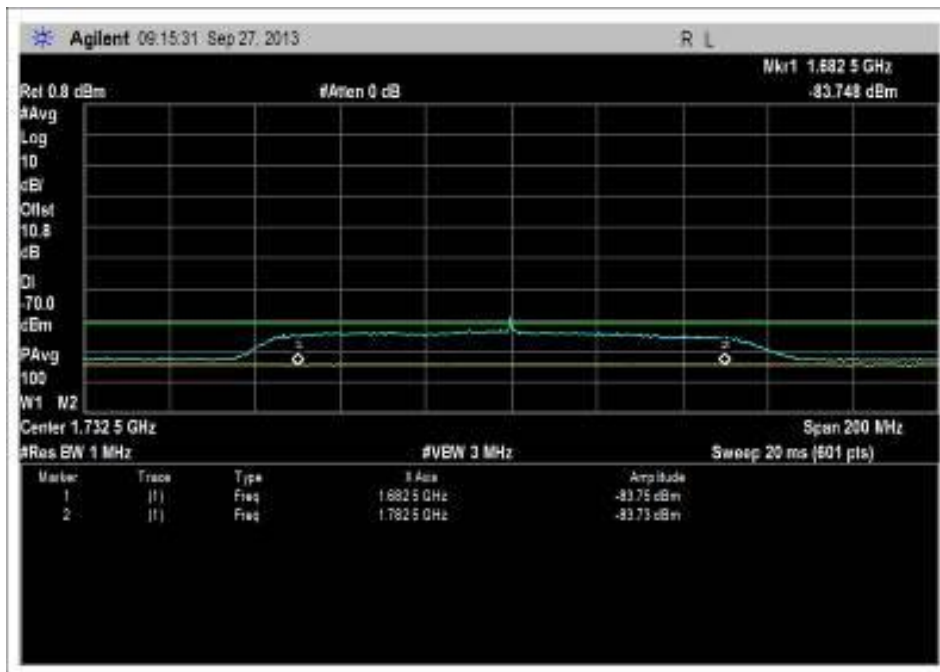

UL 1710-1755 MHz, Blue trace is Booster initialized and turned on, Yellow trace is Transmitter, power off

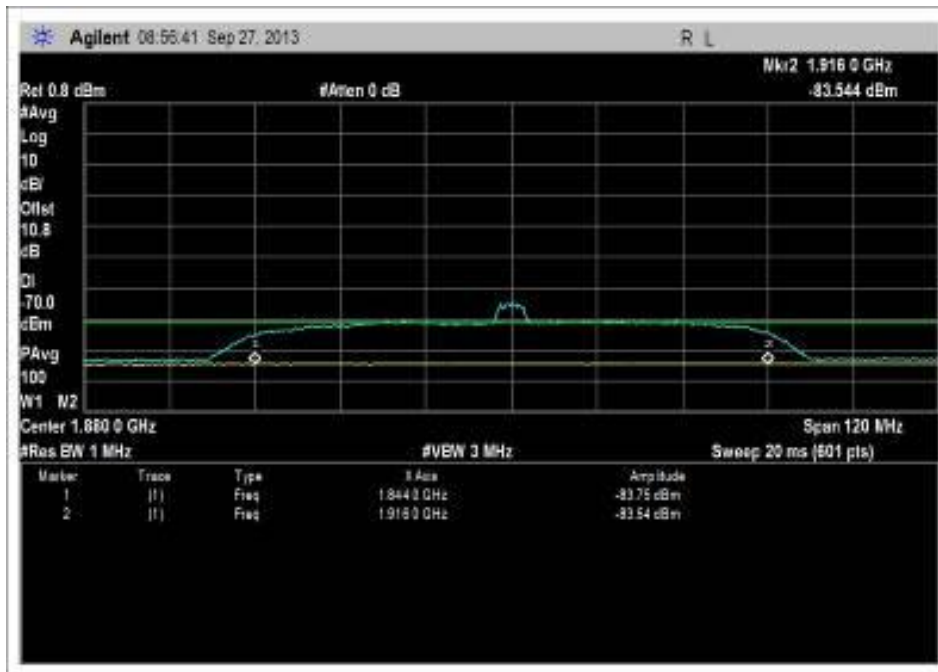

UL 1850-1910MHz, Blue trace is Booster initialized and turned on, Yellow trace is Transmitter power off.

DL noise power measurement was made with test procedure described below, with span covering the DL CMRS band.

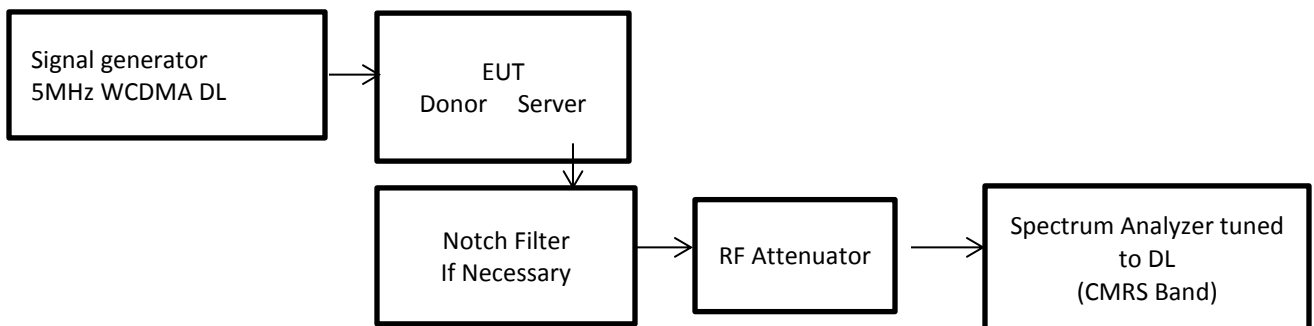

Initially with a DL link WCDMA signal to initialize the booster and placed DL path of the booster in On state, a trace was recorded, then the DL signal was turned off to for evaluation of DL noise power in the absent of DL signal, with another trace recorded.

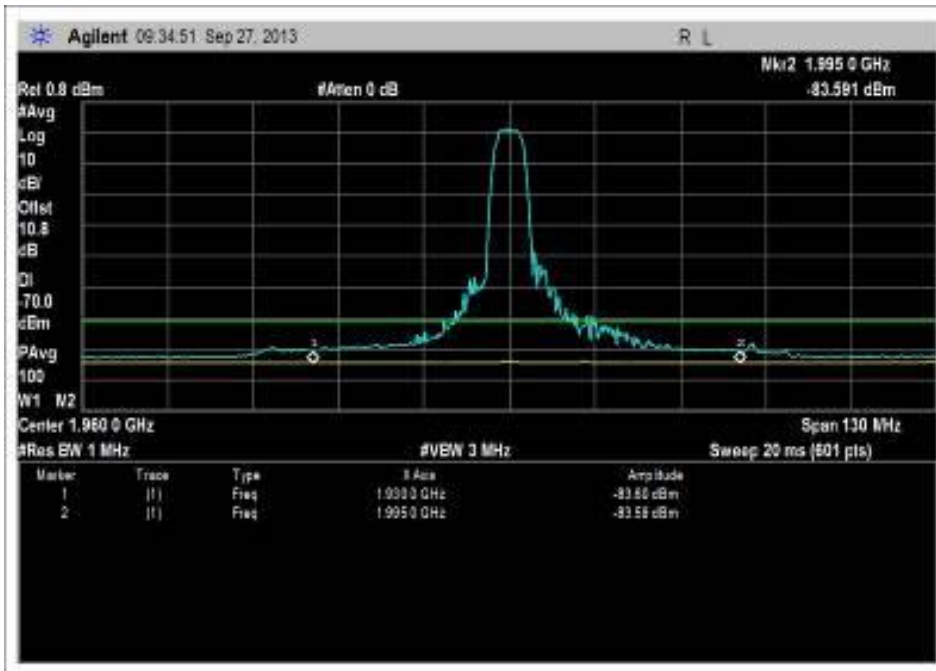

DL: 1930-1990MHz Blue trace is Booster on, signal in the center of the band is the DL Signal. Yellow trace is DL noise power in the absent of DL signal.

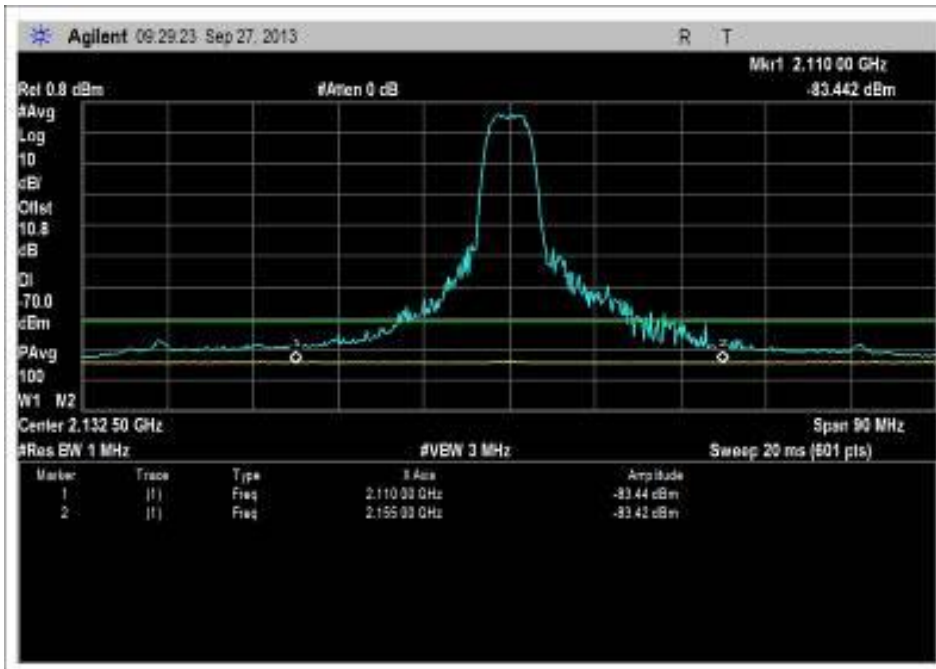

DL: 2110-2155MHz Blue trace is Booster on, signal in the center of the band is the DL signal. Yellow trace is DL noise power in the absent of DL signal.

Test Setup Photos



UL Noise

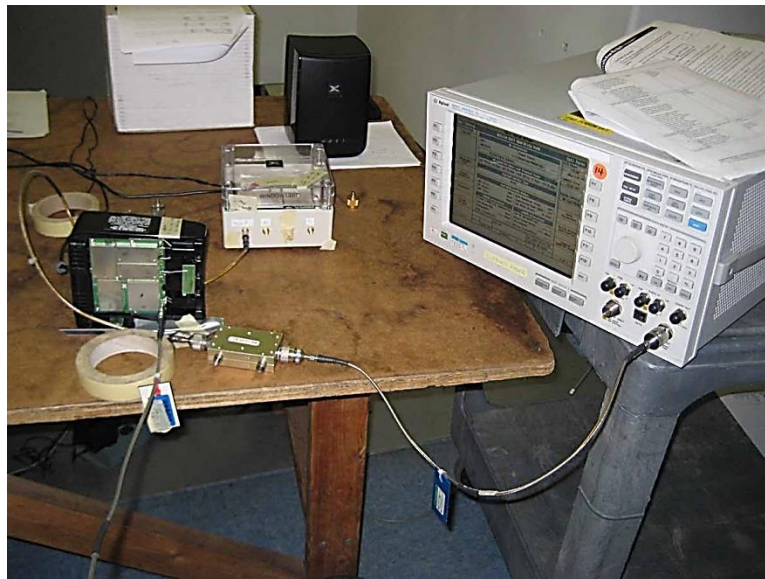

DL Noise

FCC 20.21(e)(9)(i)(J) Uplink Inactivity
Test Conditions / Setup

Test Location: CKC Laboratories, Inc. • 110 North Olinda Place • Brea, CA 92823 • 714-993-6112

Customer: **Nextivity, Inc.**
 Specification: **20.21(e)(9)(i)(J) Uplink In activity**
 Work Order #: **94857** Date: 9/24/2013
 Test Type: **Conducted Emissions** Time: 08:31:39
 Equipment: **Provider Specific Consumer Signal Booster** Sequence#: 1
 Manufacturer: Nextivity, Inc. Tested By: E. Wong
 Model: CELFI-RS224WU, CELFI-RS224CU 110V 60Hz
 S/N: 159311000046, 159311000046

Test Equipment:

ID	Asset #	Description	Model	Calibration Date	Cal Due Date
	AN02869	Spectrum Analyzer	E4440A	2/6/2013	2/6/2015
	AN03418	Signal Generator	Agilent	7/26/2013	7/26/2013
	AN02946	Cable	Astrolab Inc.	7/31/2013	7/31/2015

Equipment Under Test (* = EUT):

Function	Manufacturer	Model #	S/N
Provider Specific Consumer Signal Booster*	Nextivity, Inc.	CELFIR-S224WU	159311000046
Provider Specific Consumer Signal Booster	Nextivity, Inc.	CELFIR-S224CU	159311000046

Test Conditions / Notes:

The EUT is provider specific signal booster pair consisted of a Window unit (WU) and a Coverage unit (CU) using proprietary 5.8 GHz Wireless interface.
 Intended band of operation
 UL= 1850-1910 MHz, 1710-1755MHz
 DL= 1930-1990MHz, 2110-2155MHz.
 The EUT is capable operating in 5 MHz segment within the CMRS band by setting the Spectrum Block Filter, gain and other operational parameter based on received public land mobile network (PLMN) ID.
 For testing purposes, the Spectrum block filter and operation of the booster is set in test mode using a laptop and test software interface.
 Test environment conditions: 22°C, 32% Relative Humidity, 100kPa

The test was performed In accordance with section 7.8 of the FCC document: **935210 D03 Wideband Consumer Signal Booster Measurement Guidance DR04-41516**

Test Data

For this test, due to the unique operation of this booster, the Uplink signal was initially off, a 5MHz WCDMA DL signal is sent to the Booster to initialize operation. After the booster is in operation, an Uplink, 4.1MHz Signal at below AGC level was applied to the EUT to place it in uplink On state.

Measurement was made via a directional coupler, with reverse power connected to the spectrum analyzer, Sig gen was connected to the input port of the directional coupler, and the output of the directional coupler was connected to the Donor port by which the DL signal was injected into.

With the span on the spectrum analyzer set at 0 Hz, sweep time set to 10 second, Uplink signal was turned off at t=2 second. The time between t = 2 second and the time at which the noise power reduced to the Uplink inactivity noise power limit was captured. The limit is 5 second.

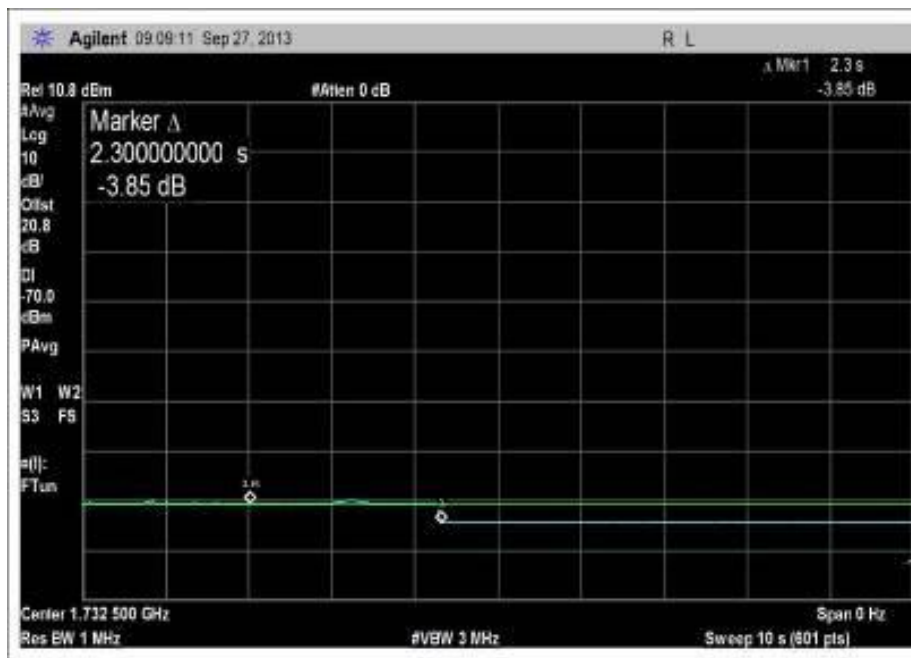

UL 1710-1755MHz band, 2.3 sec.

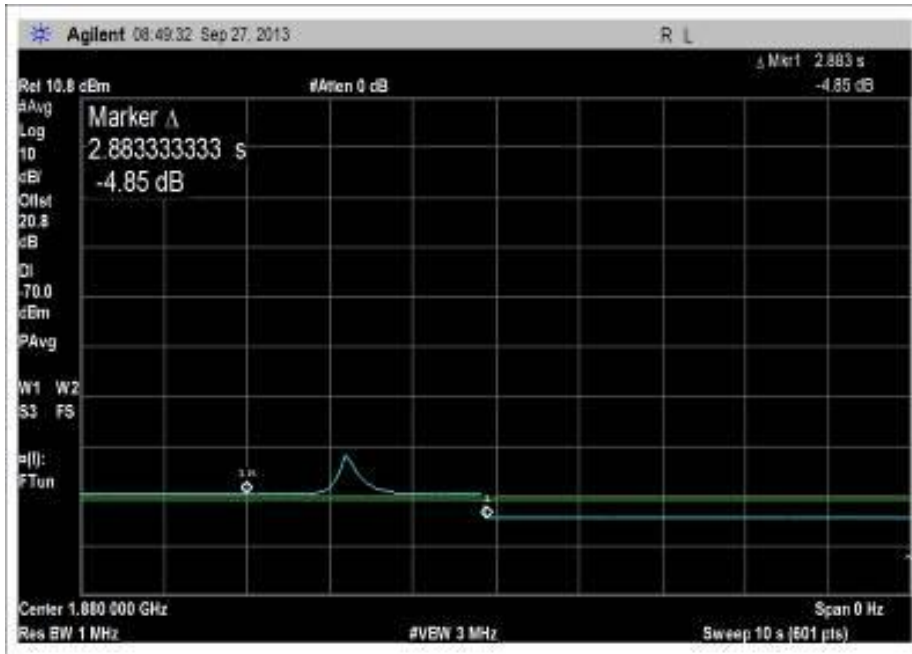

UL 1850 – 1910 MHz band, 2.83 sec

Test Setup Photos



FCC 20.21(e)(9)(ii)(A) Anti Oscillation Detection

Test Conditions / Setup

Test Location: CKC Laboratories, Inc. • 110 North Olinda Place • Brea, CA 92823 • 714-993-6112

Customer: **Nextivity, Inc.**
 Specification: **FCC20.21(e)(9)(ii)(A) Anti Oscillation detection.**
 Work Order #: **94857** Date: 9/24/2013
 Test Type: **Conducted Emissions** Time: 08:31:39
 Equipment: **der Specific Consumer Signal Booster** Sequence#: 1
 Manufacturer: Nextivity, Inc. Tested By: E. Wong
 Model: CELFI-RS224WU, CELFI-RS224CU 110V 60Hz
 S/N: 159311000046, 159311000046

Test Equipment:

ID	Asset #	Description	Model	Calibration Date	Cal Due Date
	AN02869	Spectrum Analyzer	E4440A	2/6/2013	2/6/2015
	AN03418	Signal Generator	Agilent	7/26/2013	7/26/2013
	AN02946	Cable	Astrolab Inc.	7/31/2013	7/31/2015

Equipment Under Test (* = EUT):

Function	Manufacturer	Model #	S/N
Provider Specific Consumer Signal Booster*	Nextivity, Inc.	CELFIR-S224WU	159311000046
Provider Specific Consumer Signal Booster	Nextivity, Inc.	CELFIR-S224CU	159311000046

Support Devices:

Function	Manufacturer	Model #	S/N
----------	--------------	---------	-----

Test Conditions / Notes:

The EUT is provider specific signal booster pair consisted of a Window unit (WU) and a Coverage unit (CU) using proprietary 5.8 GHz Wireless interface.
 Intended band of operation
 UL= 1850-1910 MHz, 1710-1755MHz
 DL= 1930-1990MHz, 2110-2155MHz.
 The EUT is capable operating in 5 MHz segment within the CMRS band by setting the Spectrum Block Filter, gain and other operational parameter based on received public land mobile network (PLMN) ID.
 For testing purposes, the Spectrum block filter and operation of the booster is set in test mode using a laptop and test software interface.
 Test environment conditions: 22°C, 32% Relative Humidity, 100kPa

The test was performed in accordance with section 7.11 of the FCC document: **935210 D03 Wideband Consumer Signal Booster Measurement Guidance DR04-41516** with minor variation due to the unique design of the device.
FCC20.21(e)(9)(ii)(A) Anti-Oscillation:
Consumer boosters must be able to detect and mitigate (i.e.; by automatic gain reduction or shut down), any oscillations in uplink and downlink bands. Oscillation detection and mitigation must occur automatically within 0.3 seconds in the uplink band and within 1 second in the downlink band. In cases where oscillation is detected, the booster must continue mitigation for at least one minute before restarting. After five such restarts, the booster must not resume operation until manually reset.

Test Data

Instead of an Oscilloscope, a spectrum analyzer was used. The EUT with Spectrum Block filter was tuned to the center of the CMRS band and following the set up as in Figure 8 of 935210 D03.

The device would not go into oscillation when following the test procedure by setting the attenuator in 1 dB step or 10 dB step. However, with the Spectrum analyzer span set in the operating band of the device, a spike was detected when the attenuation was set from 110dB and rapidly dropped to 0 dB. The following was observed.

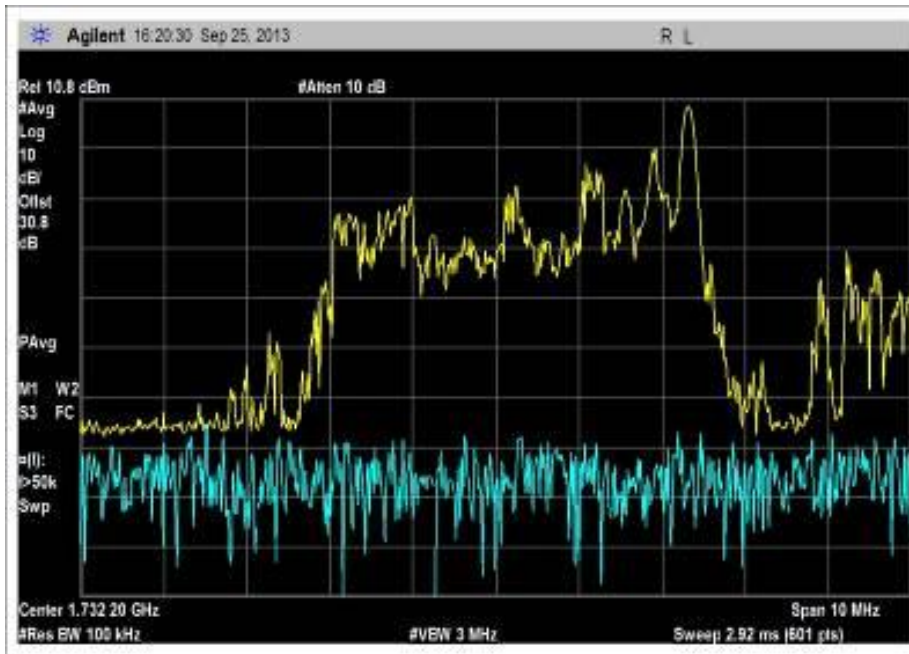

Spike observed when attenuator was rapidly switched from 110dB to 0dB. Yellow trace is Max hold. Blue trace represents noise level in the pass band under investigation.

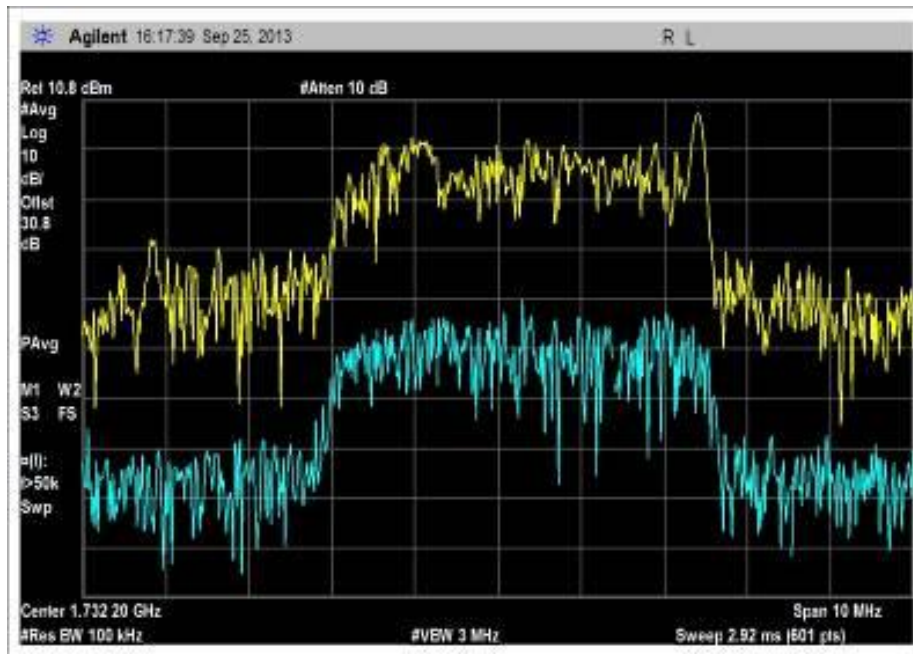

With the attenuator set back to 110dB. Yellow trace is Max hold, blue trace represents noise level in the pass band under investigation.

The test was performed by setting the spectrum analyzer to the frequency where the spike was detected, set span =0 MHz, sweep time at 10 Sec. With Attenuation set at 110dB, initiate a single sweep, and rapidly reduce the attenuation to 0 dB. The time between the spike rises and when it reduces to a value lower than the noise level when the attenuation was set at 110dB is consider the “mitigation” time of the booster.

By design the booster will stay inactive, another plot with sweep time set at 300 s was captured to show inactivity.

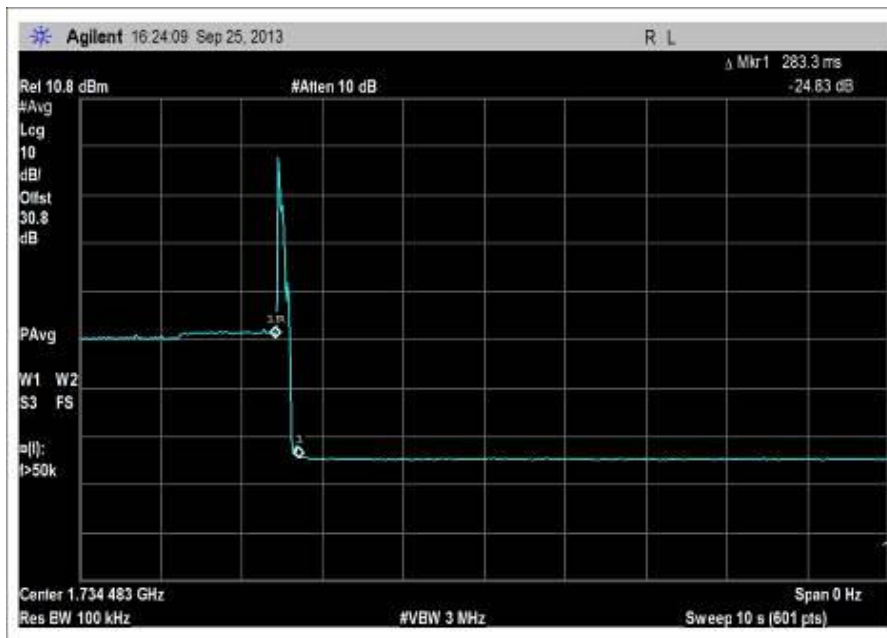

UL: 1710-1755MHz. Measured mitigation time = 283 ms

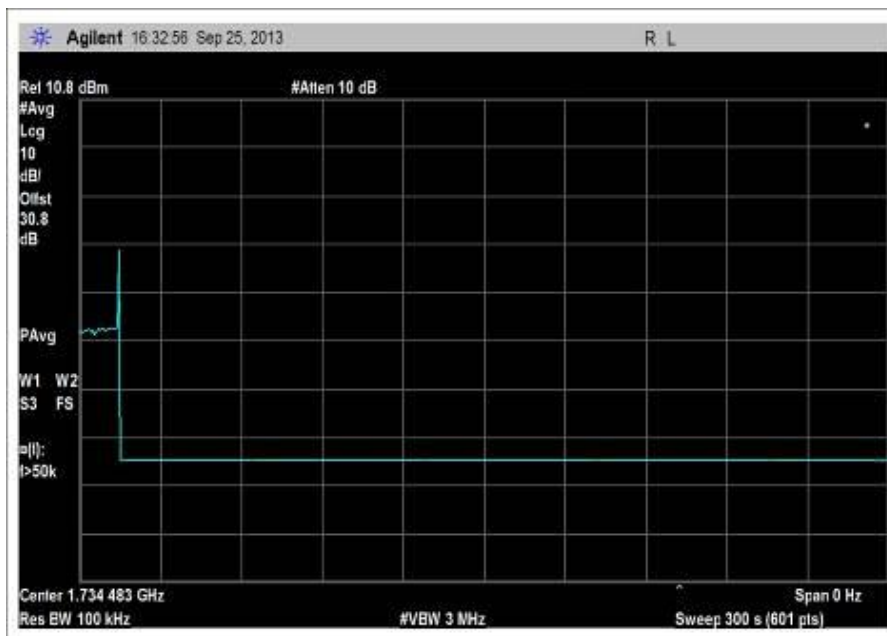

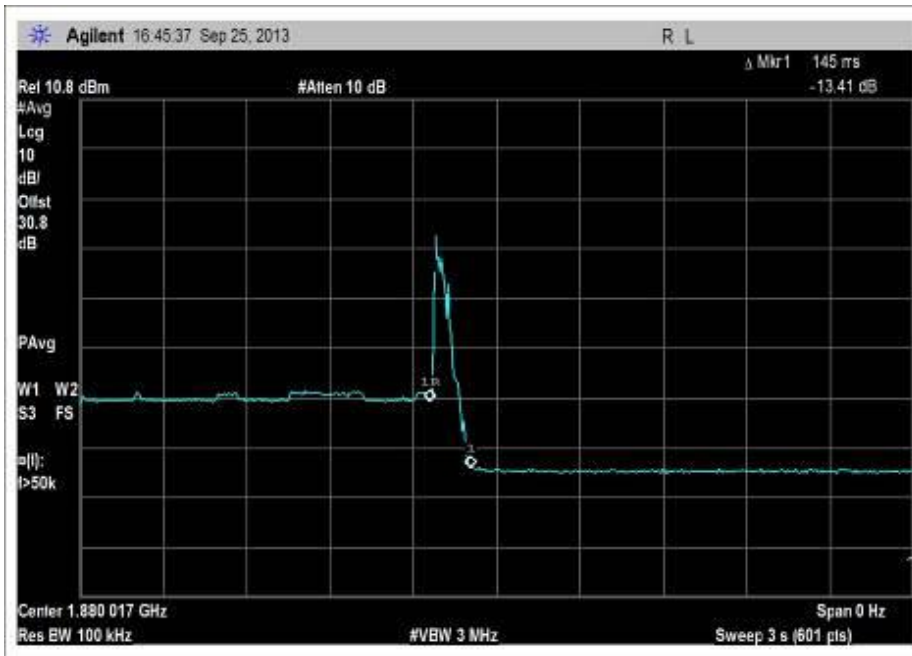

UL: 1850 – 1910MHz. Measured mitigation time = 145 ms.

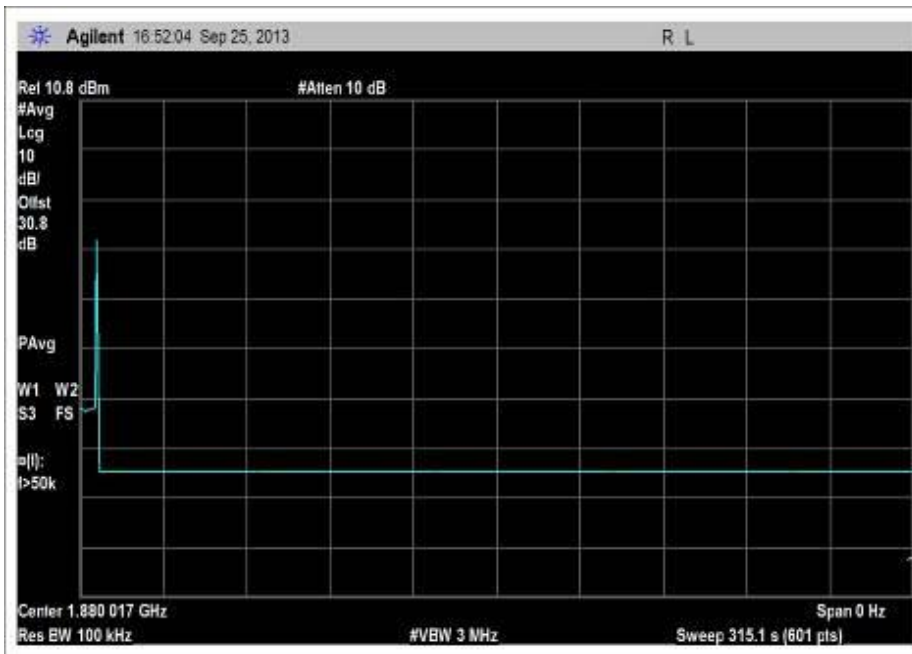

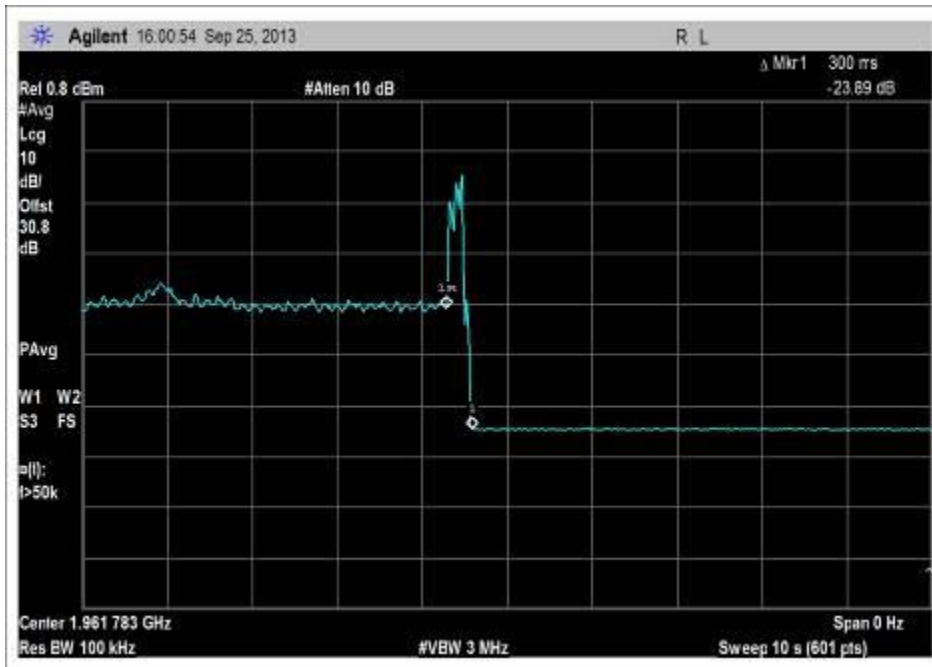

DL: 1930-1990MHz, Measure mitigation time = 300ms

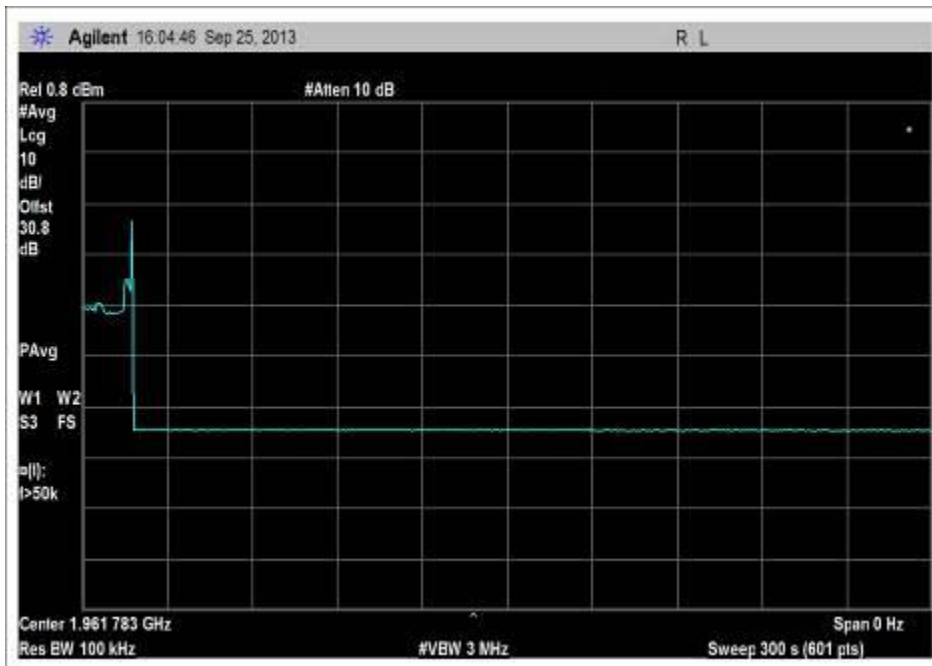

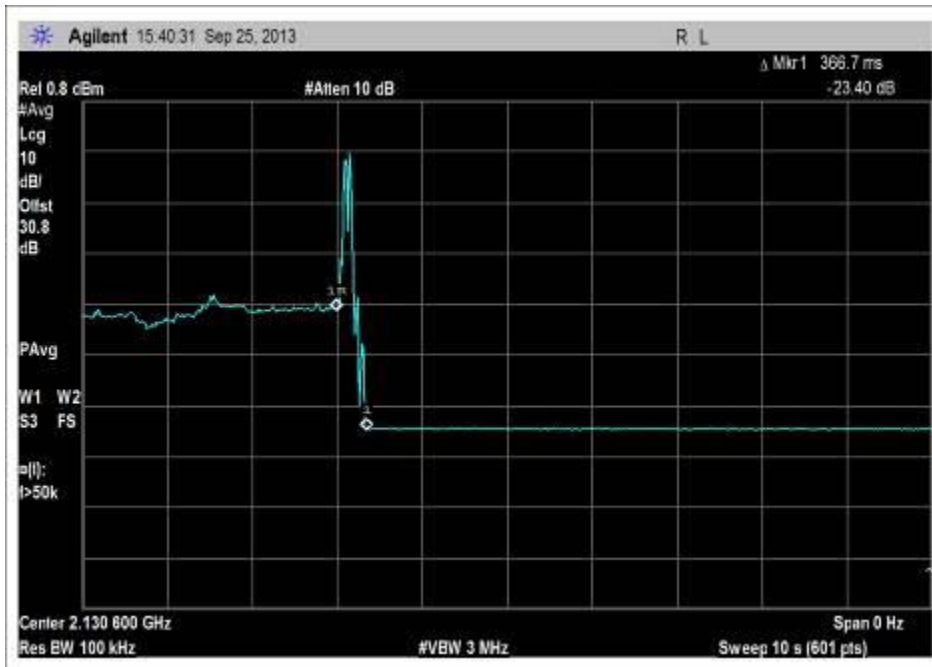

DL 2110-2155MHz .Measure mitigation time = 366ms

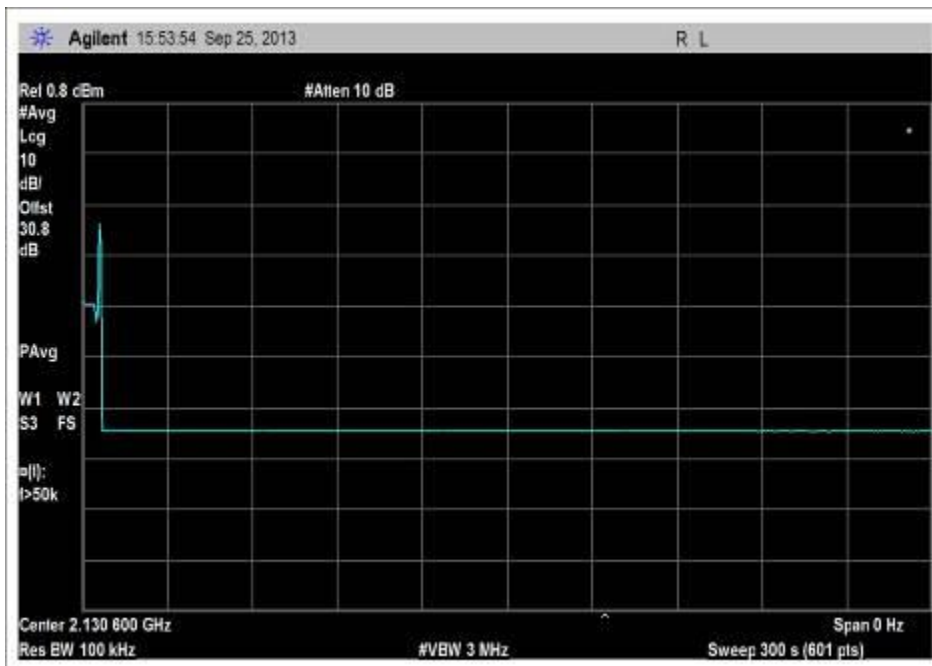

Test Setup Photos

