



TEST REPORT

FCC ID: YEKFMXP-T1

Applicant : DIGIDOCK DEVELOPMENT INC.
Address : 6F, No.151, Xihu 1st Rd., Neihu Dist., Taipei City 11494, Taiwan (R.O.C.)

Equipment under Test (EUT):

Name : Bluetooth FM Transmitter
Model : FMXP-T1
Multi-listing model No.: CF-3XXXFMYYY(XXX=0~9, Y=A~Z)

Standards : FCC Part15.239

Report No. : STE121226832

Date of Test : January 4-8, 2013

Date of Issue : January 9, 2013

Test Result :	PASS *
----------------------	---------------

* In the configuration tested, the EUT complied with the standards specified above

Authorized Signature

(Mark Zhu)
General Manager

The manufacture should ensure that all the products in series production are in conformity with the product sample detailed in this report.

If the product in this report is used in any configuration other than that detailed in the report, the manufacturer must ensure the new system complies with all relevant standards. Any mention of Shenzhen Certification Technology Service Co., Ltd. Or test done by Shenzhen Certification Technology Service Co., Ltd. Approvals in connection with, distribution or use of the product described in this report must be approved by Shenzhen Certification Technology Service Co., Ltd. Approvals in writing.

TABLE OF CONTENT

Description	Page
1 General Information -----	3
1.1 Description of Device (EUT)-----	3
1.2 Description of Test Facility -----	4
2 Test Equipment List -----	4
3 Test Procedure-----	5
4 Summary of Measurement-----	6
5 POWER LINE CONDUCTED EMISSION -----	7
5.1 Conducted Emission Limits(15.209&249)-----	7
5.3 Test Setup -----	7
5.3 Test Procedure -----	8
5.4 Test Resluts -----	8
6 Radiated Emission Test -----	9
6.1 Radiated Emission Limits(15.209&239)-----	9
6.2 Test Setup for Emission measurement -----	10
6.3 Test Procedure-----	11
6.4 Test Condition -----	12
7 Bandwidth Test-----	18
7.1 Limit for Bandwidth -----	18
7.2 Method of measurement-----	18
7.3 Test Setup -----	18
7.4 Test Results -----	18
8 Band Edge Test-----	20
8.1 Test Limit-----	20
8.2 Test Procedure -----	20
8.3 Test Results -----	20
9 Antenna Requirement -----	22
9.1 Standard requirement -----	22
9.2 Result -----	22
10 Photographs of Test Setup -----	23
11 Photographs of EUT-----	24

1 General Information

1.1 Description of Device (EUT)

Trade Name : N/A

EUT : Bluetooth FM Transmitter

Model No. : FMXP-T1
: Multi-listing model No.: CF-3XXXFMYYY(XXX=0~9, Y=A~Z)
DIFF. : Only different in appearance, the other the same.
The test model: FMXP-T1.

Type of Antenna : PCB antenna, Gain: 0dBi

Operation Frequency : 88.3-88.9MHz

Channel number : 4

Modulation type : FM

Power Supply : DC 12/24V Supply by battery

Rated RF output Power : 61.98 dBuV(PK detector)

Applicant : DIGIDOCK DEVELOPMENT INC.
Address : 6F, No.151, Xinhua 1st Rd., Neihu Dist., Taipei City 11494,
Taiwan (R.O.C.)

Manufacturer : DIGIDOCK DEVELOPMENT INC.
Address : 6F, No.151, Xinhua 1st Rd., Neihu Dist., Taipei City 11494,
Taiwan (R.O.C.)

1.2 Description of Test Facility

Shenzhen Certification Technology Service Co., Ltd.
 2F, Building B, East Area of Nanchang Second Industrial Zone,
 Gushu 2nd Road, Bao'an District, Shenzhen 518126, P.R. China
 FCC Registered No.: 197647

2 Test Equipment List

Equipment	Manufacture	Model No.	Serial No.	Last cal.	Cal Interval
3m Semi-Anechoic	ETS-LINDGRE N	N/A	SEL0017	06/06/2012	1Year
Spectrum analyzer	Agilent	E4443A	MY46185649	06/06/2012	1Year
Receiver	R&S	ESCI	100492	04/06/2012	1Year
Receiver	R&S	ESCI	101202	07/01/2012	1Year
Bilog Antenna	Sunol	JB3	A121206	04/06/2012	1Year
L.I.S.N.	R&S	ESH3-Z5	100305	16/06/2012	1Year
Horn Antenna	EMCO	3115	640201028-0 6	04/06/2012	1Year
Power Meter	Anritsu	ML2487A	6K00001491	23/02/2012	1Year
ETS Horn Antenna	ETS	3160	SEL0076	12/08/2012	1Year
Active Loop Antenna	Beijing Daze	ZN30900A	SEL0097	15/06/2012	1Year
Cable	Resenberger	N/A	No.1	04/06/2012	1Year
Cable	SCHWARZBEC K	N/A	No.2	04/06/2012	1Year
Cable	SCHWARZBEC K	N/A	No.3	04/06/2012	1Year
Pre-amplifier	R&S	AFS42-00101 800-25-S-42	SEL0081	06/06/2012	1Year
Pre-amplifier	R&S	AFS33-180026 50-30-8P-44	SEL0080	06/06/2012	1Year

3 Test Procedure

POWER LINE CONDUCTED INTERFERENCE: The test procedure used was ANSI Standard C63.4-2003 using a 50 u H LISN. Both Lines were observed. The bandwidth of the receiver was 10kHz with an appropriate sweep speed. The ambient temperature of the EUT was 25°C with a humidity of 58%.

RADIATION INTERFERENCE: The test procedure used was ANSI Standard C63.4-2003 using a ANRITSU spectrum analyzer with a pre-selector. The analyzer was calibrated in dB above a micro volt at the output of the antenna. The resolution bandwidth was 100kHz and the video bandwidth was 300 kHz up to 1 GHz and 1 MHz with a video BW of 3MHz above 1 GHz. The ambient temperature of the EUT was 25°C with a humidity of 58%.

FORMULA OF CONVERSION FACTORS: The Field Strength at 3m was established by adding the meter reading of the spectrum analyzer (which is set to read in units of dBuV) to the antenna correction factor supplied by the antenna manufacturer and cable loss. The antenna correction factors and cable loss are stated in terms of dB. The gain of the Pre-selector was accounted for in the Spectrum Analyzer Meter Reading.

Example:

Freq (MHz) METER READING + ACF + CABLE = FS

33.20 dBuV + 10.36 dB + 0.9 dB= 44.46 dBuV/m @ 3m

ANSI STANDARD C63.4-2003 10.1.7 MEASUREMENT PROCEDURES: The EUT was placed on a table 80 cm high and with dimensions of 1m by 1.5m. The EUT was placed in the center of the table (1.5m side). The table used for radiated measurements is capable of continuous rotation. When an emission was found, the table was rotated to produce the maximum signal strength. At this point, the antenna was raised and lowered from 1m to 4m. The antenna was placed in both the horizontal and vertical planes. The situation was similar for the conducted measurement except that the table did not rotate. The EUT was setup as described in ANSI Standard C63.4-2003 10.1.7 with the EUT 40 cm from the vertical ground wall.

4 Summary of Measurement

Test Item	Test Requirement	Standard Paragraph	Result
Antenna Requirement	FCC PART15	15.203	Compliance
Conducted Emission	FCC PART15	15.207	Compliance
Radiation Emission	FCC PART15	15.209&15.239	Compliance
Bandwidth Requirement	FCC PART15	15.239	Compliance
Band edge Requirement	FCC PART15	15.239	Compliance

Note: The EUT has been tested as an independent unit. And Continual transmitting in maximum power (The new battery be used during Test).

The EUT has been tested on under the worst case test mode, has tested the modulation mode.

5 POWER LINE CONDUCTED EMISSION

5.1 Conducted Emission Limits(15.209&249)

Frequency MHz	Limits dB(μ V)	
	Quasi-peak Level	Average Level
0.15 -0.50	66 -56*	56 - 46*
0.50 -5.00	56	46
5.00 -30.00	60	50

Notes: 1. *Decreasing linearly with logarithm of frequency.

2. The lower limit shall apply at the transition frequencies.

3. The limit decreases in line with the logarithm of the frequency in the rang of 0.15 to 0.50 MHz.

5.3 Test Setup

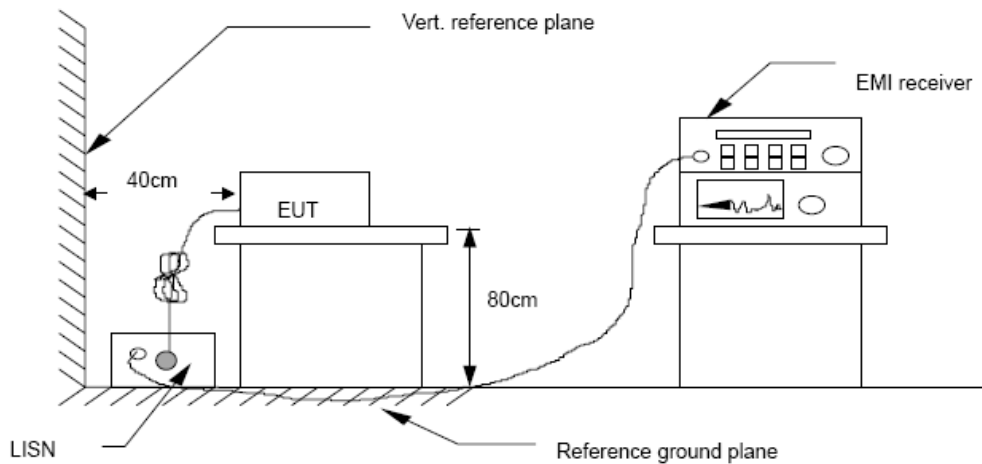

5.3 Test Procedure

The EUT is put on the plane 0.8m high above the ground by insulating support and is connected to the power mains through a line impedance stabilization network (L.I.S.N.). This provides a 50ohm coupling impedance for the EUT system. Please refer the block diagram of the test setup and photographs. Both sides of AC lines are checked to find out the maximum conducted emission. In order to find the maximum emission levels, the relative positions of equipment and all of the interface cables shall be changed according to ANSI C63.4-2003 on Conducted Emission Measurement.

The bandwidth of test receiver (R & S ESCS30) is set at 9 kHz.

5.4 Test Result

EUT Supply by DC power, so this test is not applicable.

6 Radiated Emission Test

6.1 Radiated Emission Limits(15.209&239)

Frequency (MHZ)	Field Strength Limits at 3 metres (watts,e.i.r.p.)		
	uV/m	dB uV/m	Measurement distance(m)
0.009-0.490	2400/F(kHz)	XX	300
0.490-1.705	24000/F(kHz)	XX	30
1.705-30	30	29.5	30
30~88	100(3nW)	40	3
88~216	150(6.8nW)	43.5	3
216~960	200(12nW)	46	3
Above960	500(75nW)	54	3
Carrier frequency	250	48(AV)	3
Carrier frequency		68(PK)	3

NOTE:

- a) The tighter limit applies at the band edges.
- b) Emission Level(dB uV/m)=20log Emission Level(uV/m)
- c) XX means the limit is unsure

6.2 Test Setup for Emission measurement

Test Setup for Emission Below 30MHz

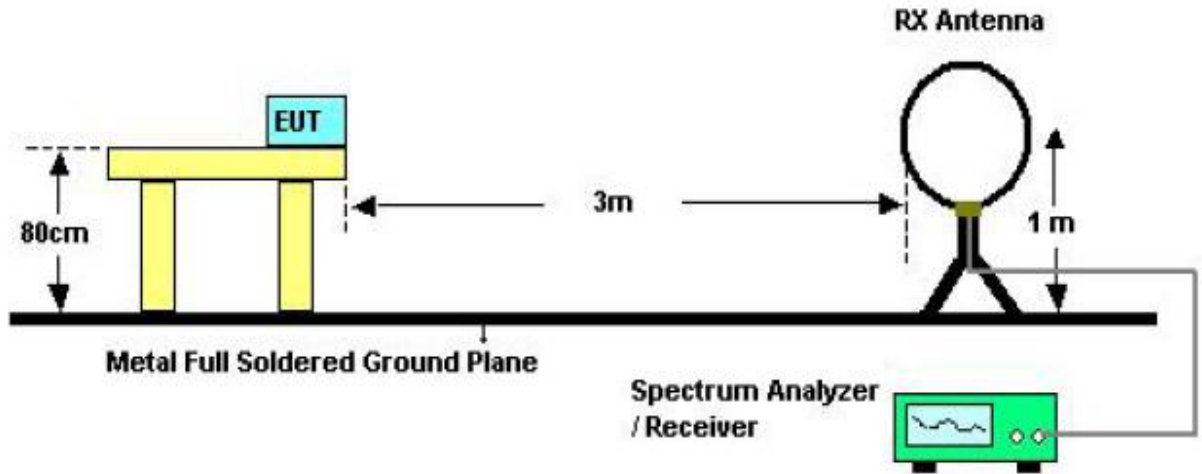

Test Setup for Emission above 30MHz

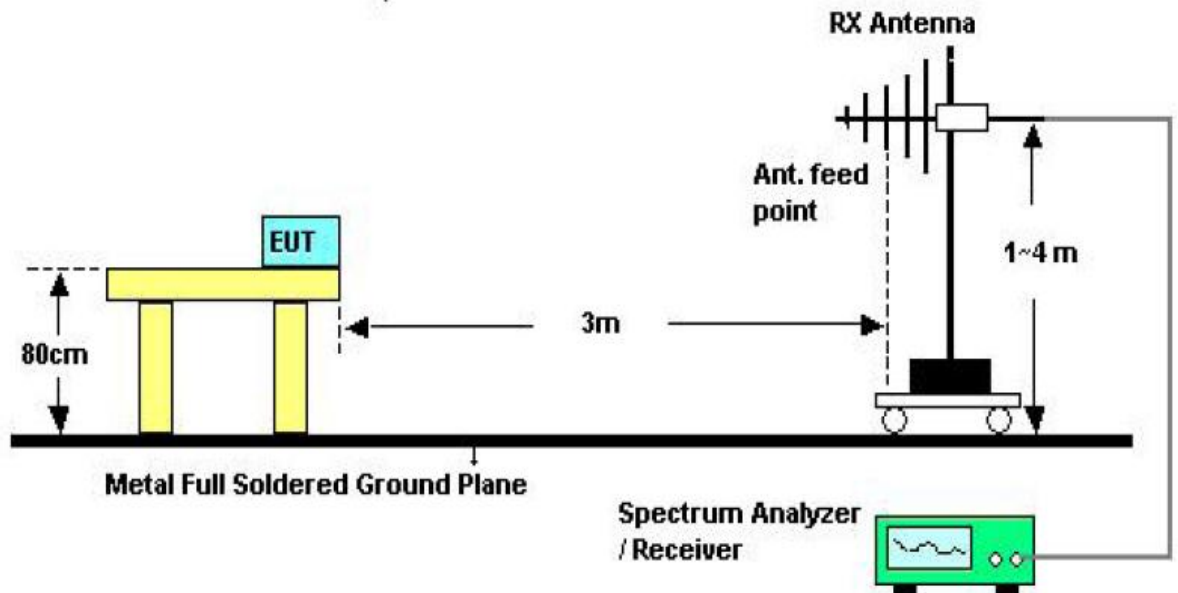

Test Setup for Emission above 1GHz

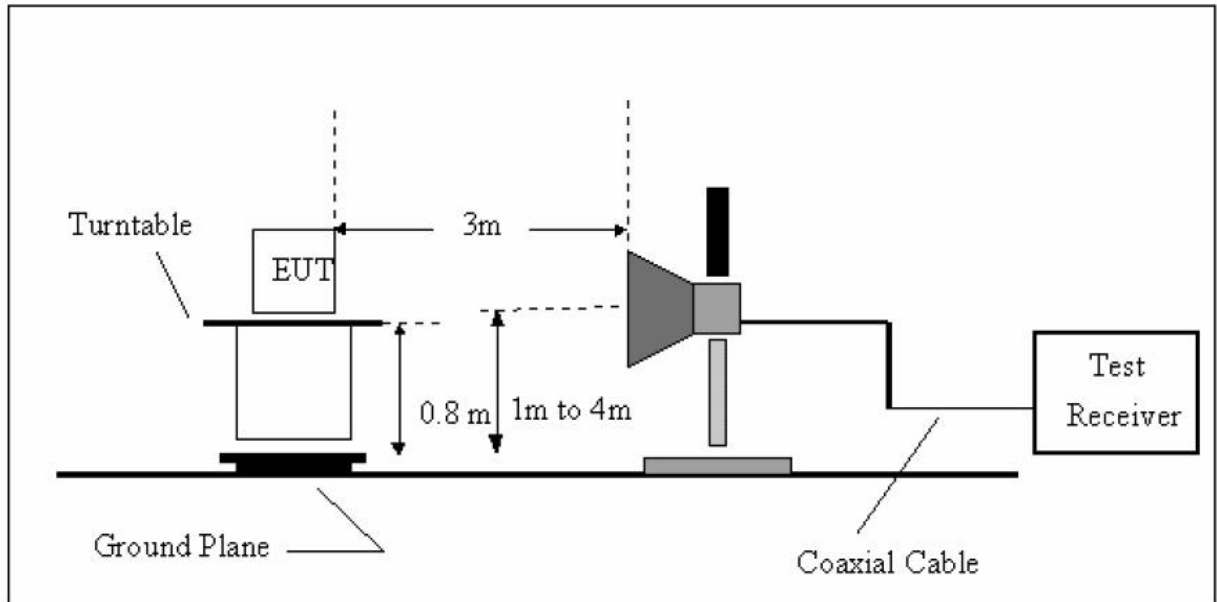

6.3 Test Procedure

- a) The measuring distance of 3m shall be used for measurements at frequency up to 1GHz and above 1 GHz, The EUT was placed on a rotating 0.8 m high above ground. The table was rotated 360 degrees to determine the position of the highest radiation
- b) The Test antenna shall vary between 1m and 4m. Both Horizontal and Vertical antenna are set to make measurement.
- c) The initial step in collecting conducted emission data is a spectrum analyzer Peak detector mode pre-scanning the measurement frequency range. Significant Peaks are then marked and then Qusia Peak Detector mode premeasured
- d) If Peak value comply with QP limit Below 1GHz. The EUT deemed to comply with QP limit. But the Peak value and average value both need to comply with applicable limit above 1GHz.
- e) Repeated step a and d test with EUT in X, Y, Z position, and the maximum emissions data were recorded when EUT in X position as the test photo indicated.
- f) For the actual test configuration, please see the test setup photo.

g) Test Equipment Setting For emission test:

30MHZ~1GHz:

RBW 120KHz VBW 300KHz

Above 1GHz :

RBW 1MHz VBW 3MHz for Peak value

RBW 1MHz VBW 10Hz for Average Value

6.4 Test Condition

A continuously playing MP3 audio source (Ipod, Brand: Apple, Model: A1238, S/N: 2Z8181UQYMV) was connected during the test. The volume of the audio source was set to maximum to represent the worst case. The transmitter was transmitting continuously.

We have scanned up the 10th harmonics about the EUT.

From 9KHz to 30MHz: Conclusion: PASS

6.5 Test Results

Radiated Emissions Result of Outside the band (88.3-88.9MHz)

EUT	Bluetooth FM Transmitter	Model Name	FMXP-T1
Temperature	26°C	Relative Humidity	58%
Pressure	960hPa	Test voltage	DC 12V Supply by battery
Test Mode	TX	TX frequency	88.3MHz

Antenna polarization: Vertical								
Frequency	Reading	Cable Loss	Antenna Factor	Amplifier	Correct Factor	Measurement Result	Limit line	Over
MHz	dBuV	dB	dB	Gain	dB	dBuV/m	dBuV/m	Margin
42.96	43.79	0.57	14.09	29.79	-15.13	28.66	40.00	-11.34
177.44	40.37	1.15	13.92	28.89	-13.82	26.55	43.50	-16.95
266.68	46.58	2.22	13.85	29.32	-13.25	33.33	46.00	-12.67
355.92	41.46	2.64	15.64	29.45	-11.17	30.29	46.00	-15.71
445.16	46.76	3.02	16.63	29.67	-10.02	36.74	46.00	-9.26
622.67	39.99	3.17	18.19	29.82	-8.46	31.53	46.00	-14.47
--	--	--	--	--	--	--	--	--

Antenna polarization: Horizontal								
Frequency	Reading	Cable Loss	Antenna Factor	Amplifier	Correct Factor	Measurement Result	Limit line	Over
MHz	dBuV	dB	dB	Gain	Db	dBuV/m	dBuV/m	Margin
92.46	46.23	1.07	13.24	28.75	-14.44	31.79	43.50	-11.71
177.44	43.19	2.86	16.11	29.62	-10.65	32.54	46.00	-13.46
266.68	42.79	3.14	18.24	29.87	-8.49	34.30	46.00	-11.70
355.92	40.77	3.21	19.65	29.63	-6.77	34.00	46.00	-12.00
445.16	44.62	3.01	20.63	29.72	-6.08	38.54	46.00	-7.46
622.67	40.08	3.82	21.85	29.66	-3.99	36.09	46.00	-9.91
--	--	--	--	--	--	--	--	--

EUT	Bluetooth FM Transmitter	Model Name	FMXP-T1
Temperature	26°C	Relative Humidity	58%
Pressure	960hPa	Test voltage	DC 12V Supply by battery
Test Mode	TX(iPod)	TX frequency	88.5MHz

Antenna polarization: Vertical								
Frequency MHz	Reading dBuV	Cable Loss dB	Antenna Factor dB	Amplifier Gain	Correct Factor dB	Measurement Result dBuV/m	Limit line dBuV/m	Over Margin
59.65	43.22	0.56	14.09	29.82	-15.17	28.05	40.00	-11.95
176.47	40.97	1.16	13.92	28.94	-13.86	27.11	43.50	-16.39
264.76	39.46	2.24	13.85	29.27	-13.18	26.28	46.00	-19.72
353.98	45.75	2.69	15.66	29.46	-11.11	34.64	46.00	-11.36
619.76	42.37	3.04	16.62	29.67	-10.01	32.36	46.00	-13.64
797.27	38.55	3.12	18.11	29.83	-8.6	29.95	46.00	-16.05
--	--	--	--	--	--	--	--	--

Antenna polarization: Horizontal								
Frequency MHz	Reading dBuV	Cable Loss dB	Antenna Factor dB	Amplifier Gain	Correct Factor Db	Measurement Result dBuV/m	Limit line dBuV/m	Over Margin
130.88	42.33	1.04	13.27	28.91	-14.6	27.73	43.50	-15.77
176.47	43.51	2.82	16.05	29.57	-10.7	32.81	46.00	-13.19
265.71	45.82	3.17	18.27	29.83	-8.39	37.43	46.00	-8.57
443.22	44.79	3.43	19.64	29.72	-6.65	38.14	46.00	-7.86
619.76	41.58	3.58	20.65	29.60	-5.37	36.21	46.00	-9.79
797.27	39.76	3.84	21.98	29.68	-3.86	35.90	46.00	-10.10
--	--	--	--	--	--	--	--	--

EUT	Bluetooth FM Transmitter	Model Name	FMXP-T1
Temperature	26°C	Relative Humidity	58%
Pressure	960hPa	Test voltage	DC 12V Supply by battery
Test Mode	TX(iPod)	TX frequency	88.9MHz

Antenna polarization: Vertical								
Frequency MHz	Reading dBuV	Cable Loss dB	Antenna Factor dB	Amplifier Gain	Correct Factor dB	Measurement Result dBuV/m	Limit line dBuV/m	Over Margin
44.55	46.39	0.55	14.07	29.81	-15.19	31.20	40.00	-8.80
177.44	42.48	1.12	13.90	28.90	-13.88	28.60	43.50	-14.90
266.68	44.53	2.21	13.87	29.28	-13.20	31.33	46.00	-14.67
445.16	41.72	2.67	15.68	29.47	-11.12	30.60	46.00	-15.40
622.67	45.19	3.01	16.65	29.63	-9.97	35.22	46.00	-10.78
758.23	40.18	3.18	18.16	29.80	-8.46	31.72	46.00	-14.28
--	--	--	--	--	--	--	--	--

Antenna polarization: Horizontal								
Frequency MHz	Reading dBuV	Cable Loss dB	Antenna Factor dB	Amplifier Gain	Correct Factor Db	Measurement Result dBuV/m	Limit line dBuV/m	Over Margin
107.15	45.43	1.06	13.22	28.90	-14.62	30.81	43.50	-12.69
177.44	42.14	2.80	16.09	29.52	-10.63	31.51	46.00	-14.49
266.68	40.73	3.19	18.28	29.82	-8.35	32.38	46.00	-13.62
445.16	42.40	3.40	19.69	29.75	-6.66	35.74	46.00	-10.26
622.67	40.27	3.59	20.66	29.65	-5.40	34.87	46.00	-11.13
801.15	40.63	3.85	21.97	29.63	-3.81	36.82	46.00	-9.18
--	--	--	--	--	--	--	--	--

Notes: --Means other frequency and mode comply with standard requirements and at least have 20dB margin.

Correct Factor=Cable Loss+Antenna Factor-Amplifier Gain

Measurement Result=Reading + Correct Factor

Margin=Measurement Result-Limit

Radiated Emissions Result of Inside band (88.3~88.9MHz)

EUT	FM Wireless Transmitter	Model Name	FMXP-T1
Temperature	26°C	Relative Humidity	58%
Pressure	960hPa	Test voltage	DC 12V Supply by battery
Test Mode	TX (iPod)	Antenna polarization	Horizontal/Vertical

Channel Low(88.3MHz)									
Fre. MHz	Plority H/V	Reading dBuV	Antenna Factor dB	Cable Loss dB	Amplifier Gain dB	Correct Factor dB	Measure Result dBuV/m	Limit dBuV/m	Margin dB
88.3	H	82.10 (PK)	5.9	0.53	26.55	-20.12	61.98	68.00	-6.02
88.3	H	60.57 (AV)	5.9	0.53	26.55	-20.12	40.45	48.00	-7.55
--	H	--	--	--	--	--	--	--	--
88.3	V	77.7 (PK)	5.9	0.53	26.55	-20.12	57.58	68.00	-10.42
88.3	V	59.16(AV)	5.9	0.53	26.55	-20.12	39.04	48.00	-8.96
--	V	--	--	--	--	--	--	--	--

Channel Middle(88.5MHz)									
Fre. MHz	Plority H/V	Reading dBuV	Antenna Factor dB	Cable Loss dB	Amplifier Gain dB	Correct Factor dB	Measure Result dBuV/m	Limit dBuV/m	Margin dB
88.5	H	77.28 (PK)	5.5	0.51	26.58	-20.57	56.71	68.00	-11.29
88.5	H	59.42 (AV)	5.5	0.51	26.58	-20.57	38.85	48.00	-9.15
--	H	--	--	--	--	--	--	--	--
88.5	V	80.80 (PK)	5.5	0.51	26.58	-20.57	60.23	68.00	-7.77
88.5	V	56.18 (AV)	5.5	0.51	26.58	-20.57	35.61	48.00	-12.39
--	V	--	--	--	--	--	--	--	--

Channel High(88.9MHz)									
Fre. MHz	Plority H/V	Reading dBuV	Antenna Factor dB	Cable Loss dB	Amplifier Gain dB	Correct Factor dB	Measure Result dBuV/m	Limit dBuV/m	Margin dB
88.9	H	72.18 (PK)	5.7	0.56	26.62	-20.36	51.82	68.00	-16.18
88.9	H	56.73 (AV)	5.7	0.56	26.62	-20.36	36.37	48.00	-11.63
--	H	--	--	--	--	--	--	--	--
	H								
88.9	V	76.57 (PK)	5.7	0.56	26.62	-20.36	56.21	68.00	-11.79
88.9	V	54.75 (AV)	5.7	0.56	26.62	-20.36	34.39	48.00	-13.61
--	V	--	--	--	--	--	--	--	--
	V								

Notes: --Means other frequency and mode comply with standard requirements and at least have 20dB margin.
 Correct Factor=Cable Loss+Antenna Factor-Amplifier Gain
 Measurement Result=Reading + Correct Factor
 Margin=Measurement Result-Limit

7 Bandwidth Test

7.1 Limit for Bandwidth

The occupied bandwidth shall not exceed 200 KHz

7.2 Method of measurement

a) The bandwidth is measured at an amplitude level reduced 20dB from the reference level. The reference level is the level of the highest amplitude signal observed from the transmitter at the fundamental frequency. Once the reference level is established, the equipment is conditioned with typical modulating signal to produce the worst-case (i.e. the widest) bandwidth.

b) The test receiver RBW set 10KHz, VBW set 30KHz

7.3 Test Setup

same as section 6.2

7.4 Test Results

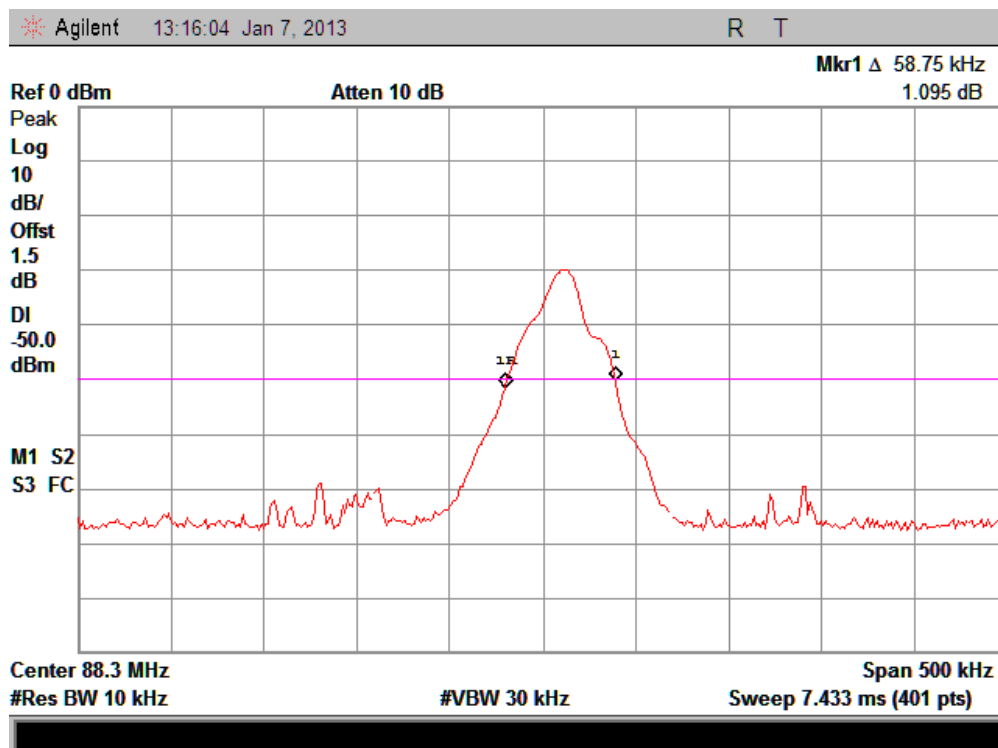

88.3MHz bandwidth test plot

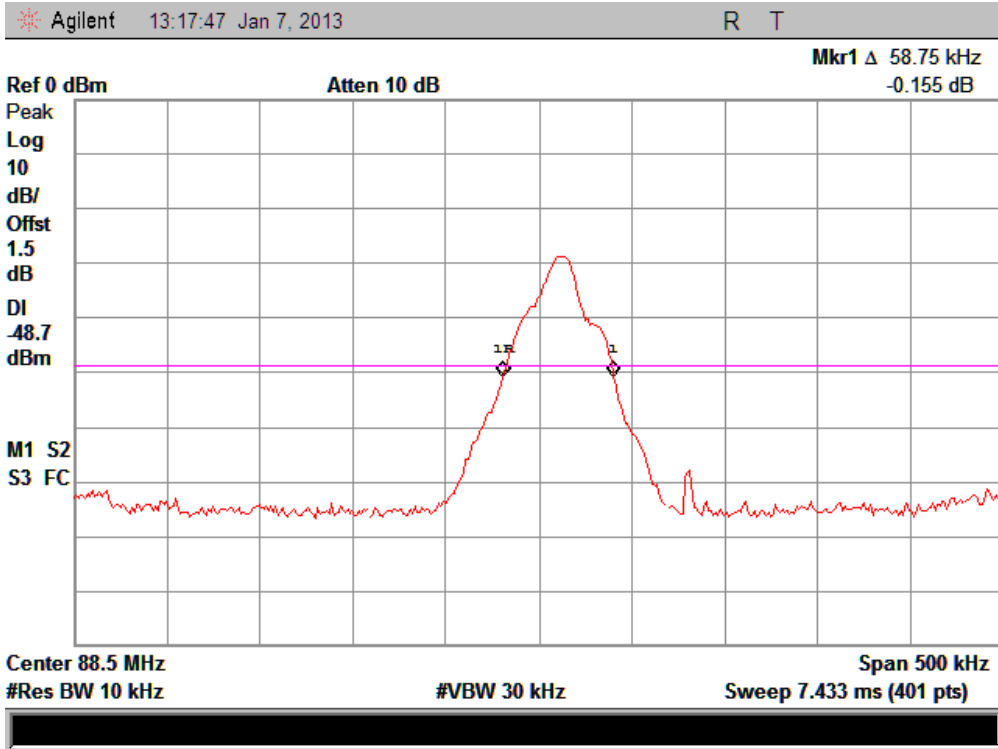

88.5MHz bandwidth test plot

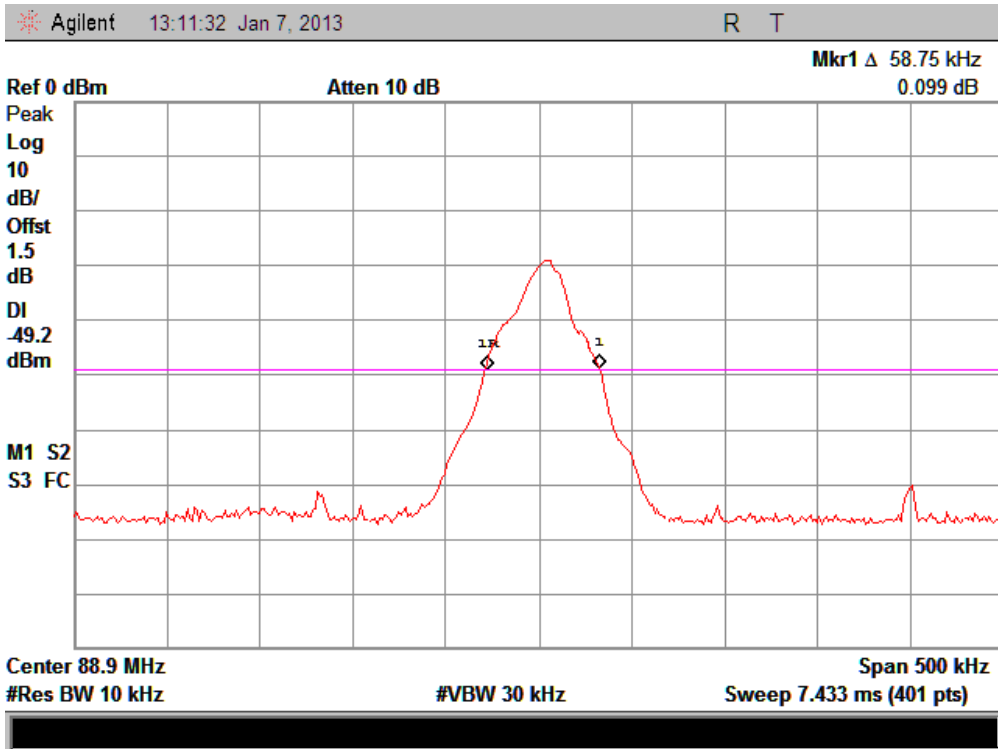

88.9MHz bandwidth test plot

8 Band Edge Test

8.1 Test Limit

Please see the part 15.239a

8.2 Test Procedure

- a) Put the EUT on a 0.8m high table, power on the EUT. Emissions were scanned and measured rotating the EUT to 360 degrees, Find the maximum Emission
- b) Turning to Low and High frequency, then reduced 20dB from the reference level. The reference level is the level of the highest amplitude signal observed from the transmitter at the fundamental frequency.
- c) Check the spurious emissions out of band.
- d) RBW, VBW Setting, please see the following test plot.

8.3 Test Results

Pass

Detailed information, please see the following page.

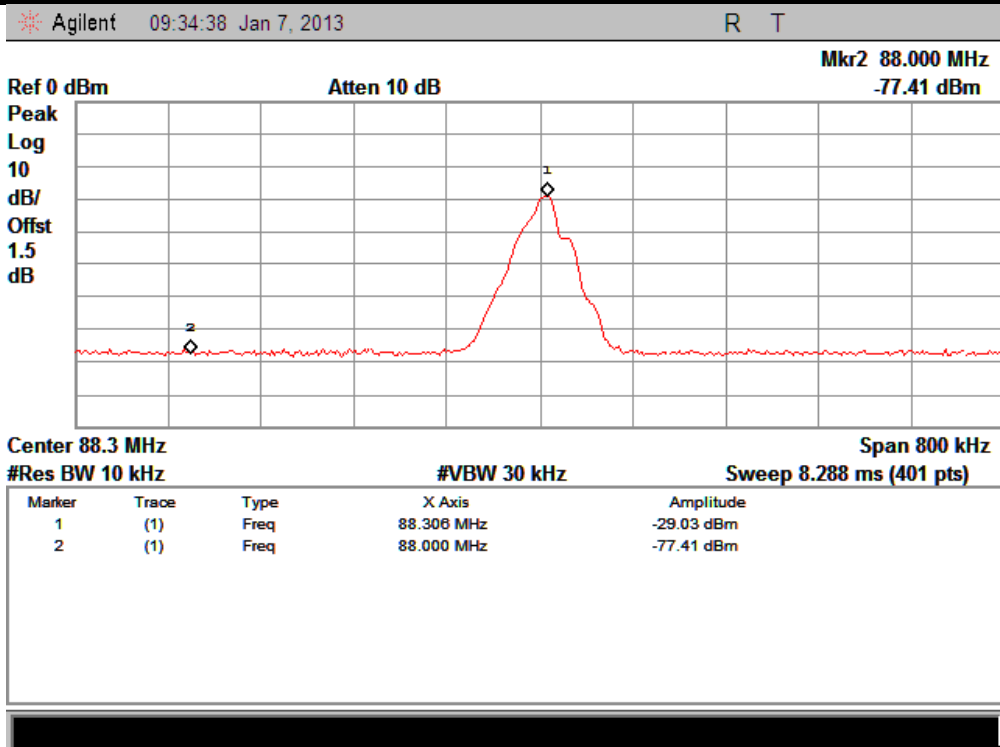

88.3MHz Test Plot

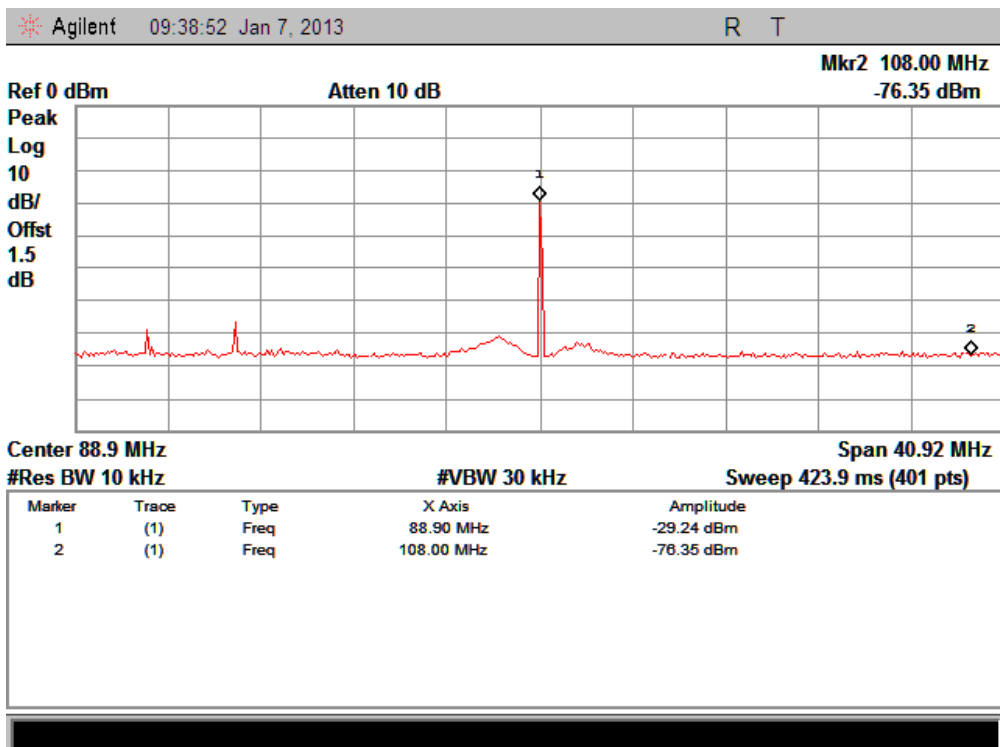

88.9MHz Test Plot

9 Antenna Requirement

9.1 Standard requirement

An intentional radiator shall be designed to ensure that no antenna other than that furnished by the responsible party shall be used with the device. The use of a permanently attached antenna or of an antenna that uses a unique coupling to the intentional radiator shall be considered sufficient to comply with the provisions of this Section. The manufacturer may design the unit so that a broken antenna can be replaced by the user, but the use of a standard antenna jack or electrical connector is prohibited.

9.2 Result

The device is integral antenna, it comply with the standard requirement.

10 Photographs of Test Setup

Photographs-Radiated Emission Test Setup in Chamber

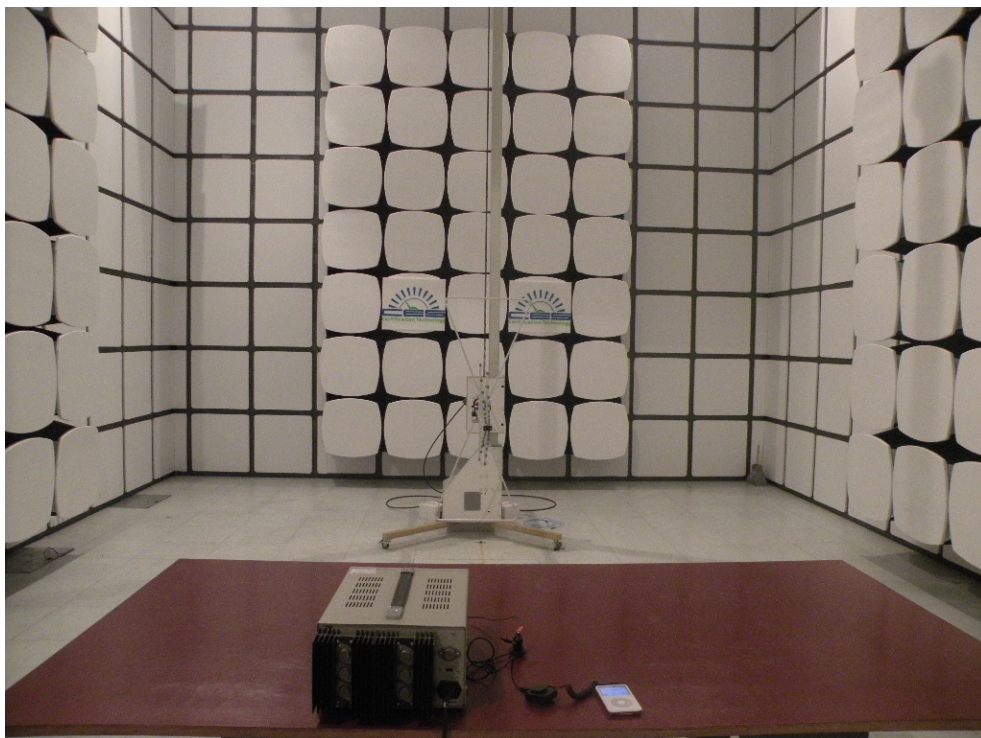
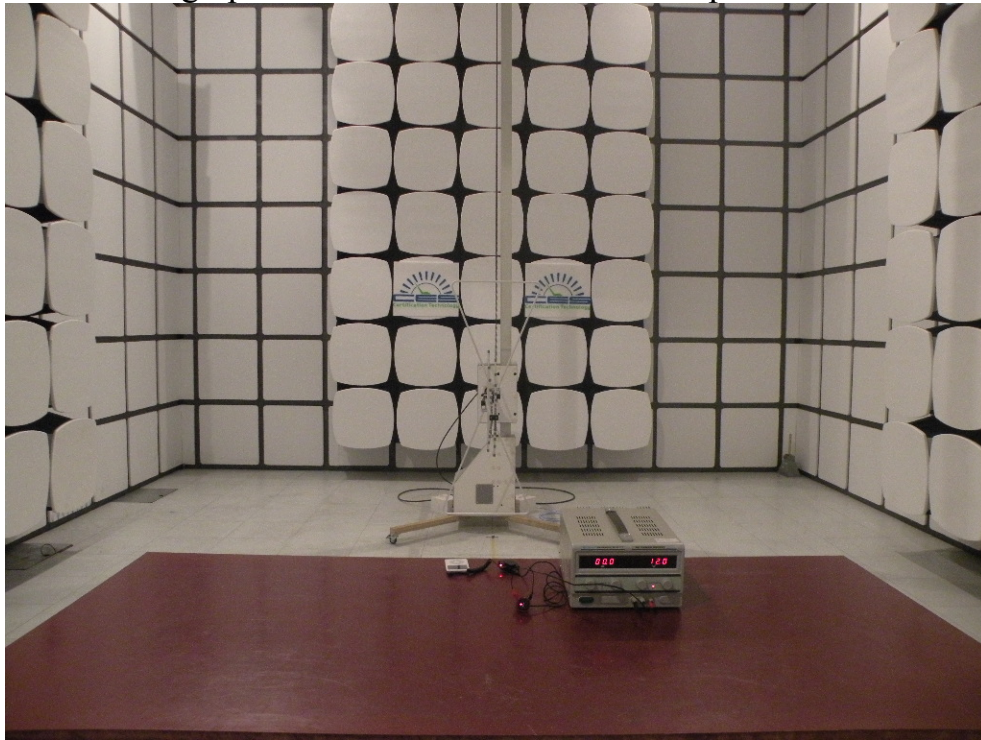

11 Photographs of EUT



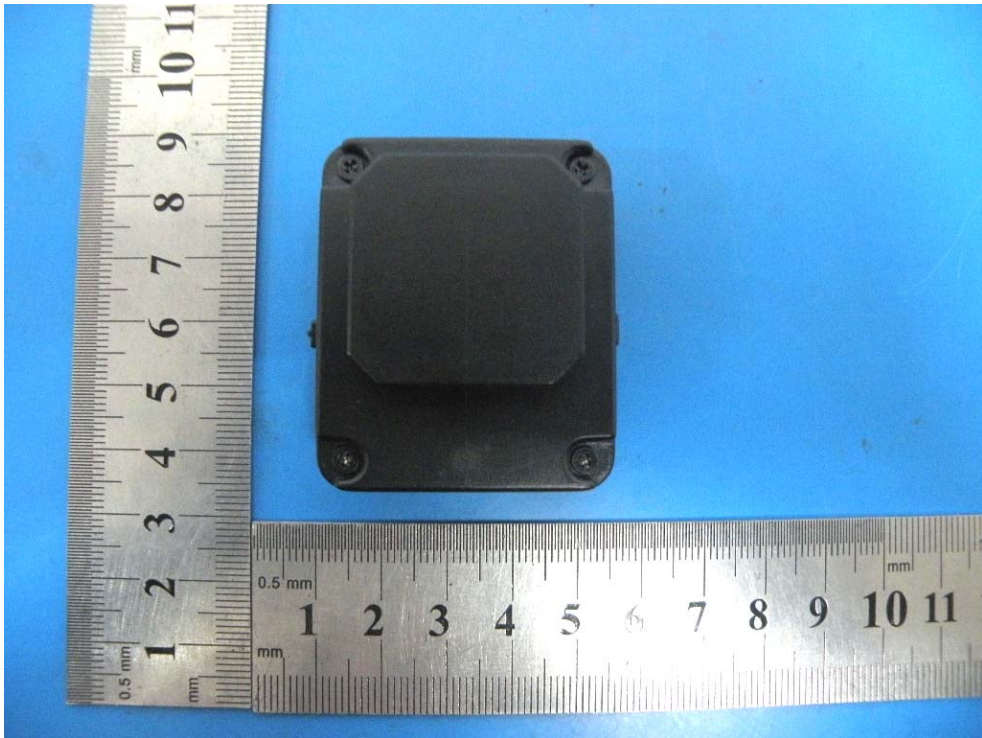





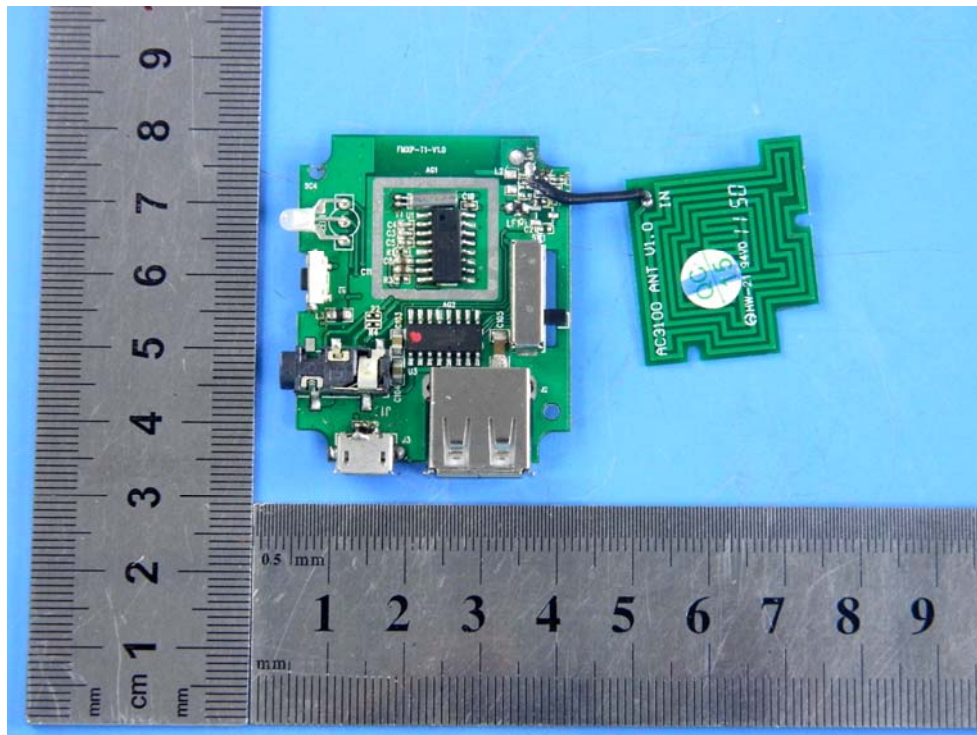
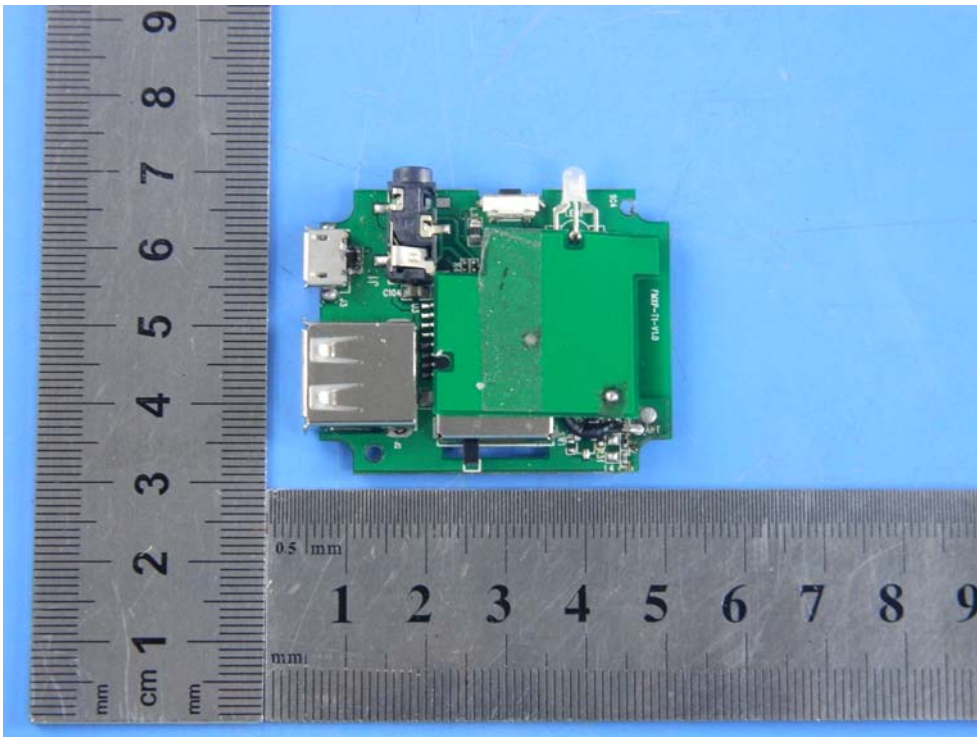

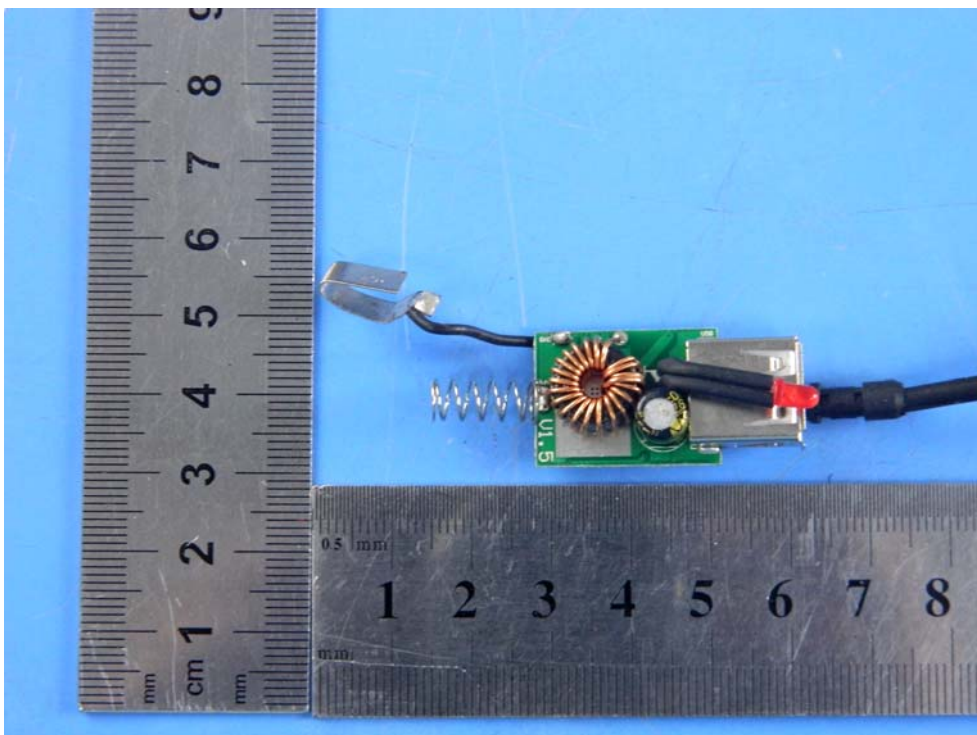
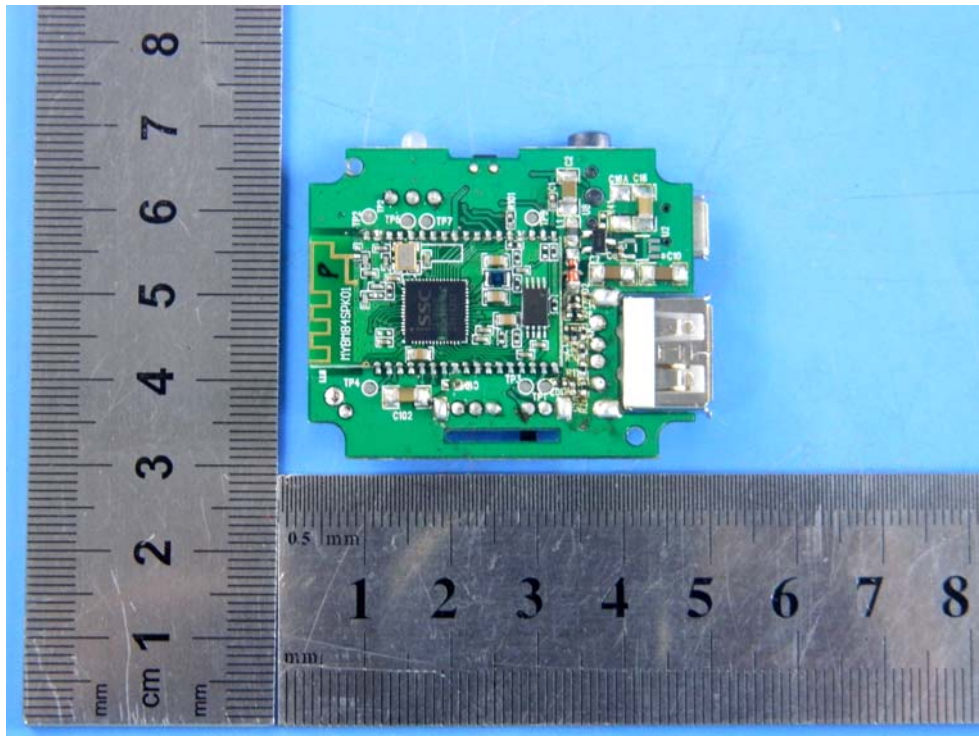

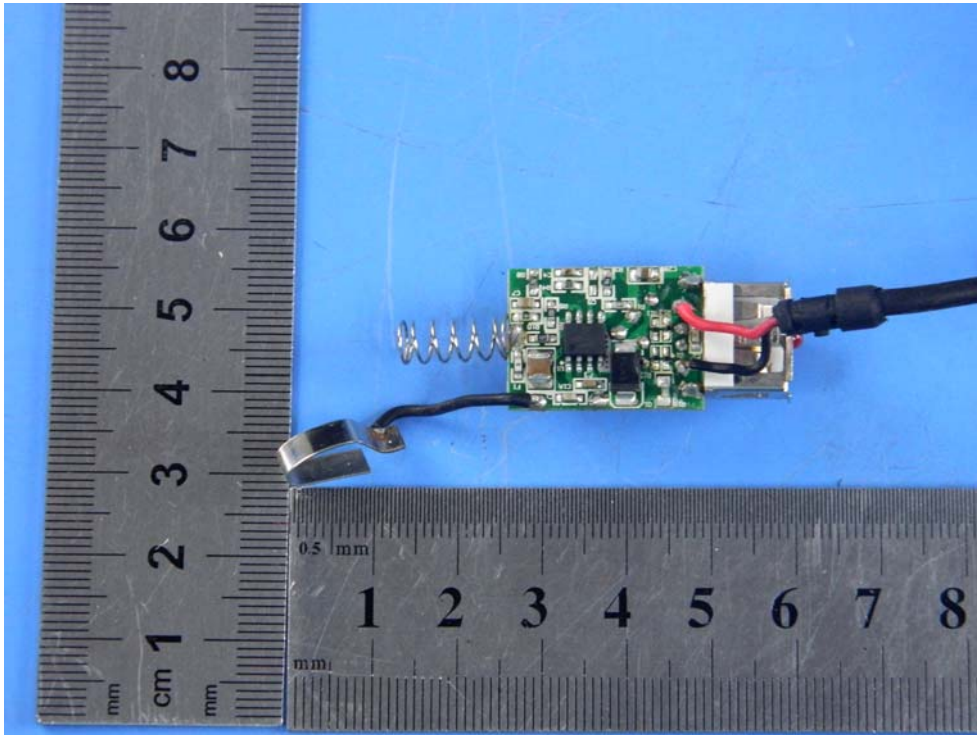

----- THE END OF REPORT-----