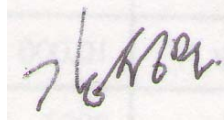
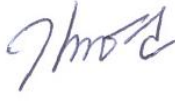

# Approval Sheet

Product	Dielectric Chip Antenna		
Customer	GLOSYS		
Model	CAR AUDIO		
Customer Code			
Supplier	MicroRF Co., LTD.		
Supplier Code	ADSBTM0802-A00		
Customer	Designed by	Checked by	Approved by
MicroRF	Designed by	By checked	By approved
			
	R&D	QC	R&D
	Wongook, Lee	Sunmo, Kang	Seungyun, Kim

2009. 4. 9

MicroRF Co., Ltd.

TEL. 82-2-6406-5590

FAX. 82-2-6406-5591

# SPECIFICATION

Model : ADSBTM0802-A00

## DIELECTRIC CHIP ANTENNA

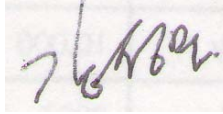
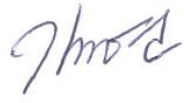
Designed by	Approved by	Approved by
		
R&D	QC	R&D
Wongook, Lee	Sunmo, Kang	Seungyun, Kim
090218	090218	090218

2009. 4. 9

MicroRF Co., Ltd.

TEL. 82-02-6406-5590

FAX. 82-02-6406-5591

# Contents

1. Revision History -----	1
2. Features and Applications -----	2
3. Code No. -----	2
4. Electrical Specifications -----	2
5. Mechanical Dimensions -----	5
6. Measurement Method and Conditions -----	6
7. Environmental Specifications -----	7
8. Environmental Tests and conditions -----	8
9. Recommended Soldering Patterns -----	9
10. Packaging -----	10
11. Usage and Cautions -----	10
12. RoHS Data -----	11

1. Revision History

Product	Dielectric Chip Antenna	Model	Bluetooth headset
		CODE NO.	ADSBTM0802-A00

Rev No.	Date	Name	Page	Item	Revision Issue
1.0	090409	W.G.Lee			Issued

## 2. FEATURES AND APPLICATIONS

This ceramic chip antenna is applied to 2.4 GHz ISM band applications, i.e. wireless LAN, Bluetooth, Zigbee, etc..

## 3. CODE NO.

CODE NO. : ADSBTM0802-A00

CUSTOMER PART NO. :

## 4. ELECTRICAL SPECIFICATIONS

4-1.

- \* All items are measured in room temperature (25°C).
- \* All items are measured at customer set condition.

No.	ITEM	Specification	Typical Data
1	Frequency	2400 ~ 2500 MHz	2400 ~ 2484 MHz
2	VSWR	4.0 max	3.0 Max
3	Total Gain(Peak)	Peak Gain : 0 dBi min	1 dBi
4	Impedance	50 Ω	50 Ω
5	Polarization	Linear	Linear

4-2 VSWR data (S11 of SET condition)

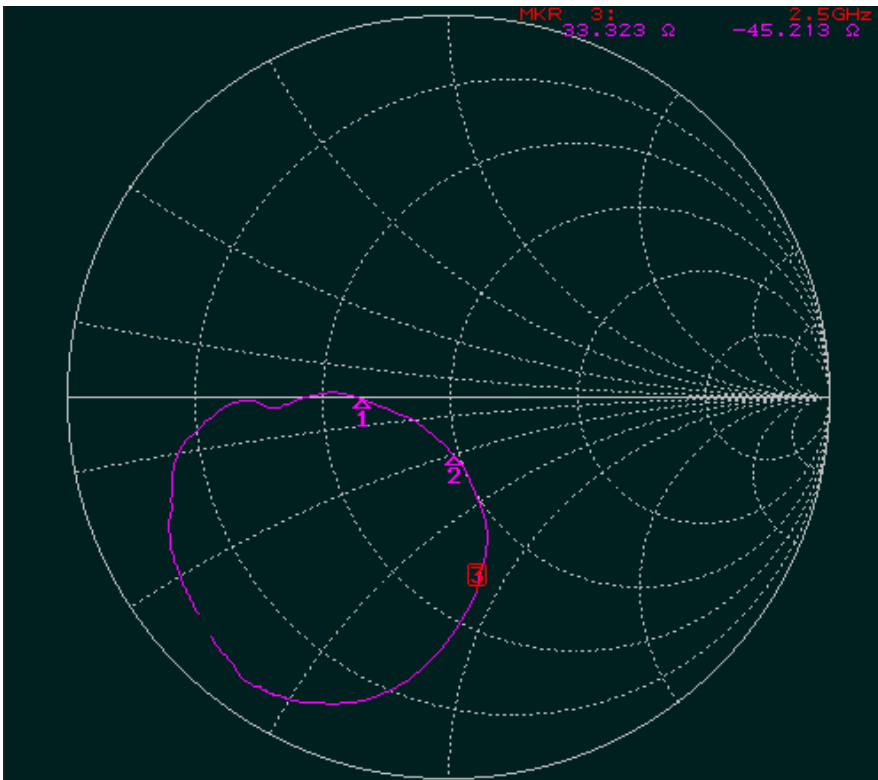
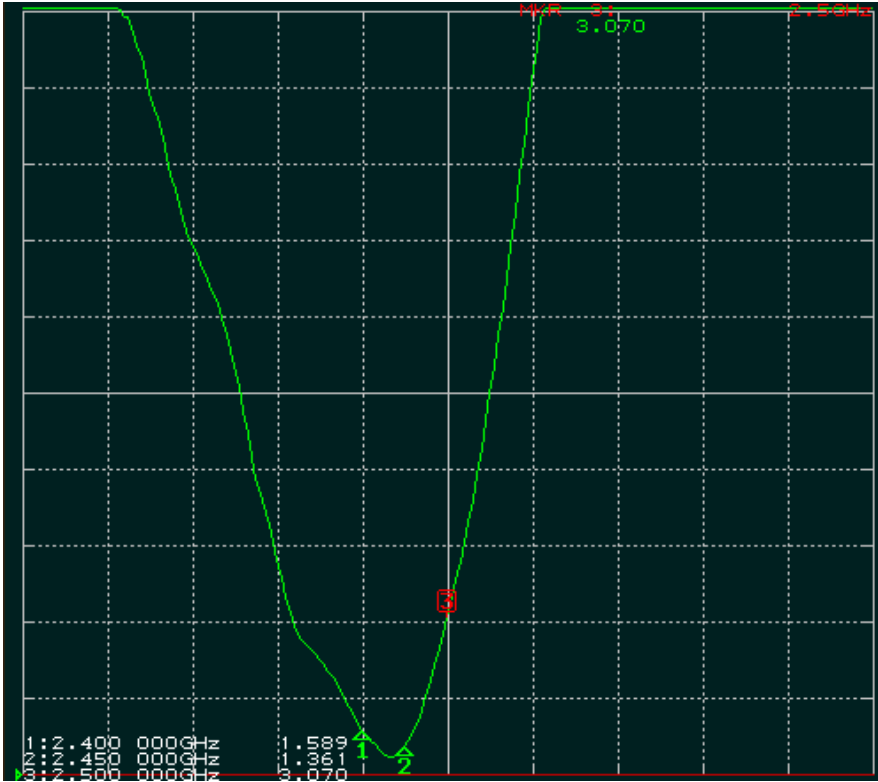

4-3 Radiation Patterns

Peak Value(Beam Peak :dBi)

	Azimuth Plane	Elevation 1	Elevation 2
2.4 GHz	0.976	2.920	3.438
2.45 GHz	0.592	1.894	2.912
2.5 GHz	-2.444	-0.998	0.299

(a) Azimuth Plane (XY) – Horizontal Polarization

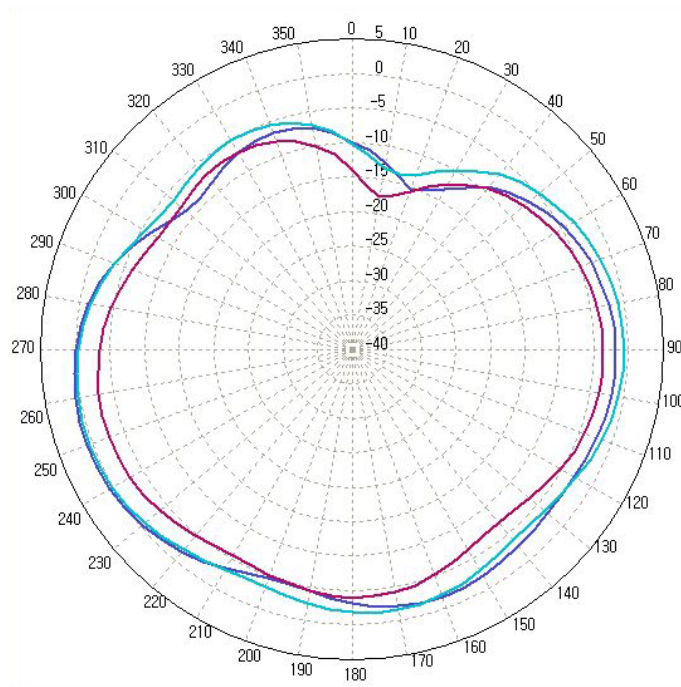

(b) Elevation1 Plane (ZX) – Vertical Polarization

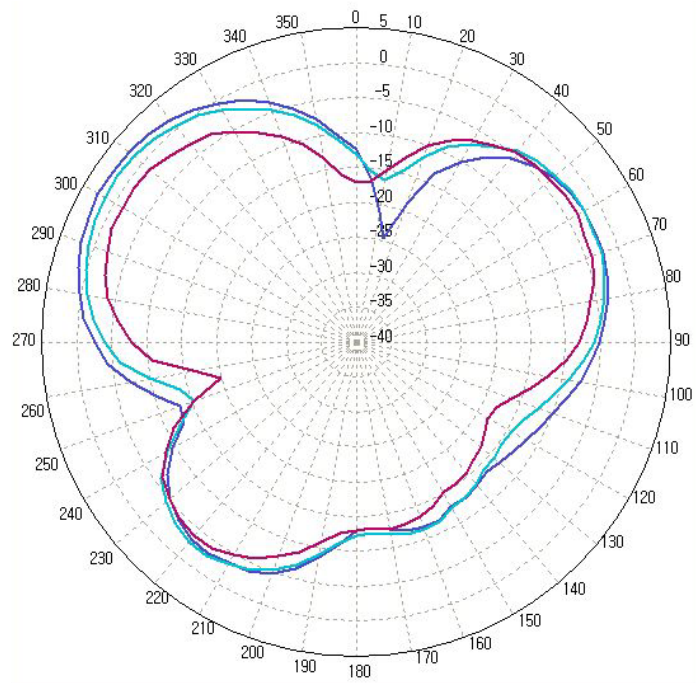

(c) Elevation2 Plane (YZ) – Vertical Polarization

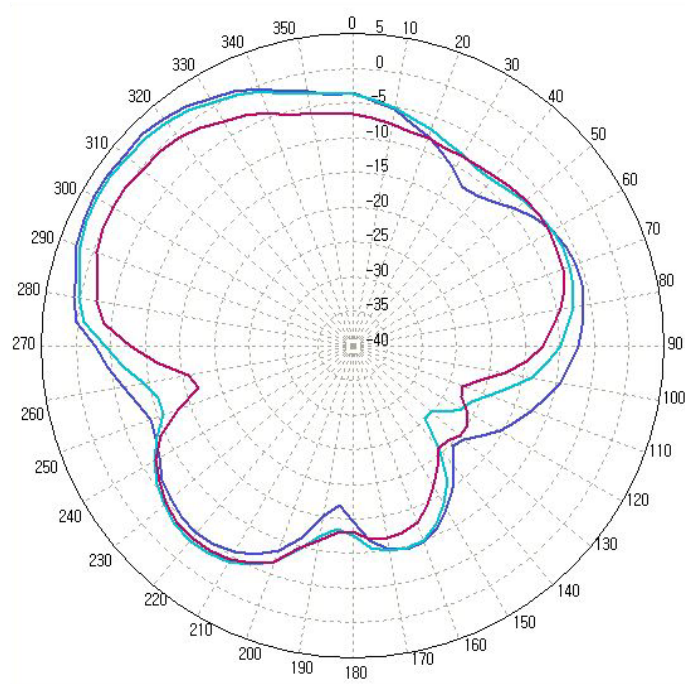



5. MECHANICAL DIMENSIONS

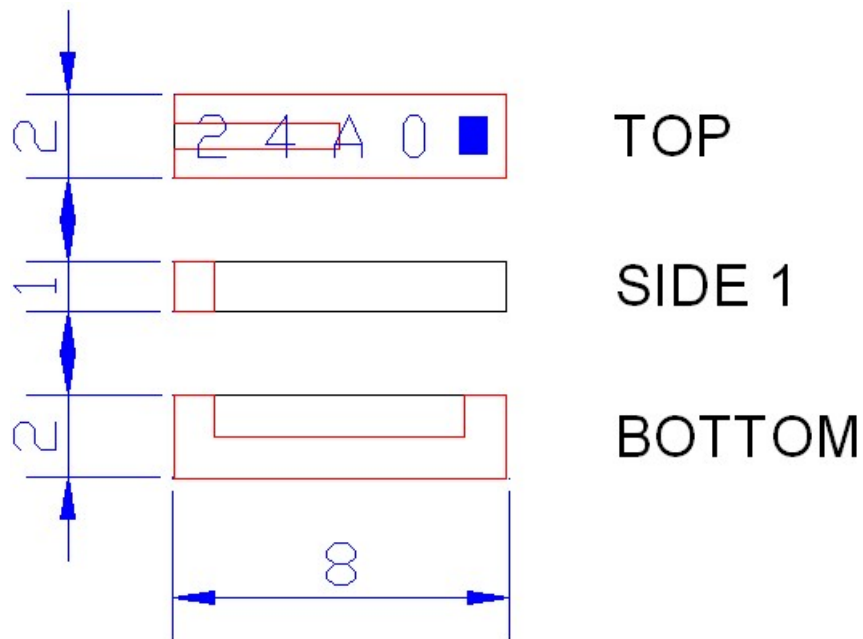

6. Measurement Method and Conditions

The measurement of antenna performance is measurement of gain, radiation pattern using ORBIT/FR apparatus in Anechoic chamber and measurement of VSWR using Network analyzer.

6-1. The measurement of Frequency and VSWR

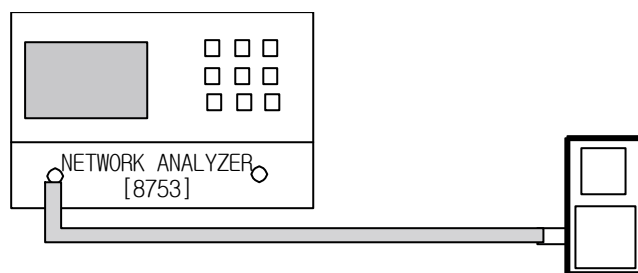

<Measurement Method>

- 1) As seen the above, network analyzer is set up for S11 measurement.
- 2) The measurement frequency range is to set up from 2 GHz to 3 GHz.
- 3) Perform S11 one port full calibration.
- 4) Measure the VSRW of three points of Bluetooth frequency range such as 2400 MHz, 2450 MHz, and 2500 MHz.

6-2. The measurement of Gain and Radiation Patterns

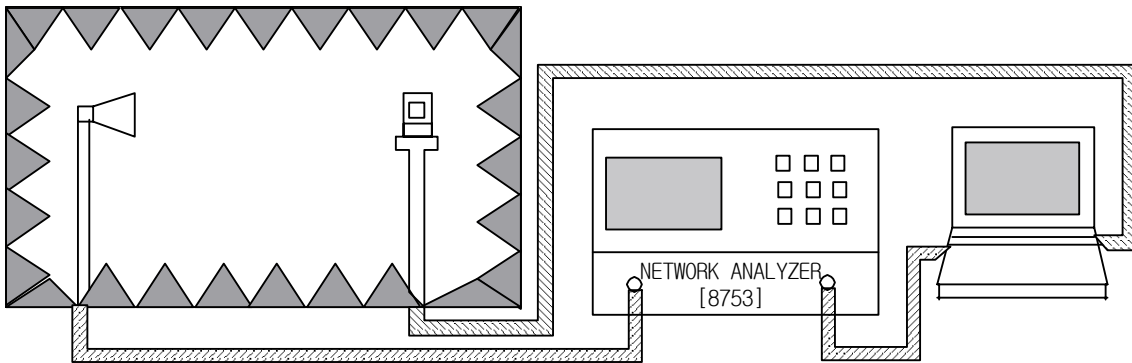

<Measurement Method>

- 1) As seen the above, network analyzer is to set up in Anechoic chamber.
- 2) As seen the beneath, for the measurement planes as Azimuth, Elevation1, and Elevation2, measure Gain data of vertical polarization and horizontal polarization for each plane.

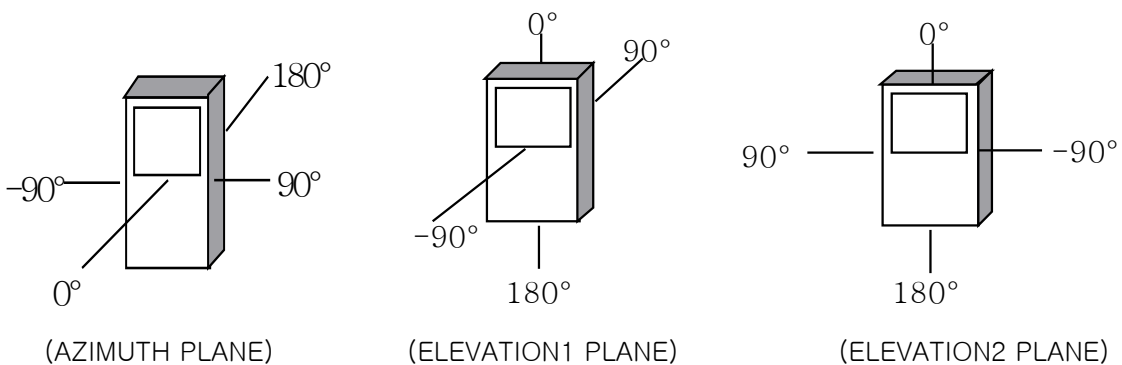

7. ENVIRONMENTAL SPECIFICATIONS

No.	Items	Specifications
1	Material	Pb-free system
2	Operating Temperature Range	-30 ~ +85 °C
3	Operating Humidity Range	45 ~ 85 % RH

## 8. ENVIRONMENTAL TESTS

No.	Item	Test Conditions
1	High Temperature Storage	Leave for $72 \pm 2$ hours in a test bath retaining $85 \pm 2^\circ\text{C}$ . After then, leave on the test conditions for 1.5 hours.
2	Low Temperature Storage	Leave for $72 \pm 2$ hours in a test bath retaining $-30 \pm 2^\circ\text{C}$ . After then, leave on the test condition for 1.5 hours.
3	Static Humidity	Leave for $24 \pm 2$ hours in a test bath retaining 90~95% RH / $50 \pm 3^\circ\text{C}$ . After then, leave in the test condition for 1.5 hours.
4	Thermal Shock	Cool from $25^\circ\text{C}$ down to $-30 \pm 2^\circ\text{C}$ and leave for 30 minutes. After that, heat up to $+85 \pm 2^\circ\text{C}$ and leave for 30 minutes. After then, cool down to $25^\circ\text{C}$ . Repeat the cycle 15 times and leave on the test conditions for 1.5 hours.
5	Drop Shock	Drop 150g weight onto steel floor from the height of 152cm, 19 times and 120cm, 12 times.
6	Vibration	With 5g of the whole acceleration at 20 to 2000 Hz, apply a vibration for 2 hours for each of 3 directions.
7	Solder Proof	No reaching after reflow for $5 \pm 1$ sec at $260^\circ\text{C}$ .
8	Soldering Conditions	$230 \pm 5^\circ\text{C}$ / $5 \pm 1$ sec for Sn/Pb soldering system $245 \pm 5^\circ\text{C}$ / $2 \pm 1$ sec for Pb-free soldering system

9. RECOMMENDED SOLDERING PATTERNS

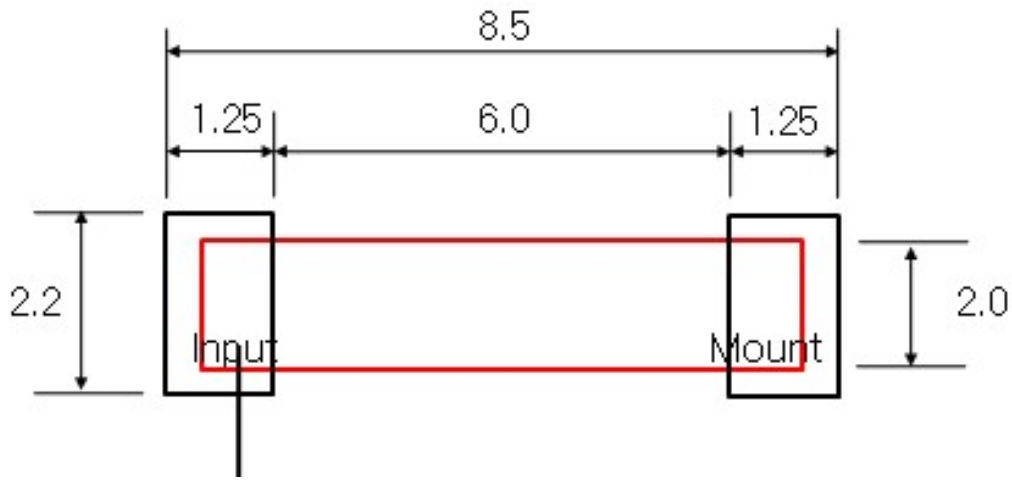

10. PACKAGING

10-1. Reel Taping Quantity

10,000 pcs / 1 reel

10-2. Reel Dimensions

: Reel Hall Direction should be same as Input Dot Direction of Antenna.

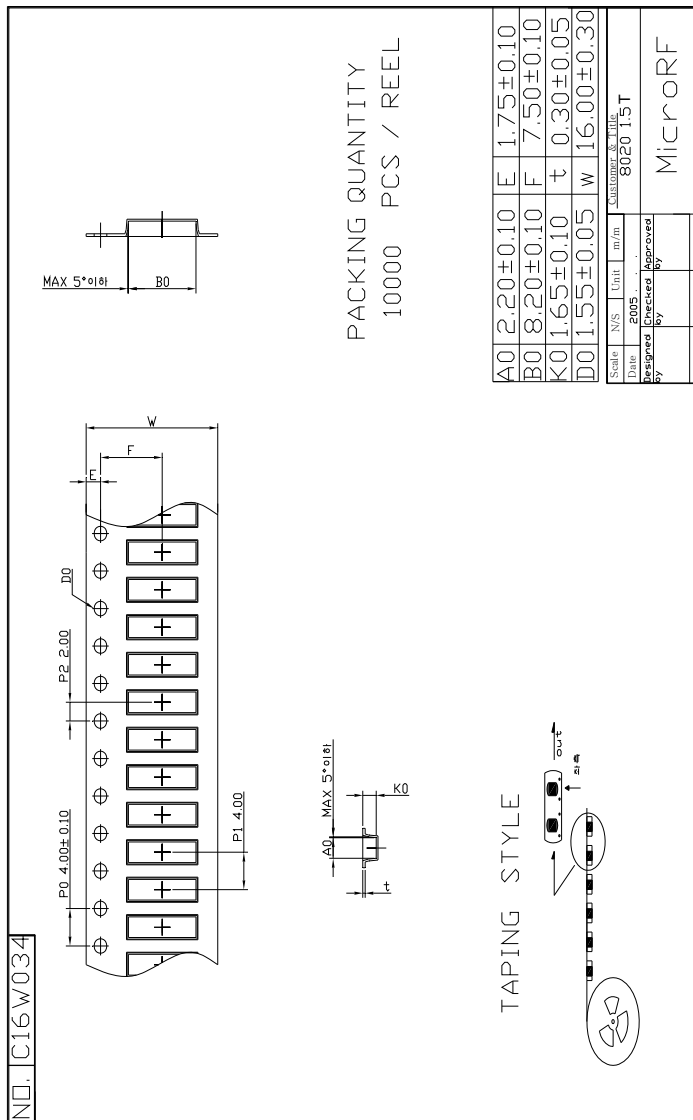

11. USAGE AND CAUTIONS

- Safe-keeping conditions: 3 months in 20±15°C and less than 60% RH



Report No. : 08 - 1435 - 0061-1

1 page of 3 pages

## TEST REPORT

**1. Applicant**

Name : MICRO RF  
 Address : 810,811,Venture Incubating Center,Suwon Univ.  
 San 2-2, Wawoori, Bongdam-eup, Hwaseong-si  
 Gyunggi-do, Korea.

**2. Products**

Name : ADSBT\*\*\*\*\*  
 Model/Type : \* \* \*  
 Manufacturer : \* \* \*

**3. Test Standard/Method** : Refer to the attached sheet.

**4. Test Results** : Refer to the attached sheet.

**5. Use of Report** : Q.C

**6. Date of Application** : JUN. 09. 2008.

**7. Date of Issue** : JUN. 26. 2008.

*The test results contained apply only to the test sample(s) supplied by the applicant, and this test report shall not be reproduced in full or in part without approval of the KTL in advance.*

**Tested by**  
  
 Kyung-Mee Lee  
 Material Testing Team

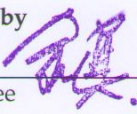
**Approved by**  
  
 Jin-Sook Lee  
 Technical Supervisor

## Korea Testing Laboratory

222-13, Guro3-Dong Guro-Gu Seoul 152-718, Korea.  
<http://www.ktl.re.kr>

Tel. : +82-2-860-1648  
 Fax. : +82-2-860-1649

FP204-01-01

## TEST RESULT

1. Test Conditions : (22 ± 2) °C, less than 55 %R.H.

2. Quantitative Analysis Results

1) Analysis of Heavy Metals

(Unit : mg/kg)

Element	Test Method	Detection Limit <sup>1)</sup>	Result
Pb	Refer to KS L 3418:2005	8.4	Not detected
Cd	Refer to KS L 3418:2005	0.54	Not detected
Hg	Refer to EPA 7473	1.2	Not detected
Cr <sup>6+</sup> <sup>2)</sup>	Refer to KS D 1662:2005	2.5	Not detected

<sup>1)</sup> Detection limits are calculated by detection limit of test instrument.

<sup>2)</sup> Unit : µg/ea.

2) Analysis of Brominated Flame Retardants

(Unit : mg/kg)

Element	Test Method	Detection Limit <sup>3)</sup>	Result
Total PBBs	GC-MS	1	Not detected
Mono-BB	"	"	"
Di-BB	"	"	"
Tri-BB	"	"	"
Tetra-BB	"	"	"
Penta-BB	"	"	"
Hexa-BB	"	"	"
Hepta-BB	"	"	"
Octa-BB	"	"	"
Nona-BB	"	"	"
Deca-BB	"	"	"

(Unit : mg/kg)

Element	Test Method	Detection Limit <sup>3)</sup>	Result
Total PBDEs	GC-MS	1	Not detected
Mono-BDE	"	"	"
Di-BDE	"	"	"
Tri-BDE	"	"	"
Tetra-BDE	"	"	"
Penta-BDE	"	"	"
Hexa-BDE	"	"	"
Hepta-BDE	"	"	"
Octa-BDE	"	"	"
Nona-BDE	"	"	"
Deca-BDE	"	"	"

<sup>3)</sup> Detection limits are detection limit of test instrument.

3) Analysis of Halogen Elements

(Unit : mg/kg)

Element	Test Method	Detection Limit	Result
Cl	Refer to EN 14582:2007	30	Not detected
T-Br	Refer to EN 14582:2007	30	Not detected

3. Test Instruments

Instrument	Maker	Model
ICP-AES	PERKIN ELMER	OPTIMA 4300
AAS	ThermoElectron Co.	SOLAAR Series
Mercury Analyzer	MILESTONE	DMA-80
UV/Vis Spectrophotometer	VARIAN	CARY 300
GC-MS	Agilent Technologies	6890N GC/5973N MSD
WD-XRF	RIGAKU	ZSX 100e
IC/AQF-100	DIONEX/MITSUBISHI CHEMICAL Co.	ICS-2000/AQF-100

THE END.