

SAR EVALUATION REPORT

For

DT Research, Inc.

6F, NO.1, NingPo E. St. Taipei, 100 Taiwan

FCC ID: YE3801I

IC: 7647A-801I

Report Type: Original Report	Product Type: Mobile Tablet
Report Number:	RDG171205015-20
Report Date:	2018-01-26
Reviewed By:	Rocky Xiao RF Engineer <i>Rocky Xiao</i>
Prepared By:	Bay Area Compliance Laboratories Corp. (Dongguan) No.69 Pulongcun, Puxinhu Industry Area, Tangxia, Dongguan, Guangdong, China Tel: +86-769-86858888 Fax: +86-769-86858891 www.baclcorp.com.cn

Attestation of Test Results			
EUT Information	EUT Description	Mobile Tablet	
	Tested Model	DT301A	
	FCC ID	YE3801I	
	IC	7647A-801I	
	Serial Number:	17120501520	
	Test Date	2017-12-12 ~ 2018-01-10	
MODE		Max. SAR Level(s) Reported(W/kg)	Limit(W/kg)
CDMA 850	1g Body SAR	0.25	1.6
CDMA1900	1g Body SAR	1.18	
WCDMA Band 2	1g Body SAR	1.12	
WCDMA Band 5	1g Body SAR	0.61	
LTE Band 2	1g Body SAR	1.00	
LTE Band 4	1g Body SAR	1.21	
LTE Band 5	1g Body SAR	0.65	
LTE Band 13	1g Body SAR	0.52	
LTE Band 17	1g Body SAR	0.35	
2.4GHz WLAN	1g Body SAR	0.43	
5GHz WLAN	1g Body SAR	0.96	
Bluetooth(BDR/EDR)	1g Body SAR	0.05	
Simultaneous	1g Body SAR	1.58	
	1g Body SAR	1.58(Hotspot)	
Applicable Standards	FCC 47 CFR part 2.1093 Radiofrequency radiation exposure evaluation: portable devices		
	RSS-102 Issue 5 March 2015 Radio Frequency (RF) Exposure Compliance of Radio communication Apparatus (All Frequency Bands).		
	IEEE1528:2013 IEEE Recommended Practice for Determining the Peak Spatial-Average Specific Absorption Rate (SAR) in the Human Head from Wireless Communications Devices: Measurement Techniques		
	IEC 62209-2:2010 Human exposure to radio frequency fields from hand-held and body-mounted wireless communication devices-Human models, instrumentation, and procedures-Part 2: Procedure to determine the specific absorption rate (SAR) for wireless communication devices used in close proximity to the human body (frequency range of 30 MHz to 6 GHz)		
	KDB procedures KDB 447498 D01 General RF Exposure Guidance v06 KDB 865664 D01 SAR measurement 100 MHz to 6 GHz v01r04 KDB 865664 D02 RF Exposure Reporting v01r02 KDB 941225 D01 3G SAR Procedures v03r01 KDB 941225 D05 SAR for LTE Devices v02r05 KDB 941225 D06 Hotspot Mode v02r01 KDB 616217 D04 SAR for laptop and tablets v01r02 KDB 248227 D01 802 11 Wi-Fi SAR v02r02		

Note: This wireless device has been shown to be capable of compliance for localized specific absorption rate (SAR) for Occupational/Controlled Exposure limits specified in **FCC 47 CFR part 2.1093/RSS-102 Issue 5 March 2015** and has been tested in accordance with the measurement procedures specified in IEEE 1528-2013 and RF exposure KDB procedures.

The results and statements contained in this report pertain only to the device(s) evaluated.

TABLE OF CONTENTS

DOCUMENT REVISION HISTORY	5
EUT DESCRIPTION	6
TECHNICAL SPECIFICATION	6
REFERENCE, STANDARDS, AND GUIDELINES.....	7
SAR LIMITS	8
FACILITIES.....	9
DESCRIPTION OF TEST SYSTEM	10
EQUIPMENT LIST AND CALIBRATION	15
EQUIPMENTS LIST & CALIBRATION INFORMATION	15
SAR MEASUREMENT SYSTEM VERIFICATION	16
LIQUID VERIFICATION	16
SYSTEM ACCURACY VERIFICATION	19
SAR SYSTEM VALIDATION DATA	21
EUT TEST STRATEGY AND METHODOLOGY	31
TEST POSITIONS FOR DEVICE OPERATING NEXT TO A PERSON’S EAR.....	31
CHEEK/TOUCH POSITION	32
EAR/TILT POSITION	32
TEST POSITIONS FOR BODY-WORN AND OTHER CONFIGURATIONS	33
TEST DISTANCE FOR SAR EVALUATION	33
SAR EVALUATION PROCEDURE.....	34
CONDUCTED OUTPUT POWER MEASUREMENT	35
PROVISION APPLICABLE	35
TEST PROCEDURE	35
RADIO CONFIGURATION	35
MAXIMUM TARGET OUTPUT POWER	40
PROXIMITY SENSOR OPERATION.....	44
TEST RESULTS:	45
STANDALONE SAR TEST EXCLUSION CONSIDERATIONS	72
ANTENNA LOCATION	72
ANTENNA DISTANCE TO EDGE	72
STANDALONE SAR TEST EXCLUSION CONSIDERATIONS(KDB):.....	73
SAR TEST EXCLUSION FOR THE EUT EDGE CONSIDERATIONS RESULT	74
STANDALONE SAR TEST EXCLUSION CONSIDERATIONS(RSS-102):.....	75
SAR TEST EXCLUSION FOR THE EUT EDGE CONSIDERATIONS RESULT	75
SAR TEST DATA.....	77
SAR MEASUREMENT VARIABILITY	98
SAR SIMULTANEOUS TRANSMISSION DESCRIPTION	99
SAR PLOTS.....	104
APPENDIX A MEASUREMENT UNCERTAINTY	105
APPENDIX B EUT TEST POSITION PHOTOS	107
APPENDIX C –CALIBRATION CERTIFICATES	108

DOCUMENT REVISION HISTORY

Revision Number	Report Number	Description of Revision	Date of Revision
0	RDG171205015-20	Original Report	2018-01-26

EUT DESCRIPTION

This report has been prepared on behalf of **DT Research, Inc.** and their product, Model: **DT301A**, FCC ID: **YE3801I**, IC: **7647A-801I** or the EUT (Equipment under Test) as referred to in the rest of this report.

**All measurement and test data in this report was gathered from production sample serial number: 17120501520 (Assigned by BACL, Dongguan).The EUT supplied by the applicant was received on 2017-12-07.*

Technical Specification

Product Type	Portable
Exposure Category:	Population / Uncontrolled
Antenna Type(s):	Internal Antenna for WWAN, WLAN and Bluetooth External Antenna for long ranger Hopping
Body-Worn Accessories:	None
Operation Mode :	CDMA 1xRTT, 1xEVDO Rev.A, WCDMA, LTE, WLAN 2.4G/5G and Bluetooth, long ranger Hopping
Frequency Band:	CDMA 850(BC0): 824-849 MHz(TX) ; 869-894 MHz(RX) CDMA 1900(BC1): 1850-1910 MHz(TX) ; 1930-1990 MHz(RX) WCDMA Band 2: 1850-1910 MHz(TX) ; 1930-1990 MHz(RX) WCDMA Band 5: 824-849 MHz(TX) ; 869-894 MHz(RX) LTE Band 2: 1850-1910 MHz(TX) ; 1930-1990 MHz(RX) LTE Band 4: 1710-1755 MHz(TX) ; 2110-2155 MHz(RX) LTE Band 5: 824-849 MHz(TX) ; 869-894 MHz(RX) LTE Band 13: 777-787 MHz(TX) ; 746-756 MHz(RX) LTE Band 17: 704-716 MHz(TX) ; 734-746 MHz(RX) WLAN 2.4G: 2412MHz-2462MHz WLAN 5G: 5150-5250 MHz/5250-5350 MHz/5470-5725 MHz/5725-5850 MHz Bluetooth : 2402MHz-2480MHz Long range Hopping: 2401.6MHz-2470.8MHz
Conducted RF Power:	CDMA 850 : 23.97 dBm; CDMA 1900: 23.96 dBm WCDMA Band 2 : 22.86 dBm; WCDMA Band 5: 22.88 dBm LTE Band 2: 23.86 dBm ; LTE Band 4: 23.74 dBm LTE Band 5: 24.33 dBm; LTE Band 13: 24.01 dBm LTE Band 17: 23.99 dBm; WLAN 2.4G: 19.87 dBm WLAN 5G: 14.68 dBm Bluetooth BDR/EDR: 5.90 dBm Bluetooth LE: -1.30 dBm Long range Hopping: 15.71 dBm
Dimensions (L*W*H):	28.5 cm (H) x 20.0 cm (W) x 5.4 cm (D)
Power Source:	11.4 V _{DC} Rechargeable Battery
Normal Operation:	Body Supported

Note : The overall diagonal dimension of the EUT >200mm, so test procedures in KDB616217 D04 should be applicable.

REFERENCE, STANDARDS, AND GUIDELINES

FCC:

The Report and Order requires routine SAR evaluation prior to equipment authorization of portable transmitter devices, including portable telephones. For consumer products, the applicable limit is 1.6 mW/g as recommended by the ANSI/IEEE standard C95.1-1992 [6] for an uncontrolled environment (Paragraph 65). According to the Supplement C of OET Bulletin 65 "Evaluating Compliance with FCC Guide-lines for Human Exposure to Radio frequency Electromagnetic Fields", released on Jun 29, 2001 by the FCC, the device should be evaluated at maximum output power (radiated from the antenna) under "worst-case" conditions for normal or intended use, incorporating normal antenna operating positions, device peak performance frequencies and positions for maximum RF energy coupling.

This report describes the methodology and results of experiments performed on wireless data terminal. The objective was to determine if there is RF radiation and if radiation is found, what is the extent of radiation with respect to safety limits. SAR (Specific Absorption Rate) is the measure of RF exposure determined by the amount of RF energy absorbed by human body (or its parts) – to determine how the RF energy couples to the body or head which is a primary health concern for body worn devices. The limit below which the exposure to RF is considered safe by regulatory bodies in North America is 1.6 mW/g average over 1 gram of tissue mass.

CE:

The order requires routine SAR evaluation prior to equipment authorization of portable transmitter devices, including portable telephones. For consumer products, the applicable limit is 2 mW/g as recommended by EN62209-1 for an uncontrolled environment. According to the Standard, the device should be evaluated at maximum output power (radiated from the antenna) under "worst-case" conditions for normal or intended use, incorporating normal antenna operating positions, device peak performance frequencies and positions for maximum RF energy coupling.

This report describes the methodology and results of experiments performed on wireless data terminal. The objective was to determine if there is RF radiation and if radiation is found, what is the extent of radiation with respect to safety limits. SAR (Specific Absorption Rate) is the measure of RF exposure determined by the amount of RF energy absorbed by human body (or its parts) – to determine how the RF energy couples to the body or head which is a primary health concern for body worn devices. The limit below which the exposure to RF is considered safe by regulatory bodies in Europe is 2 mW/g average over 10 gram of tissue mass.

The test configurations were laid out on a specially designed test fixture to ensure the reproducibility of measurements. Each configuration was scanned for SAR. Analysis of each scan was carried out to characterize the above effects in the device.

SAR Limits

FCC&IC Limit

EXPOSURE LIMITS	SAR (W/kg)	
	(General Population / Uncontrolled Exposure Environment)	(Occupational / Controlled Exposure Environment)
Spatial Average (averaged over the whole body)	0.08	0.4
Spatial Peak (averaged over any 1 g of tissue)	1.60	8.0
Spatial Peak (hands/wrists/feet/ankles averaged over 10 g)	4.0	20.0

CE Limit

EXPOSURE LIMITS	SAR (W/kg)	
	(General Population / Uncontrolled Exposure Environment)	(Occupational / Controlled Exposure Environment)
Spatial Average (averaged over the whole body)	0.08	0.4
Spatial Peak (averaged over any 10 g of tissue)	2.0	10
Spatial Peak (hands/wrists/feet/ankles averaged over 10 g)	4.0	20.0

Population/Uncontrolled Environments are defined as locations where there is the exposure of individual who have no knowledge or control of their exposure.

Occupational/Controlled Environments are defined as locations where there is exposure that may be incurred by people who are aware of the potential for exposure (i.e. as a result of employment or occupation).

General Population/Uncontrolled environments Spatial Peak limit **1.6W/kg** (FCC/IC) & 2 W/kg (CE) applied to the EUT.

FACILITIES

The Test site used by Bay Area Compliance Laboratories Corp. (Dongguan) to collect test data is located on the No.69 Pulongcun, Puxinhu Industry Area, Tangxia, Dongguan, Guangdong, China

The test site has been approved by the FCC under the KDB 974614 D01 and is listed in the FCC Public Access Link (PAL) database, FCC Registration No. : 897218,the FCC Designation No. : CN1220.

The test site has been registered with ISED Canada under ISED Canada Registration Number 3062D.

The test sites and measurement facilities used to collect data are located at:

<input type="checkbox"/> SAR Lab 1	<input checked="" type="checkbox"/> SAR Lab 2
------------------------------------	-----------------------------------------------

DESCRIPTION OF TEST SYSTEM

These measurements were performed with the automated near-field scanning system DASY5 from Schmid & Partner Engineering AG (SPEAG) which is the Fifth generation of the system shown in the figure hereinafter:



DASY5 System Description

The DASY5 system for performing compliance tests consists of the following items:

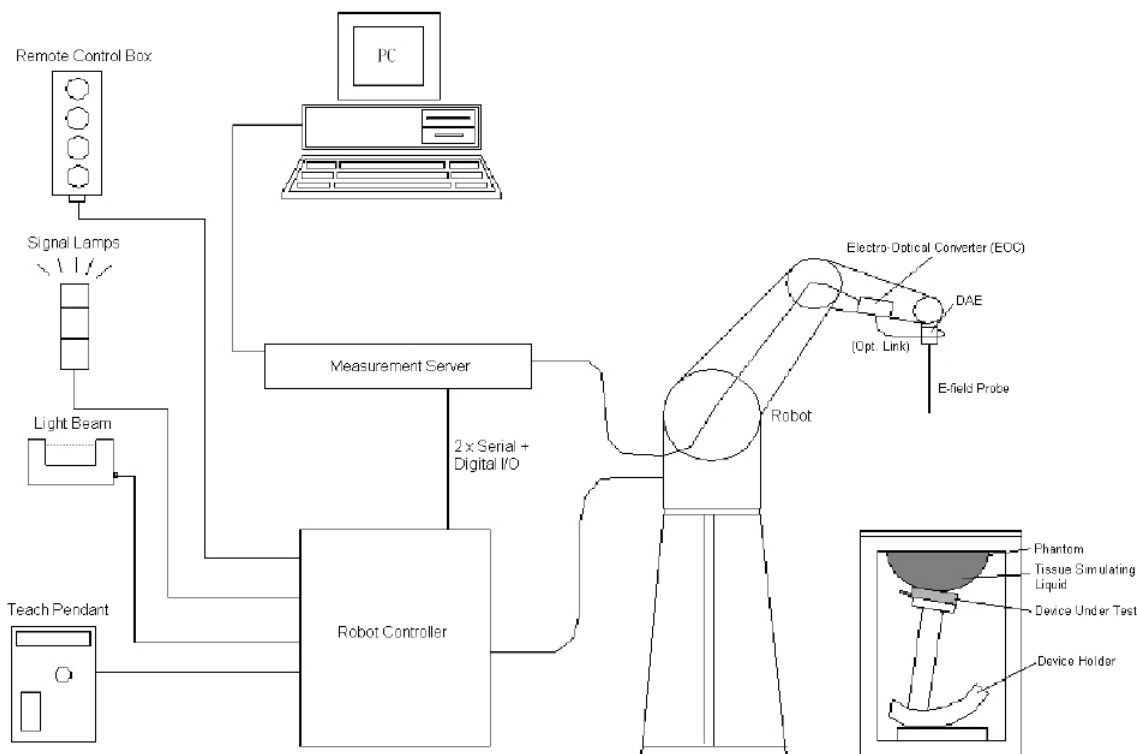

- A standard high precision 6-axis robot with controller, teach pendant and software. An arm extension for accommodating the data acquisition electronics (DAE).
- An isotropic field probe optimized and calibrated for the targeted measurement.
- A data acquisition electronics (DAE) which performs the signal application, signal multiplexing, AD-conversion, offset measurements, mechanical surface detection, collision detection, etc. The unit is battery powered with standard or rechargeable batteries. The signal is optically transmitted to the EOC.
- The Electro-optical converter (EOC) performs the conversion from optical to electrical signals for the digital communication to the DAE. To use optical surface detection, a special version of the EOC is required. The EOC signal is transmitted to the measurement server.
- The function of the measurement server is to perform the time critical tasks such as signal filtering, control of the robot operation and fast movement interrupts.
- The Light Beam used is for probe alignment. This improves the (absolute) accuracy of the probe positioning.
- A computer running Win7 professional operating system and the DASY52 software.
- Remote control and teach pendant as well as additional circuitry for robot safety such as warning lamps, etc.
- The phantom, the device holder and other accessories according to the targeted measurement.

DASY5 Measurement Server

The DASY5 measurement server is based on a PC/104 CPU board with a 400MHz Intel ULV Celeron, 128MB chip-disk and 128MB RAM. The necessary circuits for communication with the DAE4 (or DAE3) electronics box, as well as the 16 bit AD-converter system for optical detection and digital I/O interface are contained on the DASY5 I/O board, which is directly connected to the PC/104 bus of the CPU board.



The measurement server performs all real-time data evaluation of field measurements and surface detection, controls robot movements and handles safety operation. The PC operating system cannot interfere with these time critical processes. All connections are supervised by a watchdog, and disconnection of any of the cables to the measurement server will automatically disarm the robot and disable all program-controlled robot movements. Furthermore, the measurement server is equipped with an expansion port which is reserved for future applications. Please note that this expansion port does not have a standardized point out, and therefore only devices provided by SPEAG can be connected. Devices from any other supplier could seriously damage the measurement server.

Data Acquisition Electronics

The data acquisition electronics (DAE4) consist of a highly sensitive electrometer-grade preamplifier with auto-zeroing, a channel and gain-switching multiplexer, a fast 16 bit AD-converter and a command decoder with a control logic unit. Transmission to the measurement server is accomplished through an optical downlink for data and status information, as well as an optical uplink for commands and the clock.

The mechanical probe mounting device includes two different sensor systems for frontal and sideways probe contacts. They are used for mechanical surface detection and probe collision detection.

The input impedance of both the DAE4 as well as of the DAE3 box is 200M Ω ; the inputs are symmetrical and floating. Common mode rejection is above 80 dB.

ES3DV2 E-Field Probes

Frequency	10 MHz to > 4 GHz Linearity: ± 0.2 dB (30 MHz to 4 GHz)
Directivity	± 0.2 dB in TSL (rotation around probe axis) ± 0.3 dB in TSL (rotation normal to probe axis)
Dynamic Range	5 µW/g to > 100 mW/g Linearity: ± 0.2 dB (noise: typically < 1 µW/g)
Dimensions	Overall length: 337 mm (Tip: 10 mm) Tip diameter: 4 mm (Body: 10 mm) Typical distance from probe tip to dipole centers: 4.0 mm
Application	General dosimetry up to 4 GHz Dosimetry in strong gradient fields Compliance tests of mobile phones
Compatibility	DASY3, DASY4, DASY52 SAR and higher, EASY4/MRI

EX3DV4 E-Field Probes

Frequency	10 MHz to > 6 GHz Linearity: ± 0.2 dB (30 MHz to 6 GHz)
Directivity	± 0.3 dB in TSL (rotation around probe axis) ± 0.5 dB in TSL (rotation normal to probe axis)
Dynamic Range	10 µW/g to > 100 mW/g Linearity: ± 0.2 dB (noise: typically < 1 µW/g)
Dimensions	Overall length: 337 mm (Tip: 20 mm) Tip diameter: 2.5 mm (Body: 12 mm) Typical distance from probe tip to dipole centers: 1 mm
Application	High precision dosimetric measurements in any exposure scenario (e.g., very strong gradient fields); the only probe that enables compliance testing for frequencies up to 6 GHz with precision of better 30%.
Compatibility	DASY3, DASY4, DASY52 SAR and higher, EASY4/MRI

SAM Twin Phantom

The SAM twin phantom is a fiberglass shell phantom with 2mm shell thickness (except the ear region, where shell thickness increases to 6 mm). The phantom has three measurement areas:

- _ Left Head
- _ Right Head
- _ Flat phantom

The phantom table for the DASY systems based on the robots have the size of 100 x 50 x 85 cm (L x W x H). For easy dislocation these tables have fork lift cut outs at the bottom.

The bottom plate contains three pairs of bolts for locking the device holder. The device holder positions are adjusted to the standard measurement positions in the three sections. Only one device holder is necessary if two phantoms are used (e.g., for different liquids)



A white cover is provided to cover the phantom during off-periods to prevent water evaporation and changes in the liquid parameters. Free space scans of devices on top of this phantom cover are possible. Three reference marks are provided on the phantom counter. These reference marks are used to teach the absolute phantom position relative to the robot.

Robots

The DASY5 system uses the high precision industrial robot. The robot offers the same features important for our application:

- High precision (repeatability 0.02mm)
- High reliability (industrial design)
- Low maintenance costs (virtually maintenance free due to direct drive gears; no belt drives)
- Jerk-free straight movements (brushless synchrony motors; no stepper motors)
- Low ELF interference (motor control fields shielded via the closed metallic construction shields)

The above mentioned robots are controlled by the Staubli CS8c robot controllers. All information regarding the use and maintenance of the robot arm and the robot controller is contained on the CDs delivered along with the robot. Paper manuals are available upon request direct from Staubli.

Area Scans

Area scans are defined prior to the measurement process being executed with a user defined variable spacing between each measurement point (integral) allowing low uncertainty measurements to be conducted. Scans defined for FCC applications utilize a 15mm 2 step integral, with 1.5mm interpolation used to locate the peak SAR area used for zoom scan assessments.

Where the system identifies multiple SAR peaks (which are within 25% of peak value) the system will provide the user with the option of assessing each peak location individually for zoom scan averaging.

Zoom Scan (Cube Scan Averaging)

The averaging zoom scan volume utilized in the DASY5 software is in the shape of a cube and the side dimension of a 1 g or 10 g mass is dependent on the density of the liquid representing the simulated tissue. A density of 1000 kg/m³ is used to represent the head and body tissue density and not the phantom liquid density, in order to be consistent with the definition of the liquid dielectric properties, i.e. the side length of the 1g cube is 10mm, with the side length of the 10g cube is 21.5mm.

When the cube intersects with the surface of the phantom, it is oriented so that 3 vertices touch the surface of the shell or the center of a face is tangent to the surface. The face of the cube closest to the surface is modified in order to conform to the tangent surface.

The zoom scan integer steps can be user defined so as to reduce uncertainty, but normal practice for typical test applications (including FCC) utilize a physical step of 7 x 7 x 7 (5mmx5mmx5mm) providing a volume of 30 mm in the X & Y & Z axis.

Tissue Dielectric Parameters for Head and Body Phantoms

The head tissue dielectric parameters recommended by the IEEE SCC-34/SC-2 in P1528 have been incorporated in the following table. These head parameters are derived from planar layer models simulating the highest expected SAR for the dielectric properties and tissue thickness variations in a human head. Other head and body tissue parameters that have not been specified in P1528 are derived from the tissue dielectric parameters computed from the 4-Cole-Cole equations described in Reference [12] and extrapolated according to the head parameters specified in P1528.

Recommended Tissue Dielectric Parameters for Head and Body

Frequency (MHz)	Head Tissue		Body Tissue	
	ϵ_r	σ (S/m)	ϵ_r	σ (S/m)
150	52.3	0.76	61.9	0.80
300	45.3	0.87	58.2	0.92
450	43.5	0.87	56.7	0.94
835	41.5	0.90	55.2	0.97
900	41.5	0.97	55.0	1.05
915	41.5	0.98	55.0	1.06
1450	40.5	1.20	54.0	1.30
1610	40.3	1.29	53.8	1.40
1800-2000	40.0	1.40	53.3	1.52
2450	39.2	1.80	52.7	1.95
3000	38.5	2.40	52.0	2.73
5800	35.3	5.27	48.2	6.00

EQUIPMENT LIST AND CALIBRATION

Equipments List & Calibration Information

Equipment	Model	S/N	Calibration Date	Calibration Due Date
DASY5 Test Software	DASY52.8	N/A	NCR	NCR
DASY5 Measurement Server	DASY5 4.5.12	1567	NCR	NCR
Data Acquisition Electronics	DAE4	772	2017/10/9	2018/10/8
E-Field Probe	EX3DV4	7329	2017/3/13	2018/3/12
E-Field Probe	ES3DV2	3019	2017/10/30	2018/10/29
Mounting Device	MD4HHTV5	BJPCTC0152	NCR	NCR
Twin SAM	Twin SAM V5.0	1412	NCR	NCR
Dipole, 750 MHz	D750V3	1167	2016/11/8	2019/11/7
Dipole, 1750 MHz	D1750V2	1141	2015/7/9	2018/7/9
Dipole, 1900 MHz	D1900V2	543	2016/10/25	2019/10/24
Dipole, 2450 MHz	D2450V2	971	2015/7/8	2018/7/8
Dipole, 5GHz	D5GHzV2	1246	2016/11/7	2019/11/6
Simulated Tissue 750 MHz Body	TS-750-B	1710075002	Each Time	/
Simulated Tissue 1750 MHz Body	TS-1750-B	1709175002	Each Time	/
Simulated Tissue 1900 MHz Body	TS-1900-B	1709190002	Each Time	/
Simulated Tissue 2450 MHz Body	TS-2450-B	1709245002	Each Time	/
Simulated Tissue 5250 MHz Body	TS-5250-B	1701525002	Each Time	/
Simulated Tissue 5600 MHz Body	TS-5600-B	1701560002	Each Time	/
Simulated Tissue 5800 MHz Body	TS-5800-B	1701580002	Each Time	/
Network Analyzer	8753C	3033A02857	2017/8/31	2018/8/31
Dielectric assessment kit	1253	SM DAK 040 CA	NCR	NCR
Signal Generator	N5182B	MY51350142	2017/5/4	2018/5/4
Power Meter	EPM-441A	GB37481494	2017/12/11	2018/12/11
Power Amplifier	ZVA-183-S+	5969001149	NCR	NCR
Directional Coupler	488Z	N/A	NCR	NCR
Attenuator	20dB, 100W	N/A	NCR	NCR
Attenuator	3dB, 150W	N/A	NCR	NCR
R&S, universal Radio Communication Tester	CMU200	109 038	2017/7/21	2018/7/21
Wireless communication tester	E5515C	MY48367501	2017/12/11	2018/12/11
Wideband Radio Communication Tester	CMW500	1201.0002K50	2017/8/31	2018/8/31

SAR MEASUREMENT SYSTEM VERIFICATION

Liquid Verification

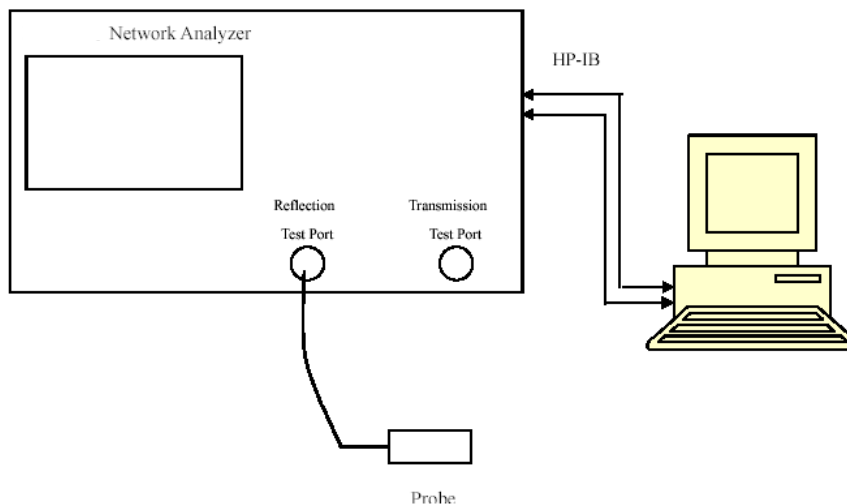

Liquid Verification Setup Block Diagram

Liquid Verification Results

Frequency (MHz)	Liquid Type	Liquid Parameter		Target Value		Delta (%)		Tolerance (%)
		ϵ_r	σ (S/m)	ϵ_r	σ (S/m)	$\Delta\epsilon_r$	$\Delta\sigma$ (S/m)	
750	Simulated Tissue 750MHz Body	57.073	0.975	55.53	0.96	2.78	1.56	± 5
782	Simulated Tissue 750MHz Body	56.815	1.016	55.41	0.97	2.54	4.74	± 5

*Liquid Verification above was performed on 2018-01-03.

Frequency (MHz)	Liquid Type	Liquid Parameter		Target Value		Delta (%)		Tolerance (%)
		ϵ_r	σ (S/m)	ϵ_r	σ (S/m)	$\Delta\epsilon_r$	$\Delta\sigma$ (S/m)	
709	Simulated Tissue 750MHz Body	57.193	0.943	55.69	0.96	2.7	-1.77	± 5
710	Simulated Tissue 750MHz Body	57.189	0.946	55.69	0.96	2.69	-1.46	± 5
711	Simulated Tissue 750MHz Body	57.172	0.947	55.68	0.96	2.68	-1.35	± 5
750	Simulated Tissue 750MHz Body	57.133	0.959	55.53	0.96	2.89	-0.1	± 5
824.7	Simulated Tissue 750MHz Body	56.838	0.963	55.24	0.97	2.89	-0.72	± 5
836.52	Simulated Tissue 750MHz Body	56.376	0.964	55.2	0.97	2.13	-0.62	± 5
848.31	Simulated Tissue 750MHz Body	56.291	0.975	55.16	0.99	2.05	-1.52	± 5

*Liquid Verification above was performed on 2018-01-08.

Frequency (MHz)	Liquid Type	Liquid Parameter		Target Value		Delta (%)		Tolerance (%)
		ϵ_r	σ (S/m)	ϵ_r	σ (S/m)	$\Delta\epsilon_r$	$\Delta\sigma$ (S/m)	
750	Simulated Tissue 750MHz Body	57.543	0.945	55.53	0.96	3.63	-1.56	±5
826.4	Simulated Tissue 750MHz Body	57.466	0.953	55.23	0.97	4.05	-1.75	±5
829	Simulated Tissue 750MHz Body	57.446	0.958	55.22	0.97	4.03	-1.24	±5
836.5	Simulated Tissue 750MHz Body	57.296	0.962	55.2	0.97	3.8	-0.82	±5
836.6	Simulated Tissue 750MHz Body	57.295	0.967	55.2	0.97	3.8	-0.31	±5
844	Simulated Tissue 750MHz Body	57.223	0.968	55.17	0.98	3.72	-1.22	±5
846.6	Simulated Tissue 750MHz Body	56.998	0.974	55.16	0.98	3.33	-0.61	±5

*Liquid Verification above was performed on 2018-01-09.

Frequency (MHz)	Liquid Type	Liquid Parameter		Target Value		Delta (%)		Tolerance (%)
		ϵ_r	σ (S/m)	ϵ_r	σ (S/m)	$\Delta\epsilon_r$	$\Delta\sigma$ (S/m)	
1720	Simulated Tissue 1750 MHz Body	52.819	1.512	53.51	1.47	-1.29	2.86	±5
1732.5	Simulated Tissue 1750 MHz Body	52.786	1.526	53.48	1.48	-1.3	3.11	±5
1745	Simulated Tissue 1750 MHz Body	52.694	1.539	53.44	1.49	-1.4	3.29	±5
1750	Simulated Tissue 1750 MHz Body	52.611	1.543	53.43	1.49	-1.53	3.56	±5

*Liquid Verification above was performed on 2018-01-10.

Frequency (MHz)	Liquid Type	Liquid Parameter		Target Value		Delta (%)		Tolerance (%)
		ϵ_r	σ (S/m)	ϵ_r	σ (S/m)	$\Delta\epsilon_r$	$\Delta\sigma$ (S/m)	
1852.4	Simulated Tissue 1900 MHz Body	54.564	1.452	53.3	1.52	2.37	-4.47	±5
1860	Simulated Tissue 1900 MHz Body	54.374	1.467	53.3	1.52	2.02	-3.49	±5
1880	Simulated Tissue 1900 MHz Body	54.225	1.471	53.3	1.52	1.74	-3.22	±5
1900	Simulated Tissue 1900 MHz Body	54.154	1.491	53.3	1.52	1.6	-1.91	±5
1907.6	Simulated Tissue 1900 MHz Body	54.064	1.514	53.3	1.52	1.43	-0.39	±5

*Liquid Verification above was performed on 2018-01-02.

Frequency (MHz)	Liquid Type	Liquid Parameter		Target Value		Delta (%)		Tolerance (%)
		ϵ_r	σ (S/m)	ϵ_r	σ (S/m)	$\Delta\epsilon_r$	$\Delta\sigma$ (S/m)	
1851.25	Simulated Tissue 1900 MHz Body	54.605	1.458	53.3	1.52	2.45	-4.08	±5
1880	Simulated Tissue 1900 MHz Body	54.198	1.49	53.3	1.52	1.68	-1.97	±5
1900	Simulated Tissue 1900 MHz Body	54.161	1.518	53.3	1.52	1.62	-0.13	±5
1908.75	Simulated Tissue 1900 MHz Body	54.031	1.535	53.3	1.52	1.37	0.99	±5

*Liquid Verification above was performed on 2018-01-03.

Frequency (MHz)	Liquid Type	Liquid Parameter		Target Value		Delta (%)		Tolerance (%)
		ϵ_r	σ (S/m)	ϵ_r	σ (S/m)	$\Delta\epsilon_r$	$\Delta\sigma$ (S/m)	
2402	Simulated Tissue 2450 MHz Body	54.432	1.868	52.76	1.9	3.17	-1.68	±5
2412	Simulated Tissue 2450 MHz Body	54.359	1.909	52.75	1.91	3.05	-0.05	±5
2437	Simulated Tissue 2450 MHz Body	54.235	1.935	52.72	1.94	2.87	-0.26	±5
2441	Simulated Tissue 2450 MHz Body	53.418	1.936	52.71	1.94	1.34	-0.21	±5
2450	Simulated Tissue 2450 MHz Body	52.669	1.956	52.7	1.95	-0.06	0.31	±5
2462	Simulated Tissue 2450 MHz Body	51.891	1.977	52.68	1.97	-1.5	0.36	±5
2480	Simulated Tissue 2450 MHz Body	51.606	1.983	52.66	1.99	-2	-0.35	±5

*Liquid Verification above was performed on 2018-01-10.

Frequency (MHz)	Liquid Type	Liquid Parameter		Target Value		Delta (%)		Tolerance (%)
		ϵ_r	σ (S/m)	ϵ_r	σ (S/m)	$\Delta\epsilon_r$	$\Delta\sigma$ (S/m)	
5180	Simulated Tissue 5250 MHz Body	50.724	5.361	49.04	5.28	3.43	1.53	±5
5200	Simulated Tissue 5250 MHz Body	50.659	5.397	49.01	5.3	3.36	1.83	±5
5240	Simulated Tissue 5250 MHz Body	49.913	5.419	48.96	5.35	1.95	1.29	±5
5250	Simulated Tissue 5250 MHz Body	49.872	5.563	48.95	5.36	1.88	3.79	±5
5260	Simulated Tissue 5250 MHz Body	49.604	5.578	48.93	5.37	1.38	3.87	±5
5280	Simulated Tissue 5250 MHz Body	49.511	5.604	48.91	5.39	1.23	3.97	±5
5320	Simulated Tissue 5250 MHz Body	49.435	5.669	48.86	5.43	1.18	4.40	±5

*Liquid Verification above was performed on 2017-12-12.

Frequency (MHz)	Liquid Type	Liquid Parameter		Target Value		Delta (%)		Tolerance (%)
		ϵ_r	σ (S/m)	ϵ_r	σ (S/m)	$\Delta\epsilon_r$	$\Delta\sigma$ (S/m)	
5500	Simulated Tissue 5600 MHz Body	49.827	5.476	48.61	5.65	2.5	-3.08	±5
5580	Simulated Tissue 5600 MHz Body	48.764	5.513	48.5	5.74	0.54	-3.95	±5
5600	Simulated Tissue 5600 MHz Body	48.506	5.649	48.47	5.77	0.07	-2.1	±5
5700	Simulated Tissue 5600 MHz Body	48.479	5.705	48.34	5.88	0.29	-2.98	±5
5720	Simulated Tissue 5600 MHz Body	48.256	5.812	48.31	5.9	-0.11	-1.49	±5

*Liquid Verification above was performed on 2017-12-13.

Frequency (MHz)	Liquid Type	Liquid Parameter		Target Value		Delta (%)		Tolerance (%)
		ϵ_r	σ (S/m)	ϵ_r	σ (S/m)	$\Delta\epsilon_r$	$\Delta\sigma$ (S/m)	
5745	Simulated Tissue 5800 MHz Body	49.133	5.861	48.27	5.94	1.79	-1.33	±5
5785	Simulated Tissue 5800 MHz Body	49.016	5.897	48.22	5.98	1.65	-1.39	±5
5800	Simulated Tissue 5800 MHz Body	48.981	5.902	48.2	6	1.62	-1.63	±5
5825	Simulated Tissue 5800 MHz Body	48.717	5.934	48.2	6	1.07	-1.1	±5

*Liquid Verification above was performed on 2017-12-13.

System Accuracy Verification

Prior to the assessment, the system validation kit was used to test whether the system was operating within its specifications of $\pm 10\%$. The validation results are tabulated below. And also the corresponding SAR plot is attached as well in the SAR plots files.

The spacing distances in the **System Verification Setup Block Diagram** is given by the following:

- a) $s = 15 \text{ mm} \pm 0,2 \text{ mm}$ for $300 \text{ MHz} \leq f \leq 1 \text{ 000 MHz}$;
- b) $s = 10 \text{ mm} \pm 0,2 \text{ mm}$ for $1 \text{ 000 MHz} < f \leq 3 \text{ 000 MHz}$;
- c) $s = 10 \text{ mm} \pm 0,2 \text{ mm}$ for $3 \text{ 000 MHz} < f \leq 6 \text{ 000 MHz}$.

System Verification Setup Block Diagram

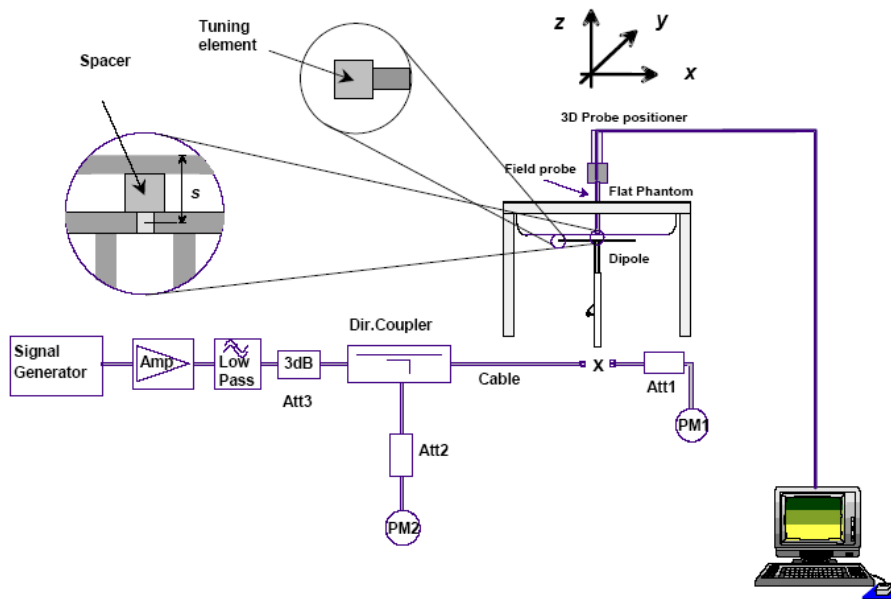

System Accuracy Check Results

Date	Frequency Band(MHz)	Liquid Type	Input Power (mW)	Measured SAR (W/kg)		Normalized to 1W (W/kg)	Target Value (W/kg)	Delta (%)	Tolerance (%)
2018/01/03	750MHz	750MHz Body	100	1g	0.852	8.52	8.58	-0.70	± 10
2018/01/08	750MHz	750MHz Body	100	1g	0.841	8.41	8.58	-1.98	± 10
2018/01/09	750MHz	750MHz Body	100	1g	0.865	8.65	8.58	0.82	± 10
2018/01/10	1750MHz	1750MHz Body	100	1g	3.89	38.9	37.4	4.01	± 10
2018/01/02	1900MHz	1900MHz Body	100	1g	4.23	42.3	41.1	2.92	± 10
2018/01/03	1900MHz	1900MHz Body	100	1g	4.34	43.4	41.1	5.60	± 10
2018/01/10	2450MHz	2450 MHz Body	100	1g	5.3	53	50.6	4.74	± 10

*The SAR values above are normalized to 1 Watt forward power.

Date	Frequency Band(MHz)	Liquid Type	Input Power (mW)	Measured SAR (W/kg)		Normalized to 1W (W/kg)	Target Value (W/kg)	Delta (%)	Tolerance (%)
2017/12/12	5250MHz	5250MHz Body	100	1g	7.59	75.9	77.6	-2.19	±10
2017/12/13	5600MHz	5600MHz Body	100	1g	8.01	80.1	77.8	2.96	±10
2017/12/13	5800MHz	5800MHz Body	100	1g	7.67	76.7	75.4	1.72	±10

*The SAR values above are normalized to 1 Watt forward power.

SAR SYSTEM VALIDATION DATA

System Performance 750 MHz Body on 2018/01/03

DUT: D750V3; Type: 750 MHz; Serial: 1167

Communication System: CW; Frequency: 750 MHz; Duty Cycle: 1:1

Medium parameters used: $f = 750 \text{ MHz}$; $\sigma = 0.975 \text{ S/m}$; $\epsilon_r = 57.073$; $\rho = 1000 \text{ kg/m}^3$

Phantom section: Flat Section

DASY5 Configuration:

- Probe: ES3DV2 - SN3019; ConvF(6.42, 6.42, 6.42); Calibrated: 2017/10/30;
- Sensor-Surface: 4mm (Mechanical Surface Detection)
- Electronics: DAE4 Sn772; Calibrated: 2016/10/25
- Phantom: Twin SAM; Type: Twin SAM V5.0; Serial: 1412
- Measurement SW: DASY52, Version 52.8 (8);

Area Scan (41x101x1): Interpolated grid: $dx=1.500 \text{ mm}$, $dy=1.500 \text{ mm}$

Maximum value of SAR (interpolated) = 1.21 W/kg

Zoom Scan (5x5x7)/Cube 0: Measurement grid: $dx=8\text{mm}$, $dy=8\text{mm}$, $dz=5\text{mm}$

Reference Value = 31.67 V/m; Power Drift = 0.02 dB

Peak SAR (extrapolated) = 1.43 W/kg

SAR(1 g) = 0.852 W/kg; SAR(10 g) = 0.569 W/kg

Maximum value of SAR (measured) = 1.22 W/kg

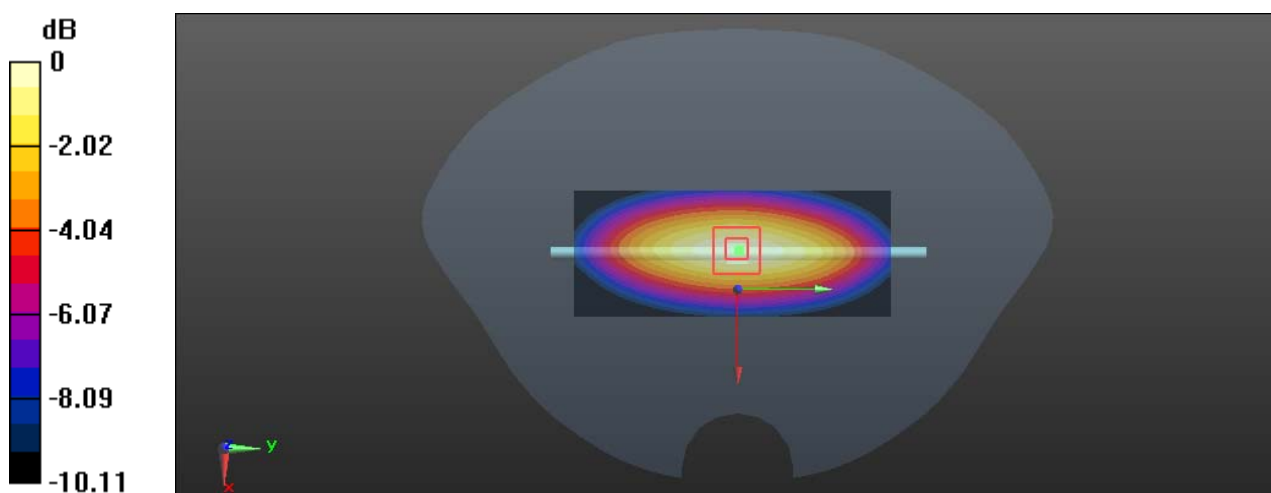

$$0 \text{ dB} = 1.22 \text{ W/kg} = 0.86 \text{ dBW/kg}$$

System Performance 750 MHz Body on 2018/01/08

DUT: D750V3; Type: 750 MHz; Serial: 1167

Communication System: CW; Frequency: 750 MHz; Duty Cycle: 1:1

Medium parameters used: $f = 750 \text{ MHz}$; $\sigma = 0.959 \text{ S/m}$; $\epsilon_r = 57.133$; $\rho = 1000 \text{ kg/m}^3$

Phantom section: Flat Section

DASY5 Configuration:

- Probe: ES3DV2 - SN3019; ConvF(6.42, 6.42, 6.42); Calibrated: 2017/10/30;
- Sensor-Surface: 4mm (Mechanical Surface Detection)
- Electronics: DAE4 Sn772; Calibrated: 2016/10/25
- Phantom: Twin SAM; Type: Twin SAM V5.0; Serial: 1412
- Measurement SW: DASY52, Version 52.8 (8);

Area Scan (41x101x1): Interpolated grid: $dx=1.500 \text{ mm}$, $dy=1.500 \text{ mm}$

Maximum value of SAR (interpolated) = 1.09 W/kg

Zoom Scan (5x5x7)/Cube 0: Measurement grid: $dx=8\text{mm}$, $dy=8\text{mm}$, $dz=5\text{mm}$

Reference Value = 31.32 V/m; Power Drift = 0.14 dB

Peak SAR (extrapolated) = 1.24 W/kg

SAR(1 g) = 0.841 W/kg; SAR(10 g) = 0.553 W/kg

Maximum value of SAR (measured) = 1.08 W/kg

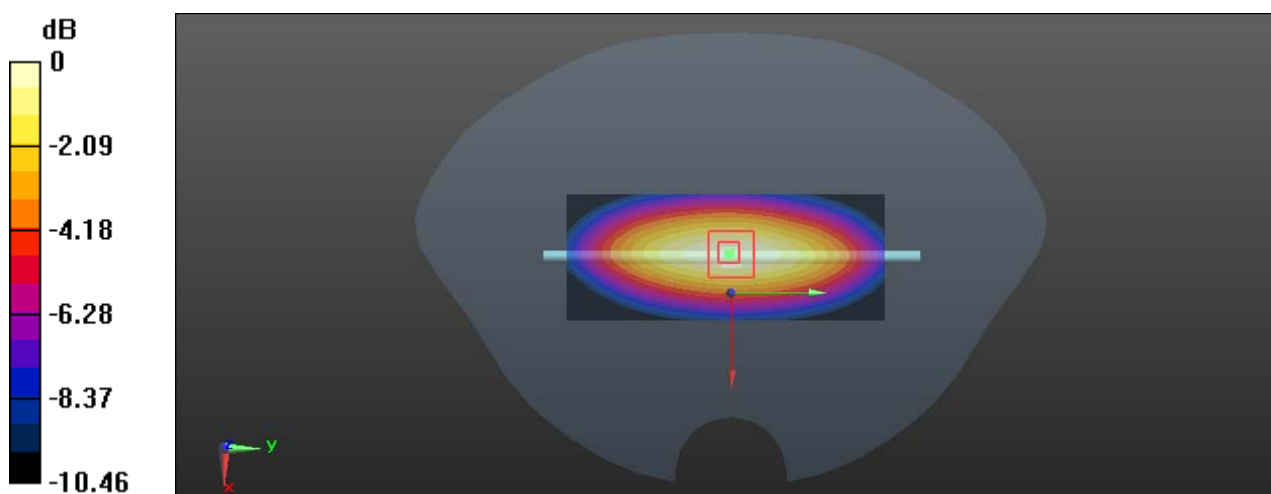

0 dB = 1.08 W/kg = 0.33 dBW/kg

System Performance 750 MHz Body on 2018/01/09

DUT: D750V3; Type: 750 MHz; Serial: 1167

Communication System: CW; Frequency: 750 MHz; Duty Cycle: 1:1

Medium parameters used: $f = 750 \text{ MHz}$; $\sigma = 0.945 \text{ S/m}$; $\epsilon_r = 57.543$; $\rho = 1000 \text{ kg/m}^3$

Phantom section: Flat Section

DASY5 Configuration:

- Probe: ES3DV2 - SN3019; ConvF(6.42, 6.42, 6.42); Calibrated: 2017/10/30;
- Sensor-Surface: 4mm (Mechanical Surface Detection)
- Electronics: DAE4 Sn772; Calibrated: 2016/10/25
- Phantom: Twin SAM; Type: Twin SAM V5.0; Serial: 1412
- Measurement SW: DASY52, Version 52.8 (8);

Area Scan (41x101x1): Interpolated grid: $dx=1.500 \text{ mm}$, $dy=1.500 \text{ mm}$

Maximum value of SAR (interpolated) = 1.36 W/kg

Zoom Scan (5x5x7)/Cube 0: Measurement grid: $dx=8\text{mm}$, $dy=8\text{mm}$, $dz=5\text{mm}$

Reference Value = 32.16 V/m; Power Drift = 0.06 dB

Peak SAR (extrapolated) = 1.51 W/kg

SAR(1 g) = 0.865 W/kg; SAR(10 g) = 0.572 W/kg

Maximum value of SAR (measured) = 1.34 W/kg

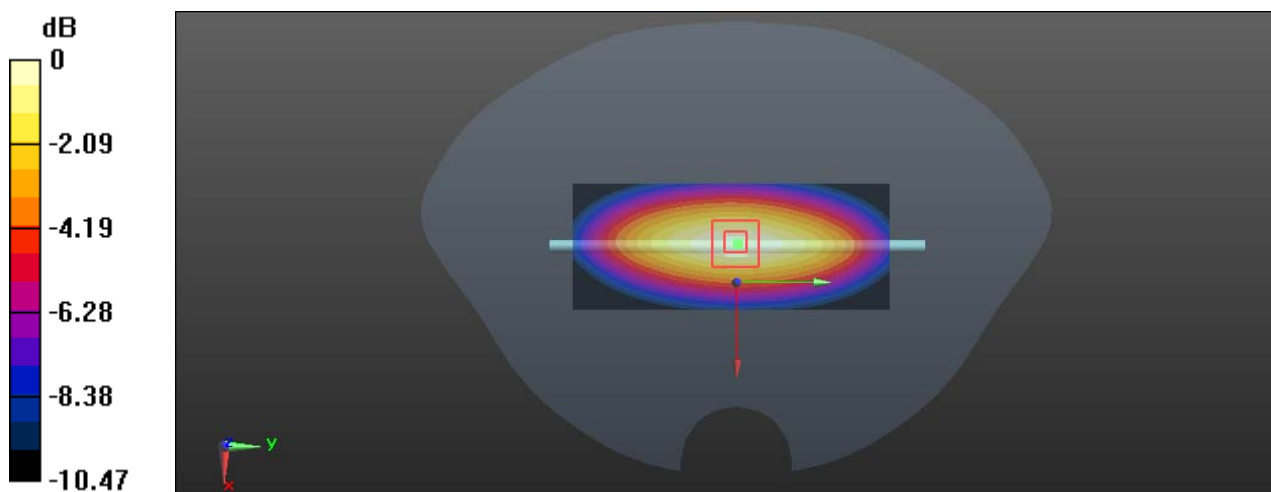

0 dB = 1.34 W/kg = 1.27 dBW/kg

System Performance 1750 MHz Body

DUT: D1750V2; Type: 1750 MHz; Serial: 1141

Communication System: CW; Frequency: 1750 MHz; Duty Cycle: 1:1
 Medium parameters used: $f = 1750 \text{ MHz}$; $\sigma = 1.543 \text{ S/m}$; $\epsilon_r = 52.611$; $\rho = 1000 \text{ kg/m}^3$
 Phantom section: Flat Section

DASY5 Configuration:

- Probe: ES3DV2 - SN3019; ConvF(4.84, 4.84, 4.84); Calibrated: 2017/10/30;
- Sensor-Surface: 4mm (Mechanical Surface Detection)
- Electronics: DAE4 Sn772; Calibrated: 2016/10/25
- Phantom: Twin SAM; Type: Twin SAM V5.0; Serial: 1412
- Measurement SW: DASY52, Version 52.8 (8);

Area Scan (41x51x1): Interpolated grid: $dx=1.500 \text{ mm}$, $dy=1.500 \text{ mm}$
 Maximum value of SAR (interpolated) = 6.11 W/kg

Zoom Scan (5x5x7)/Cube 0: Measurement grid: $dx=8\text{mm}$, $dy=8\text{mm}$, $dz=5\text{mm}$
 Reference Value = 55.69 V/m ; Power Drift = 0.05 dB
 Peak SAR (extrapolated) = 6.83 W/kg
SAR(1 g) = 3.89 W/kg ; SAR(10 g) = 2.07 W/kg
 Maximum value of SAR (measured) = 6.13 W/kg

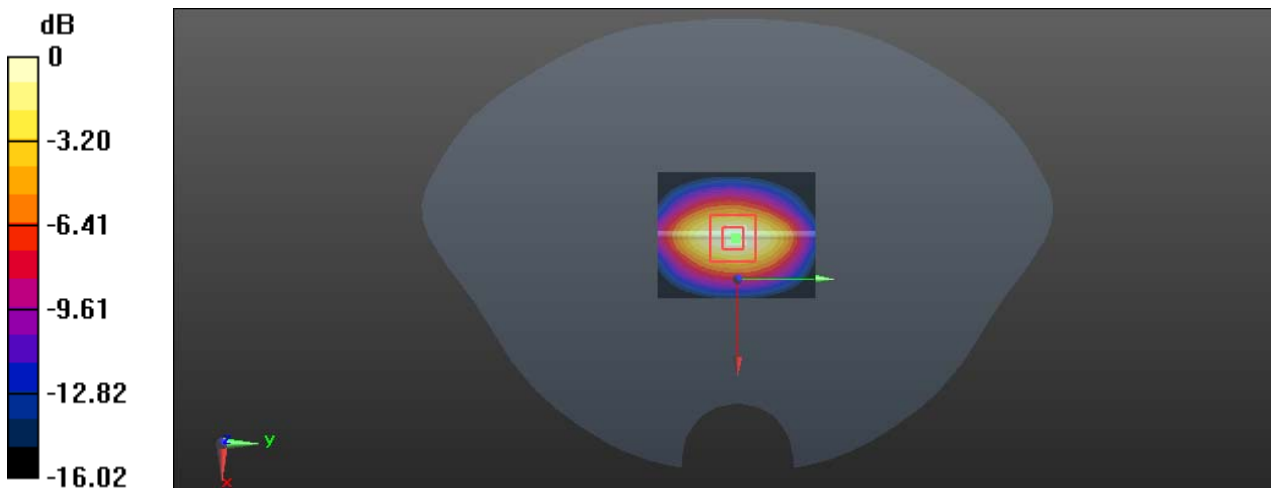

0 dB = $6.13 \text{ W/kg} = 7.87 \text{ dBW/kg}$

System Performance 1900 MHz Body on 2018/01/02

DUT: D1900V2; Type: 1900 MHz; Serial: 543

Communication System: CW; Frequency: 1900 MHz; Duty Cycle: 1:1
 Medium parameters used: $f = 1900 \text{ MHz}$; $\sigma = 1.491 \text{ S/m}$; $\epsilon_r = 54.154$; $\rho = 1000 \text{ kg/m}^3$
 Phantom section: Flat Section

DASY5 Configuration:

- Probe: ES3DV2 - SN3019; ConvF(4.65, 4.65, 4.65); Calibrated: 2017/10/30;
- Sensor-Surface: 4mm (Mechanical Surface Detection)
- Electronics: DAE4 Sn772; Calibrated: 2016/10/25
- Phantom: Twin SAM; Type: Twin SAM V5.0; Serial: 1412
- Measurement SW: DASY52, Version 52.8 (8);

Area Scan (41x51x1): Interpolated grid: $dx=1.500 \text{ mm}$, $dy=1.500 \text{ mm}$
 Maximum value of SAR (interpolated) = 6.62 W/kg

Zoom Scan (5x5x7)/Cube 0: Measurement grid: $dx=8\text{mm}$, $dy=8\text{mm}$, $dz=5\text{mm}$
 Reference Value = 56.56 V/m ; Power Drift = 0.07 dB
 Peak SAR (extrapolated) = 7.71 W/kg
SAR(1 g) = 4.23 W/kg ; SAR(10 g) = 2.27 W/kg
 Maximum value of SAR (measured) = 6.39 W/kg

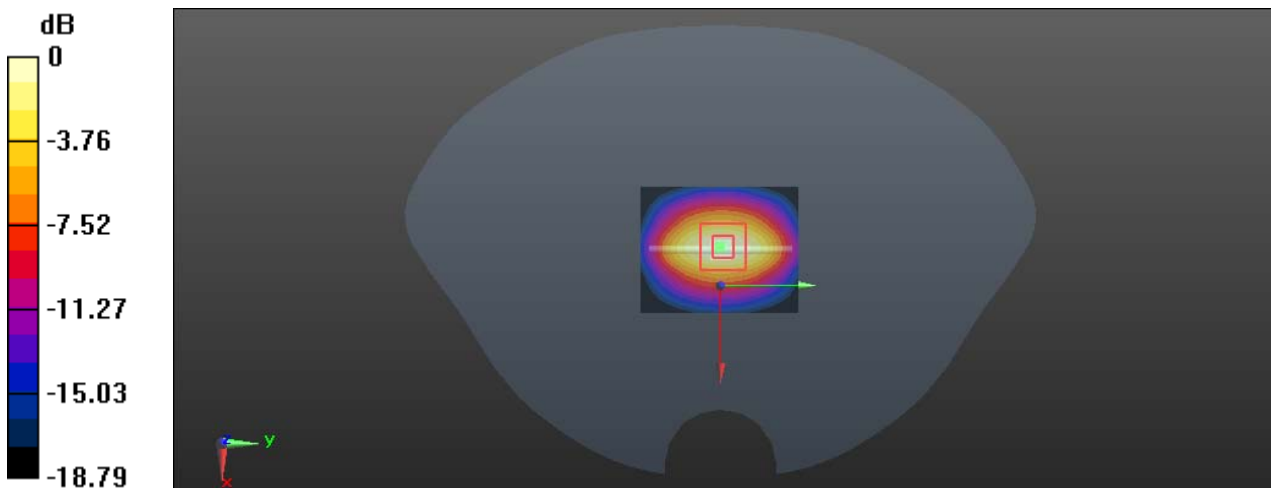

0 dB = 6.39 W/kg = 8.06 dBW/kg

System Performance 1900 MHz Body on 2018/01/03

DUT: D1900V2; Type: 1900 MHz; Serial: 543

Communication System: CW; Frequency: 1900 MHz; Duty Cycle: 1:1
 Medium parameters used: $f = 1900 \text{ MHz}$; $\sigma = 1.518 \text{ S/m}$; $\epsilon_r = 54.161$; $\rho = 1000 \text{ kg/m}^3$
 Phantom section: Flat Section

DASY5 Configuration:

- Probe: ES3DV2 - SN3019; ConvF(4.65, 4.65, 4.65); Calibrated: 2017/10/30;
- Sensor-Surface: 4mm (Mechanical Surface Detection)
- Electronics: DAE4 Sn772; Calibrated: 2016/10/25
- Phantom: Twin SAM; Type: Twin SAM V5.0; Serial: 1412
- Measurement SW: DASY52, Version 52.8 (8);

Area Scan (41x51x1): Interpolated grid: $dx=1.500 \text{ mm}$, $dy=1.500 \text{ mm}$
 Maximum value of SAR (interpolated) = 6.62 W/kg

Zoom Scan (5x5x7)/Cube 0: Measurement grid: $dx=8\text{mm}$, $dy=8\text{mm}$, $dz=5\text{mm}$
 Reference Value = 56.64 V/m ; Power Drift = 0.08 dB
 Peak SAR (extrapolated) = 7.69 W/kg
SAR(1 g) = 4.34 W/kg ; SAR(10 g) = 2.31 W/kg
 Maximum value of SAR (measured) = 6.43 W/kg

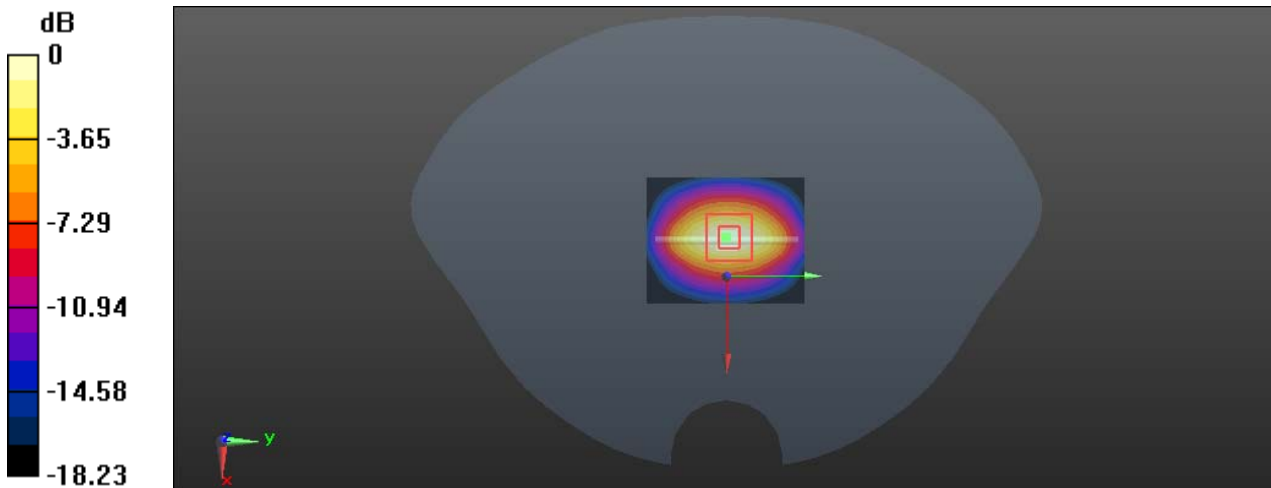

0 dB = 6.43 W/kg = 8.08 dBW/kg

System Performance 2450MHz Body

DUT: D2450V2; Type: 2450 MHz; Serial: 971

Communication System: CW; Frequency: 2450 MHz; Duty Cycle: 1:1

Medium parameters used: $f = 2450 \text{ MHz}$; $\sigma = 1.956 \text{ S/m}$; $\epsilon_r = 52.669$; $\rho = 1000 \text{ kg/m}^3$

Phantom section: Flat Section

DASY5 Configuration:

- Probe: ES3DV2 - SN3019; ConvF(4.05, 4.05, 4.05); Calibrated: 2017/10/30;
- Sensor-Surface: 4mm (Mechanical Surface Detection)
- Electronics: DAE4 Sn772; Calibrated: 2016/10/25
- Phantom: Twin SAM; Type: Twin SAM V5.0; Serial: 1412
- Measurement SW: DASY52, Version 52.8 (8);

Area Scan (51x61x1): Interpolated grid: $dx=1.200 \text{ mm}$, $dy=1.200 \text{ mm}$

Maximum value of SAR (interpolated) = 9.55 W/kg

Zoom Scan (5x5x7)/Cube 0: Measurement grid: $dx=8\text{mm}$, $dy=8\text{mm}$, $dz=5\text{mm}$

Reference Value = 55.14 V/m; Power Drift = 0.16 dB

Peak SAR (extrapolated) = 10.9 W/kg

SAR(1 g) = 5.30 W/kg; SAR(10 g) = 2.41 W/kg

Maximum value of SAR (measured) = 9.02 W/kg

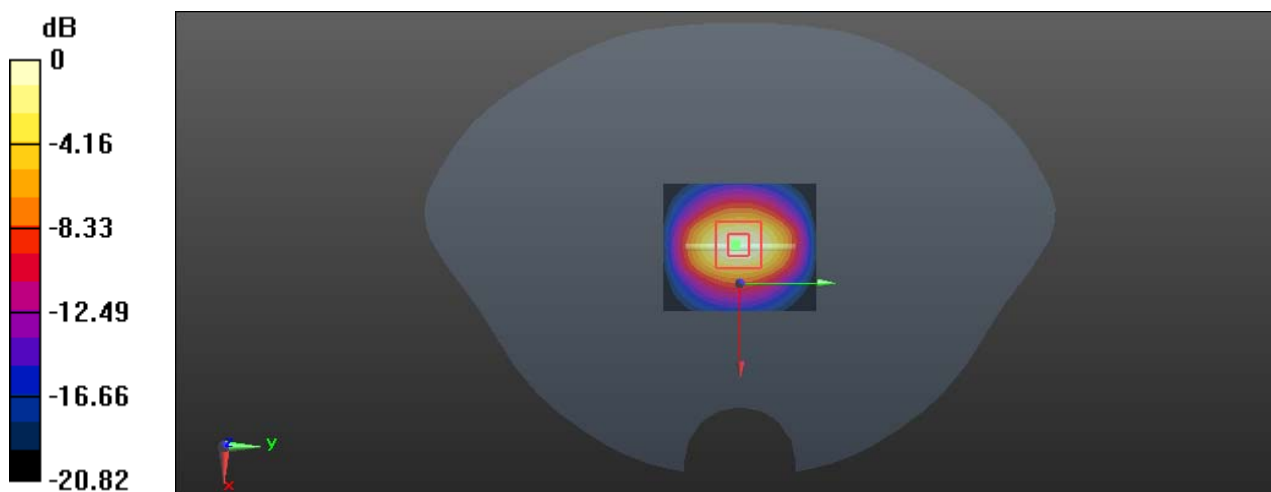

0 dB = 9.02 W/kg = 9.55 dBW/kg

System Performance 5250 MHz Body

DUT: D5GHzV2; Type: 5250 MHz; Serial: SN:1246

Communication System: CW; Frequency: 5250 MHz; Duty Cycle: 1:1

Medium parameters used: $f = 5250 \text{ MHz}$; $\sigma = 5.563 \text{ S/m}$; $\epsilon_r = 49.872$; $\rho = 1000 \text{ kg/m}^3$

Phantom section: Flat Section

DASY5 Configuration:

- Probe: EX3DV4 - SN7329; ConvF(4.84, 4.84, 4.84); Calibrated: 2017/3/13;
- Sensor-Surface: 1.4mm (Mechanical Surface Detection)
- Electronics: DAE4 Sn772; Calibrated: 2016/10/25
- Phantom: Twin SAM; Type: Twin SAM V5.0; Serial: 1412
- Measurement SW: DASY52, Version 52.8 (8);

Area Scan (31x51x1): Interpolated grid: $dx=1.000 \text{ mm}$, $dy=1.000 \text{ mm}$

Maximum value of SAR (interpolated) = 18.4 W/kg

Zoom Scan (7x7x6)/Cube 0: Measurement grid: $dx=5\text{mm}$, $dy=5\text{mm}$, $dz=2\text{mm}$

Reference Value = 37.76 V/m; Power Drift = 0.04 dB

Peak SAR (extrapolated) = 27.8 W/kg

SAR(1 g) = 7.59 W/kg; SAR(10 g) = 2.11 W/kg

Maximum value of SAR (measured) = 17.7 W/kg

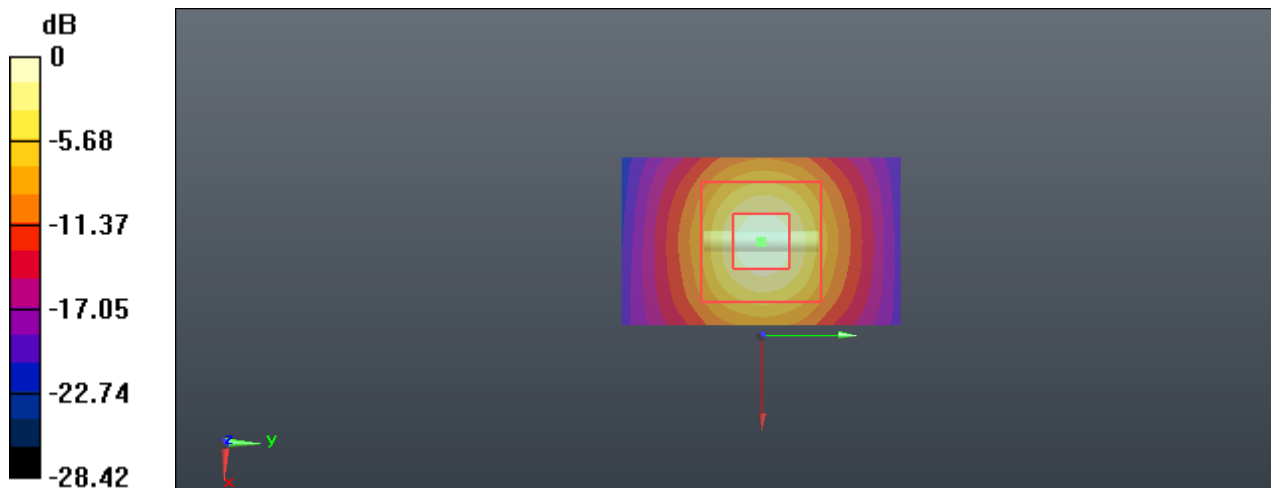

0 dB = 17.7 W/kg = 12.48 dBW/kg

System Performance 5600 MHz Body

DUT: D5GHzV2; Type: 5600 MHz; Serial: SN:1246

Communication System: CW; Frequency: 5600 MHz; Duty Cycle: 1:1

Medium parameters used: $f = 5600 \text{ MHz}$; $\sigma = 5.649 \text{ S/m}$; $\epsilon_r = 48.506$; $\rho = 1000 \text{ kg/m}^3$

Phantom section: Flat Section

DASY5 Configuration:

- Probe: EX3DV4 - SN7329; ConvF(4.12, 4.12, 4.12); Calibrated: 2017/3/13;
- Sensor-Surface: 1.4mm (Mechanical Surface Detection)
- Electronics: DAE4 Sn772; Calibrated: 2016/10/25
- Phantom: Twin SAM; Type: Twin SAM V5.0; Serial: 1412
- Measurement SW: DASY52, Version 52.8 (8);

Area Scan (31x51x1): Interpolated grid: $dx=1.000 \text{ mm}$, $dy=1.000 \text{ mm}$

Maximum value of SAR (interpolated) = 20.6 W/kg

Zoom Scan (7x7x6)/Cube 0: Measurement grid: $dx=5\text{mm}$, $dy=5\text{mm}$, $dz=2\text{mm}$

Reference Value = 40.16 V/m; Power Drift = 0.02 dB

Peak SAR (extrapolated) = 31.7 W/kg

SAR(1 g) = 8.01 W/kg; SAR(10 g) = 2.28 W/kg

Maximum value of SAR (measured) = 20.5 W/kg

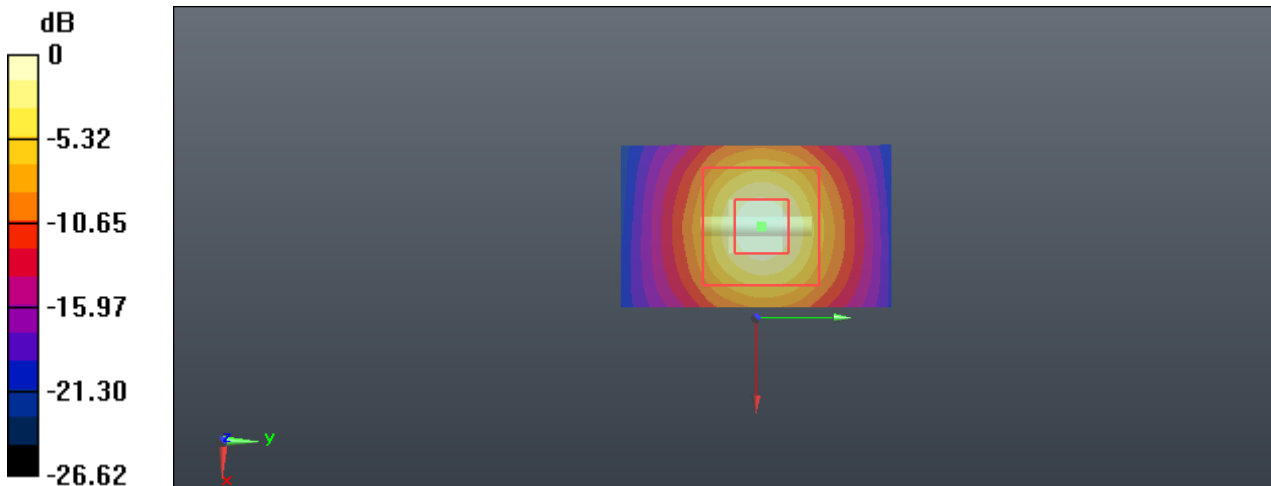

0 dB = 20.5 W/kg = 13.12 dBW/kg

System Performance 5800 MHz Body

DUT: D5GHzV2; Type: 5800 MHz; Serial: SN:1246

Communication System: CW; Frequency: 5800 MHz; Duty Cycle: 1:1

Medium parameters used: $f = 5800 \text{ MHz}$; $\sigma = 5.902 \text{ S/m}$; $\epsilon_r = 48.981$; $\rho = 1000 \text{ kg/m}^3$

Phantom section: Flat Section

DASY5 Configuration:

- Probe: EX3DV4 - SN7329; ConvF(4.48, 4.48, 4.48); Calibrated: 2017/3/13;
- Sensor-Surface: 1.4mm (Mechanical Surface Detection)
- Electronics: DAE4 Sn772; Calibrated: 2016/10/25
- Phantom: Twin SAM; Type: Twin SAM V5.0; Serial: 1412
- Measurement SW: DASY52, Version 52.8 (8);

Area Scan (31x51x1): Interpolated grid: $dx=1.000 \text{ mm}$, $dy=1.000 \text{ mm}$

Maximum value of SAR (interpolated) = 19.9 W/kg

Zoom Scan (7x7x6)/Cube 0: Measurement grid: $dx=5\text{mm}$, $dy=5\text{mm}$, $dz=2\text{mm}$

Reference Value = 36.46 V/m; Power Drift = -0.02 dB

Peak SAR (extrapolated) = 30.3 W/kg

SAR(1 g) = 7.67 W/kg; SAR(10 g) = 2.24 W/kg

Maximum value of SAR (measured) = 19.8 W/kg

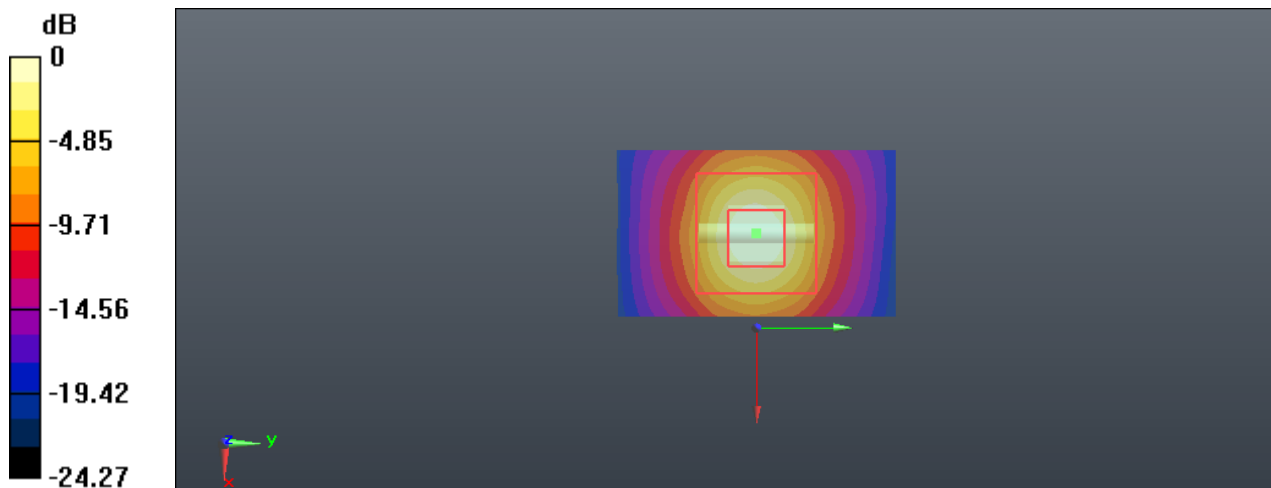

0 dB = 19.8 W/kg = 12.97 dBW/kg

EUT TEST STRATEGY AND METHODOLOGY

Test Positions for Device Operating Next to a Person’s Ear

This category includes most wireless handsets with fixed, retractable or internal antennas located toward the top half of the device, with or without a foldout, sliding or similar keypad cover. The handset should have its earpiece located within the upper ¼ of the device, either along the centerline or off-centered, as perceived by its users. This type of handset should be positioned in a normal operating position with the “test device reference point” located along the “vertical centerline” on the front of the device aligned to the “ear reference point”. The “test device reference point” should be located at the same level as the center of the earpiece region. The “vertical centerline” should bisect the front surface of the handset at its top and bottom edges. A “ear reference point” is located on the outer surface of the head phantom on each ear spacer. It is located 1.5 cm above the center of the ear canal entrance in the “phantom reference plane” defined by the three lines joining the center of each “ear reference point” (left and right) and the tip of the mouth.

A handset should be initially positioned with the earpiece region pressed against the ear spacer of a head phantom. For the SCC-34/SC-2 head phantom, the device should be positioned parallel to the “N-F” line defined along the base of the ear spacer that contains the “ear reference point”. For interim head phantoms, the device should be positioned parallel to the cheek for maximum RF energy coupling. The “test device reference point” is aligned to the “ear reference point” on the head phantom and the “vertical centerline” is aligned to the “phantom reference plane”. This is called the “initial ear position”. While maintaining these three alignments, the body of the handset is gradually adjusted to each of the following positions for evaluating SAR:

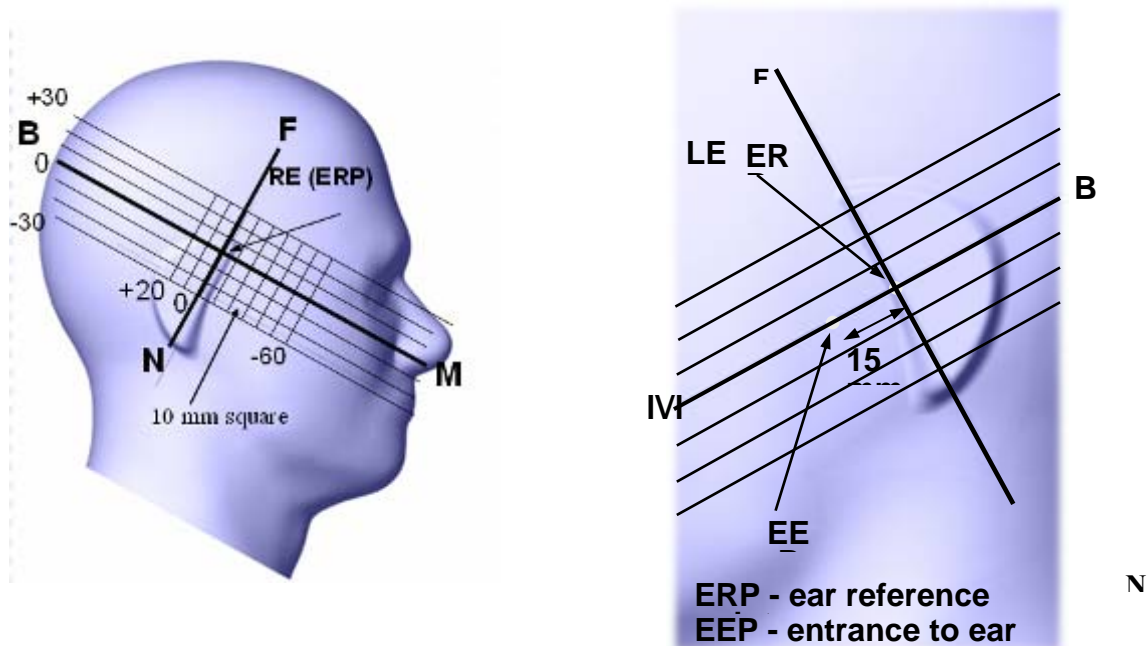

Cheek/Touch Position

The device is brought toward the mouth of the head phantom by pivoting against the “ear reference point” or along the “N-F” line for the SCC-34/SC-2 head phantom.

This test position is established:

When any point on the display, keypad or mouthpiece portions of the handset is in contact with the phantom.

(or) When any portion of a foldout, sliding or similar keypad cover opened to its intended self-adjusting normal use position is in contact with the cheek or mouth of the phantom.

For existing head phantoms – when the handset loses contact with the phantom at the pivoting point, rotation should continue until the device touches the cheek of the phantom or breaks its last contact from the ear spacer.

Cheek /Touch Position



Ear/Tilt Position

With the handset aligned in the “Cheek/Touch Position”:

1) If the earpiece of the handset is not in full contact with the phantom’s ear spacer (in the “Cheek/Touch position”) and the peak SAR location for the “Cheek/Touch” position is located at the ear spacer region or corresponds to the earpiece region of the handset, the device should be returned to the “initial ear position” by rotating it away from the mouth until the earpiece is in full contact with the ear spacer.

2) (otherwise) The handset should be moved (translated) away from the cheek perpendicular to the line passes through both “ear reference points” (note: one of these ear reference points may not physically exist on a split head model) for approximate 2-3 cm. While it is in this position, the device handset is tilted away from the mouth with respect to the “test device reference point” until the inside angle between the vertical centerline on the front surface of the phone and the horizontal line passing through the ear reference point is by 15° to 80° . After the tilt, it is then moved (translated) back toward the head perpendicular to the line passes through both “ear reference points” until the device touches the phantom or the ear spacer. If the antenna touches the head first, the positioning process should be repeated with a tilt angle less than 15° so that the device and its antenna would touch the phantom simultaneously. This test position may require a device holder or positioner to achieve the translation and tilting with acceptable positioning repeatability.

If a device is also designed to transmit with its keypad cover closed for operating in the head position, such positions should also be considered in the SAR evaluation. The device should be tested on the left and right side of the head phantom in the “Cheek/Touch” and “Ear/Tilt” positions. When applicable, each configuration should be tested with the antenna in its fully extended and fully retracted positions. These test configurations should be tested at the high, middle and low frequency channels of each operating mode; for example, AMPS, CDMA, and TDMA. If the SAR measured at the middle channel for each test configuration (left, right, Cheek/Touch, Tilt/Ear, extended and retracted) is at least 2.0 dB lower than the SAR limit, testing at the high and low channels is optional for such test configuration(s). If the transmission band of the test device is less than 10 MHz, testing at the high and low frequency channels is optional.

Ear /Tilt 15° Position

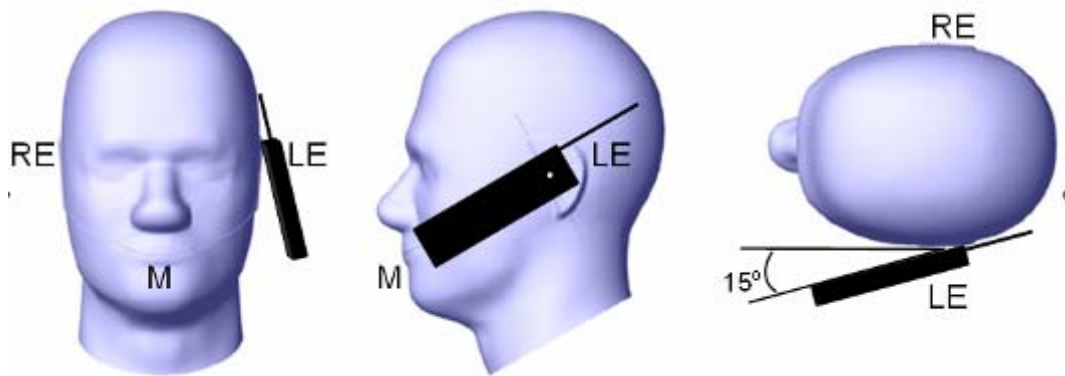

Test positions for body-worn and other configurations

Body-worn operating configurations should be tested with the belt-clips and holsters attached to the device and positioned against a flat phantom in normal use configurations. Devices with a headset output should be tested with a headset connected to the device. When multiple accessories that do not contain metallic components are supplied with the device, the device may be tested with only the accessory that dictates the closest spacing to the body. When multiple accessories that contain metallic components are supplied with the device, the device must be tested with each accessory that contains a unique metallic component. If multiple accessories share an identical metallic component (e.g., the same metallic belt-clip used with different holsters with no other metallic components), only the accessory that dictates the closest spacing to the body must be tested.

Body-worn accessories may not always be supplied or available as options for some devices that are intended to be authorized for body-worn use. A separation distance of 1.5 cm between the back of the device and a flat phantom is recommended for testing body-worn SAR compliance under such circumstances. Other separation distances may be used, but they should not exceed 2.5 cm. In these cases, the device may use body-worn accessories that provide a separation distance greater than that tested for the device provided however that the accessory contains no metallic components.

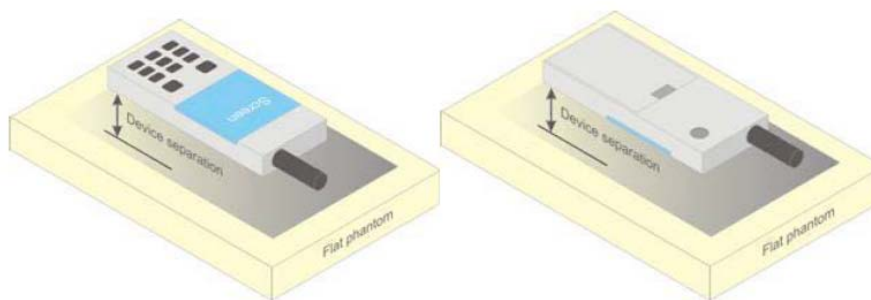

Figure 5 – Test positions for body-worn devices

Test Distance for SAR Evaluation

For the case the EUT(Equipment Under Test) is set directly against the phantom, the test distance is 0mm.

SAR Evaluation Procedure

The evaluation was performed with the following procedure:

Step 1: Measurement of the SAR value at a fixed location above the ear point or central position was used as a reference value for assessing the power drop. The SAR at this point is measured at the start of the test and then again at the end of the testing.

Step 2: The SAR distribution at the exposed side of the head was measured at a distance of 4 mm from the inner surface of the shell. The area covered the entire dimension of the head or radiating structures of the EUT, the horizontal grid spacing was 15 mm x 15 mm, and the SAR distribution was determined by integrated grid of 1.5mm x 1.5mm. Based on these data, the area of the maximum absorption was determined by spline interpolation. The first Area Scan covers the entire dimension of the EUT to ensure that the hotspot was correctly identified.

Step 3: Around this point, a volume of 30 mm x 30 mm x 30 mm was assessed by measuring 7x 7 x 7 points. On the basis of this data set, the spatial peak SAR value was evaluated under the following procedure:

- 1) The data at the surface were extrapolated, since the center of the dipoles is 1.2 mm away from the tip of the probe and the distance between the surface and the lowest measuring point is 1.3 mm. The extrapolation was based on a least square algorithm. A polynomial of the fourth order was calculated through the points in z-axes. This polynomial was then used to evaluate the points between the surface and the probe tip.

- 2) The maximum interpolated value was searched with a straightforward algorithm. Around this maximum the SAR values averaged over the spatial volumes (1 g or 10 g) were computed by the 3D-Spline interpolation algorithm. The 3D-Spline is composed of three one dimensional splines with the "Not a knot"-condition (in x, y and z-directions). The volume was integrated with the trapezoidal-algorithm. One thousand points (10 x 10 x 10) were interpolated to calculate the averages.

All neighboring volumes were evaluated until no neighboring volume with a higher average value was found.

Step 4: Re-measurement of the SAR value at the same location as in Step 1. If the value changed by more than 5%, the evaluation was repeated.

CONDUCTED OUTPUT POWER MEASUREMENT

Provision Applicable

The measured peak output power should be greater and within 5% than EMI measurement.

Test Procedure

The RF output of the transmitter was connected to the input of the EMI Test Receiver through Combiner.

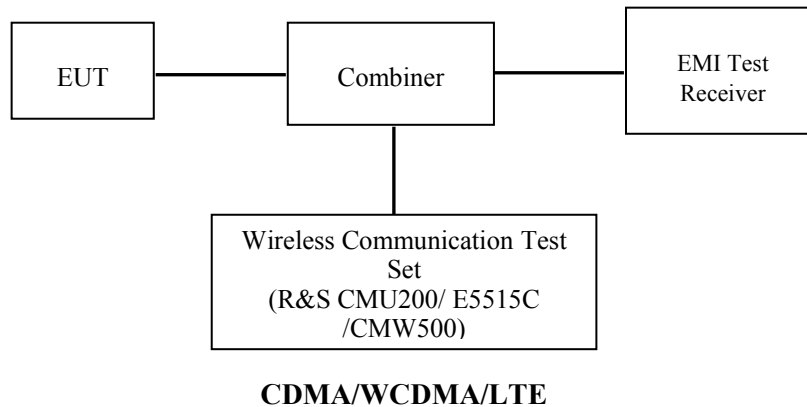

Radio Configuration

The power measurement was configured by the Wireless Communication Test Set E5515C for WCDMA Band and Wideband Radio Communication Tester CMW500 for LTE Band.

CDMA 1x RTT

Maximum output power is verified on the high, middle and low channels according to procedures in section 4.4.5.2 of 3GPP2 C.S0011/TIA-98-E. Steps 3 and 4 are measured using Loopback Service Option SO55 with power control bits in “All Up” condition. Step 10 is measured using TDSO/SO32 with power control bits in the “Bits Hold” condition (i.e. alternative Up/Down Bits).

Table 4.4.5.2-1. Test Parameters for Maximum RF Output Power with a Single Traffic Code Channel, Spreading Rate 1

Parameter	Units	Value
I_{or}	dBm/1.23 MHz	-104
$\frac{\text{Pilot } E_c}{I_{or}}$	dB	-7
$\frac{\text{Traffic } E_c}{I_{or}}$	dB	-7.4

Table 4.4.5.2-2. Test Parameters for Maximum RF Output Power with Multiple Traffic Code Channels, Spreading Rate 1

Parameter	Units	Value
$\frac{\text{Pilot } E_c}{I_{or}}$	dB	-7
$\frac{\text{Traffic } E_c}{I_{or}}$	dB	-7.4

EVDO

Maximum output power is verified on the high, middle and low channels according to procedures in section 3.1.2.3.4 of 3GPP2 C.S0033-0/TIA-866 for Rev. 0, section 4.3.4 of 3GPP2 C.S0033-A for Rev. A.

Maximum output power is measured for Rev. 0 and Rev. A in Subtype 0/1 and Subtype 2 Physical Layer configurations, respectively.

WCDMA Release 99

The following tests were conducted according to the test requirements outlines in section 5.2 of the 3GPP TS34.121-1 specification. The EUT has a nominal maximum output power of 24dBm (+1.7/-3.7).

WCDMA General Settings	Loopback Mode	Test Mode 1
	Rel99 RMC	12.2kbps RMC
	Power Control Algorithm	Algorithm2
	β_c/β_d	8/15

HSDPA

The following tests were conducted according to the test requirements outlines in section 5.2 of the 3GPP TS34.121-1 specification.

	Mode	HSDPA	HSDPA	HSDPA	HSDPA
	Subset	1	2	3	4
WCDMA General Settings	Loopback Mode	Test Mode 1			
	Rel99 RMC	12.2kbps RMC			
	HSDPA FRC	H-Set1			
	Power Control Algorithm	Algorithm2			
	β_c	2/15	12/15	15/15	15/15
	β_d	15/15	15/15	8/15	4/15
	$\beta_d(SF)$	64			
	β_c/β_d	2/15	12/15	15/8	15/4
	β_{hs}	4/15	24/15	30/15	30/15
	MPR(dB)	0	0	0.5	0.5
HSDPA Specific Settings	DACK	8			
	DNAK	8			
	DCQI	8			
	Ack-Nack repetition factor	3			
	CQI Feedback	4ms			
	CQI Repetition Factor	2			
	A _{hs} = β_{hs}/β_c	30/15			

HSUPA

The following tests were conducted according to the test requirements outlines in section 5.2 of the 3GPP TS34.121-1 specification.

	Mode	HSUPA	HSUPA	HSUPA	HSUPA	HSUPA
	Subset	1	2	3	4	5
WCDMA General Settings	Loopback Mode	Test Mode 1				
	Rel99 RMC	12.2kbps RMC				
	HSDPA FRC	H-Set1				
	HSUPA Test	HSUPA Loopback				
	Power Control Algorithm	Algorithm2				
	β_c	11/15	6/15	15/15	2/15	15/15
	β_d	15/15	15/15	9/15	15/15	0
	β_{cc}	209/225	12/15	30/15	2/15	5/15
	β_c / β_d	11/15	6/15	15/9	2/15	-
	β_{hs}	22/15	12/15	30/15	4/15	5/15
	CM(dB)	1.0	3.0	2.0	3.0	1.0
MPR(dB)	0	2	1	2	0	
HSDPA Specific Settings	DACK	8				
	DNAK	8				
	DCQI	8				
	Ack-Nack repetition factor	3				
	CQI Feedback	4ms				
	CQI Repetition Factor	2				
	$A_{hs} = \beta_{hs} / \beta_c$	30/15				
HSUPA Specific Settings	DE-DPCCH	6	8	8	5	7
	DHARQ	0	0	0	0	0
	AG Index	20	12	15	17	21
	ETFCI	75	67	92	71	81
	Associated Max UL Data Rate kbps	242.1	174.9	482.8	205.8	308.9
	Reference E_FCIs	E-TFCI 11 E E-TFCI PO 4 E-TFCI 67 E-TFCI PO 18 E-TFCI 71 E-TFCI PO23 E-TFCI 75 E-TFCI PO26 E-TFCI 81 E-TFCI PO 27	E-TFCI 11 E-TFCI PO4 E-TFCI 92 E-TFCI PO 18	E-TFCI 11 E-TFCI PO4 E-TFCI 71 E-TFCI 92 E-TFCI PO 18	E-TFCI 11 E E-TFCI PO 4 E-TFCI 67 E-TFCI PO 18 E-TFCI 71 E-TFCI PO23 E-TFCI 75 E-TFCI PO26 E-TFCI 81 E-TFCI PO 27	

HSPA+

Sub-test	β_c (Note3)	β_d	β_{HS} (Note1)	β_{ec}	β_{ed} (2xSF2) (Note 4)	β_{ed} (2xSF4) (Note 4)	CM (dB) (Note 2)	MPR (dB) (Note 2)	AG Index (Note 4)	E-TFCI (Note 5)	E-TFCI (boost)
1	1	0	30/15	30/15	β_{ed1} : 30/15 β_{ed2} : 30/15	β_{ed3} : 24/15 β_{ed4} : 24/15	3.5	2.5	14	105	105

Note 1: $\Delta_{ACK}, \Delta_{NACK}$ and $\Delta_{CQI} = 30/15$ with $\beta_{hs} = 30/15 * \beta_c$.

Note 2: CM = 3.5 and the MPR is based on the relative CM difference, MPR = MAX(CM-1,0).

Note 3: DPDCH is not configured, therefore the β_c is set to 1 and $\beta_d = 0$ by default.

Note 4: β_{ed} can not be set directly; it is set by Absolute Grant Value.

Note 5: All the sub-tests require the UE to transmit 2SF2+2SF4 16QAM EDCH and they apply for UE using E-DPDCH category 7. E-DCH TTI is set to 2ms TTI and E-DCH table index = 2. To support these E-DCH configurations DPDCH is not allocated. The UE is signalled to use the extrapolation algorithm.

The following tests were conducted according to the test requirements in Table C.11.1.4 of 3GPP TS 34.121-1

DC-HSDPA

The following tests were conducted according to the test requirements in Table C.8.1.12 of 3GPP TS 34.121-1

Table C.8.1.12: Fixed Reference Channel H-Set 12

Parameter	Unit	Value
Nominal Avg. Inf. Bit Rate	kbps	60
Inter-TTI Distance	TTI's	1
Number of HARQ Processes	Processes	6
Information Bit Payload (N_{INF})	Bits	120
Number Code Blocks	Blocks	1
Binary Channel Bits Per TTI	Bits	960
Total Available SML's in UE	SML's	19200
Number of SML's per HARQ Proc.	SML's	3200
Coding Rate		0.15
Number of Physical Channel Codes	Codes	1
Modulation		QPSK
<p>Note 1: The RMC is intended to be used for DC-HSDPA mode and both cells shall transmit with identical parameters as listed in the table.</p> <p>Note 2: Maximum number of transmission is limited to 1, i.e., retransmission is not allowed. The redundancy and constellation version 0 shall be used.</p>		

LTE

For UE Power Class 1 and 3, the allowed Maximum Power Reduction (MPR) for the maximum output power in Table 6.2.2-1 due to higher order modulation and transmit bandwidth configuration (resource blocks) is specified in Table 6.2.3-1.

Table 6.2.3-1: Maximum Power Reduction (MPR) for Power Class 1 and 3

Modulation	Channel bandwidth / Transmission bandwidth (N_{RB})						MPR (dB)
	1.4 MHz	3.0 MHz	5 MHz	10 MHz	15 MHz	20 MHz	
QPSK	> 5	> 4	> 8	> 12	> 16	> 18	≤ 1
16 QAM	≤ 5	≤ 4	≤ 8	≤ 12	≤ 16	≤ 18	≤ 1
16 QAM	> 5	> 4	> 8	> 12	> 16	> 18	≤ 2

For UE Power Class 1 and 3 the specific requirements and identified subclauses are specified in Table 6.2.4-1 along with the allowed A-MPR values that may be used to meet these requirements. The allowed A-MPR values specified below in Table 6.2.4.-1 to 6.2.4-15 are in addition to the allowed MPR requirements specified in sub-clause 6.2.3.

Table 6.2.4-1: Additional Maximum Power Reduction (A-MPR)

Network Signalling value	Requirements (subclause)	E-UTRA Band	Channel bandwidth (MHz)	Resources Blocks (N_{RB})	A-MPR (dB)
NS_01	6.6.2.1.1	Table 5.5-1	1.4, 3, 5, 10, 15, 20	Table 5.6-1	N/A
NS_03	6.6.2.2.1	2, 4, 10, 23, 25, 35, 36	3	>5	≤ 1
			5	>6	≤ 1
			10	>6	≤ 1
			15	>8	≤ 1
			20	>10	≤ 1
NS_04	6.6.2.2.2	41	5	>6	≤ 1
			10, 15, 20	Table 6.2.4-4	
NS_05	6.6.3.3.1	1	10, 15, 20	≥ 50	≤ 1
NS_06	6.6.2.2.3	12, 13, 14, 17	1.4, 3, 5, 10	Table 5.6-1	N/A
NS_07	6.6.2.2.3	13	10	Table 6.2.4-2	
	6.6.3.3.2				
NS_08	6.6.3.3.3	19	10, 15	> 44	≤ 3
NS_09	6.6.3.3.4	21	10, 15	> 40	≤ 1
				> 55	≤ 2
				Table 6.2.4-3	
NS_11	6.6.2.2.1	23	1.4, 3, 5, 10, 15, 20	Table 6.2.4-5	
NS_12	6.6.3.3.5	26	1.4, 3, 5	Table 6.2.4-6	
NS_13	6.6.3.3.6	26	5	Table 6.2.4-7	
NS_14	6.6.3.3.7	26	10, 15	Table 6.2.4-8	
NS_15	6.6.3.3.8	26	1.4, 3, 5, 10, 15	Table 6.2.4-9	
				Table 6.2.4-10	
NS_16	6.6.3.3.9	27	3, 5, 10	Table 6.2.4-11, Table 6.2.4-12, Table 6.2.4-13	
NS_17	6.6.3.3.10	28	5, 10	Table 5.6-1	N/A
NS_18	6.6.3.3.11	28	5	≥ 2	≤ 1
			10, 15, 20	≥ 1	≤ 4
NS_19	6.6.3.3.12	44	10, 15, 20	Table 6.2.4-14	
NS_20	6.2.2	23	5, 10, 15, 20	Table 6.2.4-15	
	6.6.2.2.1				
	6.6.3.2				
...					
NS_32	-	-	-	-	-

Maximum Target Output Power

Maximum Target Output Power (dBm)				
Mode/Band		Low Channel	Middle Channel	High Channel
P-Sensor NOT Triggered	CDMA 850(CDMA 1x RTT)	24	24	24
	CDMA 1900(CDMA 1x RTT)	23.8	23.8	23.8
	CDMA 850(EVDO)	24.3	24.3	24.3
	CDMA 1900(EVDO)	24	24	24
	WCDMA Band 2	23	23	23
	HSDPA	22.5	22.5	22.5
	HSUPA	21.9	21.9	21.9
	DC-HSDPA	22.1	22.1	22.1
	HSPA+	21.8	21.8	21.8
	WCDMA Band 5	23	23	23
	HSDPA	22.9	22.9	22.9
	HSUPA	22.3	22.3	22.3
	DC-HSDPA	22.2	22.2	22.2
	HSPA+	21.9	21.9	21.9
	LTE Band 2	23.9	23.9	23.9
	LTE Band 4	23.8	23.8	23.8
	LTE Band 5	24.4	24.4	24.4
	LTE Band 13	24.1	24.1	24.1
	LTE Band 17	24	24	24
P-Sensor Triggered	CDMA 850(CDMA 1x RTT)	19.2	19.2	19.2
	CDMA 1900(CDMA 1x RTT)	19	19	19
	CDMA 850(EVDO)	19.5	19.5	19.5
	CDMA 1900(EVDO)	19.2	19.2	19.2
	WCDMA Band 2	18.2	18.2	18.2
	HSDPA	17.7	17.7	17.7
	HSUPA	17.1	17.1	17.1
	DC-HSDPA	17.3	17.3	17.3
	HSPA+	17	17	17
	WCDMA Band 5	18.2	18.2	18.2
	HSDPA	18.1	18.1	18.1
	HSUPA	17.5	17.5	17.5
	DC-HSDPA	17.4	17.4	17.4
	HSPA+	17.1	17.1	17.1
	LTE Band 2	19.1	19.1	19.1
	LTE Band 4	19	19	19
	LTE Band 5	19.4	19.4	19.4
	LTE Band 13	19.3	19.3	19.3
	LTE Band 17	19.2	19.2	19.2

Maximum Target Output Power (dBm)				
Mode/Band		Low Channel	Middle Channel	High Channel
WLAN 2.4G SISO Chain 0(Main)	802.11b	20	20	20
	802.11g	18.5	18.5	18.5
	802.11n HT20	19	19	19
	802.11n HT40	17.6	17.6	17.6
WLAN 2.4G SISO Chain 1(Aux)	802.11b	20	20	20
	802.11g	17.5	17.5	17.5
	802.11n HT20	18	18	18
	802.11n HT40	18	18	18
WLAN 2.4G MIMO Chain 0(Main)	802.11n HT20	15.6	15.6	15.6
	802.11n HT40	15	15.6	15
WLAN 2.4G MIMO Chain 1(AUX)	802.11n HT20	15.5	15.5	15.5
	802.11n HT40	16	17	16
WLAN 5.2G SISO Chain 0 (Main)	802.11 a	14.8	14.8	14.8
	802.11 n20	14.5	14.5	14.5
	802.11 n40	13.8	/	13.8
	802.11 ac20	14.5	14.5	14.5
	802.11 ac40	14	/	14
	802.11 ac80	/	11.5	/
WLAN 5.2G SISO Chain 1 (Aux)	802.11 a	14.8	14.8	14.8
	802.11 n20	14	14	14
	802.11 n40	14	/	14
	802.11 ac20	14	14	14
	802.11 ac40	14	/	14
	802.11 ac80	/	12	/
WLAN 5.3G SISO Chain 0(Main)	802.11 a	14.3	14.3	14.3
	802.11 n20	14	14	14
	802.11 n40	13.5	/	13.5
	802.11 ac20	13.8	13.8	13.8
	802.11 ac40	13.6	/	13.6
	802.11 ac80	/	11.6	/
WLAN 5.3G SISO Chain 1(Aux)	802.11 a	14.7	14.7	14.7
	802.11 n20	14	14	14
	802.11 n40	13.5	/	13.5
	802.11 ac20	13.7	13.7	13.7
	802.11 ac40	13.5	/	13.5
	802.11 ac80	/	11.6	/

Maximum Target Output Power (dBm)				
Mode/Band		Low Channel	Middle Channel	High Channel
WLAN 5.6G SISO Chain 0(Main)	802.11 a	14.8	14.8	14.8
	802.11 n20	14	14	14
	802.11 n40	14.2	14.2	14.2
	802.11 ac20	14	14	14
	802.11 ac40	14	14	14
	802.11 ac80	12.1	12.1	12.1
WLAN 5.6G SISO Chain 1(Aux)	802.11 a	14.7	14.7	14.7
	802.11 n20	14	14	14
	802.11 n40	14	14	14
	802.11 ac20	14	14	14
	802.11 ac40	14	14	14
	802.11 ac80	11.6	11.6	11.6
WLAN 5.8G SISO Chain 0(Main)	802.11 a	14.7	14.7	14.7
	802.11 n20	14.2	14.2	14.2
	802.11 n40	14.1	/	14.1
	802.11 ac20	14	14	14
	802.11 ac40	14.2	/	14.2
	802.11 ac80	/	12.3	/
WLAN 5.8G SISO Chain 1(Aux)	802.11 a	14.5	14.5	14.5
	802.11 n20	14	14	14
	802.11 n40	13.7	/	13.7
	802.11 ac20	13.8	13.8	13.8
	802.11 ac40	13.7	/	13.7
	802.11 ac80	/	11.6	/

Maximum Target Output Power (dBm)				
Mode/Band		Low Channel	Middle Channel	High Channel
WLAN 5.2G MIMO Chain 0(Main)	802.11 n20	11	11	11
	802.11 n40	6	/	11
	802.11 ac20	11	11	11
	802.11 ac40	6	/	11
	802.11 ac80	/	9	/
WLAN 5.2G MIMO Chain 1(Aux)	802.11 n20	11	11	11
	802.11 n40	6	/	11
	802.11 ac20	10.8	10.8	10.8
	802.11 ac40	6	/	11
	802.11 ac80	/	9	/
WLAN 5.3G MIMO Chain 0(Main)	802.11 n20	11	11	11
	802.11 n40	11.5	/	11.5
	802.11 ac20	11	11	11
	802.11 ac40	11	11	11
	802.11 ac80	/	9	/
WLAN 5.3G MIMO Chain 1(Aux)	802.11 n20	10.8	10.8	10.8
	802.11 n40	10.7	/	10.7
	802.11 ac20	10.6	10.6	10.6
	802.11 ac40	10.7	/	10.7
	802.11 ac80	/	9	/
WLAN 5.6G MIMO Chain 0(Main)	802.11 n20	11.5	11.5	11.5
	802.11 n40	10.8	10.8	10.8
	802.11 ac20	11.3	11.3	11.3
	802.11 ac40	10.8	10.8	10.8
	802.11 ac80	9	9	9
WLAN 5.6G MIMO Chain 1(Aux)	802.11 n20	11	11	11
	802.11 n40	10.6	10.6	10.6
	802.11 ac20	10.8	10.8	10.8
	802.11 ac40	10.7	10.7	10.7
	802.11 ac80	8.6	8.6	8.6
WLAN 5.8G MIMO Chain 0(Main)	802.11 n20	11.2	11.2	11.2
	802.11 n40	11	/	11
	802.11 ac20	11.2	11.2	11.2
	802.11 ac40	11	/	11
	802.11 ac80	/	9	/
WLAN 5.8G MIMO Chain 1(Aux)	802.11 n20	11	11	11
	802.11 n40	10.8	/	10.8
	802.11 ac20	10.8	10.8	10.8
	802.11 ac40	10.8	/	10.8
	802.11 ac80	/	9	/
Bluetooth BDR/EDR		6	6	6
Bluetooth LE		-1	-1	-1

Note: The device employed a proximity sensor for WWAN.

Proximity Sensor Operation

A Proximity sensor for power reduction is implemented in this device to address RF exposure compliance when the WWAN antenna is positioned close to the user’s body. This design combines the antenna and proximity sensor into a single FPC (Flexible Printed Circuit). The sensor operation area is the top side of the device.

The minimum detection distances for Top side determined as below:

Proximity Sensor Status Table

Top edge

Distance (mm)	15	16	17	18	19	20	21	22	23	24	25	26	27
Toward	on	on	on	on	on	on	on	off	off	off	off	off	off
Away	on	on	on	on	on	on	on	on	off	off	off	off	off

Note: each side minimum detection distance was performed with below:
 Toward: moving toward the phantom
 Away: Moving away from the phantom

Tilt angle

The influence of table tilt angles to proximity sensor triggering was determined by positioning each tablet edge that contains a transmitting antenna, perpendicular to the flat phantom, at 22mm separation.

Rotating the tablet around the edge next to the phantom in $\leq 10^\circ$ increments until the tablet is $\pm 45^\circ$ from the vertical position at 0° . And the maximum output power remains in the reduced mode.

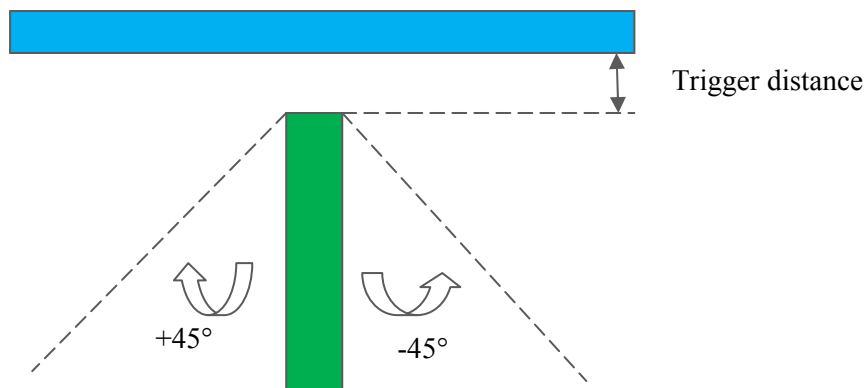

Trigger Distance (mm)	
Position	Top Edge
Minimum	21

Power Reduction Values

The power reduction values in each edge are the same as below power table at the separation distance P-sensor triggering on, please refer to the below test results.

Base on the minimum separation triggering distance is 21mm for top edge, a additional SAR measurements were required at 20cm for top edge.

Test Results:

CDMA 1x RTT P-Sensor Not Triggered

Band	Channel No.	Frequency (MHz)	RF Output Power (dBm)			
			RC1+SO55	RC3+SO55	RC3+SO32 (FCH)	RC3+SO32 (SCH)
BC0	1013	824.70	23.76	23.85	23.77	23.83
	384	836.52	23.89	23.97	23.85	23.86
	777	848.31	23.72	23.83	23.72	23.79
BC1	25	1851.25	23.68	23.59	23.69	23.60
	600	1880	23.61	23.51	23.66	23.67
	1175	1908.75	23.77	23.63	23.78	23.69

EVDO P-Sensor Not Triggered

Band	Channel No.	Frequency (MHz)	RF Output Power (dBm)	
			RTAP 153.6kbps Subtype 0	RETAP 4096pbs Subtype 2
BC0	1013	824.7	23.92	23.68
	384	836.52	24.19	23.72
	777	848.31	23.88	23.81
BC1	25	1851.25	23.96	23.95
	600	1880	23.64	23.79
	1175	1908.75	23.77	23.85

CDMA 1x RTT P-Sensor Triggered

Band	Channel No.	Frequency (MHz)	RF Output Power (dBm)			
			RC1+SO55	RC3+SO55	RC3+SO32 (FCH)	RC3+SO32 (SCH)
BC0	1013	824.7	18.87	18.89	18.75	18.88
	384	836.52	19.05	18.94	18.68	19.09
	777	848.31	18.82	18.99	18.6	18.79
BC1	25	1851.25	18.61	18.67	18.81	18.54
	600	1880	18.48	18.62	18.59	18.78
	1175	1908.75	18.56	18.62	18.59	18.81

EVDO P-Sensor Triggered

Band	Channel No.	Frequency (MHz)	RF Output Power (dBm)	
			RTAP 153.6kbps Subtype 0	RETAP 4096pbs Subtype 2
BC0	1013	824.7	19.22	18.92
	384	836.52	19.34	18.8
	777	848.31	19.28	18.81
BC1	25	1851.25	19.07	18.77
	600	1880	18.83	18.66
	1175	1908.75	18.76	18.8

**WCDMA P-Sensor NOT Triggered:
Results (12.2kbps RMC)**

Band	Frequency (MHz)	RF Output Power (dBm)
WCDMA Band 2	1852.4	22.86
	1880	22.62
	1907.6	22.54
WCDMA Band 5	826.4	22.83
	836.6	22.88
	846.6	22.74

Results (HSDPA)

Band	Frequency (MHz)	RF Output Power (dBm)			
		Subset 1	Subset 2	Subset 3	Subset 4
WCDMA Band 2	1852.4	22.30	22.23	22.41	22.25
	1880	22.07	22.10	21.71	22.21
	1907.6	21.96	22.01	21.94	22.18
WCDMA Band 5	826.4	22.16	22.47	21.92	22.37
	836.6	22.37	22.73	22.65	22.75
	846.6	22.30	22.22	22.71	22.04

Results (HSUPA)

Band	Frequency (MHz)	RF Output Power (dBm)				
		Subset 1	Subset 2	Subset 3	Subset 4	Subset 5
WCDMA Band 2	1852.4	21.68	21.83	21.73	21.76	21.66
	1880	21.57	21.40	21.75	21.59	21.24
	1907.6	21.50	21.55	21.19	21.48	21.56
WCDMA Band 5	826.4	21.74	21.85	22.22	21.63	21.55
	836.6	21.84	21.96	21.76	21.87	21.89
	846.6	21.87	22.05	21.03	21.37	21.58

Results (DC-HSDPA):

Band	Frequency (MHz)	RF Output Power (dBm)			
		Subset 1	Subset 2	Subset 3	Subset 4
WCDMA Band 2	1852.4	21.52	21.96	22.02	21.78
	1880	21.40	21.28	21.30	21.60
	1907.6	21.60	21.55	21.55	21.70
WCDMA Band 5	826.4	21.47	21.46	22.08	22.12
	836.6	21.50	21.14	21.49	21.29
	846.6	20.99	21.44	21.48	21.50

Results (HSPA+)

Band	Frequency (MHz)	RF Output Power (dBm)
WCDMA Band 2	1852.4	21.72
	1880	21.35
	1907.6	21.63
WCDMA Band 5	826.4	21.78
	836.6	21.57
	846.6	21.16

WCDMA P-Sensor Triggered:

Results (12.2kbps RMC)

Band	Frequency (MHz)	RF Output Power (dBm)
WCDMA Band 2	1852.4	18.06
	1880	17.94
	1907.6	17.92
WCDMA Band 5	826.4	18.04
	836.6	18.01
	846.6	17.98

Results (HSDPA)

Band	Frequency (MHz)	RF Output Power (dBm)			
		Subset 1	Subset 2	Subset 3	Subset 4
WCDMA Band 2	1852.4	17.53	17.37	17.31	17.08
	1880	17.14	17.14	16.78	17.29
	1907.6	17.11	16.86	16.84	17.08
WCDMA Band 5	826.4	17.23	17.62	17.16	17.34
	836.6	17.36	17.79	17.43	17.75
	846.6	17.5	17.08	17.89	17.28

Results (HSUPA)

Band	Frequency (MHz)	RF Output Power (dBm)				
		Subset 1	Subset 2	Subset 3	Subset 4	Subset 5
WCDMA Band 2	1852.4	16.72	16.94	16.81	16.7	16.61
	1880	16.35	16.23	16.72	16.56	16.4
	1907.6	16.55	16.6	16.16	16.62	16.56
WCDMA Band 5	826.4	16.74	16.66	17.22	16.73	16.34
	836.6	17.08	16.91	16.92	16.95	16.7
	846.6	16.76	17.26	16.2	16.35	16.76

Results (DC-HSDPA):

Band	Frequency (MHz)	RF Output Power (dBm)			
		Subset 1	Subset 2	Subset 3	Subset 4
WCDMA Band 2	1852.4	16.53	16.98	17.11	16.56
	1880	16.21	16.5	16.09	16.49
	1907.6	16.62	16.69	16.49	16.9
WCDMA Band 5	826.4	16.64	16.25	17.25	17.09
	836.6	16.31	16.25	16.38	16.12
	846.6	15.96	16.2	16.7	16.45

Results (HSPA+)

Band	Frequency (MHz)	RF Output Power (dBm)
WCDMA Band 2	1852.4	16.67
	1880	16.31
	1907.6	16.87
WCDMA Band 5	826.4	16.65
	836.6	16.45
	846.6	16.1

Note:

1. The default test configuration is to measure SAR with an established radio link between the EUT and a communication test set using a 12.2 kbps RMC (reference measurement Channel) Configured in Test Loop Model 1.
2. KDB 941225 D01-Body SAR is not required for HSDPA/HSUPA/HSPA+/DC-HSDPA when the maximum average output of each RF channel is less than ¼ dB higher than measured 12.2kbps RMC or the maximum SAR for 12.2kbps RMC is < 75% of SAR limit.

LTE Band 2 P-Sensor NOT Triggered:

Test Bandwidth	Test Modulation	Resource Block & RB offset	Target MPR	Meas MPR	Low Channel (dBm)	Middle Channel (dBm)	High Channel (dBm)
1.4M	QPSK	1#0	0	0	23.48	23.33	23.54
		1#3	0	0	23.76	23.3	23.64
		1#5	0	0	23.52	23.31	23.48
		3#0	1	1	23.73	23.49	23.37
		3#3	1	1	22.41	22.49	22.88
		6#0	1	1	22.45	22.49	22.58
	16-QAM	1#0	1	1	22.23	22.14	22.23
		1#3	1	1	22.33	22.24	22.24
		1#5	1	1	22.32	22.15	22.32
		3#0	2	2	22.24	22.11	22.08
		3#3	2	2	22.32	22.39	22.39
		6#0	2	2	22.4	22.35	22.53
3M	QPSK	1#0	0	0	23.51	23.19	23.52
		1#8	0	0	23.27	23.07	23.34
		1#14	0	0	23.59	23.49	23.53
		10#0	1	1	23.76	23.08	23.76
		10#5	1	1	22.48	22.28	22.3
		15#0	1	1	22.36	22.29	22.48
	16-QAM	1#0	1	1	22.25	22.55	22.36
		1#8	1	1	22.44	22.63	22.12
		1#14	1	1	22.42	22.1	22.37
		10#0	2	2	22.31	22.65	22.46
		10#5	2	2	22.98	22.91	22.96
		15#0	2	2	22.96	22.91	22.95
5M	QPSK	1#0	0	0	23.6	23.2	23.45
		1#13	0	0	23.77	23.22	23.39
		1#24	0	0	23.64	23.37	23.6
		10#0	1	1	23.86	23.17	23.79
		10#15	1	1	22.19	22.4	22.25
		25#0	1	1	22.39	22.3	22.48
	16-QAM	1#0	1	1	22.74	22.18	22.65
		1#13	1	1	22.58	22.11	22.58
		1#24	1	1	22.81	22.22	22.6
		10#0	2	2	22.93	22.31	22.42
		10#15	2	2	22.58	22.44	22.64
		25#0	2	2	22.56	22.31	22.44

Test Bandwidth	Test Modulation	Resource Block & RB offset	Target MPR	Meas MPR	Low Channel (dBm)	Middle Channel (dBm)	High Channel (dBm)
10M	QPSK	1#0	0	0	23.38	23.26	23.37
		1#25	0	0	23.55	23.42	23.61
		1#49	0	0	23.47	23.3	23.65
		25#0	1	1	23.29	22.87	23.3
		25#25	1	1	22.54	22.36	22.37
		50#0	1	1	22.37	22.27	22.38
	16-QAM	1#0	1	1	22.4	22.09	22.17
		1#25	1	1	22.11	22.21	22.52
		1#49	1	1	22.39	22.4	22.31
		25#0	2	2	22.25	22.12	22.6
		25#25	2	2	22.65	22.27	22.26
		50#0	2	2	22.44	22.35	22.31
15M	QPSK	1#0	0	0	23.47	23.27	23.26
		1#38	0	0	23.71	23.04	23.7
		1#74	0	0	23.43	23.28	23.6
		36#0	1	1	23.58	23.23	23.31
		36#39	1	1	22.62	22.27	22.43
		75#0	1	1	22.3	22.07	22.14
	16-QAM	1#0	1	1	22.29	22.52	22.58
		1#38	1	1	22.09	22.73	22.66
		1#74	1	1	22.37	22.49	22.98
		36#0	2	2	22.31	22.24	22.37
		36#39	2	2	22.65	22.84	22.29
		75#0	2	2	22.19	22.17	22.13
20M	QPSK	1#0	0	0	23.45	23.39	23.3
		1#50	0	0	23.43	23.16	23.11
		1#99	0	0	23.44	23.4	23.54
		50#0	1	1	23.55	23.71	23.28
		50#50	1	1	22.51	22.41	22.36
		100#0	1	1	22.42	22.36	22.15
	16-QAM	1#0	1	1	22.5	22.6	23.05
		1#50	1	1	22.48	22.49	23.02
		1#99	1	1	22.61	22.6	23.2
		50#0	2	2	22.31	22.4	23.24
		50#50	2	2	22.21	22.5	22.5
		100#0	2	2	22.31	22.38	22.14

LTE Band 4 P-Sensor NOT Triggered:

Test Bandwidth	Test Modulation	Resource Block & RB offset	Target MPR	Meas MPR	Low Channel (dBm)	Middle Channel (dBm)	High Channel (dBm)
1.4M	QPSK	1#0	0	0	23.3	23.31	23.31
		1#3	0	0	23.49	23.66	23.61
		1#5	0	0	23.35	23.42	23.36
		3#0	1	1	23.45	23.3	23.25
		3#3	1	1	22.08	22.63	22.63
		6#0	1	1	22.24	22.38	22.54
	16-QAM	1#0	1	1	22.28	22.14	22.07
		1#3	1	1	22.16	22.37	22.15
		1#5	1	1	22.22	22.2	22.12
		3#0	2	2	22.35	22.33	22.34
		3#3	2	2	22.37	22.46	22.09
		6#0	2	2	22.18	22.53	22.34
3M	QPSK	1#0	0	0	23.31	23.25	23.42
		1#8	0	0	23.61	23.09	23.65
		1#14	0	0	23.31	23.47	23.38
		10#0	1	1	23.46	23.23	23.34
		10#5	1	1	22.14	22.23	22.3
		15#0	1	1	22.34	22.45	22.32
	16-QAM	1#0	1	1	22.26	22.18	22.09
		1#8	1	1	22.42	22.54	22.27
		1#14	1	1	22.09	22.2	22.1
		10#0	2	2	22.56	22.42	22.01
		10#5	2	2	22.13	22.29	22.33
		15#0	2	2	22.17	22.51	22.55
5M	QPSK	1#0	0	0	23.51	23.41	23.28
		1#13	0	0	23.71	23.12	23.68
		1#24	0	0	23.36	23.38	23.43
		10#0	1	1	23.07	23.52	23.6
		10#15	1	1	22.4	22.17	22.27
		25#0	1	1	22.26	22.32	22.2
	16-QAM	1#0	1	1	22.57	22.02	22.5
		1#13	1	1	22.82	22.1	22.7
		1#24	1	1	22.43	22.1	22.51
		10#0	2	2	22.77	22.33	22.35
		10#15	2	2	22.14	22.2	22.25
		25#0	2	2	22.18	22.33	22.27

Test Bandwidth	Test Modulation	Resource Block & RB offset	Target MPR	Meas MPR	Low Channel (dBm)	Middle Channel (dBm)	High Channel (dBm)
10M	QPSK	1#0	0	0	23.19	23.28	23.26
		1#25	0	0	23.01	23.39	22.93
		1#49	0	0	23.3	23.46	23.47
		25#0	1	1	23.24	23.12	23.3
		25#25	1	1	22.68	22.31	22.12
		50#0	1	1	21.94	22.07	22.18
	16-QAM	1#0	1	1	22.04	22.61	22.93
		1#25	1	1	22.31	22.03	22.83
		1#49	1	1	22.49	22.5	22.97
		25#0	2	2	22.25	22.16	23.07
		25#25	2	2	22.22	22.22	22.29
		50#0	2	2	22.98	22.13	22.27
15M	QPSK	1#0	0	0	23.19	23.09	23.42
		1#38	0	0	23.21	23.31	23.3
		1#74	0	0	23.26	23.44	23.5
		36#0	1	1	22.98	22.78	23.22
		36#39	1	1	22.05	21.98	22.48
		75#0	1	1	22.36	22.27	22.4
	16-QAM	1#0	1	1	22.22	22.25	22.55
		1#38	1	1	22.23	22.43	22.44
		1#74	1	1	22.07	22.66	22.3
		36#0	2	2	22.21	22.21	22.8
		36#39	2	2	22.63	22.24	22.93
		75#0	2	2	22.44	22.19	22.17
20M	QPSK	1#0	0	0	23.33	23.25	23.64
		1#50	0	0	23.58	23.26	23.61
		1#99	0	0	23.66	23.74	23.31
		50#0	1	1	23.14	23.41	23.39
		50#50	1	1	22.42	22.34	22.58
		100#0	1	1	22.06	22.02	22.44
	16-QAM	1#0	1	1	22.51	22.25	22.79
		1#50	1	1	22.5	22.62	23.09
		1#99	1	1	22.24	23.13	23.21
		50#0	2	2	22.8	22.37	22.59
		50#50	2	2	22.3	22.08	22
		100#0	2	2	22.24	22.07	22.12

LTE Band 5 P-Sensor NOT Triggered:

Test Bandwidth	Test Modulation	Resource Block & RB offset	Target MPR	Meas MPR	Low Channel (dBm)	Middle Channel (dBm)	High Channel (dBm)
1.4M	QPSK	1#0	0	0	23.83	23.85	23.71
		1#3	0	0	24.06	23.56	23.57
		1#5	0	0	23.76	23.93	23.63
		3#0	1	1	23.72	23.93	24.02
		3#3	1	1	23.01	22.88	22.88
		6#0	1	1	22.81	22.9	22.89
	16-QAM	1#0	1	1	22.75	22.68	22.74
		1#3	1	1	22.72	23.02	23.22
		1#5	1	1	22.57	22.84	22.98
		3#0	2	2	22.89	22.57	22.91
		3#3	2	2	22.62	22.93	22.85
		6#0	2	2	22.76	22.95	22.65
3M	QPSK	1#0	0	0	23.67	23.89	23.68
		1#8	0	0	23.52	23.85	23.95
		1#14	0	0	23.7	23.82	23.66
		10#0	1	1	23.45	23.53	23.85
		10#5	1	1	22.6	23.16	23.07
		15#0	1	1	22.67	22.9	22.79
	16-QAM	1#0	1	1	22.57	22.62	22.91
		1#8	1	1	22.82	22.91	22.66
		1#14	1	1	22.65	22.63	22.92
		10#0	2	2	22.69	22.87	22.62
		10#5	2	2	22.76	22.85	22.57
		15#0	2	2	22.73	22.97	22.91
5M	QPSK	1#0	0	0	23.9	23.63	23.69
		1#13	0	0	23.96	23.65	23.68
		1#24	0	0	23.93	23.77	24
		10#0	1	1	23.57	23.66	24.04
		10#15	1	1	22.76	22.91	24.14
		25#0	1	1	22.66	22.8	24.33
	16-QAM	1#0	1	1	23	22.99	22.85
		1#13	1	1	23.12	22.89	22.92
		1#24	1	1	23.14	22.91	23.08
		10#0	2	2	22.95	22.54	22.81
		10#15	2	2	22.56	22.99	23.22
		25#0	2	2	22.72	22.98	23.16

Test Bandwidth	Test Modulation	Resource Block & RB offset	Target MPR	Meas MPR	Low Channel (dBm)	Middle Channel (dBm)	High Channel (dBm)
10M	QPSK	1#0	0	0	23.74	23.73	23.86
		1#25	0	0	23.59	23.45	23.81
		1#49	0	0	23.62	23.55	23.75
		25#0	1	1	23.4	23.82	23.68
		25#25	1	1	22.61	22.92	22.62
		50#0	1	1	22.53	22.84	22.77
	16-QAM	1#0	1	1	23.03	22.89	22.74
		1#25	1	1	23.08	23.26	22.58
		1#49	1	1	23.27	22.67	22.73
		25#0	2	2	23.28	22.95	22.64
		25#25	2	2	22.79	22.81	22.95
		50#0	2	2	22.95	22.76	22.77

LTE Band 13 P-Sensor NOT Triggered:

Test Bandwidth	Test Modulation	Resource Block & RB offset	Target MPR	Meas MPR	Low Channel (dBm)	Middle Channel (dBm)	High Channel (dBm)
5M	QPSK	1#0	0	0	23.83	23.65	23.93
		1#13	0	0	24.01	23.83	23.77
		1#24	0	0	24	23.8	23.59
		10#0	1	1	23.69	23.43	23.75
		10#15	1	1	22.63	22.77	22.76
		25#0	1	1	22.63	22.72	22.89
	16-QAM	1#0	1	1	23	22.43	23.07
		1#13	1	1	23.1	22.47	23.13
		1#24	1	1	23.19	22.59	22.72
		10#0	2	2	23.18	22.41	23.08
		10#15	2	2	22.29	22.46	22.88
		25#0	2	2	22.58	22.81	22.71
10M	QPSK	1#0	0	0	/	23.5	/
		1#25	0	0	/	23.45	/
		1#49	0	0	/	23.62	/
		25#0	1	1	/	23.56	/
		25#25	1	1	/	22.78	/
		50#0	1	1	/	22.71	/
	16-QAM	1#0	1	1	/	23.17	/
		1#25	1	1	/	23.03	/
		1#49	1	1	/	23.25	/
		25#0	2	2	/	23.14	/
		25#25	2	2	/	23.17	/
		50#0	2	2	/	22.65	/

LTE Band 17 P-Sensor NOT Triggered:

Test Bandwidth	Test Modulation	Resource Block & RB offset	Target MPR	Meas MPR	Low Channel (dBm)	Middle Channel (dBm)	High Channel (dBm)
5M	QPSK	1#0	0	0	23.42	23.81	23.75
		1#13	0	0	23.12	23.58	23.57
		1#24	0	0	23.92	23.65	23.25
		10#0	1	1	23.16	23.65	23.67
		10#15	1	1	22.88	22.94	22.52
		25#0	1	1	22.55	22.85	22.54
	16-QAM	1#0	1	1	22.63	22.58	22.86
		1#13	1	1	23.02	22.3	22.89
		1#24	1	1	23.11	22.44	22.38
		10#0	2	2	22.95	22.5	22.95
		10#15	2	2	22.42	22.98	22.64
		25#0	2	2	22.6	22.78	22.51
10M	QPSK	1#0	0	0	23.92	23.55	23.6
		1#25	0	0	23.8	23.52	23.83
		1#49	0	0	23.81	23.48	23.38
		25#0	1	1	23.61	23.99	23.56
		25#25	1	1	22.35	22.29	22.42
		50#0	1	1	22.5	22.53	22.69
	16-QAM	1#0	1	1	23.53	22.53	22.39
		1#25	1	1	23.65	22.49	22.31
		1#49	1	1	23.35	22.41	22.36
		25#0	2	2	23.34	22.46	22.49
		25#25	2	2	22.55	22.72	22.34
		50#0	2	2	22.64	22.41	22.61

LTE Band 2 P-Sensor Triggered:

Test Bandwidth	Test Modulation	Resource Block & RB offset	Target MPR	Meas MPR	Low Channel (dBm)	Middle Channel (dBm)	High Channel (dBm)
1.4M	QPSK	1#0	0	0	18.57	18.5	18.51
		1#3	0	0	18.84	18.06	18.74
		1#5	0	0	18.55	18.5	18.4
		3#0	1	1	18.6	18.65	18.51
		3#3	1	1	17.56	17.33	17.73
		6#0	1	1	17.44	17.36	17.68
	16-QAM	1#0	1	1	17.45	17.67	17.34
		1#3	1	1	17.25	17.38	17.29
		1#5	1	1	17.32	17.52	17.49
		3#0	2	2	17.45	17.24	17.23
		3#3	2	2	17.32	17.27	17.34
		6#0	2	2	17.26	17.38	17.31
3M	QPSK	1#0	0	0	18.33	18.3	18.6
		1#8	0	0	18.19	17.99	18.35
		1#14	0	0	18.55	18.24	18.51
		10#0	1	1	18.76	18.24	18.66
		10#5	1	1	17.65	17.32	17.44
		15#0	1	1	17.58	17.45	17.52
	16-QAM	1#0	1	1	17.32	17.39	17.25
		1#8	1	1	17.35	17.66	17.39
		1#14	1	1	17.31	17.32	17.37
		10#0	2	2	17.24	17.39	17.54
		10#5	2	2	17.53	17.73	17.26
		15#0	2	2	17.43	17.39	17.6
5M	QPSK	1#0	0	0	18.51	18.42	18.67
		1#13	0	0	19.02	18.32	18.4
		1#24	0	0	18.56	18.31	18.41
		10#0	1	1	18.97	18.05	18.6
		10#15	1	1	17.26	17.8	17.53
		25#0	1	1	17.4	17.22	17.6
	16-QAM	1#0	1	1	17.81	17.98	17.63
		1#13	1	1	17.4	17.27	17.65
		1#24	1	1	17.95	17.23	17.63
		10#0	2	2	18.14	17.5	17.25
		10#15	2	2	17.91	17.4	17.44
		25#0	2	2	17.54	17.43	17.58

Test Bandwidth	Test Modulation	Resource Block & RB offset	Target MPR	Meas MPR	Low Channel (dBm)	Middle Channel (dBm)	High Channel (dBm)
10M	QPSK	1#0	0	0	18.44	18.32	18.36
		1#25	0	0	18.5	18.24	18.4
		1#49	0	0	18.45	18.31	18.86
		25#0	1	1	18.4	18.05	18.12
		25#25	1	1	17.22	17.54	17.22
		50#0	1	1	17.56	17.28	17.47
	16-QAM	1#0	1	1	17.36	17.57	17.34
		1#25	1	1	17.34	17.35	17.65
		1#49	1	1	17.59	17.39	17.57
		25#0	2	2	17.24	17.74	17.77
		25#25	2	2	17.56	17.41	17.47
		50#0	2	2	17.66	17.39	17.56
15M	QPSK	1#0	0	0	18.51	18.46	18.36
		1#38	0	0	18.61	18.07	18.55
		1#74	0	0	18.33	18.24	18.4
		36#0	1	1	18.81	17.99	18.29
		36#39	1	1	17.87	17.29	17.44
		75#0	1	1	17.65	17.92	17.42
	16-QAM	1#0	1	1	17.36	17.75	17.68
		1#38	1	1	17.6	17.93	17.72
		1#74	1	1	17.31	17.31	17.79
		36#0	2	2	17.56	17.31	17.61
		36#39	2	2	17.37	17.8	17.57
		75#0	2	2	17.37	17.22	17.34
20M	QPSK	1#0	0	0	18.87	18.79	18.64
		1#50	0	0	18.2	18.28	18.24
		1#99	0	0	18.35	18.33	18.72
		50#0	1	1	18.32	18.54	18.36
		50#50	1	1	17.28	17.29	17.37
		100#0	1	1	17.66	17.28	17.56
	16-QAM	1#0	1	1	17.54	17.62	18.2
		1#50	1	1	17.33	17.55	17.83
		1#99	1	1	17.73	17.53	18.31
		50#0	2	2	17.37	17.42	18.17
		50#50	2	2	17.57	17.55	17.39
		100#0	2	2	17.49	17.53	17.63

LTE Band 4 P-Sensor Triggered:

Test Bandwidth	Test Modulation	Resource Block & RB offset	Target MPR	Meas MPR	Low Channel (dBm)	Middle Channel (dBm)	High Channel (dBm)
1.4M	QPSK	1#0	0	0	18.06	18.09	18.54
		1#3	0	0	18.72	18.62	18.79
		1#5	0	0	18.14	18.64	18.54
		3#0	1	1	18.28	18.49	18.05
		3#3	1	1	17.51	17.51	17.45
		6#0	1	1	17.28	17.26	17.44
	16-QAM	1#0	1	1	17.2	17.54	17.23
		1#3	1	1	17.58	17.21	17.39
		1#5	1	1	17.28	17.62	17.57
		3#0	2	2	17.65	17.3	17.29
		3#3	2	2	17.26	17.5	17.95
		6#0	2	2	17.32	17.33	17.55
3M	QPSK	1#0	0	0	18.19	18.1	18.32
		1#8	0	0	18.44	17.99	18.49
		1#14	0	0	18.48	18.64	18.4
		10#0	1	1	18.59	18.21	18.47
		10#5	1	1	17.52	17.64	17.56
		15#0	1	1	17.23	17.22	17.34
	16-QAM	1#0	1	1	17.35	17.4	17.21
		1#8	1	1	17.62	17.36	17.21
		1#14	1	1	17.26	17.44	17.16
		10#0	2	2	17.58	17.65	17.22
		10#5	2	2	17.48	17.42	17.57
		15#0	2	2	17.68	17.7	17.67
5M	QPSK	1#0	0	0	18.5	18.17	18.52
		1#13	0	0	18.53	18.13	18.59
		1#24	0	0	18.38	18.26	18.41
		10#0	1	1	17.86	18.66	18.54
		10#15	1	1	17.33	17.25	17.17
		25#0	1	1	17.19	17.57	17.64
	16-QAM	1#0	1	1	17.47	17.59	17.68
		1#13	1	1	17.98	17.9	17.78
		1#24	1	1	17.54	17.55	17.57
		10#0	2	2	17.76	17.16	17.38
		10#15	2	2	17.58	17.42	17.64
		25#0	2	2	17.48	17.63	17.42

Test Bandwidth	Test Modulation	Resource Block & RB offset	Target MPR	Meas MPR	Low Channel (dBm)	Middle Channel (dBm)	High Channel (dBm)
10M	QPSK	1#0	0	0	18.26	18.13	18.36
		1#25	0	0	17.83	18.31	17.77
		1#49	0	0	18.28	18.34	18.27
		25#0	1	1	18.02	18.34	18.28
		25#25	1	1	17.53	17.35	17.29
		50#0	1	1	17.61	17.69	17.32
	16-QAM	1#0	1	1	17.41	17.7	18.06
		1#25	1	1	17.68	17.95	17.95
		1#49	1	1	17.71	17.37	18.07
		25#0	2	2	17.61	17.4	18.2
		25#25	2	2	17.64	17.29	17.21
		50#0	2	2	17.68	17.66	17.33
15M	QPSK	1#0	0	0	18.23	18.33	18.55
		1#38	0	0	18.26	18.12	18.24
		1#74	0	0	18.19	18.53	18.44
		36#0	1	1	17.87	17.64	18.23
		36#39	1	1	17.54	17.56	17.68
		75#0	1	1	17.8	17.2	17.39
	16-QAM	1#0	1	1	17.35	17.33	17.37
		1#38	1	1	17.43	17.58	17.53
		1#74	1	1	17.61	17.88	17.35
		36#0	2	2	17.3	17.27	17.98
		36#39	2	2	17.31	17.27	17.43
		75#0	2	2	17.61	17.56	17.39
20M	QPSK	1#0	0	0	18.14	18.12	18.96
		1#50	0	0	18.65	18.2	18.4
		1#99	0	0	18.41	18.6	18.39
		50#0	1	1	18.5	18.81	18.43
		50#50	1	1	17.77	17.28	17.44
		100#0	1	1	17.21	17.16	17.57
	16-QAM	1#0	1	1	17.33	17.49	18
		1#50	1	1	17.27	17.39	18.24
		1#99	1	1	17.35	18.46	18.44
		50#0	2	2	17.57	17.31	17.76
		50#50	2	2	17.61	17.45	17.95
		100#0	2	2	17.44	17.68	17.68

LTE Band 5 P-Sensor Triggered:

Test Bandwidth	Test Modulation	Resource Block & RB offset	Target MPR	Meas MPR	Low Channel (dBm)	Middle Channel (dBm)	High Channel (dBm)
1.4M	QPSK	1#0	0	0	18.92	19	18.8
		1#3	0	0	18.86	18.4	18.42
		1#5	0	0	19	18.82	18.66
		3#0	1	1	18.58	19.11	19.13
		3#3	1	1	17.84	17.63	17.69
		6#0	1	1	17.8	18.03	18.03
	16-QAM	1#0	1	1	17.56	17.77	17.74
		1#3	1	1	17.68	17.87	17.82
		1#5	1	1	17.72	17.82	17.88
		3#0	2	2	17.74	17.69	17.98
		3#3	2	2	17.79	17.85	17.99
		6#0	2	2	17.85	17.69	17.72
3M	QPSK	1#0	0	0	18.83	18.91	18.75
		1#8	0	0	18.74	19.01	18.74
		1#14	0	0	18.92	18.85	18.67
		10#0	1	1	18.35	18.77	19.08
		10#5	1	1	17.75	18.26	17.87
		15#0	1	1	17.65	17.73	17.74
	16-QAM	1#0	1	1	17.92	17.77	17.76
		1#8	1	1	17.59	17.56	17.65
		1#14	1	1	17.84	17.73	17.98
		10#0	2	2	17.79	18.03	17.76
		10#5	2	2	17.95	17.79	17.85
		15#0	2	2	17.83	17.88	17.91
5M	QPSK	1#0	0	0	18.77	18.38	18.67
		1#13	0	0	18.82	18.73	18.66
		1#24	0	0	18.69	18.87	18.77
		10#0	1	1	18.35	18.44	19.04
		10#15	1	1	17.78	17.69	19.17
		25#0	1	1	17.86	17.81	19.35
	16-QAM	1#0	1	1	17.78	17.78	17.8
		1#13	1	1	18.24	17.94	17.68
		1#24	1	1	17.96	17.83	17.9
		10#0	2	2	17.76	17.79	17.91
		10#15	2	2	17.67	17.94	18.25
		25#0	2	2	17.91	17.75	17.98

Test Bandwidth	Test Modulation	Resource Block & RB offset	Target MPR	Meas MPR	Low Channel (dBm)	Middle Channel (dBm)	High Channel (dBm)
10M	QPSK	1#0	0	0	18.63	18.47	18.68
		1#25	0	0	18.57	18.54	18.8
		1#49	0	0	18.77	18.85	18.96
		25#0	1	1	18.62	18.69	18.58
		25#25	1	1	17.6	18.08	17.66
		50#0	1	1	17.95	17.83	17.69
	16-QAM	1#0	1	1	17.8	17.89	17.84
		1#25	1	1	17.92	17.92	17.7
		1#49	1	1	18.1	17.89	17.58
		25#0	2	2	18.26	17.85	17.61
		25#25	2	2	17.82	17.87	17.82
		50#0	2	2	17.96	17.78	17.86

LTE Band 13 P-Sensor Triggered:

Test Bandwidth	Test Modulation	Resource Block & RB offset	Target MPR	Meas MPR	Low Channel (dBm)	Middle Channel (dBm)	High Channel (dBm)
5M	QPSK	1#0	0	0	18.73	18.7	19.17
		1#13	0	0	18.93	18.78	18.68
		1#24	0	0	18.9	18.73	18.67
		10#0	1	1	18.47	18.53	18.59
		10#15	1	1	17.61	17.76	17.62
		25#0	1	1	17.73	17.55	17.69
	16-QAM	1#0	1	1	18.14	17.5	18.11
		1#13	1	1	18.19	17.52	18.01
		1#24	1	1	18.26	17.43	17.77
		10#0	2	2	18.22	17.52	18.18
		10#15	2	2	17.66	17.57	17.61
		25#0	2	2	17.59	17.66	17.62
10M	QPSK	1#0	0	0	/	18.5	/
		1#25	0	0	/	18.45	/
		1#49	0	0	/	18.52	/
		25#0	1	1	/	18.98	/
		25#25	1	1	/	17.73	/
		50#0	1	1	/	17.88	/
	16-QAM	1#0	1	1	/	18.11	/
		1#25	1	1	/	18.08	/
		1#49	1	1	/	18.06	/
		25#0	2	2	/	18.24	/
		25#25	2	2	/	18.39	/
		50#0	2	2	/	17.67	/

LTE Band 17 P-Sensor Triggered:

Test Bandwidth	Test Modulation	Resource Block & RB offset	Target MPR	Meas MPR	Low Channel (dBm)	Middle Channel (dBm)	High Channel (dBm)
5M	QPSK	1#0	0	0	18.25	18.81	18.83
		1#13	0	0	18.32	18.63	18.71
		1#24	0	0	18.84	18.65	18.19
		10#0	1	1	18.36	18.52	18.45
		10#15	1	1	18.12	18.13	17.41
		25#0	1	1	17.42	17.85	17.39
	16-QAM	1#0	1	1	17.79	17.57	17.65
		1#13	1	1	17.94	17.44	18.02
		1#24	1	1	18.05	17.42	17.51
		10#0	2	2	17.75	17.57	18.2
		10#15	2	2	17.44	17.56	17.73
		25#0	2	2	17.55	17.65	17.38
10M	QPSK	1#0	0	0	18.8	18.38	18.59
		1#25	0	0	18.91	18.43	18.73
		1#49	0	0	18.79	18.31	18.6
		25#0	1	1	18.83	19.09	18.68
		25#25	1	1	17.62	17.29	17.47
		50#0	1	1	17.39	17.64	17.67
	16-QAM	1#0	1	1	18.39	17.56	17.68
		1#25	1	1	18.68	18.23	18.32
		1#49	1	1	18.33	17.58	17.62
		25#0	2	2	17.75	18.22	17.86
		25#25	2	2	17.71	17.64	17.42
		50#0	2	2	17.87	17.65	17.37

Note:

- 1.SAR for LTE band exposure configurations is measured according to the procedures of KDB 941225 D05 SAR for LTE Devices v02.
- 2.The CMW500 Wideband Radio Communication tester is used for LTE output power measurements and SAR testing. Closed loop power control is used to keep the radio transmitters the max output power during the test.
- 3.KDB941225D05v02- SAR for higher order modulation is required only when the highest maximum output power for the configuration in the higher order modulation is > ½ dB higher than the same configuration in QPSK or when the reported SAR for the QPSK configuration is > 1.45 W/kg

Hopping:

Mode		Channel frequency (MHz)	RF Output Power (dBm)
Bluetooth	BDR(GFSK)	2402	5.57
		2441	5.41
		2480	5.90
	EDR($\pi/4$ -DQPSK)	2402	5.20
		2441	5.62
		2480	5.89
	EDR-8DPSK	2402	4.87
		2441	5.31
		2480	5.64
	BLE	2402	-1.86
		2440	-1.30
		2480	-1.18
Long range Hopping		2401.683	15.06
		2435.771	15.71
		2470.788	16.58

WLAN 2.4G, SISO Mode:

Mode	Channel	Frequency (MHz)	Conducted Average Output Power (dBm)	
			Main(Chain 0)	Aux(Chain 1)
802.11 b	Low	2412	19.87	19.45
	Middle	2437	19.82	19.59
	High	2462	19.72	19.76
802.11 g	Low	2412	18.05	17.02
	Middle	2437	18.42	17.29
	High	2462	16.89	17.10
802.11 n20	Low	2412	18.06	16.96
	Middle	2437	18.62	17.85
	High	2462	17.91	16.97
802.11 n40	Low	2422	17.41	16.95
	Middle	2437	17.39	17.81
	High	2452	16.14	16.28

Note:

The output power was tested under data rate 1Mbps for 802.11b, 6Mbps for 802.11g, MCS0 for 802.11n HT20 and 802.11n HT40.

WLAN 2.4G, MIMO Mode:

Mode	Channel	Frequency (MHz)	Conducted Average Output Power (dBm)		
			Main(Chain 0)	Aux(Chain 1)	Total
802.11 n20	Low	2412	15.40	14.59	18.02
	Middle	2437	15.11	14.86	18.00
	High	2462	15.10	15.06	18.09
802.11 n40	Low	2422	13.40	14.97	17.27
	Middle	2437	15.47	16.70	19.14
	High	2452	14.67	15.74	18.25

Note: The output power was tested under data rate MCS8 for 802.11n HT20 and 802.11n HT40.

WLAN 5G, SISO Mode:

UNII Band	Mode	Frequency (MHz)	Conducted Average Output Power (dBm)	
			Main (Chain 0)	Aux (Chain 1)
5150-5250MHz	802.11 a	5180	14.50	14.37
		5200	14.58	14.50
		5240	14.47	14.21
	802.11 n20	5180	13.93	13.91
		5200	14.09	13.86
		5240	13.84	13.45
	802.11 n40	5190	12.70	13.28
		5230	13.69	13.91
	802.11 ac20	5180	13.96	13.88
		5200	14.03	13.78
		5240	13.75	13.67
	802.11 ac40	5190	12.66	13.30
5230		13.61	13.87	
802.11 ac80	5210	11.39	11.74	
5250-5350MHz	802.11 a	5260	14.15	14.54
		5280	14.01	14.22
		5320	13.87	14.06
	802.11 n20	5260	13.68	13.72
		5280	13.49	13.48
		5320	13.29	13.46
	802.11 n40	5270	13.35	13.36
		5310	12.26	13.13
	802.11 ac20	5260	13.67	13.57
		5280	13.40	13.34
		5320	13.48	13.30
	802.11 ac40	5270	13.43	13.24
		5310	13.28	13.14
	802.11 ac80	5290	11.40	11.47

UNII Band	Mode	Frequency (MHz)	Conducted Average Output Power (dBm)	
			Main (Chain 0)	Aux (Chain 1)
5470-5725MHz	802.11 a	5500	14.40	14.29
		5580	14.68	14.36
		5700	13.91	14.34
		5720	14.27	14.50
	802.11 n20	5500	13.83	13.80
		5580	13.86	13.72
		5700	13.19	13.37
		5720	13.44	13.71
	802.11 n40	5510	13.67	12.67
		5590	13.97	13.75
		5670	13.73	13.66
		5710	13.53	13.72
	802.11 ac20	5500	13.85	13.34
		5580	13.82	13.81
		5700	13.19	13.49
		5720	13.55	13.62
	802.11 ac40	5510	13.63	12.63
		5590	13.88	13.66
		5670	13.69	13.66
		5710	13.56	13.81
802.11 ac80	5530	11.93	11.29	
	5610	11.24	11.46	
	5690	11.45	11.46	
5725-5850MHz	802.11 a	5745	14.59	14.37
		5785	14.10	14.16
		5825	14.38	14.18
	802.11 n20	5745	13.90	13.41
		5785	13.69	13.51
		5825	13.85	13.71
	802.11 n40	5755	13.66	13.54
		5795	13.94	13.46
	802.11 ac20	5745	13.82	13.36
		5785	13.54	13.35
		5825	13.88	13.62
	802.11 ac40	5755	13.75	13.44
		5795	14.04	13.52
802.11 ac80	5775	12.01	11.47	

WLAN 5G, MIMO Mode:

UNII Band	Mode	Frequency (MHz)	Conducted Average Output Power (dBm)		
			Main (Chain 0)	Aux (Chain 1)	Total
5150-5250MHz	802.11 n20	5180	10.79	10.55	13.68
		5200	10.87	10.55	13.72
		5240	10.82	10.58	13.71
	802.11 n40	5190	4.96	4.95	7.97
		5230	10.88	10.61	13.76
	802.11 ac20	5180	10.94	10.64	13.80
		5200	10.59	10.44	13.53
		5240	10.84	10.64	13.75
	802.11 ac40	5190	4.89	4.83	7.87
		5230	10.76	10.65	13.72
802.11 ac80	5210	8.52	8.24	11.39	
5250-5350MHz	802.11 n20	5260	10.41	10.26	13.35
		5280	10.50	10.23	13.38
		5320	10.69	10.45	13.58
	802.11 n40	5270	10.90	10.54	13.73
		5310	10.38	10.22	13.31
	802.11 ac20	5260	10.40	10.40	13.41
		5280	10.39	10.38	13.40
		5320	10.78	10.42	13.61
	802.11 ac40	5270	10.72	10.57	13.66
		5310	10.52	10.19	13.37
802.11 ac80	5290	8.43	8.29	11.37	
5470-5725MHz	802.11 n20	5500	10.70	10.58	13.65
		5580	11.12	10.73	13.94
		5700	10.63	10.44	13.55
		5720	10.44	10.42	13.44
	802.11 n40	5510	10.35	10.28	13.33
		5550	10.57	10.43	13.51
		5670	10.63	10.37	13.51
		5710	10.62	10.31	13.48
	802.11 ac20	5500	10.69	10.52	13.62
		5580	11.17	10.66	13.93
		5700	10.65	10.40	13.54
		5720	10.54	10.45	13.51
	802.11 ac40	5510	10.35	10.28	13.33
		5550	10.51	10.53	13.53
		5670	10.57	10.37	13.48
		5710	10.54	10.36	13.46
	802.11 ac80	5530	8.64	8.34	11.50
		5610	8.37	8.43	11.41
5690		8.37	8.36	11.38	

UNII Band	Mode	Frequency (MHz)	Conducted Average Output Power (dBm)		
			Main (Chain 0)	Aux (Chain 1)	Total
5725-5850MHz	802.11 n20	5745	10.98	10.62	13.81
		5785	10.80	10.35	13.59
		5825	10.98	10.49	13.75
	802.11 n40	5755	10.87	10.56	13.73
		5795	10.86	10.51	13.70
	802.11 ac20	5745	10.98	10.50	13.76
		5785	10.75	10.41	13.59
		5825	11.00	10.60	13.81
	802.11 ac40	5755	10.87	10.47	13.68
		5795	10.82	10.66	13.75
	802.11 ac80	5775	8.84	8.54	11.70

Note:

The EUT was tested under data rate:

- 802.11a: 6Mbps
- 802.11 n20 SISO: MCS0
- 802.11 n20 MIMO: MCS8
- 802.11 n40 SISO: MCS0
- 802.11 n40 MIMO: MCS8
- 802.11 ac20 SISO: MCS0
- 802.11 ac20 MIMO: MCS8
- 802.11 ac40 SISO: MCS0
- 802.11 ac40 MIMO: MCS8
- 802.11 ac80 SISO: MCS0
- 802.11 ac80 MIMO: MCS8

Standalone SAR test exclusion considerations

Antenna Location

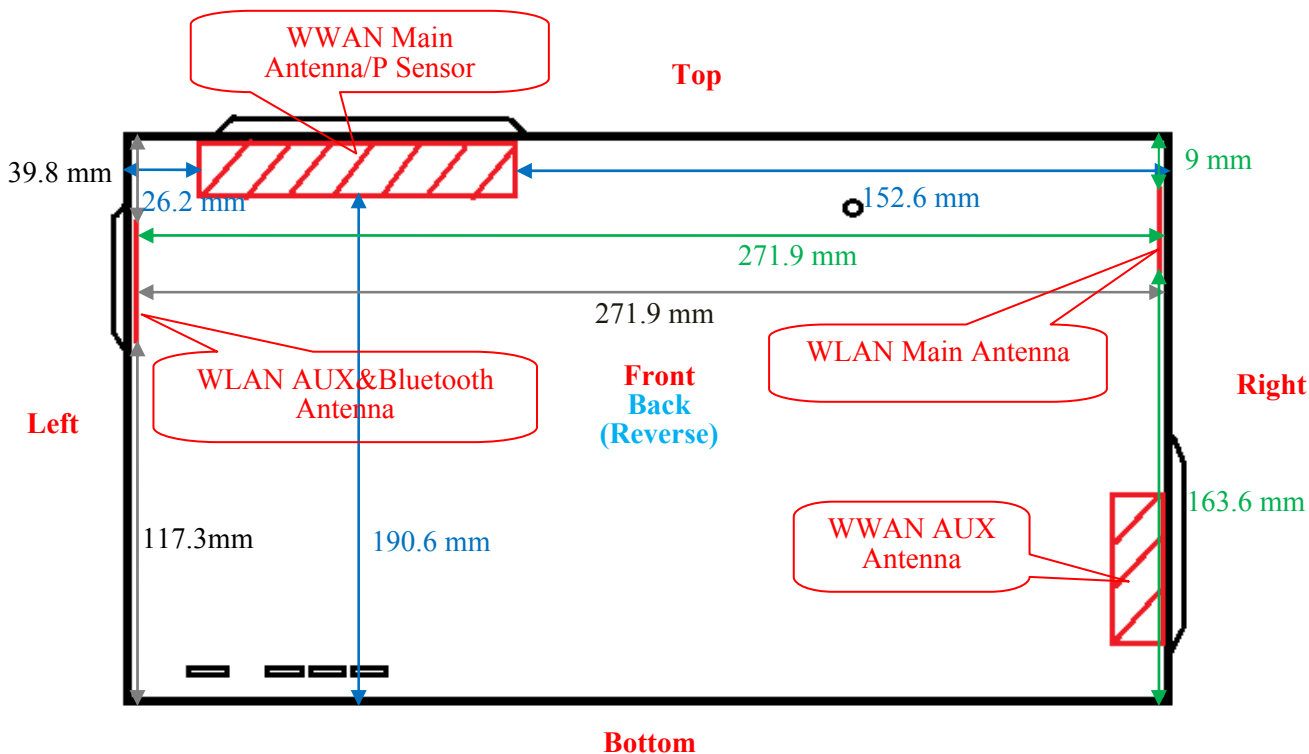

- Note: 1、 The Protective material on corners was removed during SAR test.
 2、 The long range Hopping is an external antenna which located in the back of the tablet, it is set on the tripod when normal using, the separation distance of at least 20 centimeters is normally maintained between its radiating structure and the body of the user or nearby persons, so the SAR testing is not required.

Antenna Distance To Edge

Antenna Distance To Edge(mm)					
Antenna	Left Edge	Right Edge	Top Edge	Back Edge	Bottom Edge
WWAN Main	26.2	152.6	8.1	1.8	190.6
Bluetooth/WLAN AUX	2.3	271.9	39.8	2.7	117.3
WLAN Main	271.9	2.5	9	4.7	163.6

Standalone SAR test exclusion considerations(KDB):

Mode	Frequency (MHz)	Pavg (dBm)	Pavg (mW)	Test Exclusion Distance (mm)
CDMA 850	849	24.3	269.2	69
CDMA 1900	1910	24	251.2	65
WCDMA Band 2	1910	23	199.5	59
WCDMA Band 5	849	23	199.5	57
LTE Band 2	1910	23.9	245.5	64
LTE Band 4	1755	23.8	239.9	63
LTE Band 5	849	24.4	275.4	70
LTE Band 13	782	24.1	257	67
LTE Band 17	716	24	251.2	66
2.4GHz WLAN(Main)	2462	20	100	51
2.4GHz WLAN(AUX)	2462	20	100	51
5.2GHz WLAN(Main)	5240	14.8	30.2	23
5.2GHz WLAN(AUX)	5240	14.8	30.2	23
5.3GHz WLAN(Main)	5320	14.3	26.9	21
5.3GHz WLAN(AUX)	5320	14.7	29.5	23
5.6GHz WLAN(Main)	5720	14.8	30.2	24
5.6GHz WLAN(AUX)	5720	14.7	29.5	23
5.8GHz WLAN(Main)	5785	14.7	29.5	24
5.8GHz WLAN(AUX)	5785	14.5	28.2	23
Bluetooth	2480	6	4	3

NOTE:

The 1-g and 10-g SAR test exclusion thresholds for 100 MHz to 6 GHz at test separation distances ≤ 50 mm are determined by:

$$[(\text{max. power of channel, including tune-up tolerance, mW}) / (\text{min. test separation distance, mm})] \cdot$$

$$[\sqrt{f(\text{GHz})}] \leq 3.0 \text{ for 1-g SAR and } \leq 7.5 \text{ for 10-g extremity SAR, where}$$

1. $f(\text{GHz})$ is the RF channel transmit frequency in GHz.

2. Power and distance are rounded to the nearest mW and mm before calculation.

3. The result is rounded to one decimal place for comparison.

4. When the minimum test separation distance is < 5 mm, a distance of **5 mm** is applied to determine SAR test Exclusion.

SAR test exclusion for the EUT edge considerations detail:**Distance < 50 mm**

The 1-g and 10-g SAR test exclusion thresholds for 100 MHz to 6 GHz at test separation distances ≤ 50 mm are determined by:

$$[(\text{max. power of channel, including tune-up tolerance, mW}) / (\text{min. test separation distance, mm})] \cdot$$

$$[\sqrt{f(\text{GHz})}] \leq 3.0 \text{ for 1-g SAR and } \leq 7.5 \text{ for 10-g extremity SAR, where}$$

1. $f(\text{GHz})$ is the RF channel transmit frequency in GHz.

2. Power and distance are rounded to the nearest mW and mm before calculation.

3. The result is rounded to one decimal place for comparison.

4. When the minimum test separation distance is < 5 mm, a distance of 5 mm is applied to determine SAR test Exclusion.

Distance > 50mm

At 100 MHz to 6 GHz and for *test separation distances* > 50 mm, the SAR test exclusion threshold is determined according to the following:

a) [Power allowed at numeric threshold for 50 mm in step 1) + (test separation distance - 50 mm)·(f(MHz)/150)] mW, at 100 MHz to 1500 MHz

b) [Power allowed at numeric threshold for 50 mm in step 1) + (test separation distance - 50 mm)·10] mW at > 1500 MHz and ≤ 6 GHz

SAR test exclusion for the EUT edge considerations Result

Mode	Left	Right	Top	Back	Bottom
CDMA 850	Required	Exclusion	Required	Required	Exclusion
CDMA 1900	Required	Exclusion	Required	Required	Exclusion
WCDMA Band 2	Required	Exclusion	Required	Required	Exclusion
WCDMA Band 5	Required	Exclusion	Required	Required	Exclusion
LTE Band 2	Required	Exclusion	Required	Required	Exclusion
LTE Band 4	Required	Exclusion	Required	Required	Exclusion
LTE Band 5	Required	Exclusion	Required	Required	Exclusion
LTE Band 13	Required	Exclusion	Required	Required	Exclusion
LTE Band 17	Required	Exclusion	Required	Required	Exclusion
2.4GHz WLAN(Main)	Exclusion	Required	Required	Required	Exclusion
2.4GHz WLAN(AUX)	Required	Exclusion	Required	Required	Exclusion
5.2GHz WLAN(Main)	Exclusion	Required	Required	Required	Exclusion
5.2GHz WLAN(AUX)	Required	Exclusion	Exclusion	Required	Exclusion
5.3GHz WLAN(Main)	Exclusion	Required	Required	Required	Exclusion
5.3GHz WLAN(AUX)	Required	Exclusion	Exclusion	Required	Exclusion
5.6GHz WLAN(Main)	Exclusion	Required	Required	Required	Exclusion
5.6GHz WLAN(AUX)	Required	Exclusion	Exclusion	Required	Exclusion
5.8GHz WLAN(Main)	Exclusion	Required	Required	Required	Exclusion
5.8GHz WLAN(AUX)	Required	Exclusion	Exclusion	Required	Exclusion

Note:

Required: The distance is less than **Test Exclusion Distance**, the SAR test is required.

Exclusion: The distance is large than **Test Exclusion Distance**, SAR test is not required.

Standalone SAR test exclusion considerations(RSS-102):

Mode	Frequency (MHz)	Pavg (dBm)	Antenna Gain(dBi)	e.i.r.p. (mW)	Test Exclusion Distance (mm)
CDMA 850	849	24.3	-0.1	269.2	>50
CDMA 1900	1910	24	3.6	575.4	>50
WCDMA Band 2	1910	23	3.6	457.1	>50
WCDMA Band 5	849	23	-0.1	199.5	>50
LTE Band 2	1910	23.9	3.6	562.3	>50
LTE Band 4	1755	23.8	3.1	489.8	>50
LTE Band 5	849	24.4	-0.1	275.4	>50
LTE Band 13	782	24.1	-0.3	257	>50
LTE Band 17	716	24	-3.6	251.2	>50
2.4GHz WLAN(Main)	2462	20	1.4	138	37
2.4GHz WLAN(AUX)	2462	20	3.0	199.5	43
5.2GHz WLAN(Main)	5240	14.8	3.55	68.4	32
5.2GHz WLAN(AUX)	5240	14.8	4.24	80.2	35
5.3GHz WLAN(Main)	5320	14.3	3.40	58.9	30
5.3GHz WLAN(AUX)	5320	14.7	4.70	87.1	37
5.6GHz WLAN(Main)	5720	14.8	3.54	68.2	34
5.6GHz WLAN(AUX)	5720	14.7	4.98	92.9	42
5.8GHz WLAN(Main)	5785	14.7	3.07	59.8	35
5.8GHz WLAN(AUX)	5785	14.5	4.86	86.3	41
Bluetooth	2480	6	3.0	7.9	11

NOTE:

- 1, When the operating frequency of the device is between two frequencies located in Table 1of **RSS-102 Issue 5 March 2015**, linear interpolation shall be applied for the applicable separation distance.
- 2, When the **Test Exclusion Distance** is farther than **50mm** and less than 200mm, testing for each edge is required.

SAR test exclusion for the EUT edge considerations Result

Mode	Back	Left Edge	Right Edge	Top Edge	Bottom Edge
CDMA 850	Required	Required	Required	Required	Required
CDMA 1900	Required	Required	Required	Required	Required
WCDMA Band 2	Required	Required	Required	Required	Required
WCDMA Band 5	Required	Required	Required	Required	Required
LTE Band 2	Required	Required	Required	Required	Required
LTE Band 4	Required	Required	Required	Required	Required
LTE Band 5	Required	Required	Required	Required	Required
LTE Band 13	Required	Required	Required	Required	Required
LTE Band 17	Required	Required	Required	Required	Required

Mode	Back	Left Edge	Right Edge	Top Edge	Bottom Edge
2.4GHz WLAN(Main)	Required	Exclusion	Required	Required	Exclusion
2.4GHz WLAN(Aux)	Required	Required	Exclusion	Required	Exclusion
5.2GHz WLAN(Main)	Required	Exclusion	Required	Required	Exclusion
5.2GHz WLAN(Aux)	Required	Required	Exclusion	Exclusion	Exclusion
5.3GHz WLAN(Main)	Required	Exclusion	Required	Required	Exclusion
5.3GHz WLAN(Aux)	Required	Required	Exclusion	Exclusion	Exclusion
5.6GHz WLAN(Main)	Required	Exclusion	Required	Required	Exclusion
5.6GHz WLAN(Aux)	Required	Required	Exclusion	Required	Exclusion
5.8GHz WLAN(Main)	Required	Exclusion	Required	Required	Exclusion
5.8GHz WLAN(Aux)	Required	Required	Exclusion	Required	Exclusion
Bluetooth	Required	Required	Exclusion	Exclusion	Exclusion

Note:

Required: The distance is less than **Test Exclusion Distance**, the SAR test is required.

Exclusion: The distance is large than **Test Exclusion Distance**, SAR test is not required.

Only when the distance from the antenna to edge is large than **Test Exclusion Distance specified** under **KDB and RSS-102 Issue 5 March 2015**, SAR test is not required

SAR Test Data**Environmental Conditions**

Temperature:	22.4-23.8 °C	22.5-23.7 °C	22.6-24.2 °C	22.3-23.7 °C
Relative Humidity:	43 %	42 %	44 %	42 %
ATM Pressure:	101.3 kPa	102.1 kPa	100.9 kPa	101.1 kPa
Test Date:	2017-12-12	2017-12-13	2018-01-02	2018-01-03

Temperature:	22.4-23.3 °C	22.6-23.6 °C	22.6-24.1 °C
Relative Humidity:	42 %	44 %	39 %
ATM Pressure:	100.8 kPa	102 kPa	101.8 kPa
Test Date:	2018-01-08	2018-01-09	2018-01-10

Testing was performed by Ken Zhu, Sam Liang, William Ye.

CDMA 850 EUT with Power Reduction (P-Sensor Triggered):

EUT Position	Frequency (MHz)	Test Mode	Max. Meas. Power (dBm)	Max. Rated Power (dBm)	1g SAR (W/kg)				
					Scaled Factor	Meas. SAR	Scaled SAR	Corrected SAR	Plot
Body-Top (0mm)	824.7	RTAP 153.6	19.22	19.5	1.067	0.202	0.216	0.22	1#
	836.52	RTAP 153.6	19.34	19.5	1.038	0.237	0.246	0.25	2#
	848.31	RTAP 153.6	19.28	19.5	1.052	0.215	0.226	0.23	3#

Test Date:2018/01/08

CDMA 850 EUT without Power Reduction (P-Sensor NOT Triggered):

EUT Position	Frequency (MHz)	Test Mode	Max. Meas. Power (dBm)	Max. Rated Power (dBm)	1g SAR (W/kg)				
					Scaled Factor	Meas. SAR	Scaled SAR	Corrected SAR	Plot
Body-Back (0mm) ^{Note*}	824.7	RTAP 153.6	/	/	/	/	/	/	/
	836.52	RTAP 153.6	24.19	24.3	1.026	0.023	0.024	0.02	4#
	848.31	RTAP 153.6	/	/	/	/	/	/	/
Body-Top (20mm)	824.7	RTAP 153.6	/	/	/	/	/	/	/
	836.52	RTAP 153.6	24.19	24.3	1.026	0.062	0.064	0.06	5#
	848.31	RTAP 153.6	/	/	/	/	/	/	/
Body-Left (0mm) ^{Note*}	824.7	RTAP 153.6	/	/	/	/	/	/	/
	836.52	RTAP 153.6	24.19	24.3	1.026	0.019	0.019	0.02	6#
	848.31	RTAP 153.6	/	/	/	/	/	/	/
Body-Right (0mm) ^{Note*}	824.7	RTAP 153.6	/	/	/	/	/	/	/
	836.52	RTAP 153.6	24.19	24.3	1.026	< 0.01	0.01	0.01	/
	848.31	RTAP 153.6	/	/	/	/	/	/	/
Body-Bottom (0mm) ^{Note*}	824.7	RTAP 153.6	/	/	/	/	/	/	/
	836.52	RTAP 153.6	24.19	24.3	1.026	< 0.01	0.01	0.01	/
	848.31	RTAP 153.6	/	/	/	/	/	/	/
Body-Top-Tilt	824.7	RTAP 153.6	/	/	/	/	/	/	/
	836.52	RTAP 153.6	24.19	24.3	1.026	0.065	0.067	0.07	7#
	848.31	RTAP 153.6	/	/	/	/	/	/	/

Test Date:2018/01/08

CDMA 1900 EUT with Power Reduction (P-Sensor Triggered):

EUT Position	Frequency (MHz)	Test Mode	Max. Meas. Power (dBm)	Max. Rated Power (dBm)	1g SAR (W/kg)				
					Scaled Factor	Meas. SAR	Scaled SAR	Corrected SAR	Plot
Body-Top (0mm)	1851.25	RTAP 153.6	19.07	19.2	1.03	1.08	1.112	1.15	8#
	1880	RTAP 153.6	18.83	19.2	1.089	0.998	1.087	1.09	9#
	1908.75	RTAP 153.6	18.76	19.2	1.107	1.07	1.184	1.18	10#

Test Date:2018/01/03

CDMA 1900 EUT without Power Reduction (P-Sensor NOT Triggered):

EUT Position	Frequency (MHz)	Test Mode	Max. Meas. Power (dBm)	Max. Rated Power (dBm)	1g SAR (W/kg)				
					Scaled Factor	Meas. SAR	Scaled SAR	Corrected SAR	Plot
Body-Back (0mm) ^{Note*}	1851.25	RTAP 153.6	/	/	/	/	/	/	/
	1880	RTAP 153.6	23.64	24	1.086	0.076	0.083	0.08	11#
	1908.75	RTAP 153.6	/	/	/	/	/	/	/
Body-Top (20mm)	1851.25	RTAP 153.6	/	/	/	/	/	/	/
	1880	RTAP 153.6	23.64	24	1.086	0.016	0.017	0.02	12#
	1908.75	RTAP 153.6	/	/	/	/	/	/	/
Body-Left (0mm) ^{Note*}	1851.25	RTAP 153.6	/	/	/	/	/	/	/
	1880	RTAP 153.6	23.64	24	1.086	0.014	0.015	0.02	13#
	1908.75	RTAP 153.6	/	/	/	/	/	/	/
Body-Right (0mm) ^{Note*}	1851.25	RTAP 153.6	/	/	/	/	/	/	/
	1880	RTAP 153.6	23.64	24	1.086	< 0.01	0.01	0.01	/
	1908.75	RTAP 153.6	/	/	/	/	/	/	/
Body-Bottom (0mm) ^{Note*}	1851.25	RTAP 153.6	/	/	/	/	/	/	/
	1880	RTAP 153.6	23.64	24	1.086	< 0.01	0.01	0.01	/
	1908.75	RTAP 153.6	/	/	/	/	/	/	/
Body-Top-Tilt	1851.25	RTAP 153.6	/	/	/	/	/	/	/
	1880	RTAP 153.6	23.64	24	1.086	0.122	0.132	0.13	14#
	1908.75	RTAP 153.6	/	/	/	/	/	/	/

Test Date:2018/01/03

WCDMA Band 2 EUT with Power Reduction (P-Sensor Triggered):

EUT Position	Frequency (MHz)	Test Mode	Max. Meas. Power (dBm)	Max. Rated Power (dBm)	1g SAR (W/kg)				
					Scaled Factor	Meas. SAR	Scaled SAR	Corrected SAR	Plot
Body-Top (0mm)	1852.4	RMC	18.06	18.2	1.033	0.943	0.974	1.01	15#
	1880	RMC	17.94	18.2	1.062	1.02	1.083	1.11	16#
	1907.6	RMC	17.92	18.2	1.067	1.04	1.110	1.12	17#

Test Date:2018/01/02

WCDMA Band 2 EUT without Power Reduction (P-Sensor NOT Triggered):

EUT Position	Frequency (MHz)	Test Mode	Max. Meas. Power (dBm)	Max. Rated Power (dBm)	1g SAR (W/kg)				
					Scaled Factor	Meas. SAR	Scaled SAR	Corrected SAR	Plot
Body-Back (0mm) ^{Note*}	1852.4	RMC	/	/	/	/	/	/	/
	1880	RMC	22.62	23	1.091	0.094	0.103	0.11	18#
	1907.6	RMC	/	/	/	/	/	/	/
Body-Top (20mm)	1852.4	RMC	/	/	/	/	/	/	/
	1880	RMC	22.62	23	1.091	0.106	0.116	0.12	19#
	1907.6	RMC	/	/	/	/	/	/	/
Body-Left (0mm) ^{Note*}	1852.4	RMC	/	/	/	/	/	/	/
	1880	RMC	22.62	23	1.091	0.063	0.069	0.07	20#
	1907.6	RMC	/	/	/	/	/	/	/
Body-Right (0mm) ^{Note*}	1852.4	RMC	/	/	/	/	/	/	/
	1880	RMC	22.62	23	1.091	< 0.01	0.01	0.01	/
	1907.6	RMC	/	/	/	/	/	/	/
Body-Bottom (0mm) ^{Note*}	1852.4	RMC	/	/	/	/	/	/	/
	1880	RMC	22.62	23	1.091	< 0.01	0.01	0.01	/
	1907.6	RMC	/	/	/	/	/	/	/
Body-Top-Tilt	1852.4	RMC	/	/	/	/	/	/	/
	1880	RMC	22.62	23	1.091	0.137	0.149	0.15	21#
	1907.6	RMC	/	/	/	/	/	/	/

Test Date:2018/01/02

WCDMA Band 5 EUT with Power Reduction (P-Sensor Triggered):

EUT Position	Frequency (MHz)	Test Mode	Max. Meas. Power (dBm)	Max. Rated Power (dBm)	1g SAR (W/kg)				
					Scaled Factor	Meas. SAR	Scaled SAR	Corrected SAR	Plot
Body-Top (0mm)	826.4	RMC	18.04	18.2	1.038	0.504	0.523	0.53	22#
	836.6	RMC	18.01	18.2	1.045	0.551	0.576	0.58	23#
	846.6	RMC	17.98	18.2	1.052	0.568	0.598	0.61	24#

Test Date:2018/01/09

WCDMA Band 5 EUT without Power Reduction (P-Sensor NOT Triggered):

EUT Position	Frequency (MHz)	Test Mode	Max. Meas. Power (dBm)	Max. Rated Power (dBm)	1g SAR (W/kg)				
					Scaled Factor	Meas. SAR	Scaled SAR	Corrected SAR	Plot
Body-Back (0mm) <small>Note*</small>	826.4	RMC	/	/	/	/	/	/	/
	836.6	RMC	22.88	23	1.028	0.062	0.064	0.06	25#
	846.6	RMC	/	/	/	/	/	/	/
Body-Top (20mm)	826.4	RMC	/	/	/	/	/	/	/
	836.6	RMC	22.88	23	1.028	0.084	0.086	0.09	26#
	846.6	RMC	/	/	/	/	/	/	/
Body-Left (0mm) <small>Note*</small>	826.4	RMC	/	/	/	/	/	/	/
	836.6	RMC	22.88	23	1.028	0.084	0.086	0.09	27#
	846.6	RMC	/	/	/	/	/	/	/
Body-Right (0mm) <small>Note*</small>	826.4	RMC	/	/	/	/	/	/	/
	836.6	RMC	22.88	23	1.028	< 0.01	0.01	0.01	/
	846.6	RMC	/	/	/	/	/	/	/
Body-Bottom (0mm) <small>Note*</small>	826.4	RMC	/	/	/	/	/	/	/
	836.6	RMC	22.88	23	1.028	< 0.01	0.01	0.01	/
	846.6	RMC	/	/	/	/	/	/	/
Body-Top-Tilt	826.4	RMC	/	/	/	/	/	/	/
	836.6	RMC	22.88	23	1.028	0.153	0.157	0.16	28#
	846.6	RMC	/	/	/	/	/	/	/

Test Date:2018/01/09

Note:

1. When the 1-g SAR is $\leq 0.8\text{W/kg}$, testing for other channels are optional.
2. The EUT transmit and receive through the same antenna while testing SAR.
3. The default test configuration is to measure SAR with an established radio link between the EUT and a communication test set using a 12.2 kbps RMC (reference measurement Channel) Configured in Test Loop Model.
4. KDB 941225 D01-Body SAR is not required for HSDPA/HSUPA/HSPA+/DC-HSDPA when the maximum average output of each RF channel is less than $\frac{1}{4}$ dB higher than measured 12.2kbps RMC or the maximum SAR for 12.2kbps RMC is $< 75\%$ of SAR limit.
5. When SAR or MPE is not measured at the maximum power level allowed for production units, the results must be scaled to the maximum tune-up tolerance limit according to the power applied to the individual channels tested to determine compliance.
6. For modes that peak SAR is too low to evaluate, a SAR value 0.01W/kg is considered as their Scaled SAR.
7. According to IEC 62209-2:2010 ,If the correction ΔSAR has a positive sign, the measured SAR results shall not be corrected.
8. The Long range Hopping antenna was removed, when the EUT was tested in top setup position, for sufficiently conservative consideration.

Note*: P- Sensor is not triggered when the distance is 0mm.

LTE Band 2 EUT with Power Reduction (P-Sensor Triggered):

EUT Position	Frequency (MHz)	Bandwidth (MHz)	Test Mode	Max. Meas. Power (dBm)	Max. Rated Power (dBm)	1g SAR (W/kg)				
						Scaled Factor	Meas. SAR	Scaled SAR	Corrected SAR	Plot
Body-Top (0mm)	1860	20	1RB	18.87	19.1	1.054	0.858	0.904	0.93	29#
	1880	20	1RB	18.79	19.1	1.074	0.829	0.89	0.91	30#
	1900	20	1RB	18.64	19.1	1.112	0.888	0.987	1.00	31#
	1880	20	50%RB	18.54	19.1	1.138	0.670	0.762	0.78	32#

Test Date:2018/01/02

LTE Band 2 EUT without Power Reduction (P-Sensor NOT Triggered):

EUT Position	Frequency (MHz)	Bandwidth (MHz)	Test Mode	Max. Meas. Power (dBm)	Max. Rated Power (dBm)	1g SAR (W/kg)				
						Scaled Factor	Meas. SAR	Scaled SAR	Corrected SAR	Plot
Body-Back (0mm) ^{Note*}	1860	20	1RB	/	/	/	/	/	/	/
	1880	20	1RB	23.39	23.9	1.125	0.106	0.119	0.12	33#
	1900	20	1RB	/	/	/	/	/	/	/
	1880	20	50%RB	23.71	23.9	1.045	0.085	0.089	0.09	34#
Body-Top (20mm)	1860	20	1RB	/	/	/	/	/	/	/
	1880	20	1RB	23.39	23.9	1.125	0.108	0.122	0.12	35#
	1900	20	1RB	/	/	/	/	/	/	/
	1880	20	50%RB	23.71	23.9	1.045	0.083	0.087	0.09	36#
Body-Left (0mm) ^{Note*}	1860	20	1RB	/	/	/	/	/	/	/
	1880	20	1RB	23.39	23.9	1.125	0.059	0.066	0.07	37#
	1900	20	1RB	/	/	/	/	/	/	/
	1880	20	50%RB	23.71	23.9	1.045	0.048	0.05	0.05	38#
Body-Right (0mm) ^{Note*}	1860	20	1RB	/	/	/	/	/	/	/
	1880	20	1RB	23.39	23.9	1.125	< 0.01	0.01	0.01	/
	1900	20	1RB	/	/	/	/	/	/	/
	1880	20	50%RB	23.71	23.9	1.045	< 0.01	0.01	0.01	/
Body-Bottom (0mm) ^{Note*}	1860	20	1RB	/	/	/	/	/	/	/
	1880	20	1RB	23.39	23.9	1.125	< 0.01	0.01	0.01	/
	1900	20	1RB	/	/	/	/	/	/	/
	1880	20	50%RB	23.71	23.9	1.045	< 0.01	0.01	0.01	/
Body-Top-Tilt	1860	20	1RB	/	/	/	/	/	/	/
	1880	20	1RB	23.39	23.9	1.125	0.144	0.162	0.17	39#
	1900	20	1RB	/	/	/	/	/	/	/
	1880	20	50%RB	23.71	23.9	1.045	0.109	0.114	0.12	40#

Test Date:2018/01/02

LTE Band 4 EUT with Power Reduction (P-Sensor Triggered):

EUT Position	Frequency (MHz)	Bandwidth (MHz)	Test Mode	Max. Meas. Power (dBm)	Max. Rated Power (dBm)	1g SAR (W/kg)				
						Scaled Factor	Meas. SAR	Scaled SAR	Corrected SAR	Plot
Body-Top (0mm)	1720	20	1RB	18.65	19	1.084	1.05	1.138	1.14	41#
	1732.5	20	1RB	18.2	19	1.202	1.01	1.214	1.21	42#
	1745	20	1RB	18.4	19	1.148	0.987	1.133	1.13	43#
	1732.5	20	50%RB	18.81	19	1.045	0.601	0.628	0.63	44#

Test Date:2018/01/10

LTE Band 4 EUT without Power Reduction (P-Sensor NOT Triggered):

EUT Position	Frequency (MHz)	Bandwidth (MHz)	Test Mode	Max. Meas. Power (dBm)	Max. Rated Power (dBm)	1g SAR (W/kg)				
						Scaled Factor	Meas. SAR	Scaled SAR	Corrected SAR	Plot
Body-Back (0mm) ^{Note*}	1720	20	1RB	/	/	/	/	/	/	/
	1732.5	20	1RB	23.74	23.8	1.014	0.080	0.081	0.08	45#
	1745	20	1RB	/	/	/	/	/	/	/
	1732.5	20	50%RB	23.41	23.8	1.094	0.063	0.069	0.07	46#
Body-Top (20mm)	1720	20	1RB	/	/	/	/	/	/	/
	1732.5	20	1RB	23.74	23.8	1.014	0.074	0.075	0.08	47#
	1745	20	1RB	/	/	/	/	/	/	/
	1732.5	20	50%RB	23.41	23.8	1.094	0.057	0.062	0.06	48#
Body-Left (0mm) ^{Note*}	1720	20	1RB	/	/	/	/	/	/	/
	1732.5	20	1RB	23.74	23.8	1.014	0.068	0.069	0.07	49#
	1745	20	1RB	/	/	/	/	/	/	/
	1732.5	20	50%RB	23.41	23.8	1.094	0.051	0.056	0.06	50#
Body-Right (0mm) ^{Note*}	1720	20	1RB	/	/	/	/	/	/	/
	1732.5	20	1RB	23.74	23.8	1.014	< 0.01	0.01	0.01	/
	1745	20	1RB	/	/	/	/	/	/	/
	1732.5	20	50%RB	23.41	23.8	1.094	< 0.01	0.01	0.01	/
Body-Bottom (0mm) ^{Note*}	1720	20	1RB	/	/	/	/	/	/	/
	1732.5	20	1RB	23.74	23.8	1.014	< 0.01	0.01	0.01	/
	1745	20	1RB	/	/	/	/	/	/	/
	1732.5	20	50%RB	23.41	23.8	1.094	< 0.01	0.01	0.01	/
Body-Top-Tilt	1720	20	1RB	/	/	/	/	/	/	/
	1732.5	20	1RB	23.74	23.8	1.014	0.482	0.489	0.49	51#
	1745	20	1RB	/	/	/	/	/	/	/
	1732.5	20	50%RB	23.41	23.8	1.094	0.372	0.407	0.41	52#

Test Date:2018/01/10

LTE Band 5 EUT with Power Reduction (P-Sensor Triggered):

EUT Position	Frequency (MHz)	Bandwidth (MHz)	Test Mode	Max. Meas. Power (dBm)	Max. Rated Power (dBm)	1g SAR (W/kg)				
						Scaled Factor	Meas. SAR	Scaled SAR	Corrected SAR	Plot
Body-Top (0mm)	829	10	1RB	18.77	19.4	1.156	0.535	0.618	0.63	53#
	836.5	10	1RB	18.85	19.4	1.135	0.567	0.644	0.65	54#
	844	10	1RB	18.96	19.4	1.107	0.559	0.619	0.63	55#
	836.5	10	50%RB	18.69	19.4	1.178	0.440	0.518	0.53	56#

Test Date:2018/01/09

LTE Band 5 EUT without Power Reduction (P-Sensor NOT Triggered):

EUT Position	Frequency (MHz)	Bandwidth (MHz)	Test Mode	Max. Meas. Power (dBm)	Max. Rated Power (dBm)	1g SAR (W/kg)				
						Scaled Factor	Meas. SAR	Scaled SAR	Corrected SAR	Plot
Body-Back (0mm) ^{Note*}	829	10	1RB	/	/	/	/	/	/	/
	836.5	10	1RB	23.73	24.4	1.167	0.062	0.072	0.07	57#
	844	10	1RB	/	/	/	/	/	/	/
	836.5	10	50%RB	23.82	24.4	1.143	0.049	0.056	0.06	58#
Body-Top (20mm)	829	10	1RB	/	/	/	/	/	/	/
	836.5	10	1RB	23.73	24.4	1.167	0.078	0.091	0.09	59#
	844	10	1RB	/	/	/	/	/	/	/
	836.5	10	50%RB	23.82	24.4	1.143	0.063	0.072	0.07	60#
Body-Left (0mm) ^{Note*}	829	10	1RB	/	/	/	/	/	/	/
	836.5	10	1RB	23.73	24.4	1.167	0.081	0.095	0.10	61#
	844	10	1RB	/	/	/	/	/	/	/
	836.5	10	50%RB	23.82	24.4	1.143	0.060	0.069	0.07	62#
Body-Right (0mm) ^{Note*}	829	10	1RB	/	/	/	/	/	/	/
	836.5	10	1RB	23.73	24.4	1.167	< 0.01	0.01	0.01	/
	844	10	1RB	/	/	/	/	/	/	/
	836.5	10	50%RB	23.82	24.4	1.143	< 0.01	0.01	0.01	/
Body-Bottom (0mm) ^{Note*}	829	10	1RB	/	/	/	/	/	/	/
	836.5	10	1RB	23.73	24.4	1.167	< 0.01	0.01	0.01	/
	844	10	1RB	/	/	/	/	/	/	/
	836.5	10	50%RB	23.82	24.4	1.143	< 0.01	0.01	0.01	/
Body-Top-Tilt	829	10	1RB	/	/	/	/	/	/	/
	836.5	10	1RB	23.73	24.4	1.167	0.142	0.166	0.17	63#
	844	10	1RB	/	/	/	/	/	/	/
	836.5	10	50%RB	23.82	24.4	1.143	0.110	0.126	0.13	64#

Test Date:2018/01/09

LTE Band 13 EUT with Power Reduction (P-Sensor Triggered):

EUT Position	Frequency (MHz)	Bandwidth (MHz)	Test Mode	Max. Meas. Power (dBm)	Max. Rated Power (dBm)	1g SAR (W/kg)				
						Scaled Factor	Meas. SAR	Scaled SAR	Corrected SAR	Plot
Body-Top (0mm)	782	10	1RB	18.52	19.3	1.197	0.424	0.508	0.52	65#
	782	10	50%RB	18.98	19.3	1.076	0.330	0.355	0.37	66#

Test Date:2018/01/03

LTE Band 13 EUT without Power Reduction (P-Sensor NOT Triggered):

EUT Position	Frequency (MHz)	Bandwidth (MHz)	Test Mode	Max. Meas. Power (dBm)	Max. Rated Power (dBm)	1g SAR (W/kg)				
						Scaled Factor	Meas. SAR	Scaled SAR	Corrected SAR	Plot
Body-Back (0mm) ^{Note*}	782	10	1RB	23.62	24.1	1.117	0.050	0.056	0.06	67#
	782	10	50%RB	23.56	24.1	1.132	0.027	0.031	0.03	68#
Body-Top (20mm)	782	10	1RB	23.62	24.1	1.117	0.122	0.136	0.14	69#
	782	10	50%RB	23.56	24.1	1.132	0.094	0.106	0.11	70#
Body-Left (0mm) ^{Note*}	782	10	1RB	23.62	24.1	1.117	0.034	0.038	0.04	71#
	782	10	50%RB	23.56	24.1	1.132	0.027	0.031	0.03	72#
Body-Right (0mm) ^{Note*}	782	10	1RB	23.62	24.1	1.117	< 0.01	0.01	0.01	/
	782	10	50%RB	23.56	24.1	1.132	< 0.01	0.01	0.01	/
Body-Bottom (0mm) ^{Note*}	782	10	1RB	23.62	24.1	1.117	< 0.01	0.01	0.01	/
	782	10	50%RB	23.56	24.1	1.132	< 0.01	0.01	0.01	/
Body-Top-Tilt	782	10	1RB	23.62	24.1	1.117	0.170	0.19	0.20	73#
	782	10	50%RB	23.56	24.1	1.132	0.123	0.139	0.14	74#

Test Date:2018/01/03

LTE Band 17 EUT with Power Reduction (P-Sensor Triggered):

EUT Position	Frequency (MHz)	Bandwidth (MHz)	Test Mode	Max. Meas. Power (dBm)	Max. Rated Power (dBm)	1g SAR (W/kg)				Plot
						Scaled Factor	Meas. SAR	Scaled SAR	Corrected SAR	
Body-Top (0mm)	709	10	1RB	18.91	19.2	1.069	0.299	0.320	0.33	75#
	710	10	1RB	18.43	19.2	1.194	0.290	0.346	0.35	76#
	711	10	1RB	18.72	19.2	1.117	0.286	0.319	0.32	77#
	710	10	50%RB	19.09	19.2	1.026	0.212	0.218	0.22	78#

Test Date:2018/01/08

LTE Band 17 EUT without Power Reduction (P-Sensor NOT Triggered):

EUT Position	Frequency (MHz)	Bandwidth (MHz)	Test Mode	Max. Meas. Power (dBm)	Max. Rated Power (dBm)	1g SAR (W/kg)				Plot
						Scaled Factor	Meas. SAR	Scaled SAR	Corrected SAR	
Body-Back (0mm) ^{Note*}	709	10	1RB	/	/	/	/	/	/	/
	710	10	1RB	23.55	24	1.109	0.037	0.041	0.04	79#
	711	10	1RB	/	/	/	/	/	/	/
	710	10	50%RB	23.99	24	1.002	0.029	0.029	0.03	80#
Body-Top (20mm)	709	10	1RB	/	/	/	/	/	/	/
	710	10	1RB	23.55	24	1.109	0.075	0.083	0.08	81#
	711	10	1RB	/	/	/	/	/	/	/
	710	10	50%RB	23.99	24	1.002	0.062	0.062	0.06	82#
Body-Left (0mm) ^{Note*}	709	10	1RB	/	/	/	/	/	/	/
	710	10	1RB	23.55	24	1.109	0.019	0.021	0.02	83#
	711	10	1RB	/	/	/	/	/	/	/
	710	10	50%RB	23.99	24	1.002	0.015	0.015	0.02	84#
Body-Right (0mm) ^{Note*}	709	10	1RB	/	/	/	/	/	/	/
	710	10	1RB	23.55	24	1.109	< 0.01	0.01	0.01	/
	711	10	1RB	/	/	/	/	/	/	/
	710	10	50%RB	23.99	24	1.002	< 0.01	0.01	0.01	/
Body-Bottom (0mm) ^{Note*}	709	10	1RB	/	/	/	/	/	/	/
	710	10	1RB	23.55	24	1.109	< 0.01	0.01	0.01	/
	711	10	1RB	/	/	/	/	/	/	/
	710	10	50%RB	23.99	24	1.002	< 0.01	0.01	0.01	/
Body-Top-Tilt	709	10	1RB	/	/	/	/	/	/	/
	710	10	1RB	23.55	24	1.109	0.110	0.122	0.12	85#
	711	10	1RB	/	/	/	/	/	/	/
	710	10	50%RB	23.99	24	1.002	0.084	0.084	0.09	86#

Test Date:2018/01/08

Note:

1. SAR for LTE band exposure configurations is measured according to the procedures of KDB 941225 D05 SAR for LTE Devices v02.
2. KDB941225D05- Start with the largest channel bandwidth and measure SAR for QPSK with 1 RB allocation, using the RB offset and required test channel combination with the highest maximum output power among RB offset the upper edge, middle and lower edge of each required test channel.
3. When the 1-g SAR is $\leq 0.8\text{W/kg}$, testing for other channels are optional.
4. Worst case SAR for 50% RB allocation is selected to be tested.
5. KDB941225D05- For QPSK with 100% RB allocation, SAR is not required when the highest maximum output power for 100 % RB allocation is less than the highest maximum output power in 50% and 1 RB allocations and the highest reported SAR for 1 RB and 50% RB allocation are $\leq 0.8\text{ W/kg}$.
6. KDB941225D05-For QPSK with 100% RB allocation, when the reported SAR measured for the Highest output power channel is $< 1.45\text{ W/kg}$, tests for the remaining required test channels are optional.
7. KDB941225D05- other channel bandwidths SAR test is required when the highest maximum output power of a configuration requiring testing in the smaller channel bandwidth is $> \frac{1}{2}\text{ dB}$ higher than the equivalent channel configurations in the largest channel bandwidth configuration or the reported SAR of a configuration for the largest channel bandwidth is $> 1.45\text{ W/kg}$.
8. KDB941225D05-SAR for higher order modulation is required only when the highest maximum output power for the configuration in the higher order modulation is $> \frac{1}{2}\text{ dB}$ higher than the same configuration in QPSK or when the reported SAR for the QPSK configuration is $> 1.45\text{ W/kg}$
9. KDB 648474 D04-When the peak SAR located in regions that probe is unable to access, a flat phantom is used for SAR measurement.
10. For modes that peak SAR is too low to evaluate, a SAR value 0.01W/kg is considered as their Scaled SAR.
11. According to IEC 62209-2:2010 ,If the correction ΔSAR has a positive sign, the measured SAR results shall not be corrected.
12. The Long range Hopping antenna was removed, when the EUT was tested in top setup position, for sufficiently conservative consideration.

Note*: P- Sensor is not triggered when the distance is 0mm.

WLAN 2.4G:

Antenna Chain 0(Main):

EUT Position	Frequency (MHz)	Test Mode	Max. Meas. Power (dBm)	Max. Rated Power (dBm)	1g SAR (W/kg)				
					Scaled Factor	Meas. SAR	Scaled SAR	Corrected SAR	Plot
Body-Back (0mm)	2412	802.11b	/	/	/	/	/	/	/
	2437	802.11b	19.82	20	1.042	0.157	0.164	0.17	87#
	2462	802.11b	/	/	/	/	/	/	/
Body-Top (0mm)	2412	802.11b	/	/	/	/	/	/	/
	2437	802.11b	19.82	20	1.042	0.203	0.212	0.21	88#
	2462	802.11b	/	/	/	/	/	/	/
Body-Right (0mm)	2412	802.11b	19.87	20	1.03	0.323	0.333	0.34	89#
	2437	802.11b	19.82	20	1.042	0.387	0.403	0.41	90#
	2462	802.11b	19.72	20	1.067	0.402	0.429	0.43	91#

Test Date:2018/01/10

Antenna Chain 1(Aux):

EUT Position	Frequency (MHz)	Test Mode	Max. Meas. Power (dBm)	Max. Rated Power (dBm)	1g SAR (W/kg)				
					Scaled Factor	Meas. SAR	Scaled SAR	Corrected SAR	Plot
Body-Back (0mm)	2412	802.11b	/	/	/	/	/	/	/
	2437	802.11b	19.59	20	1.099	0.079	0.087	0.09	92#
	2462	802.11b	/	/	/	/	/	/	/
Body-Top (0mm)	2412	802.11b	/	/	/	/	/	/	/
	2437	802.11b	19.59	20	1.099	< 0.01	0.01	0.01	/
	2462	802.11b	/	/	/	/	/	/	/
Body-Left (0mm)	2412	802.11b	19.45	20	1.135	0.198	0.225	0.23	93#
	2437	802.11b	19.59	20	1.099	0.204	0.224	0.23	94#
	2462	802.11b	19.76	20	1.057	0.231	0.244	0.24	95#

Test Date:2018/01/10

Note:

1. When the 1-g SAR is $\leq 0.8W/kg$, testing for other channels are optional.
2. When SAR or MPE is not measured at the maximum power level allowed for production units, the results must be scaled to the maximum tune-up tolerance limit according to the power applied to the individual channels tested to determine compliance.
3. KDB 248227 D01-SAR is not required for 2.4 GHz OFDM when the highest reported SAR for DSSS is adjusted by the ratio of OFDM to DSSS specified maximum output power and the adjusted SAR is $\leq 1.2 W/kg$.
4. For modes that peak SAR is too low to evaluate, a SAR value 0.01W/kg is considered as their Scaled SAR.
5. According to IEC 62209-2:2010 ,If the correction ΔSAR has a positive sign, the measured SAR results shall not be corrected.
6. The Long range Hopping antenna was removed, when the EUT was tested in top setup position, for sufficiently conservative consideration.

WLAN 5.2G(5150-5250MHz):

Antenna Chain 0(Main):

EUT Position	Frequency (MHz)	Test Mode	Max. Meas. Power (dBm)	Max. Rated Power (dBm)	1g SAR (W/kg)				
					Scaled Factor	Meas. SAR	Scaled SAR	Corrected SAR	Plot
Body-Back (0mm)	5180	802.11a	/	/	/	/	/	/	/
	5200	802.11a	14.58	14.8	1.052	0.111	0.117	0.12	96#
	5240	802.11a	/	/	/	/	/	/	/
Body-Top (0mm)	5180	802.11a	/	/	/	/	/	/	/
	5200	802.11a	14.58	14.8	1.052	0.326	0.343	0.35	97#
	5240	802.11a	/	/	/	/	/	/	/
Body-Right (0mm)	5180	802.11a	14.50	14.8	1.072	0.614	0.658	0.66	98#
	5200	802.11a	14.58	14.8	1.052	0.634	0.667	0.67	99#
	5240	802.11a	14.47	14.8	1.079	0.500	0.54	0.54	100#

Test Date:2017/12/12

Antenna Chain 1(Aux):

EUT Position	Frequency (MHz)	Test Mode	Max. Meas. Power (dBm)	Max. Rated Power (dBm)	1g SAR (W/kg)				
					Scaled Factor	Meas. SAR	Scaled SAR	Corrected SAR	Plot
Body-Back (0mm)	5180	802.11a	/	/	/	/	/	/	/
	5200	802.11a	14.50	14.8	1.072	0.112	0.120	0.12	101#
	5240	802.11a	/	/	/	/	/	/	/
Body-Left (0mm)	5180	802.11a	14.37	14.8	1.104	0.312	0.344	0.35	102#
	5200	802.11a	14.50	14.8	1.072	0.306	0.328	0.33	103#
	5240	802.11a	14.21	14.8	1.146	0.370	0.424	0.43	104#

Test Date:2017/12/12

WLAN 5.3G(5250-5350MHz):

Antenna Chain 0(Main):

EUT Position	Frequency (MHz)	Test Mode	Max. Meas. Power (dBm)	Max. Rated Power (dBm)	1g SAR (W/kg)				
					Scaled Factor	Meas. SAR	Scaled SAR	Corrected SAR	Plot
Body-Back (0mm)	5260	802.11a	/	/	/	/	/	/	/
	5280	802.11a	14.01	14.3	1.069	0.097	0.104	0.10	105#
	5320	802.11a	/	/	/	/	/	/	/
Body-Top (0mm)	5260	802.11a	/	/	/	/	/	/	/
	5280	802.11a	14.01	14.3	1.069	0.218	0.233	0.23	106#
	5320	802.11a	/	/	/	/	/	/	/
Body-Right (0mm)	5260	802.11a	14.15	14.3	1.035	0.471	0.487	0.49	107#
	5280	802.11a	14.01	14.3	1.069	0.427	0.456	0.46	108#
	5320	802.11a	13.87	14.3	1.104	0.458	0.506	0.51	109#

Test Date:2017/12/12

Antenna Chain 1(Aux):

EUT Position	Frequency (MHz)	Test Mode	Max. Meas. Power (dBm)	Max. Rated Power (dBm)	1g SAR (W/kg)				
					Scaled Factor	Meas. SAR	Scaled SAR	Corrected SAR	Plot
Body-Back (0mm)	5260	802.11a	/	/	/	/	/	/	/
	5280	802.11a	14.22	14.7	1.117	0.123	0.137	0.14	110#
	5320	802.11a	/	/	/	/	/	/	/
Body-Left (0mm)	5260	802.11a	14.54	14.7	1.038	0.425	0.441	0.44	111#
	5280	802.11a	14.22	14.7	1.117	0.385	0.43	0.43	112#
	5320	802.11a	14.06	14.7	1.159	0.386	0.447	0.45	113#

Test Date:2017/12/12

WLAN 5.6G(5470-5725MHz):

Antenna Chain 0(Main):

EUT Position	Frequency (MHz)	Test Mode	Max. Meas. Power (dBm)	Max. Rated Power (dBm)	1g SAR (W/kg)				
					Scaled Factor	Meas. SAR	Scaled SAR	Corrected SAR	Plot
Body-Back (0mm)	5500	802.11a	/	/	/	/	/	/	/
	5580	802.11a	14.68	14.8	1.028	0.169	0.174	0.17	114#
	5700	802.11a	/	/	/	/	/	/	/
	5720	802.11a	/	/	/	/	/	/	/
Body-Top (0mm)	5500	802.11a	/	/	/	/	/	/	/
	5580	802.11a	14.68	14.8	1.028	0.319	0.328	0.33	115#
	5700	802.11a	/	/	/	/	/	/	/
	5720	802.11a	/	/	/	/	/	/	/
Body-Right (0mm)	5500	802.11a	14.40	14.8	1.096	0.877	0.961	0.96	116#
	5580	802.11a	14.68	14.8	1.028	0.824	0.847	0.85	117#
	5700	802.11a	13.91	14.8	1.227	0.631	0.774	0.77	118#
	5720	802.11a	14.27	14.8	1.13	0.603	0.681	0.68	119#

Test Date:2017/12/13

Antenna Chain 1(Aux):

EUT Position	Frequency (MHz)	Test Mode	Max. Meas. Power (dBm)	Max. Rated Power (dBm)	1g SAR (W/kg)				
					Scaled Factor	Meas. SAR	Scaled SAR	Corrected SAR	Plot
Body-Back (0mm)	5500	802.11a	/	/	/	/	/	/	/
	5580	802.11a	14.36	14.7	1.081	0.148	0.16	0.16	120#
	5700	802.11a	/	/	/	/	/	/	/
	5720	802.11a	/	/	/	/	/	/	/
Body-Top (0mm)	5500	802.11a	/	/	/	/	/	/	/
	5580	802.11a	14.36	14.7	1.081	< 0.01	0.01	0.01	/
	5700	802.11a	/	/	/	/	/	/	/
	5720	802.11a	/	/	/	/	/	/	/
Body-Left (0mm)	5500	802.11a	14.29	14.7	1.099	0.454	0.499	0.50	121#
	5580	802.11a	14.36	14.7	1.081	0.412	0.445	0.45	122#
	5700	802.11a	14.34	14.7	1.086	0.388	0.421	0.42	123#
	5720	802.11a	14.50	14.7	1.047	0.401	0.420	0.42	124#

Test Date:2017/12/13

WLAN 5.8G(5725-5850MHz):

Antenna Chain 0(Main):

EUT Position	Frequency (MHz)	Test Mode	Max. Meas. Power (dBm)	Max. Rated Power (dBm)	1g SAR (W/kg)				
					Scaled Factor	Meas. SAR	Scaled SAR	Corrected SAR	Plot
Body-Back (0mm)	5745	802.11a	/	/	/	/	/	/	/
	5785	802.11a	14.10	14.7	1.148	0.138	0.158	0.16	125#
	5825	802.11a	/	/	/	/	/	/	/
Body-Top (0mm)	5745	802.11a	/	/	/	/	/	/	/
	5785	802.11a	14.10	14.7	1.148	0.312	0.358	0.36	126#
	5825	802.11a	/	/	/	/	/	/	/
Body-Right (0mm)	5745	802.11a	14.59	14.7	1.026	0.704	0.722	0.72	127#
	5785	802.11a	14.10	14.7	1.148	0.667	0.766	0.77	128#
	5825	802.11a	14.38	14.7	1.076	0.680	0.732	0.73	129#

Test Date:2017/12/13

Antenna Chain 1(Aux):

EUT Position	Frequency (MHz)	Test Mode	Max. Meas. Power (dBm)	Max. Rated Power (dBm)	1g SAR (W/kg)				
					Scaled Factor	Meas. SAR	Scaled SAR	Corrected SAR	Plot
Body-Back (0mm)	5745	802.11a	/	/	/	/	/	/	/
	5785	802.11a	14.16	14.5	1.081	0.127	0.137	0.14	130#
	5825	802.11a	/	/	/	/	/	/	/
Body-Top (0mm)	5745	802.11a	/	/	/	/	/	/	/
	5785	802.11a	14.16	14.5	1.081	< 0.01	0.01	0.01	/
	5825	802.11a	/	/	/	/	/	/	/
Body-Left (0mm)	5745	802.11a	14.37	14.5	1.03	0.392	0.404	0.41	131#
	5785	802.11a	14.16	14.5	1.081	0.369	0.399	0.40	132#
	5825	802.11a	14.18	14.5	1.076	0.306	0.329	0.33	133#

Test Date:2017/12/13

Note:

1. When the 1-g SAR is $\leq 0.8W/kg$, testing for other channels are optional.
2. When SAR or MPE is not measured at the maximum power level allowed for production units, the results must be scaled to the maximum tune-up tolerance limit according to the power applied to the individual channels tested to determine compliance.
3. For modes that peak SAR is too low to evaluate, a SAR value 0.01W/kg is considered as their Scaled SAR.
4. According to IEC 62209-2:2010 ,If the correction ΔSAR has a positive sign, the measured SAR results shall not be corrected.
5. The Long range Hopping antenna was removed, when the EUT was tested in top setup position, for sufficiently conservative consideration.

Bluetooth:

Antenna Chain 1(Aux):

EUT Position	Frequency (MHz)	Test Mode	Max. Meas. Power (dBm)	Max. Rated Power (dBm)	1g SAR (W/kg)				
					Scaled Factor	Meas. SAR	Scaled SAR	Corrected SAR	Plot
Body-Back (0mm)	2402	GFSK	/	/	/	/	/	/	/
	2441	GFSK	5.41	6	1.146	< 0.01	0.01	0.01	/
	2480	GFSK	/	/	/	/	/	/	/
Body-Left (0mm)	2402	GFSK	5.57	6	1.104	0.026	0.029	0.03	134#
	2441	GFSK	5.41	6	1.146	0.039	0.045	0.05	135#
	2480	GFSK	5.90	6	1.023	0.037	0.038	0.04	136#

Test Date:2018/01/10

Note:

1. When the 1-g SAR is $\leq 0.8W/kg$, testing for other channels are optional.
2. When SAR or MPE is not measured at the maximum power level allowed for production units, the results must be scaled to the maximum tune-up tolerance limit according to the power applied to the individual channels tested to determine compliance.
3. For modes that peak SAR is too low to evaluate, a SAR value 0.01W/kg is considered as their Scaled SAR.
4. According to IEC 62209-2:2010 ,If the correction ΔSAR has a positive sign, the measured SAR results shall not be corrected.
5. The long ranger BT is an external antenna which located in the back of the tablet,it is setted on the tripod when normal using the separation distance of at least 20 centimeters is normally maintained between its radiating structure and the body of the user or nearby persons,so the SAR testing is not required.

Corrected SAR Evaluation

62209-2 © IEC:2010

– 89 –

Annex F
(normative)**SAR correction for deviations of complex permittivity from targets****F.2 SAR correction formula**

From [13] and [14], a linear relationship was found between the percent change in SAR (denoted ΔSAR) and the percent change in the permittivity and conductivity from the target values in Table 1 (denoted $\Delta \epsilon_r$ and $\Delta \sigma$, respectively). This linear relationship agrees with the results of Kuster and Balzano [48] and Bit-Babik et al. [2]. The relationship is given by:

$$\Delta SAR = c_\epsilon \Delta \epsilon_r + c_\sigma \Delta \sigma \quad (F.1)$$

where

$c_\epsilon = \partial(\Delta SAR)/\partial(\Delta \epsilon)$ is the coefficients representing the sensitivity of SAR to permittivity where SAR is normalized to output power;

$c_\sigma = \partial(\Delta SAR)/\partial(\Delta \sigma)$ is the coefficients representing the sensitivity of SAR to conductivity, where SAR is normalized to output power.

The values of c_ϵ and c_σ have a simple relationship with frequency that can be described using polynomial equations. For the 1 g averaged SAR c_ϵ and c_σ are given by

$$c_\epsilon = -7,854 \times 10^{-4} f^3 + 9,402 \times 10^{-3} f^2 - 2,742 \times 10^{-2} f - 0,202 \ 6 \quad (F.2)$$

$$c_\sigma = 9,804 \times 10^{-3} f^3 - 8,661 \times 10^{-2} f^2 + 2,981 \times 10^{-2} f + 0,782 \ 9 \quad (F.3)$$

where

f is the frequency in GHz.

For the 10 g averaged SAR, the variables c_ϵ and c_σ are given by:

$$c_\epsilon = 3,456 \times 10^{-3} f^3 - 3,531 \times 10^{-2} f^2 + 7,675 \times 10^{-2} f - 0,186 \ 0 \quad (F.4)$$

$$c_\sigma = 4,479 \times 10^{-3} f^3 - 1,586 \times 10^{-2} f^2 - 0,197 \ 2 f + 0,771 \ 7 \quad (F.5)$$

Corrected SAR Evaluation Table

Frequency (MHz)	Liquid Type	C ϵ	$\Delta \epsilon r$	C δ	$\Delta \delta$	Δ SAR (%)
1852.4	Body	-0.226	2.37	0.603	-4.47	-3.23
1860	Body	-0.226	2.02	0.602	-3.49	-2.56
1880	Body	-0.226	1.74	0.598	-3.22	-2.32
1900	Body	-0.226	1.6	0.594	-1.91	-1.50
1907.6	Body	-0.226	1.43	0.593	-0.39	-0.55

*Test Date 2018-01-02.

Frequency (MHz)	Liquid Type	C ϵ	$\Delta \epsilon r$	C δ	$\Delta \delta$	Δ SAR (%)
750	Body	-0.218	2.78	0.761	1.56	0.58
782	Body	-0.219	2.54	0.758	4.74	3.04
1851.25	Body	-0.226	2.45	0.603	-4.08	-3.02
1880	Body	-0.226	1.68	0.598	-1.97	-1.56
1900	Body	-0.226	1.62	0.594	-0.13	-0.44
1908.75	Body	-0.226	1.37	0.592	0.99	0.28

*Test Date 2018-01-03.

Frequency (MHz)	Liquid Type	C ϵ	$\Delta \epsilon r$	C δ	$\Delta \delta$	Δ SAR (%)
709	Body	-0.218	2.7	0.764	-1.77	-1.94
710	Body	-0.218	2.69	0.764	-1.46	-1.70
711	Body	-0.218	2.68	0.764	-1.35	-1.61
750	Body	-0.218	2.89	0.761	-0.1	-0.71
824.7	Body	-0.219	2.89	0.754	-0.72	-1.18
836.52	Body	-0.219	2.13	0.753	-0.62	-0.93
848.31	Body	-0.220	2.05	0.752	-1.52	-1.59

*Test Date 2018-01-08.

Frequency (MHz)	Liquid Type	C ϵ	$\Delta \epsilon r$	C δ	$\Delta \delta$	Δ SAR (%)
750	Body	-0.218	3.63	0.761	-1.56	-1.98
826.4	Body	-0.219	4.05	0.754	-1.75	-2.21
829	Body	-0.219	4.03	0.754	-1.24	-1.82
836.5	Body	-0.219	3.8	0.753	-0.82	-1.45
836.6	Body	-0.219	3.8	0.753	-0.31	-1.07
844	Body	-0.220	3.72	0.752	-1.22	-1.73
846.6	Body	-0.220	3.33	0.752	-0.61	-1.19

*Test Date 2018-01-09.

Frequency (MHz)	Liquid Type	C ε	Δ ε r	C δ	Δ δ	ΔSAR (%)
1720	Body	-0.226	-1.29	0.628	2.86	2.09
1732.5	Body	-0.226	-1.3	0.626	3.11	2.24
1745	Body	-0.226	-1.4	0.623	3.29	2.37
1750	Body	-0.226	-1.53	0.622	3.56	2.56
2402	Body	-0.225	3.17	0.491	-1.68	-1.54
2412	Body	-0.225	3.05	0.489	-0.05	-0.71
2437	Body	-0.225	2.87	0.483	-0.26	-0.77
2441	Body	-0.225	1.34	0.482	-0.21	-0.40
2450	Body	-0.225	-0.06	0.480	0.31	0.16
2462	Body	-0.225	-1.5	0.478	0.36	0.51
2480	Body	-0.225	-2	0.474	-0.35	0.28
5180	Body	-0.202	3.43	-0.024	1.53	-0.73
5200	Body	-0.201	3.36	-0.026	1.83	-0.72
5240	Body	-0.201	1.95	-0.028	1.29	-0.43
5250	Body	-0.201	1.88	-0.029	3.79	-0.49
5260	Body	-0.201	1.38	-0.030	3.87	-0.39
5280	Body	-0.201	1.23	-0.031	3.97	-0.37
5320	Body	-0.201	1.18	-0.034	4.4	-0.38
5500	Body	-0.200	2.5	-0.042	-3.08	-0.37
5580	Body	-0.199	0.54	-0.044	-3.95	0.07
5600	Body	-0.199	0.07	-0.045	-2.1	0.08
5700	Body	-0.199	0.29	-0.046	-2.98	0.08
5720	Body	-0.199	-0.11	-0.046	-1.49	0.09
5745	Body	-0.199	1.79	-0.045	-1.33	-0.30
5785	Body	-0.199	1.65	-0.045	-1.39	-0.27
5800	Body	-0.199	1.62	-0.045	-1.63	-0.25
5825	Body	-0.199	1.07	-0.044	-1.1	-0.16

$$\Delta SAR = c_{\epsilon} \Delta \epsilon_r + c_{\sigma} \Delta \sigma$$

$$c_{\epsilon} = -7,854 \times 10^{-4} f^3 + 9,402 \times 10^{-3} f^2 - 2,742 \times 10^{-2} f - 0,2026$$

$$c_{\sigma} = 9,804 \times 10^{-3} f^3 - 8,661 \times 10^{-2} f^2 + 2,981 \times 10^{-2} f + 0,7829$$

where

f is the frequency in GHz.

$$\text{Corrected SAR} = \text{Measured SAR} * ((100 + (\Delta SAR \times -1)) / 100)$$

SAR Measurement Variability

In accordance with published RF Exposure KDB procedure 865664 D01 SAR measurement 100 MHz to 6 GHz v01. These additional measurements are repeated after the completion of all measurements requiring the same head or body tissue-equivalent medium in a frequency band. The test device should be returned to ambient conditions (normal room temperature) with the battery fully charged before it is re-mounted on the device holder for the repeated measurement(s) to minimize any unexpected variations in the repeated results

- 1) Repeated measurement is not required when the original highest measured SAR is < 0.80 W/kg; steps 2) through 4) do not apply.
- 2) When the original highest measured SAR is ≥ 0.80 W/kg, repeat that measurement once.
- 3) Perform a second repeated measurement only if the ratio of largest to smallest SAR for the original and first repeated measurements is > 1.20 or when the original or repeated measurement is ≥ 1.45 W/kg (~ 10% from the 1-g SAR limit).
- 4) Perform a third repeated measurement only if the original, first or second repeated measurement is ≥ 1.5 W/kg and the ratio of largest to smallest SAR for the original, first and second repeated measurements is > 1.20.

Note: The same procedures should be adapted for measurements according to extremity and occupational exposure limits by applying a factor of 2.5 for extremity exposure and a factor of 5 for occupational exposure to the corresponding SAR thresholds.

The Highest Measured SAR Configuration in Each Frequency Band

Body

Frequency Band	Freq.(MHz)	EUT Position	Meas. SAR (W/kg)		Largest to Smallest SAR Ratio
			Original	Repeated	
(1650~1850MHz) LTE Band 4	1720	Body-Top	1.05	1.02	1.03
(1850~2000MHz) CDMA 1900	1851.25	Body-Top	1.08	1.05	1.03
(5470~5725MHz) WLAN 5.6G	5500	Body-Right	0.877	0.843	1.04

Note:

1. Second Repeated Measurement is not required since the ratio of the largest to smallest SAR for the original and first repeated measurement is not > 1.20.
2. The measured SAR results **do not** have to be scaled to the maximum tune-up tolerance to determine if repeated measurements are required.
3. SAR measurement variability must be assessed for each frequency band, which is determined by the **SAR probe calibration point and tissue-equivalent medium** used for the device measurements..

SAR SIMULTANEOUS TRANSMISSION DESCRIPTION

Simultaneous Transmission:

Description of Simultaneous Transmit Capabilities		
Transmitter Combination	Simultaneous?	Hotspot?
WWAN + Bluetooth	√	×
WWAN + WLAN Main	√	√
WWAN + WLAN AUX	√	√
WWAN + Bluetooth +WLAN Main	√	√
WWAN + WLAN Main +WLAN AUX	√	√

Note: KDB 616217 D04-The standalone and simultaneous transmission SAR tests required for tablets are more conservative than the hotspot mode use configurations; therefore, additional testing for hotspot SAR is **not required**.

Simultaneous SAR test exclusion considerations:

WWAN + Bluetooth:

Mode (SAR1+SAR2)	Position	Reported SAR (W/kg)		Σ SAR < 1.6W/kg
		SAR1	SAR2	
CDMA 850+ Bluetooth	Body-Back	0.02	0.01	0.03
	Body-Top	0.25	/	/
	Body-Left	0.02	0.05	0.07
CDMA 1900+ Bluetooth	Body-Back	0.08	0.01	0.09
	Body-Top	1.18	/	/
	Body-Left	0.02	0.05	0.07
WCDMA Band 2+ Bluetooth	Body-Back	0.11	0.01	0.12
	Body-Top	1.12	/	/
	Body-Left	0.07	0.05	0.12
WCDMA Band 5+ Bluetooth	Body-Back	0.06	0.01	0.07
	Body-Top	0.61	/	/
	Body-Left	0.09	0.05	0.14
LTE Band 2+ Bluetooth	Body-Back	0.12	0.01	0.13
	Body-Top	1.00	/	/
	Body-Left	0.07	0.05	0.12
LTE Band 4+ Bluetooth	Body-Back	0.08	0.01	0.09
	Body-Top	1.21	/	/
	Body-Left	0.07	0.05	0.12
LTE Band 5+ Bluetooth	Body-Back	0.07	0.01	0.08
	Body-Top	0.65	/	/
	Body-Left	0.10	0.05	0.15
LTE Band 13+ Bluetooth	Body-Back	0.06	0.01	0.07
	Body-Top	0.52	/	/
	Body-Left	0.04	0.05	0.09
LTE Band 17+ Bluetooth	Body-Back	0.04	0.01	0.05
	Body-Top	0.35	/	/
	Body-Left	0.02	0.05	0.07

WWAN + WLAN Main:

Mode (SAR1+SAR2)	Position	Reported SAR (W/kg)		Σ SAR < 1.6W/kg
		SAR1	SAR2	
CDMA 850 + WLAN Main	Body-Back	0.02	0.17	0.19
	Body-Top	0.25	0.36	0.61
	Body-Right	0.01	0.96	0.97
CDMA 1900 + WLAN Main	Body-Back	0.08	0.17	0.25
	Body-Top	1.18	0.36	1.54
	Body-Right	0.01	0.96	0.97
WCDMA Band 2+ WLAN Main	Body-Back	0.11	0.17	0.28
	Body-Top	1.12	0.36	1.48
	Body-Right	0.01	0.96	0.97
WCDMA Band 5+ WLAN Main	Body-Back	0.06	0.17	0.23
	Body-Top	0.61	0.36	0.97
	Body-Right	0.01	0.96	0.97
LTE Band 2+ WLAN Main	Body-Back	0.12	0.17	0.29
	Body-Top	1.00	0.36	1.36
	Body-Right	0.01	0.96	0.97
LTE Band 4+ WLAN Main	Body-Back	0.08	0.17	0.25
	Body-Top	1.21	0.36	1.57
	Body-Right	0.01	0.96	0.97
LTE Band 5+ WLAN Main	Body-Back	0.07	0.17	0.24
	Body-Top	0.65	0.36	1.01
	Body-Right	0.01	0.96	0.97
LTE Band 13+ WLAN Main	Body-Back	0.06	0.17	0.23
	Body-Top	0.52	0.36	0.88
	Body-Right	0.01	0.96	0.97
LTE Band 17+ WLAN Main	Body-Back	0.04	0.17	0.21
	Body-Top	0.35	0.36	0.71
	Body-Right	0.01	0.96	0.97

WWAN + WLAN AUX:

Mode (SAR1+SAR2)	Position	Reported SAR (W/kg)		Σ SAR < 1.6W/kg
		SAR1	SAR2	
CDMA 850 + WLAN Aux	Body-Back	0.02	0.16	0.18
	Body-Top	0.25	0.01	0.26
	Body-Left	0.02	0.50	0.52
CDMA 1900 + WLAN Aux	Body-Back	0.08	0.16	0.24
	Body-Top	1.18	0.01	1.19
	Body-Left	0.02	0.50	0.52
WCDMA Band 2+ WLAN Aux	Body-Back	0.11	0.16	0.27
	Body-Top	1.12	0.01	1.13
	Body-Left	0.07	0.50	0.57
WCDMA Band 5+ WLAN Aux	Body-Back	0.06	0.16	0.22
	Body-Top	0.61	0.01	0.62
	Body-Left	0.09	0.50	0.59
LTE Band 2+ WLAN Aux	Body-Back	0.12	0.16	0.28
	Body-Top	1.00	0.01	1.01
	Body-Left	0.07	0.50	0.57
LTE Band 4+ WLAN Aux	Body-Back	0.08	0.16	0.24
	Body-Top	1.21	0.01	1.22
	Body-Left	0.07	0.50	0.57
LTE Band 5+ WLAN Aux	Body-Back	0.07	0.16	0.23
	Body-Top	0.65	0.01	0.66
	Body-Left	0.10	0.50	0.6
LTE Band 13+ WLAN Aux	Body-Back	0.06	0.16	0.22
	Body-Top	0.52	0.01	0.53
	Body-Left	0.04	0.50	0.54
LTE Band 17+ WLAN Aux	Body-Back	0.04	0.16	0.2
	Body-Top	0.35	0.01	0.36
	Body-Left	0.02	0.50	0.52

WWAN + Bluetooth +WLAN Main:

Mode (SAR1+SAR2+SAR3)	Position	Reported SAR (W/kg)			Σ SAR < 1.6W/kg
		SAR1	SAR2	SAR3	
CDMA 850 + Bluetooth +WLAN Main	Body-Back	0.02	0.01	0.17	0.20
	Body-Top	0.25	/	0.36	/
CDMA 1900 + Bluetooth +WLAN Main	Body-Back	0.08	0.01	0.17	0.26
	Body-Top	1.18	/	0.36	/
WCDMA Band 2+ Bluetooth +WLAN Main	Body-Back	0.11	0.01	0.17	0.29
	Body-Top	1.12	/	0.36	/
WCDMA Band 5+ Bluetooth +WLAN Main	Body-Back	0.06	0.01	0.17	0.24
	Body-Top	0.61	/	0.36	/
LTE Band 2+ Bluetooth +WLAN Main	Body-Back	0.12	0.01	0.17	0.30
	Body-Top	1.00	/	0.36	/
LTE Band 4+ Bluetooth +WLAN Main	Body-Back	0.08	0.01	0.17	0.26
	Body-Top	1.21	/	0.36	/
LTE Band 5+ Bluetooth +WLAN Main	Body-Back	0.07	0.01	0.17	0.25
	Body-Top	0.65	/	0.36	/
LTE Band 13+ Bluetooth +WLAN Main	Body-Back	0.06	0.01	0.17	0.24
	Body-Top	0.52	/	0.36	/
LTE Band 17+ Bluetooth +WLAN Main	Body-Back	0.04	0.01	0.17	0.22
	Body-Top	0.35	/	0.36	/

WWAN + WLAN Main +WLAN AUX:

Mode (SAR1+SAR2+SAR3)	Position	Reported SAR (W/kg)			Σ SAR < 1.6W/kg
		SAR1	SAR2	SAR3	
CDMA 850+ WLAN Main +WLAN AUX	Body-Back	0.02	0.17	0.16	0.35
	Body-Top	0.25	0.36	0.01	0.62
CDMA 1900+ WLAN Main +WLAN AUX	Body-Back	0.08	0.17	0.16	0.41
	Body-Top	1.18	0.36	0.01	1.55
WCDMA Band 2+ WLAN Main +WLAN AUX	Body-Back	0.11	0.17	0.16	0.44
	Body-Top	1.12	0.36	0.01	1.49
WCDMA Band 5+ WLAN Main +WLAN AUX	Body-Back	0.06	0.17	0.16	0.39
	Body-Top	0.61	0.36	0.01	0.98
LTE Band 2+ WLAN Main +WLAN AUX	Body-Back	0.12	0.17	0.16	0.45
	Body-Top	1.00	0.36	0.01	1.37
LTE Band 4+ WLAN Main +WLAN AUX	Body-Back	0.08	0.17	0.16	0.41
	Body-Top	1.21	0.36	0.01	1.58
LTE Band 5+ WLAN Main +WLAN AUX	Body-Back	0.07	0.17	0.16	0.4
	Body-Top	0.65	0.36	0.01	1.02
LTE Band 13+ WLAN Main +WLAN AUX	Body-Back	0.06	0.17	0.16	0.39
	Body-Top	0.52	0.36	0.01	0.89
LTE Band 17+ WLAN Main +WLAN AUX	Body-Back	0.04	0.17	0.16	0.37
	Body-Top	0.35	0.36	0.01	0.72

Conclusion:

Sum of SAR: $\Sigma \text{SAR} < 1.6 \text{ W/kg}$ therefore simultaneous transmission SAR with Volume Scans is **not required**.

SAR Plots

Please Refer to the Attachment.

APPENDIX A MEASUREMENT UNCERTAINTY

The uncertainty budget has been determined for the measurement system and is given in the following Table.

Measurement uncertainty evaluation for IEEE1528-2013 SAR test

Source of uncertainty	Tolerance/uncertainty ± %	Probability distribution	Divisor	ci (1 g)	ci (10 g)	Standard uncertainty ± %, (1 g)	Standard uncertainty ± %, (10 g)
Measurement system							
Probe calibration	6.55	N	1	1	1	6.6	6.6
Axial Isotropy	4.7	R	√3	1	1	2.7	2.7
Hemispherical Isotropy	9.6	R	√3	0	0	0.0	0.0
Boundary effect	1.0	R	√3	1	1	0.6	0.6
Linearity	4.7	R	√3	1	1	2.7	2.7
Detection limits	1.0	R	√3	1	1	0.6	0.6
Readout electronics	0.3	N	1	1	1	0.3	0.3
Response time	0.0	R	√3	1	1	0.0	0.0
Integration time	0.0	R	√3	1	1	0.0	0.0
RF ambient conditions – noise	1.0	R	√3	1	1	0.6	0.6
RF ambient conditions–reflections	1.0	R	√3	1	1	0.6	0.6
Probe positioner mech. Restrictions	0.8	R	√3	1	1	0.5	0.5
Probe positioning with respect to phantom shell	6.7	R	√3	1	1	3.9	3.9
Post-processing	2.0	R	√3	1	1	1.2	1.2
Test sample related							
Test sample positioning	2.8	N	1	1	1	2.8	2.8
Device holder uncertainty	6.3	N	1	1	1	6.3	6.3
Drift of output power	5.0	R	√3	1	1	2.9	2.9
Phantom and set-up							
Phantom uncertainty (shape and thickness tolerances)	4.0	R	√3	1	1	2.3	2.3
Liquid conductivity target)	5.0	R	√3	0.64	0.43	1.8	1.2
Liquid conductivity meas.)	2.5	N	1	0.64	0.43	1.6	1.1
Liquid permittivity target)	5.0	R	√3	0.6	0.49	1.7	1.4
Liquid permittivity meas.)	2.5	N	1	0.6	0.49	1.5	1.2
Combined standard uncertainty		RSS				12.2	12.0
Expanded uncertainty 95 % confidence interval)						24.3	23.9

Measurement uncertainty evaluation for IEC62209-2 SAR test

Source of uncertainty	Tolerance/uncertainty ± %	Probability distribution	Divisor	ci (1 g)	ci (10 g)	Standard uncertainty ± %, (1 g)	Standard uncertainty ± %, (10 g)
Measurement system							
Probe calibration	6.55	N	1	1	1	6.6	6.6
Axial Isotropy	4.7	R	√3	1	1	2.7	2.7
Hemispherical Isotropy	9.6	R	√3	0	0	0.0	0.0
Linearity	4.7	R	√3	1	1	2.7	2.7
Modulation Response	0.0	R	√3	1	1	0.0	0.0
Detection limits	1.0	R	√3	1	1	0.6	0.6
Boundary effect	1.0	R	√3	1	1	0.6	0.6
Readout electronics	0.3	N	1	1	1	0.3	0.3
Response time	0.0	R	√3	1	1	0.0	0.0
Integration time	0.0	R	√3	1	1	0.0	0.0
RF ambient conditions – noise	1.0	R	√3	1	1	0.6	0.6
RF ambient conditions–reflections	1.0	R	√3	1	1	0.6	0.6
Probe positioner mech. Restrictions	0.8	R	√3	1	1	0.5	0.5
Probe positioning with respect to phantom shell	6.7	R	√3	1	1	3.9	3.9
Post-processing	2.0	R	√3	1	1	1.2	1.2
Test sample related							
Device holder Uncertainty	6.3	N	1	1	1	6.3	6.3
Test sample positioning	2.8	N	1	1	1	2.8	2.8
Power scaling	4.5	R	√3	1	1	2.6	2.6
Drift of output power	5.0	R	√3	1	1	2.9	2.9
Phantom and set-up							
Phantom uncertainty (shape and thickness tolerances)	4.0	R	√3	1	1	2.3	2.3
Algorithm for correcting SAR for deviations in permittivity and conductivity	1.9	N	1	1	0.84	1.1	0.9
Liquid conductivity (meas.)	2.5	N	1	0.64	0.43	1.6	1.1
Liquid permittivity (meas.)	2.5	N	1	0.6	0.49	1.5	1.2
Temp. unc. - Conductivity	1.7	R	√3	0.78	0.71	0.8	0.7
Temp. unc. - Permittivity	0.3	R	√3	0.23	0.26	0.0	0.0
Combined standard uncertainty		RSS				12.2	12.1
Expanded uncertainty 95 % confidence interval)						24.5	24.2

APPENDIX B EUT TEST POSITION PHOTOS

Please Refer to the Attachment.

APPENDIX C –CALIBRATION CERTIFICATES

Please Refer to the Attachment.

******* END OF REPORT *******