

SAR EVALUATION REPORT

For

DT Research Inc.

6F., NO.1, Ning-Po E. Street, Taipei 100, Taiwan

FCC ID: YE3800J

Report Type: Original Report	Product Type: Tablet PC
Report Number:	RTWD161214002-00E
Report Date:	2017-01-20
Reviewed By:	Manager <i>Jesse Huang</i>
Prepared By:	Bay Area Compliance Laboratories Corp. (Kunshan) No.248 Chenghu Road, Kunshan, Jiangsu province, China. Tel: +86-0512-86175000 Fax: +86-0512-88934268 www.baclcorp.com.cn

Attestation of Test Results			
EUT Information	Company Name	DT Research Inc.	
	EUT Description	Tablet PC	
	Model Number	DT395CR, Atlas 91i	
	FCC ID	YE3800J	
	Serial Number	16112300602	
	Test Date	2017-01-16 and 2017-01-18	
MODE		Max. SAR Level(s) Reported(W/Kg)	Limit (W/Kg)
WLAN 2.4G	1g Body SAR	0.22	1.6
WLAN 5G	1g Body SAR	0.56	
Simultaneous	1g Body SAR	0.59	
Applicable Standards	ANSI / IEEE C95.1 : 2005 IEEE Standard for Safety Levels with Respect to Human Exposure to Radio Frequency Electromagnetic Fields,3 kHz to 300 GHz.		
	ANSI / IEEE C95.3 : 2002 IEEE Recommended Practice for Measurements and Computations of Radio Frequency Electromagnetic Fields With Respect to Human Exposure to Such Fields,100 kHz—300 GHz.		
	IEEE1528:2013 Draft Recommended Practice for Determining the Peak Spatial-Average Specific Absorption Rate (SAR) in the Human Head from Wireless Communications Devices: Measurement Techniques.		
	IEC62209-2:2010 Human exposure to radio frequency fields from hand-held and body-mounted wireless communication devices – Human models, instrumentation, and procedures – Part 2: Procedure to determine the specific absorption rate (SAR) for wireless communication devices used in close proximity to the human body (frequency range of 30 MHz to 6 GHz)		
	KDB procedures KDB 447498 D01 General RF Exposure Guidance v05r02. KDB 616217 D04 SAR for laptop and tablets v01r01 KDB 865664 D01 SAR measurement 100 MHz to 6 GHz v01r03 KDB 865664 D02 RF Exposure Reporting v01r01 KDB 248227 D01-SAR Measurement Procedures for 802.11a/b/g Transmitters		
Note: This device is in compliance with Specific Absorption Rate (SAR) for general population/uncontrolled exposure limits (1.6 W/kg) specified in FCC 47 CFR part 2 (2.1093) and ANSI/IEEE C95.1-1992, and had been tested in accordance with the measurement methods and procedures specified in IEEE 1528-2013 and FCC KDB publications			

TABLE OF CONTENTS

DOCUMENT REVISION HISTORY	4
EUT DESCRIPTION	5
TECHNICAL SPECIFICATION	5
REFERENCE, STANDARDS, AND GUIDELINES	6
SAR LIMITS	7
FACILITIES	8
DESCRIPTION OF TEST SYSTEM	9
EQUIPMENT LIST AND CALIBRATION	14
EQUIPMENTS LIST & CALIBRATION INFORMATION	14
SAR MEASUREMENT SYSTEM VERIFICATION	15
LIQUID VERIFICATION	15
SYSTEM ACCURACY VERIFICATION	17
EUT TEST STRATEGY AND METHODOLOGY	18
TEST POSITIONS FOR DEVICE OPERATING NEXT TO A PERSON’S EAR	18
CHEEK/TOUCH POSITION	19
EAR/TILT POSITION	19
TEST POSITIONS FOR BODY-WORN AND OTHER CONFIGURATIONS	20
SAR EVALUATION PROCEDURE	21
SAR TESTING FOR TABLET	21
TEST METHODOLOGY	21
CONDUCTED OUTPUT POWER MEASUREMENT	22
PROVISION APPLICABLE	22
TEST PROCEDURE	22
WLAN CONDUCTED POWER	22
MAXIMUM OUTPUT POWER AMONG PRODUCTION UNITS	23
TEST RESULTS:	25
ANTENNA LOCATION	28
SAMPLE EDGE LOCATION	29
ANTENNA DISTANCE TO EDGE	29
STANDALONE SAR TEST EXCLUSION CONSIDERATIONS	29
SAR MEASUREMENT RESULTS	33
TEST RESULTS :	33
SAR SIMULTANEOUS TRANSMISSION DESCRIPTION	36
APPENDIX A MEASUREMENT UNCERTAINTY	37
APPENDIX B EUT TEST POSITION PHOTOS	
APPENDIX C SAR Plots of System Verification& SAR Plots of SAR Measurement	
APPENDIX D PROBE& DIPOLE CALIBRATION CERTIFICATES	

DOCUMENT REVISION HISTORY

Revision Number	Report Number	Description of Revision	Date of Revision
0	RTWD161214002-00E	Original Report	2017-01-20

F I N A L

EUT DESCRIPTION

This report has been prepared on behalf of **DT Research Inc.** and their product, Model: **DT395CR**, **Atlas 91i** or the EUT (Equipment under Test) as referred to in the rest of this report.

Technical Specification

Product Type	Portable
Exposure Category:	Population / Uncontrolled
Antenna Type(s):	Internal Antenna
Body-Worn Accessories:	Headset
Face-Head Accessories:	None
Multi-slot Class:	None
Operation Mode :	WiFi 2.4G/5G and Bluetooth
Frequency Band:	WLAN 2.4GHz Band: 2412 MHz ~ 2462 MHz WLAN 5.2GHz Band: 5180 MHz ~ 5240 MHz WLAN 5.3GHz Band: 5260 MHz ~ 5320 MHz WLAN 5.6GHz Band: 5500 MHz ~ 5720 MHz WLAN 5.8GHz Band: 5745 MHz ~ 5825 MHz Bluetooth: 2402 MHz ~ 2480 MHz
Conducted RF Power:	WLAN 2.4GHz: 18.7 dBm WLAN 5GHz: 13.7 dBm, 14.29 dBm, 14.73 dBm, 15.82 dBm Bluetooth EDR: 4.4 dBm Bluetooth LE: 4.5 dBm
Dimensions (L*W*H):	258 mm (L) × 198 mm (W) × 32.9 mm (H)
Power Source:	7.2V _{DC} Rechargeable Battery
Normal Operation:	Body worn

Note:

1, The overall diagonal dimension of the EUT >200mm, so test procedures in KDB616217 should be applicable.

Model Difference: The major electrical and mechanical constructions of series models are identical to the basic model, except different model name and colors. The model, DT395CR is the testing sample, and the final test data are shown on this test report.

REFERENCE, STANDARDS, AND GUIDELINES

FCC:

The Report and Order requires routine SAR evaluation prior to equipment authorization of portable transmitter devices, including portable telephones. For consumer products, the applicable limit is 1.6 mW/g as recommended by the ANSI/IEEE standard C95.1-1992 [6] for an uncontrolled environment (Paragraph 65). According to the Supplement C of OET Bulletin 65 "Evaluating Compliance with FCC Guide-lines for Human Exposure to Radio frequency Electromagnetic Fields", released on Jun 29, 2001 by the FCC, the device should be evaluated at maximum output power (radiated from the antenna) under "worst-case" conditions for normal or intended use, incorporating normal antenna operating positions, device peak performance frequencies and positions for maximum RF energy coupling.

This report describes the methodology and results of experiments performed on wireless data terminal. The objective was to determine if there is RF radiation and if radiation is found, what is the extent of radiation with respect to safety limits. SAR (Specific Absorption Rate) is the measure of RF exposure determined by the amount of RF energy absorbed by human body (or its parts) – to determine how the RF energy couples to the body or head which is a primary health concern for body worn devices. The limit below which the exposure to RF is considered safe by regulatory bodies in North America is 1.6 mW/g average over 1 gram of tissue mass.

CE:

The order requires routine SAR evaluation prior to equipment authorization of portable transmitter devices, including portable telephones. For consumer products, the applicable limit is 2 mW/g as recommended by EN62209-1 for an uncontrolled environment. According to the Standard, the device should be evaluated at maximum output power (radiated from the antenna) under "worst-case" conditions for normal or intended use, incorporating normal antenna operating positions, device peak performance frequencies and positions for maximum RF energy coupling.

This report describes the methodology and results of experiments performed on wireless data terminal. The objective was to determine if there is RF radiation and if radiation is found, what is the extent of radiation with respect to safety limits. SAR (Specific Absorption Rate) is the measure of RF exposure determined by the amount of RF energy absorbed by human body (or its parts) – to determine how the RF energy couples to the body or head which is a primary health concern for body worn devices. The limit below which the exposure to RF is considered safe by regulatory bodies in Europe is 2 mW/g average over 10 gram of tissue mass.

The test configurations were laid out on a specially designed test fixture to ensure the reproducibility of measurements. Each configuration was scanned for SAR. Analysis of each scan was carried out to characterize the above effects in the device.

SAR Limits

FCC Limit (1g Tissue)

EXPOSURE LIMITS	SAR (W/kg)	
	(General Population / Uncontrolled Exposure Environment)	(Occupational / Controlled Exposure Environment)
Spatial Average (averaged over the whole body)	0.08	0.4
Spatial Peak (averaged over any 1 g of tissue)	1.60	8.0
Spatial Peak (hands/wrists/feet/ankles averaged over 10 g)	4.0	20.0

CE Limit (10g Tissue)

EXPOSURE LIMITS	SAR (W/kg)	
	(General Population / Uncontrolled Exposure Environment)	(Occupational / Controlled Exposure Environment)
Spatial Average (averaged over the whole body)	0.08	0.4
Spatial Peak (averaged over any 10 g of tissue)	2.0	10
Spatial Peak (hands/wrists/feet/ankles averaged over 10 g)	4.0	20.0

Population/Uncontrolled Environments are defined as locations where there is the exposure of individual who have no knowledge or control of their exposure.

Occupational/Controlled Environments are defined as locations where there is exposure that may be incurred by people who are aware of the potential for exposure (i.e. as a result of employment or occupation).

General Population/Uncontrolled environments Spatial Peak limit 1.6W/kg (FCC) & 2 W/kg (CE) applied to the EUT.

FACILITIES

The test site used by Bay Area Compliance Laboratories Corp. (Kunshan) to collect test data is located on No.248 Chenghu Road, Kunshan, Jiangsu province, China.

FINAL

DESCRIPTION OF TEST SYSTEM

These measurements were performed with the automated near-field scanning system DASY4 from Schmid & Partner Engineering AG (SPEAG) which is the Fifth generation of the system shown in the figure hereinafter:



DASY4 System Description

The DASY4 system for performing compliance tests consists of the following items:

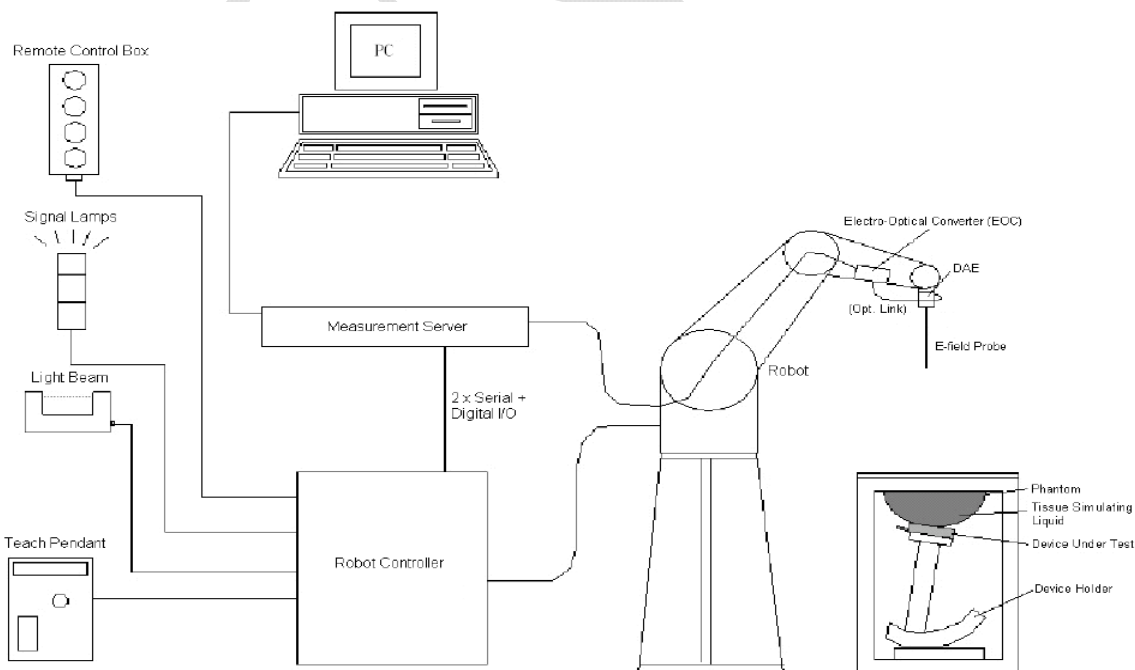

- A standard high precision 6-axis robot (Staubli TX=RX family) with controller, teach pendant and software. An arm extension for accommodating the data acquisition electronics (DAE).
- An isotropic field probe optimized and calibrated for the targeted measurement.

- A data acquisition electronics (DAE) which performs the signal amplification, signal multiplexing, AD-conversion, offset measurements, mechanical surface detection, collision detection, etc. The unit is battery powered with standard or rechargeable batteries. The signal is optically transmitted to the EOC.
- The Electro-optical converter (EOC) performs the conversion from optical to electrical signals for the digital communication to the DAE. To use optical surface detection, a special version of the EOC is required. The EOC signal is transmitted to the measurement server.
- The function of the measurement server is to perform the time critical tasks such as signal filtering, control of the robot operation and fast movement interrupts.
- The Light Beam used is for probe alignment. This improves the (absolute) accuracy of the probe positioning.
- A computer running Win7 professional operating system and the DASY42 software.
- Remote control and teach pendant as well as additional circuitry for robot safety such as warning lamps, etc.
- The phantom, the device holder and other accessories according to the targeted measurement.

DASY4 Measurement Server

The DASY4 measurement server is based on a PC/104 CPU board with a 400MHz intel ULV Celeron, 128MB chip-disk and 128MB RAM. The necessary circuits for communication with the DAE4 (or DAE3) electronics box, as well as the 16 bit AD converter system for optical detection and digital I/O interface are contained on the DASY4 I/O board, which is directly connected to the PC/104 bus of the CPU board.



The measurement server performs all real-time data evaluation of field measurements and surface detection, controls robot movements and handles safety operation. The PC operating system cannot interfere with these time critical processes. All connections are supervised by a watchdog, and disconnection of any of the cables to the measurement server will automatically disarm the robot and disable all program-controlled robot movements. Furthermore, the measurement server is equipped with an expansion port which is reserved for future applications. Please note that this expansion port does not have a standardized point out, and therefore only devices provided by SPEAG can be connected. Devices from any other supplier could seriously damage the measurement server.

Data Acquisition Electronics

The data acquisition electronics (DAE4) consist of a highly sensitive electrometer-grade preamplifier with auto-zeroing, a channel and gain-switching multiplexer, a fast 16 bit AD-converter and a command decoder with a control logic unit. Transmission to the measurement server is accomplished through an optical downlink for data and status information, as well as an optical uplink for commands and the clock.

The mechanical probe mounting device includes two different sensor systems for frontal and sideways probe contacts. They are used for mechanical surface detection and probe collision detection.

The input impedance of both the DAE4 as well as of the DAE3 box is 200M Ω ; the inputs are symmetrical and floating. Common mode rejection is above 80 dB.

EX3DV4 E-Field Probes

Frequency	10 MHz to > 6 GHz Linearity: ± 0.2 dB (30 MHz to 6 GHz)
Directivity	± 0.3 dB in TSL (rotation around probe axis) ± 0.5 dB in TSL (rotation normal to probe axis)
Dynamic Range	10 μ W/g to > 100 mW/g Linearity: ± 0.2 dB (noise: typically < 1 μ W/g)
Dimensions	Overall length: 337 mm (Tip: 20 mm) Tip diameter: 2.5 mm (Body: 12 mm) Typical distance from probe tip to dipole centers: 1 mm
Application	High precision dosimetric measurements in any exposure scenario (e.g., very strong gradient fields); the only probe that enables compliance testing for frequencies up to 6 GHz with precision of better 30%.
Compatibility	DASY3, DASY4, DASY42 SAR and higher, EASY4/MRI

SAM Twin Phantom

The SAM twin phantom is a fiberglass shell phantom with 2mm shell thickness (except the ear region, where shell thickness increases to 6 mm). The phantom has three measurement areas:

- _ Left hand
- _ Right hand
- _ Flat phantom

The phantom table for the DASY systems based on the TX90XL and RX160L robots have the size of 100 x 50 x 85 cm (L x W x H).

The phantom table for the compact DASY systems based on the RX60L robot have the size of 100 x 75 x 91 cm (L x W x H); these tables are reinforced for mounting of the robot onto the table.

For easy dislocation these tables have fork lift cut outs at the bottom.

The bottom plate contains three pairs of bolts for locking the device holder. The device holder positions are adjusted to the standard measurement positions in the three sections. Only one device holder is necessary if two phantoms are used (e.g., for different liquids)

A white cover is provided to cover the phantom during o_-periods to prevent water evaporation and changes in the liquid parameters. Free space scans of devices on top of this phantom cover are possible.

Three reference marks are provided on the phantom counter. These reference marks are used to teach the absolute phantom position relative to the robot.



Robots

The DASY4 system uses the high precision industrial robots RX60XL from Staubli SA (France). The TX robot family is the successor of the well known RX robot family and offers the same features important for our application:

- High precision (repeatability 0.02mm)
- High reliability (industrial design)
- Low maintenance costs (virtually maintenance free due to direct drive gears; no belt drives)
- Jerk-free straight movements (brushless synchron motors; no stepper motors)
- Low ELF interference (motor control fields shielded via the closed metallic construction shields)

The above mentioned robots are controlled by the Staubli CS8c robot controllers. All information regarding the use and maintenance of the robot arm and the robot controller is contained on the CDs delivered along with the robot. Paper manuals are available upon request direct from Staubli.

Area Scans

Area scans are defined prior to the measurement process being executed with a user defined variable spacing between each measurement point (integral) allowing low uncertainty measurements to be conducted. Scans defined for FCC applications utilize a 10mm² step integral, with 1mm interpolation used to locate the peak SAR area used for zoom scan assessments.

Where the system identifies multiple SAR peaks (which are within 25% of peak value) the system will provide the user with the option of assessing each peak location individually for zoom scan averaging.

Zoom Scan (Cube Scan Averaging)

The averaging zoom scan volume utilized in the DASY4 software is in the shape of a cube and the side dimension of a 1 g or 10 g mass is dependent on the density of the liquid representing the simulated tissue. A density of 1000 kg/m³ is used to represent the head and body tissue density and not the phantom liquid density, in order to be consistent with the definition of the liquid dielectric properties, i.e. the side length of the 1 g cube is 10mm, with the side length of the 10 g cube 21,5mm.

When the cube intersects with the surface of the phantom, it is oriented so that 3 vertices touch the surface of the shell or the center of a face is tangent to the surface. The face of the cube closest to the surface is modified in order to conform to the tangent surface.

The zoom scan integer steps can be user defined so as to reduce uncertainty, but normal practice for typical test applications (including FCC) utilize a physical step of 5x5x8 (8mmx8mmx5mm) providing a volume of 32mm³ in the X & Y axis, and 35mm in the Z axis.

Tissue Dielectric Parameters for Head and Body Phantoms

The head tissue dielectric parameters recommended by the IEEE SCC-34/SC-2 in P1528 have been incorporated in the following table. These head parameters are derived from planar layer models simulating the highest expected SAR for the dielectric properties and tissue thickness variations in a human head. Other head and body tissue parameters that have not been specified in P1528 are derived from the tissue dielectric parameters computed from the 4-Cole-Cole equations described in Reference [12] and extrapolated according to the head parameters specified in P1528.

Frequency (MHz)	Water (%)	Sugar (%)	Cellulose (%)	Salt (%)	Preventol (%)	DGBE (%)	Conductivity (σ)	Permittivity (ϵ_r)
For Head								
750	41.1	57.0	0.2	1.4	0.2	0	0.89	41.9
835	40.3	57.9	0.2	1.4	0.2	0	0.90	41.5
900	40.3	57.9	0.2	1.4	0.2	0	0.97	41.5
1800, 1900, 2000	55.2	0	0	0.3	0	44.5	1.40	40.0
2450	55.0	0	0	0	0	45.0	1.80	39.2
2600	54.8	0	0	0.1	0	45.1	1.96	39.0
For Body								
750	51.7	47.2	0	0.9	0.1	0	0.96	55.5
835	50.8	48.2	0	0.9	0.1	0	0.97	55.2
900	50.8	48.2	0	0.9	0.1	0	1.05	55.0
1800, 1900, 2000	70.2	0	0	0.4	0	29.4	1.52	53.3
2450	68.6	0	0	0	0	31.4	1.95	52.7
2600	68.1	0	0	0.1	0	31.8	2.16	52.5

Recommended Tissue Dielectric Parameters for Head and Body

Frequency (MHz)	Head Tissue		Body Tissue	
	ϵ_r	σ (S/m)	ϵ_r	σ (S/m)
150	52.3	0.76	61.9	0.80
300	45.3	0.87	58.2	0.92
450	43.5	0.87	56.7	0.94
835	41.5	0.90	55.2	0.97
900	41.5	0.97	55.0	1.05
915	41.5	0.98	55.0	1.06
1450	40.5	1.20	54.0	1.30
1610	40.3	1.29	53.8	1.40
1800-2000	40.0	1.40	53.3	1.52
2450	39.2	1.80	52.7	1.95
3000	38.5	2.40	52.0	2.73
5800	35.3	5.27	48.2	6.00

EQUIPMENT LIST AND CALIBRATION

Equipments List & Calibration Information

Equipment	Model	S/N	Calibration Date	Calibration Due Date
Robot	RX90	5L79A1	N/A	N/A
DASY4 Test Software	DASY4.5	N/A	N/A	N/A
DASY4 Measurement Server	DASY 4.5.12	1180	N/A	N/A
Data Acquisition Electronics	DAE4	772	2016/10/25	2017/10/24
E-Field Probe	EX3DV4	7382	2016/10/26	2017/10/25
Dipole, 2450 MHz	D2450V2	970	2015/7/8	2018/7/7
Dipole, 5GHz	D5GHzV2	1225	2015/10/16	2018/7/15
Mounting Device	SD 000 H01 KA	N/A	N/A	N/A
Twin SAM	Twin SAM V5.0	1909	N/A	N/A
Simulated Tissue 2450 MHz Head	TS-2450-H	N/A	Each Time	/
Simulated Tissue 2450 MHz Body	TS-2450-B	N/A	Each Time	/
Simulated Tissue 5 GHz Head	TS-5G-H	N/A	Each Time	/
Simulated Tissue 5 GHz Body	TS-5G-B	N/A	Each Time	/
Network Analyzer	8753B	2625A00809	2016/10/06	2017/10/05
S-Parameter Test Set	85047A	3033A02428	2016/10/06	2017/10/05
Dielectric probe kit	85070B	US33020324	N/A	N/A
Signal Generator	SMBV100A	261558	2016/07/04	2017/07/03
Power Meter	E4419B	MY41291878	2017/01/07	2018/01/06
Power Meter Sensor	E9301A	US39210953	2016/05/30	2017/05/29
Power Amplifier	10S1G4M1	18060	N/A	N/A
Directional Coupler	488Z	N/A	N/A	N/A
Attenuator	20dB, 100W	N/A	N/A	N/A
Attenuator	3dB, 150W	N/A	N/A	N/A

SAR MEASUREMENT SYSTEM VERIFICATION

Liquid Verification

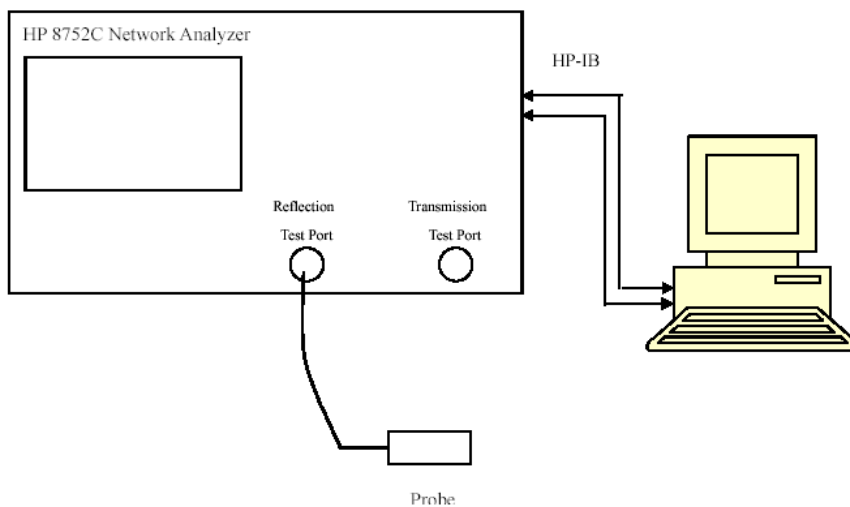

Liquid Verification Setup Block Diagram

Liquid Verification Results

Frequency (MHz)	Liquid Type	Conductivity (σ)	Permittivity (ϵ_r)	Conductivity Target (σ)	Permittivity Target (ϵ_r)	Delta (σ) (%)	Delta (ϵ_r) (%)	Limit (%)
2412	Body	1.915	51.70	1.91	52.75	0.26	-2.08	± 5
2437	Body	1.947	51.63	1.94	52.72	0.36	-2.03	± 5
2450	Body	1.960	51.60	1.95	52.70	0.51	-2.09	± 5
2462	Body	1.920	51.55	1.97	52.68	-2.54	-2.18	± 5

*Liquid Verification was performed on 2017-1-16.

Frequency (MHz)	Liquid Type	Conductivity (σ)	Permittivity (ϵ_r)	Conductivity Target (σ)	Permittivity Target (ϵ_r)	Delta (σ) (%)	Delta (ϵ_r) (%)	Limit (%)
5180	Body	5.264	46.81	5.28	49.03	-0.31	-4.47	± 5
5190	Body	5.275	46.80	5.29	49.01	-0.28	-4.49	± 5
5200	Body	5.288	46.78	5.30	49.00	-0.23	-4.53	± 5
5210	Body	5.301	46.76	5.31	48.99	-0.16	-4.56	± 5
5220	Body	5.314	46.75	5.32	48.98	-0.10	-4.58	± 5
5230	Body	5.328	46.74	5.33	48.97	-0.04	-4.61	± 5
5240	Body	5.339	46.74	5.35	48.96	-0.21	-4.62	± 5
5250	Body	5.340	46.70	5.36	48.95	-0.37	-4.60	± 5
5260	Body	5.355	46.69	5.37	48.94	-0.28	-4.51	± 5
5270	Body	5.369	46.67	5.38	48.93	-0.21	-4.56	± 5
5280	Body	5.383	46.65	5.39	48.92	-0.12	-4.59	± 5
5290	Body	5.397	46.64	5.40	48.91	-0.05	-4.61	± 5
5300	Body	5.409	46.63	5.42	48.90	-0.20	-4.65	± 5
5310	Body	5.422	46.61	5.43	48.79	-0.15	-4.48	± 5
5320	Body	5.436	46.60	5.44	48.67	-0.08	-4.31	± 5
5500	Body	5.649	46.32	5.65	48.60	-0.02	-4.69	± 5
5510	Body	5.662	46.31	5.66	48.59	0.04	-4.71	± 5
5520	Body	5.675	46.30	5.67	48.58	0.09	-4.74	± 5
5530	Body	5.690	46.29	5.68	48.57	0.18	-4.76	± 5
5540	Body	5.704	46.27	5.70	48.56	0.07	-4.79	± 5
5550	Body	5.717	46.26	5.71	48.55	0.13	-4.81	± 5
5560	Body	5.727	46.26	5.72	48.54	0.12	-4.62	± 5
5580	Body	5.743	46.21	5.74	48.52	0.06	-4.72	± 5
5600	Body	5.775	46.16	5.77	48.50	0.08	-4.82	± 5
5610	Body	5.790	46.15	5.78	48.49	0.18	-4.84	± 5
5620	Body	5.804	46.14	5.79	48.47	0.24	-4.86	± 5
5630	Body	5.818	46.13	5.80	48.46	0.31	-4.88	± 5
5640	Body	5.833	46.12	5.81	48.44	0.39	-4.70	± 5
5660	Body	5.857	46.11	5.84	48.41	0.30	-4.73	± 5
5670	Body	5.864	46.10	5.85	48.40	0.23	-4.75	± 5
5680	Body	5.871	46.07	5.86	48.38	0.18	-4.81	± 5
5690	Body	5.884	46.04	5.87	48.37	0.24	-4.87	± 5
5700	Body	5.899	46.02	5.88	48.35	0.32	-4.92	± 5
5710	Body	5.914	46.00	5.89	48.34	0.41	-4.76	± 5
5720	Body	5.930	45.99	5.91	48.32	0.34	-4.78	± 5
5745	Body	5.967	45.97	5.94	48.28	0.45	-4.82	± 5
5755	Body	5.980	45.97	5.95	48.27	0.51	-4.83	± 5
5765	Body	5.991	45.96	5.96	48.25	0.53	-4.84	± 5
5775	Body	5.997	45.96	5.97	48.24	0.45	-4.66	± 5
5785	Body	6.002	45.93	5.98	48.22	0.38	-4.72	± 5
5795	Body	6.015	45.89	5.99	48.21	0.41	-4.79	± 5
5800	Body	6.020	45.80	6	48.2	0.33	-4.95	± 5
5805	Body	6.031	45.86	6.00	48.20	0.52	-4.85	± 5
5825	Body	6.063	45.84	6.00	48.20	1.05	-4.90	± 5

*Liquid Verification was performed on 2017-1-18.

System Accuracy Verification

Prior to the assessment, the system validation kit was used to test whether the system was operating within its specifications of $\pm 10\%$. The validation results are tabulated below. And also the corresponding SAR plot is attached as well in the SAR plots files.

System Verification Setup Block Diagram

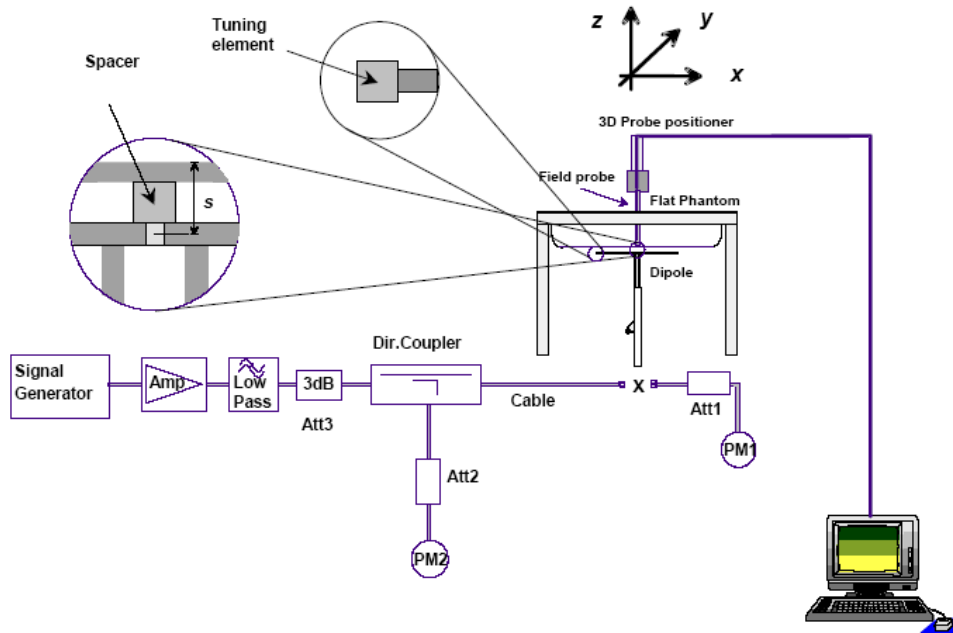

System Accuracy Check Results

Date	Frequency (MHz) ²	Tissue Type ²	Input Power (mW)	Dipole S/N	Probe S/N	DAE S/N	Measured 1g SAR (W/kg)	Targeted 1g SAR (W/kg)	Normalized 1g SAR (W/kg)	Deviation (%)	SAR (1g)
2017/1/16	2450	MSL	250	D2450V2-970	7382	772	12.40	51.30	49.6	-3.31	1g
2017/1/18	5250	MSL	100	D5GHzV2-1225	7382	772	8.11	76.10	81.1	6.57	1g
2017/1/18	5600	MSL	100	D5GHzV2-1225	7382	772	8.65	81.00	86.5	6.79	1g
2017/1/18	5800	MSL	100	D5GHzV2-1225	7382	772	8.22	77.10	82.2	6.61	1g

All SAR values are normalized to 1 Watt forward power.

EUT TEST STRATEGY AND METHODOLOGY

Test Positions for Device Operating Next to a Person’s Ear

This category includes most wireless handsets with fixed, retractable or internal antennas located toward the top half of the device, with or without a foldout, sliding or similar keypad cover. The handset should have its earpiece located within the upper ¼ of the device, either along the centerline or off-centered, as perceived by its users. This type of handset should be positioned in a normal operating position with the “test device reference point” located along the “vertical centerline” on the front of the device aligned to the “ear reference point”. The “test device reference point” should be located at the same level as the center of the earpiece region. The “vertical centerline” should bisect the front surface of the handset at its top and bottom edges. A “ear reference point” is located on the outer surface of the head phantom on each ear spacer. It is located 1.5 cm above the center of the ear canal entrance in the “phantom reference plane” defined by the three lines joining the center of each “ear reference point” (left and right) and the tip of the mouth.

A handset should be initially positioned with the earpiece region pressed against the ear spacer of a head phantom. For the SCC-34/SC-2 head phantom, the device should be positioned parallel to the “N-F” line defined along the base of the ear spacer that contains the “ear reference point”. For interim head phantoms, the device should be positioned parallel to the cheek for maximum RF energy coupling. The “test device reference point” is aligned to the “ear reference point” on the head phantom and the “vertical centerline” is aligned to the “phantom reference plane”. This is called the “initial ear position”. While maintaining these three alignments, the body of the handset is gradually adjusted to each of the following positions for evaluating SAR:

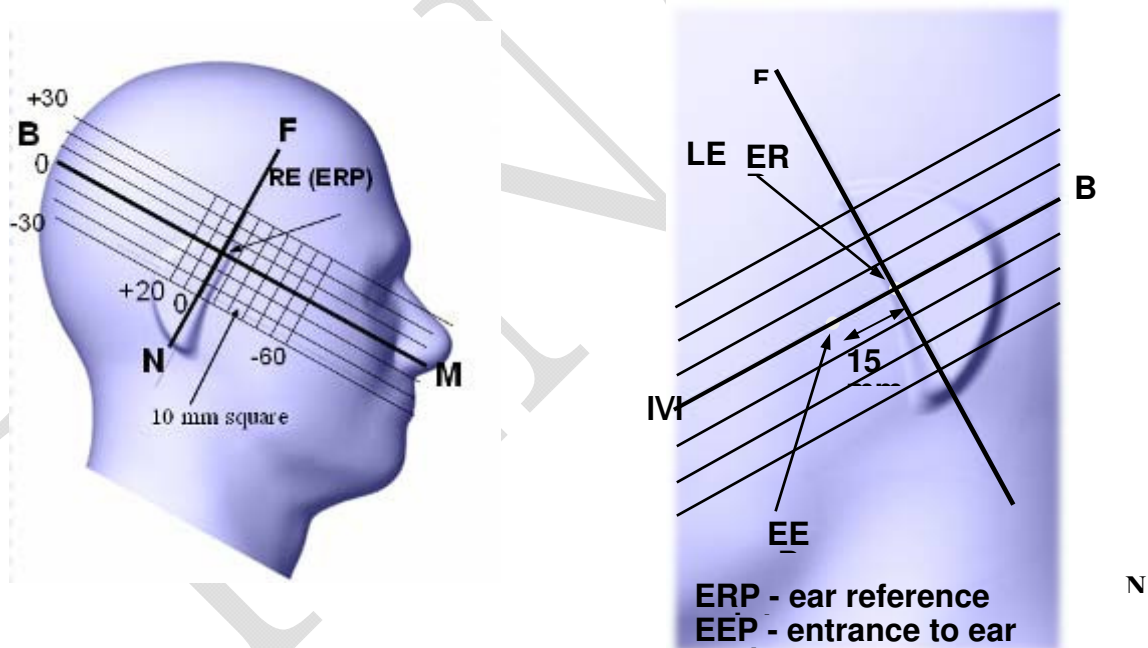

Cheek/Touch Position

The device is brought toward the mouth of the head phantom by pivoting against the “ear reference point” or along the “N-F” line for the SCC-34/SC-2 head phantom.

This test position is established:

When any point on the display, keypad or mouthpiece portions of the handset is in contact with the phantom.

(or) When any portion of a foldout, sliding or similar keypad cover opened to its intended self-adjusting normal use position is in contact with the cheek or mouth of the phantom.

For existing head phantoms – when the handset loses contact with the phantom at the pivoting point, rotation should continue until the device touches the cheek of the phantom or breaks its last contact from the ear spacer.

Cheek /Touch Position

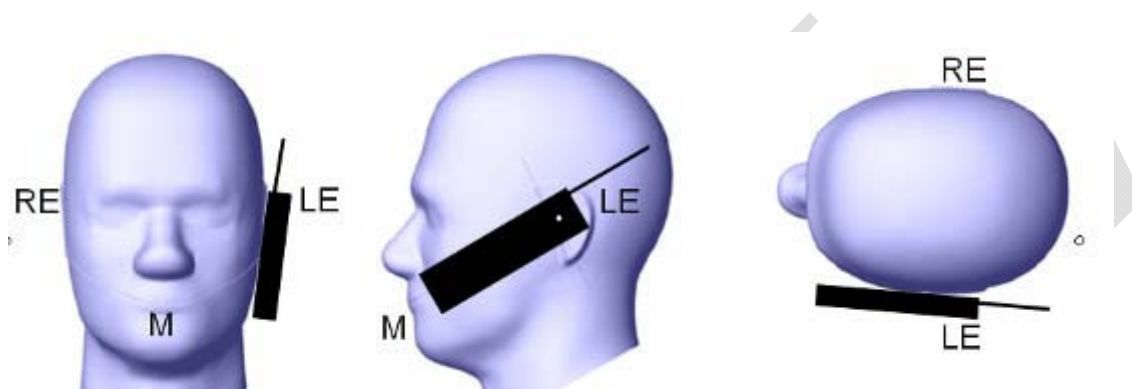

Ear/Tilt Position

With the handset aligned in the “Cheek/Touch Position”:

1) If the earpiece of the handset is not in full contact with the phantom’s ear spacer (in the “Cheek/Touch position”) and the peak SAR location for the “Cheek/Touch” position is located at the ear spacer region or corresponds to the earpiece region of the handset, the device should be returned to the “initial ear position” by rotating it away from the mouth until the earpiece is in full contact with the ear spacer.

2) (otherwise) The handset should be moved (translated) away from the cheek perpendicular to the line passes through both “ear reference points” (note: one of these ear reference points may not physically exist on a split head model) for approximate 2-3 cm. While it is in this position, the device handset is tilted away from the mouth with respect to the “test device reference point” until the inside angle between the vertical centerline on the front surface of the phone and the horizontal line passing through the ear reference point is by 15° . After the tilt, it is then moved (translated) back toward the head perpendicular to the line passes through both “ear reference points” until the device touches the phantom or the ear spacer. If the antenna touches the head first, the positioning process should be repeated with a tilt angle less than 15° so that the device and its antenna would touch the phantom simultaneously. This test position may require a device holder or positioner to achieve the translation and tilting with acceptable positioning repeatability.

If a device is also designed to transmit with its keypad cover closed for operating in the head position, such positions should also be considered in the SAR evaluation. The device should be tested on the left and right side of the head phantom in the “Cheek/Touch” and “Ear/Tilt” positions. When applicable, each configuration should be tested with the antenna in its fully extended and fully retracted positions. These test configurations should be tested at the high, middle and low frequency channels of each operating mode; for example, AMPS, CDMA, and TDMA. If the SAR measured at the middle channel for each test configuration (left, right, Cheek/Touch, Tile/Ear, extended and retracted) is at least 2.0 dB lower than the SAR limit, testing at the high and low channels is optional for such test configuration(s). If the transmission band of the test device is less than 10 MHz, testing at the high and low frequency channels is optional.

Ear /Tilt 15° Position

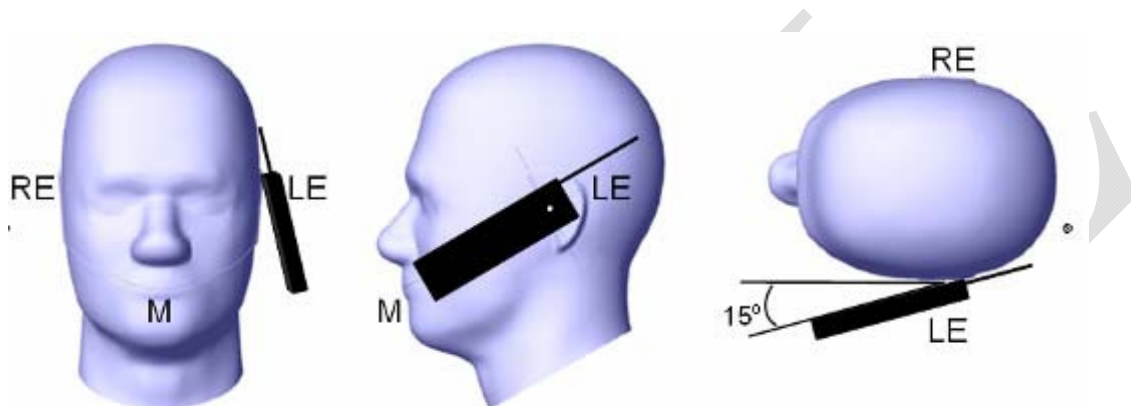

Test positions for body-worn and other configurations

Body-worn operating configurations should be tested with the belt-clips and holsters attached to the device and positioned against a flat phantom in normal use configurations. Devices with a headset output should be tested with a headset connected to the device. When multiple accessories that do not contain metallic components are supplied with the device, the device may be tested with only the accessory that dictates the closest spacing to the body. When multiple accessories that contain metallic components are supplied with the device, the device must be tested with each accessory that contains a unique metallic component. If multiple accessories share an identical metallic component (e.g., the same metallic belt-clip used with different holsters with no other metallic components), only the accessory that dictates the closest spacing to the body must be tested.

Body-worn accessories may not always be supplied or available as options for some devices that are intended to be authorized for body-worn use. A separation distance of 1.5 cm between the back of the device and a flat phantom is recommended for testing body-worn SAR compliance under such circumstances. Other separation distances may be used, but they should not exceed 2.5 cm. In these cases, the device may use body-worn accessories that provide a separation distance greater than that tested for the device provided however that the accessory contains no metallic components.

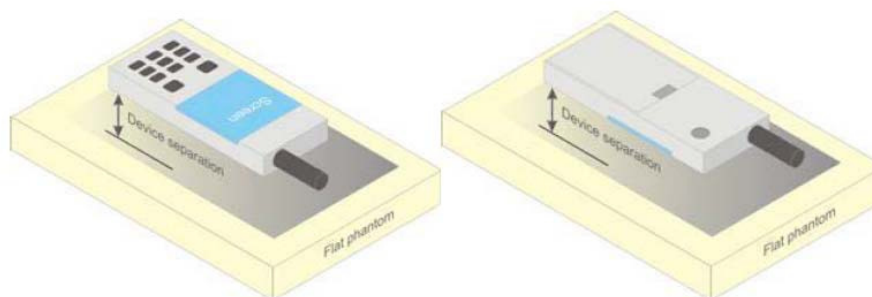

Figure 5 – Test positions for body-worn devices

SAR Evaluation Procedure

The evaluation was performed with the following procedure:

Step 1: Measurement of the SAR value at a fixed location above the ear point or central position was used as a reference value for assessing the power drop. The SAR at this point is measured at the start of the test and then again at the end of the testing.

Step 2: The SAR distribution at the exposed side of the head was measured at a distance of 4 mm from the inner surface of the shell. The area covered the entire dimension of the head or EUT and the horizontal grid spacing was 10 mm x 10 mm. Based on these data, the area of the maximum absorption was determined by spline interpolation. The first Area Scan covers the entire dimension of the EUT to ensure that the hotspot was correctly identified.

Step 3: Around this point, a volume of 35 mm x 35 mm x 35 mm was assessed by measuring 7x 7 x 7 points. On the basis of this data set, the spatial peak SAR value was evaluated under the following procedure:

- 1) The data at the surface were extrapolated, since the center of the dipoles is 1.2 mm away from the tip of the probe and the distance between the surface and the lowest measuring point is 1.3 mm. The extrapolation was based on a least square algorithm. A polynomial of the fourth order was calculated through the points in z-axes. This polynomial was then used to evaluate the points between the surface and the probe tip.
- 2) The maximum interpolated value was searched with a straightforward algorithm. Around this maximum the SAR values averaged over the spatial volumes (1 g or 10 g) were computed by the 3D-Spline interpolation algorithm. The 3D-Spline is composed of three one dimensional splines with the "Not a knot"-condition (in x, y and z-directions). The volume was integrated with the trapezoidal-algorithm. One thousand points (10 x 10 x 10) were interpolated to calculate the averages.

All neighboring volumes were evaluated until no neighboring volume with a higher average value was found.

Step 4: Re-measurement of the SAR value at the same location as in Step 1. If the value changed by more than 5%, the evaluation was repeated.

SAR Testing For Tablet

This device can be used also in full sized tablet exposure conditions, due to its size. Per FCC KDB 616217, the back surface and edges of the tablet should be tested for SAR compliance with the tablet touching the phantom. The SAR exclusion threshold in KDB 447498 D01v06 can be applied to determine SAR test exclusion for adjacent edge configurations. The closest distance from the antenna to an adjacent tablet edge is used to determine if SAR testing is required for the adjacent edges, with the adjacent edge positioned against the phantom and the edge containing the antenna positioned perpendicular to the phantom.

Test methodology

KDB 447498 D01 General RF Exposure Guidance v05r02.

KDB 865664 D01 SAR measurement 100 MHz to 6 GHz v01r03

KDB 865664 D02 RF Exposure Reporting v01r01

KDB 248227 D01-SAR Measurement Procedures for 802.11a/b/g Transmitters

CONDUCTED OUTPUT POWER MEASUREMENT

Provision Applicable

The measured peak output power should be greater and within 5% than EMI measurement.

Test Procedure

The RF output of the transmitter was connected to the input of the EMI Receiver through sufficient attenuation.

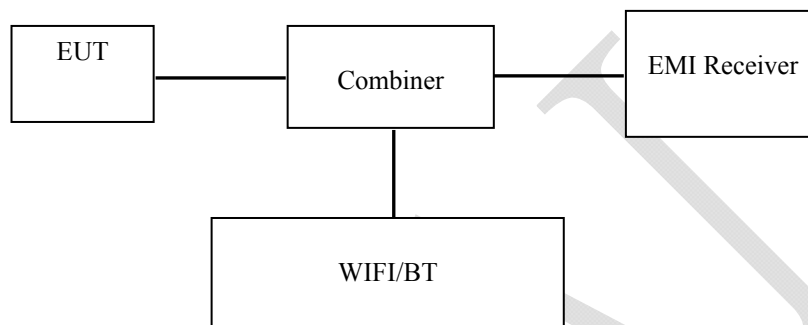

WLAN Conducted Power

General Note:

1. For WLAN SAR testing was performed on single antenna RF power in SISO mode is larger or equal to the single antenna RF power in MIMO mode, and for RF exposure assessment of MIMO mode simultaneous transmission exclusion analysis was performed with SAR test results of each antenna in SISO mode.
2. Per KDB 248227 D01v02r02, the simultaneous SAR provisions in KDB publication 447498 should be applied to determine simultaneous transmission SAR test exclusion for WiFi MIMO. If the sum of 1g single transmission chain SAR measurements is $< 1.6\text{W/kg}$ and SAR peak to location ratio < 0.04 , no additional SAR measurements for MIMO.
3. Per KDB 248227 D01v02r02, SAR test reduction is determined according to 802.11 transmission mode configurations and certain exposure conditions with multiple test positions. In the 2.4 GHz band, separate SAR procedures are applied to DSSS and OFDM configurations to simplify DSSS test requirements. For OFDM, in both 2.4 and 5 GHz bands, an initial test configuration must be determined for each standalone and aggregated frequency band, according to the transmission mode configuration with the highest maximum output power specified for production units to perform SAR measurements. If the same highest maximum output power applies to different combinations of channel bandwidths, modulations and data rates, additional procedures are applied to determine which test configurations require SAR measurement. When applicable, an initial test position may be applied to reduce the number of SAR measurements required for next to the ear, UMPC mini-tablet or hotspot mode configurations with multiple test positions.
4. For 2.4 GHz 802.11b DSSS, either the initial test position procedure for multiple exposure test positions or the DSSS procedure for fixed exposure position is applied; these are mutually exclusive. For 2.4 GHz and 5 GHz OFDM configurations, the initial test configuration is applied to measure SAR using either the initial test position procedure for multiple exposure test position configurations or the initial test configuration procedures for fixed

exposure test conditions. Based on the reported SAR of the measured configurations and maximum output power of the transmission mode configurations that are not included in the initial test configuration, the subsequent test configuration and initial test position procedures are applied to determine if SAR measurements are required for the remaining OFDM transmission configurations. In general, the number of test channels that require SAR measurement is minimized based on maximum output power measured for the test sample(s).

5. For OFDM transmission configurations in the 2.4 GHz and 5 GHz bands, When the same maximum power is specified for multiple transmission modes in a frequency band, the largest channel bandwidth, lowest order modulation, lowest data rate and lowest order 802.11a/g/n/ac mode is used for SAR measurement, on the highest measured output power channel for each frequency band.
6. DSSS and OFDM configurations are considered separately according to the required SAR procedures. SAR is measured in the initial test position using the 802.11 transmission mode configuration required by the DSSS procedure or initial test configuration and subsequent test configuration(s) according to the OFDM procedures.18 The initial test position procedure is described in the following:
 - a. When the reported SAR of the initial test position is ≤ 0.4 W/kg, further SAR measurement is not required for the other test positions in that exposure configuration and 802.11 transmission mode combinations within the frequency band or aggregated band.
 - b. When the reported SAR of the test position is > 0.4 W/kg, SAR is repeated for the 802.11 transmission mode configuration tested in the initial test position to measure the subsequent next closet/smallest test separation distance and maximum coupling test position on the highest maximum output power channel, until the report SAR is ≤ 0.8 W/kg or all required test position are tested.
 - c. For all positions/configurations, when the reported SAR is > 0.8 W/kg, SAR is measured for these test positions/configurations on the subsequent next highest measured output power channel(s) until the reported SAR is ≤ 1.2 W/kg or all required channels are

Maximum Output Power among production units

2.4GHz WLAN MAIN			WLAN AUX
Mode	Frequency (MHz)	Tune-Up Limit	Tune-Up Limit
802.11b	2412	15.50	15.50
	2437	15.50	15.00
	2462	15.50	15.00
802.11g	2412	15.50	16.00
	2437	18.00	17.00
	2462	14.50	14.00
802.11n-HT20	2412	15.50	16.00
	2437	18.00	17.50
	2462	14.00	14.00
802.11n-HT40	2422	16.00	16.00
	2437	19.00	18.00
	2452	15.00	13.50

5.2GHz WLAN MAIN			WLAN AUX
Mode	Frequency (MHz)	Tune-Up Limit	Tune-Up Limit
802.11a	5180	12.50	13.50
	5200	12.50	14.00
	5240	13.00	13.50
802.11n-HT20	5180	12.00	12.50
	5200	13.00	13.50
	5240	13.00	13.50
802.11n-HT40	5190	11.00	12.50
	5230	13.00	14.00
802.11ac-VHT80	5210	12.50	12.00

5.3GHz WLAN MAIN			WLAN AUX
Mode	Frequency (MHz)	Tune-Up Limit	Tune-Up Limit
802.11a	5260	14.00	14.00
	5280	13.50	13.50
	5320	12.50	10.50
802.11n-HT20	5260	14.00	14.00
	5280	13.50	13.50
	5320	13.50	13.00
802.11n-HT40	5270	14.50	14.50
	5310	12.50	12.50
802.11ac-VHT80	5290	12.50	11.50

5.5 WLAN MAIN			WLAN AUX
Mode	Frequency (MHz)	Tune-Up Limit	Tune-Up Limit
802.11a	5500	13.00	13.50
	5580	14.50	14.50
	5700	11.50	11.00
802.11n-HT20	5500	12.50	11.50
	5580	14.50	15.00
	5700	11.50	11.00
802.11n-HT40	5510	13.00	12.00

	5550	13.00	13.00
	5670	14.50	15.00
802.11ac-VHT20	5720	13.00	13.00
802.11ac-VHT40	5710	13.50	13.50
802.11ac-VHT80	5530	13	12.5
	5610	13	12.5
	5690	14.00	-

5.8 WLAN MAIN			WLAN AUX
Mode	Frequency (MHz)	Tune-Up Limit	Tune-Up Limit
802.11a	5745	14.50	14.50
	5785	14.50	14.00
	5825	14.50	15.00
802.11n-HT20	5745	14.50	14.50
	5785	14.50	14.50
	5825	14.50	14.50
802.11n-HT40	5755	16.00	16.00
	5795	15.00	15.00
802.11ac-VHT80	5775	15.50	15.00

Test Results:

2.4GHz WLAN MAIN			AUX
Mode	Frequency (MHz)	Average power (dBm)	Average power (dBm)
802.11b	2412	15.35	15.18
	2437	15.34	14.67
	2462	15.14	14.69
802.11g	2412	15.48	15.71
	2437	17.82	16.57
	2462	14.02	13.83
802.11n-HT20	2412	15.41	15.90
	2437	17.70	17.10
	2462	13.94	13.88
802.11n-HT40	2422	15.56	15.94
	2437	18.70	17.86
	2452	14.61	13.37

5.2GHz WLAN MAIN			AUX
Mode	Frequency (MHz)	Average power (dBm)	Average power (dBm)
802.11a	5180	12.19	12.97
	5200	12.13	13.70
	5240	12.89	13.09
802.11n-HT20	5180	11.79	12.18
	5200	12.71	13.08
	5240	12.70	12.94
802.11n-HT40	5190	10.86	12.42
	5230	12.93	13.64
802.11ac-VHT80	5210	12.37	11.7

5.3GHz WLAN MAIN			AUX
Mode	Frequency (MHz)	Average power (dBm)	Average power (dBm)
802.11a	5260	13.72	13.53
	5280	13.47	12.92
	5320	12.18	10.04
802.11n-HT20	5260	13.97	13.54
	5280	13.43	13.28
	5320	12.97	12.83
802.11n-HT40	5270	14.29	14.17
	5310	12.24	12.19
802.11ac-VHT80	5290	12.4	11.13

5.5 WLAN MAIN			AUX
Mode	Frequency (MHz)	Average power (dBm)	Average power (dBm)
802.11a	5500	12.67	13.14
	5580	14.21	14.21
	5700	11.18	10.96
802.11n-HT20	5500	11.98	11.06
	5580	13.91	14.41
	5700	11.24	10.82
802.11n-HT40	5510	12.6	11.55

	5550	12.59	12.88
	5670	14.48	14.73
802.11ac-VHT20	5720	12.79	12.51
802.11ac-VHT40	5710	13.46	13.44
802.11ac-VHT80	5530	12.62	12.26
	5610	12.52	12.41
	5690	13.85	-1.93

5.8 WLAN MAIN			AUX
Mode	Frequency (MHz)	Average power (dBm)	Average power (dBm)
802.11a	5745	14.39	14.16
	5785	14.11	13.89
	5825	14.36	14.53
802.11n-HT20	5745	14.31	14.38
	5785	14.08	14.13
	5825	14.32	14.22
802.11n-HT40	5755	15.66	15.82
	5795	14.69	14.91
802.11ac-VHT80	5775	15.36	15.3

Mode	Frequency (MHz)	Average power (dBm)		
		1Mbps	2Mbps	3Mbps
v3.0 with EDR	2402	4.40	2.31	1.84
	2441	3.17	1.30	1.00
	2480	2.04	0.05	-0.51
Tune-up Limit		5	2.5	2

Mode	Frequency (MHz)	Average power (dBm)
		GFSK
v4.0 with LE	2402	3.03
	2440	3.64
	2480	4.50
Tune-up Limit		5

Antenna Location

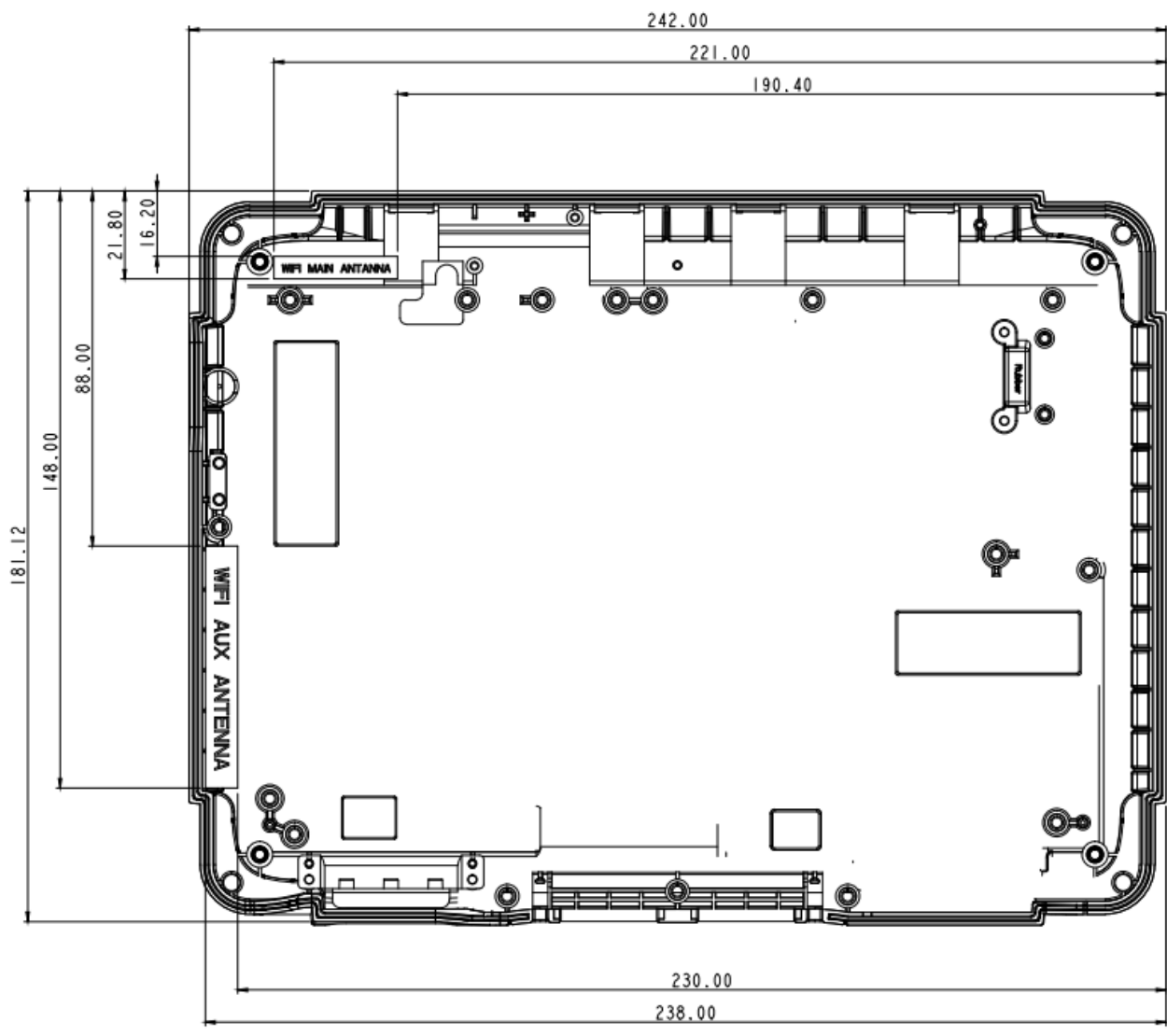

Note: The Protective material on corners was removed during SAR test.

Sample Edge Location

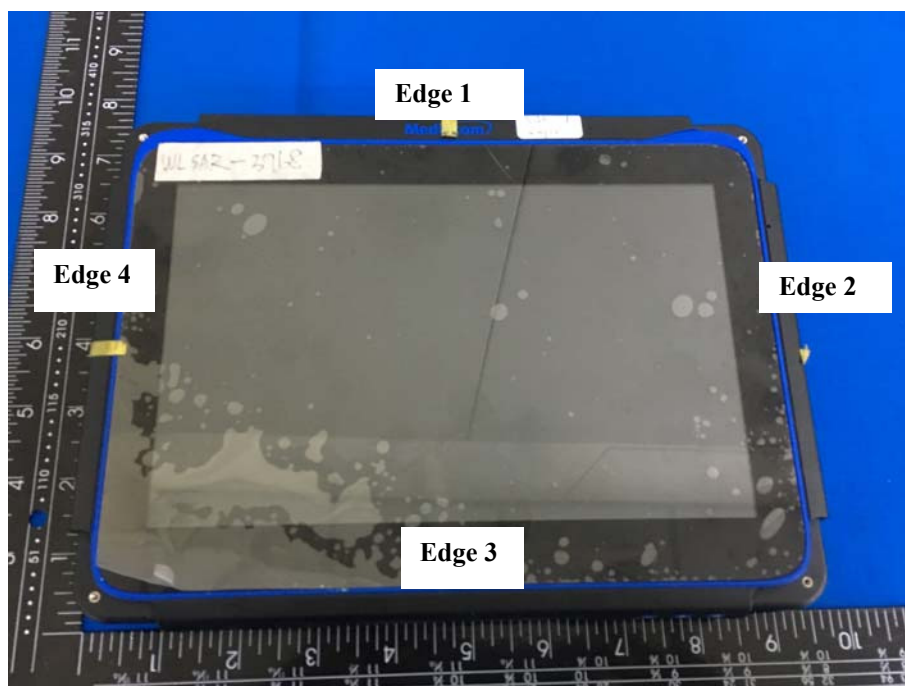

Antenna Distance To Edge

Antenna Distance To Edge (mm)					
Antenna	Back	Edge 1	Edge 2	Edge 3	Edge 4
Bluetooth/WLAN AUX (Antenna 1)	5	88	5	33	230
WLAN Main (Antenna 0)	5	16.2	21.8	159.3	190

Standalone SAR test exclusion considerations

Mode	Frequency (MHz)	Tune-up (dBm)	Tune-up (mW)	Distance (mm)	Calculated value	Threshold (1-g)	SAR Test Exclusion
WLAN 2.4G	2412	15.5	35	5	10.87	3	NO
WLAN 5G	5270	14.5	28	5	12.86	3	NO
Bluetooth	2480	5	3	5	0.94	3	YES

NOTE:

The 1-g and 10-g SAR test exclusion thresholds for 100 MHz to 6 GHz at test separation distances ≤ 50 mm are determined by:

$$[(\text{max. power of channel, including tune-up tolerance, mW}) / (\text{min. test separation distance, mm})] \cdot [\sqrt{f(\text{GHz})}] \leq 3.0 \text{ for 1-g SAR and } \leq 7.5 \text{ for 10-g extremity SAR, where}$$

1. f(GHz) is the RF channel transmit frequency in GHz.
2. Power and distance are rounded to the nearest mW and mm before calculation.
3. The result is rounded to one decimal place for comparison.
4. When the minimum test separation distance is < 5 mm, a distance of 5 mm is applied to determine SAR test Exclusion.

Distance < 50mm

Exposure Position	Wireless Interface	BT	2.4GHz WLAN MAIN	2.4GHz WLAN AUX	5GHz WLAN MAIN	5GHz WLAN AUX
	Calculated Frequency	2480MHz	2437MHz	2437MHz	5755MHz	5755MHz
Maximum power (dBm)	5	19	18	16	16	
Maximum rated power(mW)	3.0	79.0	63.0	40.0	40.0	
Back	Separation distance(mm)	5.0	5.0	5.0	5.0	5.0
	exclusion threshold	0.9	24.8	19.8	19.3	19.3
	Testing required?	No	Yes	Yes	Yes	Yes
Edge 1	Separation distance(mm)	88.0	16.2	88.0	16.2	88.0
	exclusion threshold	475.0	7.7	476.0	6.0	442.0
	Testing required?	No	Yes	No	Yes	No
Edge 2	Separation distance(mm)	5.0	21.8	5.0	21.8	5.0
	exclusion threshold	0.9	5.7	19.8	4.4	19.3
	Testing required?	No	Yes	Yes	Yes	Yes
Edge 3	Separation distance(mm)	33.0	159.3	33.0	159.3	33.0
	exclusion threshold	0.1	1189.0	3.0	1155.0	2.9
	Testing required?	No	No	No	No	No
Edge 4	Separation distance(mm)	230.0	190.0	230.0	190.0	230.0
	exclusion threshold	1895.0	1496.0	1896.0	1462.0	1862.0
	Testing required?	No	No	No	No	No

The 1-g and 10-g SAR test exclusion thresholds for 100 MHz to 6 GHz at test separation distances ≤ 50 mm are determined by:

$$[(\text{max. power of channel, including tune-up tolerance, mW}) / (\text{min. test separation distance, mm})] \cdot [\sqrt{f(\text{GHz})}] \leq 3.0 \text{ for 1-g SAR and } \leq 7.5 \text{ for 10-g extremity SAR, where}$$

1. f(GHz) is the RF channel transmit frequency in GHz.
2. Power and distance are rounded to the nearest mW and mm before calculation.
3. The result is rounded to one decimal place for comparison.
4. When the minimum test separation distance is < 5 mm, a distance of 5 mm is applied to determine SAR test Exclusion.

Distance>50mm

Exposure Position	Wireless Interface	BT	2.4GHz	2.4GHz	5GHz	5GHz
			WLAN MAIN	WLAN AUX	WLAN MAIN	WLAN AUX
Position	Calculated Frequency	2480MHz	2437MHz	2437MHz	5755MHz	5755MHz
	Maximum power (dBm)	5	19	18	16	16
	Maximum rated power(mW)	3.0	79.0	63.0	40.0	40.0
Back	Separation distance(mm)	5.0	5.0	5.0	5.0	5.0
	exclusion threshold	0.9	24.8	19.8	19.3	19.3
	Testing required?	No	Yes	Yes	Yes	Yes
Edge 1	Separation distance(mm)	88.0	16.2	88.0	16.2	88.0
	exclusion threshold	475.0	7.7	476.0	6.0	442.0
	Testing required?	No	Yes	No	Yes	No
Edge 2	Separation distance(mm)	5.0	21.8	5.0	21.8	5.0
	exclusion threshold	0.9	5.7	19.8	4.4	19.3
	Testing required?	No	Yes	Yes	Yes	Yes
Edge 3	Separation distance(mm)	33.0	159.3	33.0	159.3	33.0
	exclusion threshold	0.1	1189.0	3.0	1155.0	2.9
	Testing required?	No	No	No	No	No
Edge 4	Separation distance(mm)	230.0	190.0	230.0	190.0	230.0
	exclusion threshold	1895.0	1496.0	1896.0	1462.0	1862.0
	Testing required?	No	No	No	No	No

At 100 MHz to 6 GHz and for *test separation distances* > 50 mm, the SAR test exclusion threshold is determined according to the following:

- a) [Power allowed at numeric threshold for 50 mm in step 1) + (test separation distance - 50 mm)·(f(MHz)/150)] mW, at 100 MHz to 1500 MHz
- b) [Power allowed at numeric threshold for 50 mm in step 1) + (test separation distance - 50 mm)·10] mW at > 1500 MHz and ≤ 6 GHz

Standalone SAR estimation:

Mode	Edge	Frequency (MHz)	Tune-up (dBm)	Tune-up (mW)	Distance (mm)	Estimated 1-g (W/kg)
Bluetooth	Back	2480	5	3	5	0.126
	Edge 2	2480	5	3	5	0.126

When standalone SAR test exclusion applies to an antenna that transmits simultaneously with other antennas, the standalone SAR must be estimated according to following to determine simultaneous transmission SAR test exclusion:

$$[(\text{max. power of channel, including tune-up tolerance , mW}) / (\text{min. test separation distance,mm})] \cdot [\sqrt{f(\text{GHz})} / x]$$

W/kg for test separation distances ≤50 mm;
 where x = 7.5 for 1-g SAR.

0.4 W/kg for 1-g SAR and 1.0 W/kg for 10-g SAR, when the *test separation distances* is > 50 mm.

When the minimum test separation distance is < 5 mm, a distance of 5 mm is applied to determine SAR test Exclusion

Note: the maximum power was used for evaluation.

2.4 GHz 802.11g/n OFDM SAR Test Exclusion Requirements

For WLAN 2.4G Band SISO Chain 0(Main):

	Mode	Average Power	Tune-Up Limit	Measured 1g SAR	Reported 1g SAR	Note
WLAN 2.4G	802.11b	15.35	15.50		0.025	
WLAN 2.4G	802.11n-HT40	15.35	19.00	0.025	0.058	NO Test

For WLAN 2.4G Band SISO Chain 1(Aux):

	Mode	Average Power	Tune-Up Limit	Measured 1g SAR	Reported 1g SAR	Note
WLAN 2.4G	802.11b	15.18	15.50		0.220	
WLAN 2.4G	802.11an-HT40	15.18	18.00	0.220	0.421	No Test

Note:

KDB 248227 D01-SAR is not required for 2.4 GHz OFDM when the highest reported SAR for DSSS is adjusted by the ratio of OFDM to DSSS specified maximum output power and the adjusted SAR is ≤ 1.2 W/kg.

SAR MEASUREMENT RESULTS

This page summarizes the results of the performed dosimetric evaluation.

Test Results :

Environmental Conditions:

Temperature:	22.2-23.6 °C	22.4-23.6 °C
Relative Humidity:	26 %	27 %
ATM Pressure:	1001 mbar	1003 mbar
Test Date:	2017-1-16	2017-1-18

General Note:

1. Per KDB 447498 D01v06, the reported SAR is the measured SAR value adjusted for maximum tune-up tolerance.
 - a. Tune-up scaling Factor = tune-up limit power (mW) / EUT RF power (mW), where tune-up limit is the maximum rated power among all production units.
 - b. For SAR testing of WLAN signal with non-100% duty cycle, the measured SAR is scaled-up by the duty cycle scaling factor which is equal to "1/(duty cycle)"
 - c. For WLAN: Reported SAR(W/kg)= Measured SAR(W/kg)* Duty Cycle scaling factor * Tune-up scaling factor
2. Per KDB 447498 D01v06, for each exposure position, testing of other required channels within the operating mode of a frequency band is not required when the *reported* 1-g or 10-g SAR for the mid-band or highest output power channel is:
 - ≤ 0.8 W/kg or 2.0 W/kg, for 1-g or 10-g respectively, when the transmission band is ≤ 100 MHz
 - ≤ 0.6 W/kg or 1.5 W/kg, for 1-g or 10-g respectively, when the transmission band is between 100 MHz and 200 MHz
 - ≤ 0.4 W/kg or 1.0 W/kg, for 1-g or 10-g respectively, when the transmission band is ≥ 200 MHz

WLAN Note:

1. Per KDB 248227 D01v02r02, for 2.4GHz 802.11g/n SAR testing is not required when the highest reported SAR for DSSS is adjusted by the ratio of OFDM to DSSS specified maximum output power and the adjusted SAR is ≤ 1.2 W/kg.
2. Per KDB 248227 D01v02r02, for U-NII-1 Head and Body-worn SAR testing is not required when the U-NII-2A band highest reported SAR for a test configuration is ≤ 1.2 W/kg, SAR is not required for U-NII-1 band.
3. When the reported SAR of the test position is > 0.4 W/kg, SAR is repeated for the 802.11 transmission mode configuration tested in the initial test position to measure the subsequent next closet/smallest test separation distance and maximum coupling test position on the highest maximum output power channel, until the report SAR is ≤ 0.8 W/kg or all required test position are tested.
4. For all positions / configurations, when the reported SAR is > 0.8 W/kg, SAR is measured for these test positions / configurations on the subsequent next highest measured output power channel(s) until the reported SAR is ≤ 1.2 W/kg or all required channels are tested.
5. For WLAN SAR testing was performed on single antenna RF power in SISO mode is larger or equal to the single antenna RF power in MIMO mode, and for RF exposure assessment of MIMO mode simultaneous transmission exclusion analysis was performed with SAR test results of each antenna in SISO mode.
6. Per KDB 248227 D01v02r02, the simultaneous SAR provisions in KDB publication 447498 should be applied to determine simultaneous transmission SAR test exclusion for WiFi MIMO. If the sum of 1g single transmission chain SAR measurements is < 1.6W/kg and SAR peak to location ratio < 0.04, no additional SAR measurements for MIMO.
7. During SAR testing the WLAN transmission was verified using a spectrum analyzer.

<WLAN 2.4G>

Plot No.	Band	Mode	Test Position	Gap (mm)	Antenna	Freq. (MHz)	Average Power (dBm)	Tune-Up Limit (dBm)	Power Drift (dB)	Measured 1g SAR (W/kg)	Reported 1g SAR (W/kg)	Date
1	WLAN2.4G	802.11b	Back	0mm	Main	2412	15.35	15.50	0.13	0.006	0.006	2017/1/16
2	WLAN2.4G	802.11b	Edge 1	0mm	Main	2412	15.35	15.50	0.12	0.024	0.025	2017/1/16
3	WLAN2.4G	802.11b	Edge 2	0mm	Main	2412	15.35	15.50	0.12	0.009	0.009	2017/1/16
4	WLAN2.4G	802.11b	Back	0mm	AUX	2412	15.18	15.50	0.136	0.009	0.010	2017/1/16
5	WLAN2.4G	802.11b	Edge 2	0mm	AUX	2412	15.18	15.50	0.01	0.204	0.220	2017/1/16

<WLAN 5G>

Plot No.	Band	Mode	Test Position	Gap (mm)	Antenna	Freq. (MHz)	Average Power (dBm)	Tune-Up Limit (dBm)	Power Drift (dB)	Measured 1g SAR (W/kg)	Reported 1g SAR (W/kg)	Date
6	WLAN5G	802.11n-HT40 MCS0	Back	0mm	Main	5270	14.16	14.50	-0.021	0.012	0.013	2017/1/18
7	WLAN5G	802.11n-HT40 MCS0	Edge 1	0mm	Main	5270	14.16	14.50	-0.077	0.189	0.204	2017/1/18
8	WLAN5G	802.11n-HT40 MCS0	Edge 2	0mm	Main	5270	14.16	14.50	0.153	0.032	0.035	2017/1/18
9	WLAN5G	802.11n-HT40 MCS0	Back	0mm	AUX	5270	14.04	14.50	0.14	0.279	0.310	2017/1/18
10	WLAN5G	802.11n-HT40 MCS0	Edge 2	0mm	AUX	5270	14.04	14.50	-0.061	0.502	0.558	2017/1/18
11	WLAN5G	802.11n-HT40 MCS0	Back	0mm	Main	5670	14.35	14.50	-0.133	0.024	0.025	2017/1/18
12	WLAN5G	802.11n-HT40 MCS0	Edge 1	0mm	Main	5670	14.35	14.50	-0.047	0.208	0.215	2017/1/18
13	WLAN5G	802.11n-HT40 MCS0	Edge 2	0mm	Main	5670	14.35	14.50	-0.136	0.044	0.046	2017/1/18
14	WLAN5G	802.11n-HT40 MCS0	Back	0mm	AUX	5670	14.60	15.00	0.133	0.354	0.388	2017/1/18
15	WLAN5G	802.11n-HT40 MCS0	Edge 2	0mm	AUX	5670	14.60	15.00	0.167	0.484	0.531	2017/1/18
16	WLAN5G	802.11n-HT40 MCS0	Back	0mm	Main	5755	15.66	16.00	-0.162	0.020	0.022	2017/1/18
17	WLAN5G	802.11n-HT40	Edge 1	0mm	Main	5755	15.66	16.00	-0.132	0.182	0.197	2017/1/18

		MCS0										
18	WLAN5G	802.11n-HT40 MCS0	Edge 2	0mm	Main	5755	15.66	16.00	-0.177	0.064	0.069	2017/1/18
19	WLAN5G	802.11n-HT40 MCS0	Back	0mm	AUX	5755	15.69	16.00	0.102	0.316	0.339	2017/1/18
20	WLAN5G	802.11n-HT40 MCS0	Edge 2	0mm	AUX	5755	15.69	16.00	0.057	0.427	0.459	2017/1/18

FINAL

SAR SIMULTANEOUS TRANSMISSION DESCRIPTION

Simultaneous Transmission:

General Note:

1. EUT will choose either WLAN 2.4GHz or WLAN 5GHz according to the network signal condition; therefore, 2.4GHz WLAN and 5GHz WLAN will not operate simultaneously at any moment.
2. WLAN and Bluetooth share the same antenna AUX for tablet mode, so WLAN and Bluetooth cannot transmit simultaneously at antenna AUX.
3. According to EUT character, Bluetooth with antenna AUX can transmit simultaneously with WLAN antenna MAIN.

Simultaneous SAR test exclusion considerations:

WLAN Main + WLAN AUX:

Mode (SAR1+SAR2)	Position	Reported SAR (W/kg)		Σ SAR < 1.6W/kg
		SAR1	SAR2	
WLAN Main + WLAN Aux 2.4G Band	Body -Back	0.006	0.010	0.016
	Body -Edge 2	0.009	0.220	0.229
WLAN Main + WLAN Aux 5.3G Band	Body -Back	0.013	0.310	0.323
	Body -Edge 2	0.035	0.558	0.593
WLAN Main + WLAN Aux 5.6G Band	Body -Back	0.025	0.388	0.413
	Body -Edge 2	0.046	0.531	0.577
WLAN Main + WLAN Aux 5.8G Band	Body -Back	0.022	0.339	0.361
	Body -Edge 2	0.069	0.459	0.528

For MIMO mode, the output power per chain was less than SISO mode, the SISO SAR was used for evaluation.

Bluetooth + WLAN Main:

Mode (SAR1+SAR2)	Position	Reported SAR (W/kg)		Σ SAR < 1.6W/kg
		SAR1	SAR2	
Bluetooth + WLAN Main 2.4G Band	Body -Back	0.126	0.006	0.132
	Body -Edge 2	0.126	0.009	0.135
Bluetooth + WLAN Main 5.3G Band	Body -Back	0.126	0.013	0.139
	Body -Edge 2	0.126	0.035	0.161
Bluetooth + WLAN Main 5.6G Band	Body -Back	0.126	0.025	0.151
	Body -Edge 2	0.126	0.046	0.172
Bluetooth + WLAN Main 5.8G Band	Body -Back	0.126	0.022	0.148
	Body -Edge 2	0.126	0.069	0.195

APPENDIX A MEASUREMENT UNCERTAINTY

The uncertainty budget has been determined for the DASY4 measurement system and is given in the following Table.

DASY4 Uncertainty Budget According to IEEE 1528								
Error Description	Uncertainty Value	Prob. Dist.	Div.	(c i) 1g	(c i) 10g	Std. Unc. (1g)	Std. Unc. (10g)	(v i) veff
Measurement System								
Probe Calibration	± 6.0 %	N	1	1	1	± 6.0 %	± 6.0 %	∞
Axial Isotropy	± 4.7 %	R	√3	0.7	0.7	± 1.9 %	± 1.9 %	∞
Hemispherical Isotropy	± 9.6 %	R	√3	0.7	0.7	± 3.9 %	± 3.9 %	∞
Boundary Effects	± 1.0 %	R	√3	1	1	± 0.6 %	± 0.6 %	∞
Linearity	± 4.7 %	R	√3	1	1	± 2.7 %	± 2.7 %	∞
System Detection Limits	± 1.0 %	R	√3	1	1	± 0.6 %	± 0.6 %	∞
Readout Electronics	± 0.3 %	N	1	1	1	± 0.3 %	± 0.3 %	∞
Response Time	± 0.8 %	R	√3	1	1	± 0.5 %	± 0.5 %	∞
Integration Time	± 2.6 %	R	√3	1	1	± 1.5 %	± 1.5 %	∞
RF Ambient Noise	± 3.0 %	R	√3	1	1	± 1.7 %	± 1.7 %	∞
RF Ambient Conditions	± 3.0 %	R	√3	1	1	± 1.7 %	± 1.7 %	∞
Probe Positioner	± 0.4 %	R	√3	1	1	± 0.2 %	± 0.2 %	∞
Probe Positioning	± 2.9 %	R	√3	1	1	± 1.7 %	± 1.7 %	∞
Max. SAR Eval.	± 1.0 %	R	√3	1	1	± 0.6 %	± 0.6 %	∞
Test Sample Related								
Device Positioning	± 2.9 %	N	1	1	1	± 2.9 %	± 2.9 %	145
Device Holder	± 3.6 %	N	1	1	1	± 3.6 %	± 2.6 %	5
Power Drift	± 5.0 %	R		1	1	± 2.9 %	± 2.9 %	∞
Phantom and Setup								
Phantom Uncertainty	± 4.0 %	R	√3	1	1	± 2.3 %	± 2.3 %	∞
Liquid Conductivity (Target)	± 5.0 %	R	√3	0.64	0.43	± 1.8 %	± 1.2 %	∞
Liquid Conductivity (meas.)	± 2.5 %	N	1	0.64	0.43	± 1.6 %	± 1.1 %	∞
Liquid Permittivity (Target)	± 5.0 %	R	√3	0.6	0.49	± 1.7 %	± 1.4 %	∞
Liquid Permittivity (meas.)	± 2.5 %	N	1	0.6	0.49	± 1.5 %	± 1.0 %	∞
Combined Std. Uncertainty	-	-	-	-	-	± 10.7 %	± 10.4 %	330
Expanded STD Uncertainty	-	-	-	-	-	± 21.4 %	± 20.8 %	-

DASY4 Uncertainty Budget According to IEC 62209-2								
Error Description	Uncertainty Value	Prob. Dist.	Div.	(c i) 1g	(c i) 10g	Std. Unc. (1g)	Std. Unc. (10g)	(v i) v _{eff}
Measurement System								
Probe Calibration	± 6.0 %	N	1	1	1	± 6.0 %	± 6.0 %	∞
Axial Isotropy	± 4.7 %	R	√3	0.7	0.7	± 1.9 %	± 1.9 %	∞
Boundary Effects	± 1.0 %	R	√3	1	1	± 0.6 %	± 0.6 %	∞
Linearity	± 4.7 %	R	√3	1	1	± 2.7 %	± 2.7 %	∞
System Detection Limits	± 1.0 %	R	√3	1	1	± 0.6 %	± 0.6 %	∞
Readout Electronics	± 0.3 %	N	1	1	1	± 0.3 %	± 0.3 %	∞
Response Time	± 0.8 %	R	√3	1	1	± 0.5 %	± 0.5 %	∞
Integration Time	± 2.6 %	R	√3	1	1	± 1.5 %	± 1.5 %	∞
RF Ambient Noise	± 3.0 %	R	√3	1	1	± 1.7 %	± 1.7 %	∞
RF Ambient Conditions	± 3.0 %	R	√3	1	1	± 1.7 %	± 1.7 %	∞
Probe Positioner	± 0.4 %	R	√3	1	1	± 0.2 %	± 0.2 %	∞
Probe Positioning	± 2.9 %	R	√3	1	1	± 1.7 %	± 1.7 %	∞
Max. SAR Eval.	± 1.0 %	R	√3	1	1	± 0.6 %	± 0.6 %	∞
Test Sample Related								
Device Positioning	± 2.9 %	N	1	1	1	± 2.9 %	± 2.9 %	145
Device Holder	± 3.6 %	N	1	1	1	± 3.6 %	± 2.6 %	5
Power Drift	± 5.0 %	R		1	1	± 2.9 %	± 2.9 %	∞
Phantom and Setup								
Phantom Uncertainty	± 4.0 %	R	√3	1	1	± 2.3 %	± 2.3 %	∞
Liquid Conductivity (Target)	± 5.0 %	R	√3	0.64	0.43	± 1.8 %	± 1.2 %	∞
Liquid Conductivity (meas.)	± 2.5 %	N	1	0.64	0.43	± 1.6 %	± 1.1 %	∞
Liquid Permittivity (Target)	± 5.0 %	R	√3	0.6	0.49	± 1.7 %	± 1.4 %	∞
Liquid Permittivity (meas.)	± 2.5 %	N	1	0.6	0.49	± 1.5 %	± 1.0 %	∞
Combined Std. Uncertainty	-	-	-	-	-	± 10.7 %	± 10.4 %	330
Expanded STD Uncertainty	-	-	-	-	-	± 21.4 %	± 20.8 %	-