



FCC PART 15.407
DYNAMIC FREQUENCY SELECTION
TEST REPORT

For

DT Research Inc.
 6F., NO.1, Ning-Po E. Street, Taipei 100, Taiwan.

FCC ID: YE3800J
Model: DT395CR, Atlas 91i

Report Type: Original Report	Product Type: Mobile Tablet
Report Producer: Kaylee Chiang	<i>Kaylee Chiang</i>
Report Number: RTWD161214002-00F	
Report Date: 2017-01-11	
Reviewed By: Jerry Chang	<i>Jerry Chang</i>
Bay Area Compliance Laboratories Corp.(Taiwan) 70, Lane 169, Sec. 2, Datong Road, Xizhi Dist., New Taipei City 22183, Taiwan, R.O.C. Tel: +886 (2) 2647 6898 Fax: +886 (2) 2647 6895 www.bacl.com.tw	

Note: This test report is prepared for the customer shown above and for the device described herein. It may not be duplicated or used in part without prior written consent from Bay Area Compliance Laboratories Corp. (Taiwan)

TABLE OF CONTENTS

GENERAL INFORMATION.....	3
PRODUCT DESCRIPTION FOR EQUIPMENT UNDER TEST (EUT).....	3
OBJECTIVE	3
TEST METHODOLOGY	3
TEST FACILITY	3
SYSTEM TEST CONFIGURATION.....	4
DESCRIPTION OF TEST CONFIGURATION	4
EUT EXERCISE SOFTWARE	4
EQUIPMENT MODIFICATIONS	4
SUPPORT EQUIPMENT LIST AND DETAILS	4
SUMMARY OF TEST RESULTS	5
APPLICABLE STANDARDS.....	6
DFS REQUIREMENT	6
DFS MEASUREMENT SYSTEM.....	10
SYSTEM BLOCK DIAGRAM	10
RADIATED METHOD.....	12
TEST PROCEDURE	12
TEST RESULTS.....	13
DESCRIPTION OF EUT	13
CHANNEL LOADING	13
TEST EQUIPMENT LIST AND DETAILS.....	13
CONDUCTED TEST SETUP CONFIGURATION	14
CALIBRATION OF DFS DETECTION THRESHOLD LEVEL.....	14
TEST ENVIRONMENTAL CONDITIONS	14
CHANNEL MOVE TIME AND CHANNEL CLOSING TRANSMISSION TIME	23
TEST PROCEDURE	23
TEST RESULTS	23
NON-OCCUPANCY PERIOD.....	30
TEST PROCEDURE	30
TEST RESULT	30

GENERAL INFORMATION

Product Description for Equipment under Test (EUT)

Applicant:	DT Research Inc. 6F., NO. 1, Ning-Po E. Street, Taipei 100, Taiwan
Manufacturer:	DT Research Inc. 6F., NO. 1, Ning-Po E. Street, Taipei 100, Taiwan
Product:	Mobile Tablet
Model:	DT395CR, Atlas 91i
Trade Name:	DT Research Inc.
Voltage Range:	I/P: 100-240Vac, 1.7A O/P: 19Vdc, 3.42A
Dimension	257 mm (L) × 198 mm (W) × 29.4 mm (H)
Date of Test:	Jan 10, 2017~Jan 10, 2017

Objective

This report is prepared on behalf of *DT Research Inc.* in accordance with Part 2-Subpart J, Part 15-Subparts A, B and E of the Federal Communications Commission's rules.

The tests were performed in order to determine compliance with FCC Part 15.407(h)(2) Radar Detection Function of Dynamic Frequency Selection (DFS);

Test Methodology

FCC CFR 47 Part2, Part15.407 (h)
FCC KDB 905462 D02 UNII DFS Compliance Procedures New Rules v02
FCC KDB 905462 D03 UNII Clients Without Radar Detection New Rules v01r02

Test Facility

The Test site used by Bay Area Compliance Laboratories Corp. (Taiwan) to collect test data is located on the 70, Lane 169, Sec. 2, Datong Road, Xizhi Dist., New Taipei City 22183, Taiwan, R.O.C.

Test site at Bay Area Compliance Laboratories Corp. (Taiwan) has been fully described in reports submitted to the Federal Communication Commission (FCC). The details of these reports have been found to be in compliance with the requirements of Section 2.948 of the FCC Rules on December 06, 2014. The facility also complies with the radiated and AC line conducted test site criteria set forth in ANSI C63.10.

The Federal Communications Commission has the reports on file and is listed under FCC Registration No.: 431084. The test site has been approved by the FCC for public use and is listed in the FCC Public Access Link (PAL) database.

SYSTEM TEST CONFIGURATION

Description of Test Configuration

The EUT was configured for testing in a normal mode which was provided by the manufacturer.

EUT Exercise Software

The firmware installed in the EUT during testing was: Intel®Dual Band Wireless-AC 7265
Firmware Rev: 18.40.0.9

Equipment Modifications

N/A

Support Equipment List and Details

Manufacturer	Description	Model	Serial Number
DELL	NB	E6410	10912240367
Dlink	AP Router	WMC-AC01	NA

Master device FCC ID: RRK2012060056-1

SUMMARY OF TEST RESULTS

The following result table represents the list of measurements required under the CFR §47 Part 15.407(h), and KDB: 905462 D02 UNII DFS Compliance Procedures New Rules v02

Items	Description of Test	Result
Detection Bandwidth	UNII Detection Bandwidth	Not applicable
Performance Requirements Check	Initial Channel Availability Check Time (CAC)	Not applicable
	Radar Burst at the Beginning of the CAC	Not applicable
	Radar Burst at the End of the CAC	Not applicable
In-Service Monitoring	Channel Move Time	Compliant
	Channel Closing Transmission Time	Compliant
	Non-Occupancy Period	Compliant
Radar Detection	Statistical Performance Check	Not applicable

Note:

Not applicable: the EUT is a client unit without radar detection

APPLICABLE STANDARDS

DFS Requirement

CFR §47 Part 15.407(h),

FCC KDB 905462 D02 UNII DFS Compliance Procedures New Rules v02

Table 1: Applicability of DFS Requirements Prior to Use of a Channel

Requirement	Operational Mode		
	Master	Client Without Radar Detection	Client With Radar Detection
<i>Non-Occupancy Period</i>	Yes	Not required	Yes
<i>DFS Detection Threshold</i>	Yes	Not required	Yes
<i>Channel Availability Check Time</i>	Yes	Not required	Not required
<i>U-NII Detection Bandwidth</i>	Yes	Not required	Yes

Table 2: Applicability of DFS requirements during normal operation

Requirement	Operational Mode	
	Master Device or Client with Radar Detection	Client Without Radar Detection
<i>DFS Detection Threshold</i>	Yes	Not required
<i>Channel Closing Transmission Time</i>	Yes	Yes
<i>Channel Move Time</i>	Yes	Yes
<i>U-NII Detection Bandwidth</i>	Yes	Not required

Additional requirements for devices with multiple bandwidth modes	Master Device or Client with Radar Detection	Client Without Radar Detection
<i>U-NII Detection Bandwidth and Statistical Performance Check</i>	All BW modes must be tested	Not required
<i>Channel Move Time and Channel Closing Transmission Time</i>	Test using widest BW mode available	Test using the widest BW mode available for the link
<i>All other tests</i>	Any single BW mode	Not required

Note: Frequencies selected for statistical performance check (Section 7.8.4) should include several frequencies within the radar detection bandwidth and frequencies near the edge of the radar detection bandwidth. For 802.11 devices it is suggested to select frequencies in each of the bonded 20 MHz channels and the channel center frequency.

Table 3: DFS Detection Thresholds for Master Devices and Client Devices With Radar Detection

Maximum Transmit Power	Value (See Notes 1, 2, and 3)
EIRP ≥ 200 milliwatt	-64 dBm
EIRP < 200 milliwatt and power spectral density < 10 dBm/MHz	-62 dBm
EIRP < 200 milliwatt that do not meet the power spectral density requirement	-64 dBm
<p>Note 1: This is the level at the input of the receiver assuming a 0 dBi receive antenna.</p> <p>Note 2: Throughout these test procedures an additional 1 dB has been added to the amplitude of the test transmission waveforms to account for variations in measurement equipment. This will ensure that the test signal is at or above the detection threshold level to trigger a DFS response.</p> <p>Note 3: EIRP is based on the highest antenna gain. For MIMO devices refer to KDB Publication 662911 D01.</p>	

Table 4: DFS Response Requirement Values

Parameter	Value
<i>Non-occupancy period</i>	Minimum 30 minutes
<i>Channel Availability Check Time</i>	60 seconds
<i>Channel Move Time</i>	10 seconds See Note 1.
<i>Channel Closing Transmission Time</i>	200 milliseconds + an aggregate of 60 milliseconds over remaining 10 second period. See Notes 1 and 2.
<i>U-NII Detection Bandwidth</i>	Minimum 100% of the U-NII 99% transmission power bandwidth. See Note 3.
<p>Note 1: <i>Channel Move Time</i> and the <i>Channel Closing Transmission Time</i> should be performed with Radar Type 0. The measurement timing begins at the end of the Radar Type 0 burst.</p> <p>Note 2: The <i>Channel Closing Transmission Time</i> is comprised of 200 milliseconds starting at the beginning of the <i>Channel Move Time</i> plus any additional intermittent control signals required to facilitate a <i>Channel</i> move (an aggregate of 60 milliseconds) during the remainder of the 10 second period. The aggregate duration of control signals will not count quiet periods in between transmissions.</p> <p>Note 3: During the <i>U-NII Detection Bandwidth</i> detection test, radar type 0 should be used. For each frequency step the minimum percentage of detection is 90 percent. Measurements are performed with no data traffic.</p>	

Table 5 – Short Pulse Radar Test Waveforms

Radar Type	Pulse Width (μsec)	PRI (μsec)	Number of Pulses	Minimum Percentage of Successful Detection	Minimum Number of Trials
0	1	1428	18	See Note 1	See Note 1
1	1	Test A: 15 unique PRI values randomly selected from the list of 23 PRI values in Table 5a	Roundup $\left\{ \left(\frac{1}{360} \right) \cdot \left(\frac{19 \cdot 10^6}{\text{PRI}_{\mu\text{sec}}} \right) \right\}$	60%	30
		Test B: 15 unique PRI values randomly selected within the range of 518-3066 μsec, with a minimum increment of 1 μsec, excluding PRI values selected in Test A			
2	1-5	150-230	23-29	60%	30
3	6-10	200-500	16-18	60%	30
4	11-20	200-500	12-16	60%	30
Aggregate (Radar Types 1-4)				80%	120
Note 1: Short Pulse Radar Type 0 should be used for the detection bandwidth test, channel move time, and channel closing time tests.					

A minimum of 30 unique waveforms are required for each of the Short Pulse Radar Types 2 through 4. If more than 30 waveforms are used for Short Pulse Radar Types 2 through 4, then each additional waveform must also be unique and not repeated from the previous waveforms. If more than 30 waveforms are used for Short Pulse Radar Type 1, then each additional waveform is generated with Test B and must also be unique and not repeated from the previous waveforms in Tests A or B.

For example if in Short Pulse Radar Type 1 Test B a PRI of 3066 usec is selected, the number of pulses

would be $\text{Roundup} \left\{ \left(\frac{1}{360} \right) \cdot \left(\frac{19 \cdot 10^6}{3066} \right) \right\} = \text{Roundup} \{17.2\} = 18.$

Table 5a - Pulse Repetition Intervals Values for Test A

Pulse Repetition Frequency Number	Pulse Repetition Frequency (Pulses Per Second)	Pulse Repetition Interval (Microseconds)
1	1930.5	518
2	1858.7	538
3	1792.1	558
4	1730.1	578
5	1672.2	598
6	1618.1	618
7	1567.4	638
8	1519.8	658
9	1474.9	678
10	1432.7	698
11	1392.8	718
12	1355	738
13	1319.3	758
14	1285.3	778
15	1253.1	798
16	1222.5	818
17	1193.3	838
18	1165.6	858
19	1139	878
20	1113.6	898
21	1089.3	918
22	1066.1	938
23	326.2	3066

The aggregate is the average of the percentage of successful detections of Short Pulse Radar Types 1-4. For example, the following table indicates how to compute the aggregate of percentage of successful detections.

Radar Type	Number of Trials	Number of Successful Detections	Minimum Percentage of Successful Detection
1	35	29	82.9%
2	30	18	60%
3	30	27	90%
4	50	44	88%
Aggregate $(82.9\% + 60\% + 90\% + 88\%)/4 = 80.2\%$			

Table 6 – Long Pulse Radar Test Waveform

Radar Type	Pulse Width (µsec)	Chirp Width (MHz)	PRI (µsec)	Number of Pulses per Burst	Number of Bursts	Minimum Percentage of Successful Detection	Minimum Number of Trials
5	50-100	5-20	1000-2000	1-3	8-20	80%	30

Table 7 – Frequency Hopping Radar Test Waveform

Radar Type	Pulse Width (µsec)	PRI (µsec)	Pulses per Hop	Hopping Rate (kHz)	Hopping Sequence Length (msec)	Minimum Percentage of Successful Detection	Minimum Number of Trials
6	1	333	9	0.333	300	70%	30

DFS Measurement System

BACL DFS measurement system consists of two subsystems: (1) The radar signal generating subsystem and (2) the traffic monitoring subsystem.

System Block Diagram

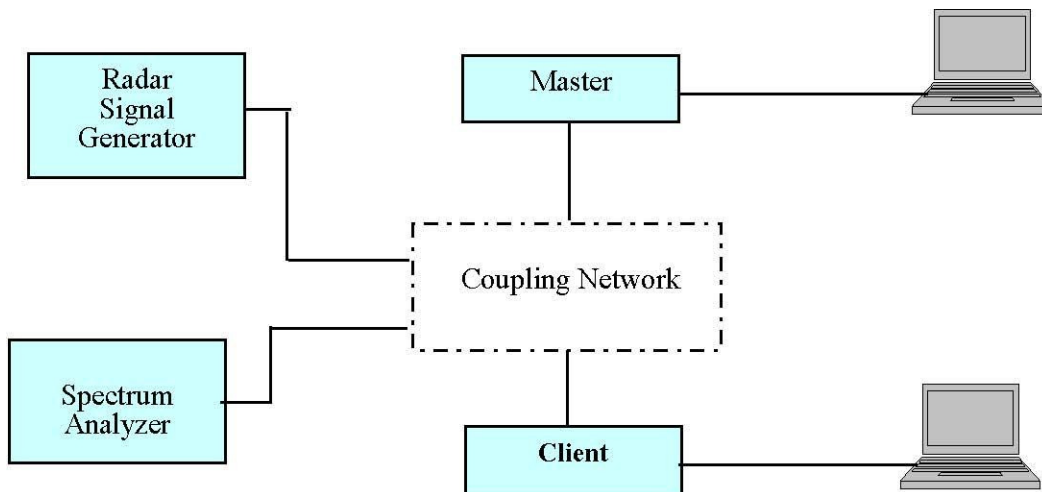

Conducted Method

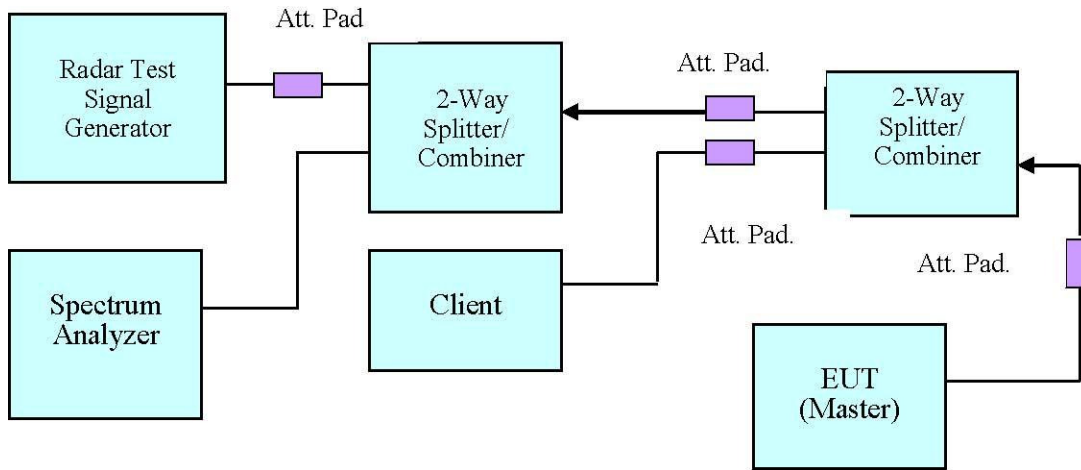

Setup for Master with injection at the Master

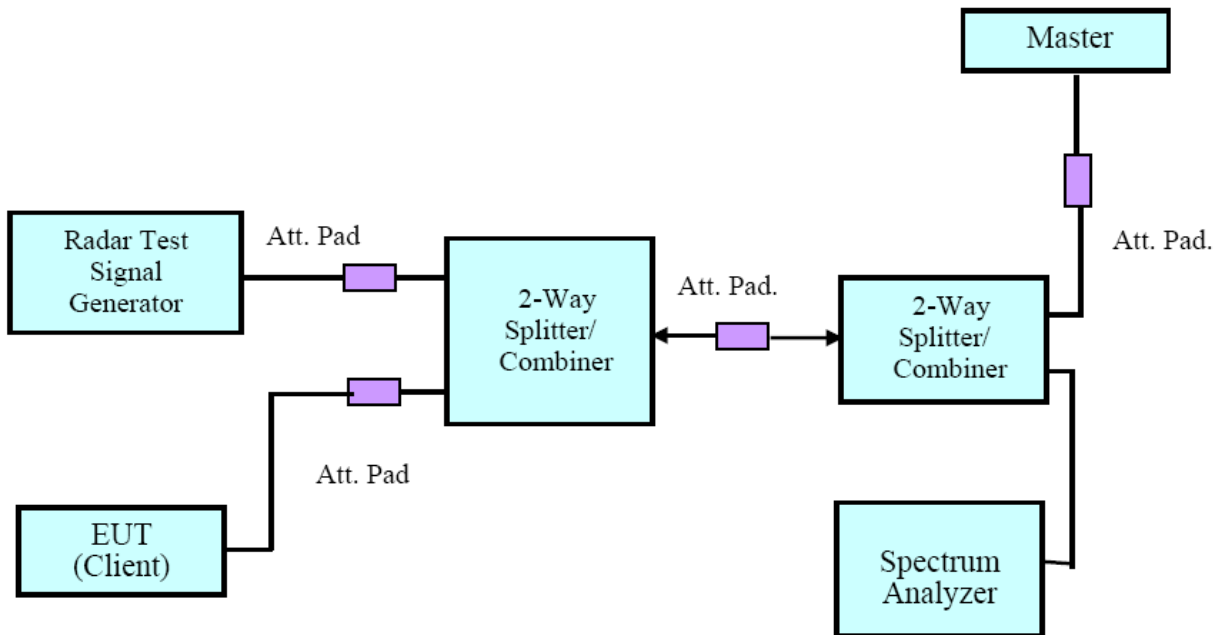

Setup for Client with injection at the Master

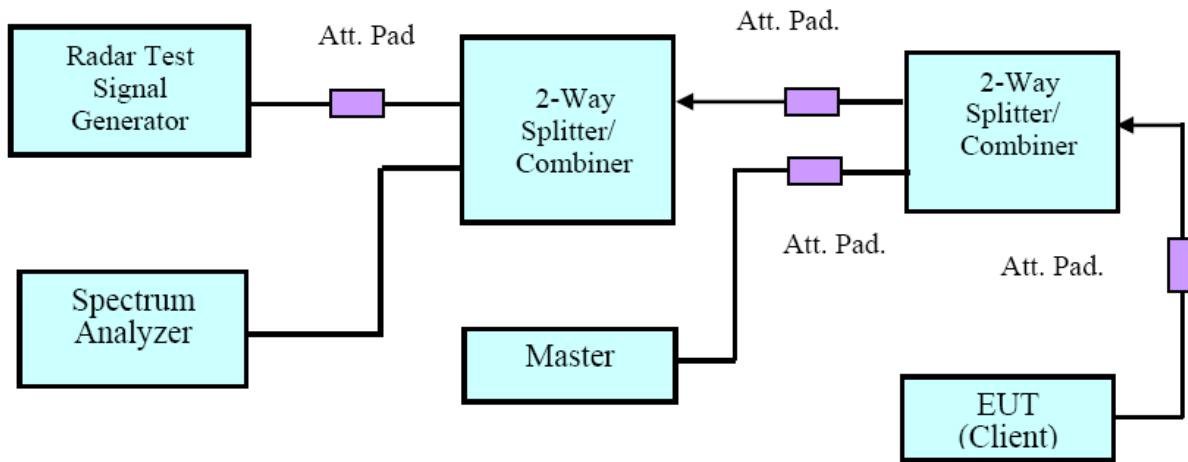

Setup for Client with injection at the Client

Radiated Method

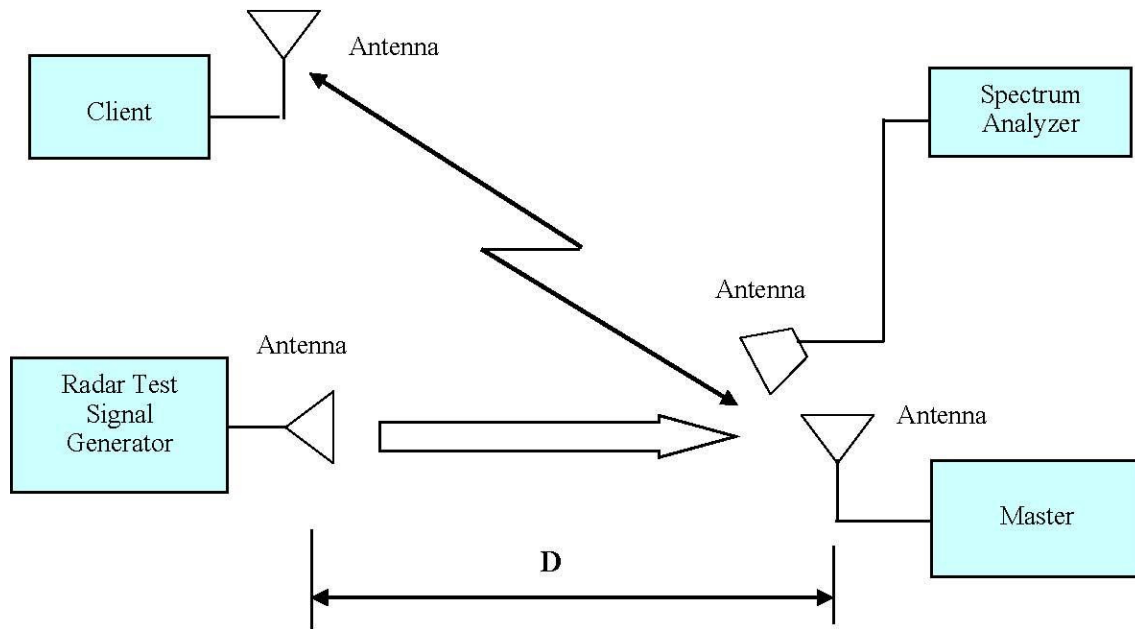

Test Procedure

A spectrum analyzer is used as a monitor verifies that the EUT status including Channel Closing Transmission Time and Channel Move Time, and does not transmit on a Channel during the Non-Occupancy Period after the diction and Channel move. It is also used to monitor EUT transmissions during the Channel Availability Check Time.

TEST RESULTS

Description of EUT

The EUT operates in 5250-5350 MHz and 5470-5725 MHz range.

The rated output power of master device is >23 dBm (EIRP), therefore the required interference threshold level is -64 dBm, the required radiated threshold at antenna port is -64dBm.

Throughout these test procedures an additional 1 dB has been added to the amplitude of the test transmission waveforms to account for variations in measurement equipment. This will ensure that the test signal is at or above the detection threshold level to trigger a DFS response.

The calibrated radiated DFS detection threshold level is set to $-62+1+(\text{Master antenna gain})=$

$-64+3.428+1= -59.572$ dBm.

Channel Loading

System testing will be performed with channel-loading using means appropriate to the data types that are used by the unlicensed device. The following requirements apply:

- a) The data file must be of a type that is typical for the device (i.e., MPEG-2, MPEG-4, WAV, MP3, MP4, AVI, etc.) and must generally be transmitting in a streaming mode.
- b) Software to ping the client is permitted to simulate data transfer but must have random ping intervals.
- c) Timing plots are required with calculations demonstrating a minimum channel loading of approximately 17% or greater. For example, channel loading can be estimated by setting the spectrum analyzer for zero span and approximate the Time On/ (Time On + Off Time). This can be done with any appropriate channel BW and modulation type.
- d) Unicast or Multicast protocols are preferable but other protocols may be used. The appropriate protocol used must be described in the test procedures.

The sample is use method (a)

WLAN traffic is generated by streaming the video file TestFile.mpg, this file is used by IP and Frame based systems for loading the test channel during the In-service compliance testing of the U-NII device. The file is streamed from the Access Point to the Client in full motion video mode using the media player with the V2.61 Codec package.

Test Equipment List and Details

Manufacturer	Description	Model	Serial Number	Calibration Date	Calibration Due Date
Rohde & Schwarz	Rohde & Schwarz	FSU26	200268	2016/5/7	2017/5/6
Rohde & Schwarz	Vector Signal Generator	SMBV100A	261748	2016/11/9	2017/11/8
Mini-Circuits	POWER SPLITTER	ZFRSC-183-S+	SF448201614S	N.C.R	N.C.R
Cable	WOKEN	SFL402	00100A1F6A192S	N.C.R	N.C.R

* Statement of Traceability: Bay Area Compliance Laboratories Corp. (Taiwan) attests that all calibrations have been performed, traceable to National Primary Standards and International System of Units (SI).

Conducted Test Setup Configuration

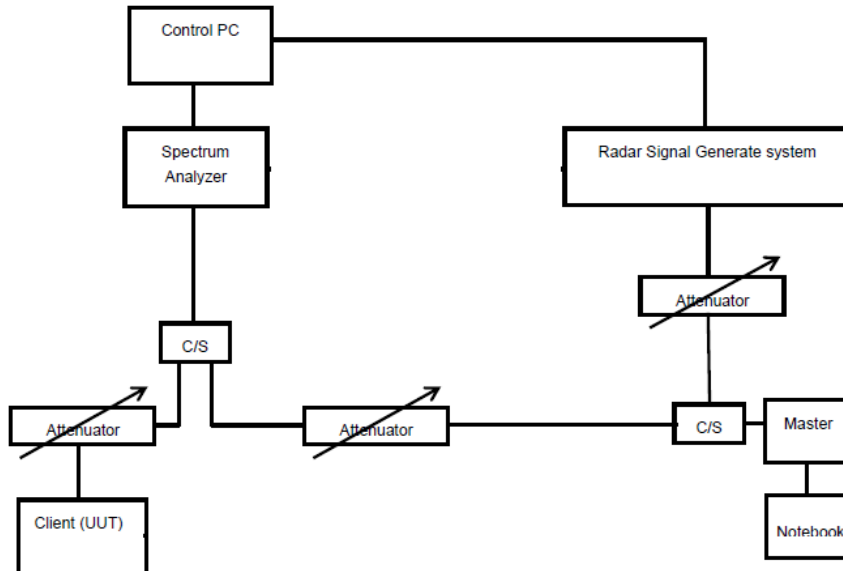

Cablibration of DFS Detection Threshold Level

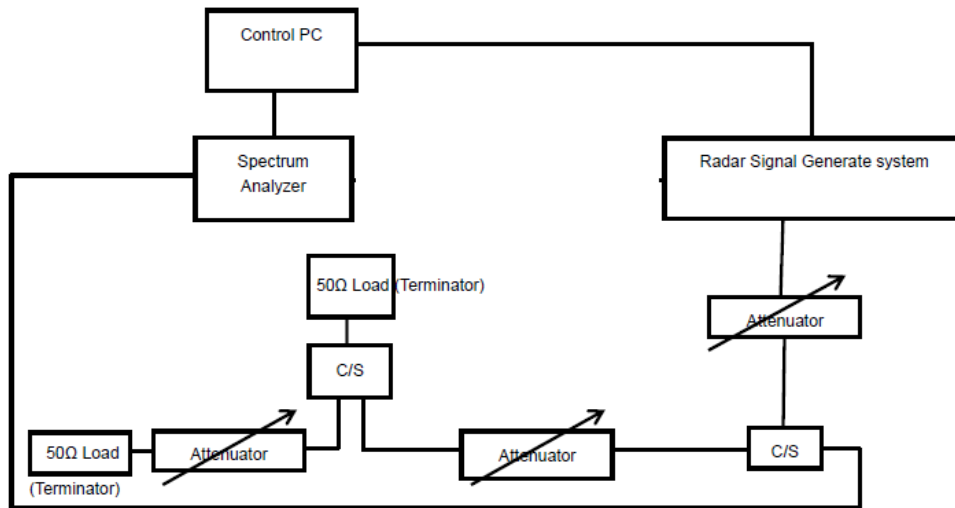

Test Environmental Conditions

Temperature:	25.5 ° C
Relative Humidity:	49 %
ATM Pressure:	100.6 kPa

The testing was performed by David Hsu on 2017-01-10.

Plots of Radar Waveforms

5290 MHz:

Radar Type 0

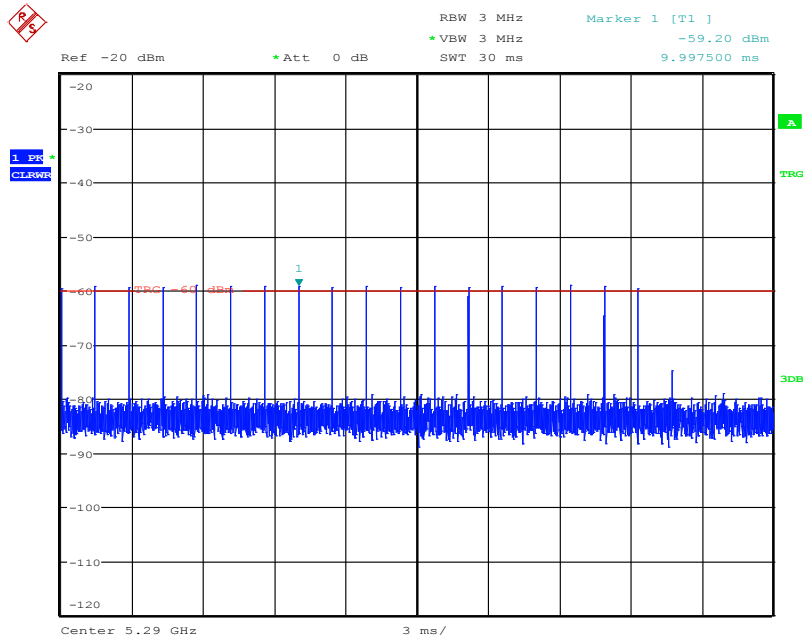

Date: 10.JAN.2017 16:04:07

Radar Type 1A

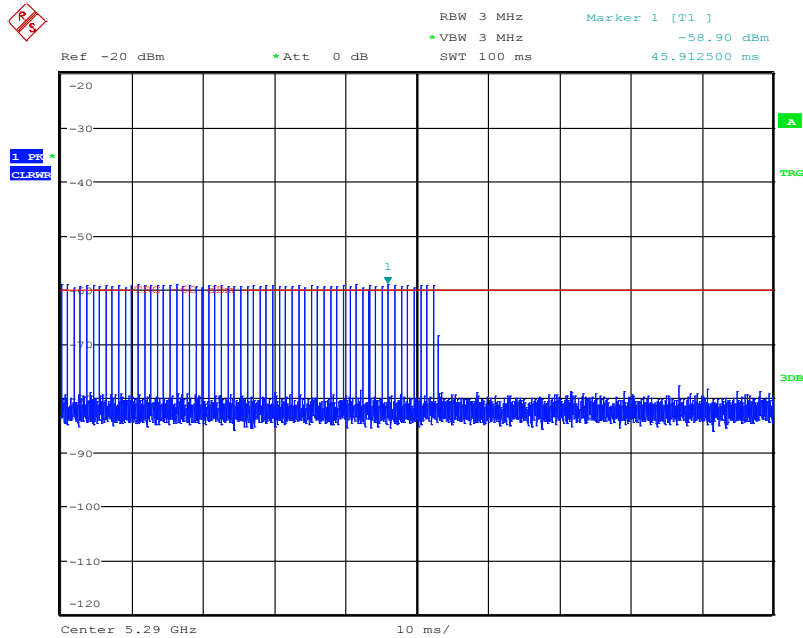

Date: 10.JAN.2017 16:05:53

Radar Type 1B

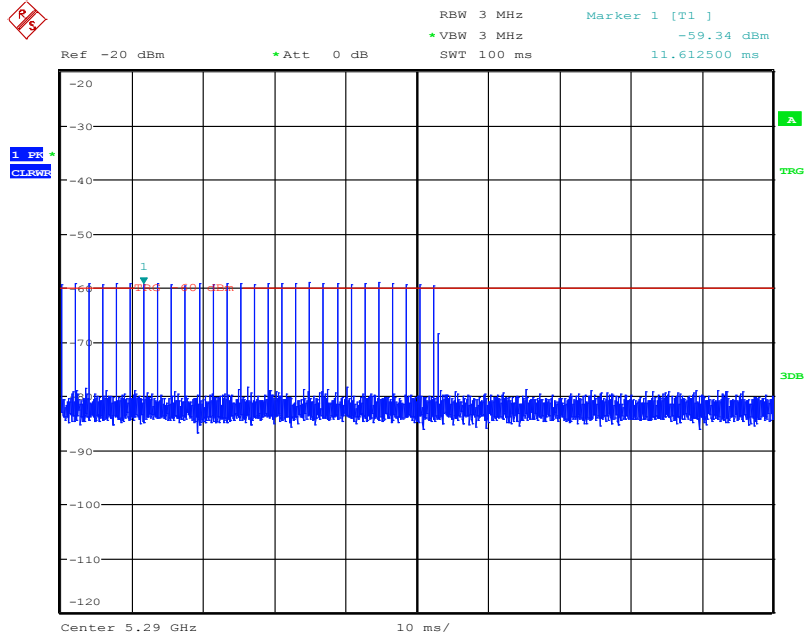

Date: 10.JAN.2017 16:11:04

Radar Type 2

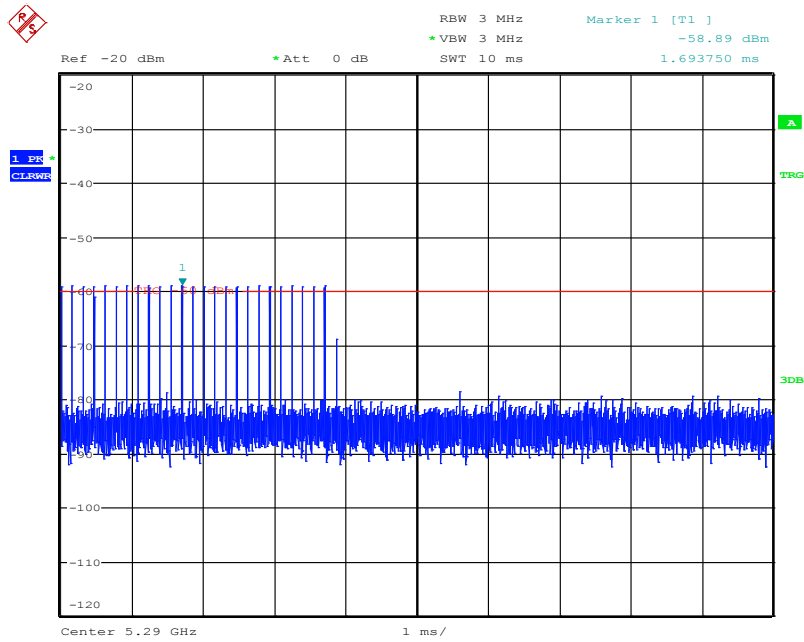

Date: 10.JAN.2017 16:13:40

Radar Type 3

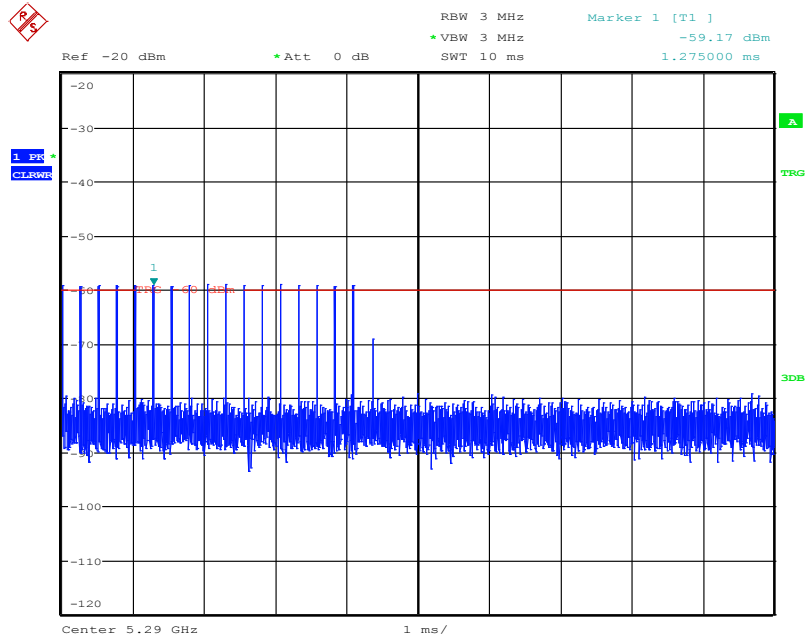

Date: 10.JAN.2017 16:20:42

Radar Type 4

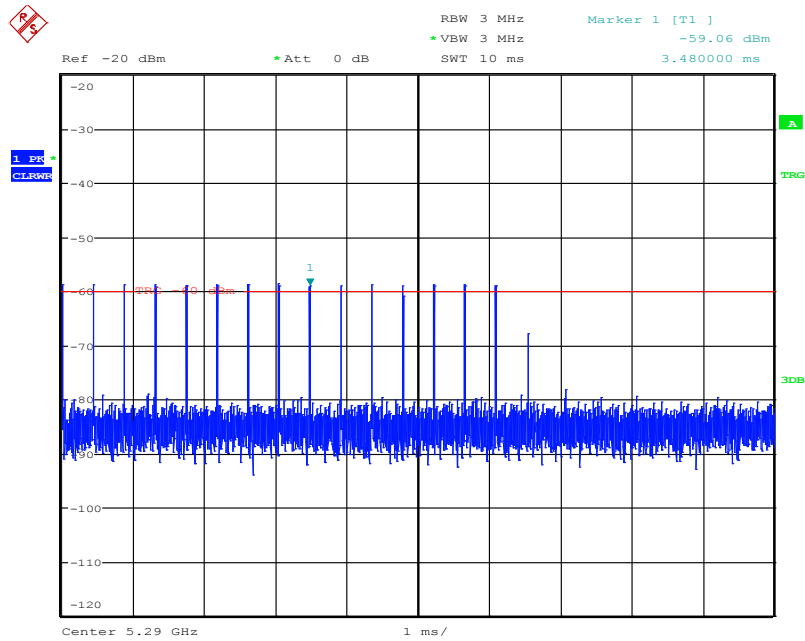

Date: 10.JAN.2017 16:33:57

Radar Type 5

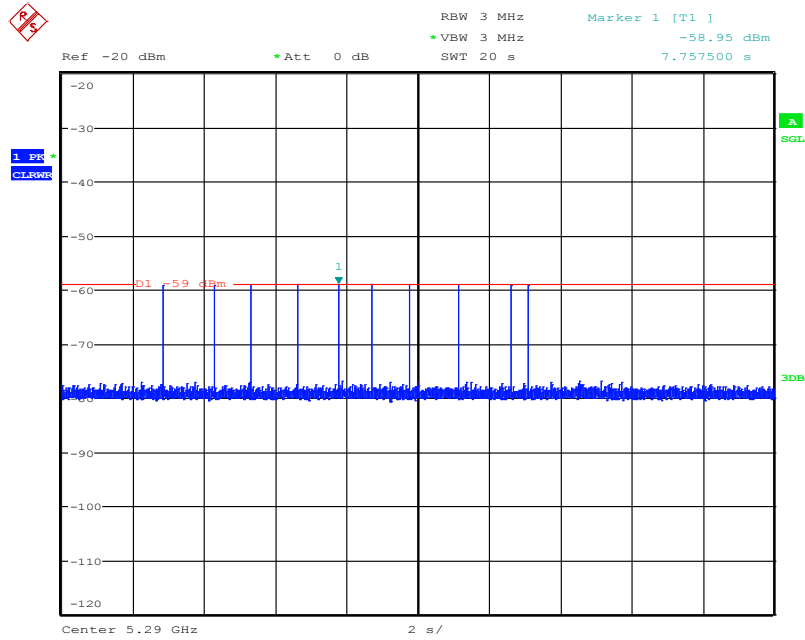

Date: 10.JAN.2017 16:53:23

Radar Type 6

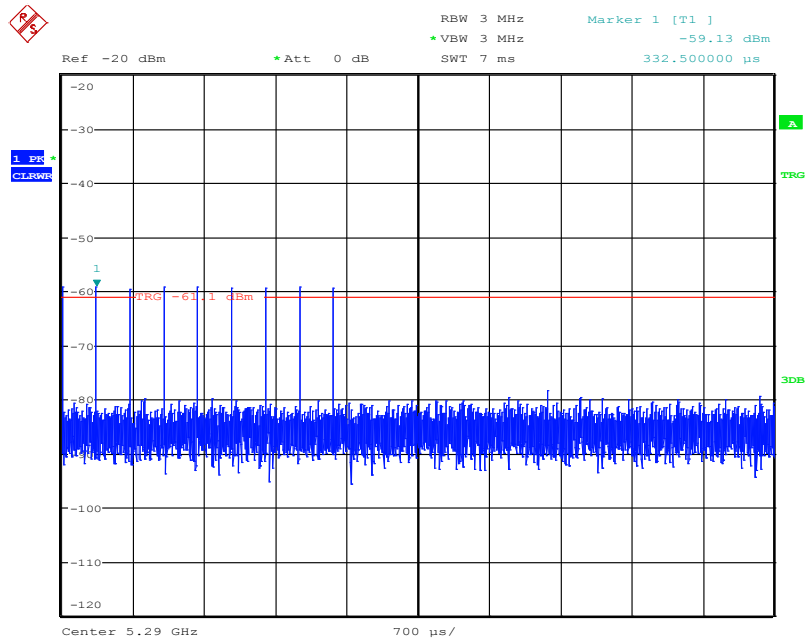

Date: 10.JAN.2017 16:49:33

5530 MHz:

Radar Type 0

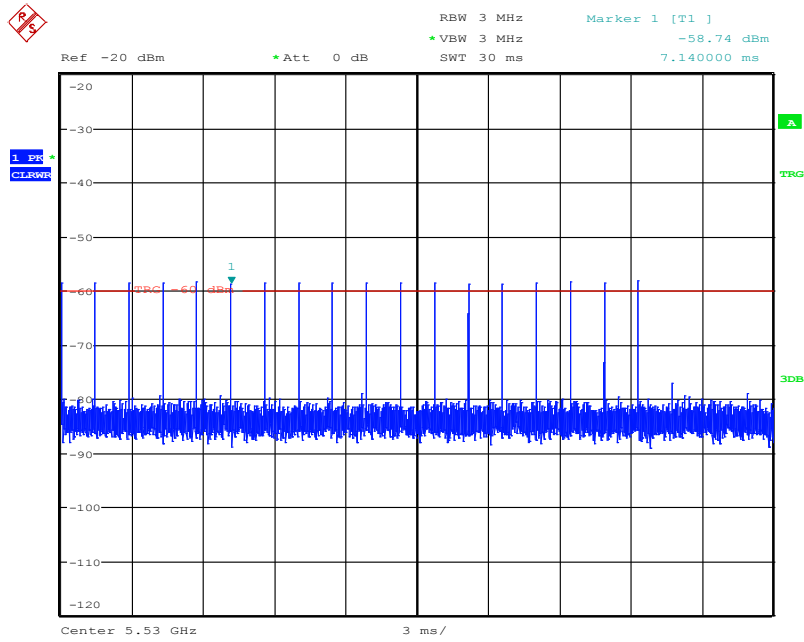

Date: 10.JAN.2017 16:02:21

Radar Type 1A

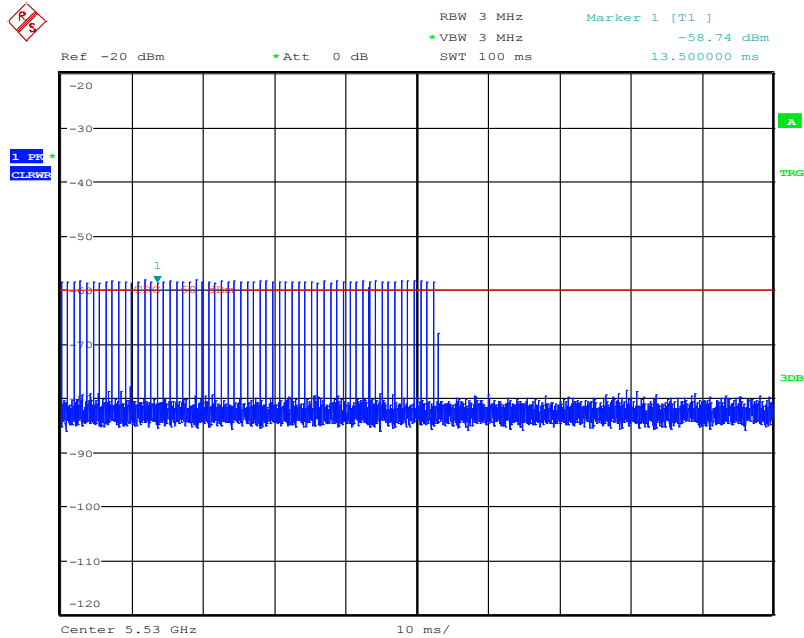

Date: 10.JAN.2017 16:07:15

Radar Type 1B

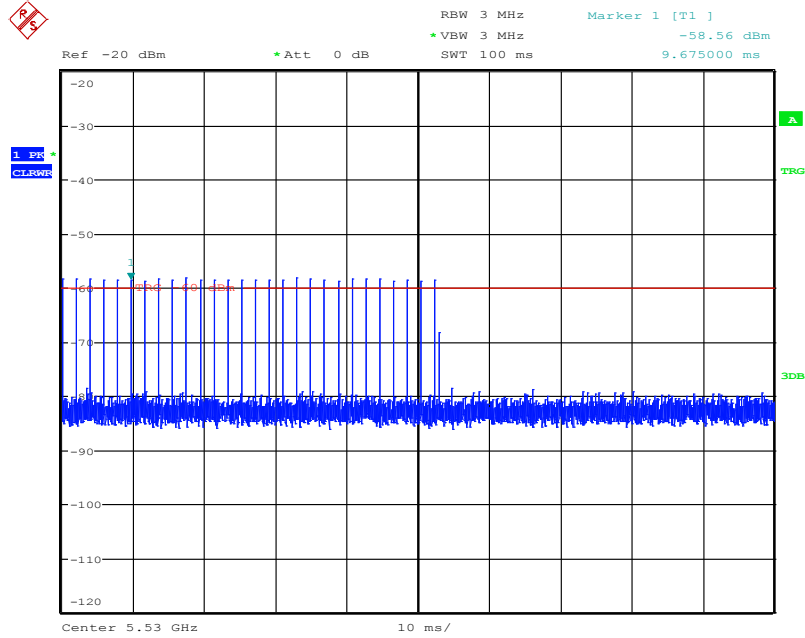

Date: 10.JAN.2017 16:10:19

Radar Type 2

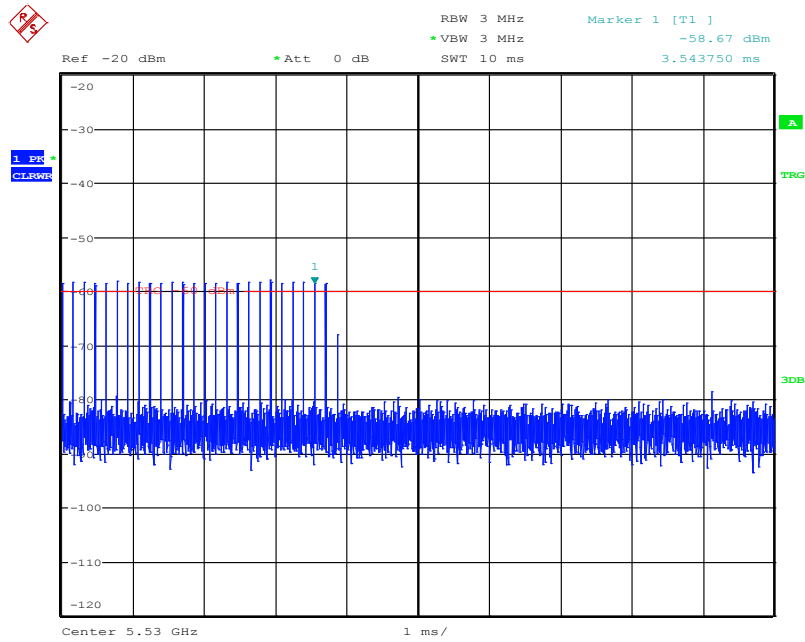

Date: 10.JAN.2017 16:15:07

Radar Type 3

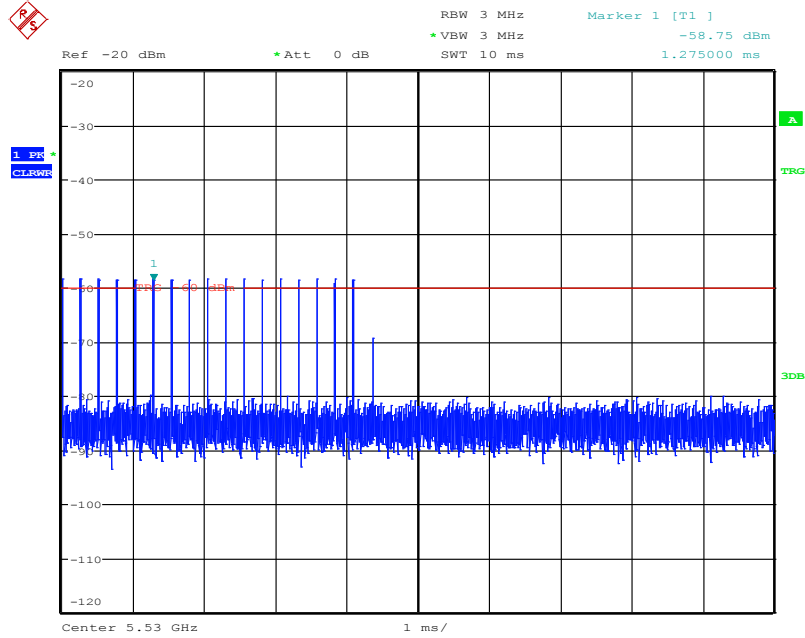

Date: 10.JAN.2017 16:19:40

Radar Type 4

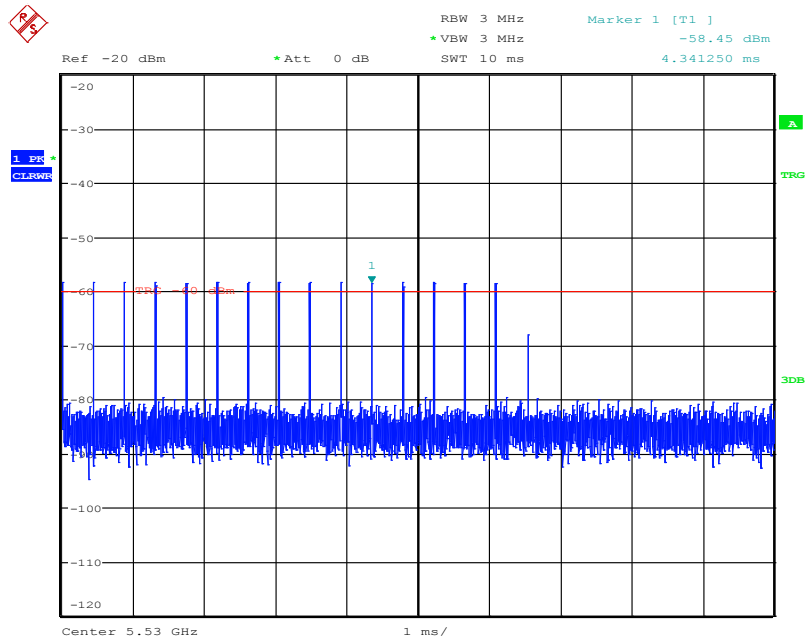

Date: 10.JAN.2017 16:37:02

Radar Type 5

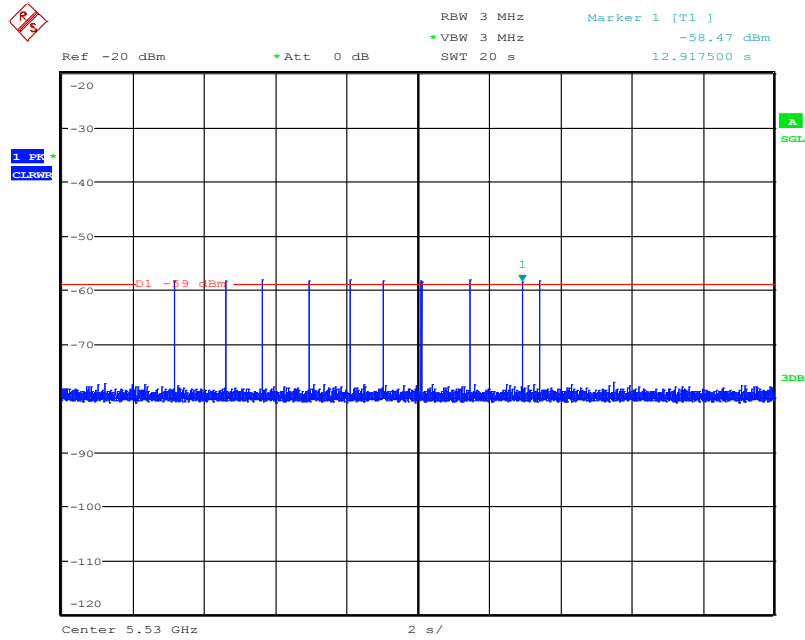

Date: 10.JAN.2017 16:52:13

Radar Type 6

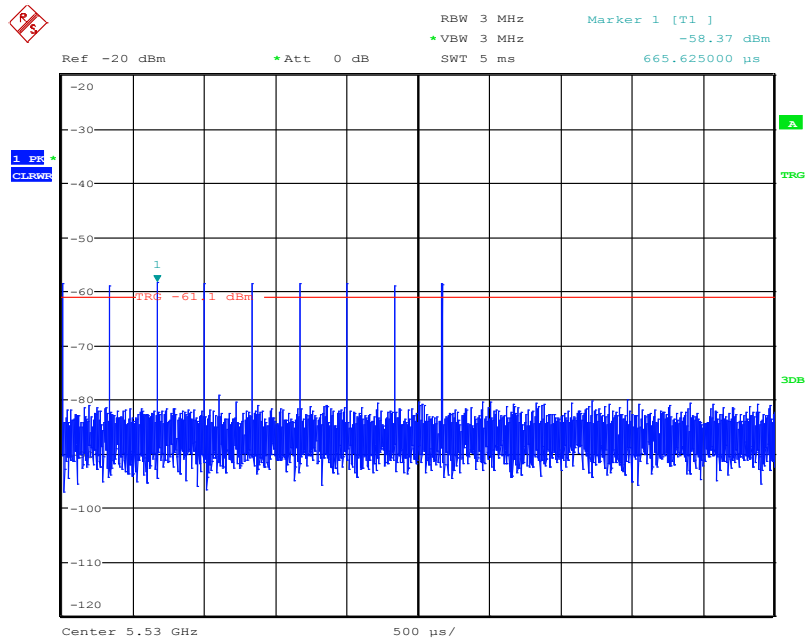

Date: 10.JAN.2017 16:44:15

CHANNEL MOVE TIME AND CHANNEL CLOSING TRANSMISSION TIME

Test Procedure

Perform type 0 short pulse radar waveform. The aggregate channel closing transmission time is calculated as follows:

Aggregate Transmission Time = N*Dwell Time

N is the number of spectrum analyzer bins showing a device transmission Dwell Time is the dwell time per bin (i.e. Dwell Time = S/B, S is the sweep time and B is the number of bin, i.e. 8192)

Test Results

Frequency (MHz)	Bandwidth (MHz)	Radar Type	Results
5290	80	Type 0	Compliant
5530	80	Type 0	Compliant

Please refer to the following tables and plots.

5290 MHz

Type 0 radar channel move time result:

Item	Time (s)	Limit (s)
Channel move time	0.810	10

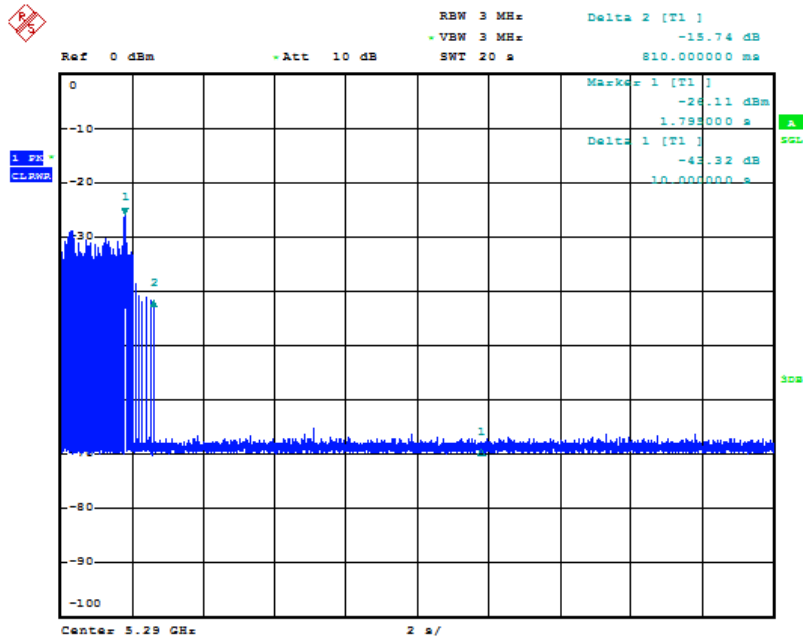

Date: 10. JAN. 2017 10:30:22

Type0 radar channel closing transmission time result:

Item	Time (ms)	Limit (ms)
Closing Transmission Time	17.5	60

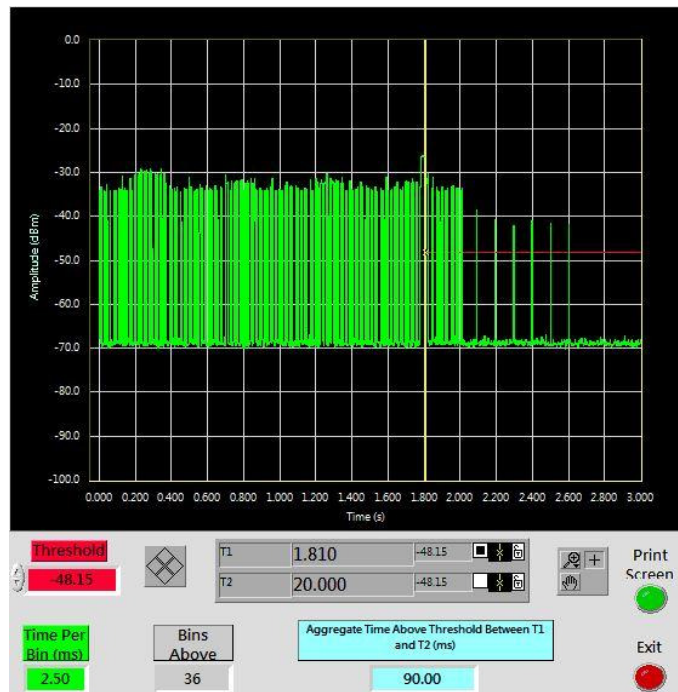
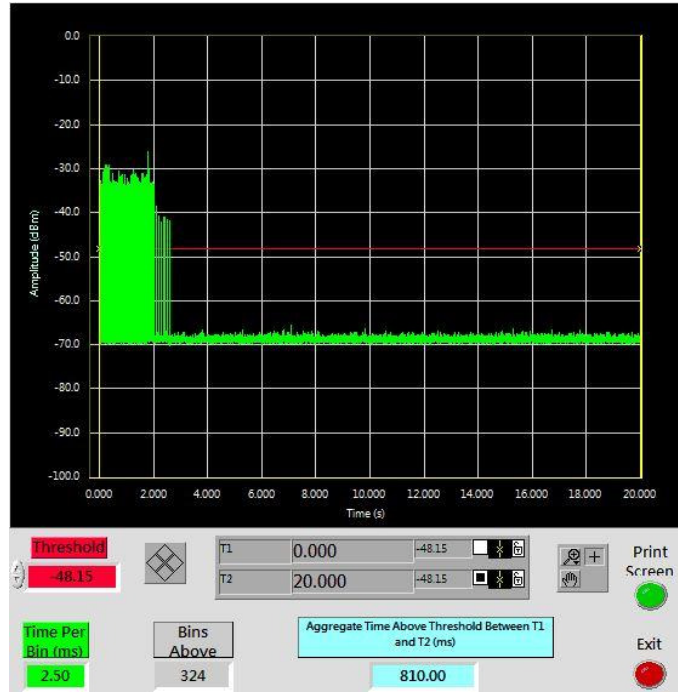

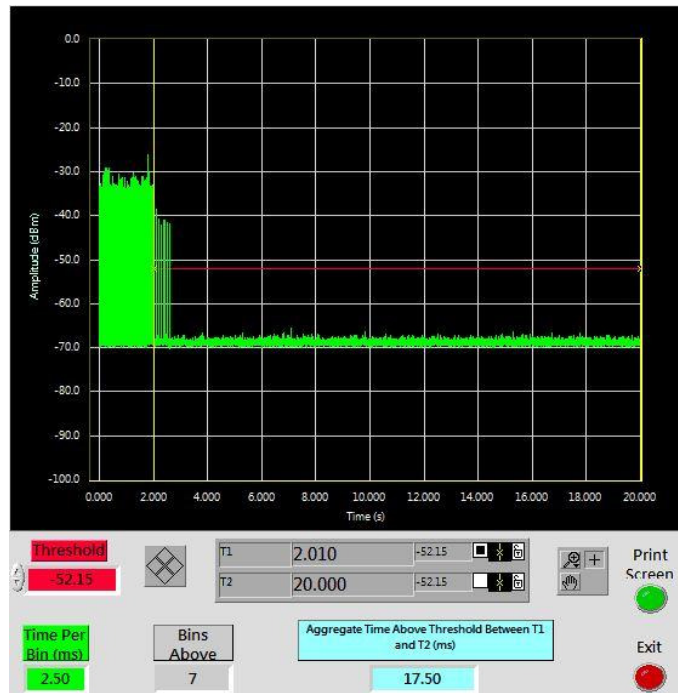
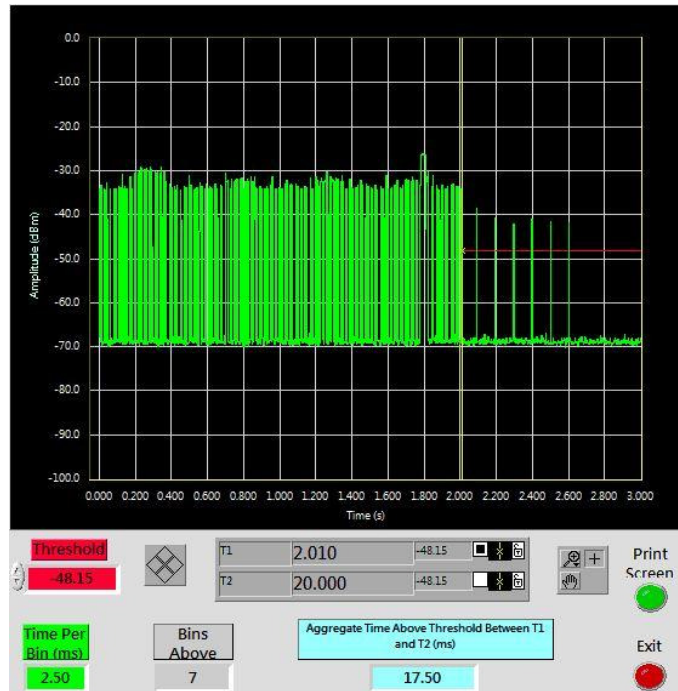

5530 MHz

Type 0 radar channel move time result:

Item	Time (s)	Limit (s)
Channel move time	0.730	10

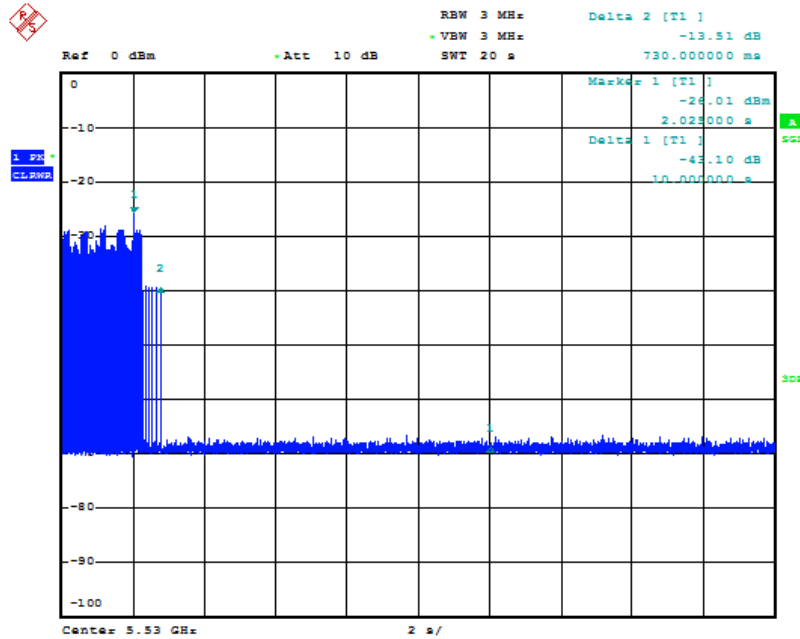

Date: 10. JAN. 2017 13:22:16

Type0 radar channel closing transmission time result:

Item	Time (ms)	Limit (ms)
Closing Transmission Time	15	60

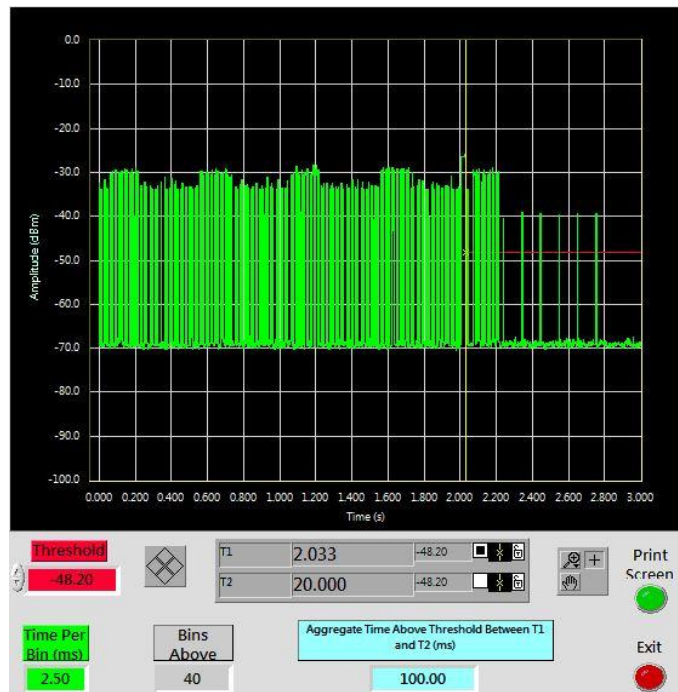
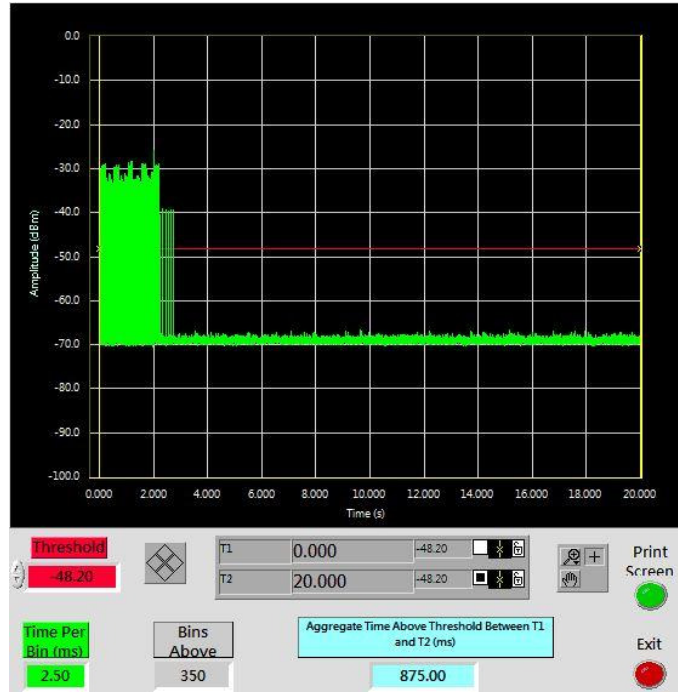

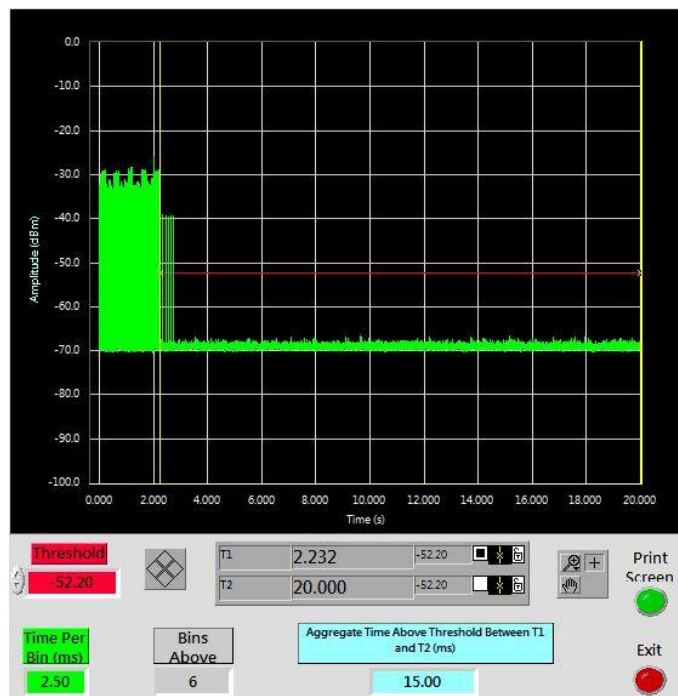
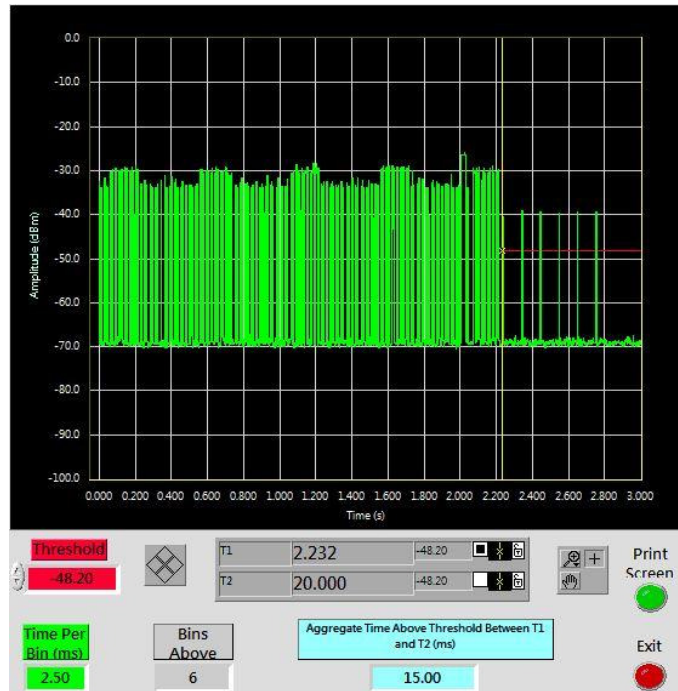

NON-OCCUPANCY PERIOD

Test Procedure

Measure the EUT for more than 30 minutes following the channel close/move time to verify that the EUT does not resume any transmissions on this channel. Provide one plot to demonstrate no transmission on the channel for the non-occupancy period (30 minutes observation time)

Test Result

Frequency(MHz)	Bandwidth (MHz)	Spectrum Analyzer Display
5290	80	No transmission within 30 minutes
5530	80	No transmission within 30 minutes

Please refer to the following plots.

5290 MHz

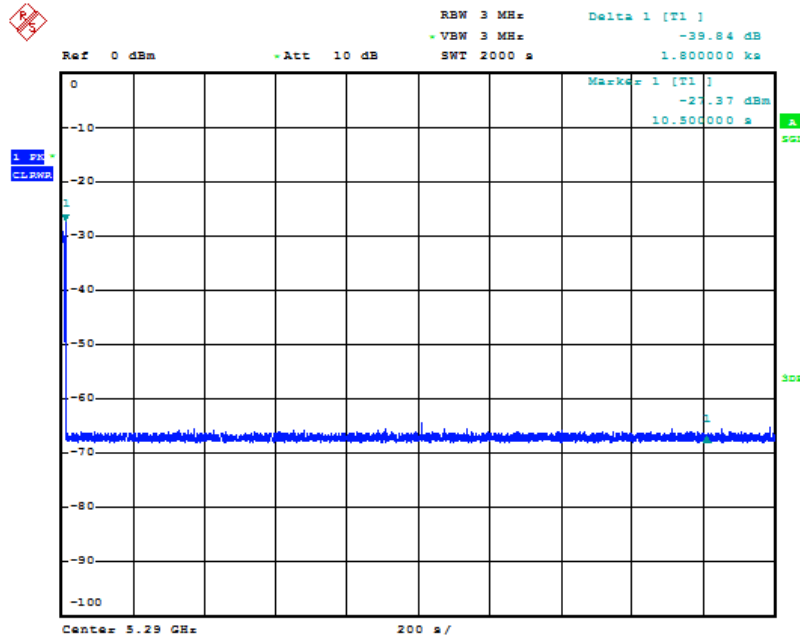

Date: 10. JAN. 2017 11:21:15

5530 MHz

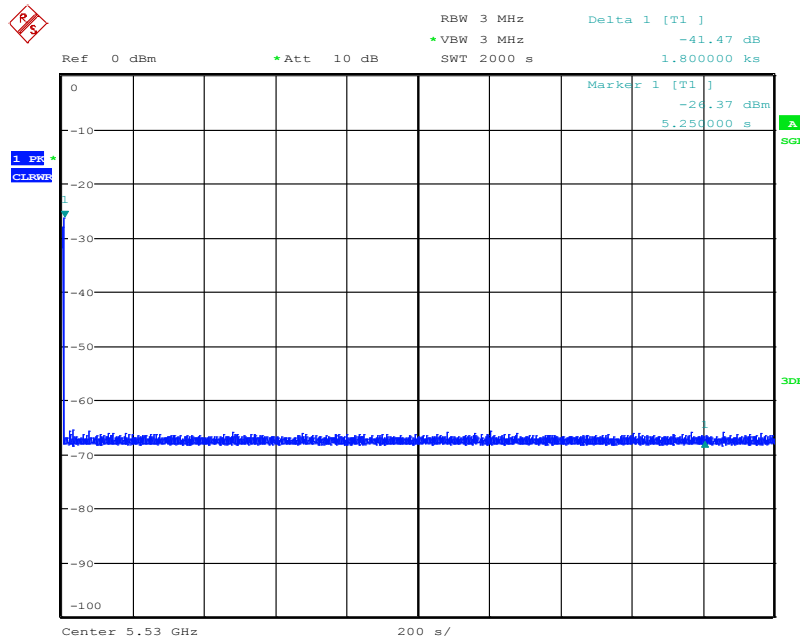

Date: 10. JAN. 2017 14:10:47

***** END OF REPORT *****