

# FCC SAR Test Report

Product Name : Mobile Tablet  
Model No. : DT317BT

Applicant : DT Research, Inc.  
Address : 6F, No. 1, NingPo E. St. Taipei, 100 Taiwan

Date of Receipt : 2017/01/05  
Issued Date : 2017/02/13  
Report No. : 1710172R-SAUSP01V00  
Report Version : V1.0



The test results relate only to the samples tested.

The test results shown in the test report are traceable to the national/international standard through the calibration of the equipment and evaluated measurement uncertainty herein.

This report must not be used to claim product endorsement by TAF or any agency of the government.

The test report shall not be reproduced without the written approval of DEKRA Testing and Certification Co., Ltd.

# Test Report

Issued Date: 2017/02/13

Report No.: 1710172R-SAUSP01V00



Product Name : Mobile Tablet  
Applicant : DT Research, Inc.  
Address : 6F, No. 1, NingPo E. St. Taipei, 100 Taiwan  
Manufacturer : DT Research, Inc.  
Model No. : DT317BT  
Trade Name : DT Research, Inc.  
FCC ID : YE3800H  
Applicable Standard : 47CFR § 2.1093  
KDB 447498 D01 v06  
KDB 616217 D04 v01r02  
Measurement : KDB 248227 D01 v02r02  
procedures : KDB 865664 D01 V01r04  
Test Result : Max. SAR Measurement (1g)  
2.4 GHz: **0.454** W/kg  
5 GHz: **1.467** W/kg  
Application Type : Certification

The above equipment has been tested by DEKRA, and found compliance with the requirement of the above standards. The test record, data evaluation & Equipment Under Test (EUT) configurations represented herein are true and accurate accounts of the measurements of the sample's SAR characteristics under the conditions specified in this report.

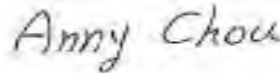
Documented By :   
( Senior Adm. Specialist / Anny Chou )

Tested By :   
( Senior Engineer / Vorana Chen )

Approved By :   
( Director / Vincent Lin )

## TABLE OF CONTENTS

Description	Page
<b>1. General Information .....</b>	<b>4</b>
1.1 EUT Description .....	4
1.2 Antenna List .....	4
1.3 SAR Test Exclusion Calculation .....	5
1.4 Test Environment .....	7
<b>2. SAR Measurement System .....</b>	<b>8</b>
2.1 DASY5 System Description .....	8
2.1.1 Applications .....	9
2.1.2 Area Scans .....	9
2.1.3 Zoom Scan (Cube Scan Averaging) .....	9
2.1.4 Uncertainty of Inter-/Extrapolation and Averaging .....	9
2.2 DASY5 E-Field Probe .....	10
2.2.1 Isotropic E-Field Probe Specification .....	10
2.3 Boundary Detection Unit and Probe Mounting Device .....	11
2.4 DATA Acquisition Electronics (DAE) and Measurement Server .....	11
2.5 Robot .....	12
2.6 Light Beam Unit .....	12
2.7 Device Holder .....	13
2.8 SAM Twin Phantom .....	13
<b>3. Tissue Simulating Liquid .....</b>	<b>14</b>
3.1 The composition of the tissue simulating liquid .....	14
3.2 Tissue Calibration Result .....	14
3.3 Tissue Dielectric Parameters for Head and Body Phantoms .....	16
<b>4. SAR Measurement Procedure .....</b>	<b>17</b>
4.1 SAR System Check .....	17
4.1.1 Dipoles .....	17
4.1.2 System Check Result .....	17
4.2 SAR Measurement Procedure .....	19
<b>5. SAR Exposure Limits .....</b>	<b>20</b>
<b>6. Test Equipment List .....</b>	<b>21</b>
<b>7. Measurement Uncertainty .....</b>	<b>23</b>
<b>8. Conducted Power Measurement (Including tolerance allowed for production unit) .....</b>	<b>25</b>
<b>9. Test Results .....</b>	<b>27</b>
9.1 SAR Test Results Summary .....	27
9.2 Simultaneous Transmission .....	29
9.2.1 Simultaneous transmission of MIMO in 802.11 Wi-Fi configurations .....	29
9.2.2 simultaneous transmission of Wi-Fi and other wireless technologies .....	30
<b>10. SAR measurement variability .....</b>	<b>31</b>
Appendix .....	32
Appendix A. SAR System Check Data	
Appendix B. SAR measurement Data	
Appendix C. Test Setup Photographs & EUT Photographs	
Appendix D. Probe Calibration Data	
Appendix E. Dipole Calibration Data	

## 1. General Information

### 1.1 EUT Description

Product Name	Mobile Tablet				
Trade Name	DT Research, Inc.				
Model No.	DT317BT				
FCC ID	YE3800H				
Frequency Range	802.11b/g/n-20: 2412-2462MHz, 802.11n-40MHz: 2422-2452MHz 802.11a/n-20MHz: 5180-5320MHz, 5745-5825MHz 802.11n-40MHz: 5190-5310, 5755-5795MHz				
Number of Channels	802.11b/g/n-20MHz: 11, n-40MHz: 7 802.11a/n-20MHz: 13; 802.11n-40MHz: 6				
Data Speed	802.11b: 1-11Mbps, 802.11a/g: 6-54Mbps, 802.11n: up to 300Mbps				
Type of Modulation	802.11b:DSSS (DBPSK, DQPSK, CCK) 802.11g/n: OFDM (BPSK, QPSK, 16QAM, 64QAM)				
Antenna Type	PCB Antenna				
Antenna Gain	Refer to the table "Antenna List"				
Channel Control	Auto				
Summary of test result –Reported 1g SAR (W/Kg)					
Test configuration	DTS(Main)	DTS(Aux)	U-NII(Main)	U-NII(Aux)	DTS(BT)
Body-Standalone	0.454	0.267	1.467	1.080	0.20
Body-Simultaneous	DTS (Main + Aux)		U-NII (Main + Aux)		DTS (UNII + BT)
	0.721		2.547 (SPLSR=0.036 )		1.667 (SPLSR=0.019 )
When BT and WIFI transmitter does simultaneously transmitter, WIFI will transmit on Main and BT will transmit on Aux					

### 1.2 Antenna List

No.	Manufacturer	Part No.	Antenna Type	Peak Gain
1	CHENGYU ELECTRIC Co.,LTD	PA0121(Main), PA0122(Aux)	PCB Antenna	2.02 dBi For 2.4GHz 3.05 dBi For 5.15~5.25GHz 3.05 dBi For 5.25~5.35GHz 3.03 dBi For 5.725~5.825GHz

### 1.3 SAR Test Exclusion Calculation

According to KDB Publication 447498 D01, section 4.3.1, per the calculations of item 1 (Power(mW)/separation (mm)\*sqrt(f(GHz)≤3.0), SAR is required as shown in the table below where calculated values are greater than 3.0 :

#### SAR exclusion calculations for WiFi-SISO and Bluetooth for antenna < 50mm from the user :

Antenna	Tx	Frequency (MHz)	Output Power		Separation distances (mm)					Calculated Threshold Value (≤3.0 SAR is not required)				
			dBm	mW	Back	Right	Left	Top	Bottom	Back	Right	Left	Top	Bottom
Main	WiFi	2462	15.50	35	9	48	130	120	2	6.2	1.2	>50mm	>50mm	11.1
Main	WiFi	5240	16.00	40	9	48	130	120	2	10.1	1.9	>50mm	>50mm	18.2
Main	WiFi	5320	16.00	40	9	48	130	120	2	10.2	1.9	>50mm	>50mm	18.4
Main	WiFi	5825	16.00	40	9	48	130	120	2	10.7	2.0	>50mm	>50mm	19.2
Main	WiFi	2462	15.50	35	9	48	130	120	2	6.2	1.2	>50mm	>50mm	11.1

#### SAR exclusion calculations for WiFi-SISO and Bluetooth for antenna > 50mm from the user :

Antenna	Tx	Frequency (MHz)	Output Power		Separation distances (mm)					Calculated Threshold Value (SAR test exclusion power,mW)				
			dBm	mW	Back	Right	Left	Top	Bottom	Back	Right	Left	Top	Bottom
Main	WiFi	2462	15.50	35	9	48	130	120	2	<50mm	<50mm	895.6	795.6	<50mm
Main	WiFi	5240	16.00	40	9	48	130	120	2	<50mm	<50mm	865.5	765.5	<50mm
Main	WiFi	5320	16.00	40	9	48	130	120	2	<50mm	<50mm	865.0	765.0	<50mm
Main	WiFi	5825	16.00	40	9	48	130	120	2	<50mm	<50mm	862.2	762.2	<50mm
Main	WiFi	2462	15.50	35	9	48	130	120	2	<50mm	<50mm	895.6	795.6	<50mm

**SAR exclusion calculations for WiFi-SISO and Bluetooth for antenna < 50mm from the user :**

Antenna	Tx	Frequency (MHz)	Output Power		Separation distances (mm)					Calculated Threshold Value ( $\leq 3.0$ SAR is not required)				
			dBm	mW	Back	Right	Left	Top	Bottom	Back	Right	Left	Top	Bottom
Aux	WiFi	2462	15.50	35	9	4	140	3	123	6.2	11.1	>50mm	11.1	>50mm
Aux	WiFi	5240	16.00	40	9	4	140	3	123	10.1	18.2	>50mm	18.2	>50mm
Aux	WiFi	5320	16.00	40	9	4	140	3	123	10.2	18.4	>50mm	18.4	>50mm
Aux	WiFi	5825	16.00	40	9	4	140	3	123	10.7	19.2	>50mm	19.2	>50mm
Aux	WiFi	2462	15.50	35	9	4	140	3	123	6.2	11.1	>50mm	11.1	>50mm
Aux	BT	2480	3.00	2	9	4	140	3	123	<b>0.3</b>	<b>0.6</b>	>50mm	<b>0.6</b>	>50mm

**SAR exclusion calculations for WiFi-SISO and Bluetooth for antenna > 50mm from the user :**

Antenna	Tx	Frequency (MHz)	Output Power		Separation distances (mm)					Calculated Threshold Value (SAR test exclusion power,mW)				
			dBm	mW	Back	Right	Left	Top	Bottom	Back	Right	Left	Top	Bottom
Aux	WiFi	2462	15.50	35	9	4	140	3	123	<50mm	<50mm	995.6	<50mm	825.6
Aux	WiFi	5240	16.00	40	9	4	140	3	123	<50mm	<50mm	965.5	<50mm	795.5
Aux	WiFi	5320	16.00	40	9	4	140	3	123	<50mm	<50mm	965.0	<50mm	795.0
Aux	WiFi	5825	16.00	40	9	4	140	3	123	<50mm	<50mm	962.2	<50mm	792.2
Aux	WiFi	2462	15.50	35	9	4	140	3	123	<50mm	<50mm	995.6	<50mm	825.6
Aux	BT	2480	3.00	2	9	4	140	3	123	<50mm	<50mm	995.3	<50mm	825.3

## 1.4 Test Environment

Ambient conditions in the laboratory:

Test Date: Feb. 02, 2017

Items	Required	Actual
Temperature (°C)	18-25	21.9± 2
Humidity (%RH)	30-70	53

Test Date: Feb. 03, 2017

Items	Required	Actual
Temperature (°C)	18-25	21.6± 2
Humidity (%RH)	30-70	52

Site Description:

Accredited by TAF

Accredited Number: 3023

Effective through: December 12, 2017

Site Name: DEKRA Testing and Certification Co., Ltd

Site Address: No.5-22, Ruishukeng, Linkou Dist., New Taipei City 24451,  
Taiwan, R.O.C.

TEL : 886-2-8601-3788 / FAX : 886-2-8601-3789

E-Mail : info.tw@dekra.com

## 2. SAR Measurement System

### 2.1 DASY5 System Description

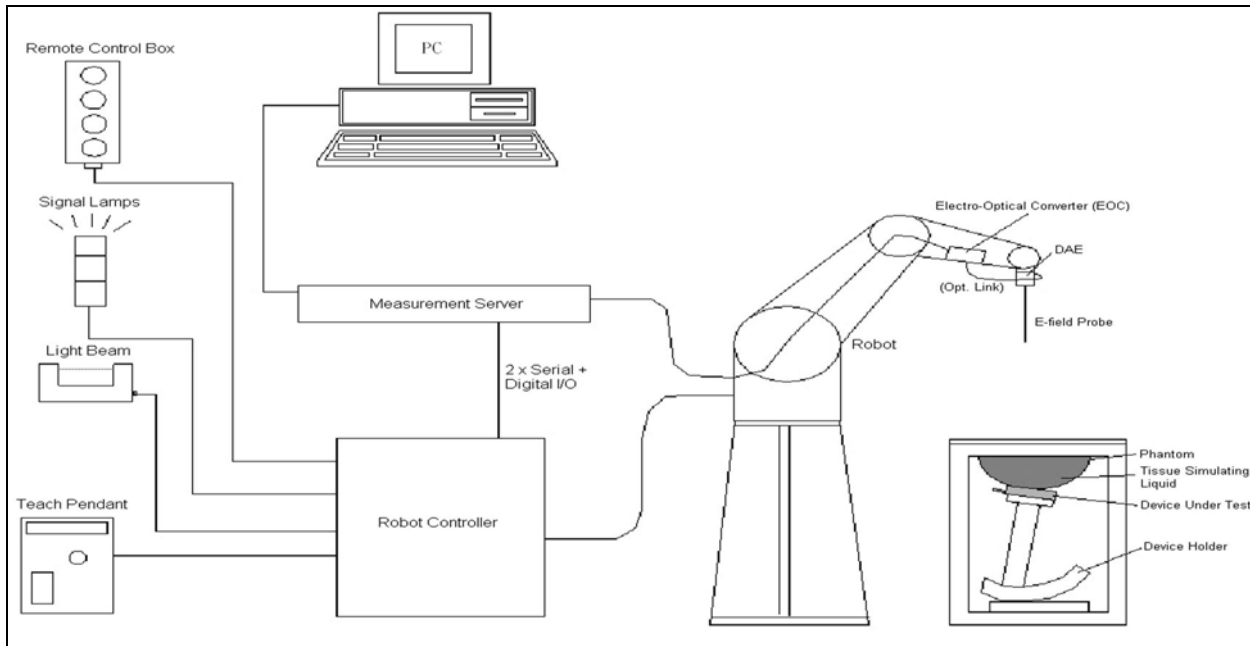

The DASY5 system for performing compliance tests consists of the following items:

- A standard high precision 6-axis robot with controller, teach pendant and software. An arm extension for accommodating the data acquisition electronics (DAE).
- A data acquisition electronics (DAE) which performs the signal amplification, signal multiplexing, AD-conversion, offset measurements, mechanical surface detection, collision detection, etc. The unit is battery powered with standard or rechargeable batteries. The signal is optically transmitted to the EOC.
- The Electro-optical converter (EOC) performs the conversion from optical to electrical signals for the digital communication to the DAE. To use optical surface detection, a special version of the EOC is required. The EOC signal is transmitted to the measurement server.
- The Light Beam used is for probe alignment. This improves the (absolute) accuracy of the probe positioning.
- A computer running WinXP and the DASY5 software.
- Remote control and teach pendant as well as additional circuitry for robot safety such as warning lamps, etc.
- The phantom, the device holder and other accessories according to the targeted measurement.



### **2.1.1 Applications**

Predefined procedures and evaluations for automated compliance testing with all worldwide standards, e.g., IEEE 1528, OET 65, IEC 62209-1, IEC 62209-2, EN 50360, EN 50383 and others.

### **2.1.2 Area Scans**

Area scans are defined prior to the measurement process being executed with a user defined variable spacing between each measurement point (integral) allowing low uncertainty measurements to be conducted. Scans defined for FCC applications utilize a 10mm<sup>2</sup> step integral, with 1mm interpolation used to locate the peak SAR area used for zoom scan assessments.

When an Area Scan has measured all reachable points, it computes the field maxima found in the scanned area, within a range of the global maximum. The range (in dB) is specified in the standards for compliance testing. For example, a 2 dB range is required in IEEE 1528-2013, EN 50361 and IEC 62209 standards, whereby 3 dB is a requirement when compliance is assessed in accordance with the ARIB standard (Japan).

### **2.1.3 Zoom Scan (Cube Scan Averaging)**

Zoom Scans are used to assess the peak spatial SAR values within a cubic averaging volume containing 1 g and 10 g of simulated tissue. A density of 1000 kg/m<sup>3</sup> is used to represent the head and body tissue density and not the phantom liquid density, in order to be consistent with the definition of the liquid dielectric properties, i.e. the side length of the 1 g cube is 10mm, with the side length of the 10 g cube 21,5mm.

The zoom scan integer steps can be user defined so as to reduce uncertainty, but normal practice for typical test applications (including FCC) utilize a physical step of 5x5x7 (8mmx8mmx5mm) providing a volume of 32mm in the X & Y axis, and 30mm in the Z axis.

### **2.1.4 Uncertainty of Inter-/Extrapolation and Averaging**

In order to evaluate the uncertainty of the interpolation, extrapolation and averaged SAR calculation algorithms of the Postprocessor, DASY5 allows the generation of measurement grids which are artificially predefined by analytically based test functions. Therefore, the grids of area scans and zoom scans can be filled with uncertainty test data, according to the SAR benchmark functions of IEEE 1528. The three analytical functions shown in equations as below are used to describe the possible range of the expected SAR distributions for the tested handsets. The field gradients are covered by the spatially flat

distribution f1, the spatially steep distribution f3 and f2 accounts for H-field cancellation on the phantom/tissue surface.

$$f_1(x, y, z) = Ae^{-\frac{z}{2a}} \cos^2 \left( \frac{\pi \sqrt{x'^2 + y'^2}}{2 \cdot 5a} \right)$$

$$f_2(x, y, z) = Ae^{-\frac{z}{a}} \frac{a^2}{a^2 + x'^2} \left( 3 - e^{-\frac{2z}{a}} \right) \cos^2 \left( \frac{\pi y'}{2 \cdot 3a} \right)$$

$$f_3(x, y, z) = A \frac{a^2}{\frac{a^2}{4} + x'^2 + y'^2} \left( e^{-\frac{2z}{a}} + \frac{a^2}{2(a + 2z)^2} \right)$$

### 2.2 DASY5 E-Field Probe

The SAR measurement is conducted with the dosimetric probe manufactured by SPEAG. The probe is specially designed and calibrated for use in liquid with high permittivity. The dosimetric probe has special calibration in liquid at different frequency. SPEAG conducts the probe calibration in compliance with international and national standards (e.g. IEEE 1528, EN 62209-1, IEC 62209, etc.) under ISO 17025. The calibration data are in Appendix D.

#### 2.2.1 Isotropic E-Field Probe Specification

<b>Model</b>	Ex3DV4	
<b>Construction</b>	Symmetrical design with triangular core Built-in shielding against static charges PEEK enclosure material (resistant to organic solvents, e.g., DGBE)	
<b>Frequency</b>	10 MHz to 6 GHz Linearity: ± 0.2 dB (30 MHz to 6 GHz)	
<b>Directivity</b>	± 0.3 dB in HSL (rotation around probe axis) ± 0.5 dB in tissue material (rotation normal to probe axis)	
<b>Dynamic Range</b>	10 µW/g to 100 mW/g Linearity: ± 0.2 dB (noise: typically < 1 µW/g)	
<b>Dimensions</b>	Overall length: 330 mm (Tip: 20 mm) Tip diameter: 2.5 mm (Body: 12 mm) Typical distance from probe tip to dipole centers: 1 mm	
<b>Application</b>	High precision dosimetric measurements in any exposure scenario (e.g., very strong gradient fields). Only probe which enables compliance testing for frequencies up to 6 GHz with precision of better 30%.	

### 2.3 Boundary Detection Unit and Probe Mounting Device

The DASY probes use a precise connector and an additional holder for the probe, consisting of a plastic tube and a flexible silicon ring to center the probe. The connector at the DAE is flexibly mounted and held in the default position with magnets and springs. Two switching systems in the connector mount detect frontal and lateral probe collisions and trigger the necessary software response.



### 2.4 DATA Acquisition Electronics (DAE) and Measurement Server

The data acquisition electronics (DAE) consists of a highly sensitive electrometer-grade preamplifier with auto-zeroing, a channel and gain-switching multiplexer, a fast 16 bit AD-converter and a command decoder and control logic unit.

Transmission to the measurement server is accomplished through an optical downlink for data and status information as well as an optical uplink for commands and the clock.

The input impedance of the DAE4 is 200M Ohm; the inputs are symmetrical and floating. Common mode rejection is above 80dB.



The DASY5 measurement server is based on a PC/104 CPU board with a 400MHz intel ULV Celeron, 128MB chipdisk and 128MB RAM. The necessary circuits for communication with the DAE electronics box, as well as the 16 bit AD converter system for optical detection and digital I/O interface are contained on the DASY5 I/O board, which is directly connected to the PC/104 bus of the CPU board.



## 2.5 Robot

The DASY5 system uses the high precision robots TX90 XL type out of the newer series from Stäubli SA (France). For the 6-axis controller DASY5 system, the CS8C robot controller version from Stäubli is used.

The XL robot series have many features that are important for our application:

- High precision (repeatability 0.02 mm)
- High reliability (industrial design)
- Jerk-free straight movements
- Low ELF interference (the closed metallic construction shields against motor control fields)
- 6-axis controller



## 2.6 Light Beam Unit

The light beam switch allows automatic "tooling" of the probe. During the process, the actual position of the probe tip with respect to the robot arm is measured, as well as the probe length and the horizontal probe offset. The software then corrects all movements, such that the robot coordinates are valid for the probe tip.

The repeatability of this process is better than 0.1 mm. If a position has been taught with an aligned probe, the same position will be reached with another aligned probe within 0.1 mm, even if the other probe has different dimensions. During probe rotations, the probe tip will keep its actual position.



## 2.7 Device Holder

The DASY5 device holder is designed to cope with different positions given in the standard. It has two scales for the device rotation (with respect to the body axis) and the device inclination (with respect to the line between the ear reference points). The rotation center for both scales is the ear reference point (EPR).

Thus the device needs no repositioning when changing the angles.

The DASY5 device holder has been made out of low-loss POM material having the following dielectric parameters: relative permittivity  $\epsilon_r = 3$  and loss tangent  $\delta = 0.02$ . The amount of dielectric material has been reduced in the closest vicinity of the device, since measurements have suggested that the influence of the clamp on the test results could thus be lowered.



## 2.8 SAM Twin Phantom

The SAM twin phantom is a fiberglass shell phantom with 2mm shell thickness (except the ear region where shell thickness increases to 6mm). It has three measurement areas:

- Left head
- Right head
- Flat phantom



The bottom plate contains three pair of bolts for locking the device holder. The device holder positions are adjusted to the standard measurement positions in the three sections. A white cover is provided to tap the phantom during off-periods to prevent water evaporation and changes in the liquid parameters. On the phantom top, three reference markers are provided to identify the phantom position with respect to the robot.

### 3. Tissue Simulating Liquid

#### 3.1 The composition of the tissue simulating liquid

INGREDIENT (% Weight)	2450MHz Body	5200MHz Body	5800MHz Body
<b>Water</b>	73.2	76	75.68
<b>Salt</b>	0.04	0.00	0.00
<b>Sugar</b>	0	0.00	0.00
<b>HEC</b>	0	0.00	0.00
<b>Preventol</b>	0	0.00	0.00
<b>DGBE</b>	26.76	4.44	4.42
<b>Triton X-100</b>	0	19.56	19.47

#### 3.2 Tissue Calibration Result

The dielectric parameters of the liquids were verified prior to the SAR evaluation using APREL Dielectric Probe Kit and Agilent E5071C Vector Network Analyzer.

Body Tissue Simulate Measurement				
Frequency [MHz]	Description	Dielectric Parameters		Tissue Temp. [°C]
		$\epsilon_r$	$\sigma$ [s/m]	
2450MHz	Reference result ± 5% window	52.7 50.065 to 55.335	1.95 1.8525 to 2.0475	N/A
	03-Feb-17	52.51	1.99	20.2
2412 MHz	Channel 1	52.65	1.93	20.2

Body Tissue Simulate Measurement				
Frequency [MHz]	Description	Dielectric Parameters		Tissue Temp. [°C]
		$\epsilon_r$	$\sigma$ [s/m]	
5200MHz	Reference result ± 5% window	49 46.55 to 51.45	5.3 5.03 to 5.56	N/A
	02-Feb-17	49.12	5.24	20.5
5180 MHz	Low channel	49.18	5.21	20.5
5220 MHz	Mid channel	49.07	5.27	20.5
5240 MHz	High channel	49.01	5.30	20.5

<b>Body Tissue Simulate Measurement</b>				
Frequency [MHz]	Description	Dielectric Parameters		Tissue Temp. [°C]
		$\epsilon_r$	$\sigma$ [s/m]	
5300MHz	Reference result ± 5% window	48.9 46.45 to 51.34	5.42 5.15 to 5.69	N/A
	02-Feb-17	48.85	5.39	20.5
5260 MHz	Low channel	48.96	5.33	20.5
5300 MHz	Mid channel	48.85	5.39	20.5
5320 MHz	High channel	48.81	5.42	20.5

<b>Body Tissue Simulate Measurement</b>				
Frequency [MHz]	Description	Dielectric Parameters		Tissue Temp. [°C]
		$\epsilon_r$	$\sigma$ [s/m]	
5800MHz	Reference result ± 5% window	48.2 45.79 to 50.61	6 5.7 to 6.3	N/A
	02-Feb-17	47.53	6.15	20.5
5745 MHz	Low channel	47.67	6.06	20.5
5785 MHz	Mid channel	47.57	6.13	20.5
5825 MHz	High channel	47.48	6.19	20.5

### 3.3 Tissue Dielectric Parameters for Head and Body Phantoms

The head tissue dielectric parameters recommended by the IEEE SCC-34/SC-2 in P1528 have been incorporated in the following table. These head parameters are derived from planar layer models simulating the highest expected SAR for the dielectric properties and tissue thickness variations in a human head. Other head and body tissue parameters that have not been specified in P1528 are derived from the tissue dielectric parameters computed from the 4-Cole-Cole equations described in Reference [12] and extrapolated according to the head parameters specified in P1528.

Target Frequency (MHz)	Head		Body	
	$\epsilon_r$	$\sigma$ (S/m)	$\epsilon_r$	$\sigma$ (S/m)
150	52.3	0.76	61.9	0.80
300	45.3	0.87	58.2	0.92
450	43.5	0.87	56.7	0.94
835	41.5	0.90	55.2	0.97
900	41.5	0.97	55.0	1.05
915	41.5	0.98	55.0	1.06
1450	40.5	1.20	54.0	1.30
1610	40.3	1.29	53.8	1.40
1800 – 2000	40.0	1.40	53.3	1.52
2450	39.2	1.80	52.7	1.95
3000	38.5	2.40	52.0	2.73
5800	35.3	5.27	48.2	6.00

( $\epsilon_r$  = relative permittivity,  $\sigma$  = conductivity and  $\rho = 1000 \text{ kg/m}^3$ )



## 4. SAR Measurement Procedure

### 4.1 SAR System Check

#### 4.1.1 Dipoles

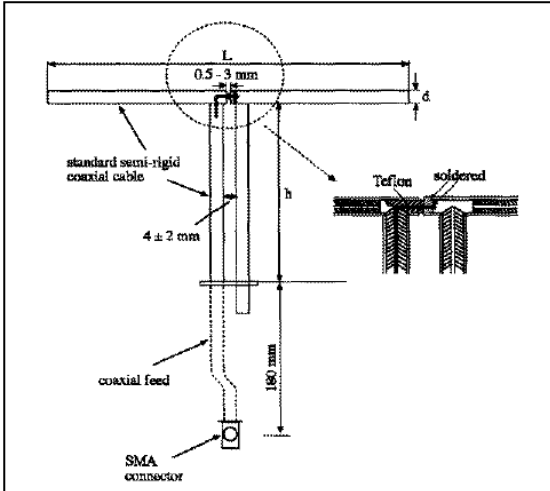

The dipoles used is based on the IEEE-1528 standard, and is complied with mechanical and electrical specifications in line with the requirements of both IEEE and FCC Supplement C. the table below provides details for the mechanical and electrical specifications for the dipoles.

Frequency	L (mm)	h (mm)	d (mm)
2450MHz	53.5	30.4	3.6
5200M~5800MHz	20.6	45.4	3.6

#### 4.1.2 System Check Result

System Performance Check at 2450MHz				
Dipole Kit: D2450V2				
Frequency [MHz]	Description	SAR [w/kg] 1g	SAR [w/kg] 10g	Tissue Temp. [°C]
2450 MHz	Reference result	51.8	24.00	N/A
	± 10% window	46.62 to 56.98	21.6 to 26.4	
	03-Feb-17	50	23.6	20.2

Note: (1) The power level is used 100mW  
 (2) All SAR values are normalized to 1W forward power.  
 (3) The reference result is from Appendix E.

**System Performance Check at 5200MHz**
**Dipole Kit: D5GHzV2**

Frequency [MHz]	Description	SAR [w/kg] 1g	SAR [w/kg] 10g	Tissue Temp. [°C]
5200 MHz	Reference result ± 10% window	73.8 66.42 to 81.18	20.6 18.54 to 22.66	N/A
	02-Feb-17	73.9	21.3	20.5

Note: (1) The power level is used 100mW  
 (4) All SAR values are normalized to 1W forward power.  
 (5) The reference result is from Appendix E.

**System Performance Check at 5300MHz**
**Dipole Kit: D5GHzV2**

Frequency [MHz]	Description	SAR [w/kg] 1g	SAR [w/kg] 10g	Tissue Temp. [°C]
5300 MHz	Reference result ± 10% window	73.9 66.51 to 81.29	20.6 18.54 to 22.66	N/A
	02-Feb-17	75.9	20.3	20.5

Note: (1) The power level is used 100mW  
 (6) All SAR values are normalized to 1W forward power.  
 (7) The reference result is from Appendix E.

**System Performance Check at 5800MHz**
**Dipole Kit: D5GHzV2**

Frequency [MHz]	Description	SAR [w/kg] 1g	SAR [w/kg] 10g	Tissue Temp. [°C]
5800 MHz	Reference result ± 10% window	76.7 69.03 to 84.37	21.2 19.08 to 23.32	N/A
	02-Feb-17	76.1	21.7	20.5

Note: (1) The power level is used 100mW  
 (2) All SAR values are normalized to 1W forward power.  
 (3) The reference result is from Appendix E.

## 4.2 SAR Measurement Procedure

The Dasy5 calculates SAR using the following equation,

$$SAR = \frac{\sigma |E|^2}{\rho}$$

$\sigma$ : represents the simulated tissue conductivity

$\rho$ : represents the tissue density

The EUT is set to transmit at the required power in line with product specification, at each frequency relating to the LOW, MID, and HIGH channel settings.

Pre-scans are made on the device to establish the location for the transmitting antenna, using a large area scan in either air or tissue simulation fluid.

The EUT is placed against the Universal Phantom where the maximum area scan dimensions are larger than the physical size of the resonating antenna. When the scan size is not large enough to cover the peak SAR distribution, it is modified by either extending the area scan size in both the X and Y directions, or the device is shifted within the predefined area.

The area scan is then run to establish the peak SAR location (interpolated resolution set at  $1\text{mm}^2$ ) which is then used to orient the center of the zoom scan. The zoom scan is then executed and the 1g and 10g averages are derived from the zoom scan volume (interpolated resolution set at  $1\text{mm}^3$ ).

## 5. SAR Exposure Limits

SAR assessments have been made in line with the requirements of IEEE-1528, FCC Supplement C, and comply with ANSI/IEEE C95.1-1992 “Uncontrolled Environments” limits. These limits apply to a location which is deemed as “Uncontrolled Environment” which can be described as a situation where the general public may be exposed to an RF source with no prior knowledge or control over their exposure.

### Limits for General Population/Uncontrolled Exposure (W/kg)

Type Exposure	Uncontrolled Environment Limit
Spatial Peak SAR (1g cube tissue for brain or body)	1.60 W/kg
Spatial Average SAR (whole body)	0.08 W/kg
Spatial Peak SAR (10g for hands, feet, ankles and wrist)	4.00 W/kg

## 6. Test Equipment List

Instrument	Manufacturer	Model No.	Serial No.	Last Calibration	Next Calibration
Stäubli Robot TX60L	Stäubli	TX60L	F09/5BL1A1/A06	2009/05/18	only once
Controller	Speag	CS8c	N/A	2009/05/18	only once
Speag Reference Dipole 2450MHz	Speag	D2450V2	930	2016/11/15	2018/11/14
Speag Reference Dipole 5GHz	Speag	D5GHzV2	1041	2015/05/22	2017/05/21
SAM Twin Phantom	Speag	QD000 P40 CA	Tp 1515	N/A	N/A
Device Holder	Speag	N/A	N/A	N/A	N/A
Data Acquisition Electronic	Speag	DAE4	1425	2016/11/18	2017/11/17
E-Field Probe	Speag	EX3DV4	3979	2016/11/25	2017/11/24
SAR Software	Speag	DASY52	V52.8 (8)	N/A	N/A
Aprel Dipole Spaccer	Aprel	ALS-DS-U	QTK-295	N/A	N/A
Power Amplifier	Mini-Circuit	ZHL-42	D051404-20	N/A	N/A
Directional Coupler	Agilent	778D-012	50550	N/A	N/A
Vector Network	Agilent	E5071C	MY46106342	2016/08/10	2017/08/08
Signal Generator	Anritsu	MG3694A	041902	2016/08/09	2017/08/07
Power Meter	Anritsu	ML2487A	6K00001447	2016/09/29	2017/09/27
Wide Bandwidth Sensor	Anritsu	MA2411B	1339194	2016/09/29	2017/09/27

Note:

Per KDB 865664 D01 requirements for dipole calibration, the following are recommended FCC procedures for SAR dipole calibration.

1. After a dipole is damaged and properly repaired to meet required specifications
2. When the measured SAR deviates from the calibrated SAR value by more than 10% due to changes in physical, mechanical, electrical or other relevant dipole conditions;
3. When the most recent return-loss, measured at least annually, deviates by more than 20% from the previous measurement (i.e. 0.2 of the dB value) or not meeting the required -20 dB return-loss specification

	Frequency	Tissue	Return loss	Limit	Verified Date
Calibration	5200	Body	-24.8dB	Within 20%	2016.05.25
Measurement	5200	Body	-27.18dB		

	Frequency	Tissue	Return loss	Limit	Verified Date
Calibration	5300	Body	-30.7dB	Within 20%	2016.05.25
Measurement	5300	Body	-26.87dB		

	Frequency	Tissue	Return loss	Limit	Verified Date
Calibration	5800	Body	-24.9dB	Within 20%	2016.05.25
Measurement	5800	Body	-24.12dB		

4. When the most recent measurement of the real or imaginary parts of the impedance, measured at least annually, deviates by more than 5 Ω from the previous measurement

	Frequency	Tissue	Impedance	Limit	Verified Date
Calibration	5200	Body	48.5	Within 5Ω	2016.05.25
Measurement	5200	Body	49.75		

	Frequency	Tissue	Impedance	Limit	Verified Date
Calibration	5300	Body	48.9	Within 5Ω	2016.05.25
Measurement	5300	Body	45.96		

	Frequency	Tissue	Impedance	Limit	Verified Date
Calibration	5800	Body	56	Within 5Ω	2016.05.25
Measurement	5800	Body	55		

## 7. Measurement Uncertainty

DASY5 Uncertainty (According to IEEE 1528-2013) Measurement uncertainty for 30 MHz to 3 GHz								
Error Description	Uncert. value	Prob. Dist.	Div.	(ci) 1g	(ci) 10g	Std. Unc. (1g)	Std. Unc. (10g)	(vi) V <sub>eff</sub>
<b>Measurement System</b>								
Probe Calibration	±6%	N	1	1	1	±6.0%	±6.0%	∞
Axial Isotropy	±4.7%	R	√3	0.7	0.7	±1.9%	±1.9%	∞
Hemispherical Isotropy	±9.6%	R	√3	0.7	0.7	±3.9%	±3.9%	∞
Boundary Effects	±1.0%	R	√3	1	1	±0.6%	±0.6%	∞
Linearity	±4.7%	R	√3	1	1	±2.7%	±2.7%	∞
System Detection Limits	±1.0%	R	√3	1	1	±0.6%	±0.6%	∞
Modulation Response	±2.4%	R	√3	1	1	±1.4%	±1.4%	∞
Readout Electronics	±0.3%	N	1	1	1	±0.3%	±0.3%	∞
Response Time	±0.8%	R	√3	1	1	±0.5%	±0.5%	∞
Integration Time	±2.6%	R	√3	1	1	±1.5%	±1.5%	∞
RF Ambient Noise	±3.0%	R	√3	1	1	±1.7%	±1.7%	∞
RF Ambient Reflections	±3.0%	R	√3	1	1	±1.7%	±1.7%	∞
Probe Positioner	±0.4%	R	√3	1	1	±0.2%	±0.2%	∞
Probe Positioning	±2.9%	R	√3	1	1	±1.7%	±1.7%	∞
Max. SAR Eval.	±4.0%	R	√3	1	1	±1.2%	±1.2%	∞
<b>Test Sample Related</b>								
Device Positioning	±2.9%	N	1	1	1	±2.9%	±2.9%	145
Device Holder	±3.6%	N	1	1	1	±3.6%	±3.6%	5
Power Drift	±5.0%	R	√3	1	1	±2.9%	±2.9%	∞
Power Scaling	±0%	R	√3	1	1	±0.0%	±0.0%	
<b>Phantom and Setup</b>								
Phantom Uncertainty	±6.1%	R	√3	1	1	±3.5%	±3.5%	∞
SAR correction	±1.9%	R	√3	1	0.84	±1.1%	±0.9%	∞
Liquid Conductivity (meas.)	±2.5%	R	√3	0.78	0.71	±1.1%	±1.0%	∞
Liquid Permittivity (meas.)	±2.5%	R	√3	0.26	0.26	±0.3%	±0.4%	∞
Temp. unc. - Conductivity	±3.4%	R	√3	0.78	0.71	±1.5%	±1.4%	∞
Temp. unc. - Permittivity	±0.4%	R	√3	0.23	0.26	±0.1%	±0.1%	∞
<b>Combined Std. Uncertainty</b>						±11.2%	±11.1%	361
<b>Expanded STD Uncertainty</b>						±22.3%	±22.2%	

<b>DASY5 Uncertainty (According to IEEE 1528-2013)</b> <b>Measurement uncertainty for 3GHz to 6 GHz</b>								
Error Description	Uncert. value	Prob. Dist.	Div.	(ci) 1g	(ci) 10g	Std. Unc. (1g)	Std. Unc. (10g)	(vi) V <sub>eff</sub>
<b>Measurement System</b>								
Probe Calibration	±6.55%	N	1	1	1	±6.55%	±6.55%	∞
Axial Isotropy	±4.7%	R	√3	0.7	0.7	±1.9%	±1.9%	∞
Hemispherical Isotropy	±9.6%	R	√3	0.7	0.7	±3.9%	±3.9%	∞
Boundary Effects	±2.0%	R	√3	1	1	±1.2%	±1.2%	∞
Linearity	±4.7%	R	√3	1	1	±2.7%	±2.7%	∞
System Detection Limits	±1.0%	R	√3	1	1	±0.6%	±0.6%	∞
Modulation Response	±2.4%	R	√3	1	1	±1.4%	±1.4%	∞
Readout Electronics	±0.3%	N	1	1	1	±0.3%	±0.3%	∞
Response Time	±0.8%	R	√3	1	1	±0.5%	±0.5%	∞
Integration Time	±2.6%	R	√3	1	1	±1.5%	±1.5%	∞
RF Ambient Noise	±3.0%	R	√3	1	1	±1.7%	±1.7%	∞
RF Ambient Reflections	±3.0%	R	√3	1	1	±1.7%	±1.7%	∞
Probe Positioner	±0.8%	R	√3	1	1	±0.5%	±0.5%	∞
Probe Positioning	±6.7%	R	√3	1	1	±3.9%	±3.9%	∞
Post-processing	±4.0%	R	√3	1	1	±2.3%	±2.3%	∞
<b>Test Sample Related</b>								
Device Positioning	±2.9%	N	1	1	1	±2.9%	±2.9%	145
Device Holder	±3.6%	N	1	1	1	±3.6%	±3.6%	5
Power Drift	±5.0%	R	√3	1	1	±2.9%	±2.9%	∞
Power Scaling	±0%	R	√3	1	1	±0.0%	±0.0%	
<b>Phantom and Setup</b>								
Phantom Uncertainty	±6.6%	R	√3	1	1	±3.8%	±3.8%	∞
SAR correction	±1.9%	R	√3	1	1	±1.1%	±0.9%	∞
Liquid Conductivity (meas.)	±2.5%	R	√3	1	0.84	±1.1%	±1.0%	∞
Liquid Permittivity (meas.)	±2.5%	R	√3	0.26	0.26	±0.3%	±0.4%	∞
Temp. unc. - Conductivity	±3.4%	R	√3	0.78	0.71	±1.5%	±1.4%	∞
Temp. unc. - Permittivity	±0.4%	R	√3	0.23	0.26	±0.1%	±0.1%	∞
<b>Combined Std. Uncertainty</b>						±12.3%	±12.2%	748
<b>Expanded STD Uncertainty</b>						±24.6%	±24.5%	



**8. Conducted Power Measurement (Including tolerance allowed for production unit)**

SISO-Main																	
	Mode	BW	15.247			U-NII-1			U-NII-2A			U-NII-2C			U-NII-3		
			CH	Target	Power	CH	Target	Power	CH	Target	Power	CH	Target	Power	CH	Target	Power
DSSS/OFDM mode specified maximum output power at an antenna port	b	20	1	15.5	15.27												
			6	15.5	15.18												
			11	15.5	15.22												
	g	20	1	14.5	14.38												
			6	14.5	14.25												
			11	14.5	14.35												
	a	20				36	16	15.51	52	16	15.52				149	16	15.98
						40	16	15.13	56	16	15.20				157	16	15.95
						44	16	15.59	60	16	15.44				165	16	15.89
						48	16	15.54	64	16	15.39						
	n-20(HT)	20	1	13	12.21	36	14	13.92	52	14	13.24				149	14	13.85
			6	13	12.18	40	14	13.95	56	14	13.32				157	14	13.96
			11	13	12.33	44	14	13.94	60	14	13.41				165	14	13.22
						48	14	14	64	14	13.56						
	n-40(HT)	40	3	11	10.33	38	14	13.26	54	14	13.32				134	14	13.58
			6	11	10.45	46	14	13.18	62	14	13.54				142	14	13.62
9			11	10.48										151	14	13.79	
														159	14	13.96	

Note : According KDB 248227D01V02r01 ,When the same highest maximum output power is specified for multiple largest channel bandwidth configurations with the same lowest order modulation or lowest order modulation and lowest data rate, power measurement is required for all equivalent 802.11 configurations with the same maximum output power.

SISO-Aux																	
DSSS/OFDM mode specified maximum output power at an antenna port	Mode	BW	15.247			U-NII-1			U-NII-2A			U-NII-2C			U-NII-3		
			CH	Target	Power	CH	Target	Power	CH	Target	Power	CH	Target	Power	CH	Target	Power
	b	20	1	15.5	15.43												
6			15.5	15.29													
11			15	14.51													
g	20	1	14	13.67													
		6	14	13.69													
		11	14.5	14.22													
a	20				36	16	15.95	52	16	15.78				149	16	15.67	
					40	16	15.62	56	16	15.49				157	16	15.84	
					44	16	15.94	60	16	15.79				165	16	15.96	
					48	16	15.86	64	16	15.75							
n-20(HT)	20	1	13	12.73	36	14	13.49	52	14	13.51				149	14	13.64	
		6	13	12.62	40	14	13.41	56	14	13.39				157	14	13.82	
		11	13	12.53	44	14	13.4	60	14	13.58				165	14	13.91	
					48	14	13.45	64	14	13.51							
n-40(HT)	40	3	11	10.87	38	14	13.33	54	14	13.32				134	14	13.49	
		6	11	10.97	46	14	13.35	62	14	13.42				142	14	13.54	
		9	11	10.88										151	14	13.62	
														159	14	13.75	

Note : According KDB 248227D01V02r01 ,When the same highest maximum output power is specified for multiple largest channel bandwidth configurations with the same lowest order modulation or lowest order modulation and lowest data rate, power measurement is required for all equivalent 802.11 configurations with the same maximum output power.

## 9. Test Results

### 9.1 SAR Test Results Summary

SAR MEASUREMENT								
Ambient Temperature (°C) : 21.6 ±2					Relative Humidity (%) : 52			
Liquid Temperature (°C) : 20.2 ±2					Depth of Liquid (cm) : >15			
Test Mode: 802.11b - 2450 MHz – Main Antenna								
Test Position Body	Antenna Position	Frequency		Conducted Power (dBm)		SAR 1g (W/kg)		Limit (W/kg)
		Channel	MHz	Measurement	Tune-up Limit	Measurement	Tune-up Scaled	
Back	Fixed	1	2412	15.27	15.5	0.431	0.454	1.6
Bottom	Fixed	1	2412	15.27	15.5	0.155	0.163	1.6
Right-Side	Fixed	1	2412	15.27	15.5	0.079	0.083	1.6
Test Mode: 802.11b - 2450 MHz – Aux Antenna								
Back	Fixed	1	2412	15.43	15.5	0.175	0.178	1.6
Top	Fixed	1	2412	15.43	15.5	0.263	0.267	1.6
Right-Side	Fixed	1	2412	15.43	15.5	0.076	0.077	1.6
<p>Note : 1. When the highest reported SAR for DSSS is adjusted by the ratio of OFDM to DSSS specified maximum output power and the adjusted SAR is ≤ 1.2 W/kg, SAR is not required.</p> <p>2. When the reported SAR of the highest measured maximum output power channel for the exposure configuration is ≤ 0.8 W/kg, no further SAR testing is required for 802.11b DSSS in that exposure configuration.</p> <p>3. Duty Cycle=100%.</p>								

SAR MEASUREMENT								
Ambient Temperature (°C) : 22.3 ±2				Relative Humidity (%) : 52				
Liquid Temperature (°C) : 20.8 ±2				Depth of Liquid (cm):>15				
Test Position Body	Antenna Position	Frequency		Conducted Power (dBm)		SAR 1g (W/kg)		Limit (W/kg)
		Channel	MHz	Measurement	Tune-up Limit	Measurement	Tune-up Scaled	
Test Mode: 802.11a-5GHz – Main Antenna								
Back	Fixed	52	5260	15.52	16	0.419	0.468	1.6
Back	Fixed	149	5745	15.98	16	0.403	0.405	1.6
Bottom	Fixed	36	5180	15.51	16	1.150	1.287	1.6
Bottom	Fixed	44	5220	15.59	16	1.270	1.396	1.6
Bottom	Fixed	48	5240	15.54	16	1.320	1.467	1.6
Bottom	Fixed	52	5260	15.52	16	1.110	1.240	1.6
Bottom	Fixed	60	5300	15.44	16	1.030	1.172	1.6
Bottom	Fixed	64	5320	15.39	16	1.030	1.185	1.6
Bottom	Fixed	149	5745	15.98	16	1.130	1.135	1.6
Bottom	Fixed	157	5785	15.95	16	1.050	1.062	1.6
Bottom	Fixed	165	5825	15.89	16	1.020	1.046	1.6
Right-Side	Fixed	52	5260	15.52	16	0.118	0.132	1.6
Right-Side	Fixed	149	5745	15.98	16	0.064	0.064	1.6
Test Mode: 802.11a-5GHz – Aux Antenna								
Back	Fixed	60	5300	15.79	16	0.471	0.494	1.6
Back	Fixed	165	5825	15.96	16	0.649	0.655	1.6
Top	Fixed	36	5180	15.95	16	0.845	0.855	1.6
Top	Fixed	44	5220	15.94	16	0.743	0.753	1.6
Top	Fixed	48	5240	15.86	16	0.718	0.742	1.6
Top	Fixed	60	5300	15.79	16	0.676	0.709	1.6
Top	Fixed	149	5745	15.67	16	0.891	0.961	1.6
Top	Fixed	157	5785	15.84	16	0.960	0.996	1.6
Top	Fixed	165	5825	15.96	16	1.070	1.080	1.6
Right-Side	Fixed	60	5300	15.79	16	0.096	0.101	1.6
Right-Side	Fixed	165	5825	15.96	16	0.012	0.012	1.6
Note : 1. When multiple transmission modes (802.11 n) have the same specified maximum output power, largest channel bandwidth, lowest order modulation and lowest data rate, the lowest order 802.11 mode is selected 2. When the reported SAR of the highest measured maximum output power channel for the exposure configuration is ≤ 0.8 W/kg, no further SAR testing is required in that exposure configuration. 3. Duty Cycle=100%.								

## 9.2 Simultaneous Transmission

### 9.2.1 Simultaneous transmission of MIMO in 802.11 Wi-Fi configurations

Frequency (GHz)	Test Position (Body)	WLAN Main SAR (W/Kg)	WLAN Aux SAR W/Kg)	Simultaneous Transmission (W/Kg)	Antenna pair in mm	Peak location separation ratio
2.4	Back	0.454	0.178	0.632	N/A	N/A
2.4	Bottom/Top	0.163	0.267	0.430	N/A	N/A
2.4	Right	0.083	0.077	0.160	N/A	N/A
5	Back	0.468	0.655	1.123	N/A	N/A
5	Bottom/Top	1.467	1.080	2.547	112	0.036
5	Right	0.132	0.101	0.233	N/A	N/A

Note : (1) The sum of value is less than 1.6W/Kg or the ratio is determined by  $(SAR1 + SAR2)^{1.5}/R_i$ , rounded to two decimal digits, and must be  $\leq 0.04$  for all antenna pairs in the configuration to qualify for SAR test exclusion.

**9.2.2 simultaneous transmission of Wi-Fi and other wireless technologies**

According the FCC: KDB 447498 D01 Section 4.3.2, IC: Notice 2016-DRS001, the standalone SAR must be estimated according to the following to determine simultaneous transmission SAR test exclusion

**FCC: KDB 447498 D01 Section 4.3.2**

$$(max. power of channel, mW)/(min. test separation distance, mm) \cdot [\sqrt{f(GHz)}/7.5]$$

**IC: Notice 2016-DRS001**

$$\frac{\text{maximum power level including tune-up tolerance for transmitter A}}{\text{maximum power level of exemption at the same frequency and distance}} \times 0.4 W/kg$$

Standard	Mode	Frequency	Max. power (mW)	Test separation distance ,(mm)	Estimated SAR (W/Kg)
FCC	BT	2441	2	5	0.08
IC	BT	2441	2	5	0.20

Note : A test separation distance of 5 mm must be applied to determine test exclusion according to the SAR Test Exclusion Threshold requirements

When the sum of SAR is larger than the limit, The ratio is determined by  $(SAR1 + SAR2)^{1.5/Ri}$ , rounded to two decimal digits, and must be  $\leq 0.04$  for all antenna pairs in the configuration to qualify for 1-g SAR test exclusion. The estimation result as below:

**For DTS Band :**

Mode	WLAN SAR (W/Kg)	BT SAR (W/Kg)	Simultaneous Transmission (W/Kg)	Antenna pair in mm	Peak location separation ratio
Bottom/Top	0.454	0.20	0.654	N/A	N/A

The sum of value is less than 1.6W/Kg, thus simultaneous SAR testing is not needed.

**For NII Band :**

Mode	WLAN SAR (W/Kg)	BT SAR (W/Kg)	Simultaneous Transmission (W/Kg)	Antenna pair in mm	Peak location separation ratio
Bottom/Top	1.467	0.20	1.667	112	0.019

The sum of value is less than 1.6W/Kg, thus simultaneous SAR testing is not needed.

## 10. SAR measurement variability

- 1) Repeated measurement is not required when the original highest measured SAR is  $< 0.80$  W/kg; steps 2) through 4) do not apply.
- 2) When the original highest measured SAR is  $\geq 0.80$  W/kg, repeat that measurement once.
- 3) Perform a second repeated measurement only if the ratio of largest to smallest SAR for the original and first repeated measurements is  $> 1.20$  or when the original or repeated measurement is  $\geq 1.45$  W/kg (~ 10% from the 1-g SAR limit).
- 4) Perform a third repeated measurement only if the original, first or second repeated measurement is  $\geq 1.5$  W/kg and the ratio of largest to smallest SAR for the original, first and second repeated measurements is  $> 1.20$ .

Frequency		SAR 1g (W/kg)						
Channel	MHz	Original	First Repeated		Second Repeated		Third Repeated	
			Value	Ratio	Value	Ratio	Value	Ratio
1	2412	0.431	N/A	N/A	N/A	N/A	N/A	N/A
48	5240	1.320	1.230	1.07	N/A	N/A	N/A	N/A

---

**Appendix**

**Appendix A. SAR System Check Data**

**Appendix B. SAR measurement Data**

**Appendix C. Test Setup Photographs & EUT Photographs**

**Appendix D. Probe Calibration Data**

**Appendix E. Dipole Calibration Data**



## Appendix A. SAR System Check Data

Test Laboratory: DEKRA

Date/Time: 2017/02/03

### System Performance Check\_2450MHz-Body

#### DUT: Dipole 2450 MHz; Type: D2450V2

Communication System: UID 0, CW; Frequency: 2450 MHz;

Communication System PAR: 0 dB

Medium parameters used:  $f = 2450$  MHz;  $\sigma = 1.99$  S/m;  $\epsilon_r = 52.51$ ;  $\rho = 1000$  kg/m<sup>3</sup>

Phantom section: Flat Section

Ambient Temperature (°C) : 21.6, Liquid Temperature (°C) : 20.2

Measurement Standard: DASY5 (IEEE/IEC/ANSI C63.19-2011)

DASY5 Configuration:

- Probe: EX3DV4 - SN3979; ConvF(7.47, 7.47, 7.47); Calibrated: 2016/11/25;
- Sensor-Surface: 4mm (Mechanical Surface Detection)
- Electronics: DAE4 Sn1425; Calibrated: 2016/11/18
- Phantom: SAM with left table; Type: SAM;
- Measurement SW: DASY52, Version 52.8 (8); SEMCAD X Version 14.6.10 (7373)

**Configuration/2450MHz Body/Area Scan (9x9x1):** Measurement grid: dx=12mm, dy=12mm

Maximum value of SAR (measured) = 13.0 W/kg

### Configuration/2450MHz Body/Zoom Scan (7x7x7) (7x7x7)/Cube 0:

Measurement grid: dx=5mm, dy=5mm, dz=5mm

Reference Value = 81.55 V/m; Power Drift = -0.11 dB

Peak SAR (extrapolated) = 25.5 W/kg

**SAR(1 g) = 12.5 W/kg; SAR(10 g) = 5.9 W/kg**

Maximum value of SAR (measured) = 13.4 W/kg

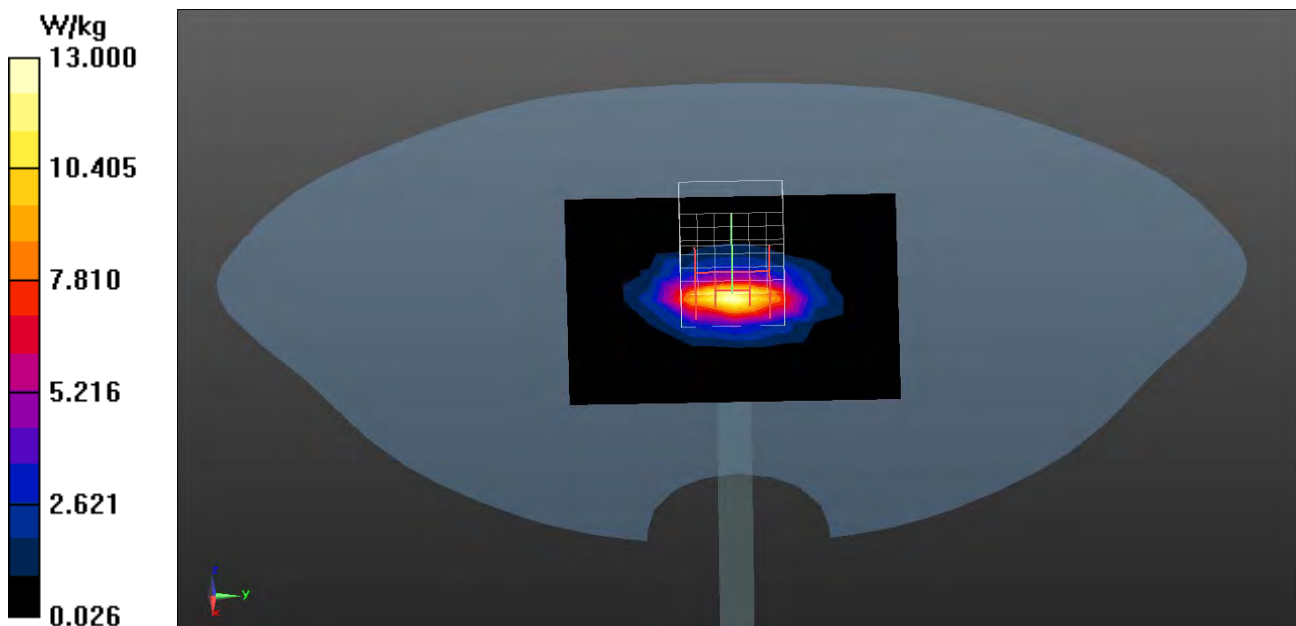

Test Laboratory: DEKRA

Date/Time: 2017/02/02

**System Performance Check\_5200MHz-Body****DUT: Dipole 5GHz; Type: D5GHzV2**

Communication System: UID 0, CW; Frequency: 5200 MHz;

Communication System PAR: 0 dB

Medium parameters used:  $f = 5200$  MHz;  $\sigma = 5.24$  S/m;  $\epsilon_r = 49.12$ ;  $\rho = 1000$  kg/m<sup>3</sup>

Phantom section: Flat Section

Ambient Temperature (°C) : 21.9, Liquid Temperature (°C) : 20.5

Measurement Standard: DASYS (IEEE/IEC/ANSI C63.19-2011)

DASY5 Configuration:

- Probe: EX3DV4 - SN3979; ConvF(4.75, 4.75, 4.75); Calibrated: 2016/11/25;
- Sensor-Surface: 1.4mm (Mechanical Surface Detection)
- Electronics: DAE4 Sn1425; Calibrated: 2016/11/18
- Phantom: SAM with right table; Type: SAM;
- Measurement SW: DASY52, Version 52.8 (8); SEMCAD X Version 14.6.10 (7373)

**Configuration/5200MHz-Body/Area Scan (8x8x1):** Measurement grid: dx=10mm, dy=10mm

Maximum value of SAR (measured) = 11.9 W/kg

**Configuration/5200MHz-Body/Zoom Scan (7x7x12), dist=1.4mm****(7x7x12)/Cube 0:** Measurement grid: dx=4mm, dy=4mm, dz=2mm

Reference Value = 69.74 V/m; Power Drift = -0.02 dB

Peak SAR (extrapolated) = 30.1 W/kg

**SAR(1 g) = 7.39 W/kg; SAR(10 g) = 2.13 W/kg**

Maximum value of SAR (measured) = 18.8 W/kg

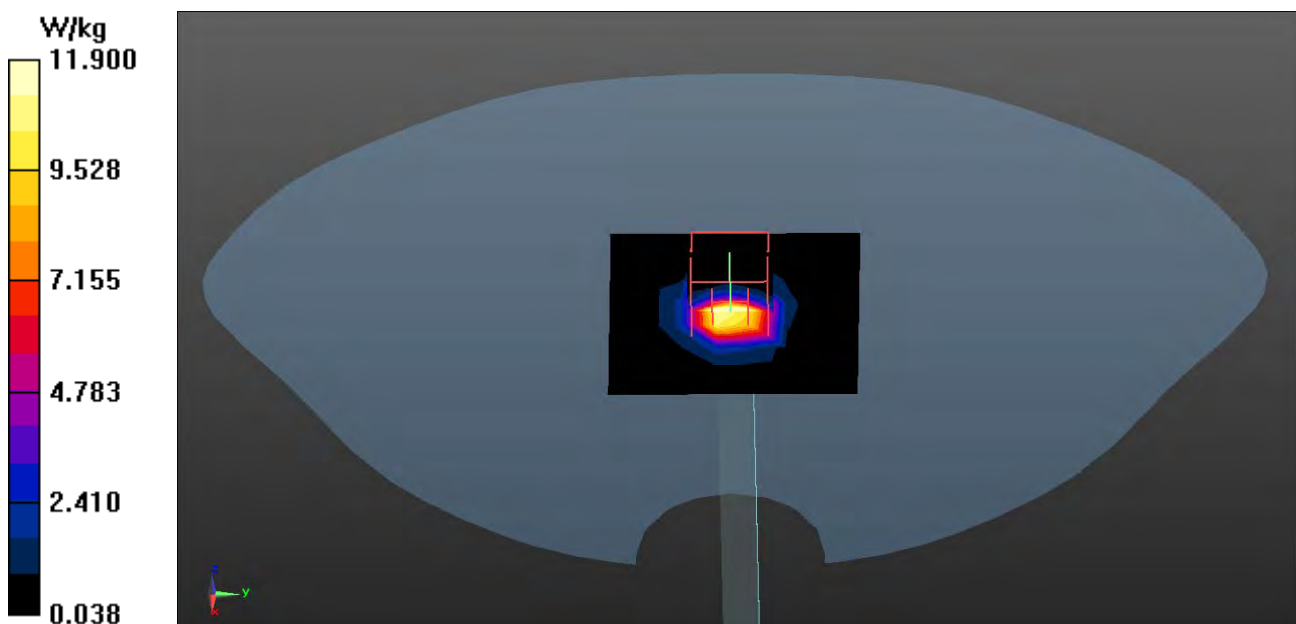

Test Laboratory: QuieTek-a DEKRA

Date/Time: 2017/02/02

**System Performance Check\_5300MHz-Body****DUT: Dipole 5GHz; Type: D5GHzV2**

Communication System: UID 0, CW; Frequency: 5300 MHz;

Communication System PAR: 0 dB

Medium parameters used:  $f = 5300$  MHz;  $\sigma = 5.39$  S/m;  $\epsilon_r = 48.85$ ;  $\rho = 1000$  kg/m<sup>3</sup>

Phantom section: Flat Section

Ambient Temperature (°C) : 21.9, Liquid Temperature (°C) : 20.5

Measurement Standard: DASY5 (IEEE/IEC/ANSI C63.19-2011)

DASY5 Configuration:

- Probe: EX3DV4 - SN3979; ConvF(4.55, 4.55, 4.55); Calibrated: 2016/11/25;
- Sensor-Surface: 1.4mm (Mechanical Surface Detection)
- Electronics: DAE4 Sn1425; Calibrated: 2016/11/18
- Phantom: SAM with right table; Type: SAM;
- Measurement SW: DASY52, Version 52.8 (8); SEMCAD X Version 14.6.10 (7373)

**Configuration/5300MHz-Body/Area Scan (8x8x1):** Measurement grid: dx=10mm, dy=10mm

Maximum value of SAR (measured) = 12.6 W/kg

**Configuration/5300MHz-Body/Zoom Scan (7x7x12), dist=1.4mm****(7x7x12)/Cube 0:** Measurement grid: dx=4mm, dy=4mm, dz=2mm

Reference Value = 68.27 V/m; Power Drift = 0.14 dB

Peak SAR (extrapolated) = 30.6 W/kg

**SAR(1 g) = 7.59 W/kg; SAR(10 g) = 2.03 W/kg**

Maximum value of SAR (measured) = 20.8 W/kg

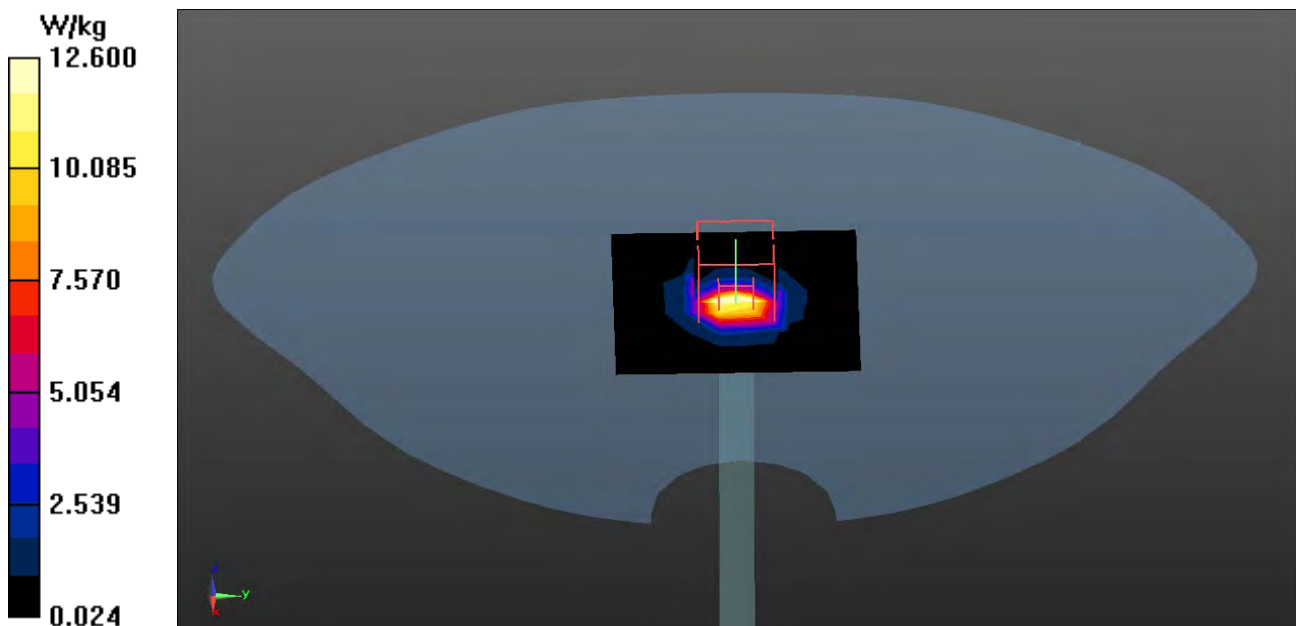

Test Laboratory: DEKRA

Date/Time: 2017/02/02

**System Performance Check\_5800MHz-Body****DUT: Dipole 5GHz; Type: D5GHzV2**

Communication System: UID 0, CW; Frequency: 5800 MHz;

Communication System PAR: 0 dB

Medium parameters used:  $f = 5800$  MHz;  $\sigma = 6.15$  S/m;  $\epsilon_r = 47.53$ ;  $\rho = 1000$  kg/m<sup>3</sup>

Phantom section: Flat Section

Ambient Temperature (°C) : 21.9, Liquid Temperature (°C) : 20.5

Measurement Standard: DASY5 (IEEE/IEC/ANSI C63.19-2011)

DASY5 Configuration:

- Probe: EX3DV4 - SN3979; ConvF(4.27, 4.27, 4.27); Calibrated: 2016/11/25;
- Sensor-Surface: 1.4mm (Mechanical Surface Detection)
- Electronics: DAE4 Sn1425; Calibrated: 2016/11/18
- Phantom: SAM with right table; Type: SAM;
- Measurement SW: DASY52, Version 52.8 (8); SEMCAD X Version 14.6.10 (7373)

**Configuration/5800MHz-Body/Area Scan (8x8x1):** Measurement grid: dx=10mm, dy=10mm

Maximum value of SAR (measured) = 12.8 W/kg

**Configuration/5800MHz-Body/Zoom Scan (7x7x12), dist=1.4mm****(7x7x12)/Cube 0:** Measurement grid: dx=4mm, dy=4mm, dz=2mm

Reference Value = 67.49 V/m; Power Drift = -0.01 dB

Peak SAR (extrapolated) = 33.7 W/kg

**SAR(1 g) = 7.61 W/kg; SAR(10 g) = 2.17 W/kg**

Maximum value of SAR (measured) = 20.3 W/kg

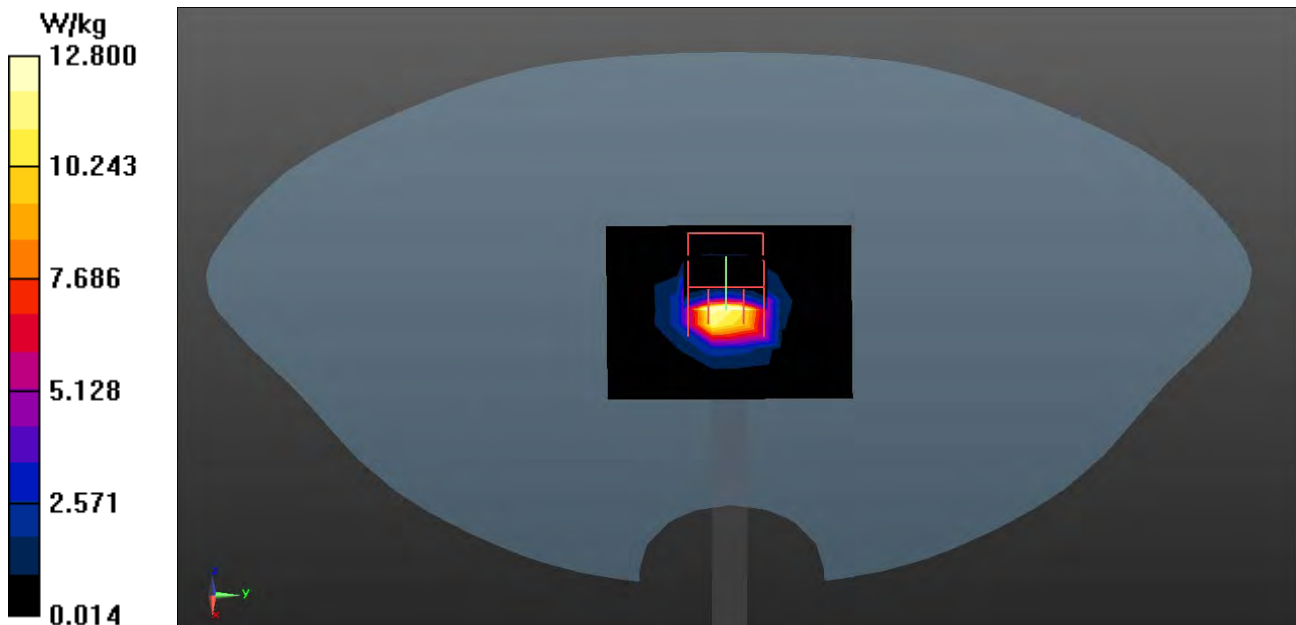

## Appendix B. SAR measurement Data

Test Laboratory: DEKRA

Date/Time: 2017/02/03

### 802.11b\_1-Back-Main

#### DUT: DT317BT; Type: Mobile Tablet

Communication System: UID 0, WLAN 2.4G; Frequency: 2412 MHz;

Communication System PAR: 0 dB

Medium parameters used:  $f = 2412$  MHz;  $\sigma = 1.93$  S/m;  $\epsilon_r = 52.65$ ;  $\rho = 1000$  kg/m<sup>3</sup>

Phantom section: Flat Section

Ambient Temperature (°C) : 21.6, Liquid Temperature (°C) : 20.2

Measurement Standard: DASYS5 (IEEE/IEC/ANSI C63.19-2011)

DASY5 Configuration:

- Probe: EX3DV4 - SN3979; ConvF(7.47, 7.47, 7.47); Calibrated: 2016/11/25;
- Sensor-Surface: 3mm (Mechanical Surface Detection)
- Electronics: DAE4 Sn1425; Calibrated: 2016/11/18
- Phantom: SAM with left table; Type: SAM;
- Measurement SW: DASYS52, Version 52.8 (8); SEMCAD X Version 14.6.10 (7373)

**Configuration/Body/Area Scan (5x19x1):** Measurement grid: dx=12mm, dy=12mm  
Maximum value of SAR (measured) = 0.431 W/kg

**Configuration/Body/Zoom Scan (7x7x7) (7x7x7)/Cube 0:** Measurement grid:  
dx=5mm, dy=5mm, dz=5mm

Reference Value = 3.777 V/m; Power Drift = -0.06 dB

Peak SAR (extrapolated) = 0.847 W/kg

**SAR(1 g) = 0.431 W/kg; SAR(10 g) = 0.204 W/kg**

Maximum value of SAR (measured) = 0.557 W/kg

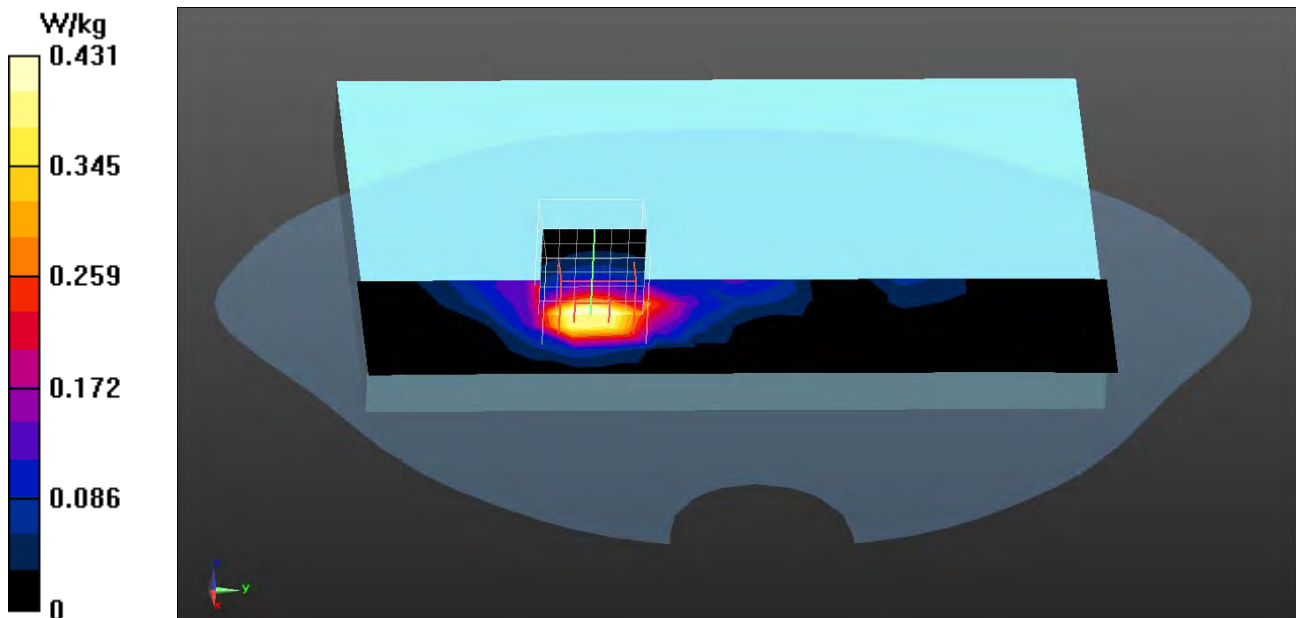

Test Laboratory: DEKRA

Date/Time: 2017/02/03

**802.11b\_1-Bottom-Main****DUT: DT317BT; Type: Mobile Tablet**

Communication System: UID 0, WLAN 2.4G; Frequency: 2412 MHz;

Communication System PAR: 0 dB

Medium parameters used:  $f = 2412$  MHz;  $\sigma = 1.93$  S/m;  $\epsilon_r = 52.65$ ;  $\rho = 1000$  kg/m<sup>3</sup>

Phantom section: Flat Section

Ambient Temperature (°C) : 21.6, Liquid Temperature (°C) : 20.2

Measurement Standard: DASYS (IEEE/IEC/ANSI C63.19-2011)

DASY5 Configuration:

- Probe: EX3DV4 - SN3979; ConvF(7.47, 7.47, 7.47); Calibrated: 2016/11/25;
- Sensor-Surface: 3mm (Mechanical Surface Detection)
- Electronics: DAE4 Sn1425; Calibrated: 2016/11/18
- Phantom: SAM with left table; Type: SAM;
- Measurement SW: DASY52, Version 52.8 (8); SEMCAD X Version 14.6.10 (7373)

**Configuration/Body/Area Scan (4x19x1):** Measurement grid: dx=12mm, dy=12mm  
Maximum value of SAR (measured) = 0.194 W/kg

**Configuration/Body/Zoom Scan (7x7x7) (7x7x7)/Cube 0:** Measurement grid:  
dx=5mm, dy=5mm, dz=5mm

Reference Value = 2.490 V/m; Power Drift = 0.19 dB

Peak SAR (extrapolated) = 0.335 W/kg

**SAR(1 g) = 0.155 W/kg; SAR(10 g) = 0.075 W/kg**

Maximum value of SAR (measured) = 0.202 W/kg

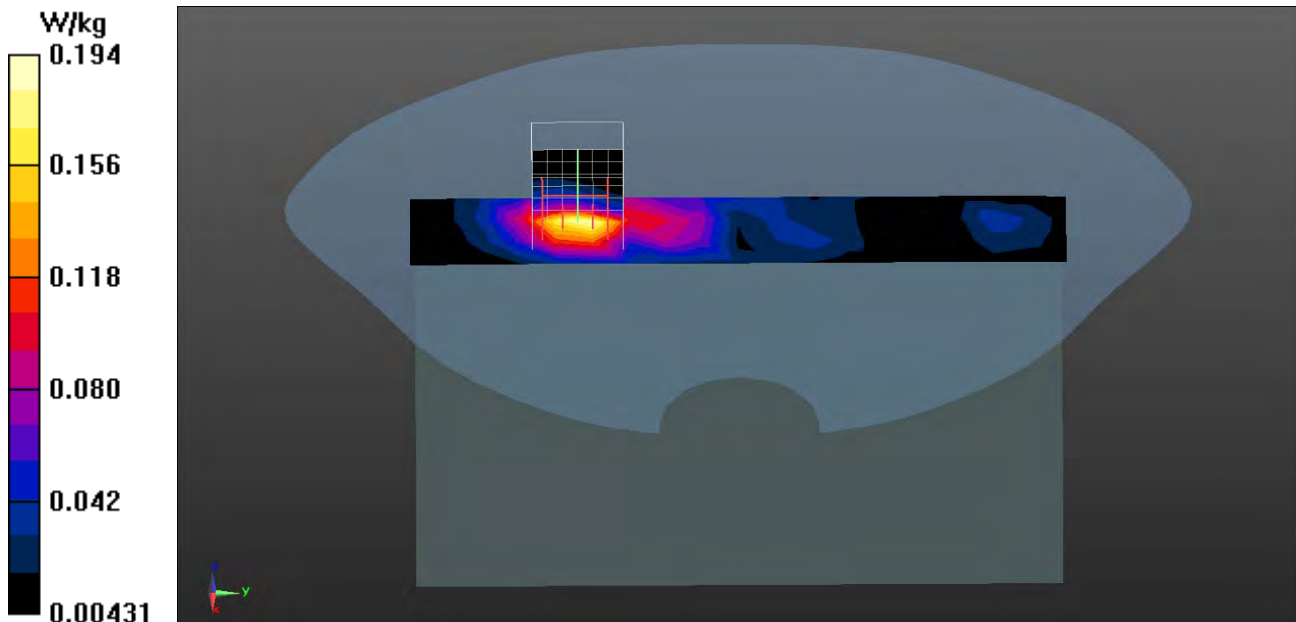

Test Laboratory: DEKRA

Date/Time: 2017/02/03

**802.11b\_1-Right-side-Main****DUT: DT317BT; Type: Mobile Tablet**

Communication System: UID 0, WLAN 2.4G; Frequency: 2412 MHz;

Communication System PAR: 0 dB

Medium parameters used:  $f = 2412$  MHz;  $\sigma = 1.93$  S/m;  $\epsilon_r = 52.65$ ;  $\rho = 1000$  kg/m<sup>3</sup>

Phantom section: Flat Section

Ambient Temperature (°C) : 21.6, Liquid Temperature (°C) : 20.2

Measurement Standard: DASYS (IEEE/IEC/ANSI C63.19-2011)

**DASY5 Configuration:**

- Probe: EX3DV4 - SN3979; ConvF(7.47, 7.47, 7.47); Calibrated: 2016/11/25;
- Sensor-Surface: 3mm (Mechanical Surface Detection)
- Electronics: DAE4 Sn1425; Calibrated: 2016/11/18
- Phantom: SAM with left table; Type: SAM;
- Measurement SW: DASYS2, Version 52.8 (8); SEMCAD X Version 14.6.10 (7373)

**Configuration/Body/Area Scan (4x13x1):** Measurement grid: dx=12mm, dy=12mm  
Maximum value of SAR (measured) = 0.0829 W/kg**Configuration/Body/Zoom Scan (7x7x7) (7x7x7)/Cube 0:** Measurement grid:  
dx=5mm, dy=5mm, dz=5mm

Reference Value = 1.903 V/m; Power Drift = -0.14 dB

Peak SAR (extrapolated) = 0.157 W/kg

**SAR(1 g) = 0.079 W/kg; SAR(10 g) = 0.038 W/kg**

Maximum value of SAR (measured) = 0.103 W/kg

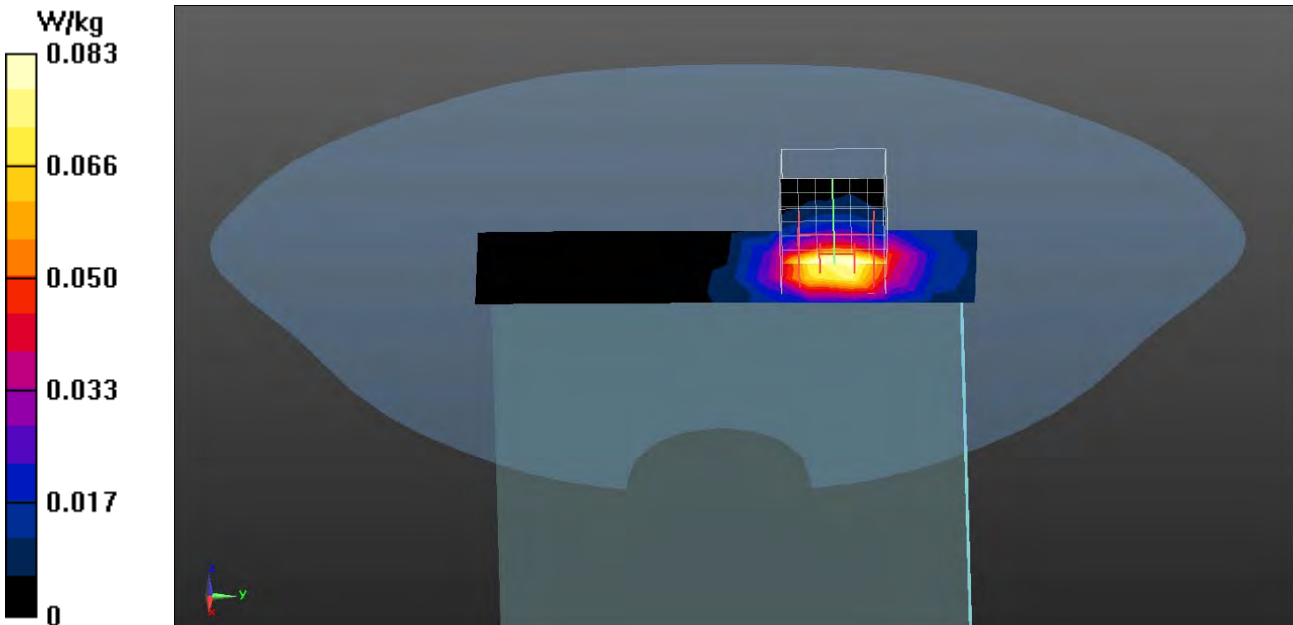

Test Laboratory: DEKRA

Date/Time: 2017/02/03

**802.11b\_1-Back-Aux****DUT: DT317BT; Type: Mobile Tablet**

Communication System: UID 0, WLAN 2.4G; Frequency: 2412 MHz;

Communication System PAR: 0 dB

Medium parameters used:  $f = 2412$  MHz;  $\sigma = 1.93$  S/m;  $\epsilon_r = 52.65$ ;  $\rho = 1000$  kg/m<sup>3</sup>

Phantom section: Flat Section

Ambient Temperature (°C) : 21.6, Liquid Temperature (°C) : 20.2

Measurement Standard: DASYS (IEEE/IEC/ANSI C63.19-2011)

DASY5 Configuration:

- Probe: EX3DV4 - SN3979; ConvF(7.47, 7.47, 7.47); Calibrated: 2016/11/25;
- Sensor-Surface: 3mm (Mechanical Surface Detection)
- Electronics: DAE4 Sn1425; Calibrated: 2016/11/18
- Phantom: SAM with left table; Type: SAM;
- Measurement SW: DASY52, Version 52.8 (8); SEMCAD X Version 14.6.10 (7373)

**Configuration/Body/Area Scan (5x19x1):** Measurement grid: dx=12mm, dy=12mm  
Maximum value of SAR (measured) = 0.230 W/kg

**Configuration/Body/Zoom Scan (7x7x7) (7x7x7)/Cube 0:** Measurement grid:  
dx=5mm, dy=5mm, dz=5mm

Reference Value = 5.790 V/m; Power Drift = 0.08 dB

Peak SAR (extrapolated) = 0.368 W/kg

**SAR(1 g) = 0.175 W/kg; SAR(10 g) = 0.095 W/kg**

Maximum value of SAR (measured) = 0.226 W/kg

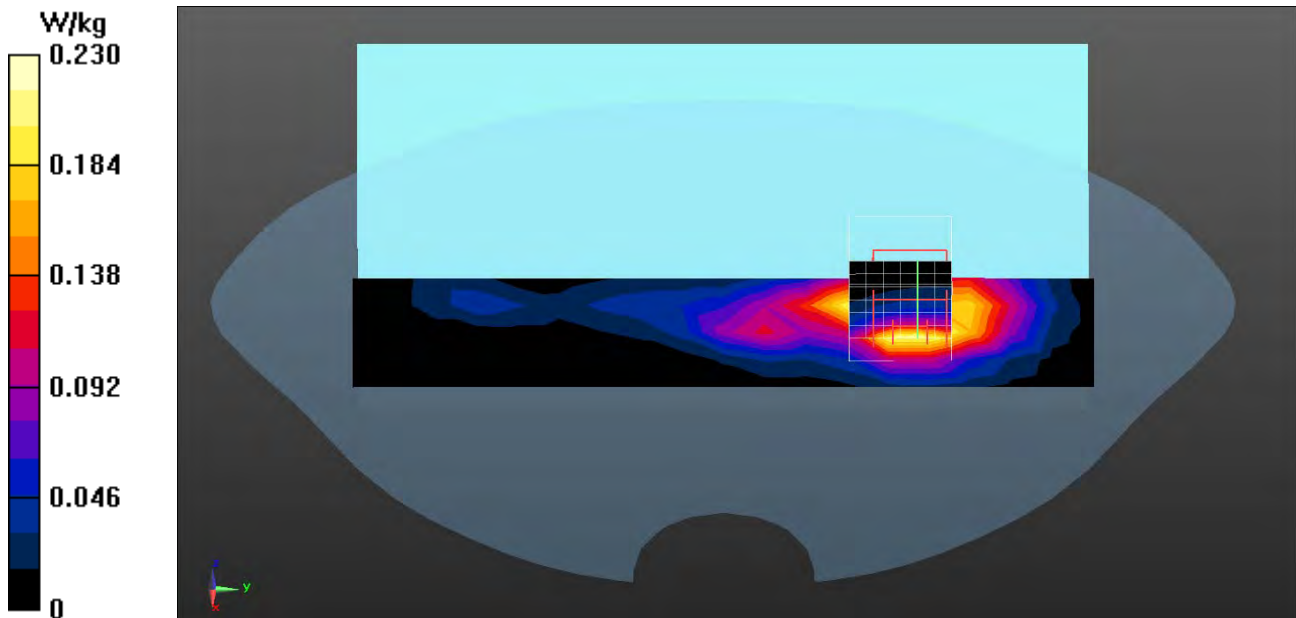



Test Laboratory: DEKRA

Date/Time: 2017/02/03

**802.11b\_1-Top-Aux**

**DUT: DT317BT; Type: Mobile Tablet**

Communication System: UID 0, WLAN 2.4G; Frequency: 2412 MHz;

Communication System PAR: 0 dB

Medium parameters used:  $f = 2412$  MHz;  $\sigma = 1.93$  S/m;  $\epsilon_r = 52.65$ ;  $\rho = 1000$  kg/m<sup>3</sup>

Phantom section: Flat Section

Ambient Temperature (°C) : 21.6, Liquid Temperature (°C) : 20.2

Measurement Standard: DASYS (IEEE/IEC/ANSI C63.19-2011)

DASY5 Configuration:

- Probe: EX3DV4 - SN3979; ConvF(7.47, 7.47, 7.47); Calibrated: 2016/11/25;
- Sensor-Surface: 3mm (Mechanical Surface Detection)
- Electronics: DAE4 Sn1425; Calibrated: 2016/11/18
- Phantom: SAM with left table; Type: SAM;
- Measurement SW: DASYS2, Version 52.8 (8); SEMCAD X Version 14.6.10 (7373)

**Configuration/Body/Area Scan (4x19x1):** Measurement grid: dx=12mm, dy=12mm  
 Maximum value of SAR (measured) = 0.340 W/kg

**Configuration/Body/Zoom Scan (7x7x7) (7x7x7)/Cube 0:** Measurement grid:  
 dx=5mm, dy=5mm, dz=5mm

Reference Value = 6.014 V/m; Power Drift = 0.09 dB

Peak SAR (extrapolated) = 0.562 W/kg

**SAR(1 g) = 0.263 W/kg; SAR(10 g) = 0.119 W/kg**

Maximum value of SAR (measured) = 0.346 W/kg

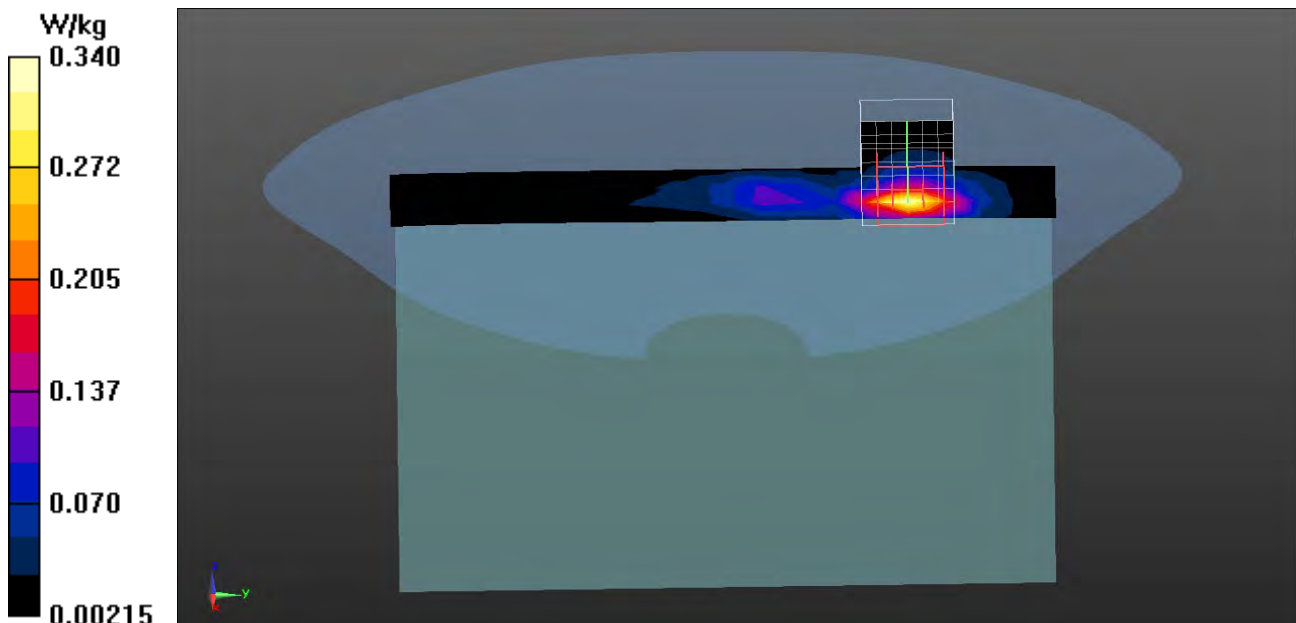

Test Laboratory: DEKRA

Date/Time: 2017/02/03

**802.11b\_1-Right-side-Aux****DUT: DT317BT; Type: Mobile Tablet**

Communication System: UID 0, WLAN 2.4G; Frequency: 2412 MHz;

Communication System PAR: 0 dB

Medium parameters used:  $f = 2412$  MHz;  $\sigma = 1.93$  S/m;  $\epsilon_r = 52.65$ ;  $\rho = 1000$  kg/m<sup>3</sup>

Phantom section: Flat Section

Ambient Temperature (°C) : 21.6, Liquid Temperature (°C) : 20.2

Measurement Standard: DASYS (IEEE/IEC/ANSI C63.19-2011)

DASY5 Configuration:

- Probe: EX3DV4 - SN3979; ConvF(7.47, 7.47, 7.47); Calibrated: 2016/11/25;
- Sensor-Surface: 3mm (Mechanical Surface Detection)
- Electronics: DAE4 Sn1425; Calibrated: 2016/11/18
- Phantom: SAM with left table; Type: SAM;
- Measurement SW: DASYS2, Version 52.8 (8); SEMCAD X Version 14.6.10 (7373)

**Configuration/Body/Area Scan (4x13x1):** Measurement grid: dx=12mm, dy=12mm  
Maximum value of SAR (measured) = 0.0760 W/kg**Configuration/Body/Zoom Scan (7x7x7) (7x7x7)/Cube 0:** Measurement grid:  
dx=5mm, dy=5mm, dz=5mm

Reference Value = 3.544 V/m; Power Drift = 0.12 dB

Peak SAR (extrapolated) = 0.151 W/kg

**SAR(1 g) = 0.076 W/kg; SAR(10 g) = 0.035 W/kg**

Maximum value of SAR (measured) = 0.0992 W/kg

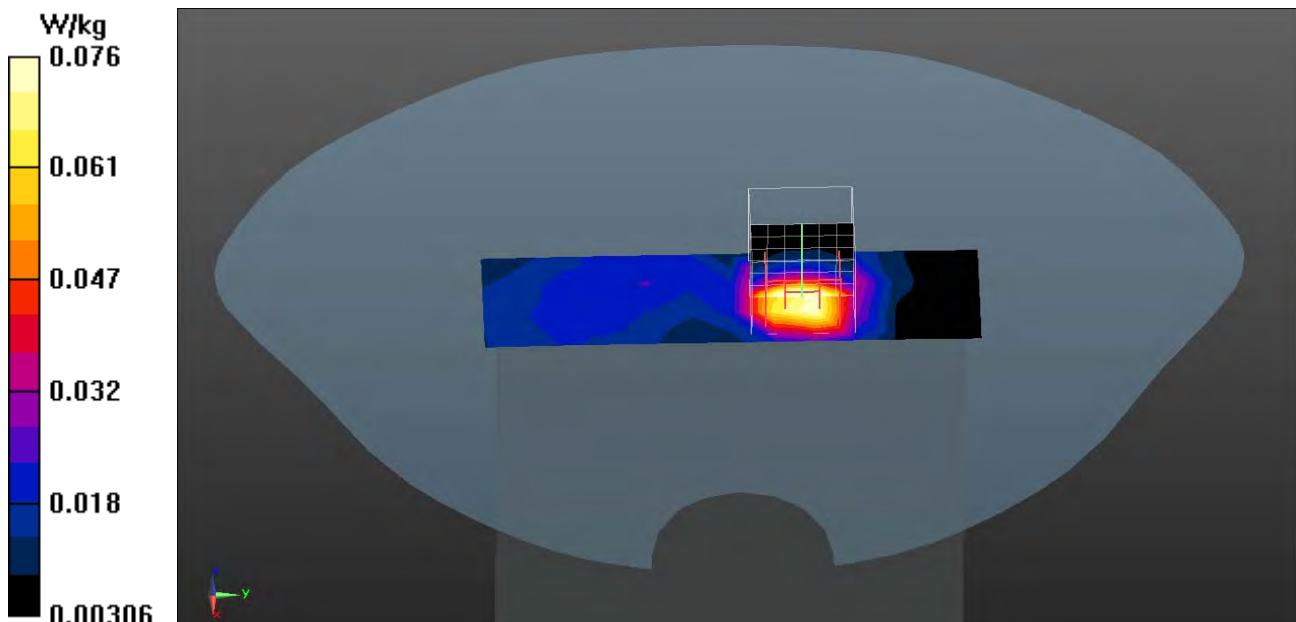

**802.11b EUT (Main Antenna) Back Z-Axis plot**  
**Channel: 1**

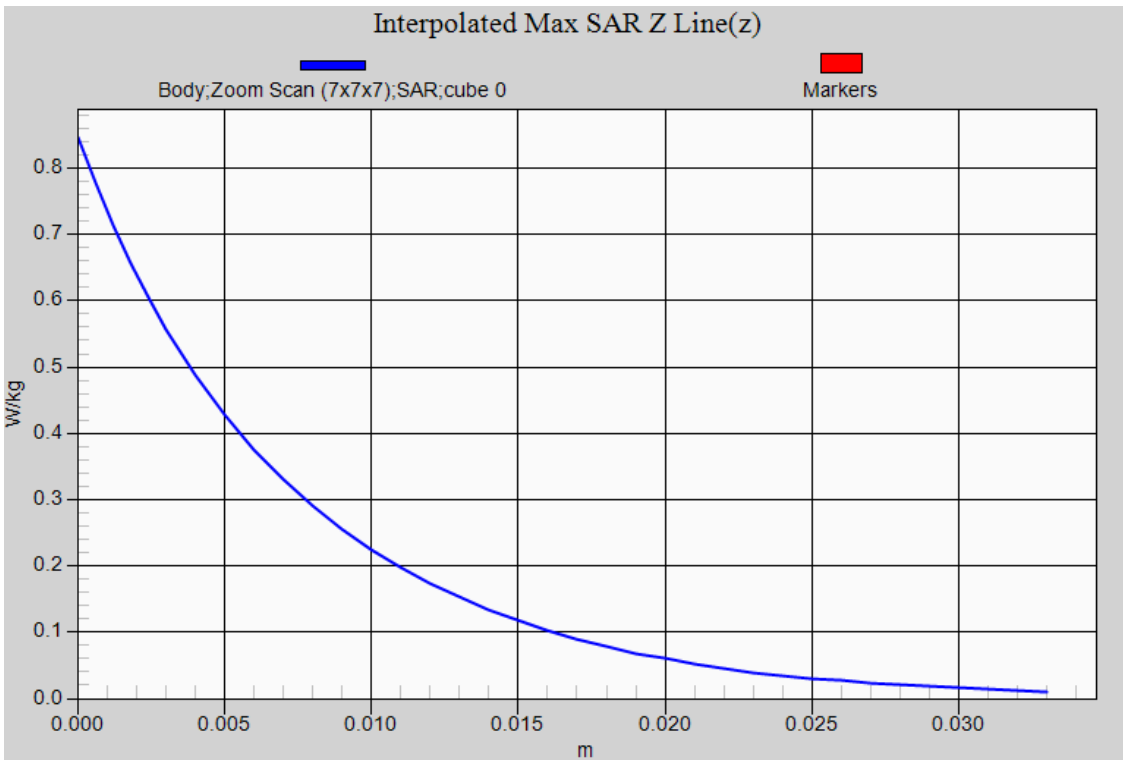

Test Laboratory: DEKRA

Date/Time: 2017/02/02

**802.11a\_52-Back-Main****DUT: DT317BT; Type: Mobile Tablet**

Communication System: UID 0, WLAN 5G; Frequency: 5260 MHz;

Communication System PAR: 0 dB

Medium parameters used:  $f = 5260$  MHz;  $\sigma = 5.33$  S/m;  $\epsilon_r = 48.96$ ;  $\rho = 1000$  kg/m<sup>3</sup>

Phantom section: Flat Section

Ambient Temperature (°C) : 21.9, Liquid Temperature (°C) : 20.5

Measurement Standard: DASYS (IEEE/IEC/ANSI C63.19-2011)

DASY5 Configuration:

- Probe: EX3DV4 - SN3979; ConvF(4.55, 4.55, 4.55); Calibrated: 2016/11/25;
- Sensor-Surface: 1.4mm (Mechanical Surface Detection)
- Electronics: DAE4 Sn1425; Calibrated: 2016/11/18
- Phantom: SAM with right table; Type: SAM;
- Measurement SW: DASY52, Version 52.8 (8); SEMCAD X Version 14.6.10 (7373)

**Configuration/Body/Area Scan (6x11x1):** Measurement grid: dx=10mm, dy=10mm  
Maximum value of SAR (measured) = 1.01 W/kg**Configuration/Body/Zoom Scan (7x7x12) (7x7x12)/Cube 0:** Measurement grid:  
dx=4mm, dy=4mm, dz=2mm

Reference Value = 0 V/m; Power Drift = 0.03 dB

Peak SAR (extrapolated) = 1.77 W/kg

**SAR(1 g) = 0.419 W/kg; SAR(10 g) = 0.141 W/kg**

Maximum value of SAR (measured) = 0.998 W/kg

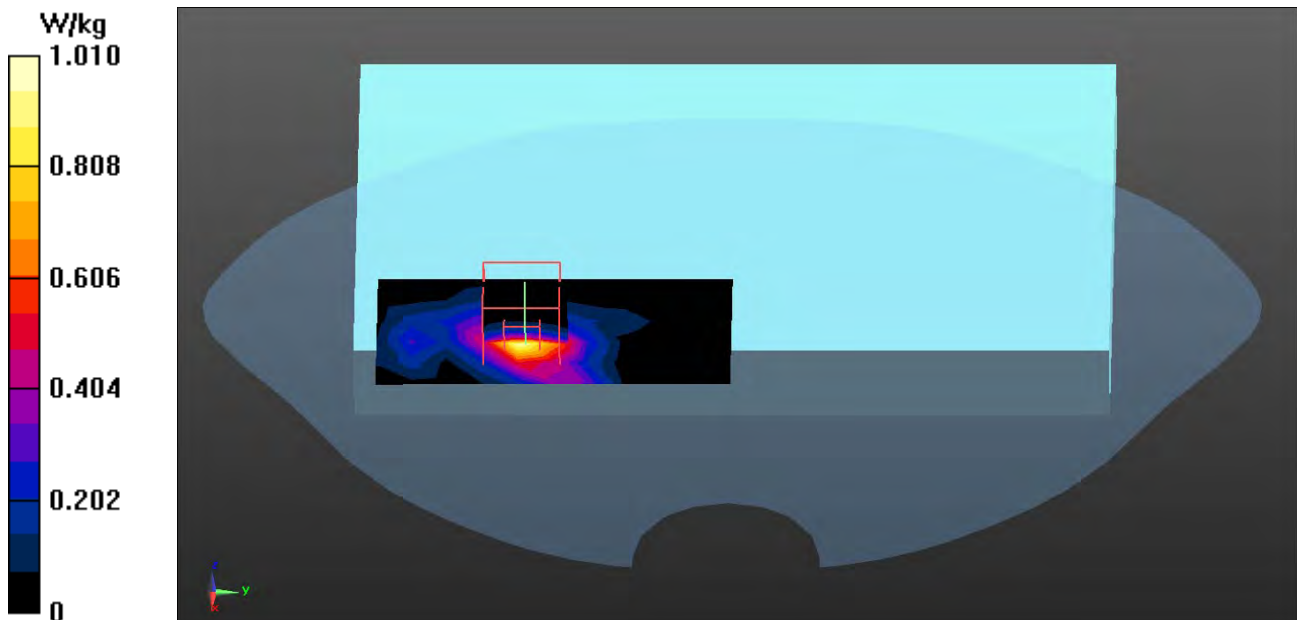

Test Laboratory: DEKRA

Date/Time: 2017/02/02

**802.11a\_149-Back-Main****DUT: DT317BT; Type: Mobile Tablet**

Communication System: UID 0, WLAN 5G; Frequency: 5745 MHz;

Communication System PAR: 0 dB

Medium parameters used:  $f = 5745$  MHz;  $\sigma = 6.06$  S/m;  $\epsilon_r = 47.67$ ;  $\rho = 1000$  kg/m<sup>3</sup>

Phantom section: Flat Section

Ambient Temperature (°C) : 21.9, Liquid Temperature (°C) : 20.5

Measurement Standard: DASY5 (IEEE/IEC/ANSI C63.19-2011)

DASY5 Configuration:

- Probe: EX3DV4 - SN3979; ConvF(4.27, 4.27, 4.27); Calibrated: 2016/11/25;
- Sensor-Surface: 1.4mm (Mechanical Surface Detection)
- Electronics: DAE4 Sn1425; Calibrated: 2016/11/18
- Phantom: SAM with right table; Type: SAM;
- Measurement SW: DASY52, Version 52.8 (8); SEMCAD X Version 14.6.10 (7373)

**Configuration/Body/Area Scan (6x23x1):** Measurement grid: dx=10mm, dy=10mm  
Maximum value of SAR (measured) = 1.04 W/kg

**Configuration/Body/Zoom Scan (7x7x12) (7x7x12)/Cube 0:** Measurement grid:  
dx=4mm, dy=4mm, dz=2mm  
Reference Value = 1.717 V/m; Power Drift = 0.19 dB  
Peak SAR (extrapolated) = 1.89 W/kg  
**SAR(1 g) = 0.403 W/kg; SAR(10 g) = 0.124 W/kg**  
Maximum value of SAR (measured) = 1.03 W/kg

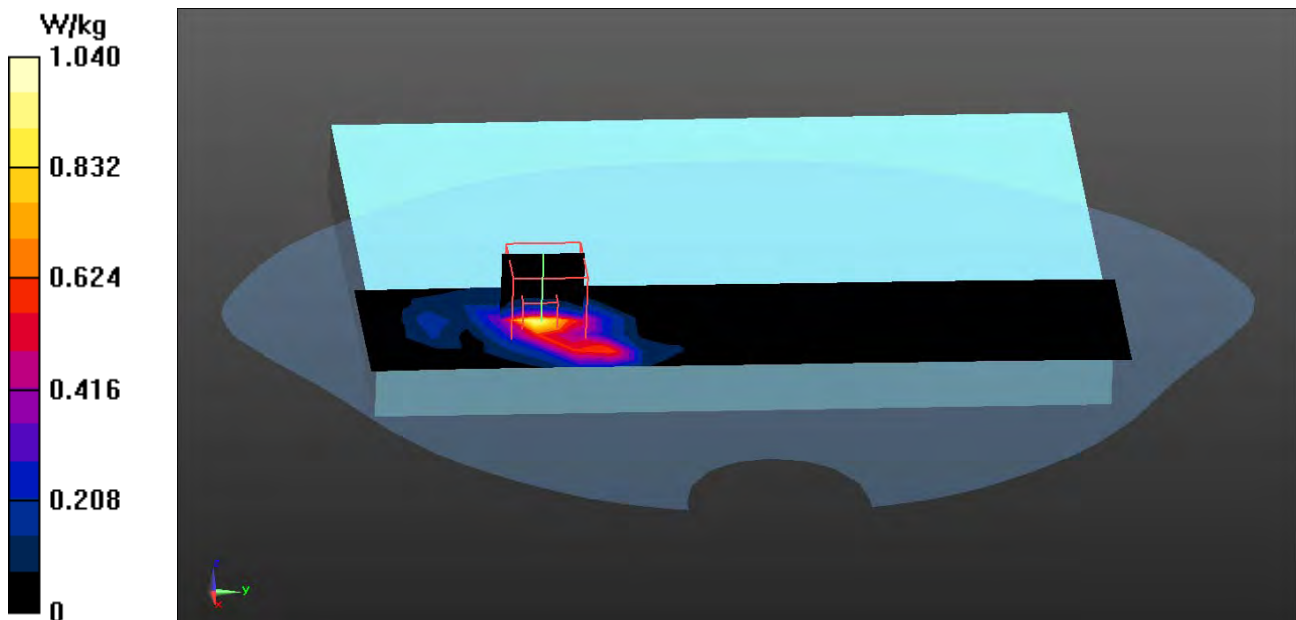

Test Laboratory: DEKRA

Date/Time: 2017/02/02

**802.11a\_36-Bottom-Main****DUT: DT317BT; Type: Mobile Tablet**

Communication System: UID 0, WLAN 5G; Frequency: 5180 MHz;

Communication System PAR: 0 dB

Medium parameters used:  $f = 5180$  MHz;  $\sigma = 5.21$  S/m;  $\epsilon_r = 49.18$ ;  $\rho = 1000$  kg/m<sup>3</sup>

Phantom section: Flat Section

Ambient Temperature (°C) : 21.9, Liquid Temperature (°C) : 20.5

Measurement Standard: DASYS (IEEE/IEC/ANSI C63.19-2011)

DASY5 Configuration:

- Probe: EX3DV4 - SN3979; ConvF(4.75, 4.75, 4.75); Calibrated: 2016/11/25;
- Sensor-Surface: 1.4mm (Mechanical Surface Detection)
- Electronics: DAE4 Sn1425; Calibrated: 2016/11/18
- Phantom: SAM with right table; Type: SAM;
- Measurement SW: DASYS2, Version 52.8 (8); SEMCAD X Version 14.6.10 (7373)

**Configuration/Body/Area Scan (6x8x1):** Measurement grid: dx=10mm, dy=10mm  
Maximum value of SAR (measured) = 1.76 W/kg**Configuration/Body/Zoom Scan (7x7x12) (7x7x12)/Cube 0:** Measurement grid:  
dx=4mm, dy=4mm, dz=2mm

Reference Value = 3.310 V/m; Power Drift = -0.05 dB

Peak SAR (extrapolated) = 6.35 W/kg

**SAR(1 g) = 1.15 W/kg; SAR(10 g) = 0.251 W/kg**

Maximum value of SAR (measured) = 3.47 W/kg

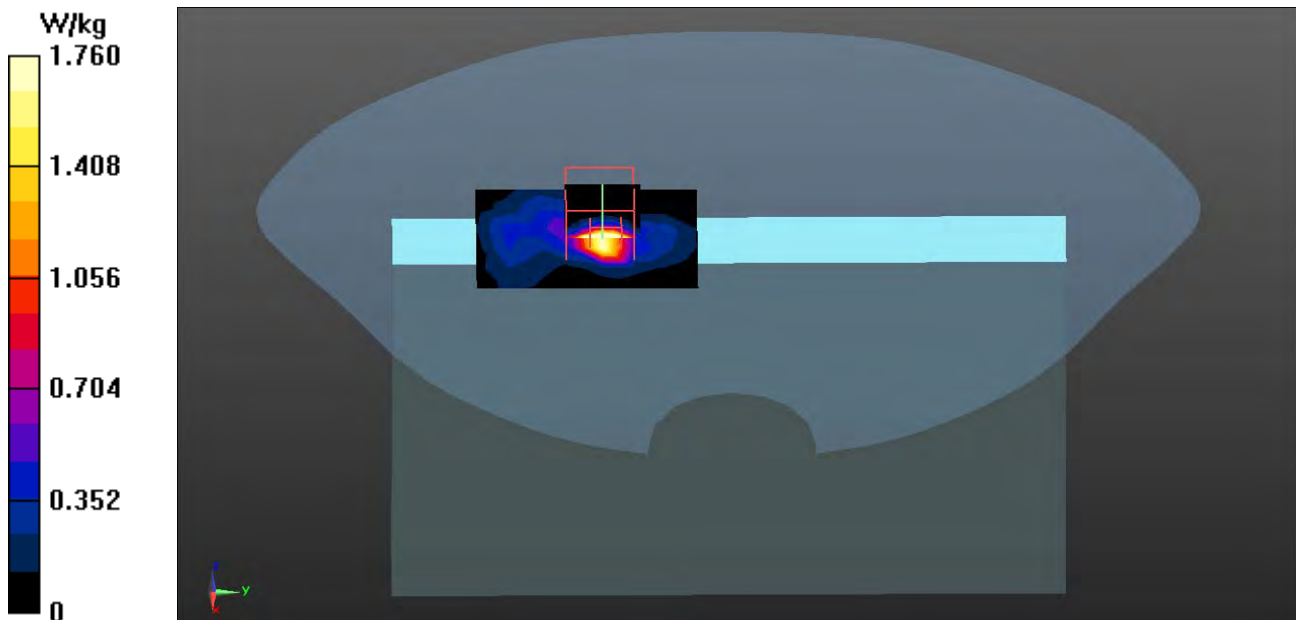

Test Laboratory: DEKRA

Date/Time: 2017/02/02

**802.11a\_44-Bottom-Main****DUT: DT317BT; Type: Mobile Tablet**

Communication System: UID 0, WLAN 5G; Frequency: 5220 MHz;

Communication System PAR: 0 dB

Medium parameters used:  $f = 5220$  MHz;  $\sigma = 5.27$  S/m;  $\epsilon_r = 49.07$ ;  $\rho = 1000$  kg/m<sup>3</sup>

Phantom section: Flat Section

Ambient Temperature (°C) : 21.9, Liquid Temperature (°C) : 20.5

Measurement Standard: DASY5 (IEEE/IEC/ANSI C63.19-2011)

DASY5 Configuration:

- Probe: EX3DV4 - SN3979; ConvF(4.75, 4.75, 4.75); Calibrated: 2016/11/25;
- Sensor-Surface: 1.4mm (Mechanical Surface Detection)
- Electronics: DAE4 Sn1425; Calibrated: 2016/11/18
- Phantom: SAM with right table; Type: SAM;
- Measurement SW: DASY52, Version 52.8 (8); SEMCAD X Version 14.6.10 (7373)

**Configuration/Body/Area Scan (6x9x1):** Measurement grid: dx=10mm, dy=10mm  
Maximum value of SAR (measured) = 1.98 W/kg

**Configuration/Body/Zoom Scan (7x7x12) (7x7x12)/Cube 0:** Measurement grid:  
dx=4mm, dy=4mm, dz=2mm

Reference Value = 3.660 V/m; Power Drift = 0.14 dB

Peak SAR (extrapolated) = 7.19 W/kg

**SAR(1 g) = 1.27 W/kg; SAR(10 g) = 0.279 W/kg**

Maximum value of SAR (measured) = 3.85 W/kg

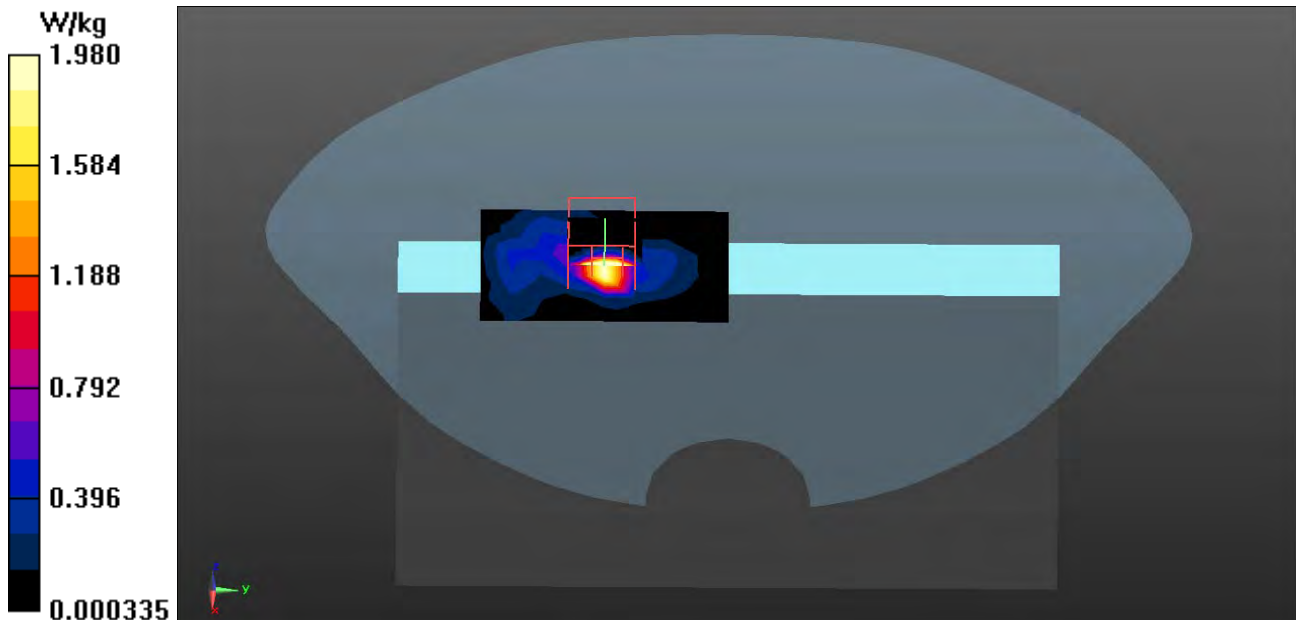

Test Laboratory: DEKRA

Date/Time: 2017/02/02

**802.11a\_48-Bottom-Main****DUT: DT317BT; Type: Mobile Tablet**

Communication System: UID 0, WLAN 5G; Frequency: 5240 MHz;

Communication System PAR: 0 dB

Medium parameters used:  $f = 5240$  MHz;  $\sigma = 5.3$  S/m;  $\epsilon_r = 49.01$ ;  $\rho = 1000$  kg/m<sup>3</sup>

Phantom section: Flat Section

Ambient Temperature (°C) : 21.9, Liquid Temperature (°C) : 20.5

Measurement Standard: DASY5 (IEEE/IEC/ANSI C63.19-2011)

DASY5 Configuration:

- Probe: EX3DV4 - SN3979; ConvF(4.75, 4.75, 4.75); Calibrated: 2016/11/25;
- Sensor-Surface: 1.4mm (Mechanical Surface Detection)
- Electronics: DAE4 Sn1425; Calibrated: 2016/11/18
- Phantom: SAM with right table; Type: SAM;
- Measurement SW: DASY52, Version 52.8 (8); SEMCAD X Version 14.6.10 (7373)

**Configuration/Body/Area Scan (6x9x1):** Measurement grid: dx=10mm, dy=10mm  
Maximum value of SAR (measured) = 1.99 W/kg

**Configuration/Body/Zoom Scan (7x7x12) (7x7x12)/Cube 0:** Measurement grid:  
dx=4mm, dy=4mm, dz=2mm

Reference Value = 3.622 V/m; Power Drift = 0.14 dB

Peak SAR (extrapolated) = 7.38 W/kg

**SAR(1 g) = 1.32 W/kg; SAR(10 g) = 0.288 W/kg**

Maximum value of SAR (measured) = 3.97 W/kg

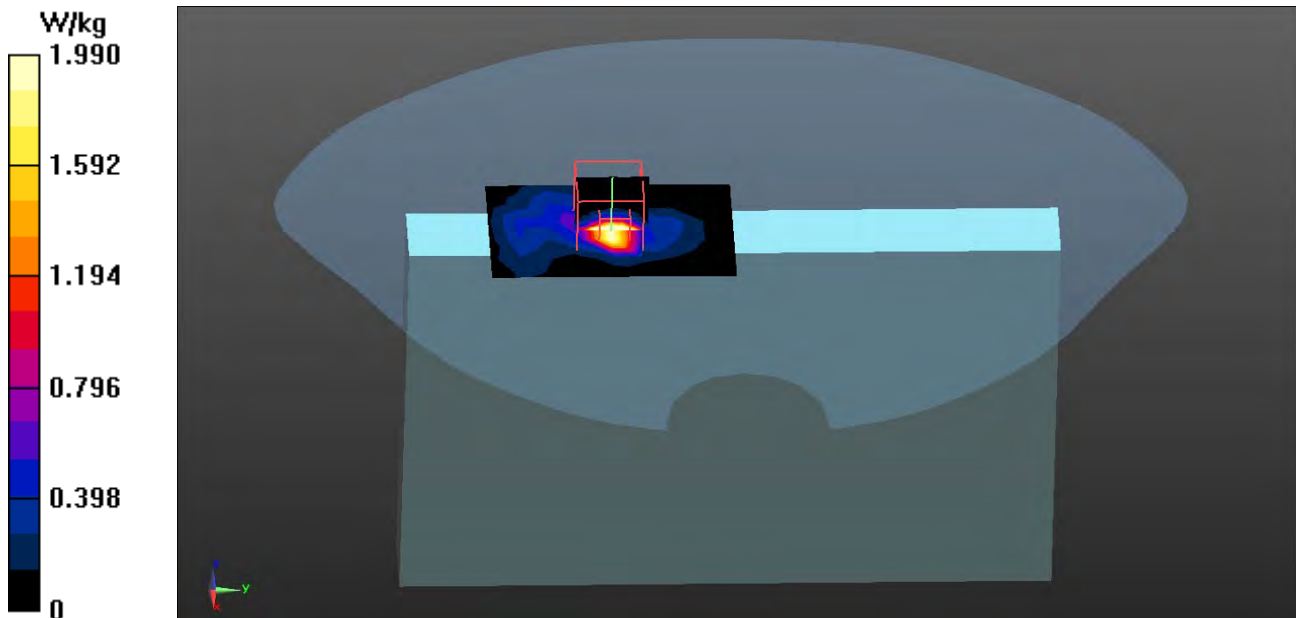



Test Laboratory: DEKRA

Date/Time: 2017/02/02

**802.11a\_52-Bottom-Main****DUT: DT317BT; Type: Mobile Tablet**

Communication System: UID 0, WLAN 5G; Frequency: 5260 MHz;

Communication System PAR: 0 dB

Medium parameters used:  $f = 5260$  MHz;  $\sigma = 5.33$  S/m;  $\epsilon_r = 48.96$ ;  $\rho = 1000$  kg/m<sup>3</sup>

Phantom section: Flat Section

Ambient Temperature (°C) : 21.9, Liquid Temperature (°C) : 20.5

Measurement Standard: DASY5 (IEEE/IEC/ANSI C63.19-2011)

DASY5 Configuration:

- Probe: EX3DV4 - SN3979; ConvF(4.55, 4.55, 4.55); Calibrated: 2016/11/25;
- Sensor-Surface: 1.4mm (Mechanical Surface Detection)
- Electronics: DAE4 Sn1425; Calibrated: 2016/11/18
- Phantom: SAM with right table; Type: SAM;
- Measurement SW: DASY52, Version 52.8 (8); SEMCAD X Version 14.6.10 (7373)

**Configuration/Body/Area Scan (6x10x1):** Measurement grid: dx=10mm, dy=10mm  
Maximum value of SAR (measured) = 1.72 W/kg**Configuration/Body/Zoom Scan (7x7x12) (7x7x12)/Cube 0:** Measurement grid:  
dx=4mm, dy=4mm, dz=2mm

Reference Value = 3.177 V/m; Power Drift = 0.16 dB

Peak SAR (extrapolated) = 6.26 W/kg

**SAR(1 g) = 1.11 W/kg; SAR(10 g) = 0.242 W/kg**

Maximum value of SAR (measured) = 3.33 W/kg

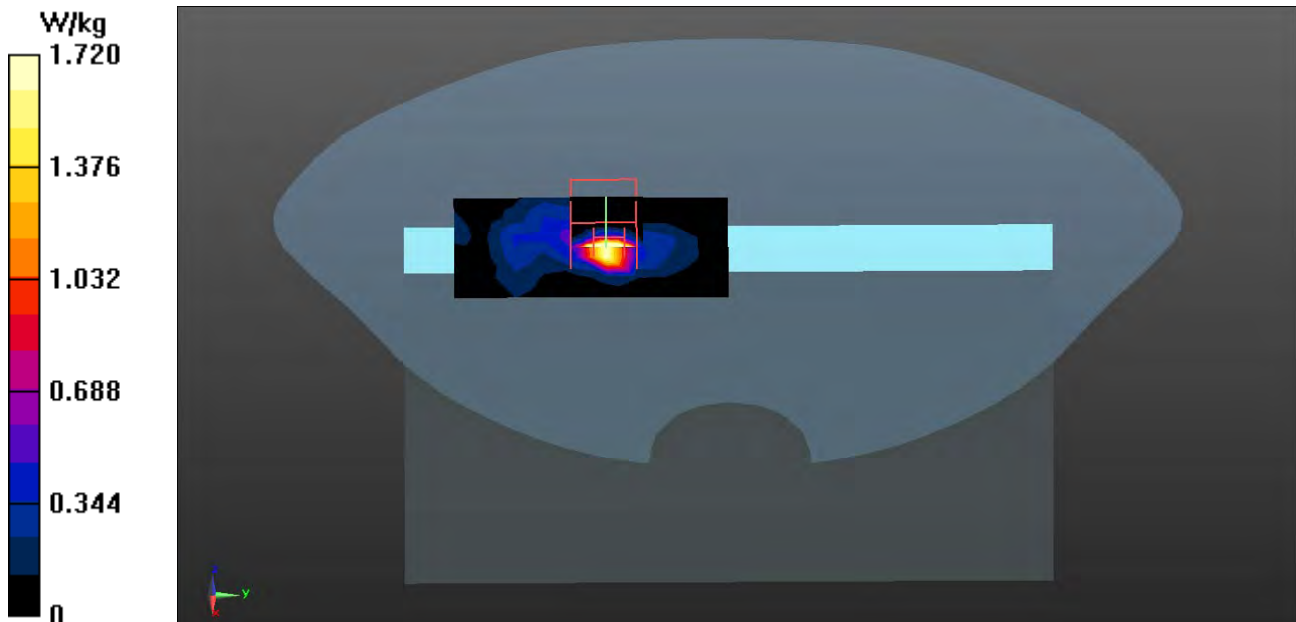

Test Laboratory: DEKRA

Date/Time: 2017/02/02

**802.11a\_60-Bottom-Main****DUT: DT317BT; Type: Mobile Tablet**

Communication System: UID 0, WLAN 5G; Frequency: 5300 MHz;

Communication System PAR: 0 dB

Medium parameters used:  $f = 5300$  MHz;  $\sigma = 5.39$  S/m;  $\epsilon_r = 48.85$ ;  $\rho = 1000$  kg/m<sup>3</sup>

Phantom section: Flat Section

Ambient Temperature (°C) : 21.9, Liquid Temperature (°C) : 20.5

Measurement Standard: DASY5 (IEEE/IEC/ANSI C63.19-2011)

DASY5 Configuration:

- Probe: EX3DV4 - SN3979; ConvF(4.55, 4.55, 4.55); Calibrated: 2016/11/25;
- Sensor-Surface: 1.4mm (Mechanical Surface Detection)
- Electronics: DAE4 Sn1425; Calibrated: 2016/11/18
- Phantom: SAM with right table; Type: SAM;
- Measurement SW: DASY52, Version 52.8 (8); SEMCAD X Version 14.6.10 (7373)

**Configuration/Body/Area Scan (6x8x1):** Measurement grid: dx=10mm, dy=10mm  
Maximum value of SAR (measured) = 2.01 W/kg**Configuration/Body/Zoom Scan (7x7x12) (7x7x12)/Cube 0:** Measurement grid:  
dx=4mm, dy=4mm, dz=2mm

Reference Value = 1.532 V/m; Power Drift = 0.16 dB

Peak SAR (extrapolated) = 5.93 W/kg

**SAR(1 g) = 1.03 W/kg; SAR(10 g) = 0.223 W/kg**

Maximum value of SAR (measured) = 2.94 W/kg

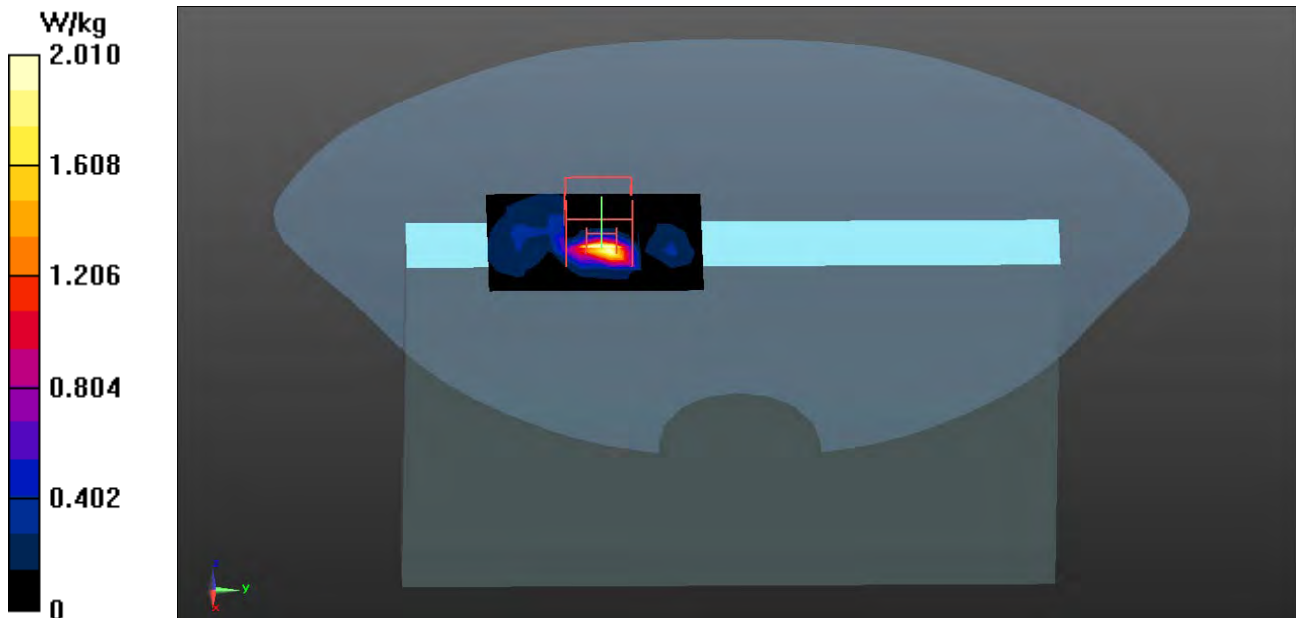

Test Laboratory: DEKRA

Date/Time: 2017/02/02

**802.11a\_64-Bottom-Main****DUT: DT317BT; Type: Mobile Tablet**

Communication System: UID 0, WLAN 5G; Frequency: 5320 MHz;

Communication System PAR: 0 dB

Medium parameters used:  $f = 5320$  MHz;  $\sigma = 5.42$  S/m;  $\epsilon_r = 48.81$ ;  $\rho = 1000$  kg/m<sup>3</sup>

Phantom section: Flat Section

Ambient Temperature (°C) : 21.9, Liquid Temperature (°C) : 20.5

Measurement Standard: DASY5 (IEEE/IEC/ANSI C63.19-2011)

DASY5 Configuration:

- Probe: EX3DV4 - SN3979; ConvF(4.55, 4.55, 4.55); Calibrated: 2016/11/25;
- Sensor-Surface: 1.4mm (Mechanical Surface Detection)
- Electronics: DAE4 Sn1425; Calibrated: 2016/11/18
- Phantom: SAM with right table; Type: SAM;
- Measurement SW: DASY52, Version 52.8 (8); SEMCAD X Version 14.6.10 (7373)

**Configuration/Body/Area Scan (6x8x1):** Measurement grid: dx=10mm, dy=10mm  
Maximum value of SAR (measured) = 2.02 W/kg**Configuration/Body/Zoom Scan (7x7x12) (7x7x12)/Cube 0:** Measurement grid:  
dx=4mm, dy=4mm, dz=2mm

Reference Value = 1.766 V/m; Power Drift = -0.14 dB

Peak SAR (extrapolated) = 5.91 W/kg

**SAR(1 g) = 1.03 W/kg; SAR(10 g) = 0.224 W/kg**

Maximum value of SAR (measured) = 2.91 W/kg

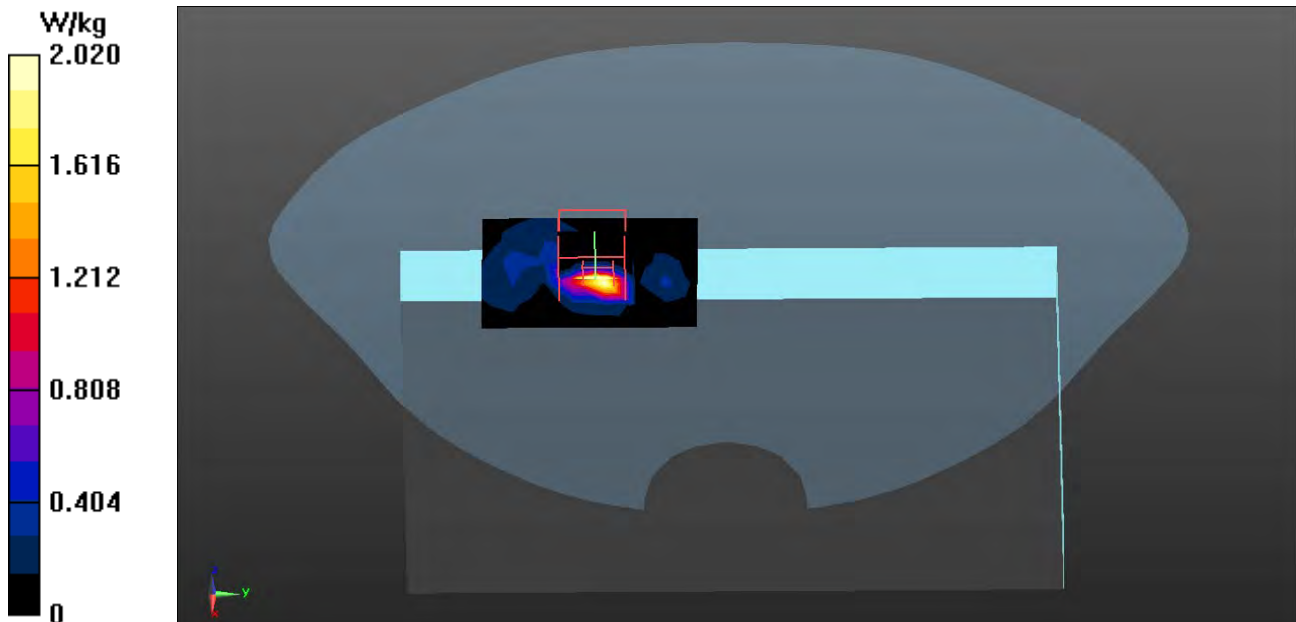

Test Laboratory: DEKRA

Date/Time: 2017/02/02

**802.11a\_149-Bottom-Main****DUT: DT317BT; Type: Mobile Tablet**

Communication System: UID 0, WLAN 5G; Frequency: 5745 MHz;

Communication System PAR: 0 dB

Medium parameters used:  $f = 5745$  MHz;  $\sigma = 6.06$  S/m;  $\epsilon_r = 47.67$ ;  $\rho = 1000$  kg/m<sup>3</sup>

Phantom section: Flat Section

Ambient Temperature (°C) : 21.9, Liquid Temperature (°C) : 20.5

Measurement Standard: DASYS (IEEE/IEC/ANSI C63.19-2011)

DASY5 Configuration:

- Probe: EX3DV4 - SN3979; ConvF(4.27, 4.27, 4.27); Calibrated: 2016/11/25;
- Sensor-Surface: 1.4mm (Mechanical Surface Detection)
- Electronics: DAE4 Sn1425; Calibrated: 2016/11/18
- Phantom: SAM with right table; Type: SAM;
- Measurement SW: DASYS2, Version 52.8 (8); SEMCAD X Version 14.6.10 (7373)

**Configuration/Body/Area Scan (6x23x1):** Measurement grid: dx=10mm, dy=10mm  
Maximum value of SAR (measured) = 1.99 W/kg**Configuration/Body/Zoom Scan (7x7x12) (7x7x12)/Cube 0:** Measurement grid:  
dx=4mm, dy=4mm, dz=2mm

Reference Value = 2.608 V/m; Power Drift = -0.16 dB

Peak SAR (extrapolated) = 6.76 W/kg

**SAR(1 g) = 1.13 W/kg; SAR(10 g) = 0.256 W/kg**

Maximum value of SAR (measured) = 3.40 W/kg

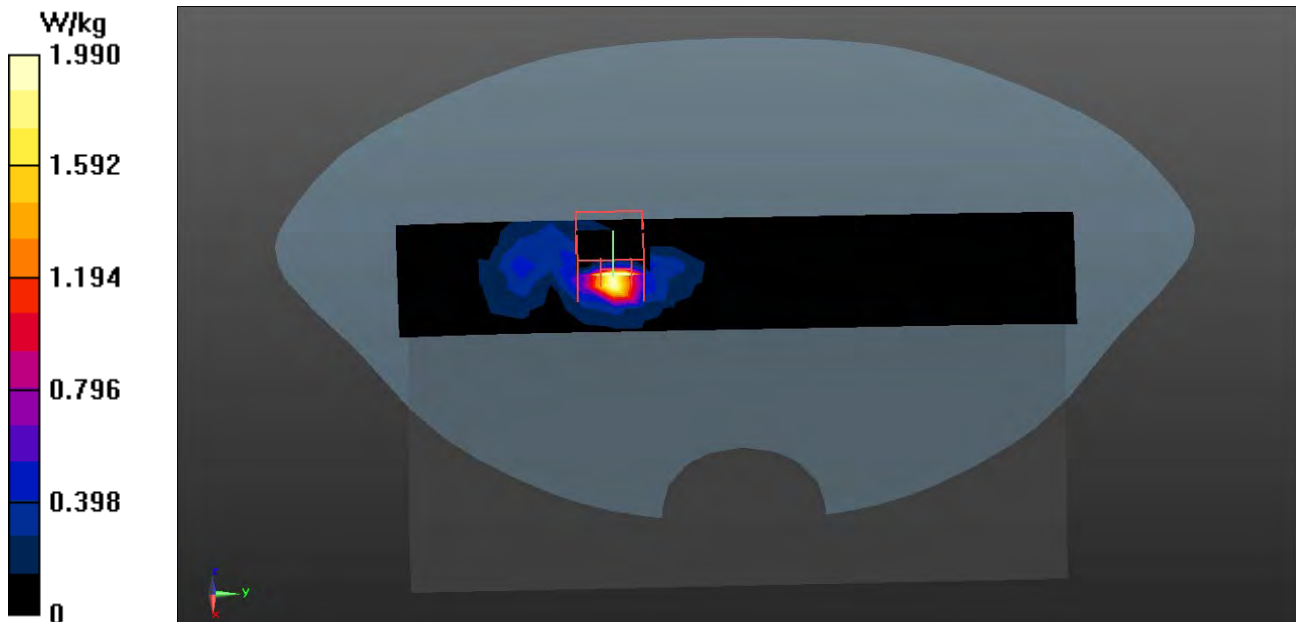

Test Laboratory: DEKRA

Date/Time: 2017/02/02

**802.11a\_157-Bottom-Main****DUT: DT317BT; Type: Mobile Tablet**

Communication System: UID 0, WLAN 5G; Frequency: 5785 MHz;

Communication System PAR: 0 dB

Medium parameters used:  $f = 5785$  MHz;  $\sigma = 6.13$  S/m;  $\epsilon_r = 47.57$ ;  $\rho = 1000$  kg/m<sup>3</sup>

Phantom section: Flat Section

Ambient Temperature (°C) : 21.9, Liquid Temperature (°C) : 20.5

Measurement Standard: DASY5 (IEEE/IEC/ANSI C63.19-2011)

DASY5 Configuration:

- Probe: EX3DV4 - SN3979; ConvF(4.27, 4.27, 4.27); Calibrated: 2016/11/25;
- Sensor-Surface: 1.4mm (Mechanical Surface Detection)
- Electronics: DAE4 Sn1425; Calibrated: 2016/11/18
- Phantom: SAM with right table; Type: SAM;
- Measurement SW: DASY52, Version 52.8 (8); SEMCAD X Version 14.6.10 (7373)

**Configuration/Body/Area Scan (6x8x1):** Measurement grid: dx=10mm, dy=10mm  
Maximum value of SAR (measured) = 2.13 W/kg**Configuration/Body/Zoom Scan (7x7x12) (7x7x12)/Cube 0:** Measurement grid:  
dx=4mm, dy=4mm, dz=2mm

Reference Value = 2.152 V/m; Power Drift = -0.06 dB

Peak SAR (extrapolated) = 6.31 W/kg

**SAR(1 g) = 1.05 W/kg; SAR(10 g) = 0.238 W/kg**

Maximum value of SAR (measured) = 3.02 W/kg

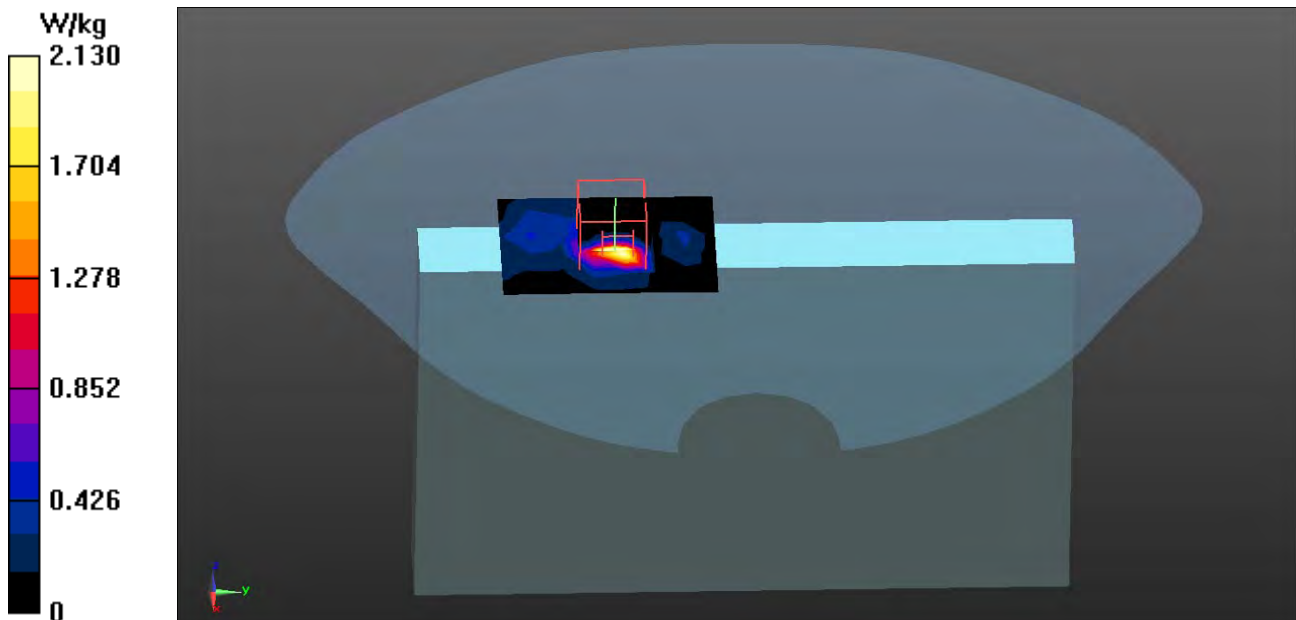

Test Laboratory: DEKRA

Date/Time: 2017/02/02

**802.11a\_165-Bottom-Main****DUT: DT317BT; Type: Mobile Tablet**

Communication System: UID 0, WLAN 5G; Frequency: 5825 MHz;

Communication System PAR: 0 dB

Medium parameters used:  $f = 5825$  MHz;  $\sigma = 6.19$  S/m;  $\epsilon_r = 47.48$ ;  $\rho = 1000$  kg/m<sup>3</sup>

Phantom section: Flat Section

Ambient Temperature (°C) : 21.9, Liquid Temperature (°C) : 20.5

Measurement Standard: DASY5 (IEEE/IEC/ANSI C63.19-2011)

DASY5 Configuration:

- Probe: EX3DV4 - SN3979; ConvF(4.27, 4.27, 4.27); Calibrated: 2016/11/25;
- Sensor-Surface: 1.4mm (Mechanical Surface Detection)
- Electronics: DAE4 Sn1425; Calibrated: 2016/11/18
- Phantom: SAM with right table; Type: SAM;
- Measurement SW: DASY52, Version 52.8 (8); SEMCAD X Version 14.6.10 (7373)

**Configuration/Body/Area Scan (6x8x1):** Measurement grid: dx=10mm, dy=10mm  
Maximum value of SAR (measured) = 2.16 W/kg**Configuration/Body/Zoom Scan (7x7x12) (7x7x12)/Cube 0:** Measurement grid:  
dx=4mm, dy=4mm, dz=2mm

Reference Value = 2.184 V/m; Power Drift = -0.11 dB

Peak SAR (extrapolated) = 6.19 W/kg

**SAR(1 g) = 1.02 W/kg; SAR(10 g) = 0.233 W/kg**

Maximum value of SAR (measured) = 2.94 W/kg

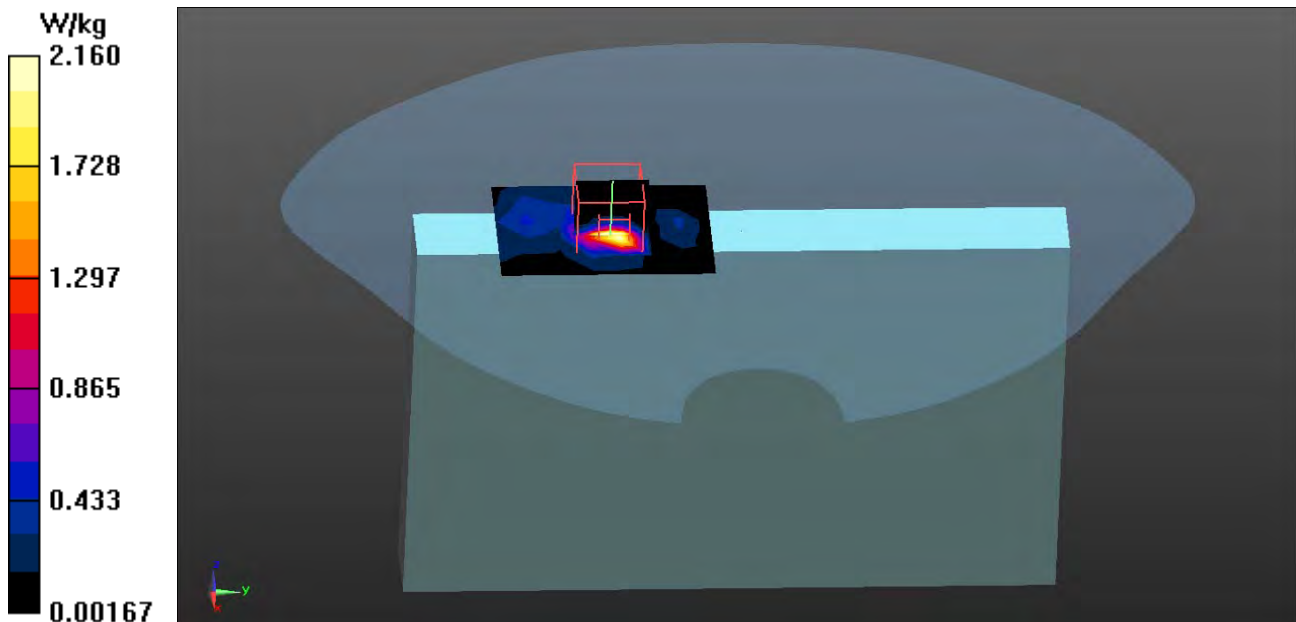

Test Laboratory: DEKRA

Date/Time: 2017/02/02

**802.11a\_52-Right-side-Main****DUT: DT317BT; Type: Mobile Tablet**

Communication System: UID 0, WLAN 5G; Frequency: 5260 MHz;

Communication System PAR: 0 dB

Medium parameters used:  $f = 5260$  MHz;  $\sigma = 5.33$  S/m;  $\epsilon_r = 48.96$ ;  $\rho = 1000$  kg/m<sup>3</sup>

Phantom section: Flat Section

Ambient Temperature (°C) : 21.9, Liquid Temperature (°C) : 20.5

Measurement Standard: DASY5 (IEEE/IEC/ANSI C63.19-2011)

DASY5 Configuration:

- Probe: EX3DV4 - SN3979; ConvF(4.55, 4.55, 4.55); Calibrated: 2016/11/25;
- Sensor-Surface: 1.4mm (Mechanical Surface Detection)
- Electronics: DAE4 Sn1425; Calibrated: 2016/11/18
- Phantom: SAM with right table; Type: SAM;
- Measurement SW: DASY52, Version 52.8 (8); SEMCAD X Version 14.6.10 (7373)

**Configuration/Body/Area Scan (6x10x1):** Measurement grid: dx=10mm, dy=10mm  
Maximum value of SAR (measured) = 0.311 W/kg**Configuration/Body/Zoom Scan (7x7x12) (7x7x12)/Cube 0:** Measurement grid:  
dx=4mm, dy=4mm, dz=2mm

Reference Value = 6.496 V/m; Power Drift = -0.07 dB

Peak SAR (extrapolated) = 0.509 W/kg

**SAR(1 g) = 0.118 W/kg; SAR(10 g) = 0.040 W/kg**

Maximum value of SAR (measured) = 0.302 W/kg

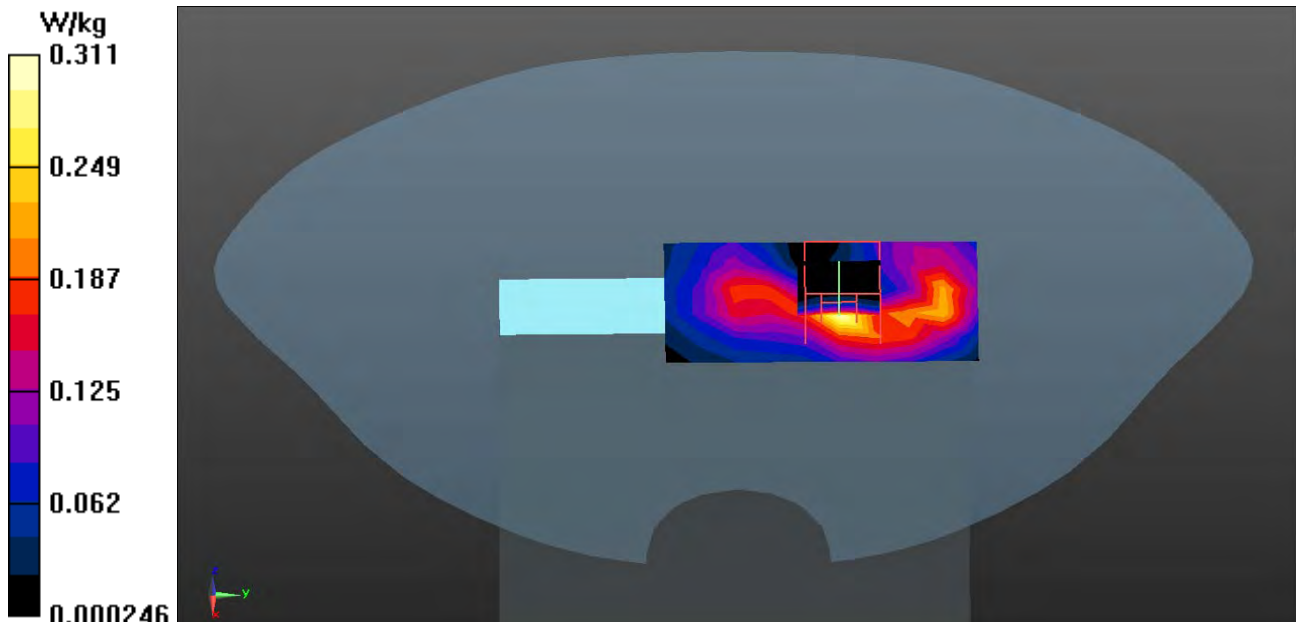

Test Laboratory: DEKRA

Date/Time: 2017/02/02

**802.11a\_149-Right-side-Main****DUT: DT317BT; Type: Mobile Tablet**

Communication System: UID 0, WLAN 5G; Frequency: 5745 MHz;

Communication System PAR: 0 dB

Medium parameters used:  $f = 5745$  MHz;  $\sigma = 6.06$  S/m;  $\epsilon_r = 47.67$ ;  $\rho = 1000$  kg/m<sup>3</sup>

Phantom section: Flat Section

Ambient Temperature (°C) : 21.9, Liquid Temperature (°C) : 20.5

Measurement Standard: DASYS (IEEE/IEC/ANSI C63.19-2011)

DASY5 Configuration:

- Probe: EX3DV4 - SN3979; ConvF(4.27, 4.27, 4.27); Calibrated: 2016/11/25;
- Sensor-Surface: 1.4mm (Mechanical Surface Detection)
- Electronics: DAE4 Sn1425; Calibrated: 2016/11/18
- Phantom: SAM with right table; Type: SAM;
- Measurement SW: DASYS2, Version 52.8 (8); SEMCAD X Version 14.6.10 (7373)

**Configuration/Body/Area Scan (6x15x1):** Measurement grid: dx=10mm, dy=10mm  
Maximum value of SAR (measured) = 0.157 W/kg**Configuration/Body/Zoom Scan (7x7x12) (7x7x12)/Cube 0:** Measurement grid:  
dx=4mm, dy=4mm, dz=2mm

Reference Value = 5.927 V/m; Power Drift = -0.13 dB

Peak SAR (extrapolated) = 0.509 W/kg

**SAR(1 g) = 0.064 W/kg; SAR(10 g) = 0.022 W/kg**

Maximum value of SAR (measured) = 0.167 W/kg

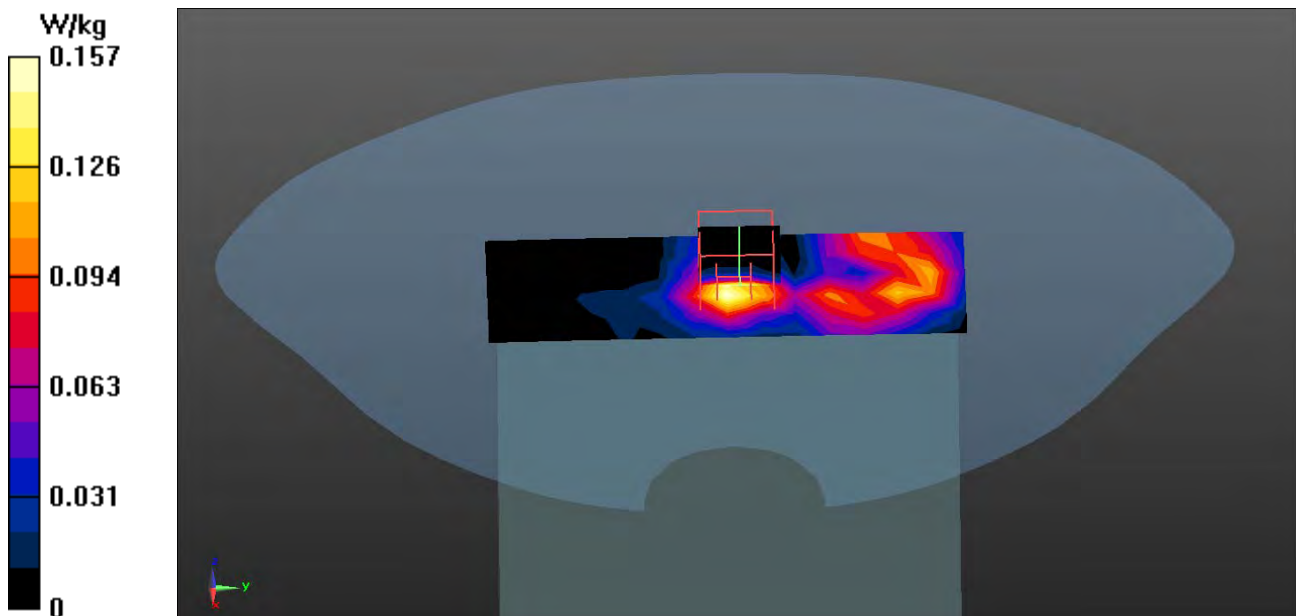



Test Laboratory: DEKRA

Date/Time: 2017/02/02

**802.11a\_60-Back-Aux****DUT: DT317BT; Type: Mobile Tablet**

Communication System: UID 0, WLAN 5G; Frequency: 5300 MHz;

Communication System PAR: 0 dB

Medium parameters used:  $f = 5300$  MHz;  $\sigma = 5.39$  S/m;  $\epsilon_r = 48.85$ ;  $\rho = 1000$  kg/m<sup>3</sup>

Phantom section: Flat Section

Ambient Temperature (°C) : 21.9, Liquid Temperature (°C) : 20.5

Measurement Standard: DASYS5 (IEEE/IEC/ANSI C63.19-2011)

DASY5 Configuration:

- Probe: EX3DV4 - SN3979; ConvF(4.55, 4.55, 4.55); Calibrated: 2016/11/25;
- Sensor-Surface: 1.4mm (Mechanical Surface Detection)
- Electronics: DAE4 Sn1425; Calibrated: 2016/11/18
- Phantom: SAM with right table; Type: SAM;
- Measurement SW: DASYS52, Version 52.8 (8); SEMCAD X Version 14.6.10 (7373)

**Configuration/Body/Area Scan (6x11x1):** Measurement grid: dx=10mm, dy=10mm  
Maximum value of SAR (measured) = 1.03 W/kg**Configuration/Body/Zoom Scan (7x7x12) (7x7x12)/Cube 0:** Measurement grid:  
dx=4mm, dy=4mm, dz=2mm

Reference Value = 5.816 V/m; Power Drift = 0.19 dB

Peak SAR (extrapolated) = 2.13 W/kg

**SAR(1 g) = 0.471 W/kg; SAR(10 g) = 0.177 W/kg**

Maximum value of SAR (measured) = 1.13 W/kg

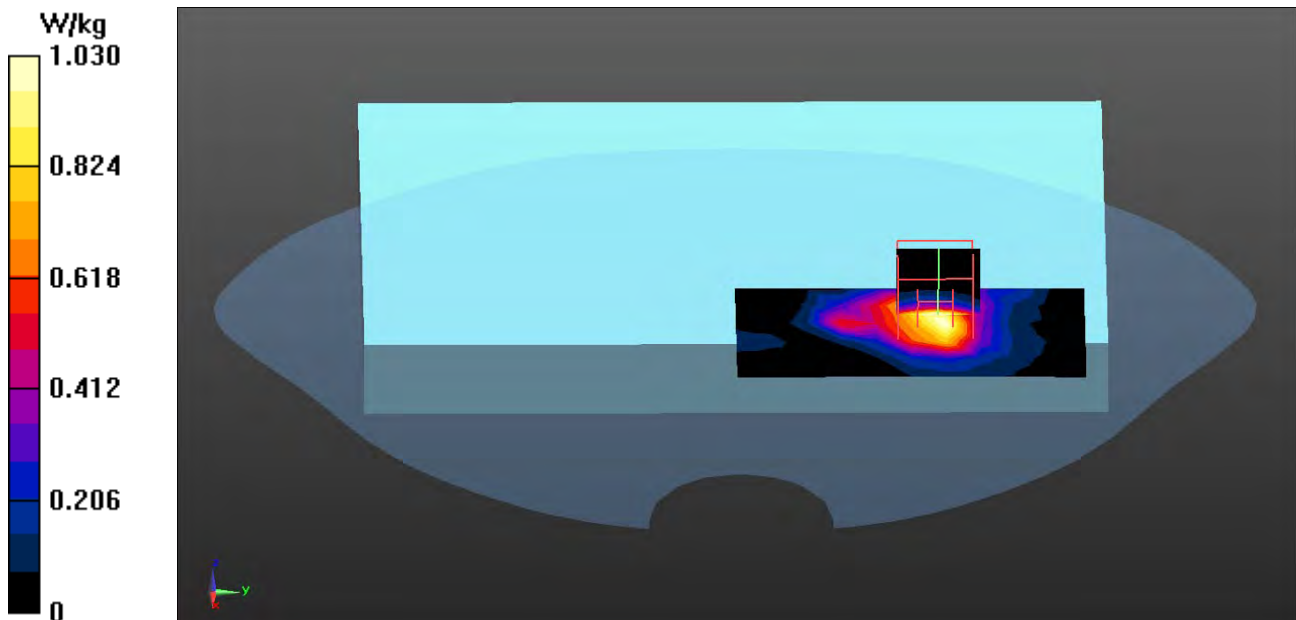

Test Laboratory: DEKRA

Date/Time: 2017/02/02

**802.11a\_165-Back-Aux****DUT: DT317BT; Type: Mobile Tablet**

Communication System: UID 0, WLAN 5G; Frequency: 5825 MHz;

Communication System PAR: 0 dB

Medium parameters used:  $f = 5825$  MHz;  $\sigma = 6.19$  S/m;  $\epsilon_r = 47.48$ ;  $\rho = 1000$  kg/m<sup>3</sup>

Phantom section: Flat Section

Ambient Temperature (°C) : 21.9, Liquid Temperature (°C) : 20.5

Measurement Standard: DASY5 (IEEE/IEC/ANSI C63.19-2011)

DASY5 Configuration:

- Probe: EX3DV4 - SN3979; ConvF(4.27, 4.27, 4.27); Calibrated: 2016/11/25;
- Sensor-Surface: 1.4mm (Mechanical Surface Detection)
- Electronics: DAE4 Sn1425; Calibrated: 2016/11/18
- Phantom: SAM with right table; Type: SAM;
- Measurement SW: DASY52, Version 52.8 (8); SEMCAD X Version 14.6.10 (7373)

**Configuration/Body/Area Scan (6x23x1):** Measurement grid: dx=10mm, dy=10mm  
Maximum value of SAR (measured) = 1.43 W/kg**Configuration/Body/Zoom Scan (7x7x12) (7x7x12)/Cube 0:** Measurement grid:  
dx=4mm, dy=4mm, dz=2mm

Reference Value = 6.484 V/m; Power Drift = -0.09 dB

Peak SAR (extrapolated) = 3.16 W/kg

**SAR(1 g) = 0.649 W/kg; SAR(10 g) = 0.225 W/kg**

Maximum value of SAR (measured) = 1.65 W/kg

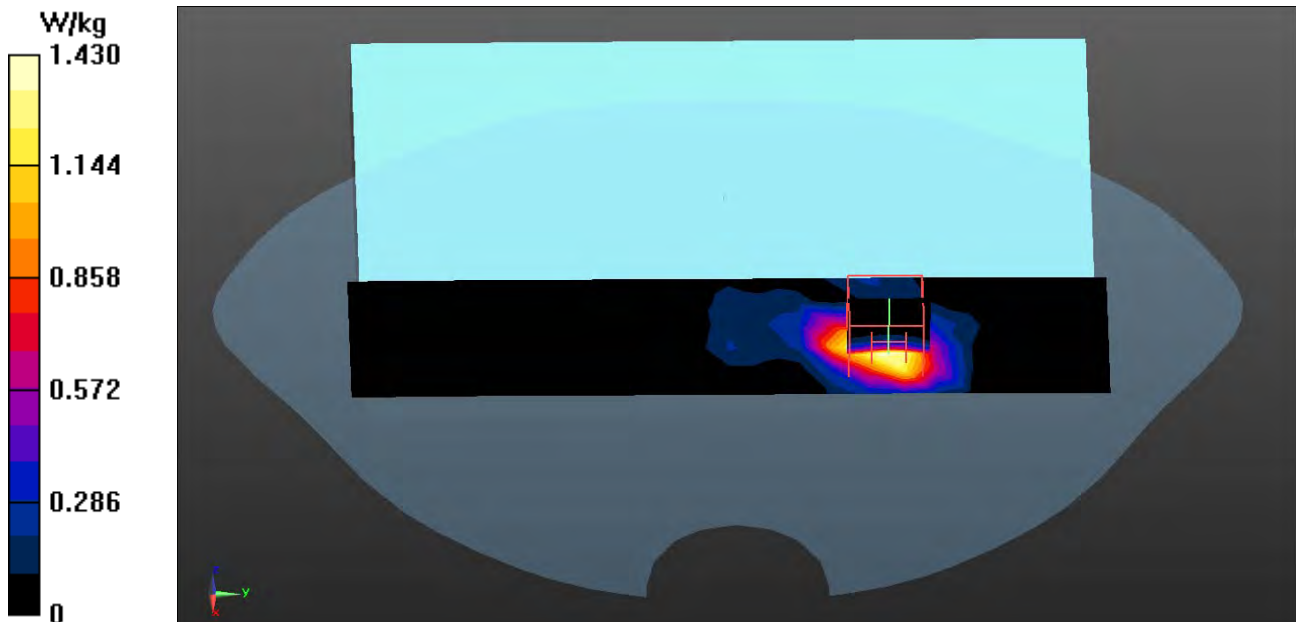

Test Laboratory: DEKRA

Date/Time: 2017/02/02

**802.11a\_36-Top-Aux****DUT: DT317BT; Type: Mobile Tablet**

Communication System: UID 0, WLAN 5G; Frequency: 5180 MHz;

Communication System PAR: 0 dB

Medium parameters used:  $f = 5180$  MHz;  $\sigma = 5.21$  S/m;  $\epsilon_r = 49.18$ ;  $\rho = 1000$  kg/m<sup>3</sup>

Phantom section: Flat Section

Ambient Temperature (°C) : 21.9, Liquid Temperature (°C) : 20.5

Measurement Standard: DASYS (IEEE/IEC/ANSI C63.19-2011)

DASY5 Configuration:

- Probe: EX3DV4 - SN3979; ConvF(4.75, 4.75, 4.75); Calibrated: 2016/11/25;
- Sensor-Surface: 1.4mm (Mechanical Surface Detection)
- Electronics: DAE4 Sn1425; Calibrated: 2016/11/18
- Phantom: SAM with right table; Type: SAM;
- Measurement SW: DASYS2, Version 52.8 (8); SEMCAD X Version 14.6.10 (7373)

**Configuration/Body/Area Scan (6x10x1):** Measurement grid: dx=10mm, dy=10mm  
Maximum value of SAR (measured) = 1.44 W/kg

**Configuration/Body/Zoom Scan (7x7x12) (7x7x12)/Cube 0:** Measurement grid:  
dx=4mm, dy=4mm, dz=2mm  
Reference Value = 5.015 V/m; Power Drift = -0.11 dB  
Peak SAR (extrapolated) = 4.43 W/kg  
**SAR(1 g) = 0.845 W/kg; SAR(10 g) = 0.259 W/kg**  
Maximum value of SAR (measured) = 2.28 W/kg

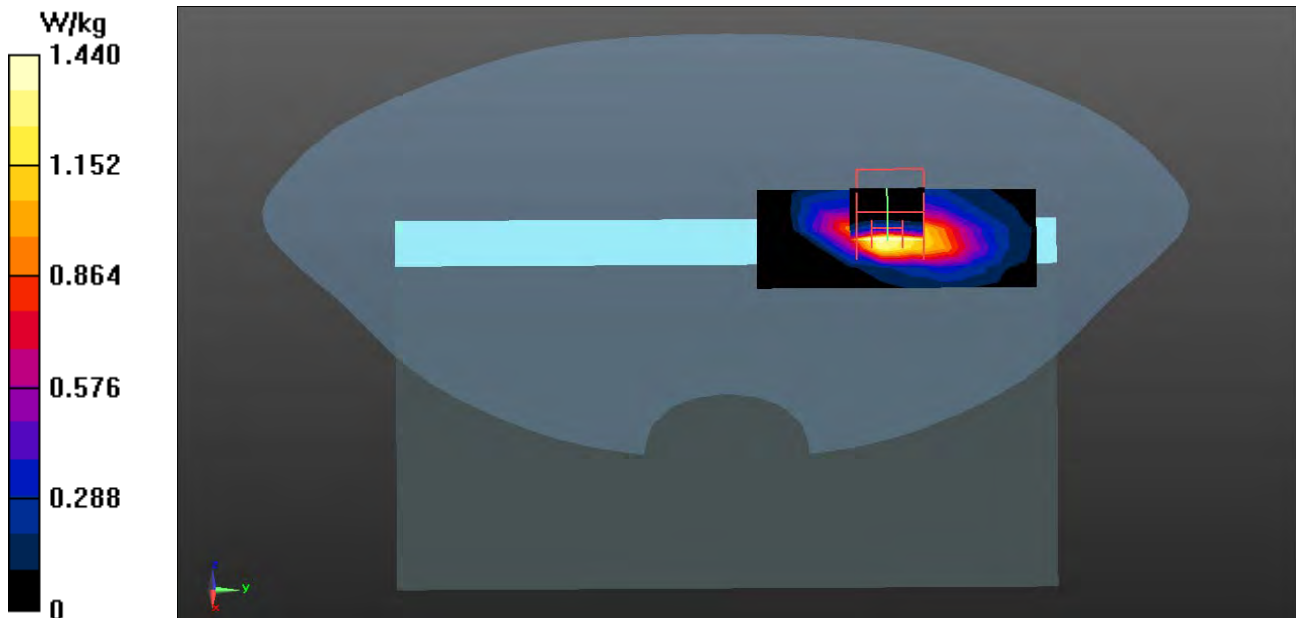

Test Laboratory: DEKRA

Date/Time: 2017/02/02

**802.11a\_44-Top-Aux****DUT: DT317BT; Type: Mobile Tablet**

Communication System: UID 0, WLAN 5G; Frequency: 5220 MHz;

Communication System PAR: 0 dB

Medium parameters used:  $f = 5220$  MHz;  $\sigma = 5.27$  S/m;  $\epsilon_r = 49.07$ ;  $\rho = 1000$  kg/m<sup>3</sup>

Phantom section: Flat Section

Ambient Temperature (°C) : 21.9, Liquid Temperature (°C) : 20.5

Measurement Standard: DASYS (IEEE/IEC/ANSI C63.19-2011)

DASY5 Configuration:

- Probe: EX3DV4 - SN3979; ConvF(4.75, 4.75, 4.75); Calibrated: 2016/11/25;
- Sensor-Surface: 1.4mm (Mechanical Surface Detection)
- Electronics: DAE4 Sn1425; Calibrated: 2016/11/18
- Phantom: SAM with right table; Type: SAM;
- Measurement SW: DASYS2, Version 52.8 (8); SEMCAD X Version 14.6.10 (7373)

**Configuration/Body/Area Scan (6x10x1):** Measurement grid: dx=10mm, dy=10mm  
Maximum value of SAR (measured) = 1.47 W/kg

**Configuration/Body/Zoom Scan (7x7x12) (7x7x12)/Cube 0:** Measurement grid:  
dx=4mm, dy=4mm, dz=2mm  
Reference Value = 5.675 V/m; Power Drift = -0.18 dB  
Peak SAR (extrapolated) = 3.81 W/kg  
**SAR(1 g) = 0.743 W/kg; SAR(10 g) = 0.233 W/kg**  
Maximum value of SAR (measured) = 2.03 W/kg

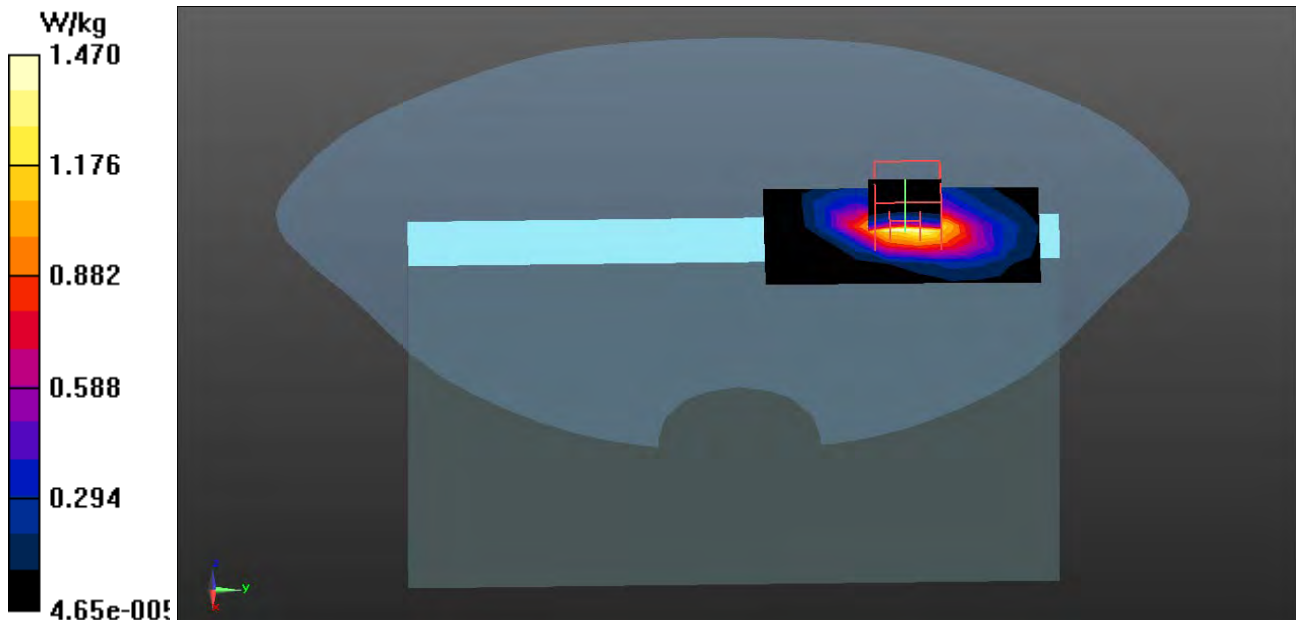

Test Laboratory: DEKRA

Date/Time: 2017/02/02

**802.11a\_48-Top-Aux****DUT: DT317BT; Type: Mobile Tablet**

Communication System: UID 0, WLAN 5G; Frequency: 5240 MHz;

Communication System PAR: 0 dB

Medium parameters used:  $f = 5240$  MHz;  $\sigma = 5.3$  S/m;  $\epsilon_r = 49.01$ ;  $\rho = 1000$  kg/m<sup>3</sup>

Phantom section: Flat Section

Ambient Temperature (°C) : 21.9, Liquid Temperature (°C) : 20.5

Measurement Standard: DASYS5 (IEEE/IEC/ANSI C63.19-2011)

DASY5 Configuration:

- Probe: EX3DV4 - SN3979; ConvF(4.75, 4.75, 4.75); Calibrated: 2016/11/25;
- Sensor-Surface: 1.4mm (Mechanical Surface Detection)
- Electronics: DAE4 Sn1425; Calibrated: 2016/11/18
- Phantom: SAM with right table; Type: SAM;
- Measurement SW: DASY52, Version 52.8 (8); SEMCAD X Version 14.6.10 (7373)

**Configuration/Body/Area Scan (6x10x1):** Measurement grid: dx=10mm, dy=10mm  
Maximum value of SAR (measured) = 1.45 W/kg

**Configuration/Body/Zoom Scan (7x7x12) (7x7x12)/Cube 0:** Measurement grid:  
dx=4mm, dy=4mm, dz=2mm  
Reference Value = 5.599 V/m; Power Drift = 0.17 dB  
Peak SAR (extrapolated) = 3.67 W/kg  
**SAR(1 g) = 0.718 W/kg; SAR(10 g) = 0.228 W/kg**  
Maximum value of SAR (measured) = 1.95 W/kg

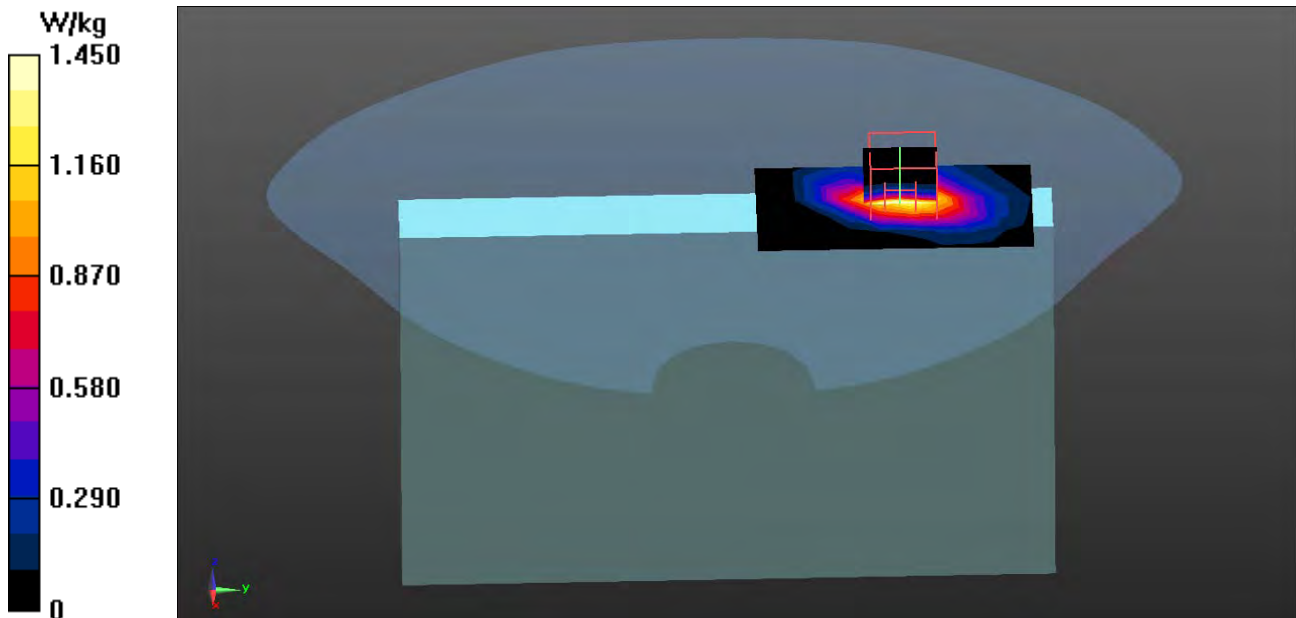

Test Laboratory: DEKRA

Date/Time: 2017/02/02

**802.11a\_60-Top-Aux****DUT: DT317BT; Type: Mobile Tablet**

Communication System: UID 0, WLAN 5G; Frequency: 5300 MHz;

Communication System PAR: 0 dB

Medium parameters used:  $f = 5300$  MHz;  $\sigma = 5.39$  S/m;  $\epsilon_r = 48.85$ ;  $\rho = 1000$  kg/m<sup>3</sup>

Phantom section: Flat Section

Ambient Temperature (°C) : 21.9, Liquid Temperature (°C) : 20.5

Measurement Standard: DASY5 (IEEE/IEC/ANSI C63.19-2011)

DASY5 Configuration:

- Probe: EX3DV4 - SN3979; ConvF(4.55, 4.55, 4.55); Calibrated: 2016/11/25;
- Sensor-Surface: 1.4mm (Mechanical Surface Detection)
- Electronics: DAE4 Sn1425; Calibrated: 2016/11/18
- Phantom: SAM with right table; Type: SAM;
- Measurement SW: DASY52, Version 52.8 (8); SEMCAD X Version 14.6.10 (7373)

**Configuration/Body/Area Scan (6x10x1):** Measurement grid: dx=10mm, dy=10mm  
Maximum value of SAR (measured) = 1.36 W/kg**Configuration/Body/Zoom Scan (7x7x12) (7x7x12)/Cube 0:** Measurement grid:  
dx=4mm, dy=4mm, dz=2mm

Reference Value = 5.167 V/m; Power Drift = -0.15 dB

Peak SAR (extrapolated) = 3.63 W/kg

**SAR(1 g) = 0.676 W/kg; SAR(10 g) = 0.213 W/kg**

Maximum value of SAR (measured) = 1.83 W/kg

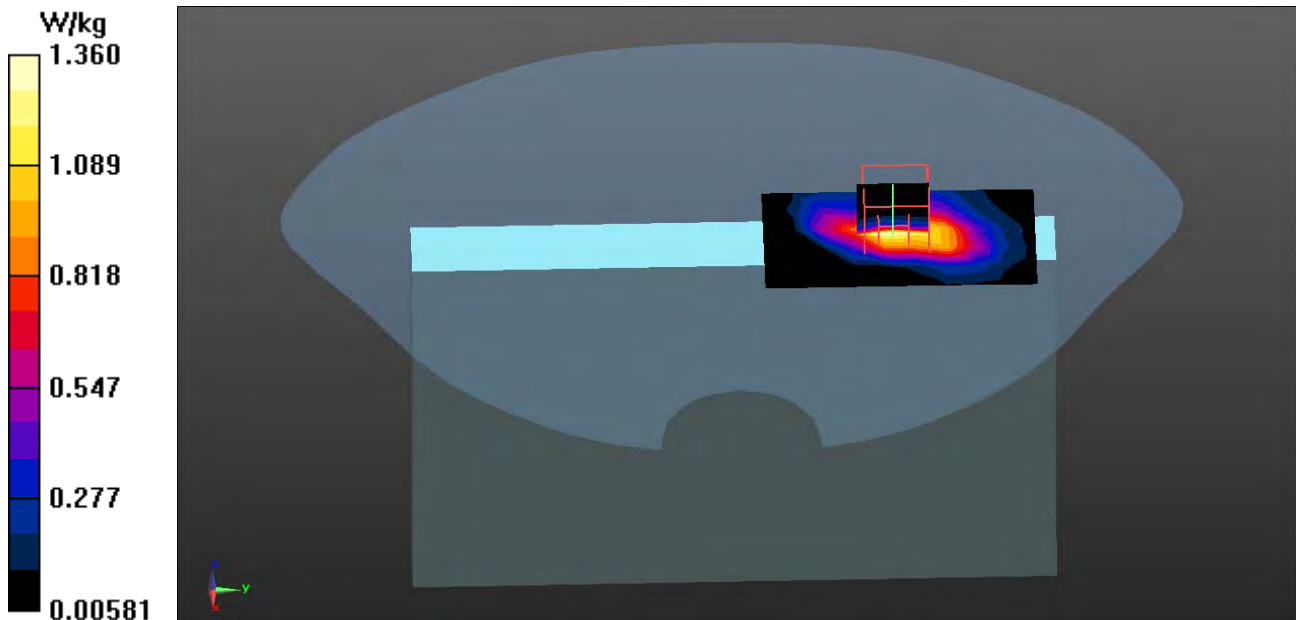

Test Laboratory: DEKRA

Date/Time: 2017/02/02

**802.11a\_149-Top-Aux****DUT: DT317BT; Type: Mobile Tablet**

Communication System: UID 0, WLAN 5G; Frequency: 5745 MHz;

Communication System PAR: 0 dB

Medium parameters used:  $f = 5745$  MHz;  $\sigma = 6.06$  S/m;  $\epsilon_r = 47.67$ ;  $\rho = 1000$  kg/m<sup>3</sup>

Phantom section: Flat Section

Ambient Temperature (°C) : 21.9, Liquid Temperature (°C) : 20.5

Measurement Standard: DASYS (IEEE/IEC/ANSI C63.19-2011)

DASY5 Configuration:

- Probe: EX3DV4 - SN3979; ConvF(4.27, 4.27, 4.27); Calibrated: 2016/11/25;
- Sensor-Surface: 1.4mm (Mechanical Surface Detection)
- Electronics: DAE4 Sn1425; Calibrated: 2016/11/18
- Phantom: SAM with right table; Type: SAM;
- Measurement SW: DASYS2, Version 52.8 (8); SEMCAD X Version 14.6.10 (7373)

**Configuration/Body/Area Scan (6x10x1):** Measurement grid: dx=10mm, dy=10mm  
Maximum value of SAR (measured) = 1.86 W/kg

**Configuration/Body/Zoom Scan (7x7x12) (7x7x12)/Cube 0:** Measurement grid:  
dx=4mm, dy=4mm, dz=2mm

Reference Value = 2.513 V/m; Power Drift = 0.17 dB

Peak SAR (extrapolated) = 5.14 W/kg

**SAR(1 g) = 0.891 W/kg; SAR(10 g) = 0.233 W/kg**

Maximum value of SAR (measured) = 2.53 W/kg

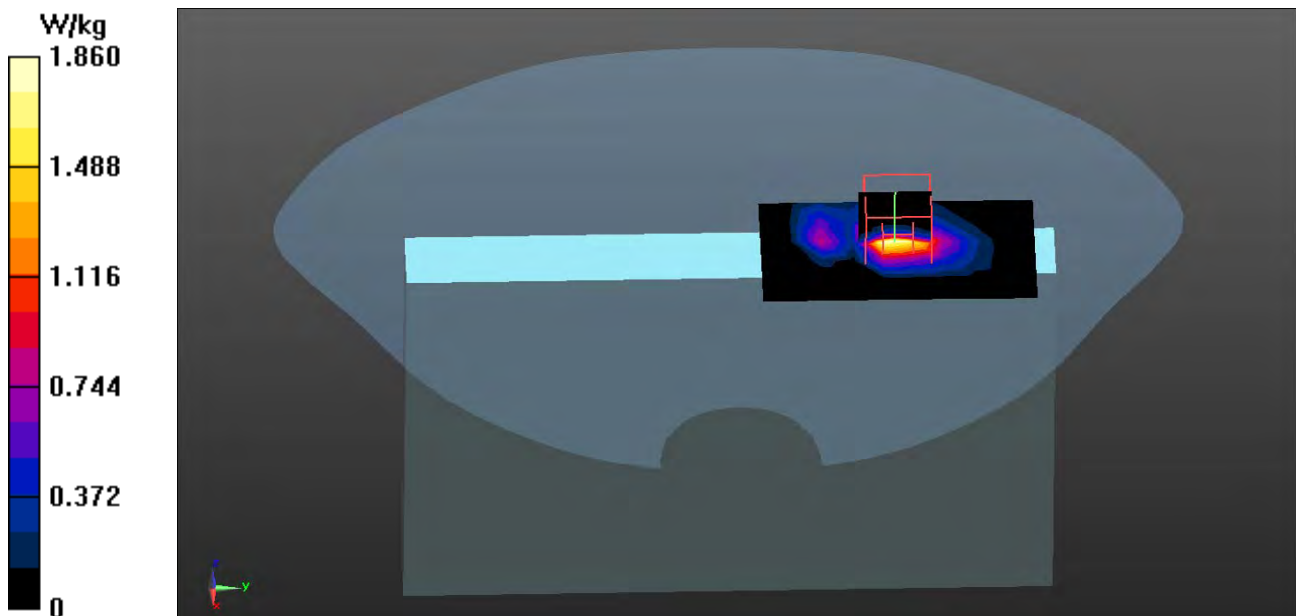

Test Laboratory: DEKRA

Date/Time: 2017/02/02

**802.11a\_157-Top-Aux****DUT: DT317BT; Type: Mobile Tablet**

Communication System: UID 0, WLAN 5G; Frequency: 5785 MHz;

Communication System PAR: 0 dB

Medium parameters used:  $f = 5785$  MHz;  $\sigma = 6.13$  S/m;  $\epsilon_r = 47.57$ ;  $\rho = 1000$  kg/m<sup>3</sup>

Phantom section: Flat Section

Ambient Temperature (°C) : 21.9, Liquid Temperature (°C) : 20.5

Measurement Standard: DASYS5 (IEEE/IEC/ANSI C63.19-2011)

DASY5 Configuration:

- Probe: EX3DV4 - SN3979; ConvF(4.27, 4.27, 4.27); Calibrated: 2016/11/25;
- Sensor-Surface: 1.4mm (Mechanical Surface Detection)
- Electronics: DAE4 Sn1425; Calibrated: 2016/11/18
- Phantom: SAM with right table; Type: SAM;
- Measurement SW: DASYS52, Version 52.8 (8); SEMCAD X Version 14.6.10 (7373)

**Configuration/Body/Area Scan (6x10x1):** Measurement grid: dx=10mm, dy=10mm  
Maximum value of SAR (measured) = 2.02 W/kg**Configuration/Body/Zoom Scan (7x7x12) (7x7x12)/Cube 0:** Measurement grid:  
dx=4mm, dy=4mm, dz=2mm

Reference Value = 1.957 V/m; Power Drift = 0.15 dB

Peak SAR (extrapolated) = 5.60 W/kg

**SAR(1 g) = 0.960 W/kg; SAR(10 g) = 0.246 W/kg**

Maximum value of SAR (measured) = 2.68 W/kg

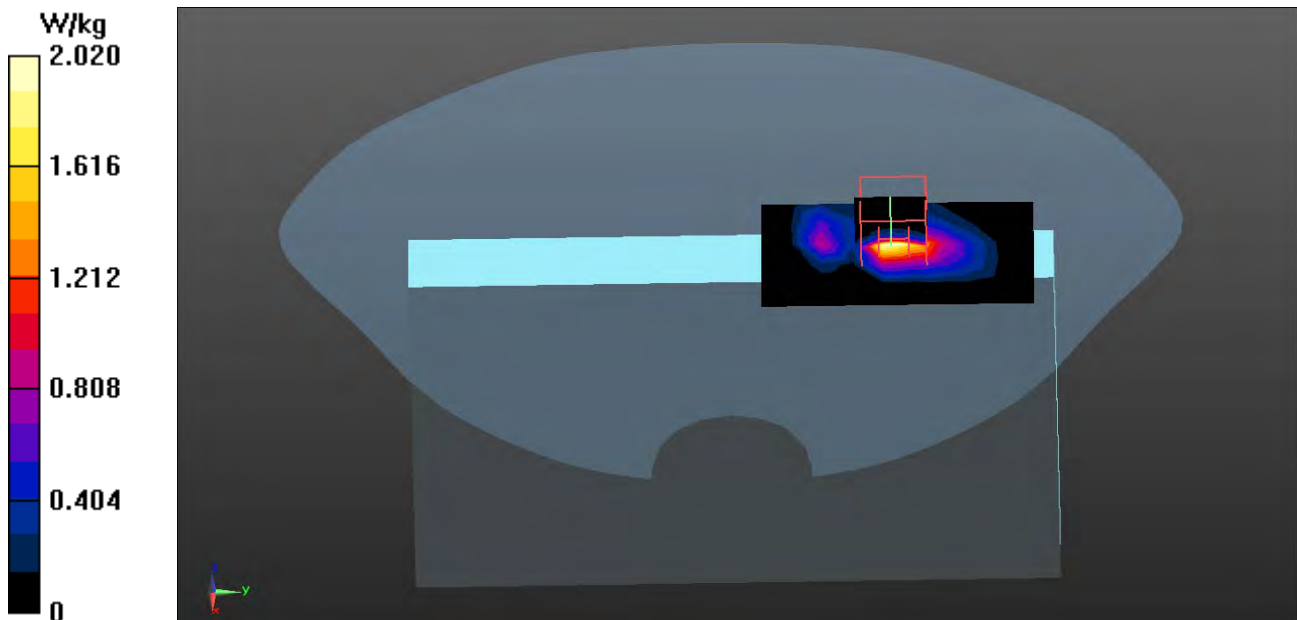



Test Laboratory: DEKRA

Date/Time: 2017/02/02

**802.11a\_165-Top-Aux****DUT: DT317BT; Type: Mobile Tablet**

Communication System: UID 0, WLAN 5G; Frequency: 5825 MHz;

Communication System PAR: 0 dB

Medium parameters used:  $f = 5825$  MHz;  $\sigma = 6.19$  S/m;  $\epsilon_r = 47.48$ ;  $\rho = 1000$  kg/m<sup>3</sup>

Phantom section: Flat Section

Ambient Temperature (°C) : 21.9, Liquid Temperature (°C) : 20.5

Measurement Standard: DASYS5 (IEEE/IEC/ANSI C63.19-2011)

DASY5 Configuration:

- Probe: EX3DV4 - SN3979; ConvF(4.27, 4.27, 4.27); Calibrated: 2016/11/25;
- Sensor-Surface: 1.4mm (Mechanical Surface Detection)
- Electronics: DAE4 Sn1425; Calibrated: 2016/11/18
- Phantom: SAM with right table; Type: SAM;
- Measurement SW: DASYS52, Version 52.8 (8); SEMCAD X Version 14.6.10 (7373)

**Configuration/Body/Area Scan (6x23x1):** Measurement grid: dx=10mm, dy=10mm  
Maximum value of SAR (measured) = 2.66 W/kg**Configuration/Body/Zoom Scan (7x7x12) (7x7x12)/Cube 0:** Measurement grid:  
dx=4mm, dy=4mm, dz=2mm

Reference Value = 1.544 V/m; Power Drift = 0.08 dB

Peak SAR (extrapolated) = 6.41 W/kg

**SAR(1 g) = 1.07 W/kg; SAR(10 g) = 0.284 W/kg**

Maximum value of SAR (measured) = 2.99 W/kg

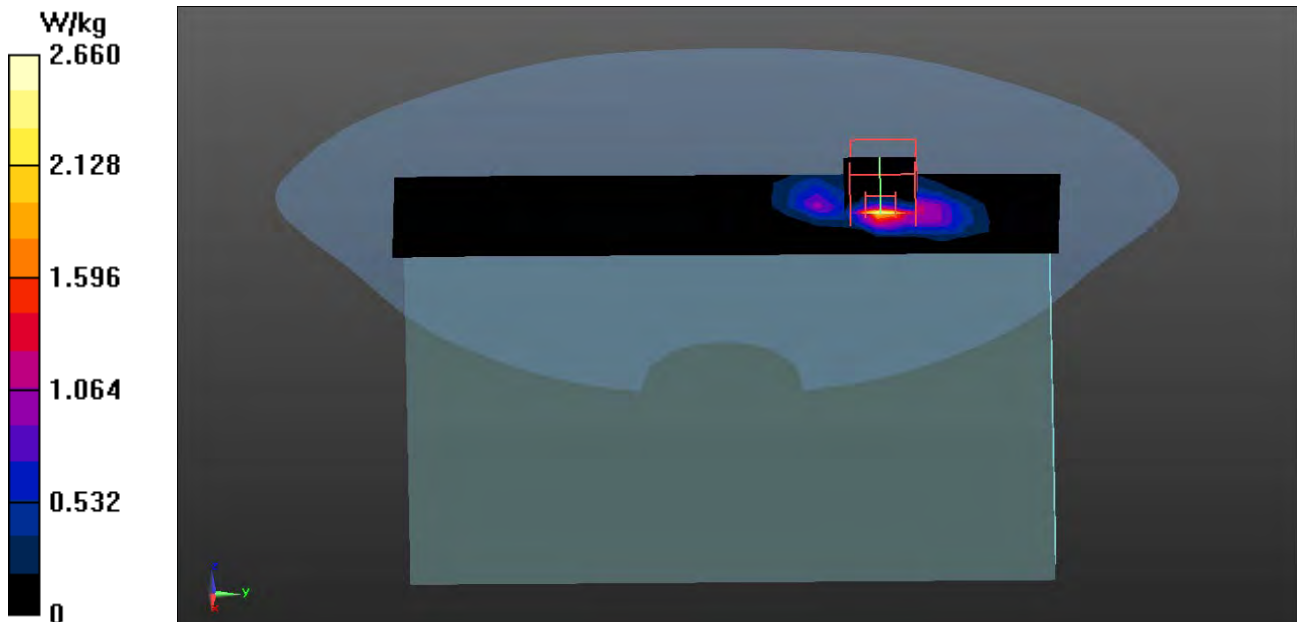

Test Laboratory: DEKRA

Date/Time: 2017/02/02

**802.11a\_60-Right-side-Aux****DUT: DT317BT; Type: Mobile Tablet**

Communication System: UID 0, WLAN 5G; Frequency: 5300 MHz;

Communication System PAR: 0 dB

Medium parameters used:  $f = 5300$  MHz;  $\sigma = 5.39$  S/m;  $\epsilon_r = 48.85$ ;  $\rho = 1000$  kg/m<sup>3</sup>

Phantom section: Flat Section

Ambient Temperature (°C) : 21.9, Liquid Temperature (°C) : 20.5

Measurement Standard: DASY5 (IEEE/IEC/ANSI C63.19-2011)

DASY5 Configuration:

- Probe: EX3DV4 - SN3979; ConvF(4.55, 4.55, 4.55); Calibrated: 2016/11/25;
- Sensor-Surface: 1.4mm (Mechanical Surface Detection)
- Electronics: DAE4 Sn1425; Calibrated: 2016/11/18
- Phantom: SAM with right table; Type: SAM;
- Measurement SW: DASY52, Version 52.8 (8); SEMCAD X Version 14.6.10 (7373)

**Configuration/Body/Area Scan (6x8x1):** Measurement grid: dx=10mm, dy=10mm  
Maximum value of SAR (measured) = 0.202 W/kg**Configuration/Body/Zoom Scan (7x7x12) (7x7x12)/Cube 0:** Measurement grid:  
dx=4mm, dy=4mm, dz=2mm

Reference Value = 4.222 V/m; Power Drift = 0.06 dB

Peak SAR (extrapolated) = 0.423 W/kg

**SAR(1 g) = 0.096 W/kg; SAR(10 g) = 0.034 W/kg**

Maximum value of SAR (measured) = 0.241 W/kg

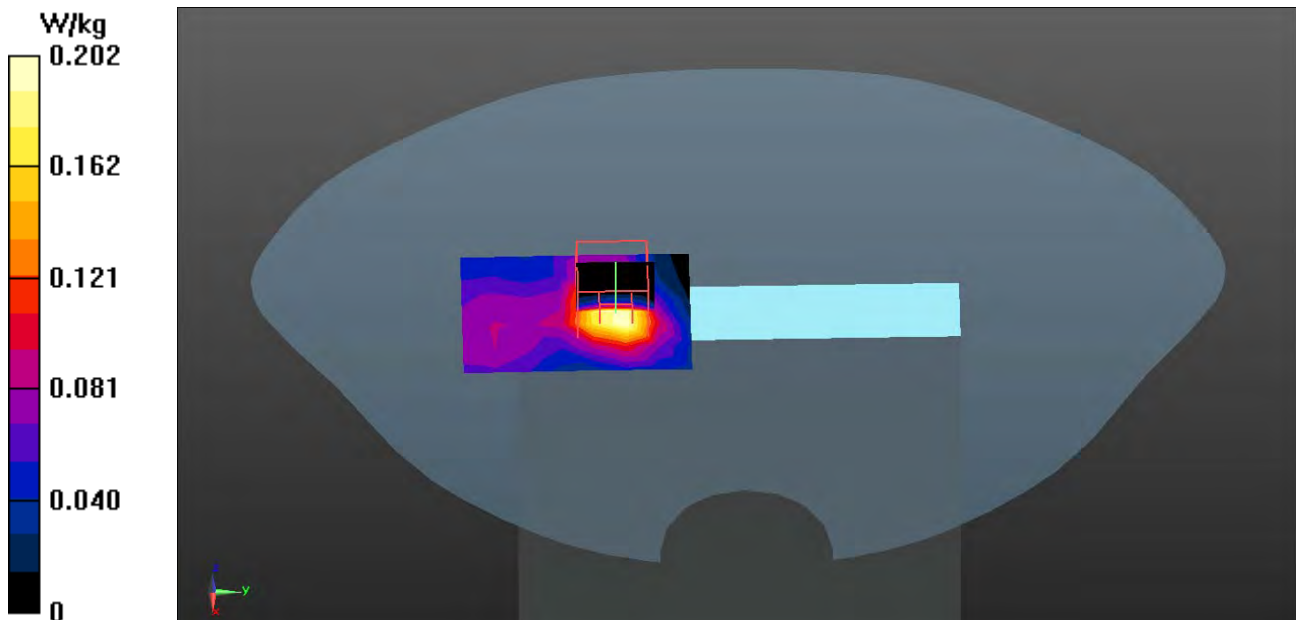

Test Laboratory: DEKRA

Date/Time: 2017/02/02

**802.11a\_165-Right-side-Aux****DUT: DT317BT; Type: Mobile Tablet**

Communication System: UID 0, WLAN 5G; Frequency: 5825 MHz;

Communication System PAR: 0 dB

Medium parameters used:  $f = 5825$  MHz;  $\sigma = 6.19$  S/m;  $\epsilon_r = 47.48$ ;  $\rho = 1000$  kg/m<sup>3</sup>

Phantom section: Flat Section

Ambient Temperature (°C) : 21.9, Liquid Temperature (°C) : 20.5

Measurement Standard: DASY5 (IEEE/IEC/ANSI C63.19-2011)

DASY5 Configuration:

- Probe: EX3DV4 - SN3979; ConvF(4.27, 4.27, 4.27); Calibrated: 2016/11/25;
- Sensor-Surface: 1.4mm (Mechanical Surface Detection)
- Electronics: DAE4 Sn1425; Calibrated: 2016/11/18
- Phantom: SAM with right table; Type: SAM;
- Measurement SW: DASY52, Version 52.8 (8); SEMCAD X Version 14.6.10 (7373)

**Configuration/Body/Area Scan (6x15x1):** Measurement grid: dx=10mm, dy=10mm  
Maximum value of SAR (measured) = 0.0362 W/kg**Configuration/Body/Zoom Scan (7x7x12) (7x7x12)/Cube 0:** Measurement grid:  
dx=4mm, dy=4mm, dz=2mm

Reference Value = 1.083 V/m; Power Drift = 0.12 dB

Peak SAR (extrapolated) = 0.161 W/kg

**SAR(1 g) = 0.012 W/kg; SAR(10 g) = 0.00398 W/kg**

Maximum value of SAR (measured) = 0.0356 W/kg

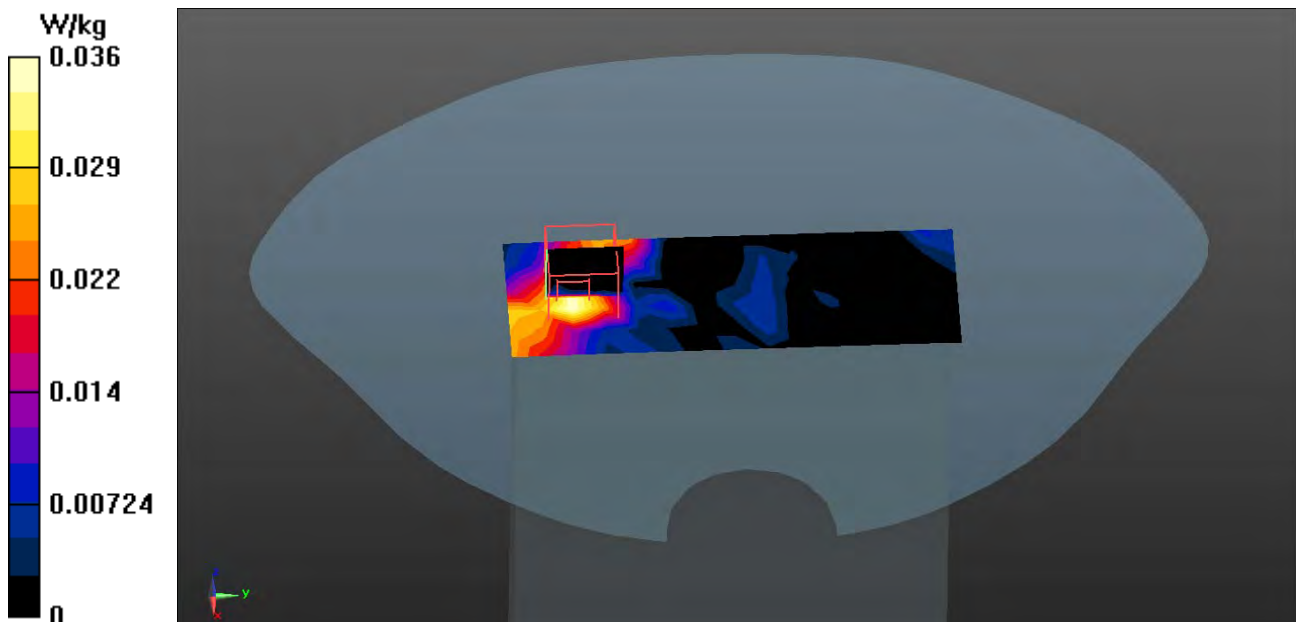

**802.11a EUT (Main Antenna) Bottom, Z-Axis plot**  
**Channel: 48**

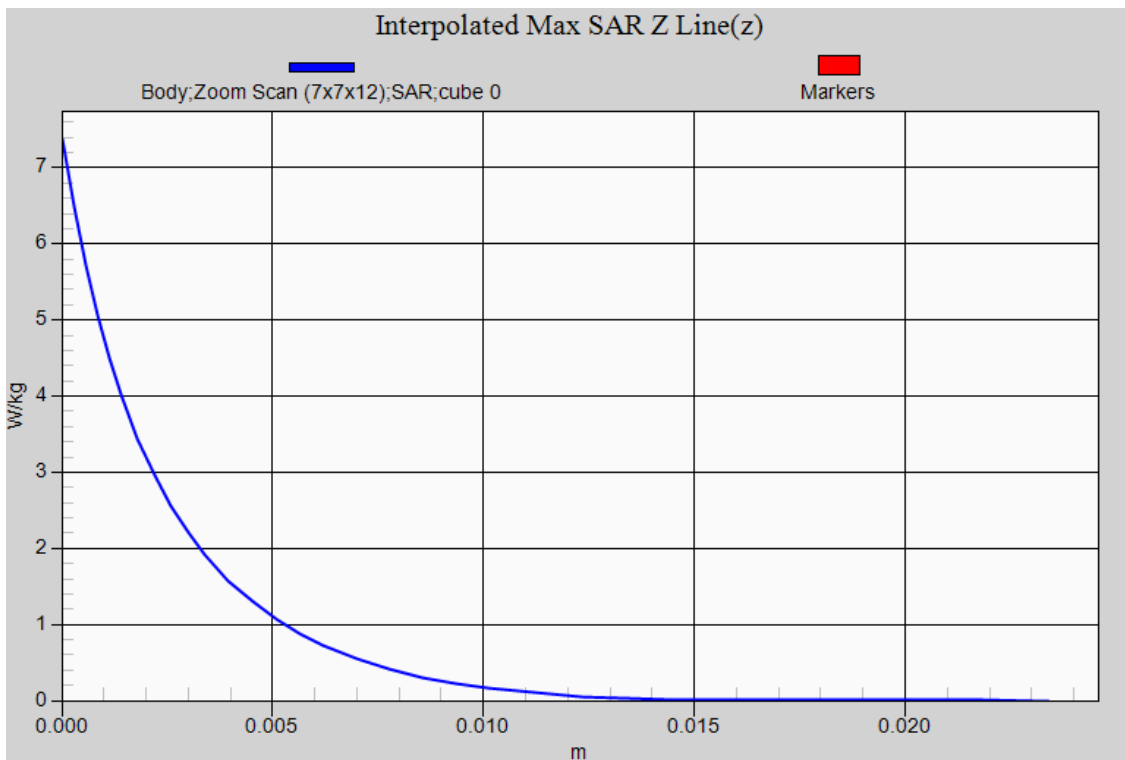

Test Laboratory: DEKRA

Date/Time: 2017/02/02

**802.11a\_48-Bottom-Main****DUT: DT317BT; Type: Mobile Tablet**

Communication System: UID 0, WLAN 5G; Frequency: 5240 MHz;

Communication System PAR: 0 dB

Medium parameters used:  $f = 5240$  MHz;  $\sigma = 5.3$  S/m;  $\epsilon_r = 49.01$ ;  $\rho = 1000$  kg/m<sup>3</sup>

Phantom section: Flat Section

Ambient Temperature (°C) : 21.9, Liquid Temperature (°C) : 20.5

Measurement Standard: DASYS5 (IEEE/IEC/ANSI C63.19-2011)

DASY5 Configuration:

- Probe: EX3DV4 - SN3979; ConvF(4.75, 4.75, 4.75); Calibrated: 2016/11/25;
- Sensor-Surface: 1.4mm (Mechanical Surface Detection)
- Electronics: DAE4 Sn1425; Calibrated: 2016/11/18
- Phantom: SAM with right table; Type: SAM;
- Measurement SW: DASY52, Version 52.8 (8); SEMCAD X Version 14.6.10 (7373)

**Configuration/Body/Area Scan (6x8x1):** Measurement grid: dx=10mm, dy=10mm

Maximum value of SAR (measured) = 2.24 W/kg

**Configuration/Body/Zoom Scan (7x7x12) (7x7x12)/Cube 0:** Measurement grid:

dx=4mm, dy=4mm, dz=2mm

Reference Value = 1.645 V/m; Power Drift = -0.13 dB

Peak SAR (extrapolated) = 6.88 W/kg

**SAR(1 g) = 1.23 W/kg; SAR(10 g) = 0.269 W/kg**

Maximum value of SAR (measured) = 3.69 W/kg

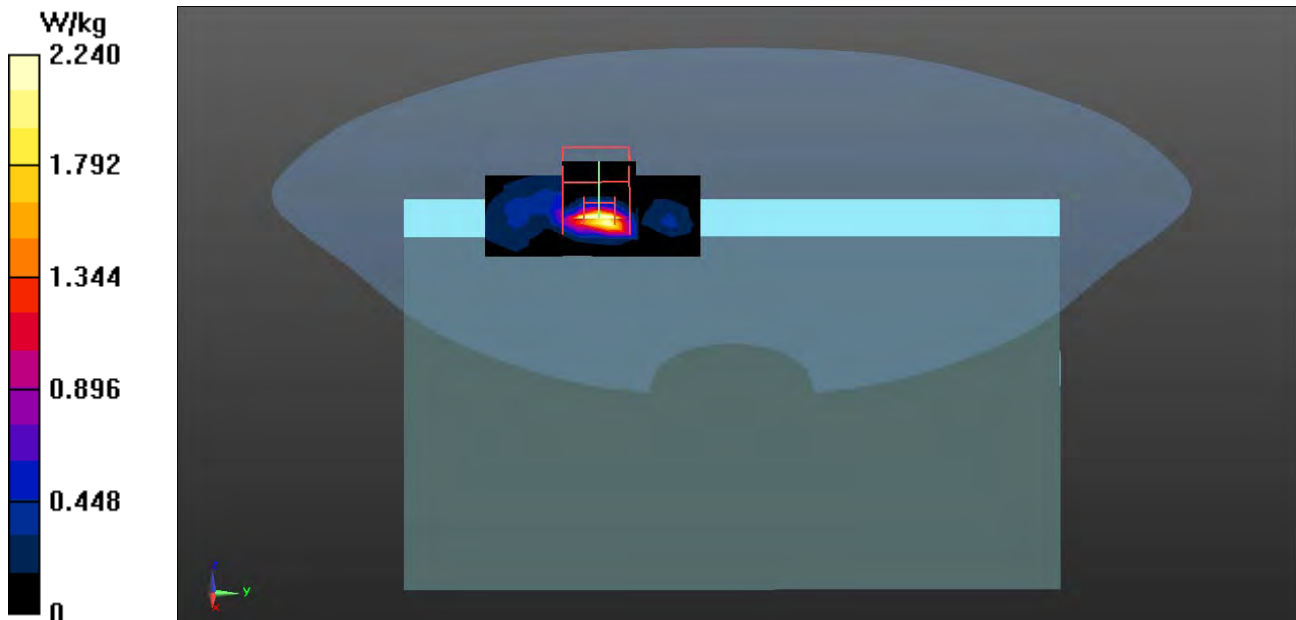

1399.11

**Calibration Laboratory of  
Schmid & Partner  
Engineering AG**  
Zeughausstrasse 43, 8004 Zurich, Switzerland



**S** Schweizerischer Kalibrierdienst  
**C** Service suisse d'étalonnage  
**S** Servizio svizzero di taratura  
**S** Swiss Calibration Service

Accredited by the Swiss Accreditation Service (SAS)  
The Swiss Accreditation Service is one of the signatories to the EA  
Multilateral Agreement for the recognition of calibration certificates

Accreditation No.: **SCS 0108**

Client **Quietek-TW (Auden)**

Certificate No: **EX3-3979\_Nov16**

## CALIBRATION CERTIFICATE

Object: **EX3DV4 - SN:3979**

Calibration procedure(s): **QA CAL-01.v9, QA CAL-14.v4, QA CAL-23.v5, QA CAL-25.v6  
Calibration procedure for dosimetric E-field probes**

Calibration date: **November 25, 2016**

This calibration certificate documents the traceability to national standards, which realize the physical units of measurements (SI).  
The measurements and the uncertainties with confidence probability are given on the following pages and are part of the certificate.

All calibrations have been conducted in the closed laboratory facility: environment temperature (22 ± 3)°C and humidity < 70%.

Calibration Equipment used (M&TE critical for calibration)

Primary Standards	ID	Cal Date (Certificate No.)	Scheduled Calibration
Power meter NRP	SN: 104778	06-Apr-16 (No. 217-02288/02289)	Apr-17
Power sensor NRP-Z91	SN: 103244	06-Apr-16 (No. 217-02288)	Apr-17
Power sensor NRP-Z91	SN: 103245	06-Apr-16 (No. 217-02289)	Apr-17
Reference 20 dB Attenuator	SN: S5277 (20x)	05-Apr-16 (No. 217-02293)	Apr-17
Reference Probe ES3DV2	SN: 3013	31-Dec-15 (No. ES3-3013_Dec15)	Dec-16
DAE4	SN: 660	23-Dec-15 (No. DAE4-660_Dec15)	Dec-16
Secondary Standards	ID	Check Date (in house)	Scheduled Check
Power meter E4419B	SN: GB41293874	06-Apr-16 (in house check Jun-16)	In house check: Jun-18
Power sensor E4412A	SN: MY41498087	06-Apr-16 (in house check Jun-16)	In house check: Jun-18
Power sensor E4412A	SN: 000110210	06-Apr-16 (in house check Jun-16)	In house check: Jun-18
RF generator HP 8648C	SN: US3642U01700	04-Aug-99 (in house check Jun-16)	In house check: Jun-18
Network Analyzer HP 8753E	SN: US37390585	18-Oct-01 (in house check Oct-16)	In house check: Oct-17

	Name	Function	Signature
Calibrated by:	Jeton Kastarti	Laboratory Technician	
Approved by:	Katja Pokovic	Technical Manager	

Issued: November 28, 2016

This calibration certificate shall not be reproduced except in full without written approval of the laboratory.



Accredited by the Swiss Accreditation Service (SAS)

Accreditation No.: **SCS 0108**

The Swiss Accreditation Service is one of the signatories to the EA  
Multilateral Agreement for the recognition of calibration certificates

### Glossary:

TSL	tissue simulating liquid
NORM <sub>x,y,z</sub>	sensitivity in free space
ConvF	sensitivity in TSL / NORM <sub>x,y,z</sub>
DCP	diode compression point
CF	crest factor (1/duty_cycle) of the RF signal
A, B, C, D	modulation dependent linearization parameters
Polarization $\varphi$	$\varphi$ rotation around probe axis
Polarization $\vartheta$	$\vartheta$ rotation around an axis that is in the plane normal to probe axis (at measurement center), i.e., $\vartheta = 0$ is normal to probe axis
Connector Angle	information used in DASY system to align probe sensor X to the robot coordinate system

### Calibration is Performed According to the Following Standards:

- IEEE Std 1528-2013, "IEEE Recommended Practice for Determining the Peak Spatial-Averaged Specific Absorption Rate (SAR) in the Human Head from Wireless Communications Devices: Measurement Techniques", June 2013
- IEC 62209-1, "Procedure to measure the Specific Absorption Rate (SAR) for hand-held devices used in close proximity to the ear (frequency range of 300 MHz to 3 GHz)", February 2005
- IEC 62209-2, "Procedure to determine the Specific Absorption Rate (SAR) for wireless communication devices used in close proximity to the human body (frequency range of 30 MHz to 6 GHz)", March 2010
- KDB 865664, "SAR Measurement Requirements for 100 MHz to 6 GHz"

### Methods Applied and Interpretation of Parameters:

- NORM<sub>x,y,z</sub>**: Assessed for E-field polarization  $\vartheta = 0$  ( $f \leq 900$  MHz in TEM-cell;  $f > 1800$  MHz: R22 waveguide). NORM<sub>x,y,z</sub> are only intermediate values, i.e., the uncertainties of NORM<sub>x,y,z</sub> does not affect the  $E^2$ -field uncertainty inside TSL (see below *ConvF*).
- NORM(f)<sub>x,y,z</sub>** = NORM<sub>x,y,z</sub> \* *frequency\_response* (see Frequency Response Chart). This linearization is implemented in DASY4 software versions later than 4.2. The uncertainty of the frequency response is included in the stated uncertainty of *ConvF*.
- DCP<sub>x,y,z</sub>**: DCP are numerical linearization parameters assessed based on the data of power sweep with CW signal (no uncertainty required). DCP does not depend on frequency nor media.
- PAR**: PAR is the Peak to Average Ratio that is not calibrated but determined based on the signal characteristics
- A<sub>x,y,z</sub>; B<sub>x,y,z</sub>; C<sub>x,y,z</sub>; D<sub>x,y,z</sub>; VR<sub>x,y,z</sub>**: A, B, C, D are numerical linearization parameters assessed based on the data of power sweep for specific modulation signal. The parameters do not depend on frequency nor media. VR is the maximum calibration range expressed in RMS voltage across the diode.
- ConvF and Boundary Effect Parameters**: Assessed in flat phantom using E-field (or Temperature Transfer Standard for  $f \leq 800$  MHz) and inside waveguide using analytical field distributions based on power measurements for  $f > 800$  MHz. The same setups are used for assessment of the parameters applied for boundary compensation (alpha, depth) of which typical uncertainty values are given. These parameters are used in DASY4 software to improve probe accuracy close to the boundary. The sensitivity in TSL corresponds to NORM<sub>x,y,z</sub> \* *ConvF* whereby the uncertainty corresponds to that given for *ConvF*. A frequency dependent *ConvF* is used in DASY version 4.4 and higher which allows extending the validity from  $\pm 50$  MHz to  $\pm 100$  MHz.
- Spherical isotropy (3D deviation from isotropy)**: in a field of low gradients realized using a flat phantom exposed by a patch antenna.
- Sensor Offset**: The sensor offset corresponds to the offset of virtual measurement center from the probe tip (on probe axis). No tolerance required.
- Connector Angle**: The angle is assessed using the information gained by determining the NORM<sub>x</sub> (no uncertainty required).

# Probe EX3DV4

## SN:3979

Manufactured: November 5, 2013  
Calibrated: November 25, 2016

Calibrated for DASY/EASY Systems  
(Note: non-compatible with DASY2 system!)



## DASY/EASY - Parameters of Probe: EX3DV4 - SN:3979

### Basic Calibration Parameters

	Sensor X	Sensor Y	Sensor Z	Unc (k=2)
Norm ( $\mu\text{V}/(\text{V}/\text{m})^2$ ) <sup>A</sup>	0.46	0.49	0.47	$\pm 10.1 \%$
DCP (mV) <sup>B</sup>	101.4	98.1	99.8	

### Modulation Calibration Parameters

UID	Communication System Name		A dB	B dB $\sqrt{\mu\text{V}}$	C	D dB	VR mV	Unc <sup>E</sup> (k=2)
0	CW	X	0.0	0.0	1.0	0.00	137.8	$\pm 3.5 \%$
		Y	0.0	0.0	1.0		136.9	
		Z	0.0	0.0	1.0		132.6	

The reported uncertainty of measurement is stated as the standard uncertainty of measurement multiplied by the coverage factor  $k=2$ , which for a normal distribution corresponds to a coverage probability of approximately 95%.

<sup>A</sup> The uncertainties of Norm X,Y,Z do not affect the  $E^2$ -field uncertainty inside TSL (see Pages 5 and 6).

<sup>B</sup> Numerical linearization parameter: uncertainty not required.

<sup>E</sup> Uncertainty is determined using the max. deviation from linear response applying rectangular distribution and is expressed for the square of the field value.

## DASY/EASY - Parameters of Probe: EX3DV4 - SN:3979

### Calibration Parameter Determined in Head Tissue Simulating Media

f (MHz) <sup>C</sup>	Relative Permittivity <sup>F</sup>	Conductivity (S/m) <sup>F</sup>	ConvF X	ConvF Y	ConvF Z	Alpha <sup>G</sup>	Depth <sup>G</sup> (mm)	Unc (k=2)
750	41.9	0.89	10.35	10.35	10.35	0.44	1.03	± 12.0 %
835	41.5	0.90	10.08	10.08	10.08	0.54	0.80	± 12.0 %
900	41.5	0.97	9.86	9.86	9.86	0.48	0.89	± 12.0 %
1450	40.5	1.20	8.78	8.78	8.78	0.41	0.80	± 12.0 %
1640	40.3	1.29	8.68	8.68	8.68	0.37	0.80	± 12.0 %
1750	40.1	1.37	8.49	8.49	8.49	0.39	0.80	± 12.0 %
1810	40.0	1.40	8.29	8.29	8.29	0.40	0.80	± 12.0 %
1900	40.0	1.40	8.15	8.15	8.15	0.33	0.80	± 12.0 %
2000	40.0	1.40	8.23	8.23	8.23	0.38	0.80	± 12.0 %
2300	39.5	1.67	7.71	7.71	7.71	0.37	0.80	± 12.0 %
2450	39.2	1.80	7.48	7.48	7.48	0.37	0.81	± 12.0 %
2600	39.0	1.96	7.23	7.23	7.23	0.28	1.03	± 12.0 %
3500	37.9	2.91	7.07	7.07	7.07	0.26	1.25	± 13.1 %
5200	36.0	4.66	5.08	5.08	5.08	0.30	1.90	± 13.1 %
5300	35.9	4.76	4.78	4.78	4.78	0.35	1.90	± 13.1 %
5500	35.6	4.96	4.66	4.66	4.66	0.40	1.90	± 13.1 %
5600	35.5	5.07	4.53	4.53	4.53	0.40	1.90	± 13.1 %
5800	35.3	5.27	4.44	4.44	4.44	0.40	1.90	± 13.1 %

<sup>C</sup> Frequency validity above 300 MHz of ± 100 MHz only applies for DASY v4.4 and higher (see Page 2), else it is restricted to ± 50 MHz. The uncertainty is the RSS of the ConvF uncertainty at calibration frequency and the uncertainty for the indicated frequency band. Frequency validity below 300 MHz is ± 10, 25, 40, 50 and 70 MHz for ConvF assessments at 30, 64, 128, 150 and 220 MHz respectively. Above 5 GHz frequency validity can be extended to ± 110 MHz.

<sup>F</sup> At frequencies below 3 GHz, the validity of tissue parameters ( $\epsilon$  and  $\sigma$ ) can be relaxed to ± 10% if liquid compensation formula is applied to measured SAR values. At frequencies above 3 GHz, the validity of tissue parameters ( $\epsilon$  and  $\sigma$ ) is restricted to ± 5%. The uncertainty is the RSS of the ConvF uncertainty for indicated target tissue parameters.

<sup>G</sup> Alpha/Depth are determined during calibration. SPEAG warrants that the remaining deviation due to the boundary effect after compensation is always less than ± 1% for frequencies below 3 GHz and below ± 2% for frequencies between 3-6 GHz at any distance larger than half the probe tip diameter from the boundary.

## DASY/EASY - Parameters of Probe: EX3DV4 - SN:3979

### Calibration Parameter Determined in Body Tissue Simulating Media

f (MHz) <sup>C</sup>	Relative Permittivity <sup>F</sup>	Conductivity (S/m) <sup>F</sup>	ConvF X	ConvF Y	ConvF Z	Alpha <sup>G</sup>	Depth <sup>G</sup> (mm)	Unc (k=2)
750	55.5	0.96	9.85	9.85	9.85	0.52	0.80	± 12.0 %
835	55.2	0.97	9.75	9.75	9.75	0.46	0.80	± 12.0 %
900	55.0	1.05	9.68	9.68	9.68	0.43	0.85	± 12.0 %
1450	54.0	1.30	8.37	8.37	8.37	0.30	0.80	± 12.0 %
1640	53.8	1.40	8.24	8.24	8.24	0.36	0.80	± 12.0 %
1750	53.4	1.49	8.11	8.11	8.11	0.36	0.87	± 12.0 %
1810	53.3	1.52	7.99	7.99	7.99	0.40	0.80	± 12.0 %
1900	53.3	1.52	7.83	7.83	7.83	0.39	0.80	± 12.0 %
2000	53.3	1.52	7.99	7.99	7.99	0.38	0.84	± 12.0 %
2300	52.9	1.81	7.65	7.65	7.65	0.32	0.80	± 12.0 %
2450	52.7	1.95	7.47	7.47	7.47	0.30	0.80	± 12.0 %
2600	52.5	2.16	7.11	7.11	7.11	0.28	0.90	± 12.0 %
3500	51.3	3.31	6.56	6.56	6.56	0.28	1.20	± 13.1 %
5200	49.0	5.30	4.75	4.75	4.75	0.40	1.80	± 13.1 %
5300	48.9	5.42	4.55	4.55	4.55	0.40	1.80	± 13.1 %
5500	48.6	5.65	4.10	4.10	4.10	0.50	1.80	± 13.1 %
5600	48.5	5.77	4.03	4.03	4.03	0.50	1.80	± 13.1 %
5800	48.2	6.00	4.27	4.27	4.27	0.50	1.80	± 13.1 %

<sup>C</sup> Frequency validity above 300 MHz of ± 100 MHz only applies for DASY v4.4 and higher (see Page 2), else it is restricted to ± 50 MHz. The uncertainty is the RSS of the ConvF uncertainty at calibration frequency and the uncertainty for the indicated frequency band. Frequency validity below 300 MHz is ± 10, 25, 40, 50 and 70 MHz for ConvF assessments at 30, 64, 128, 150 and 220 MHz respectively. Above 5 GHz frequency validity can be extended to ± 110 MHz.

<sup>F</sup> At frequencies below 3 GHz, the validity of tissue parameters ( $\epsilon$  and  $\sigma$ ) can be relaxed to ± 10% if liquid compensation formula is applied to measured SAR values. At frequencies above 3 GHz, the validity of tissue parameters ( $\epsilon$  and  $\sigma$ ) is restricted to ± 5%. The uncertainty is the RSS of the ConvF uncertainty for indicated target tissue parameters.

<sup>G</sup> Alpha/Depth are determined during calibration. SPEAG warrants that the remaining deviation due to the boundary effect after compensation is always less than ± 1% for frequencies below 3 GHz and below ± 2% for frequencies between 3-6 GHz at any distance larger than half the probe tip diameter from the boundary.

### Frequency Response of E-Field (TEM-Cell:ifi110 EXX, Waveguide: R22)

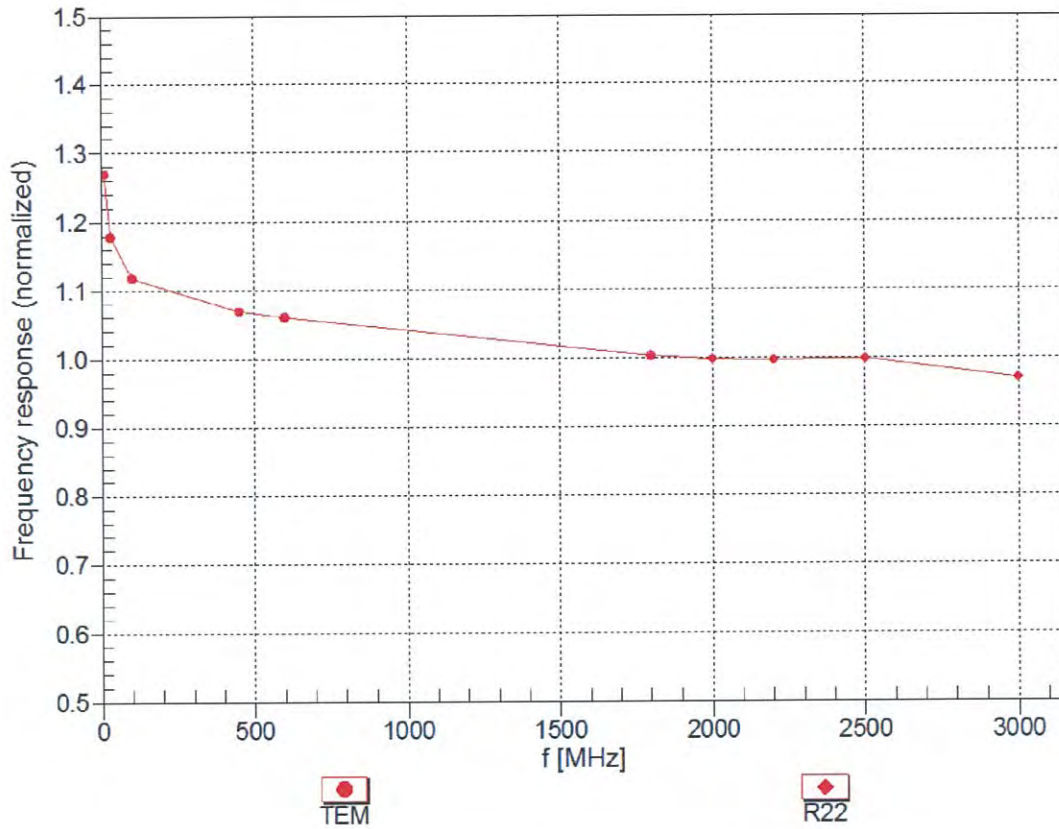

Uncertainty of Frequency Response of E-field:  $\pm 6.3\%$  (k=2)

## Receiving Pattern ( $\phi$ ), $\vartheta = 0^\circ$

f=600 MHz, TEM

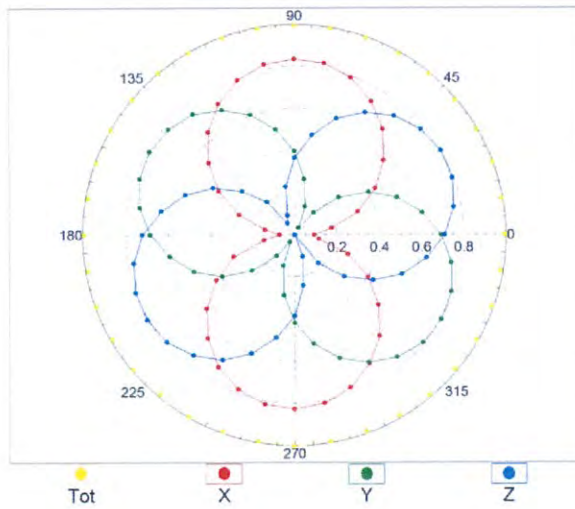

f=1800 MHz, R22

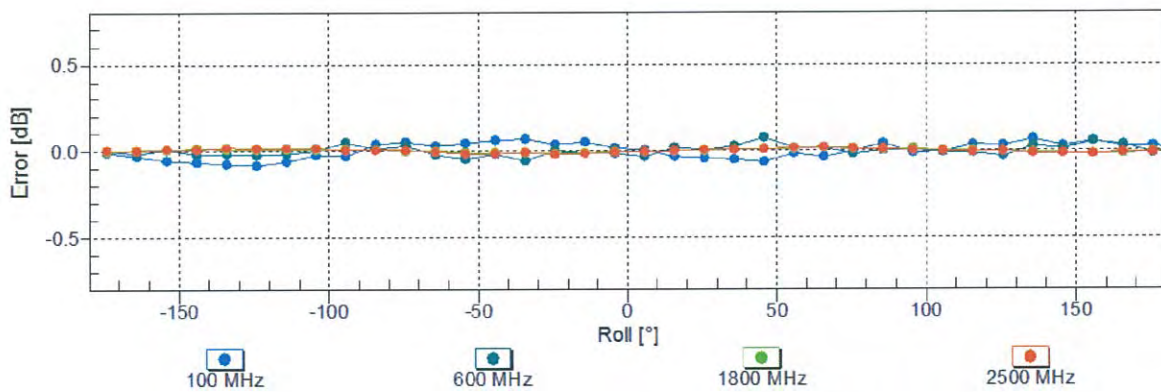
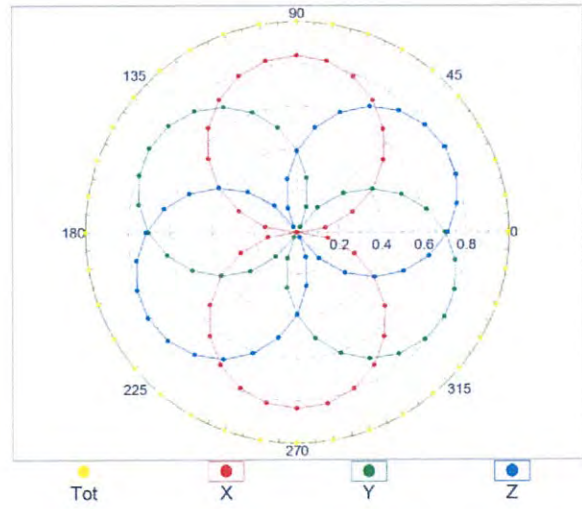

Uncertainty of Axial Isotropy Assessment:  $\pm 0.5\%$  ( $k=2$ )

### Dynamic Range $f(\text{SAR}_{\text{head}})$ (TEM cell , $f_{\text{eval}} = 1900 \text{ MHz}$ )

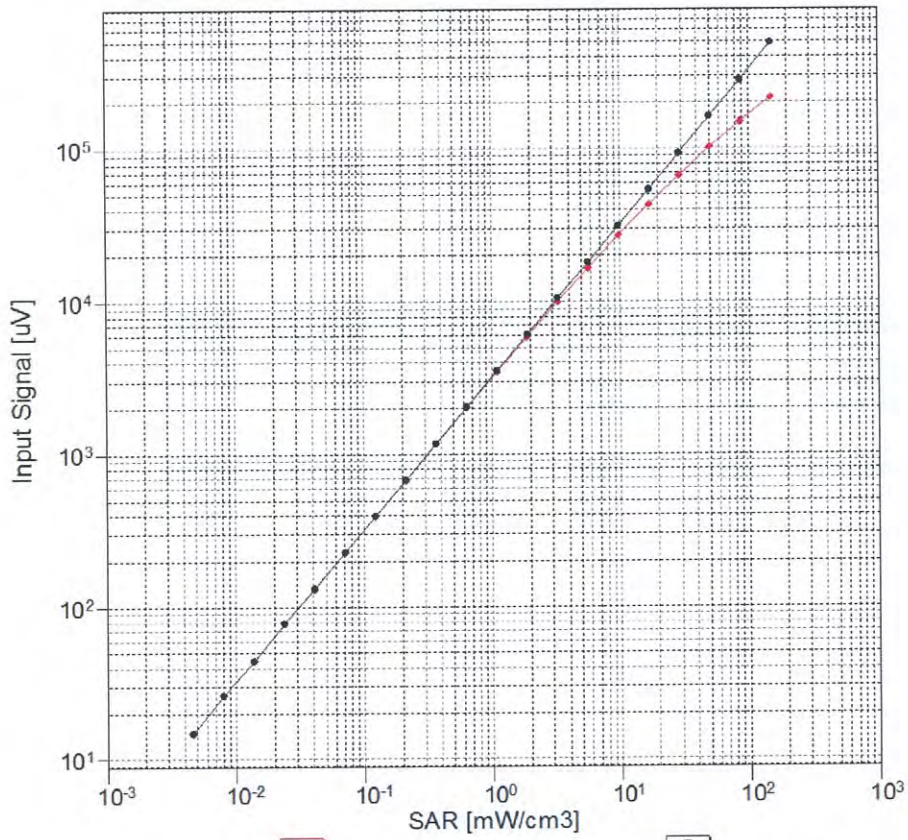

not compensated

compensated

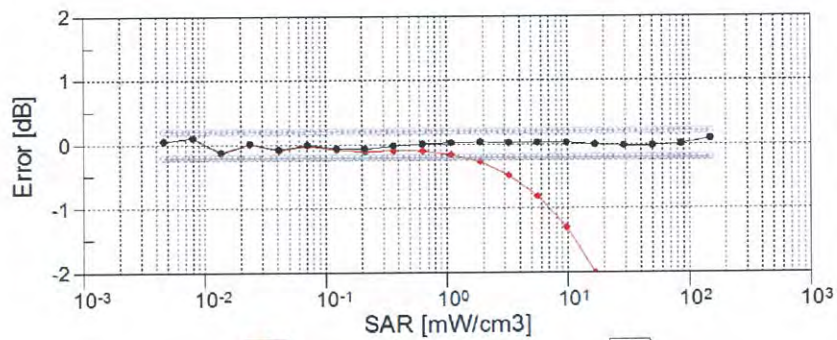

not compensated

compensated

Uncertainty of Linearity Assessment:  $\pm 0.6\%$  (k=2)

# Conversion Factor Assessment

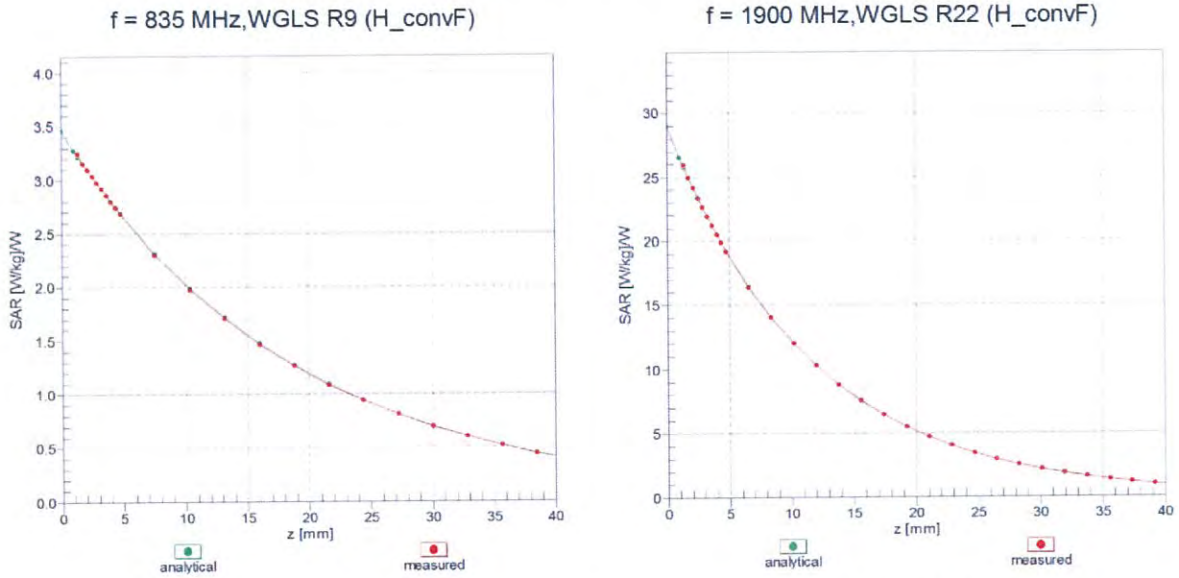

## Deviation from Isotropy in Liquid Error ( $\phi, \theta$ ), f = 900 MHz

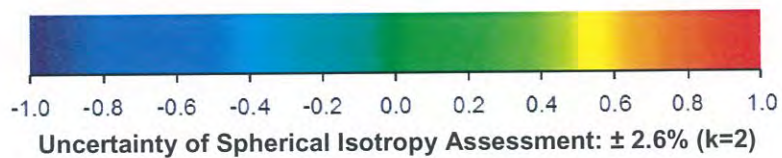
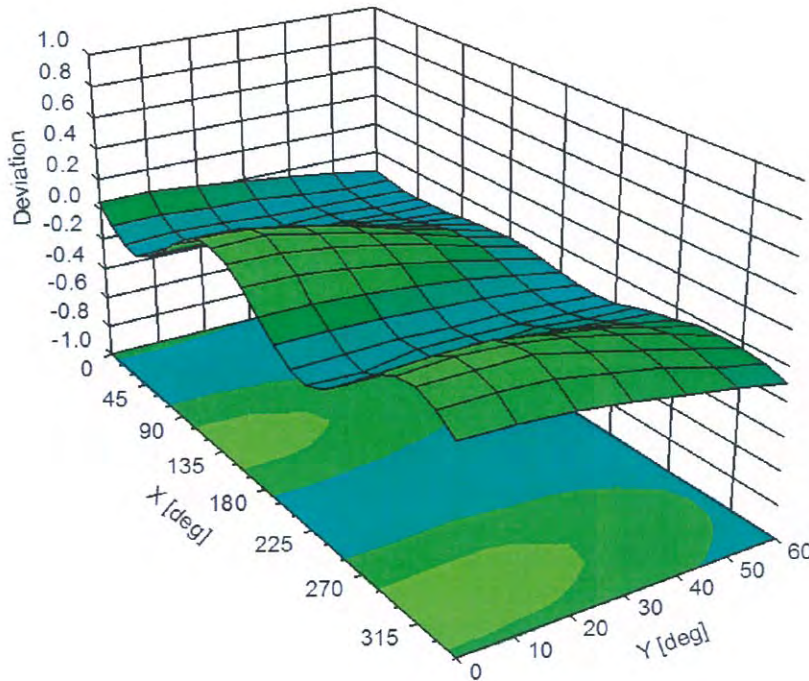

## DASY/EASY - Parameters of Probe: EX3DV4 - SN:3979

### Other Probe Parameters

Sensor Arrangement	Triangular
Connector Angle (°)	135.8
Mechanical Surface Detection Mode	enabled
Optical Surface Detection Mode	disabled
Probe Overall Length	337 mm
Probe Body Diameter	10 mm
Tip Length	9 mm
Tip Diameter	2.5 mm
Probe Tip to Sensor X Calibration Point	1 mm
Probe Tip to Sensor Y Calibration Point	1 mm
Probe Tip to Sensor Z Calibration Point	1 mm
Recommended Measurement Distance from Surface	1.4 mm