

FCC Test Report

Product Name	Medical Cart Computer
Model No	DT590B, DT592B, DT594B
FCC ID	YE3800G

Applicant	DT Research, Inc.
Address	6F, No. 1, NingPo E. St. Taipei, 100 Taiwan

Date of Receipt	Jan. 18, 2016
Issued Date	Mar. 08, 2016
Report No.	1610298R-RFUSP55V00
Report Version	V1.0



The test results relate only to the samples tested.

The test results shown in the test report are traceable to the national/international standard through the calibration report of the equipment and evaluated measurement uncertainty herein.

This report must not be used to claim product endorsement by TAF or any agency of the government.

The test report shall not be reproduced without the written approval of QuieTek Corporation.

Test Report

Issued Date: Mar. 08, 2016

Report No.: 1610298R-RFUSP55V00



Product Name	Medical Cart Computer
Applicant	DT Research, Inc.
Address	6F, No. 1, NingPo E. St. Taipei, 100 Taiwan
Manufacturer	DT Research, Inc.
Model No.	DT590B, DT592B, DT594B
FCC ID.	YE3800G
EUT Rated Voltage	AC 100-240V, 50/60Hz
EUT Test Voltage	AC 120V/60Hz
Trade Name	DT Research, Inc.
Applicable Standard	FCC CFR Title 47 Part 15 Subpart E: 2014 ANSI C63.4: 2014, ANSI C63.10: 2013 789033 D02 General UNII Test Procedures New Rules v01
Test Result	Complied

Documented By : Jinn Chen
(Senior Adm. Specialist / Jinn Chen)

Tested By : Yulin Chen
(Assistant Engineer / Yulin Chen)

Approved By :
(Director / Vincent Lin)

TABLE OF CONTENTS

Description	Page
1. GENERAL INFORMATION	5
1.1. EUT Description.....	5
1.2. Operational Description	8
1.3. Tested System Details.....	9
1.4. Configuration of tested System	10
1.5. EUT Exercise Software	11
1.6. Test Facility	12
2. Conducted Emission.....	13
2.1. Test Equipment.....	13
2.2. Test Setup	13
2.3. Limits	14
2.4. Test Procedure	14
2.5. Uncertainty	14
2.6. Test Result of Conducted Emission.....	15
3. Maximun conducted output power	31
3.1. Test Equipment.....	31
3.2. Test Setup	31
3.3. Limits	32
3.4. Test Procedure	33
3.5. Uncertainty	33
3.6. Test Result of Maximum conducted output power.....	34
4. Peak Power Spectral Density.....	81
4.1. Test Equipment.....	81
4.2. Test Setup	81
4.3. Limits	81
4.4. Test Procedure	82
4.5. Uncertainty	82
4.6. Test Result of Peak Power Spectral Density	83
5. Radiated Emission.....	129
5.1. Test Equipment.....	129
5.2. Test Setup	130
5.3. Limits	131
5.4. Test Procedure	132
5.5. Uncertainty	132
5.6. Test Result of Radiated Emission.....	133
6. Band Edge	251
6.1. Test Equipment.....	251
6.2. Test Setup	252
6.3. Limits	253
6.4. Test Procedure	253
6.5. Uncertainty	253
6.6. Test Result of Band Edge	254
7. Occupied Bandwidth.....	332

7.1.	Test Equipment.....	332
7.2.	Test Setup	332
7.3.	Limits	332
7.4.	.Test Procedure	332
7.5.	Uncertainty	332
7.6.	Test Result of Occupied Bandwidth	333
8.	Frequency Stability.....	342
8.1.	Test Equipment.....	342
8.2.	Test Setup	342
8.3.	Limits	342
8.4.	Test Procedure	342
8.5.	Uncertainty	342
8.6.	Test Result of Frequency Stability.....	343
9.	EMI Reduction Method During Compliance Testing	357
Attachment 1: EUT Test Photographs		
Attachment 2: EUT Detailed Photographs		

1. GENERAL INFORMATION

1.1. EUT Description

Product Name	Medical Cart Computer
Trade Name	DT Research, Inc.
FCC ID.	YE3800G
Model No.	DT590B, DT592B, DT594B
Frequency Range	802.11a/n-20MHz: 5180-5320MHz, 5500-5700MHz, 5745-5825MHz 802.11n-40MHz: 5190-5310, 5510-5670MHz, 5755-5795MHz 802.11ac-20MHz: 5720, 802.11ac-40MHz: 5710 802.11ac-80MHz: 5210-5290MHz, 5530-5690MHz, 5775MHz
Number of Channels	802.11a/n-20MHz: 24; 802.11n-40MHz: 11 802.11ac-20MHz: 1, 802.11ac-40MHz: 1, 802.11ac-80MHz: 6
Data Rate	802.11a: 6 - 54Mbps 802.11n: up to 300Mbps 802.11ac-80MHz: up to 866.7MHz
Channel Control	Auto
Type of Modulation	802.11a/n/ac:OFDM, BPSK, QPSK, 16QAM, 64QAM, 256QAM
Antenna type	PIFA Antenna
Antenna Gain	Refer to the table "Antenna List"
Power Cable	Non-shielded, 1.8m
Power Adapter	MFR: EDAC, M/N: EM11201D Input: 100-240Vac, 2.0-1.0A, 50-60Hz Output: 18-24V $\overline{\text{---}}$ 120W max Cable Out: Non-shielded, 1.2m, with one ferrite core bonded.

Antenna List

No.	Manufacturer	Part No.	Antenna Type	Peak Gain
1	CUELE	27-594-720020 (210-80012) (Main) 27-594-720010 (210-80013) (Aux)	PIFA Antenna	0.30dBi for 5.15~5.25GHz 0.30dBi for 5.25~5.35GHz -0.05dBi for 5.47~5.725GHz 1.14 dBi for 5.725~5.850GHz

Note: The antenna of EUT is conform to FCC 15.203

802.11a/n-20MHz Center Working Frequency of Each Channel:

Channel	Frequency	Channel	Frequency	Channel	Frequency	Channel	Frequency
Channel 36:	5180 MHz	Channel 40:	5200 MHz	Channel 44:	5220 MHz	Channel 48:	5240 MHz
Channel 52:	5260 MHz	Channel 56:	5280 MHz	Channel 60:	5300 MHz	Channel 64:	5320 MHz
Channel 100:	5500 MHz	Channel 104:	5520 MHz	Channel 108:	5540 MHz	Channel 112:	5560 MHz
Channel 116:	5580 MHz	Channel 120:	5600 MHz	Channel 124:	5620 MHz	Channel 128:	5640 MHz
Channel 132:	5660 MHz	Channel 136:	5680 MHz	Channel 140:	5700 MHz	Channel 149:	5745 MHz
Channel 153:	5765 MHz	Channel 157:	5785 MHz	Channel 161:	5805 MHz	Channel 165:	5825 MHz

802.11n-40MHz Center Working Frequency of Each Channel:

Channel	Frequency	Channel	Frequency	Channel	Frequency	Channel	Frequency
Channel 38:	5190 MHz	Channel 46:	5230 MHz	Channel 54:	5270 MHz	Channel 62:	5310 MHz
Channel 102:	5510 MHz	Channel 110:	5550 MHz	Channel 118:	5590 MHz	Channel 126:	5630 MHz
Channel 134:	5670 MHz	Channel 151:	5755 MHz	Channel 159:	5795 MHz		

802.11ac-20MHz Center Working Frequency of Each Channel:

Channel	Frequency
Channel 144:	5720 MHz

802.11ac-40MHz Center Working Frequency of Each Channel:

Channel	Frequency
Channel 142:	5710 MHz

802.11ac-80MHz Center Working Frequency of Each Channel:

Channel	Frequency	Channel	Frequency	Channel	Frequency	Channel	Frequency
Channel 42:	5210 MHz	Channel 58:	5290 MHz	Channel 106:	5530 MHz	Channel 122:	5610 MHz
Channel 138:	5690 MHz	Channel 155:	5775 MHz				

Note:

1. This device is a Medical Cart Computer with a built-in 2.4GHz and 5GHz WLAN 、 Bluetooth transceiver, this report for 5GHz WLAN.
2. At result of pretests, module supports dual-channel transmission, only the worst case is shown in the report. (802.11a is chain B)
3. Lowest and highest data rates are tested in each mode. Only worst case is shown in the report. (802.11a is 6Mbps 、 802.11n-20BW is 14.4Mbps 、 802.11n-40BW is 30Mbps and 802.11ac(80M-BW) is 65 Mbps)
4. These tests were conducted on a sample of the equipment for the purpose of demonstrating compliance with Part 15 Subpart E for Unlicensed National Information Infrastructure devices.
5. Medical Cart Computer operation on 19-inch、22-inch and 24-inch size,it was evaluated at both 22-inch and 24-inch size . 22-inch was found through pre-testing, 22-inch produce emissions was worse case.

Test Mode	Mode 1: Transmit (802.11a-6Mbps) Mode 2: Transmit (802.11n-20BW 14.4Mbps) Mode 3: Transmit (802.11n-40BW 30Mbps) Mode 4: Transmit (802.11ac-20BW-14.4Mbps) Mode 5: Transmit (802.11ac-40BW-30Mbps) Mode 6: Transmit (802.11ac-80BW-65Mbps)
-----------	---

1.3. Tested System Details

The types for all equipment, plus descriptions of all cables used in the tested system (including inserted cards) are:

For 19”:

	Product	Manufacturer	Model No.	Serial No.	Power Cord
1	LCD Monitor	DELL	ST2320Lf	CN-0M2nn6-72872-22I-C A1S	Non-Shielded, 1.8m
2	LCD Monitor	ASUS	VS229HA	F4LMQS135395	Non-Shielded, 1.8m
3	Modem	ACEEX	DM-1414	0102027541	Non-Shielded, 1.8m
4	Keyboard	Logitech	Y-U0009	LZ027HU	N/A
5	USB Mouse	Logitech	M-U0026	1245HS0684H8	N/A
6	iPod nano	Apple	A1199	5U728909VQ5	N/A
7	iPod nano	Apple	A1199	YM73337PVQ5	N/A
8	iPod nano	Apple	A1199	YM73336EVQ5	N/A
9	iPod nano	Apple	A1199	YM7333DCVQ5	N/A
10	Microphone & Earphone	Ergotech	ET-E201	N/A	N/A

For 22”:

	Product	Manufacturer	Model No.	Serial No.	Power Cord
1	LCD Monitor	DELL	ST2320Lf	CN-0M2nn6-72872-22I-C A1S	Non-Shielded, 1.8m
2	LCD Monitor	ASUS	VS229HA	F4LMQS135395	Non-Shielded, 1.8m
3	Modem	ACEEX	DM-1414	0102027541	Non-Shielded, 1.8m
4	Modem	ACEEX	DM-1414	0102027559	Non-Shielded, 1.8m
5	Modem	ACEEX	DM-1414	0102027533	Non-Shielded, 1.8m
6	Modem	ACEEX	DM-1414	0102027537	Non-Shielded, 1.8m
7	Keyboard	Logitech	Y-U0009	LZ027HU	N/A
8	USB Mouse	Logitech	M-U0026	1245HS0684H8	N/A
9	iPod nano	Apple	A1199	5U728909VQ5	N/A
10	iPod nano	Apple	A1199	YM73337PVQ5	N/A
11	iPod nano	Apple	A1199	YM73336EVQ5	N/A
12	iPod nano	Apple	A1199	YM7333DCVQ5	N/A
13	Microphone & Earphone	Ergotech	ET-E201	N/A	N/A

For 19”:

	Signal Cable Type	Signal cable Description
A	HDMI Card	Non-Shielded, 1.8m, two PCS.
B	Modem Card	Shielded, 1.5m
C	Keyboard Cable	Shielded, 1.8m
D	Mouse Cable	Shielded, 1.8m
E	USB Cable	Shielded, 1.2m, four PCS.
F	Earphone Cable	Non-Shielded, 2m

For 22”:

Signal Cable Type	Signal cable Description
A	HDMI Card
B	Modem Card
C	Keyboard Cable
D	Mouse Cable
E	USB Cable
F	Earphone Cable

1.4. Configuration of tested System

For 19”:

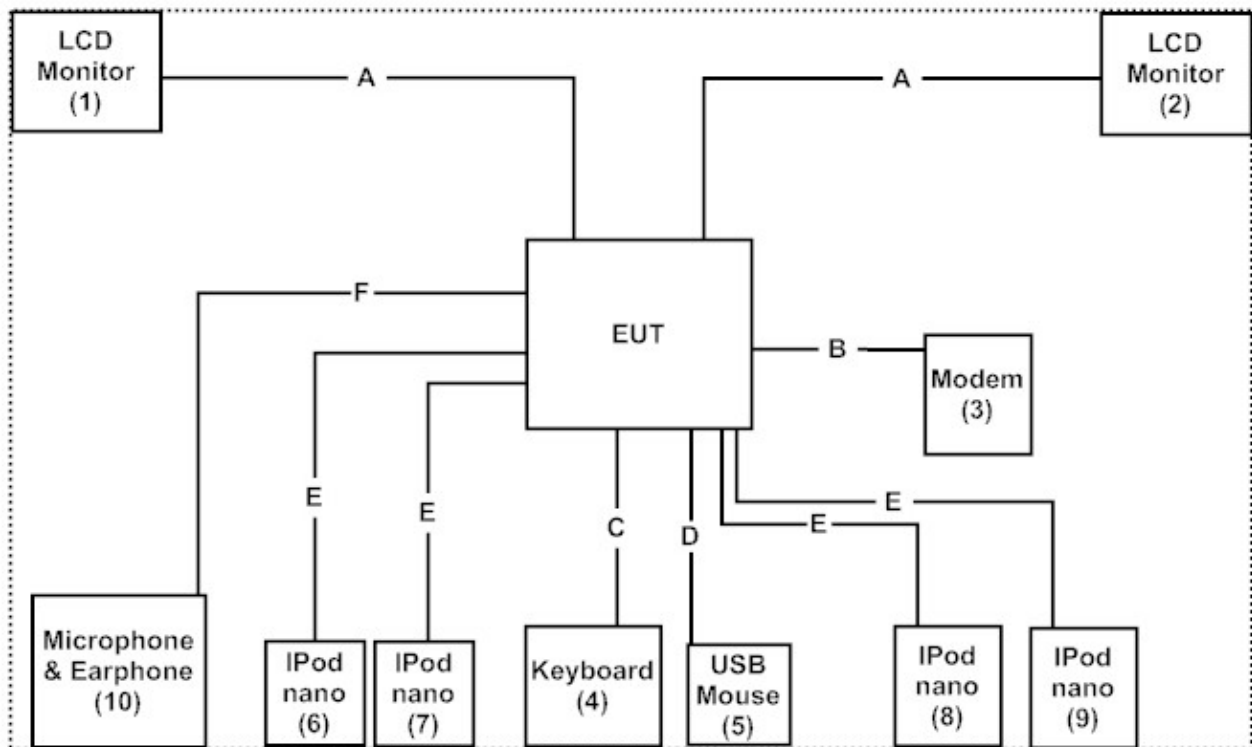

For 22”:

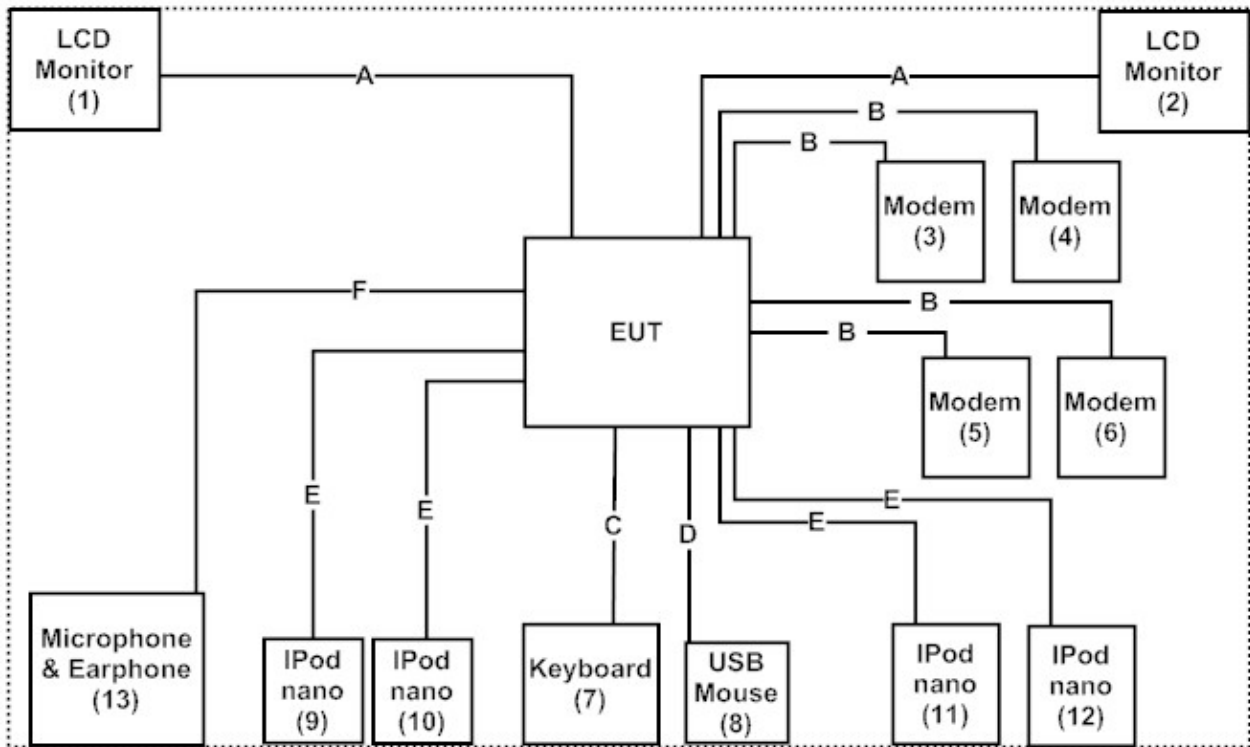

1.5. EUT Exercise Software

- (1) Setup the EUT as shown on 1.4
- (2) Execute “DRTU-V1.7.4-1041” program on the EUT.
- (3) Configure the test mode, the test channel, and the data rate.
- (4) Start the continuous transmission.
- (5) Verify that the EUT works properly.

1.6. Test Facility

Ambient conditions in the laboratory:

Items	Required (IEC 68-1)	Actual
Temperature (°C)	15-35	20-35
Humidity (%RH)	25-75	50-65
Barometric pressure (mbar)	860-1060	950-1000

The related certificate for our laboratories about the test site and management system can be downloaded from Quietek Corporation's Web Site : <http://www.quietek.com/chinese/about/certificates.aspx?bval=5>

The address and introduction of Quietek Corporation's laboratories can be founded in our Web site : <http://www.quietek.com/>

Site Description: File on
 Federal Communications Commission
 FCC Engineering Laboratory
 7435 Oakland Mills Road
 Columbia, MD 21046
 Registration Number: 92195

Site Name: Quietek Corporation
 Site Address: No.5-22, Ruishukeng Linkou Dist., New Taipei City
 24451, Taiwan, R.O.C.
 TEL: 886-2-8601-3788 / FAX : 886-2-8601-3789
 E-Mail : service@quietek.com

FCC Accreditation Number: TW1014

2. Conducted Emission

2.1. Test Equipment

	Equipment	Manufacturer	Model No. / Serial No.	Last Cal.	Remark
X	Test Receiver	R & S	ESCS 30 / 825442/018	Sep., 2015	
X	Artificial Mains Network	R & S	ENV4200 / 848411/10	Feb., 2016	Peripherals
X	LISN	R & S	ESH3-Z5 / 825562/002	Feb., 2016	EUT
	DC LISN	Schwarzbeck	8226 / 176	Mar, 2016	EUT
X	Pulse Limiter	R & S	ESH3-Z2 / 357.8810.52	Feb., 2016	
	No.1 Shielded Room				

Note:

1. All equipments are calibrated every one year.
2. The test instruments marked by “X” are used to measure the final test results.

2.2. Test Setup

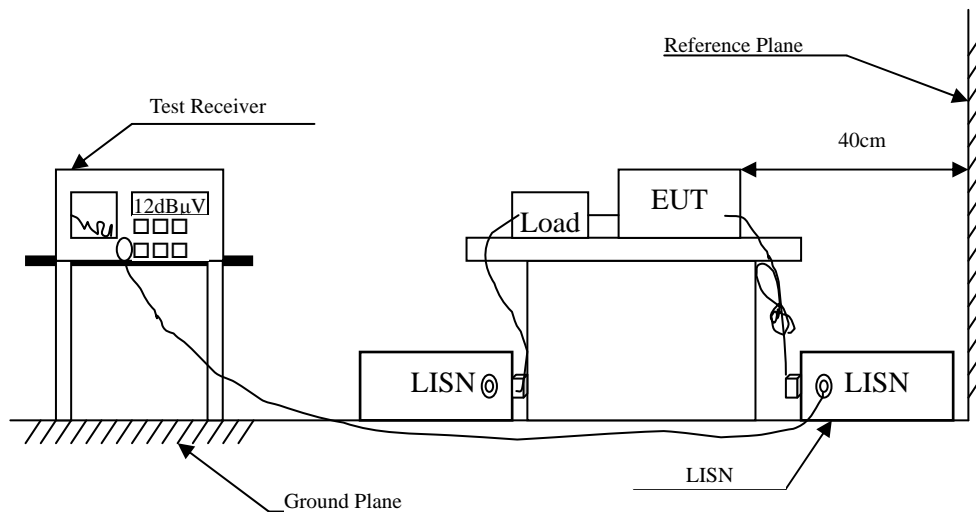

2.3. Limits

FCC Part 15 Subpart C Paragraph 15.207 (dBµV) Limit		
Frequency MHz	Limits	
	QP	AV
0.15 - 0.50	66-56	56-46
0.50-5.0	56	46
5.0 - 30	60	50

Remarks : In the above table, the tighter limit applies at the band edges.

2.4. Test Procedure

The EUT and simulators are connected to the main power through a line impedance stabilization network (L.I.S.N.). This provides a 50 ohm /50uH coupling impedance for the measuring equipment. The peripheral devices are also connected to the main power through a LISN that provides a 50ohm /50uH coupling impedance with 50ohm termination. (Please refers to the block diagram of the test setup and photographs.)

Both sides of A.C. line are checked for maximum conducted interference. In order to find the maximum emission, the relative positions of equipment and all of the interface cables must be changed according to ANSI C63.10:2013 on conducted measurement.

Conducted emissions were investigated over the frequency range from 0.15MHz to 30MHz using a receiver bandwidth of 9kHz.

The EUT was setup to ANSI C63.10, 2013; tested to UNII test procedure of FCC KDB-789033 for compliance to FCC 47CFR Subpart E requirements.

2.5. Uncertainty

± 2.26 dB

2.6. Test Result of Conducted Emission

Product : Medical Cart Computer
 Test Item : Conducted Emission Test
 Power Line : Line 1
 Test Mode : Mode 6: Transmit (802.11ac-80BW-65Mbps) (5210MHz) (19'')

Frequency MHz	Correct Factor dB	Reading Level dBµV	Measurement Level dBµV	Margin dB	Limit dBµV
LINE 1					
Quasi-Peak					
0.158	9.668	39.210	48.878	-16.893	65.771
0.173	9.664	35.840	45.504	-19.839	65.343
0.216	9.661	29.220	38.881	-25.233	64.114
14.084	9.998	20.220	30.218	-29.782	60.000
18.373	10.047	23.100	33.147	-26.853	60.000
20.861	10.055	17.770	27.825	-32.175	60.000
Average					
0.158	9.668	23.460	33.128	-22.643	55.771
0.173	9.664	18.600	28.264	-27.079	55.343
0.216	9.661	12.860	22.521	-31.593	54.114
14.084	9.998	14.660	24.658	-25.342	50.000
18.373	10.047	17.400	27.447	-22.553	50.000
20.861	10.055	12.110	22.165	-27.835	50.000

Note:

1. All Reading Levels are Quasi-Peak and average value.
2. "■" means the worst emission level.
3. Measurement Level = Reading Level + Correct Factor

Product : Medical Cart Computer
 Test Item : Conducted Emission Test
 Power Line : Line 2
 Test Mode : Mode 6: Transmit (802.11ac-80BW-65Mbps) (5210MHz) (19'')

Frequency MHz	Correct Factor dB	Reading Level dBμV	Measurement Level dBμV	Margin dB	Limit dBμV
LINE 2					
Quasi-Peak					
0.170	9.665	38.390	48.055	-17.374	65.429
0.228	9.662	30.250	39.912	-23.859	63.771
0.279	9.665	23.390	33.055	-29.259	62.314
14.818	10.095	18.810	28.905	-31.095	60.000
18.470	10.168	23.150	33.318	-26.682	60.000
20.779	10.204	19.240	29.444	-30.556	60.000
Average					
0.170	9.665	25.540	35.205	-20.224	55.429
0.228	9.662	10.560	20.222	-33.549	53.771
0.279	9.665	10.080	19.745	-32.569	52.314
14.818	10.095	13.820	23.915	-26.085	50.000
18.470	10.168	18.430	28.598	-21.402	50.000
20.779	10.204	14.100	24.304	-25.696	50.000

Note:

1. All Reading Levels are Quasi-Peak and average value.
2. "■" means the worst emission level.
3. Measurement Level = Reading Level + Correct Factor

Product : Medical Cart Computer
 Test Item : Conducted Emission Test
 Power Line : Line 1
 Test Mode : Mode 6: Transmit (802.11ac-80BW-65Mbps) (5290MHz) (19'')

Frequency MHz	Correct Factor dB	Reading Level dBμV	Measurement Level dBμV	Margin dB	Limit dBμV
LINE 1					
Quasi-Peak					
0.170	9.665	33.900	43.565	-21.864	65.429
0.240	9.663	29.970	39.633	-23.796	63.429
0.295	9.666	22.920	32.586	-29.271	61.857
0.377	9.670	16.030	25.700	-33.814	59.514
0.580	9.681	27.710	37.391	-18.609	56.000
0.697	9.688	31.270	40.958	-15.042	56.000
Average					
0.170	9.665	22.680	32.345	-23.084	55.429
0.240	9.663	16.480	26.143	-27.286	53.429
0.295	9.666	10.050	19.716	-32.141	51.857
0.377	9.670	6.790	16.460	-33.054	49.514
0.580	9.681	22.310	31.991	-14.009	46.000
0.697	9.688	10.650	20.338	-25.662	46.000

Note:

1. All Reading Levels are Quasi-Peak and average value.
2. "■" means the worst emission level.
3. Measurement Level = Reading Level + Correct Factor

Product : Medical Cart Computer
 Test Item : Conducted Emission Test
 Power Line : Line 2
 Test Mode : Mode 6: Transmit (802.11ac-80BW-65Mbps) (5290MHz) (19'')

Frequency MHz	Correct Factor dB	Reading Level dBμV	Measurement Level dBμV	Margin dB	Limit dBμV
LINE 2					
Quasi-Peak					
0.173	9.664	38.300	47.964	-17.379	65.343
0.220	9.662	27.320	36.982	-27.018	64.000
0.310	9.666	20.970	30.636	-30.793	61.429
0.576	9.681	30.270	39.951	-16.049	56.000
0.697	9.688	29.950	39.638	-16.362	56.000
0.923	9.700	17.080	26.780	-29.220	56.000
Average					
0.173	9.664	26.310	35.974	-19.369	55.343
0.220	9.662	14.480	24.142	-29.858	54.000
0.310	9.666	9.100	18.766	-32.663	51.429
0.576	9.681	25.170	34.851	-11.149	46.000
0.697	9.688	10.340	20.028	-25.972	46.000
0.923	9.700	0.770	10.470	-35.530	46.000

Note:

1. All Reading Levels are Quasi-Peak and average value.
2. "■" means the worst emission level.
3. Measurement Level = Reading Level + Correct Factor

Product : Medical Cart Computer
 Test Item : Conducted Emission Test
 Power Line : Line 1
 Test Mode : Mode 6: Transmit (802.11ac-80BW-65Mbps) (5610MHz) (19'')

Frequency MHz	Correct Factor dB	Reading Level dBμV	Measurement Level dBμV	Margin dB	Limit dBμV
LINE 1					
Quasi-Peak					
0.177	9.663	38.240	47.903	-17.326	65.229
0.263	9.664	23.330	32.994	-29.777	62.771
0.576	9.681	30.160	39.841	-16.159	56.000
0.740	9.690	30.430	40.120	-15.880	56.000
0.841	9.695	28.490	38.185	-17.815	56.000
1.287	9.720	29.570	39.290	-16.710	56.000
Average					
0.177	9.663	26.650	36.313	-18.916	55.229
0.263	9.664	11.130	20.794	-31.977	52.771
0.576	9.681	25.090	34.771	-11.229	46.000
0.740	9.690	10.060	19.750	-26.250	46.000
0.841	9.695	4.930	14.625	-31.375	46.000
1.287	9.720	21.280	31.000	-15.000	46.000

Note:

1. All Reading Levels are Quasi-Peak and average value.
2. "■" means the worst emission level.
3. Measurement Level = Reading Level + Correct Factor

Product : Medical Cart Computer
 Test Item : Conducted Emission Test
 Power Line : Line 2
 Test Mode : Mode 6: Transmit (802.11ac-80BW-65Mbps) (5610MHz) (19'')

Frequency MHz	Correct Factor dB	Reading Level dBμV	Measurement Level dBμV	Margin dB	Limit dBμV
LINE 2					
Quasi-Peak					
0.173	9.664	38.160	47.824	-17.519	65.343
0.576	9.681	30.270	39.951	-16.049	56.000
0.744	9.690	30.450	40.140	-15.860	56.000
0.849	9.696	28.360	38.056	-17.944	56.000
0.904	9.699	24.410	34.109	-21.891	56.000
1.287	9.720	29.790	39.510	-16.490	56.000
Average					
0.173	9.664	26.510	36.174	-19.169	55.343
0.576	9.681	25.250	34.931	-11.069	46.000
0.744	9.690	9.110	18.800	-27.200	46.000
0.849	9.696	4.780	14.476	-31.524	46.000
0.904	9.699	3.640	13.339	-32.661	46.000
1.287	9.720	21.590	31.310	-14.690	46.000

Note:

1. All Reading Levels are Quasi-Peak and average value.
2. "■" means the worst emission level.
3. Measurement Level = Reading Level + Correct Factor

Product : Medical Cart Computer
 Test Item : Conducted Emission Test
 Power Line : Line 1
 Test Mode : Mode 6: Transmit (802.11ac-80BW-65Mbps) (5775MHz) (19'')

Frequency MHz	Correct Factor dB	Reading Level dBμV	Measurement Level dBμV	Margin dB	Limit dBμV
LINE 1					
Quasi-Peak					
0.181	9.662	37.280	46.942	-18.172	65.114
0.228	9.662	28.300	37.962	-25.809	63.771
0.302	9.666	21.270	30.936	-30.721	61.657
0.412	9.672	17.760	27.432	-31.082	58.514
0.685	9.687	22.980	32.667	-23.333	56.000
0.830	9.695	28.910	38.605	-17.395	56.000
Average					
0.181	9.662	24.190	33.852	-21.262	55.114
0.228	9.662	15.750	25.412	-28.359	53.771
0.302	9.666	10.340	20.006	-31.651	51.657
0.412	9.672	7.220	16.892	-31.622	48.514
0.685	9.687	10.110	19.797	-26.203	46.000
0.830	9.695	4.630	14.325	-31.675	46.000

Note:

1. All Reading Levels are Quasi-Peak and average value.
2. "■" means the worst emission level.
3. Measurement Level = Reading Level + Correct Factor

Product : Medical Cart Computer
 Test Item : Conducted Emission Test
 Power Line : Line 2
 Test Mode : Mode 6: Transmit (802.11ac-80BW-65Mbps) (5775MHz) (19'')

Frequency MHz	Correct Factor dB	Reading Level dBμV	Measurement Level dBμV	Margin dB	Limit dBμV
LINE 2					
Quasi-Peak					
0.177	9.663	37.830	47.493	-17.736	65.229
0.232	9.662	29.950	39.612	-24.045	63.657
0.295	9.666	23.180	32.846	-29.011	61.857
0.513	9.678	24.510	34.188	-21.812	56.000
0.724	9.689	30.870	40.559	-15.441	56.000
0.822	9.694	28.970	38.664	-17.336	56.000
Average					
0.177	9.663	26.650	36.313	-18.916	55.229
0.232	9.662	17.620	27.282	-26.375	53.657
0.295	9.666	11.120	20.786	-31.071	51.857
0.513	9.678	18.530	28.208	-17.792	46.000
0.724	9.689	10.720	20.409	-25.591	46.000
0.822	9.694	3.920	13.614	-32.386	46.000

Note:

1. All Reading Levels are Quasi-Peak and average value.
2. "■" means the worst emission level.
3. Measurement Level = Reading Level + Correct Factor

Product : Medical Cart Computer
 Test Item : Conducted Emission Test
 Power Line : Line 1
 Test Mode : Mode 6: Transmit (802.11ac-80BW-65Mbps) (5210MHz) (22'')

Frequency MHz	Correct Factor dB	Reading Level dBμV	Measurement Level dBμV	Margin dB	Limit dBμV
LINE 1					
Quasi-Peak					
0.170	9.778	42.390	52.169	-13.260	65.429
0.220	9.776	37.690	47.466	-16.534	64.000
0.322	9.774	24.100	33.874	-27.212	61.086
1.736	9.903	4.580	14.483	-41.517	56.000
5.295	10.012	9.870	19.882	-40.118	60.000
14.142	10.143	33.120	43.263	-16.737	60.000
Average					
0.170	9.778	13.650	23.429	-32.000	55.429
0.220	9.776	19.440	29.216	-24.784	54.000
0.322	9.774	8.060	17.834	-33.252	51.086
1.736	9.903	-0.940	8.963	-37.037	46.000
5.295	10.012	3.020	13.032	-36.968	50.000
14.142	10.143	28.220	38.363	-11.637	50.000

Note:

1. All Reading Levels are Quasi-Peak and average value.
2. "■" means the worst emission level.
3. Measurement Level = Reading Level + Correct Factor

Product : Medical Cart Computer
 Test Item : Conducted Emission Test
 Power Line : Line 2
 Test Mode : Mode 6: Transmit (802.11ac-80BW-65Mbps) (5210MHz) (22")

Frequency MHz	Correct Factor dB	Reading Level dBμV	Measurement Level dBμV	Margin dB	Limit dBμV
LINE 2					
Quasi-Peak					
0.162	9.832	43.860	53.692	-11.965	65.657
0.212	9.836	34.860	44.696	-19.533	64.229
0.236	9.838	24.310	34.148	-29.395	63.543
0.330	9.845	18.770	28.615	-32.242	60.857
0.658	9.870	10.670	20.540	-35.460	56.000
14.310	10.275	32.780	43.055	-16.945	60.000
Average					
0.162	9.832	25.020	34.852	-20.805	55.657
0.212	9.836	13.950	23.786	-30.443	54.229
0.236	9.838	17.050	26.888	-26.655	53.543
0.330	9.845	10.300	20.145	-30.712	50.857
0.658	9.870	6.750	16.620	-29.380	46.000
14.310	10.275	27.180	37.455	-12.545	50.000

Note:

1. All Reading Levels are Quasi-Peak and average value.
2. "■" means the worst emission level.
3. Measurement Level = Reading Level + Correct Factor

Product : Medical Cart Computer
 Test Item : Conducted Emission Test
 Power Line : Line 1
 Test Mode : Mode 6: Transmit (802.11ac-80BW-65Mbps) (5290MHz) (22")

Frequency MHz	Correct Factor dB	Reading Level dBμV	Measurement Level dBμV	Margin dB	Limit dBμV
LINE 1					
Quasi-Peak					
0.166	9.780	43.060	52.840	-12.703	65.543
0.209	9.775	37.050	46.825	-17.489	64.314
0.252	9.779	24.500	34.279	-28.807	63.086
0.334	9.775	25.220	34.995	-25.748	60.743
0.439	9.783	20.580	30.363	-27.380	57.743
14.470	10.147	32.770	42.917	-17.083	60.000
Average					
0.166	9.780	29.160	38.940	-16.603	55.543
0.209	9.775	20.610	30.385	-23.929	54.314
0.252	9.779	6.130	15.909	-37.177	53.086
0.334	9.775	15.870	25.645	-25.098	50.743
0.439	9.783	8.890	18.673	-29.070	47.743
14.470	10.147	26.390	36.537	-13.463	50.000

Note:

1. All Reading Levels are Quasi-Peak and average value.
2. "■" means the worst emission level.
3. Measurement Level = Reading Level + Correct Factor

Product : Medical Cart Computer
 Test Item : Conducted Emission Test
 Power Line : Line 2
 Test Mode : Mode 6: Transmit (802.11ac-80BW-65Mbps) (5290MHz) (22")

Frequency MHz	Correct Factor dB	Reading Level dBμV	Measurement Level dBμV	Margin dB	Limit dBμV
LINE 2					
Quasi-Peak					
0.162	9.832	43.880	53.712	-11.945	65.657
0.209	9.835	34.700	44.535	-19.779	64.314
0.252	9.839	20.290	30.129	-32.957	63.086
0.341	9.846	17.840	27.686	-32.857	60.543
2.970	10.024	5.350	15.374	-40.626	56.000
14.267	10.274	31.990	42.264	-17.736	60.000
Average					
0.162	9.832	31.500	41.332	-14.325	55.657
0.209	9.835	19.700	29.535	-24.779	54.314
0.252	9.839	2.420	12.259	-40.827	53.086
0.341	9.846	4.470	14.316	-36.227	50.543
2.970	10.024	0.600	10.624	-35.376	46.000
14.267	10.274	26.380	36.654	-13.346	50.000

Note:

1. All Reading Levels are Quasi-Peak and average value.
2. "■" means the worst emission level.
3. Measurement Level = Reading Level + Correct Factor

Product : Medical Cart Computer
 Test Item : Conducted Emission Test
 Power Line : Line 1
 Test Mode : Mode 6: Transmit (802.11ac-80BW-65Mbps) (5610MHz) (22")

Frequency MHz	Correct Factor dB	Reading Level dBμV	Measurement Level dBμV	Margin dB	Limit dBμV
LINE 1					
Quasi-Peak					
0.170	9.778	42.470	52.249	-13.180	65.429
0.220	9.776	37.850	47.626	-16.374	64.000
0.248	9.778	25.180	34.958	-28.242	63.200
0.431	9.783	18.980	28.763	-29.208	57.971
3.939	9.981	7.100	17.081	-38.919	56.000
14.287	10.145	32.760	42.905	-17.095	60.000
Average					
0.170	9.778	22.560	32.339	-23.090	55.429
0.220	9.776	14.540	24.316	-29.684	54.000
0.248	9.778	6.330	16.108	-37.092	53.200
0.431	9.783	9.940	19.723	-28.248	47.971
3.939	9.981	0.600	10.581	-35.419	46.000
14.287	10.145	27.970	38.115	-11.885	50.000

Note:

1. All Reading Levels are Quasi-Peak and average value.
2. "■" means the worst emission level.
3. Measurement Level = Reading Level + Correct Factor

Product : Medical Cart Computer
 Test Item : Conducted Emission Test
 Power Line : Line 2
 Test Mode : Mode 6: Transmit (802.11ac-80BW-65Mbps) (5610MHz) (22'')

Frequency MHz	Correct Factor dB	Reading Level dBμV	Measurement Level dBμV	Margin dB	Limit dBμV
LINE 2					
Quasi-Peak					
0.162	9.832	43.940	53.772	-11.885	65.657
0.193	9.834	35.830	45.664	-19.107	64.771
0.345	9.846	13.850	23.696	-36.733	60.429
0.466	9.855	12.220	22.075	-34.896	56.971
9.806	10.179	16.460	26.639	-33.361	60.000
13.822	10.258	32.220	42.478	-17.522	60.000
Average					
0.162	9.832	24.110	33.942	-21.715	55.657
0.193	9.834	21.430	31.264	-23.507	54.771
0.345	9.846	-1.610	8.236	-42.193	50.429
0.466	9.855	7.670	17.525	-29.446	46.971
9.806	10.179	9.020	19.199	-30.801	50.000
13.822	10.258	27.960	38.218	-11.782	50.000

Note:

1. All Reading Levels are Quasi-Peak and average value.
2. "■" means the worst emission level.
3. Measurement Level = Reading Level + Correct Factor

Product : Medical Cart Computer
 Test Item : Conducted Emission Test
 Power Line : Line 1
 Test Mode : Mode 6: Transmit (802.11ac-80BW-65Mbps) (5775MHz) (22'')

Frequency MHz	Correct Factor dB	Reading Level dBμV	Measurement Level dBμV	Margin dB	Limit dBμV
LINE 1					
Quasi-Peak					
0.166	9.780	42.880	52.660	-12.883	65.543
0.181	9.776	38.290	48.066	-17.048	65.114
0.326	9.774	25.130	34.904	-26.067	60.971
0.392	9.780	14.530	24.310	-34.776	59.086
5.623	10.017	9.080	19.097	-40.903	60.000
14.291	10.145	32.650	42.795	-17.205	60.000
Average					
0.166	9.780	15.990	25.770	-29.773	55.543
0.181	9.776	23.710	33.486	-21.628	55.114
0.326	9.774	12.900	22.674	-28.297	50.971
0.392	9.780	3.440	13.220	-35.866	49.086
5.623	10.017	2.490	12.507	-37.493	50.000
14.291	10.145	28.440	38.585	-11.415	50.000

Note:

1. All Reading Levels are Quasi-Peak and average value.
2. "■" means the worst emission level.
3. Measurement Level = Reading Level + Correct Factor

Product : Medical Cart Computer
 Test Item : Conducted Emission Test
 Power Line : Line 2
 Test Mode : Mode 6: Transmit (802.11ac-80BW-65Mbps) (5775MHz) (22")

Frequency MHz	Correct Factor dB	Reading Level dBμV	Measurement Level dBμV	Margin dB	Limit dBμV
LINE 2					
Quasi-Peak					
0.154	9.831	44.880	54.711	-11.175	65.886
0.170	9.832	41.840	51.672	-13.757	65.429
0.240	9.838	23.490	33.328	-30.101	63.429
2.646	10.018	4.240	14.258	-41.742	56.000
11.552	10.207	23.190	33.397	-26.603	60.000
14.279	10.275	32.450	42.725	-17.275	60.000
Average					
0.154	9.831	26.640	36.471	-19.415	55.886
0.170	9.832	25.880	35.712	-19.717	55.429
0.240	9.838	13.390	23.228	-30.201	53.429
2.646	10.018	-0.180	9.838	-36.162	46.000
11.552	10.207	19.550	29.757	-20.243	50.000
14.279	10.275	26.760	37.035	-12.965	50.000

Note:

1. All Reading Levels are Quasi-Peak and average value.
2. "■" means the worst emission level.
3. Measurement Level = Reading Level + Correct Factor

3. Maximun conducted output power

3.1. Test Equipment

	Equipment	Manufacturer	Model No./Serial No.	Last Cal.
X	Power Meter	Anritsu	ML2495A/6K00003357	May, 2015
X	Power Sensor	Anritsu	MA2411B/0738448	Jun., 2015
X	Spectrum Analyzer	Agilent	N9010A / MY48030495	Apr., 2015

Note:

1. All equipments are calibrated with traceable calibrations. Each calibration is traceable to the national or international standards.
2. The test instruments marked with “X” are used to measure the final test results.

3.2. Test Setup

26dBc Occupied Bandwidth

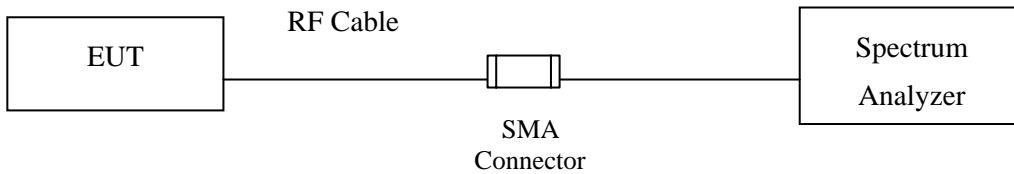

Conduction Power Measurement (for 802.11a)

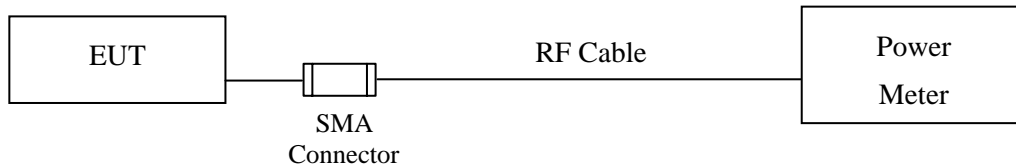

3.3. Limits

3.3.1. For the band 5.15-5.25 GHz,

(i) For an outdoor access point operating in the band 5.15-5.25 GHz, the maximum conducted output power over the frequency band of operation shall not exceed 1 W, provided the maximum antenna gain does not exceed 6 dBi. If transmitting antennas of directional gain greater than 6 dBi are used, the maximum conducted output power shall be reduced by the amount in dB that the directional gain of the antenna exceeds 6 dBi. The maximum e.i.r.p. at any elevation angle above 30 degrees as measured from the horizon must not exceed 125 mW (21 dBm).

(ii) For an indoor access point operating in the band 5.15-5.25 GHz, the maximum conducted output power over the frequency band of operation shall not exceed 1 W provided the maximum antenna gain does not exceed 6 dBi. In addition. If transmitting antennas of directional gain greater than 6 dBi are used, the maximum conducted output power shall be reduced by the amount in dB that the directional gain of the antenna exceeds 6 dBi.

(iii) For fixed point-to-point access points operating in the band 5.15-5.25 GHz, the maximum conducted output power over the frequency band of operation shall not exceed 1 W. Fixed point-to-point U-NII devices may employ antennas with directional gain up to 23 dBi without any corresponding reduction in the maximum conducted output power. For fixed point-to-point transmitters that employ a directional antenna gain greater than 23 dBi, a 1 dB reduction in maximum conducted output power is required for each 1 dB of antenna gain in excess of 23 dBi. Fixed, point-to-point operations exclude the use of point-to-multipoint systems, omnidirectional applications, and multiple collocated transmitters transmitting the same information. The operator of the U-NII device, or if the equipment is professionally installed, the installer, is responsible for ensuring that systems employing high gain directional antennas are used exclusively for fixed, point-to-point operations.

(iv) For mobile and portable client devices in the 5.15-5.25 GHz band, the maximum conducted output power over the frequency band of operation shall not exceed 250 mW provided the maximum antenna gain does not exceed 6 dBi. In addition. If transmitting antennas of directional gain greater than 6 dBi are used, the maximum conducted output power shall be reduced by the amount in dB that the directional gain of the antenna exceeds 6 dBi.

3.3.2. For the 5.25-5.35 GHz and 5.47-5.725 GHz bands, the maximum conducted output power over the frequency bands of operation shall not exceed the lesser of 250 mW or $11 \text{ dBm} + 10 \log B$, where B is the 26 dB emission bandwidth in megahertz. If transmitting antennas of directional gain greater than 6 dBi are used, the maximum conducted output power shall be reduced by the amount in dB that the directional gain of the antenna exceeds 6 dBi.

3.3.3. For the band 5.725-5.85 GHz, the maximum conducted output power over the frequency band of operation shall not exceed 1 W. In addition. If transmitting antennas of directional gain greater than 6 dBi are used, the maximum conducted output power shall be reduced by the amount in dB that the directional gain of the antenna exceeds 6 dBi. However, fixed point-to-point UNII devices operating in

this band may employ transmitting antennas with directional gain greater than 6 dBi without any corresponding reduction in transmitter conducted power. Fixed, point-to-point operations exclude the use of point-to-multipoint systems, omnidirectional applications, and multiple collocated transmitters transmitting the same information. The operator of the U-NII device, or if the equipment is professionally installed, the installer, is responsible for ensuring that systems employing high gain directional antennas are used exclusively for fixed, point-to-point operations.

3.4. Test Procedure

As an alternative to FCC KDB-789033, the EUT maximum conducted output power was measured with an average power meter employing a video bandwidth greater than the 6dB BW of the emission under test. Maximum conducted output power was read directly from the meter across all data rates, and across three channels within each sub-band. Special care was used to make sure that the EUT was transmitting in continuous mode. This method exceeds the limitations of FCC KDB-789033, and provides more accurate measurements.

802.11an (BW \leq 40MHz) Maximum conducted output power using KDB 789033 section E)3)b) Method PM-G (Measurement using a gated RF average power meter)

Note: the power meter have a video bandwidth that is greater than or equal to the measurement bandwidth, (Anritsu/ MA2411B video bandwidth: 65MHz)

802.11ac (BW=80MHz) Maximum conducted output power using KDB 789033 section E)2)b) Method SA-1 (trace averaging with the EUT transmitting at full power throughout each sweep).

When transmitted signals consist of two or more non-contiguous spectrum segments (e.g., 80+80 MHz mode) or when a single spectrum segment of a transmission crosses the boundary between two adjacent U-NII bands, KDB 644545 D01 section F) procedure is used for measurements.

3.5. Uncertainty

± 1.27 dB

3.6. Test Result of Maximum conducted output power

Product : Medical Cart Computer
 Test Item : Maximum conducted output power
 Test Site : No.3 OATS
 Test Mode : Mode 1: Transmit (802.11a-6Mbps) (19''+22''+24'')

CHAIN A

Cable loss=1dB		Maximum conducted output power								
Channel No.	Frequency (MHz)	Data Rate (Mbps)								Required Limit
		6	9	12	18	24	36	48	54	
		Measurement Level (dBm)								
36	5180	15.32	--	--	--	--	--	--	--	<24dBm
44	5220	16.83	16.78	16.71	16.65	16.59	16.53	16.47	16.41	<24dBm
48	5240	16.77	--	--	--	--	--	--	--	<24dBm
52	5260	17.83	--	--	--	--	--	--	--	<24dBm
60	5300	17.26	17.19	17.04	16.94	16.83	16.72	16.61	16.50	<24dBm
64	5320	14.61	--	--	--	--	--	--	--	<24dBm
100	5500	14.32	--	--	--	--	--	--	--	<24dBm
116	5580	16.87	16.79	16.72	16.64	16.57	16.49	16.42	16.34	<24dBm
140	5700	14.92	--	--	--	--	--	--	--	<24dBm
149	5745	16.85	--	--	--	--	--	--	--	<30dBm
157	5785	16.89	16.83	16.72	16.64	16.56	16.47	16.39	16.30	<30dBm
165	5825	17.13	--	--	--	--	--	--	--	<30dBm

Note: Maximum conducted output power Value =Reading value on average power meter + cable loss

CHAIN B

Cable loss=1dB		Maximum conducted output power								
Channel No.	Frequency (MHz)	Data Rate (Mbps)								Required Limit
		6	9	12	18	24	36	48	54	
		Measurement Level (dBm)								
36	5180	16.38	--	--	--	--	--	--	--	<24dBm
44	5220	17.73	17.64	17.58	17.5	17.43	17.35	17.28	17.2	<24dBm
48	5240	17.68	--	--	--	--	--	--	--	<24dBm
52	5260	18.47	--	--	--	--	--	--	--	<24dBm
60	5300	18.28	18.15	18.03	17.90	17.78	17.65	17.53	17.40	<24dBm
64	5320	15.73	--	--	--	--	--	--	--	<24dBm
100	5500	15.45	--	--	--	--	--	--	--	<24dBm
116	5580	17.92	17.83	17.74	17.65	17.56	17.47	17.38	17.29	<24dBm
140	5700	15.80	--	--	--	--	--	--	--	<24dBm
149	5745	17.70	--	--	--	--	--	--	--	<30dBm
157	5785	17.86	17.69	17.58	17.43	17.29	17.15	17.01	16.87	<30dBm
165	5825	18.18	--	--	--	--	--	--	--	<30dBm

Note: Maximum conducted output power Value =Reading value on average power meter + cable loss

Maximum conducted output power Measurement:

CHAIN B

Channel No	Frequency Range (MHz)	99% Bandwidth (MHz)	Output Power (dBm)	Output Power Limit	
				(dBm)	dBm+10log(BW)
36	5180	--	16.38	24	--
44	5220	--	17.73	24	--
48	5240	--	17.68	24	--
52	5260	17.463	18.47	24	23.42
60	5300	17.483	18.28	24	23.43
64	5320	17.510	15.73	24	23.43
100	5500	17.374	15.45	24	23.40
116	5580	17.452	17.92	24	23.42
140	5700	17.454	15.80	24	23.42
149	5745	--	17.70	30	--
157	5785	--	17.86	30	--
165	5825	--	18.18	30	--

Note:

1. Power Output Value = Reading value on average power meter + cable loss

**99% Occupied Bandwidth:
Channel 52:**

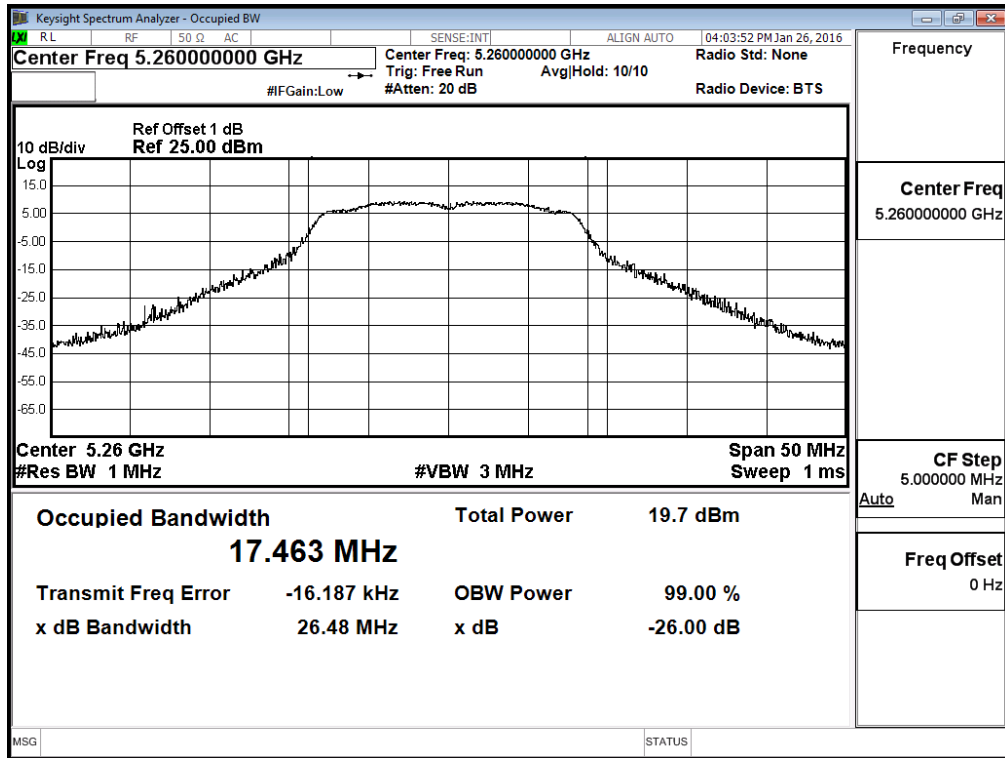

Channel 60:

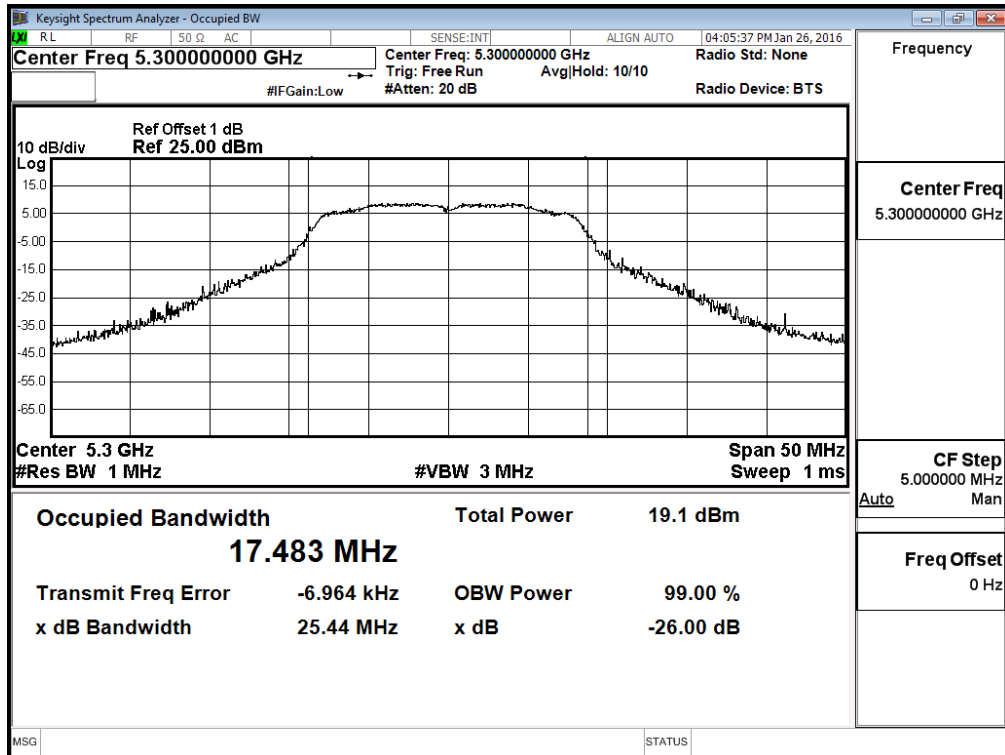

Channel 64:

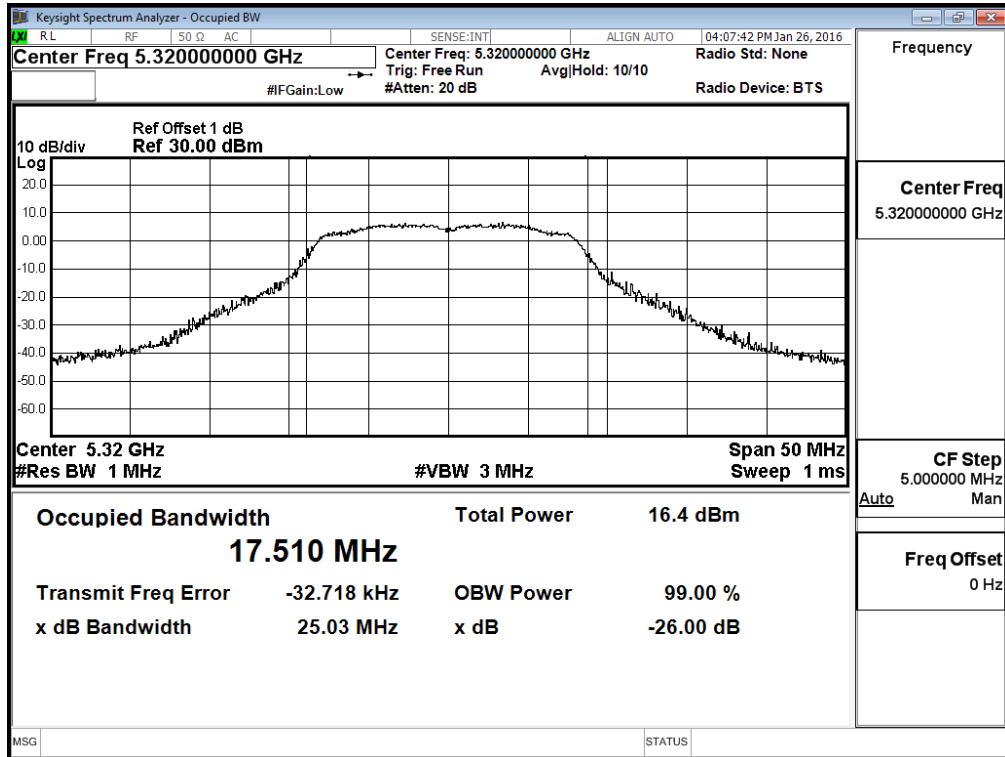

Channel 100:

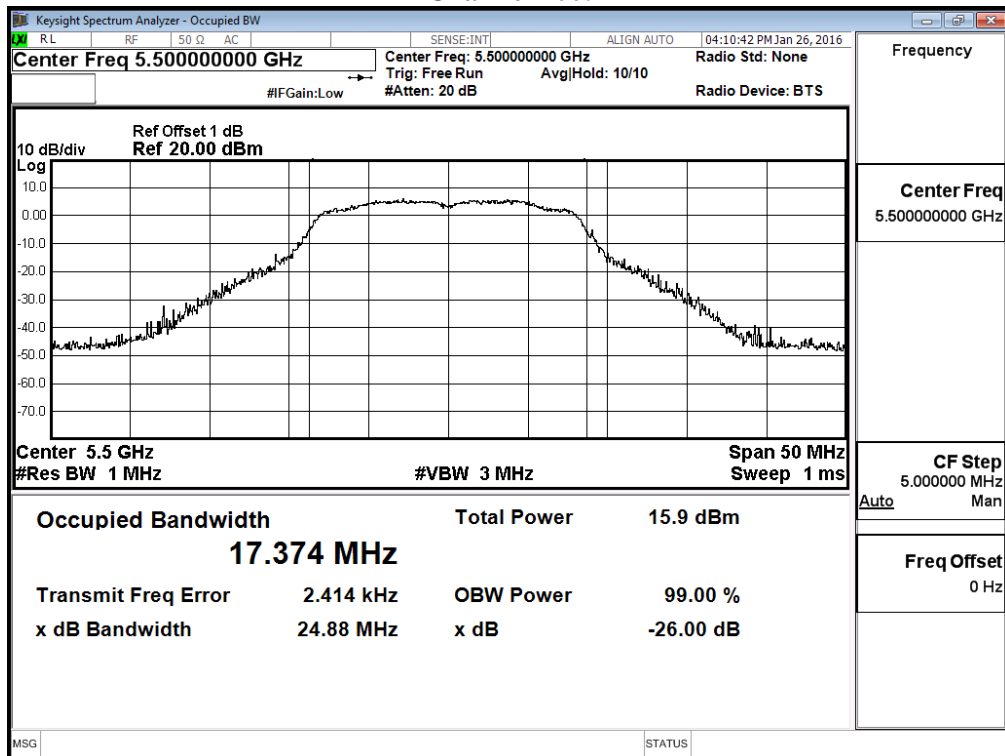

Channel 116:

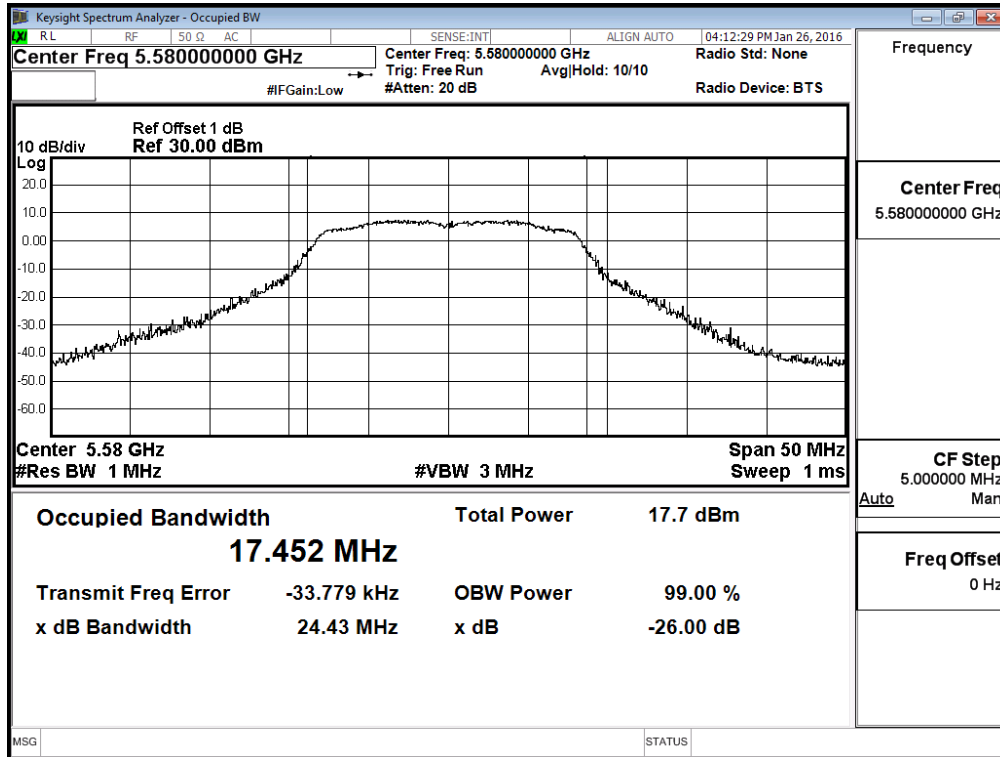

Channel 140:

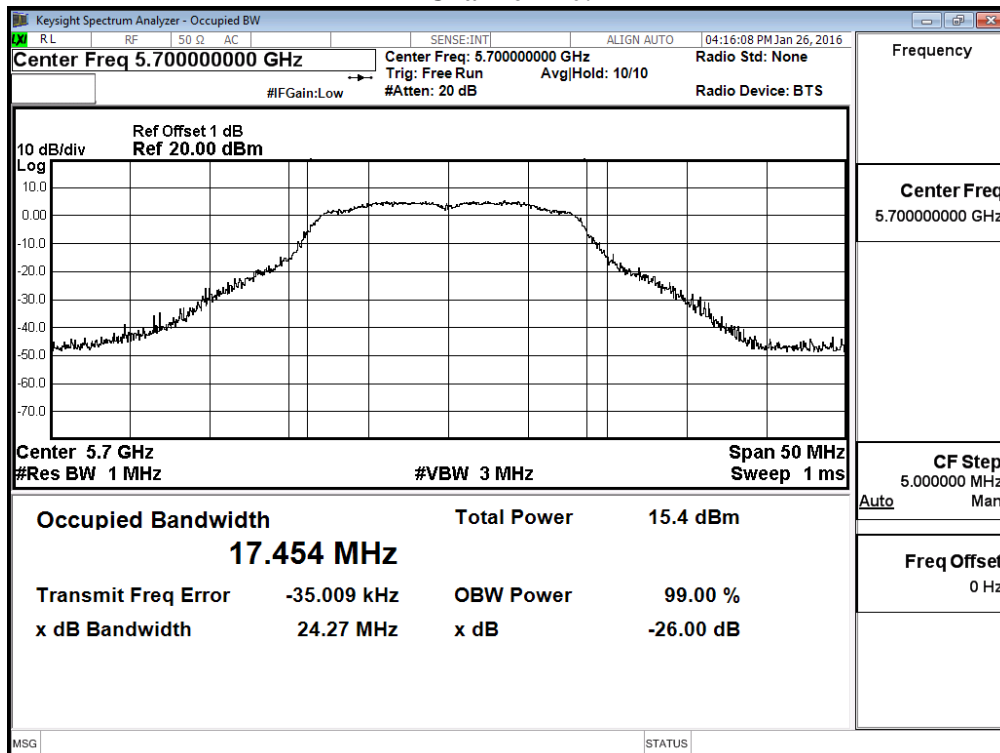

Product : Medical Cart Computer
 Test Item : Maximum conducted output power
 Test Site : No.3 OATS
 Test Mode : Mode 2: Transmit (802.11n-20BW 14.4Mbps) (19''+22''+24'')

CHAIN A

Cable loss=1dB		Maximum conducted output power								
Channel No.	Frequency (MHz)	Data Rate (Mbps)								Required Limit
		HT8	HT9	HT10	HT11	HT12	HT13	HT14	HT15	
		Measurement Level (dBm)								
36	5180	12.86	--	--	--	--	--	--	--	<24dBm
44	5220	13.10	13.08	12.99	12.95	12.89	12.84	12.78	12.73	<24dBm
48	5240	12.63	--	--	--	--	--	--	--	<24dBm
52	5260	15.08	--	--	--	--	--	--	--	<24dBm
60	5300	15.32	15.28	15.22	15.17	15.12	15.07	15.02	14.97	<24dBm
64	5320	13.32	--	--	--	--	--	--	--	<24dBm
100	5500	12.72	--	--	--	--	--	--	--	<24dBm
116	5580	15.55	15.45	15.32	15.21	15.10	14.98	14.865	14.75	<24dBm
140	5700	11.96	--	--	--	--	--	--	--	<24dBm
149	5745	14.70	--	--	--	--	--	--	--	<30dBm
157	5785	15.70	15.66	15.54	15.47	15.39	15.31	15.23	15.15	<30dBm
165	5825	15.86	--	--	--	--	--	--	--	<30dBm

Note: Maximum conducted output power Value =Reading value on average power meter + cable loss

CHAIN B

Cable loss=1dB		Maximum conducted output power								
Channel No.	Frequency (MHz)	Data Rate (Mbps)								Required Limit
		HT8	HT9	HT10	HT11	HT12	HT13	HT14	HT15	
		Measurement Level (dBm)								
36	5180	12.13	--	--	--	--	--	--	--	<24dBm
44	5220	12.21	12.09	11.96	11.84	11.71	11.59	11.46	11.34	<24dBm
48	5240	13.08	--	--	--	--	--	--	--	<24dBm
52	5260	14.73	--	--	--	--	--	--	--	<24dBm
60	5300	15.07	15.01	14.93	14.86	14.79	14.72	14.65	14.58	<24dBm
64	5320	12.89	--	--	--	--	--	--	--	<24dBm
100	5500	11.88	--	--	--	--	--	--	--	<24dBm
116	5580	15.01	14.91	14.82	14.72	14.63	14.53	14.44	14.34	<24dBm
140	5700	11.72	--	--	--	--	--	--	--	<24dBm
149	5745	15.20	--	--	--	--	--	--	--	<30dBm
157	5785	15.03	14.91	14.84	14.74	14.64	14.55	14.45	14.36	<30dBm
165	5825	14.56	--	--	--	--	--	--	--	<30dBm

Note: Maximum conducted output power Value =Reading value on average power meter + cable loss

Maximum conducted output power Measurement:

(CHAIN A+ B)

Channel Number	Frequency (MHz)	99% Bandwidth (MHz)	Chain A Power (dBm)	Chain B Power (dBm)	Output Power (dBm)	Output Power Limit	
						(dBm)	dBm+10log(BW)
36	5180	--	12.86	12.13	15.52	24	--
44	5220	--	13.10	12.21	15.69	24	--
48	5240	--	12.63	13.08	15.87	24	--
52	5260	18.353	15.08	14.73	17.92	24	23.64
60	5300	18.399	15.32	15.07	18.21	24	23.65
64	5320	18.436	13.32	12.89	16.12	24	23.66
100	5500	18.304	12.72	11.88	15.33	24	23.63
116	5580	18.299	15.55	15.01	18.30	24	23.62
140	5700	18.329	11.96	11.72	14.85	24	23.63
149	5745	--	14.70	15.20	17.97	30	--
157	5785	--	15.70	15.03	18.39	30	--
165	5825	--	15.86	14.56	18.27	30	--

Note:

1. Power Output Value =Reading value on average power meter + cable loss
2. Output Power (dBm) = 10LOG (Chain A Power (mW)+ Chain B Power (mW))
3. 99% Bandwidth is the bandwidth of chain A or chain B whichever is less bandwidth, output power limitation is more stringent.

99% Occupied Bandwidth: Channel 52 -Chain A

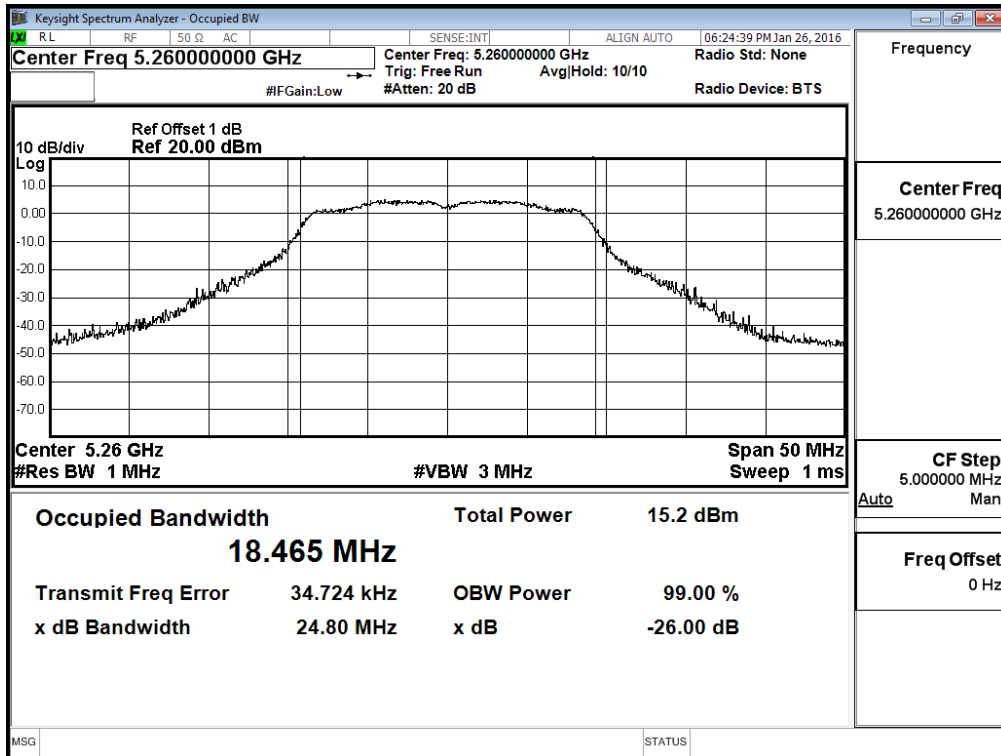

Channel 60 -Chain A

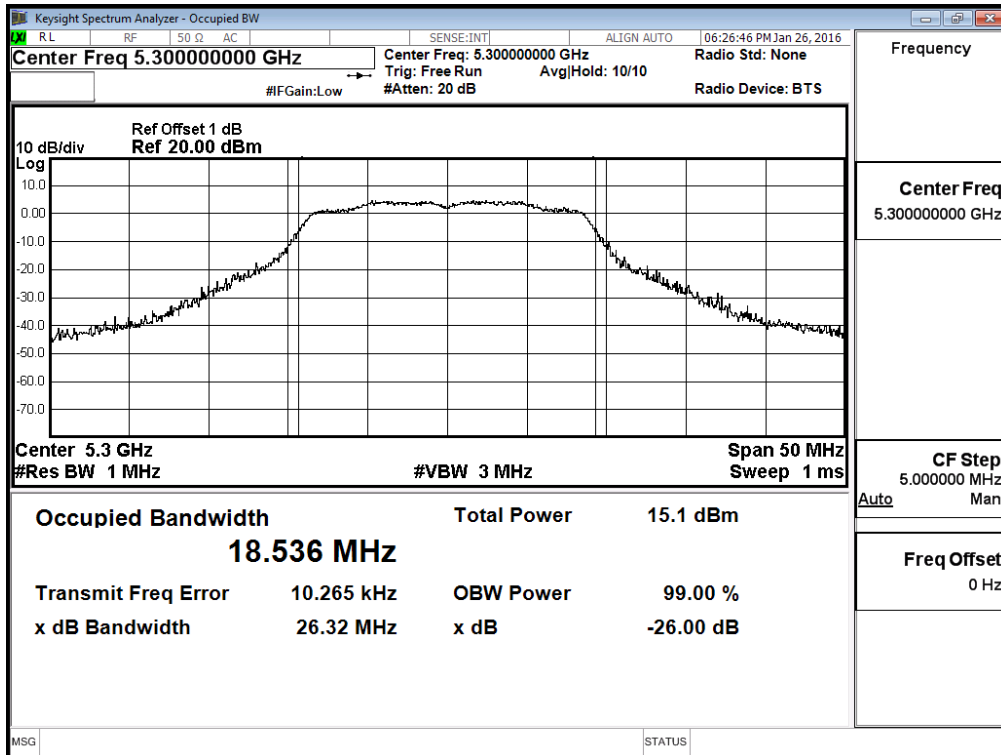

Channel 64 -Chain A

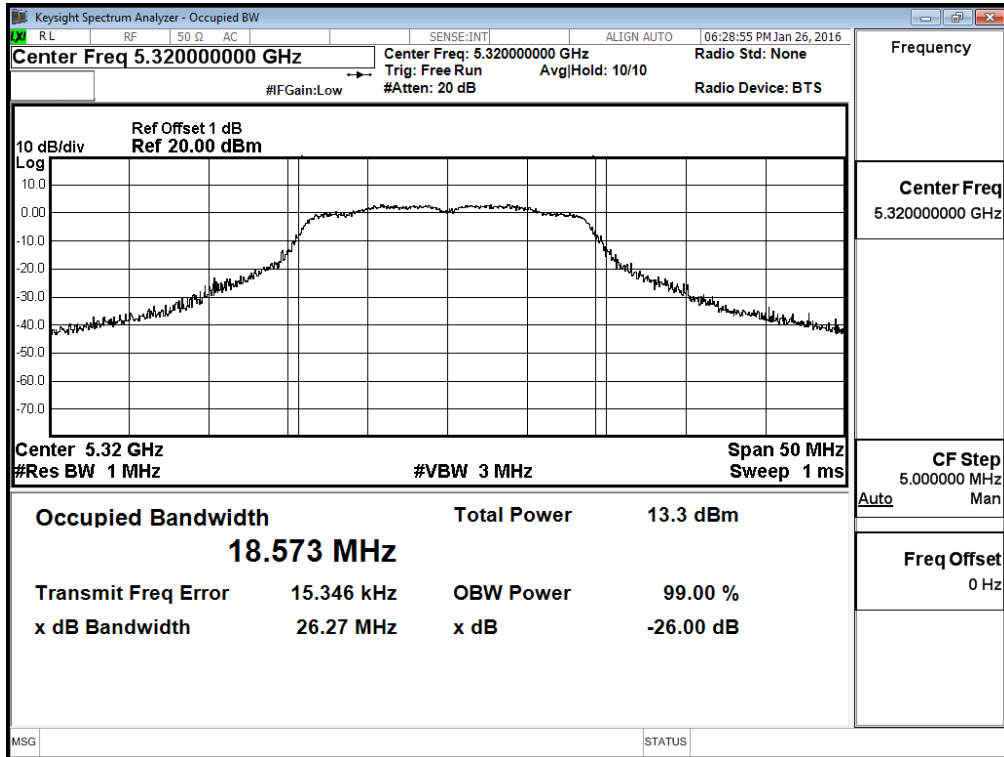

Channel 100 -Chain A

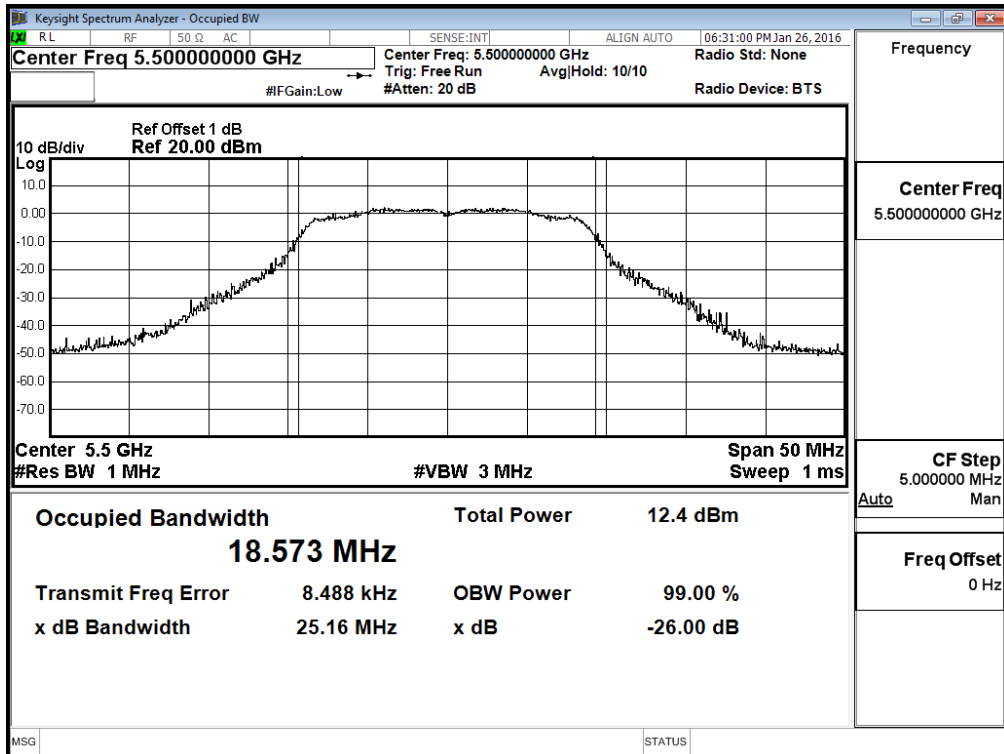

Channel 116 -Chain A

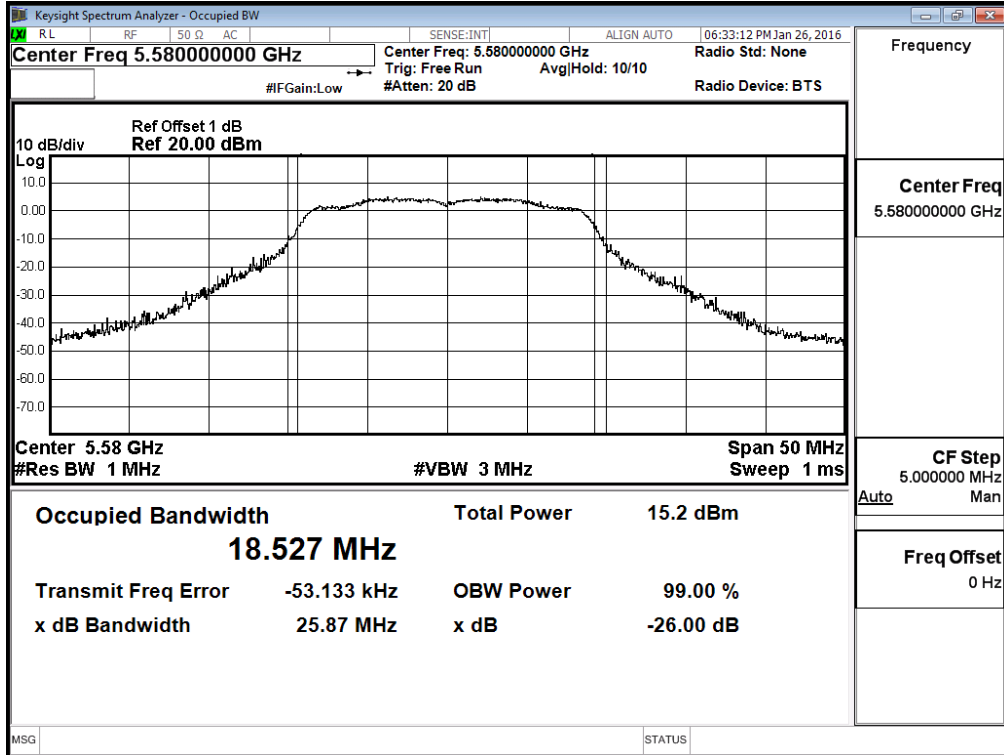

Channel 140 -Chain A

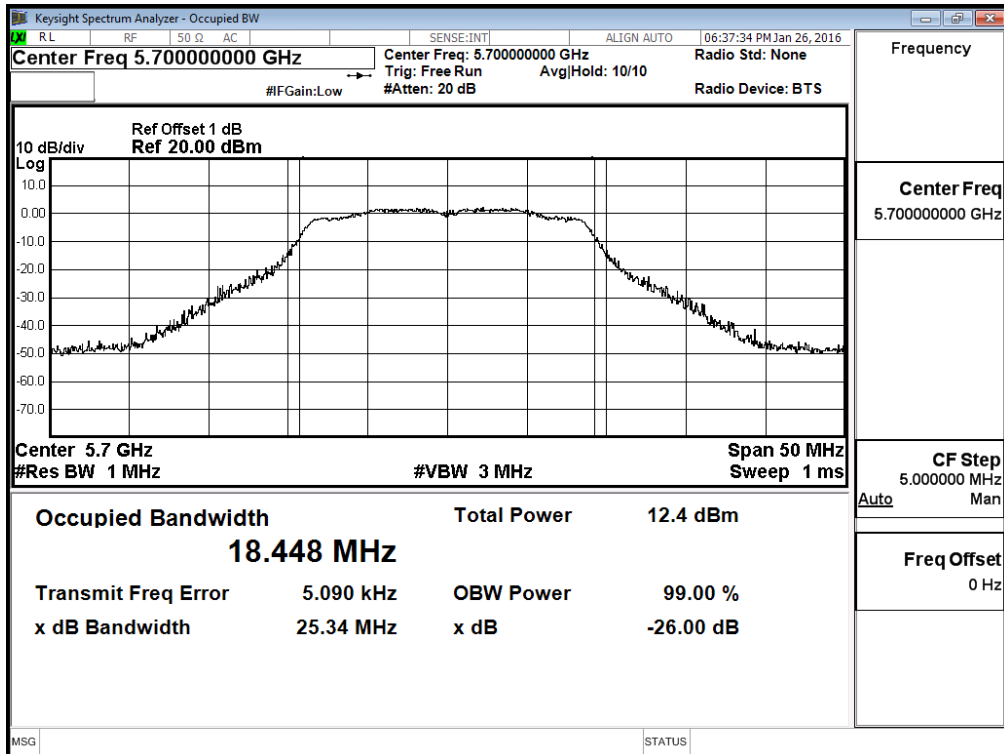

**99% Occupied Bandwidth:
Channel 52 -Chain B**

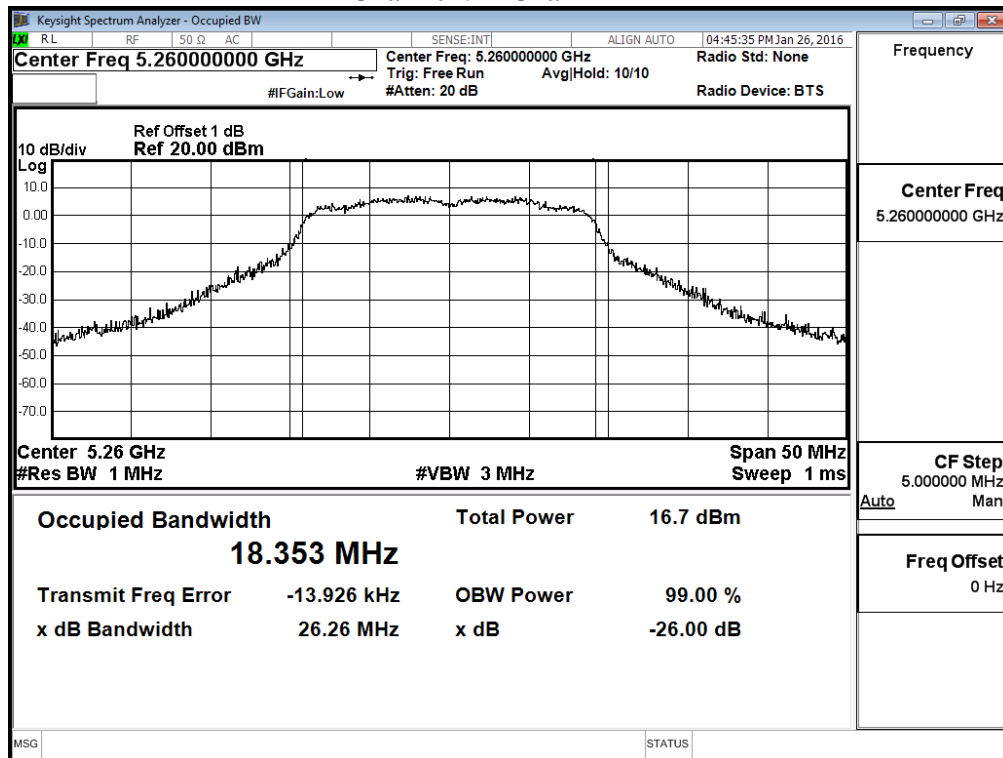

Channel 60 -Chain B

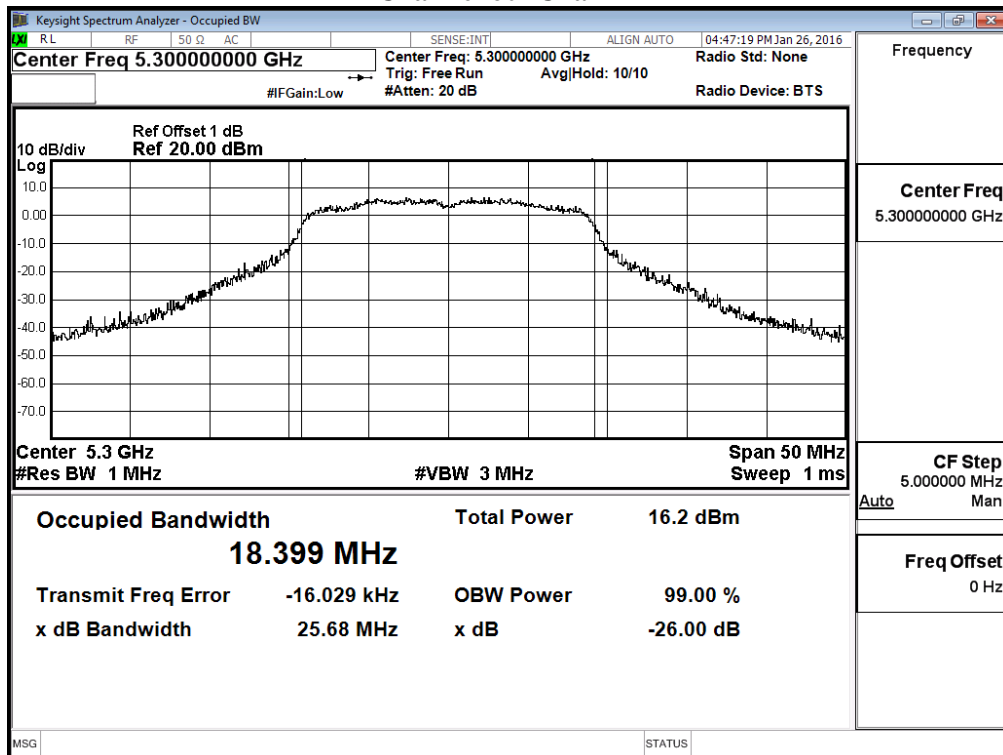

Channel 64 -Chain B

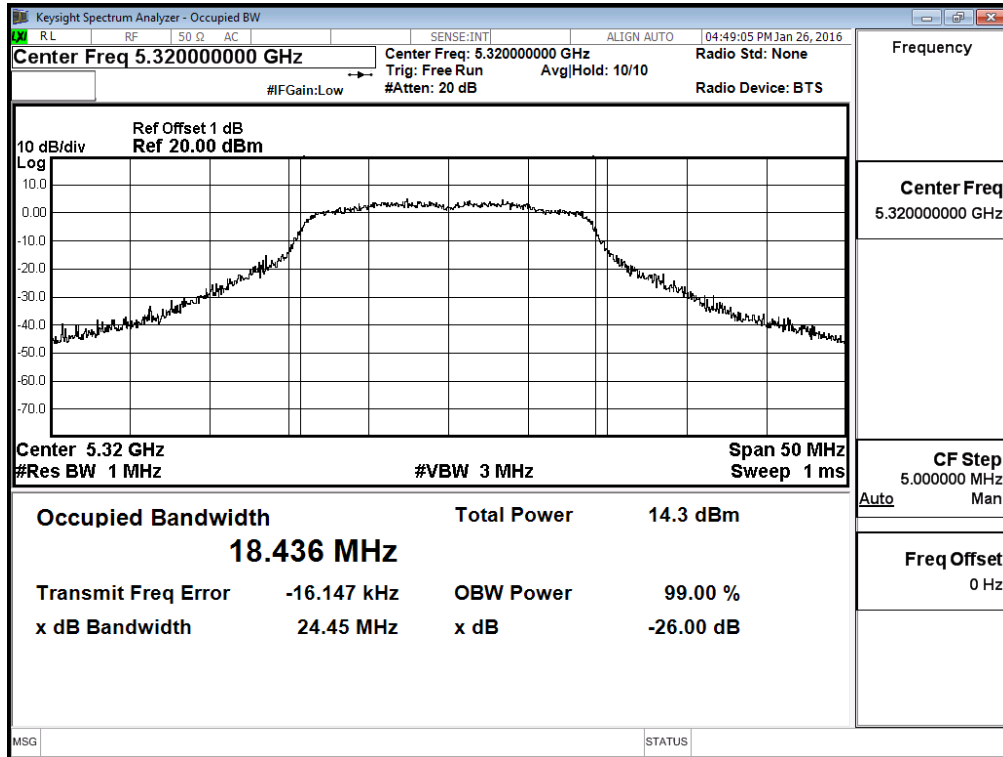

Channel 100 -Chain B

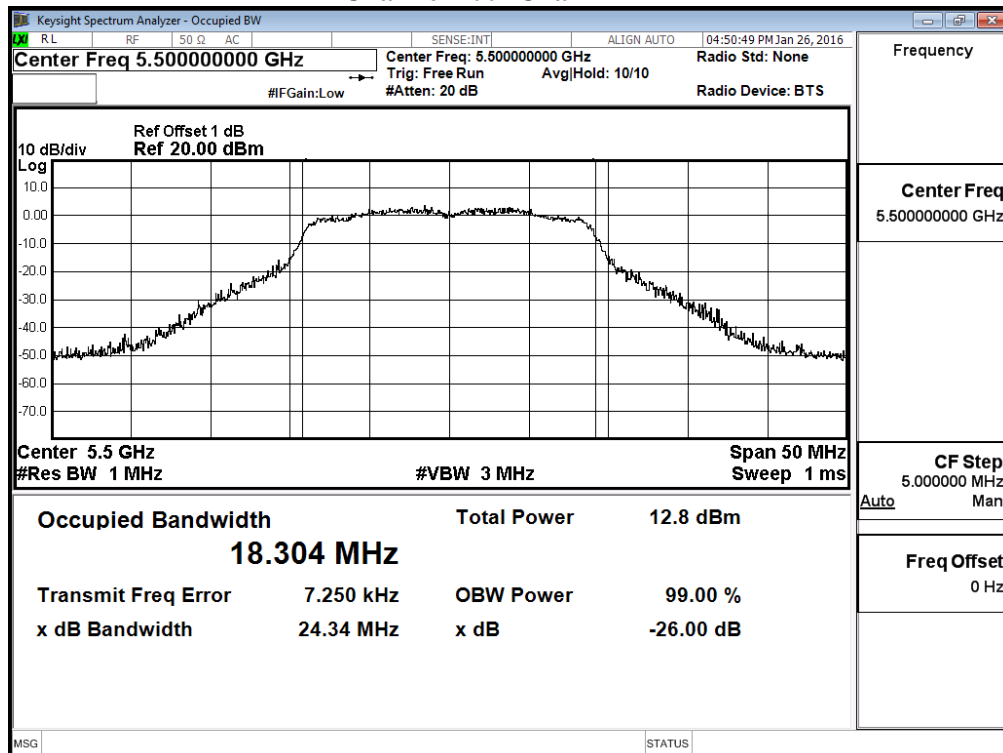

Channel 116 -Chain B

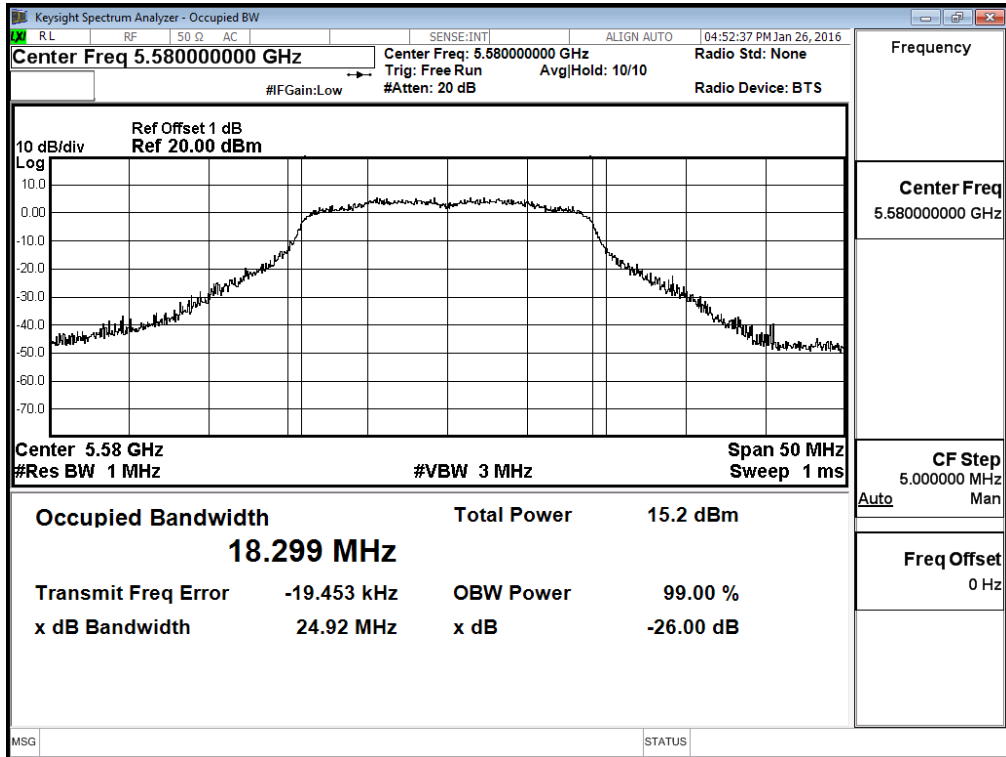

Channel 140 -Chain B

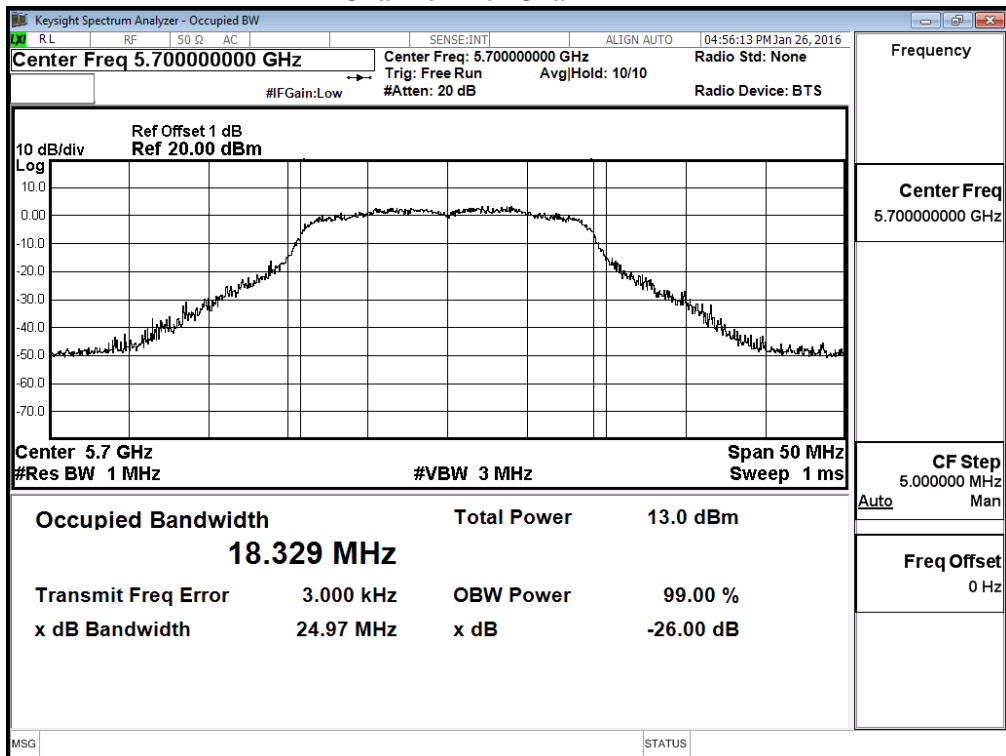

Product : Medical Cart Computer
 Test Item : Maximum conducted output power
 Test Site : No.3 OATS
 Test Mode : Mode 3: Transmit (802.11n-40BW 30Mbps) (19''+22''+24'')

CHAIN A

Cable loss=1dB		Maximum conducted output power								
Channel No.	Frequency (MHz)	Data Rate (Mbps)								Required Limit
		HT8	HT9	HT10	HT11	HT12	HT13	HT14	HT15	
		Measurement Level (dBm)								
38	5190	10.73	--	--	--	--	--	--	--	<24dBm
46	5230	14.81	14.74	14.62	14.53	14.44	14.34	14.25	14.15	<24dBm
54	5270	14.07	--	--	--	--	--	--	--	<24dBm
62	5310	12.27	12.19	12.06	11.96	11.86	11.75	11.65	11.54	<24dBm
102	5510	12.62	--	--	--	--	--	--	--	<24dBm
110	5550	15.47	15.29	15.17	15.01	14.86	14.71	14.56	14.41	<24dBm
134	5670	14.70	--	--	--	--	--	--	--	<24dBm
151	5755	14.68	--	--	--	--	--	--	--	<30dBm
159	5795	15.48	15.4	15.33	15.25	15.18	15.10	15.03	14.95	<30dBm

Note: Maximum conducted output power Value =Reading value on average power meter + cable loss

CHAIN B

Cable loss=1dB		Maximum conducted output power								
Channel No.	Frequency (MHz)	Data Rate (Mbps)								Required Limit
		HT8	HT9	HT10	HT11	HT12	HT13	HT14	HT15	
		Measurement Level (dBm)								
38	5190	9.92	--	--	--	--	--	--	--	<24dBm
46	5230	14.88	14.72	14.59	14.44	14.30	14.15	14.01	13.86	<24dBm
54	5270	14.14	--	--	--	--	--	--	--	<24dBm
62	5310	12.08	11.97	11.82	11.70	11.57	11.44	11.31	11.18	<24dBm
102	5510	11.78	--	--	--	--	--	--	--	<24dBm
110	5550	14.60	14.48	14.35	14.23	14.10	13.98	13.85	13.73	<24dBm
134	5670	14.70	--	--	--	--	--	--	--	<24dBm
151	5755	15.27	--	--	--	--	--	--	--	<30dBm
159	5795	15.18	15.12	14.96	14.87	14.76	14.65	14.54	14.43	<30dBm

Note: Maximum conducted output power Value =Reading value on average power meter + cable loss

Maximum conducted output power Measurement:

(CHAIN A+ B)

Channel Number	Frequency (MHz)	99% Bandwidth (MHz)	Chain A Power (dBm)	Chain B Power (dBm)	Output Power (dBm)	Output Power Limit	
						(dBm)	dBm+10log(BW)
38	5190	--	10.73	9.92	13.35	24	--
46	5230	--	14.81	14.88	17.86	24	--
54	5270	36.256	14.07	14.14	17.12	24	26.59
62	5310	36.246	12.27	12.08	15.19	24	26.59
102	5510	36.225	12.62	11.78	15.23	24	26.59
110	5550	36.307	15.47	14.60	18.07	24	26.60
134	5670	36.208	14.70	14.70	17.71	24	26.59
151	5755	--	14.68	15.27	18.00	30	--
159	5795	--	15.48	15.18	18.34	30	--

Note:

1. Power Output Value =Reading value on average power meter + cable loss
2. Output Power (dBm) = 10LOG (Chain A Power (mW)+ Chain B Power (mW))
3. 99% Bandwidth is the bandwidth of chain A or chain B whichever is less bandwidth, output power limitation is more stringent.

99% Occupied Bandwidth:

Channel 54 – Chain A

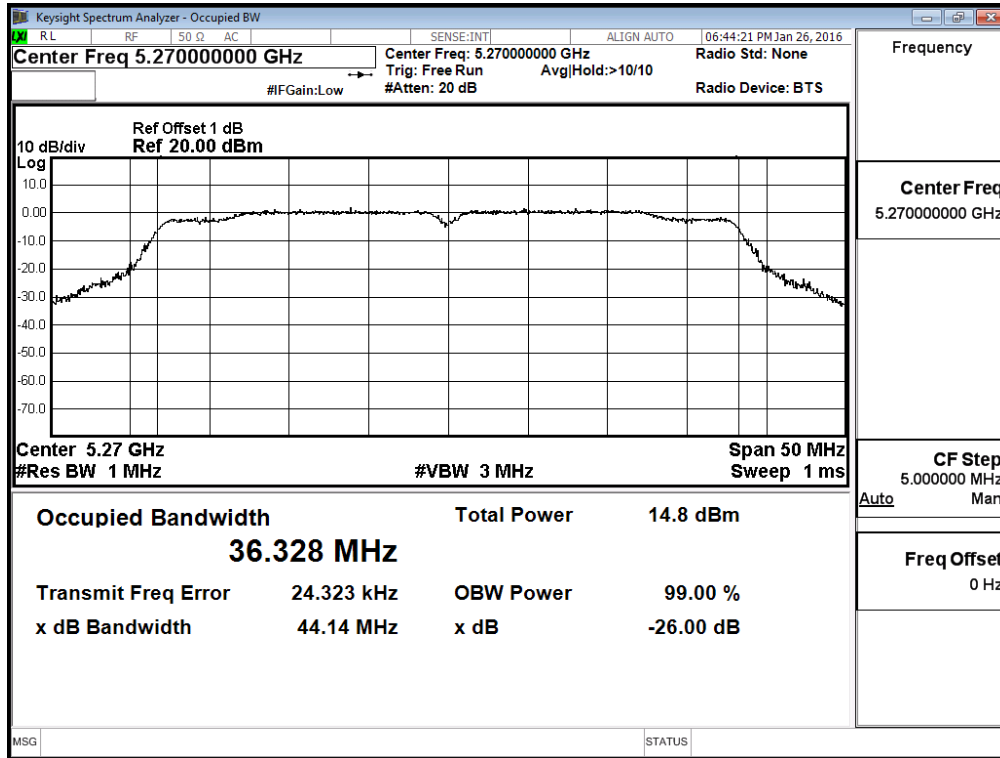

Channel 62 – Chain A

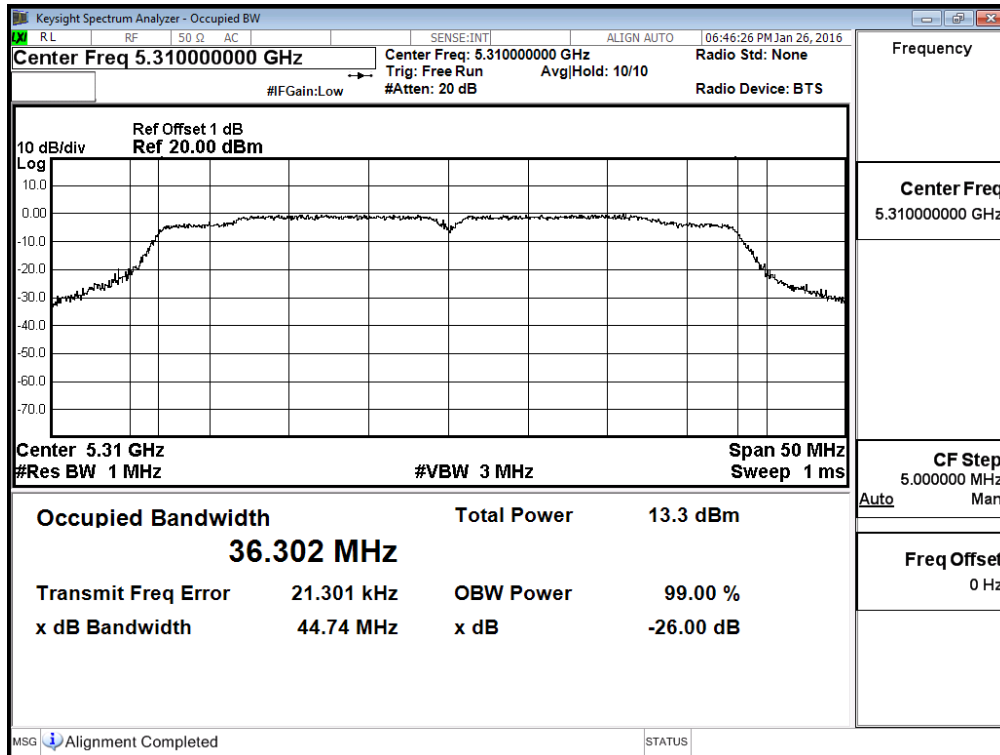

Channel 102 – Chain A

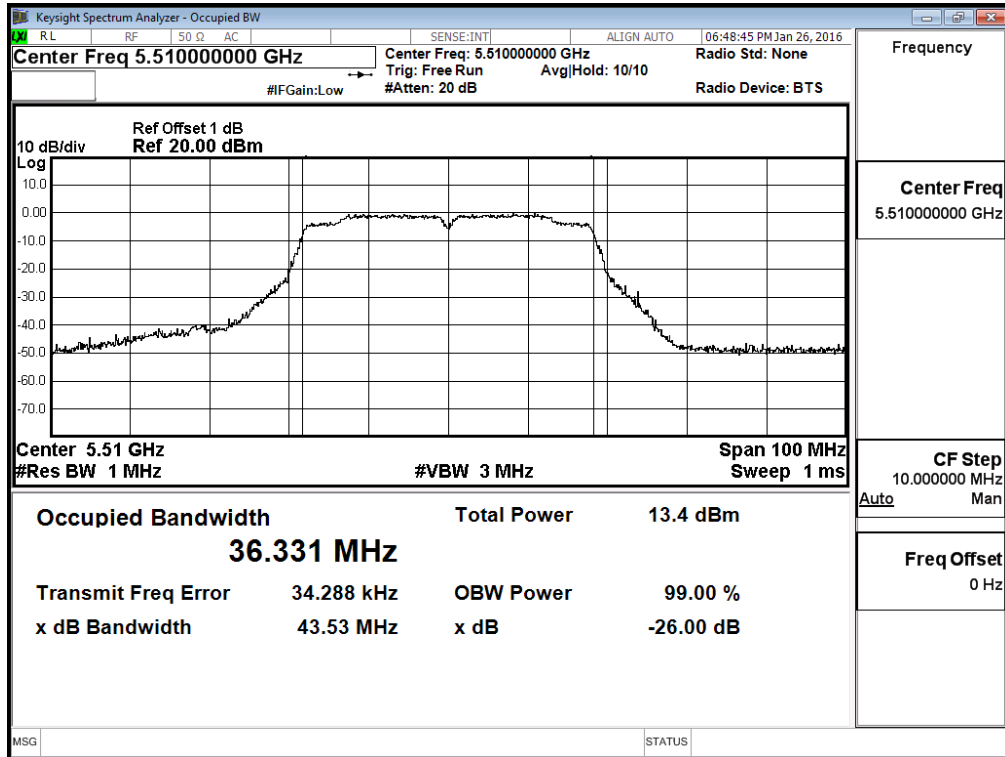

Channel 110 – Chain A

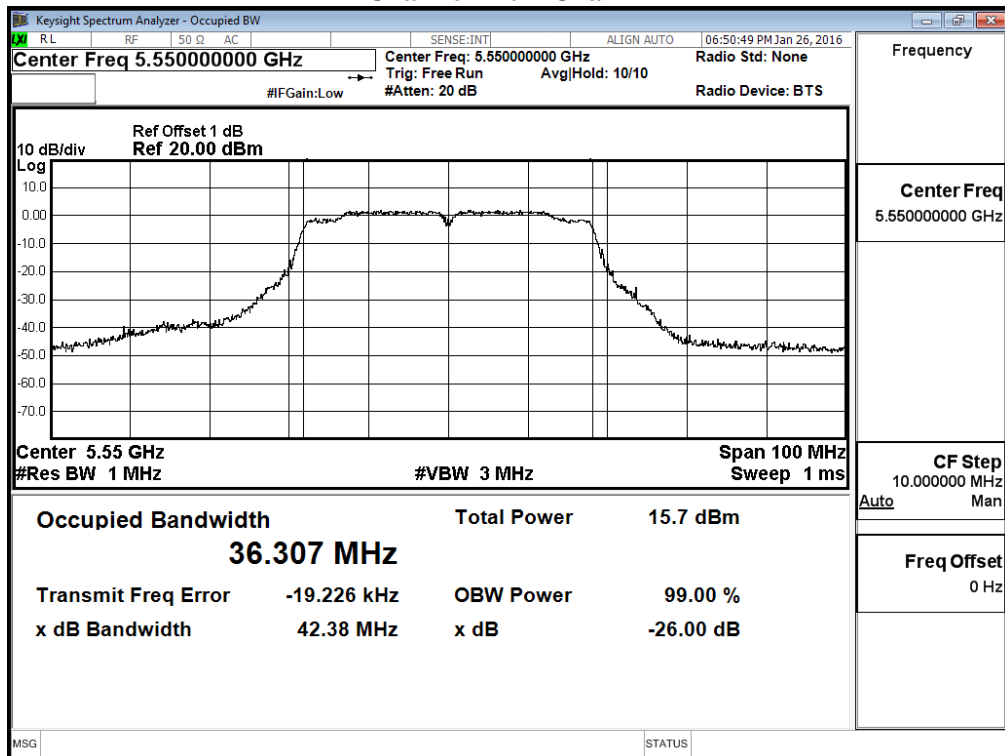

Channel 134 – Chain A

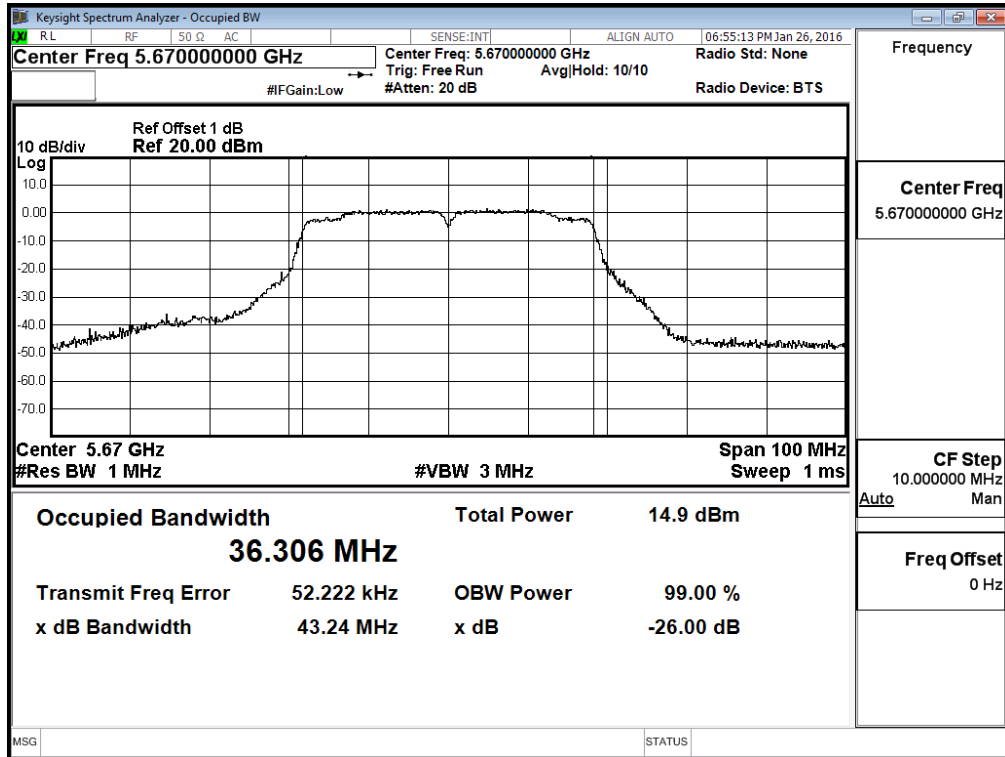

**99% Occupied Bandwidth:
Channel 54 – Chain B**

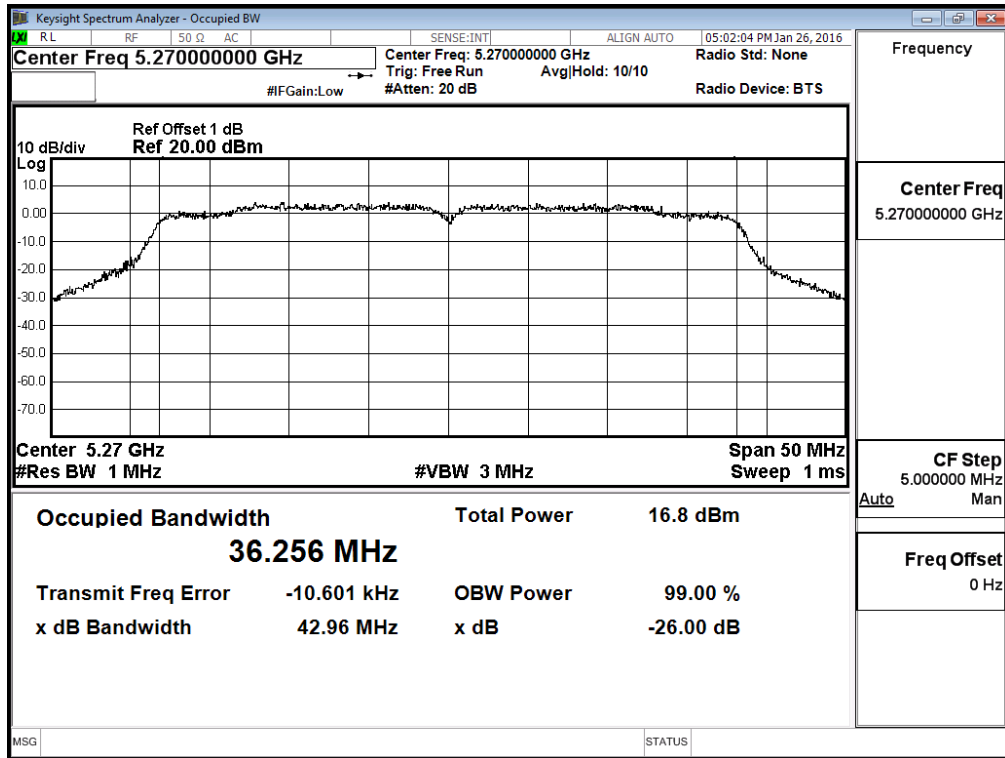

Channel 62 – Chain B

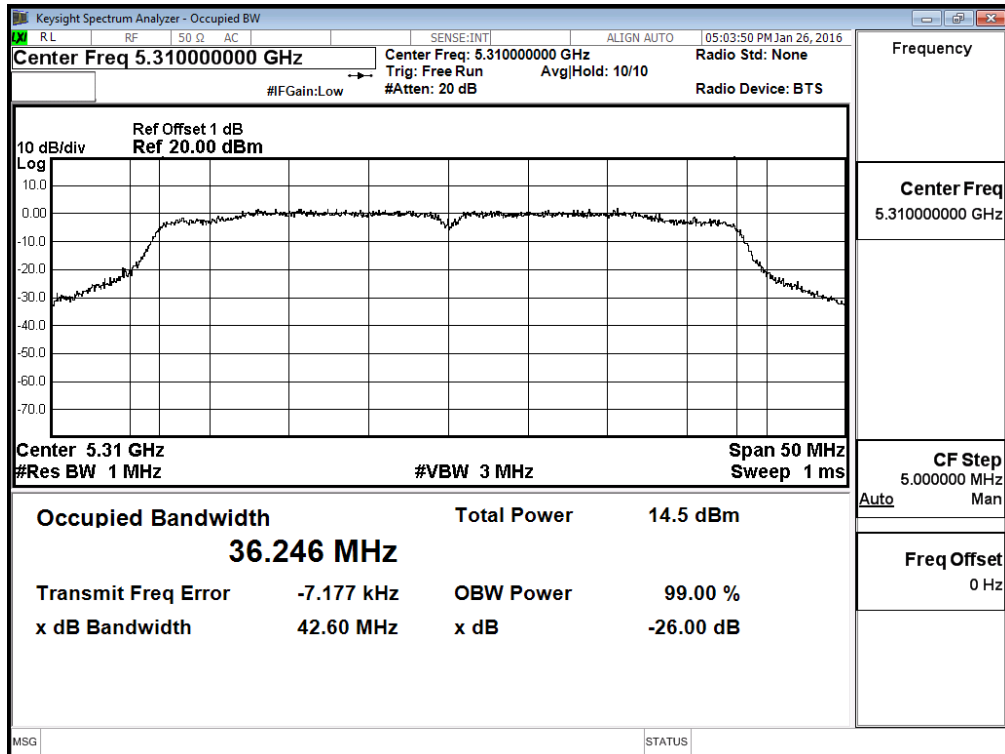

Channel 102 – Chain B

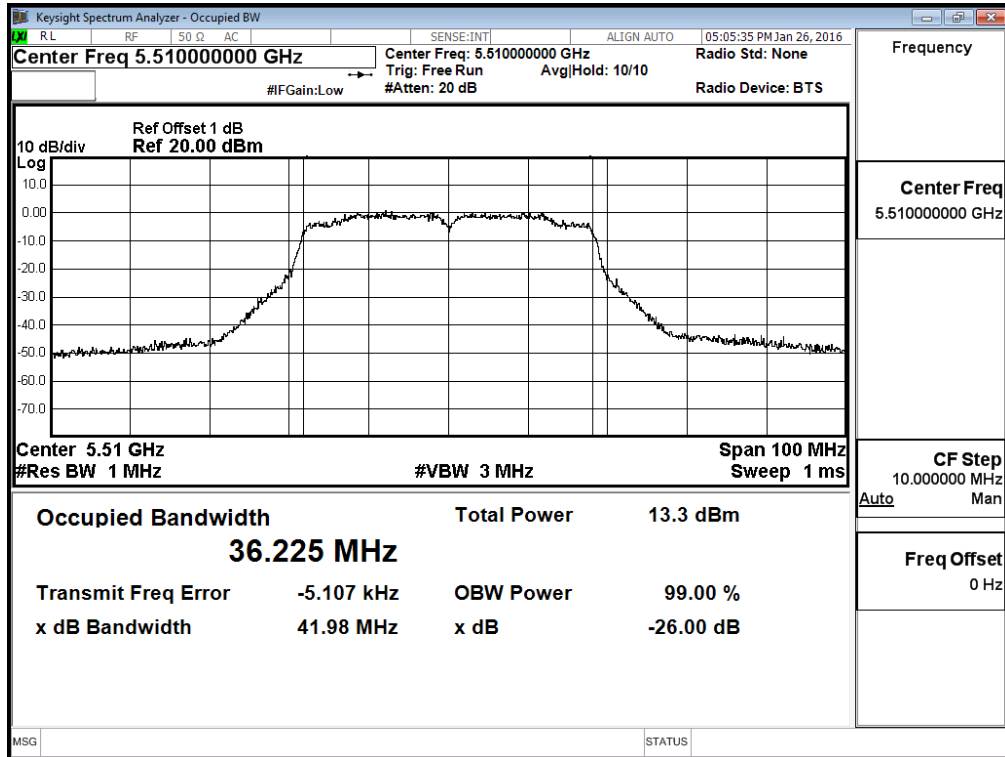

Channel 110 – Chain B

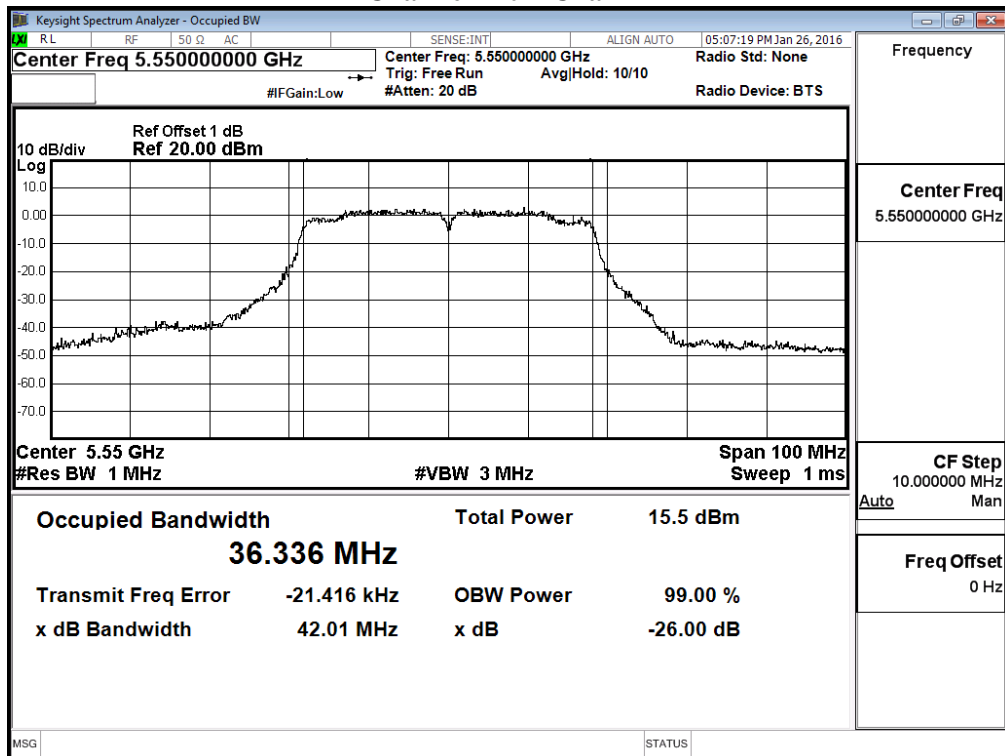

Channel 134 – Chain B

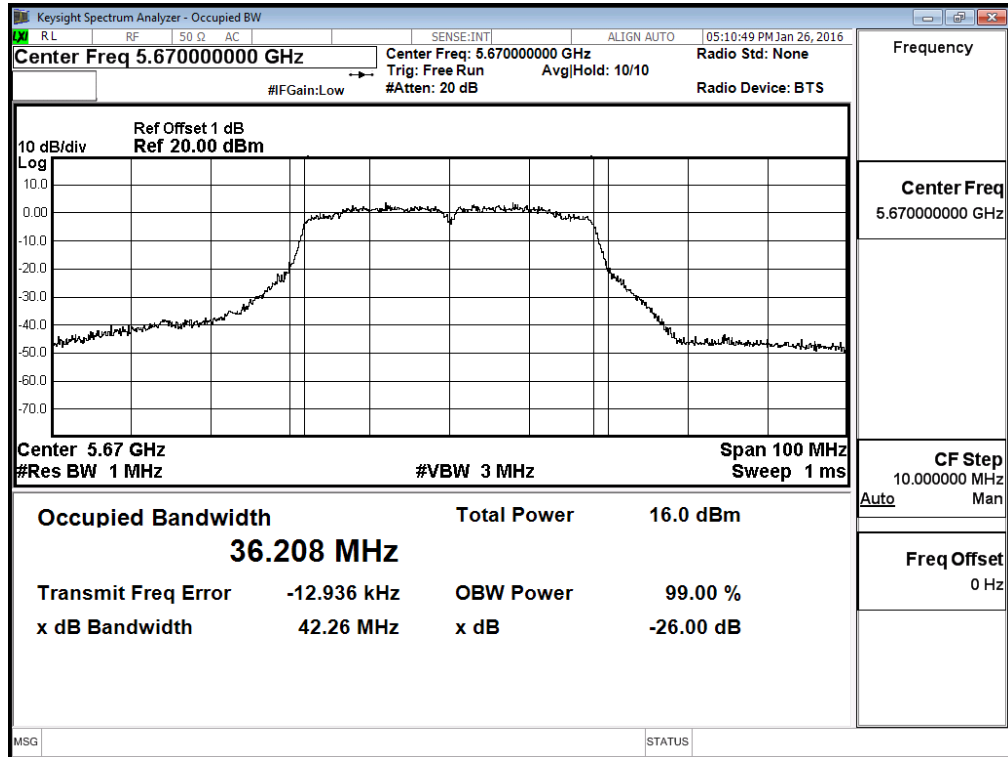

Product : Medical Cart Computer
 Test Item : Maximum conducted output power
 Test Site : No.3 OATS
 Test Mode : Mode 4: Transmit (802.11ac-20BW-14.4Mbps) (19''+22''+24'')

Chain A

Cable loss=1dB		Maximum conducted output power									
Channel No.	Frequency (MHz)	Data Rate (Mbps)									Required Limit
		VTH0	VTH1	VTH2	VTH3	VTH4	VTH5	VTH6	VTH7	VTH8	
		Measurement Level (dBm)									
144 (Band3)	5720	8.03	7.97	7.86	7.78	7.70	7.61	7.53	7.44	7.36	<24dBm
144 (Band4)	5720	0.60	0.52	0.45	0.37	0.30	0.22	0.15	0.07	0.00	<30dBm

Chain B

Cable loss=1dB		Maximum conducted output power									
Channel No.	Frequency (MHz)	Data Rate (Mbps)									Required Limit
		VTH0	VTH1	VTH2	VTH3	VTH4	VTH5	VTH6	VTH7	VTH8	
		Measurement Level (dBm)									
144 (Band3)	5720	6.80	6.72	6.67	6.6	6.54	6.47	6.41	6.34	6.28	<24dBm
144 (Band4)	5720	-0.37	-0.42	-0.48	-0.53	-0.59	-0.64	-0.70	-0.75	-0.81	<30dBm

Maximum conducted output power Measurement:

Channel No	Frequency Range (MHz)	99% Bandwidth (MHz)	Chain A Power (dBm)	Chain B Power (dBm)	Output Power (dBm)	Output Power Limit		Result
						(dBm)	dBm+10log(BW)	
144(Band3)	5720	14.360	8.030	6.800	10.47	24	22.57	Pass
144(Band4)	5720	--	0.600	-0.370	3.15	30	--	Pass

Note:

- Output Power (dBm) = 10LOG (Chain A Power (mW)+ Chain B Power (mW))
- 99% Bandwidth is the bandwidth of chain A or chain B whichever is less bandwidth, output power limitation is more stringent.

99% Occupied Bandwidth:
Channel 144 – Chain A

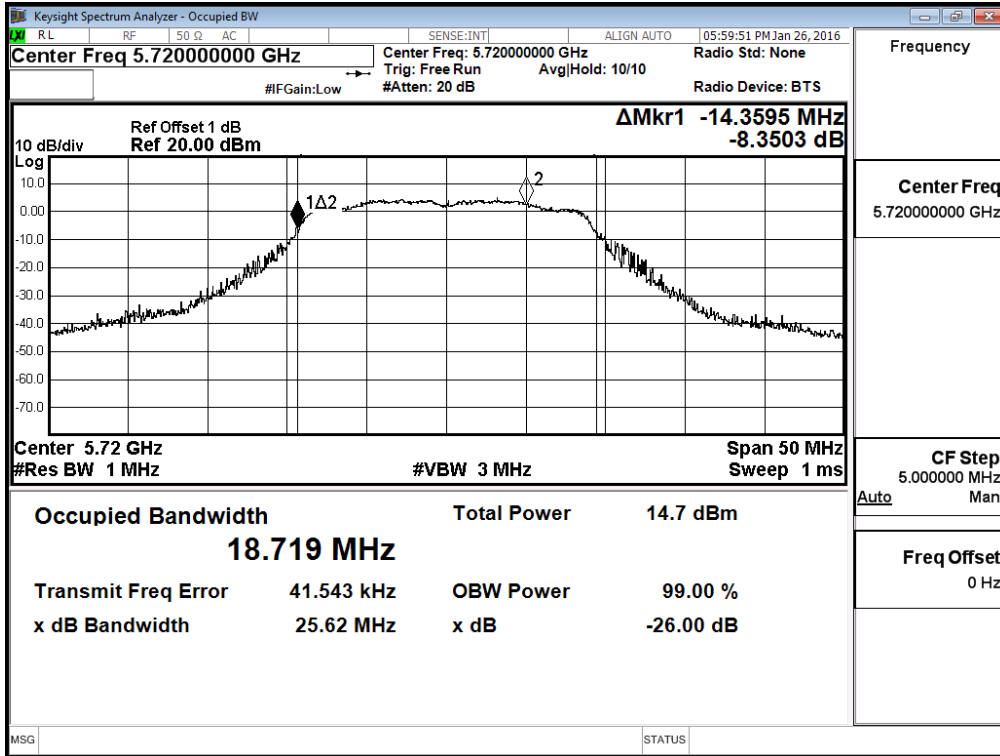

99% Occupied Bandwidth:
Channel 144 – Chain B

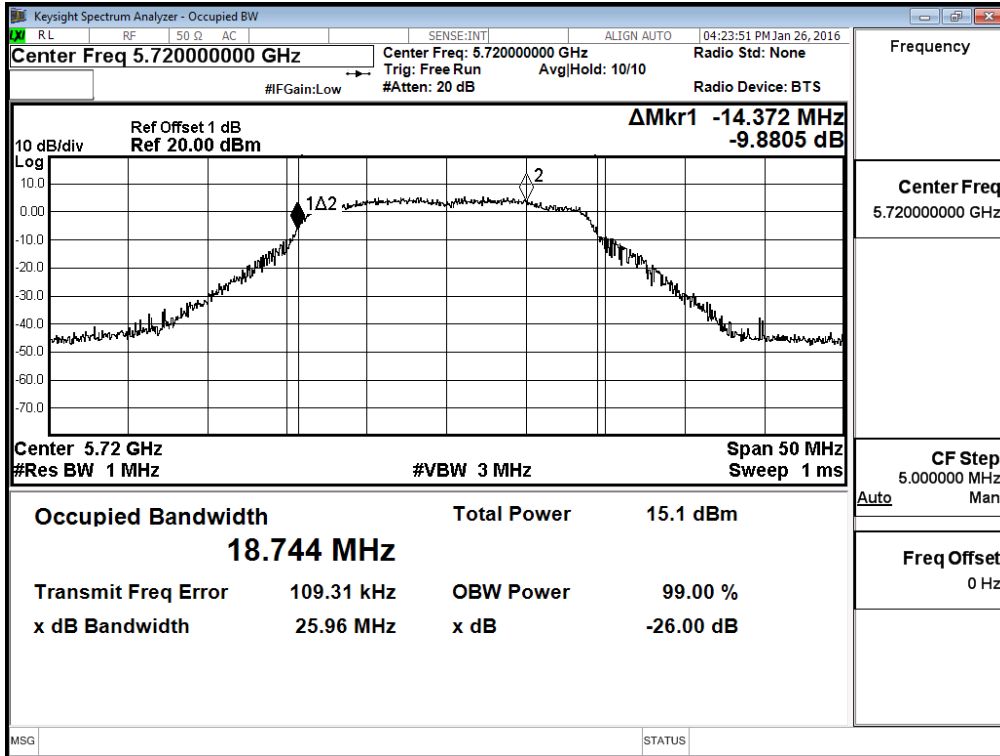

**Maximum conducted output power:
Channel 144 (Band3) – Chain A**

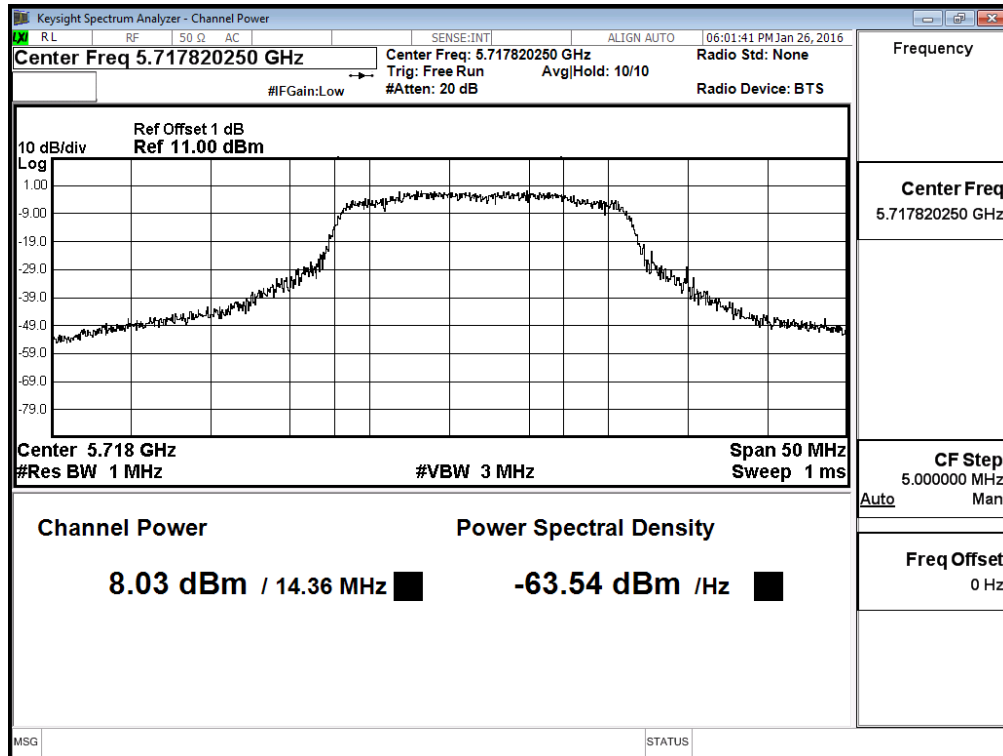

Channel 144 (Band4) – Chain A

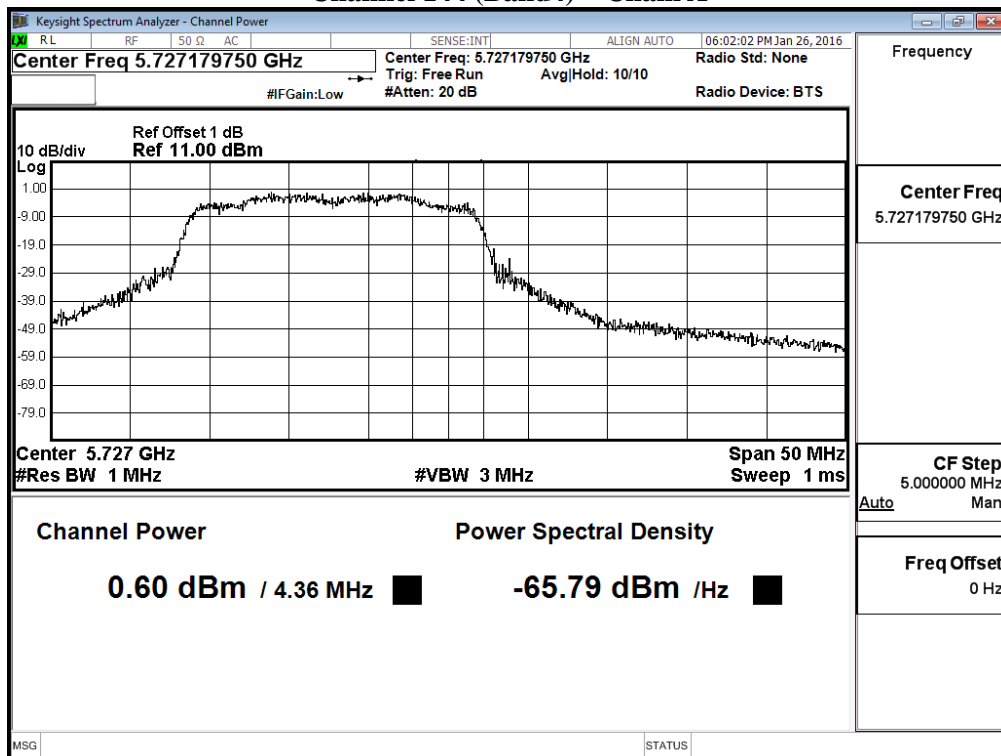

Maximum conducted output power:
Channel 144 (Band3) – Chain B

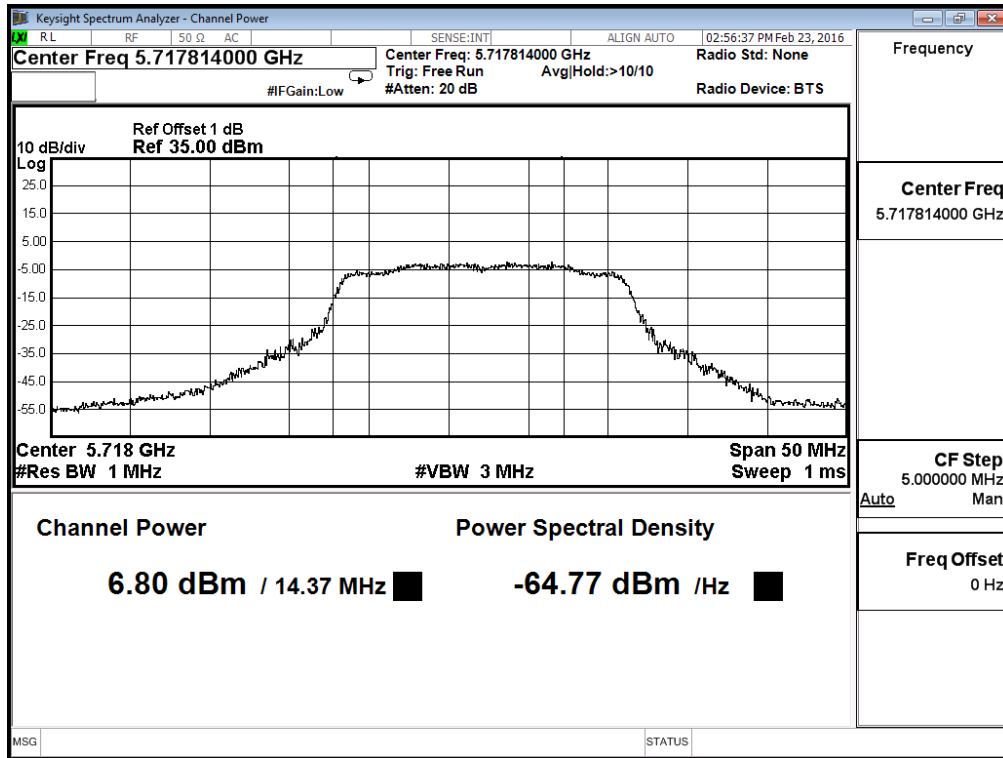

Channel 144 (Band4) – Chain B

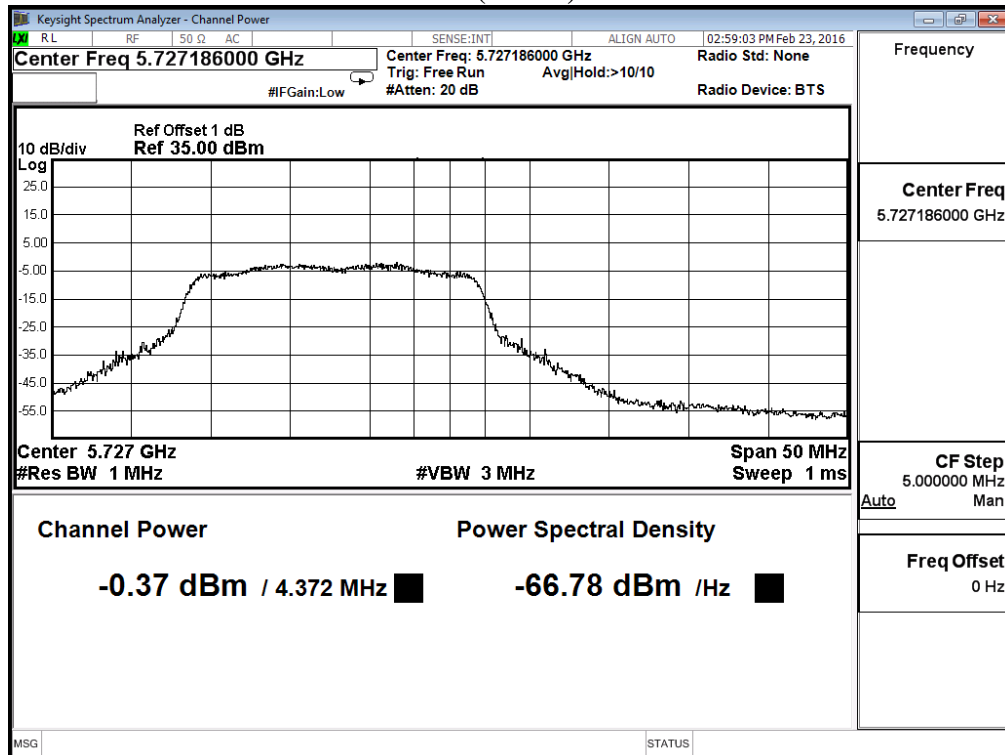

Product : Medical Cart Computer
 Test Item : Maximum conducted output power
 Test Site : No.3 OATS
 Test Mode : Mode 5: Transmit (802.11ac-40BW-30Mbps) (19”+22”+24”)

Chain A

Cable loss=1dB		Maximum conducted output power										
Channel No	Frequency (MHz)	Data Rate (Mbps)										Required Limit
		VTH0	VTH1	VTH2	VTH3	VTH4	VTH5	VTH6	VTH7	VTH8	VTH9	
142F(Band3)	5710	9.65	9.58	9.49	9.41	9.33	9.25	9.17	9.09	9.01	8.93	<24dBm
142F(Band4)	5710	-3.33	-3.42	-3.48	-3.56	-3.64	-3.71	-3.79	-3.86	-3.94	-4.01	<30dBm

Chain B

Cable loss=1dB		Maximum conducted output power										
Channel No	Frequency (MHz)	Data Rate (Mbps)										Required Limit
		VTH0	VTH1	VTH2	VTH3	VTH4	VTH5	VTH6	VTH7	VTH8	VTH9	
142F(Band3)	5710	8.26	8.17	8.08	7.99	7.9	7.81	7.72	7.63	7.54	7.45	<24dBm
142F(Band4)	5710	-4.89	-4.93	-5.02	-5.08	-5.14	-5.21	-5.27	-5.34	-5.40	-5.47	<30dBm

Maximum conducted output power Measurement:

Channel No	Frequency Range (MHz)	99% Bandwidth (MHz)	Chain A Power (dBm)	Chain B Power (dBm)	Output Power (dBm)	Output Power Limit		Result
						(dBm)	dBm+10log(BW)	
142F(Band3)	5710	33.131	9.650	8.260	12.02	24	26.20	Pass
142F(Band4)	5710	--	-3.330	-4.890	-1.03	30	--	Pass

Note:

- Output Power (dBm) = 10LOG (Chain A Power (mW)+ Chain B Power (mW))
- 99% Bandwidth is the bandwidth of chain A or chain B whichever is less bandwidth, output power limitation is more stringent.

**99% Occupied Bandwidth:
Channel 142 – Chain A**

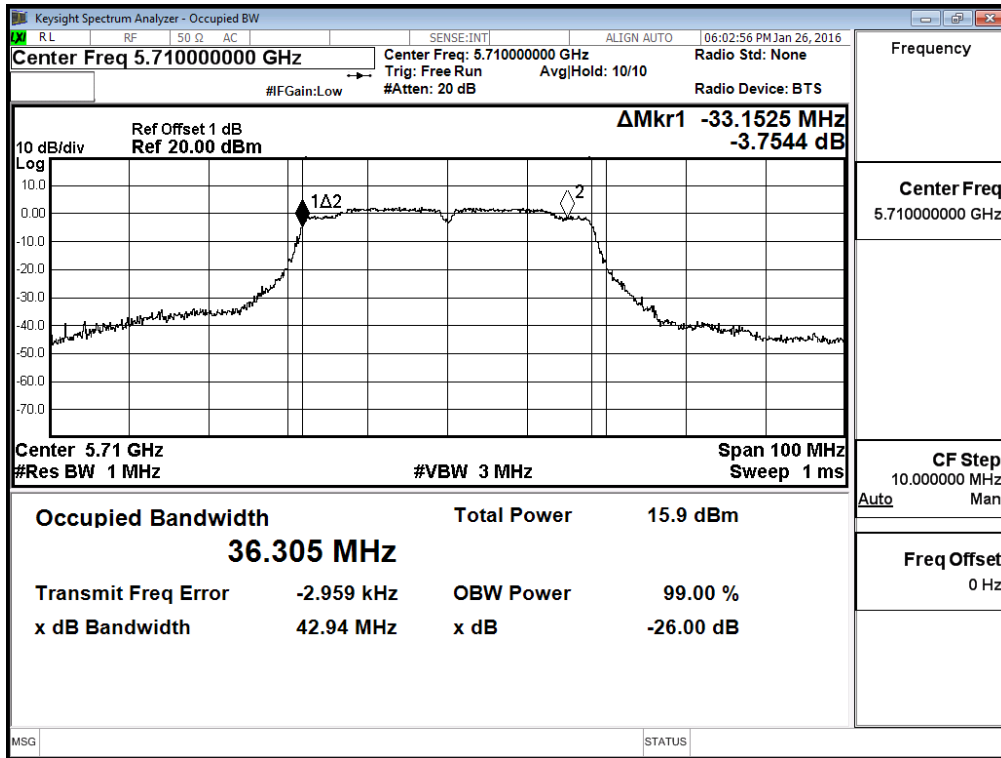

**99% Occupied Bandwidth:
Channel 142 – Chain B**

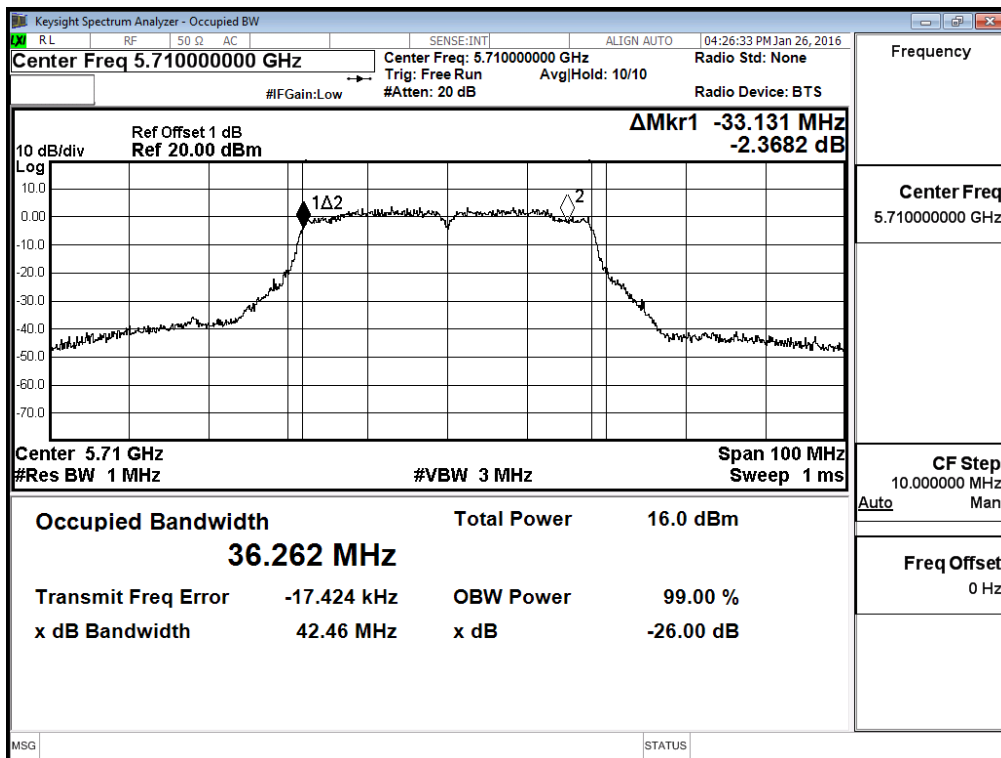

Maximum conducted output power:
Channel 142 (Band3) – Chain A

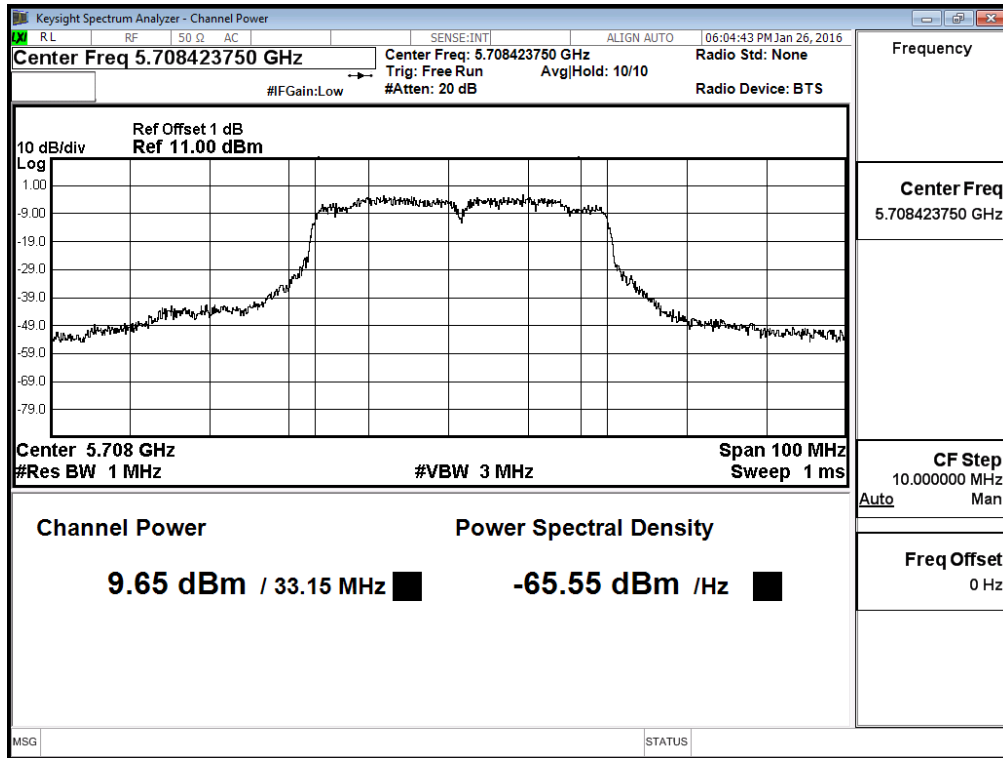

Channel 142 (Band4) – Chain A

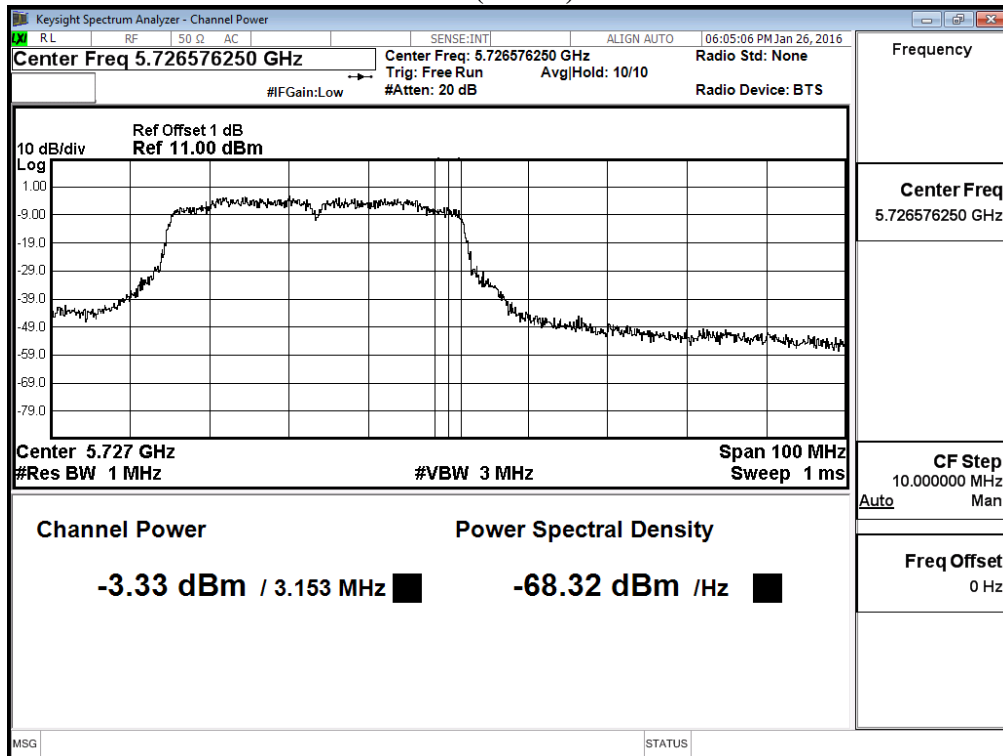

Maximum conducted output power:
Channel 142 (Band3) – Chain B

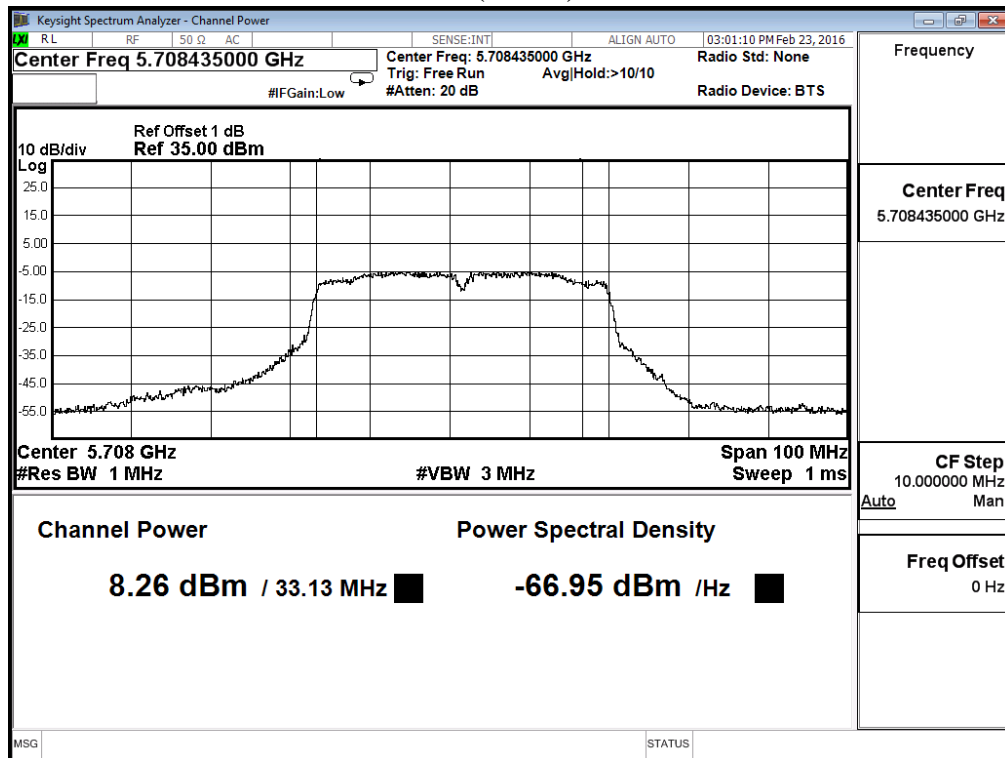

Channel 142 (Band4) – Chain B

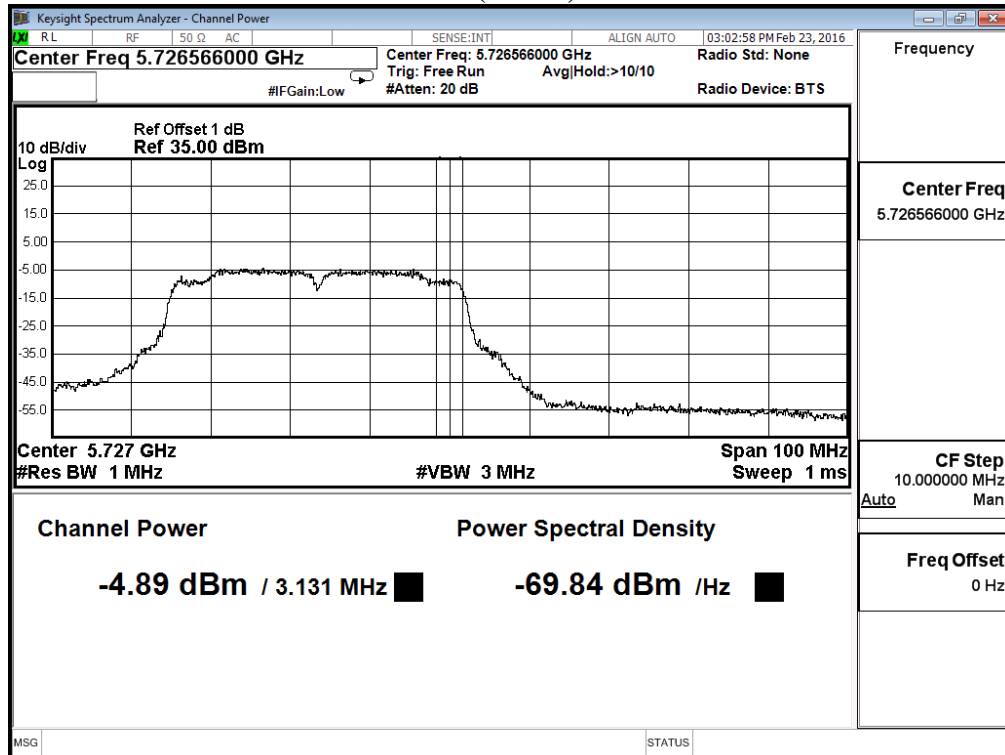

Product : Medical Cart Computer
 Test Item : Maximum conducted output power
 Test Site : No.3 OATS
 Test Mode : Mode 6: Transmit (802.11ac-80BW-65Mbps) (19''+22''+24'')

Chain A

Cable loss=1dB		Maximum conducted output power										
Channel No	Frequency (MHz)	Data Rate (Mbps)										Required Limit
		VTH0	VTH1	VTH2	VTH3	VTH4	VTH5	VTH6	VTH7	VTH8	VTH9	
42	5210	6.78	6.72	6.63	6.56	6.49	6.41	6.34	6.26	6.19	6.11	<24dBm
58	5290	8.11	8.03	7.96	7.88	7.81	7.73	7.66	7.58	7.51	7.43	<24dBm
106ac80	5530	6.50	--	--	--	--	--	--	--	--	--	<24dBm
122ac80	5610	10.03	9.96	9.87	9.79	9.71	9.63	9.55	9.47	9.39	9.31	<24dBm
138ac80(Band3)	5690	10.15	--	--	--	--	--	--	--	--	--	<24dBm
138ac80(Band4)	5690	-6.21	--	--	--	--	--	--	--	--	--	<30dBm
155ac80	5775	9.18	9.09	9.02	8.94	8.86	8.78	8.70	8.62	8.54	8.46	<30dBm

Chain B

Cable loss=1dB		Maximum conducted output power										
Channel No	Frequency (MHz)	Data Rate (Mbps)										Required Limit
		VTH0	VTH1	VTH2	VTH3	VTH4	VTH5	VTH6	VTH7	VTH8	VTH9	
42	5210	5.55	5.46	5.38	5.29	5.21	5.12	5.04	4.95	4.87	4.78	<24dBm
58	5290	7.65	7.57	7.5	7.42	7.35	7.27	7.20	7.12	7.05	6.97	<24dBm
106ac80	5530	5.64	--	--	--	--	--	--	--	--	--	<24dBm
122ac80	5610	8.50	8.41	8.34	8.26	8.18	8.10	8.02	7.94	7.86	7.78	<24dBm
138ac80(Band3)	5690	8.99	--	--	--	--	--	--	--	--	--	<24dBm
138ac80(Band4)	5690	-7.16	--	--	--	--	--	--	--	--	--	<30dBm
155ac80	5775	8.53	8.46	8.39	8.32	8.25	8.18	8.11	8.04	7.97	7.9	<30dBm

Maximum conducted output power Measurement:

Channel No	Frequency Range (MHz)	99% Bandwidth (MHz)	Chain A Power (dBm)	Chain B Power (dBm)	Output Power (dBm)	Output Power Limit		Result
						(dBm)	dBm+10log(BW)	
42	5210	--	6.78	5.55	9.22	24	--	Pass
58	5290	75.348	8.11	7.65	10.90	24	29.77	Pass
106	5530	75.330	6.50	5.64	9.10	24	29.77	Pass
122	5610	75.455	10.030	8.50	12.34	24	29.78	Pass
138	5690	72.705	10.15	8.99	12.62	24	29.62	Pass
138ac80(Band4)	5690	2.705	-6.21	-7.16	-3.65	30	15.32	Pass
155	5775	--	9.18	8.53	11.88	30	--	Pass

Note:

1. Output Power (dBm) = 10LOG (Chain A Power (mW)+ Chain B Power (mW))
2. 99% Bandwidth is the bandwidth of chain A or chain B whichever is less bandwidth, output power limitation is more stringent.

**99% Occupied Bandwidth:
Channel 42 – Chain A**

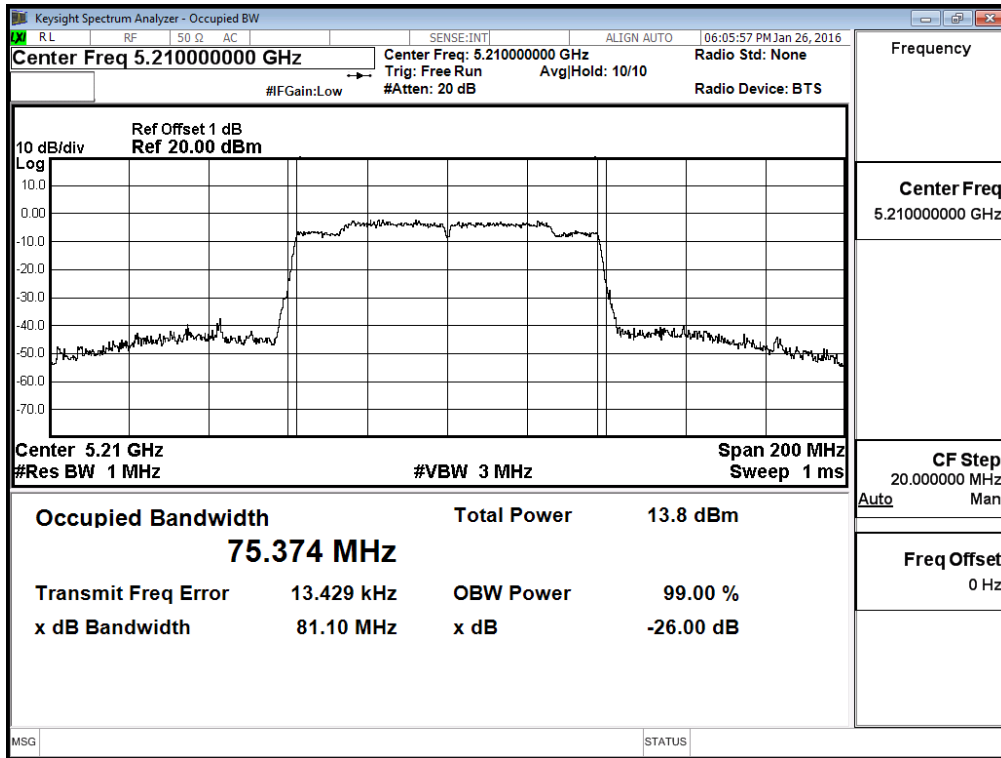

Channel 58 – Chain A

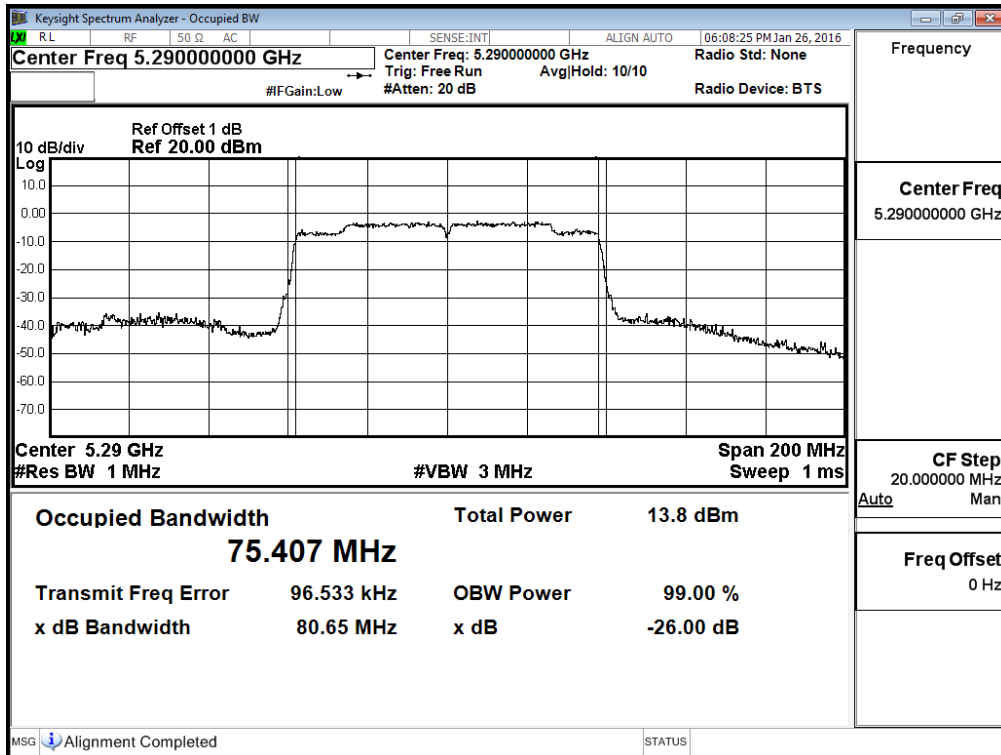

Channel 106 – Chain A

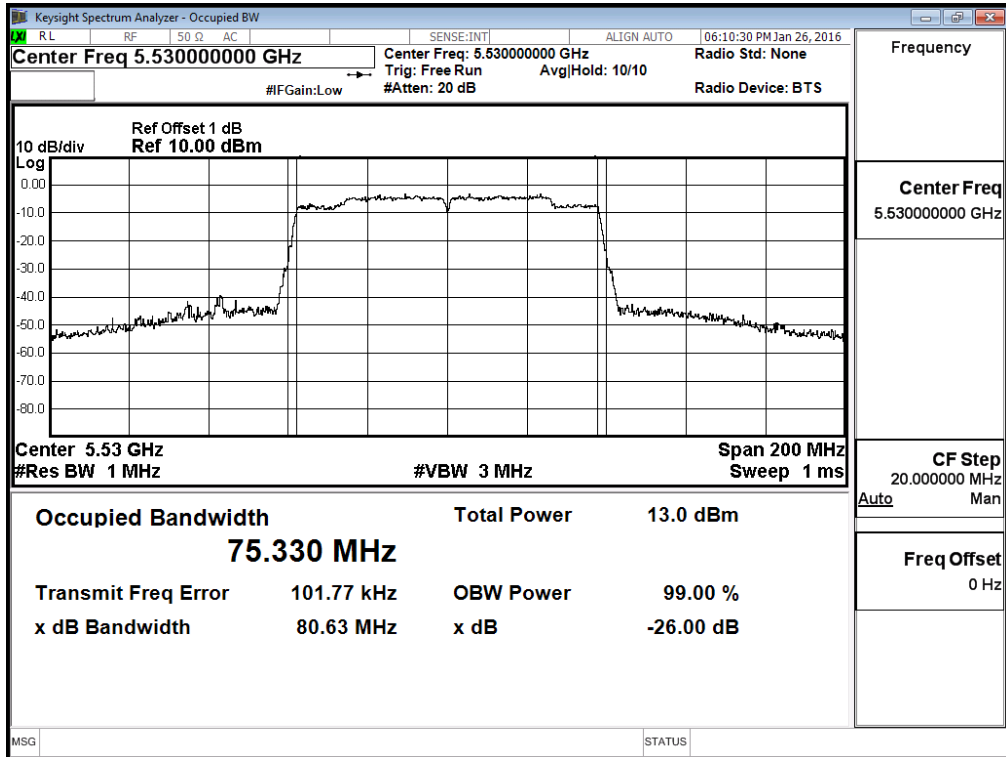

Channel 122 – Chain A

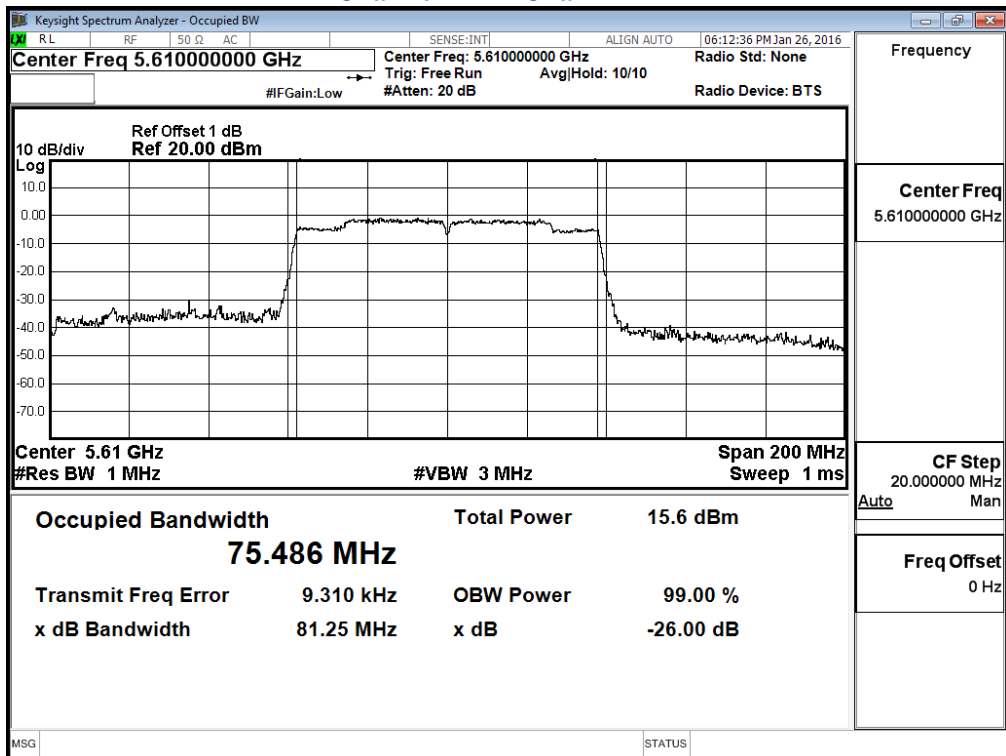

Channel 138 – Chain A

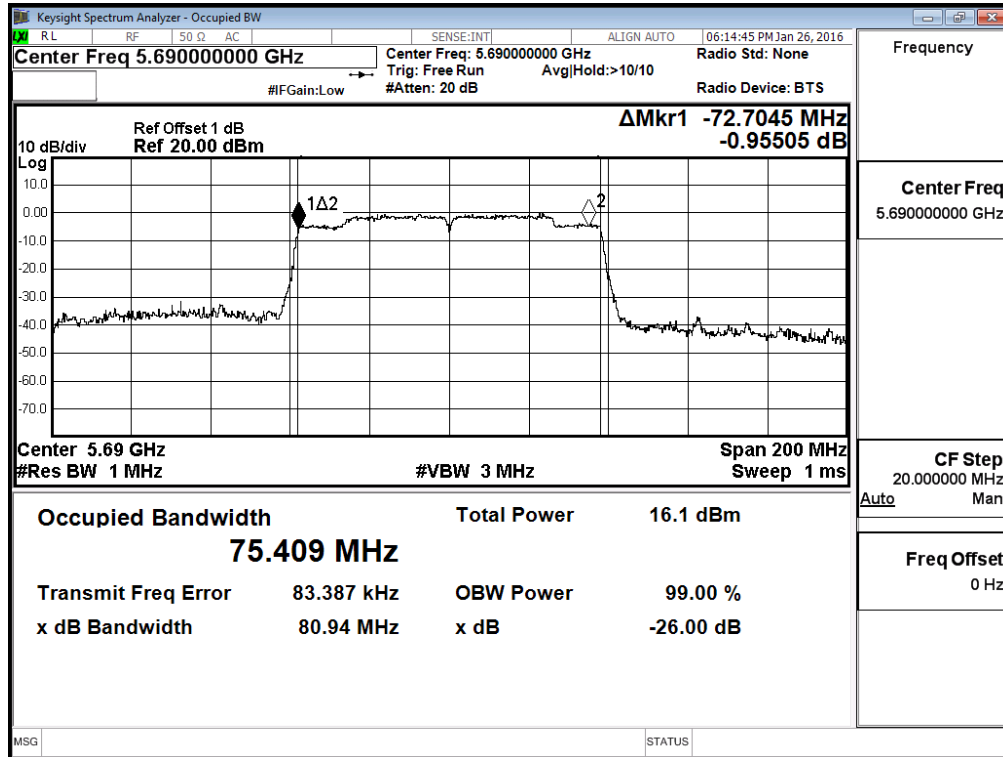

Channel 155 – Chain A

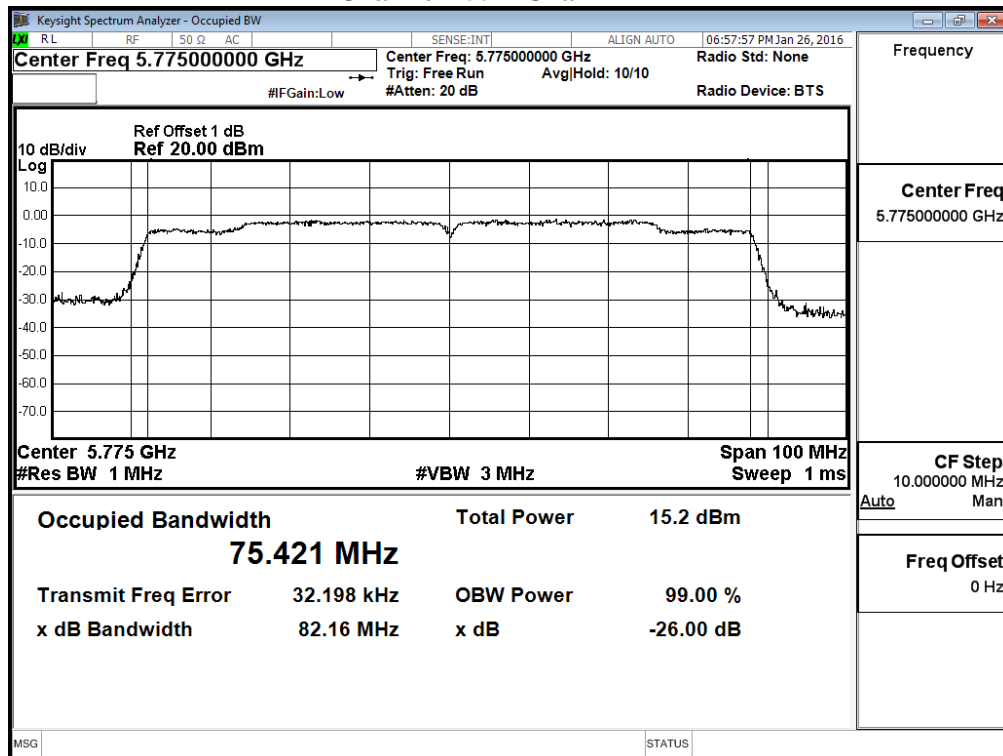

**99% Occupied Bandwidth:
Channel 42 – Chain B**

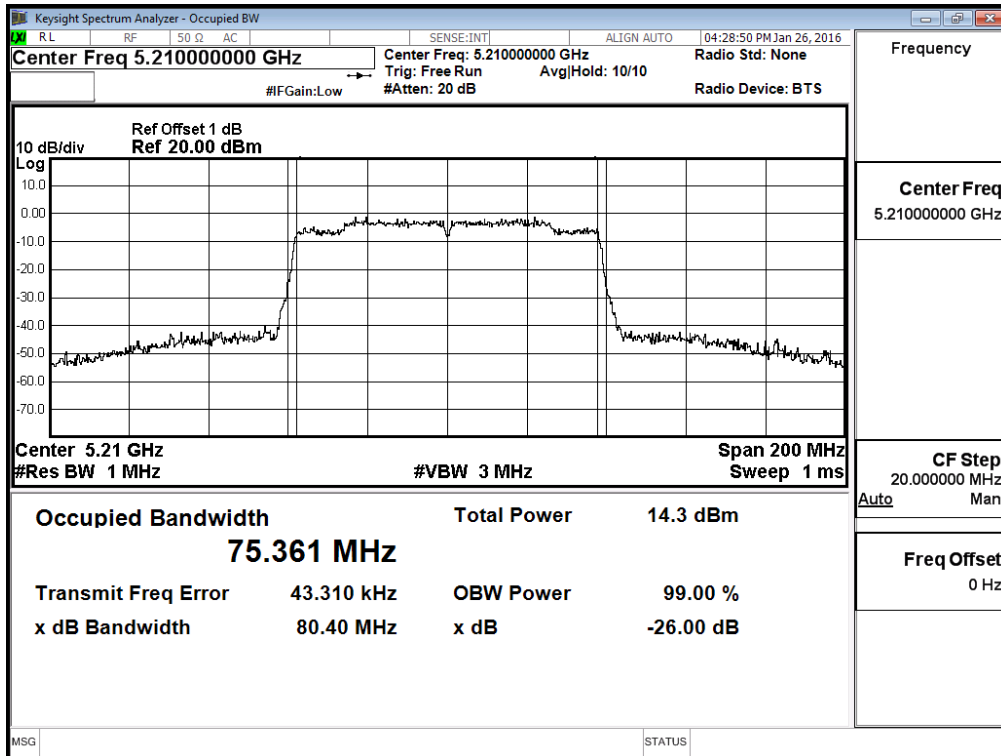

Channel 58 – Chain B

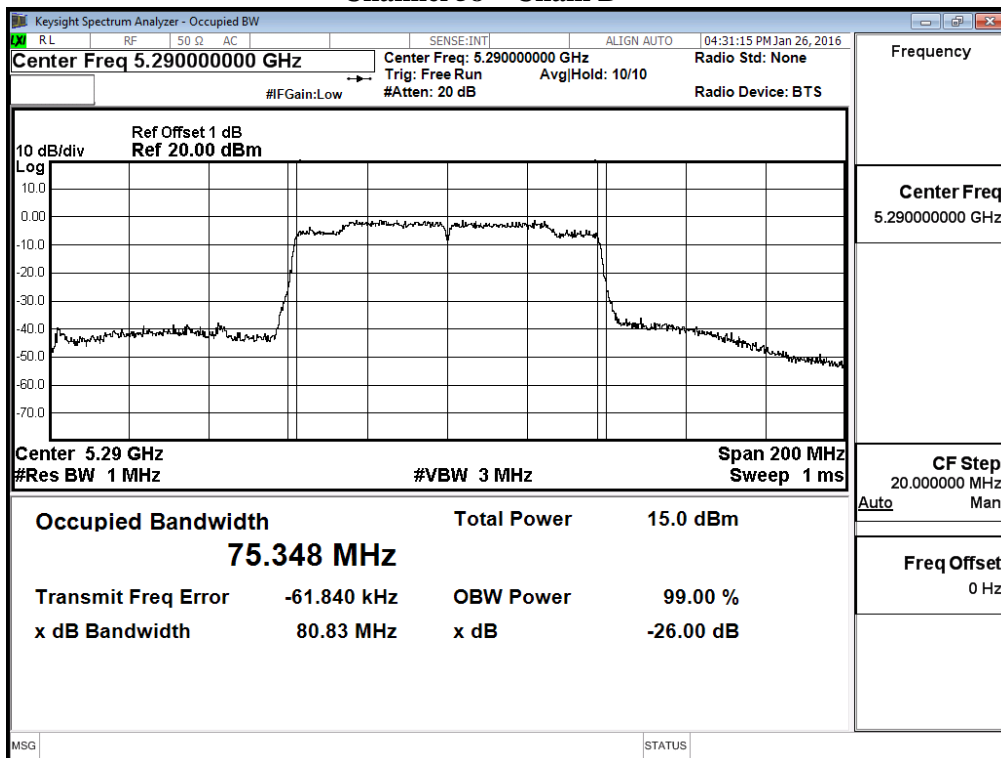

Channel 106 – Chain B

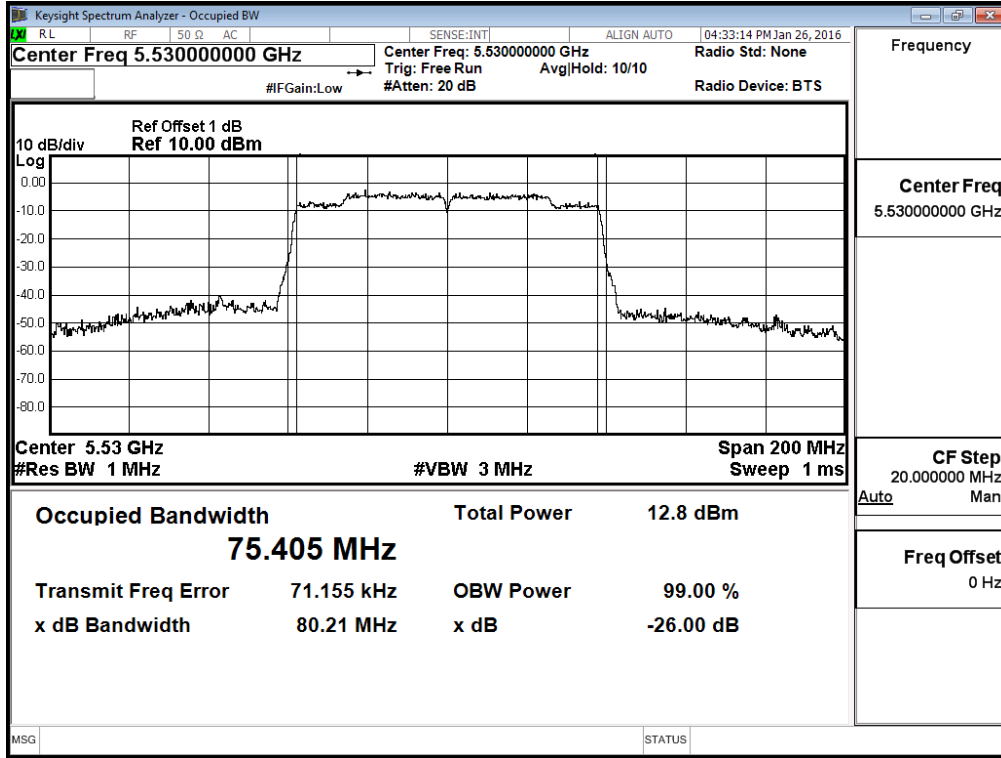

Channel 122 – Chain B

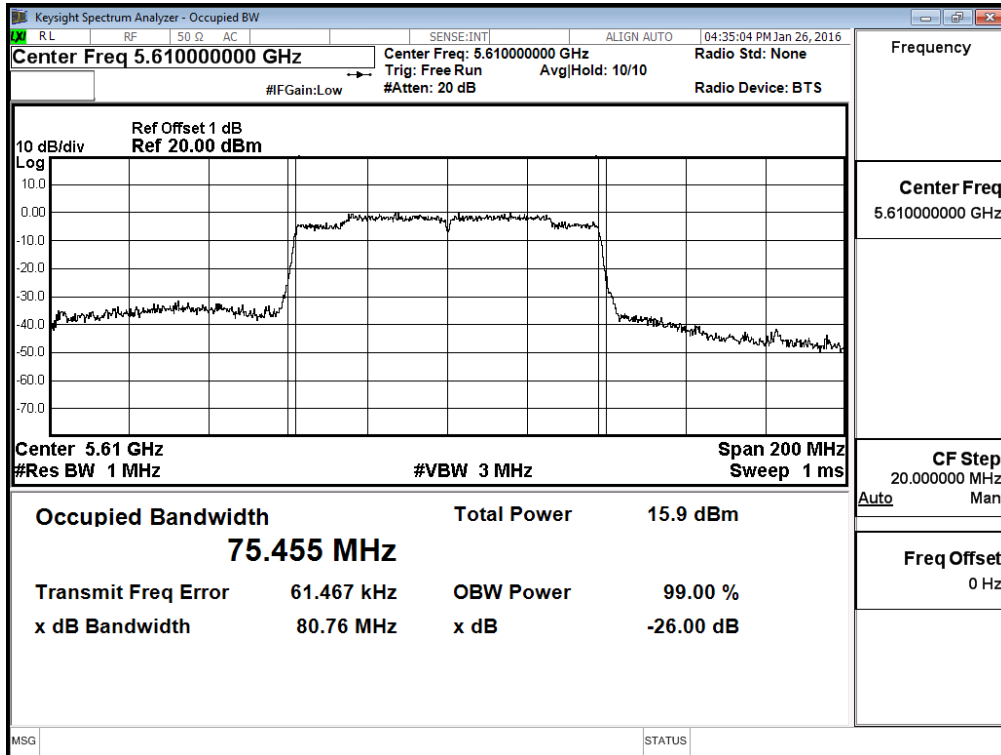

Channel 138 – Chain B

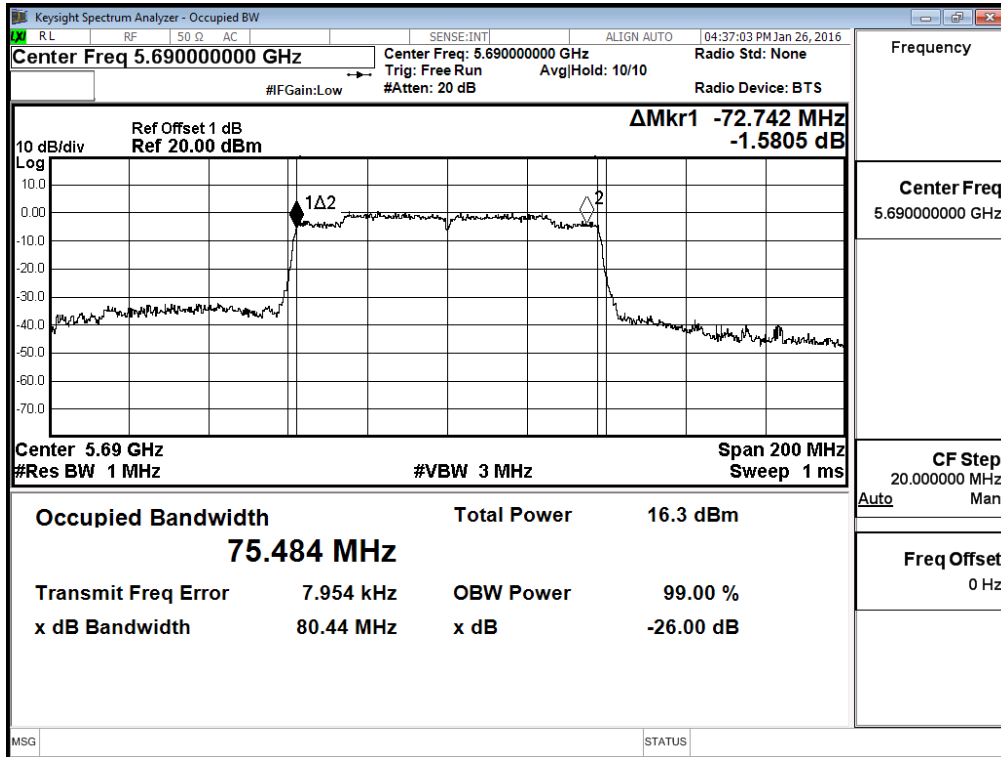

Channel 155 – Chain B

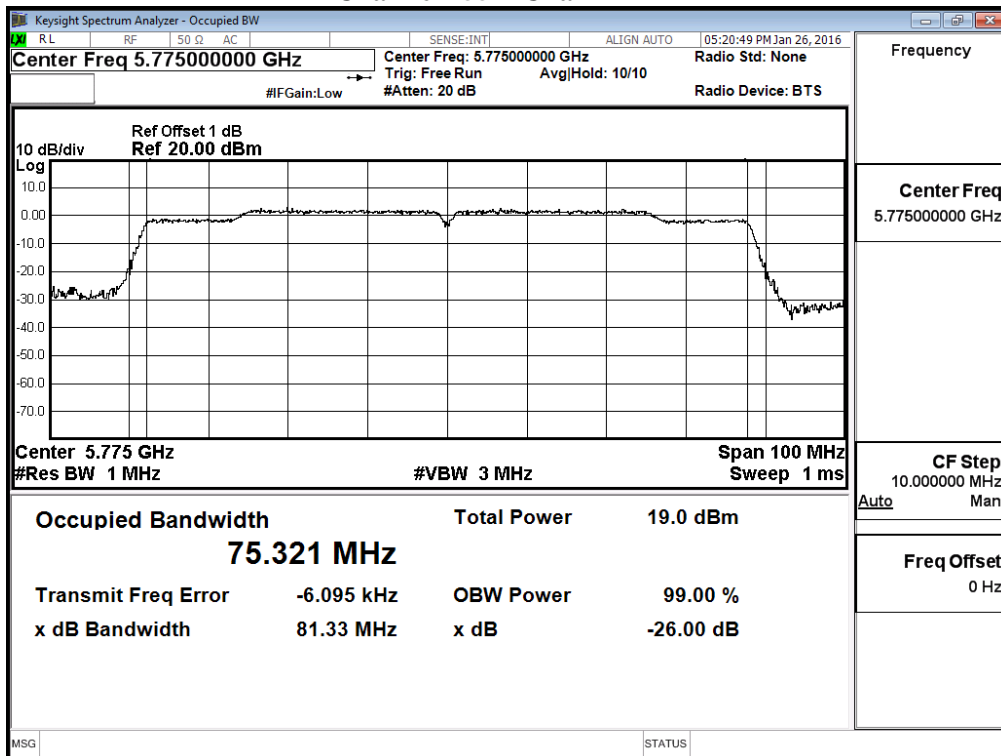

Maximum conducted output power:

Channel 42 – Chain A

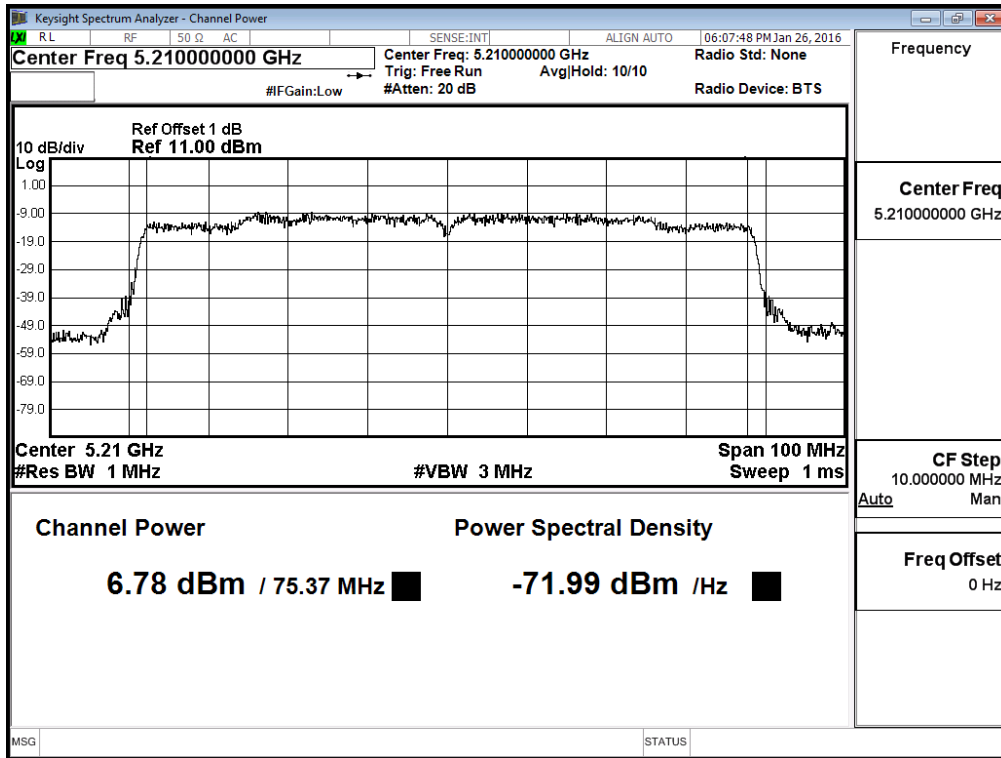

Maximum conducted output power:

Channel 58 – Chain A

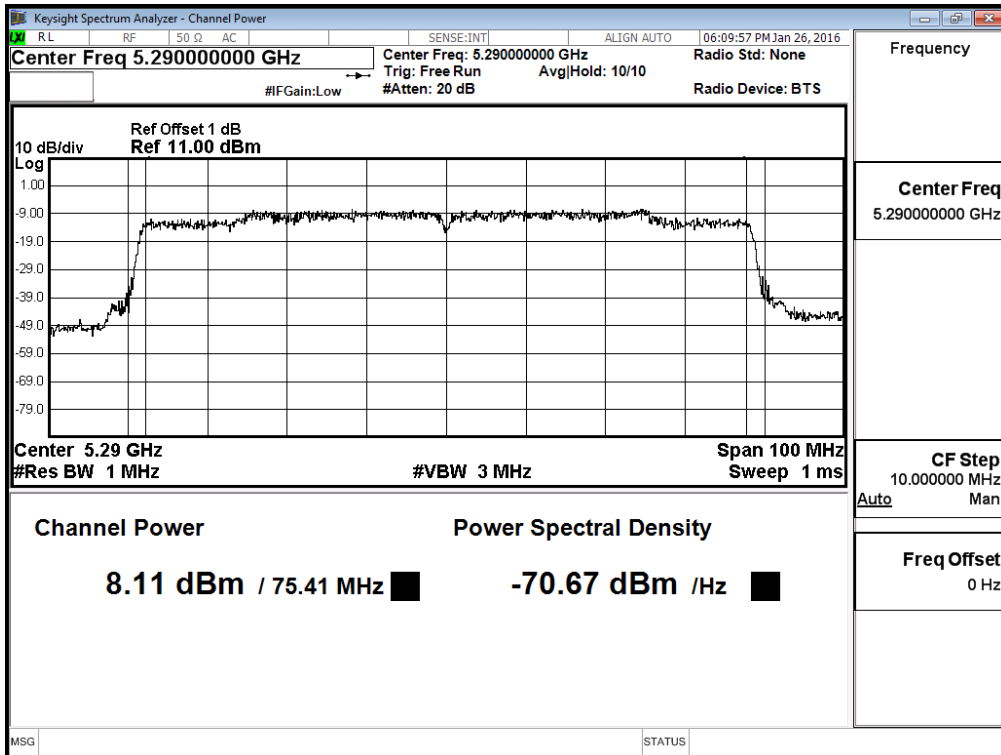

Maximum conducted output power:

Channel 106 – Chain A

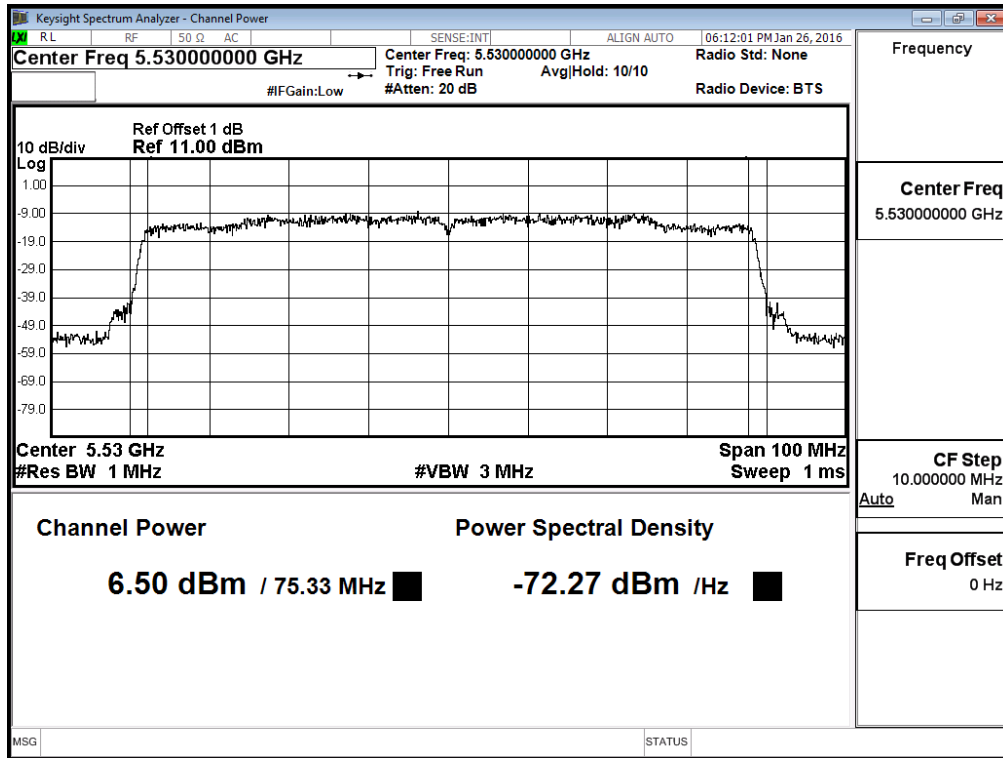

Maximum conducted output power:

Channel 122 – Chain A

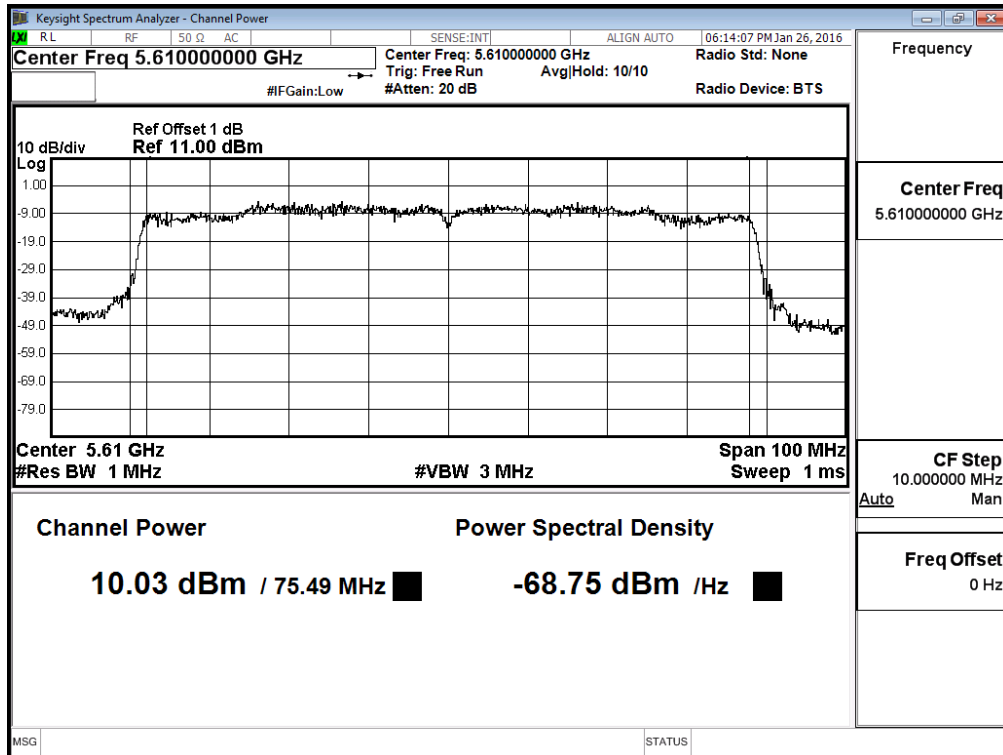

Maximum conducted output power:
Channel 138 (Band3) – Chain A

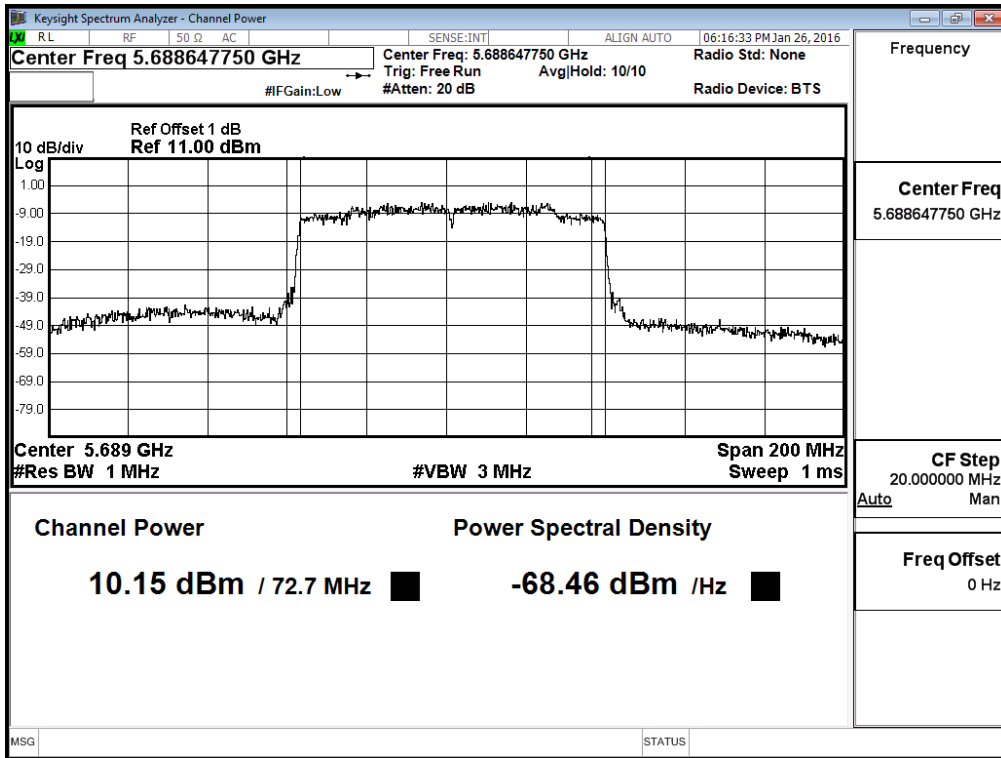

Maximum conducted output power:
Channel 138 (Band4) – Chain A

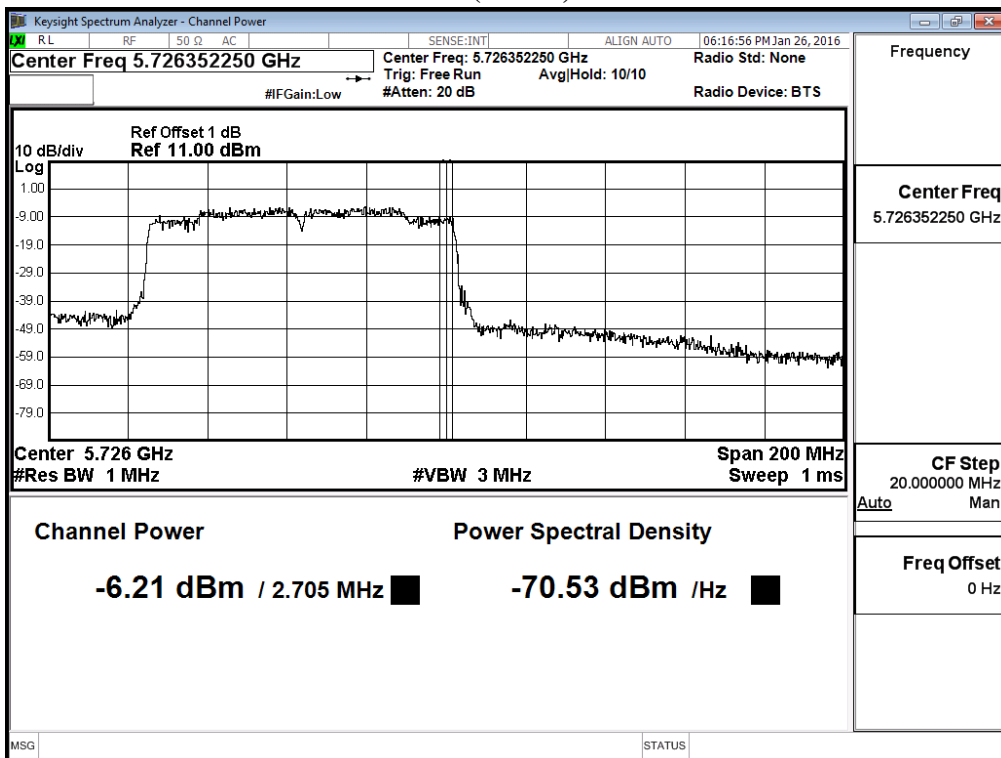

Maximum conducted output power:

Channel 155 – Chain A

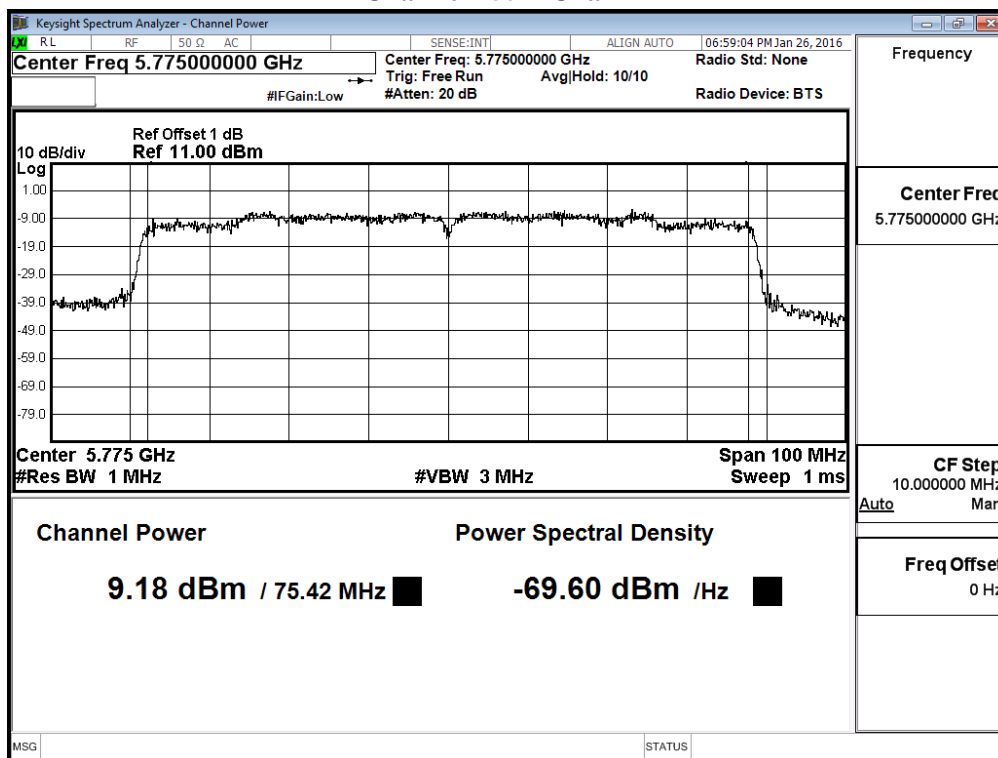

Maximum conducted output power:

Channel 106 – Chain B

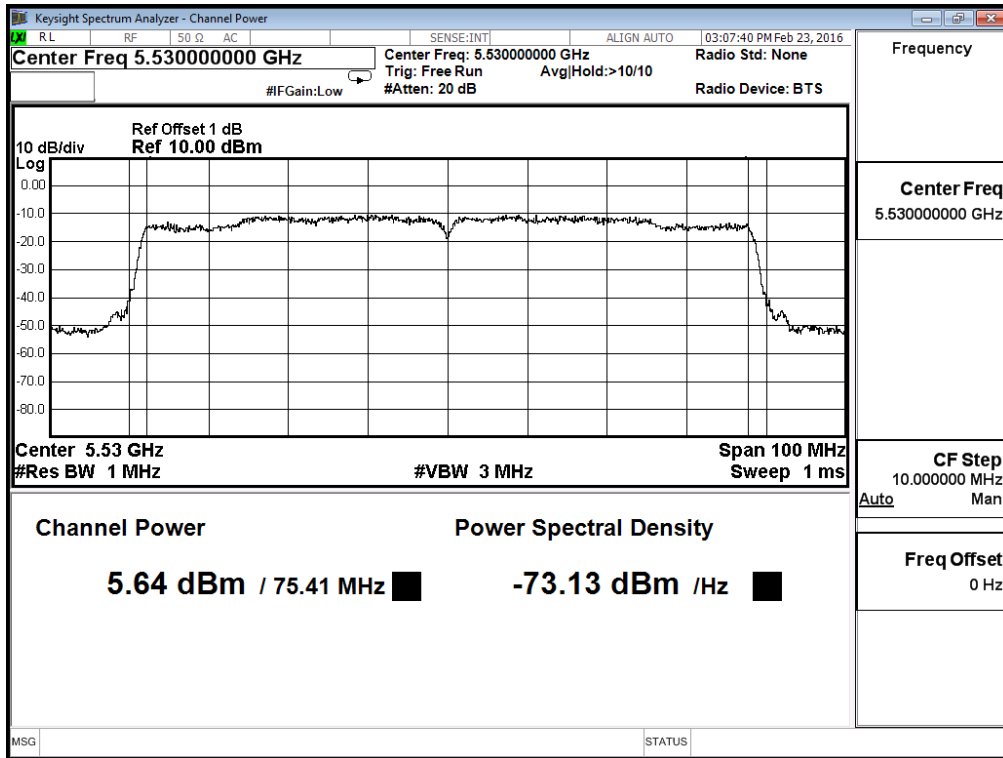

Maximum conducted output power:

Channel 122 – Chain B

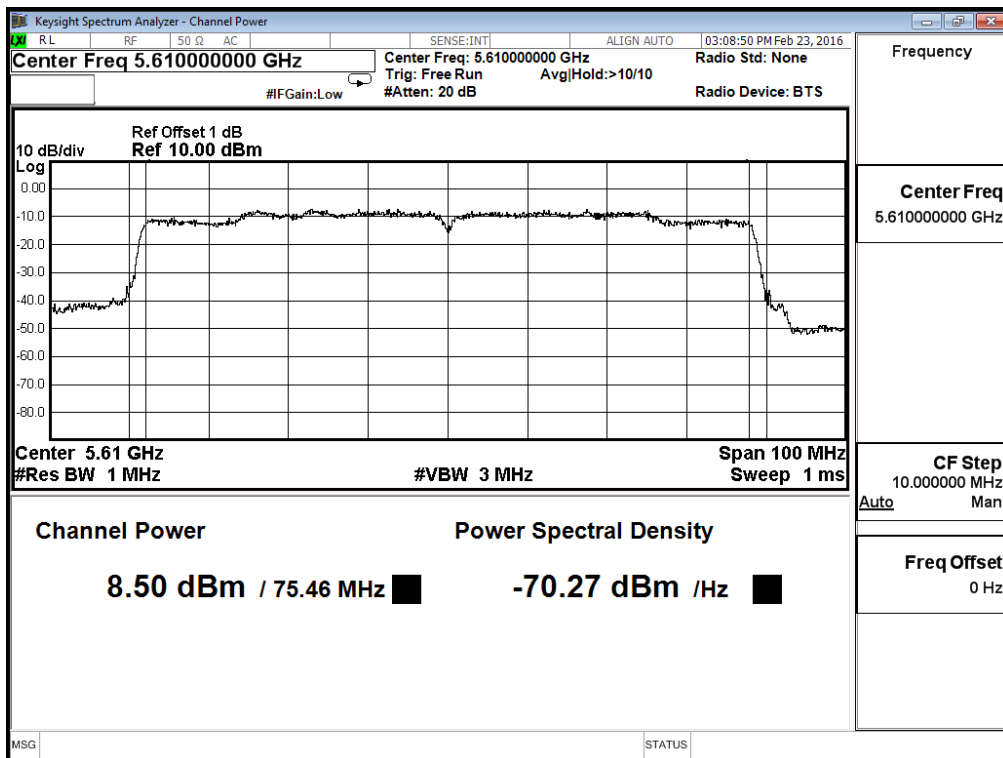

Maximum conducted output power:
Channel 138 (Band3) – Chain B

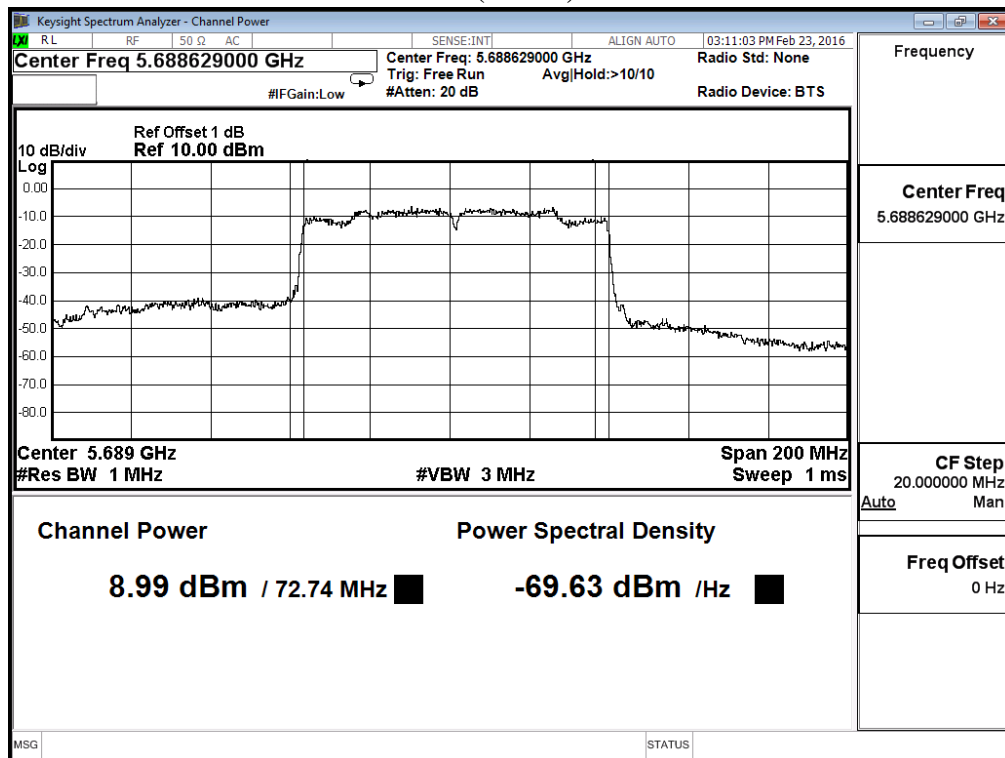

Maximum conducted output power:
Channel 138 (Band4) – Chain B

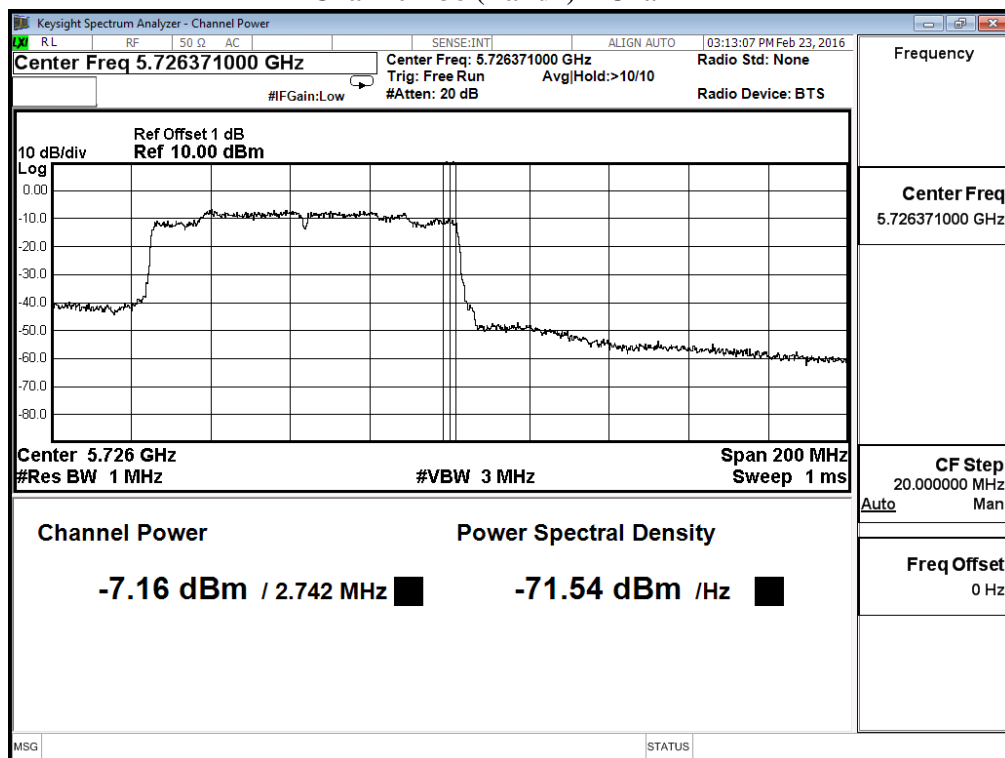

**Maximum conducted output power:
Channel 155 – Chain B**

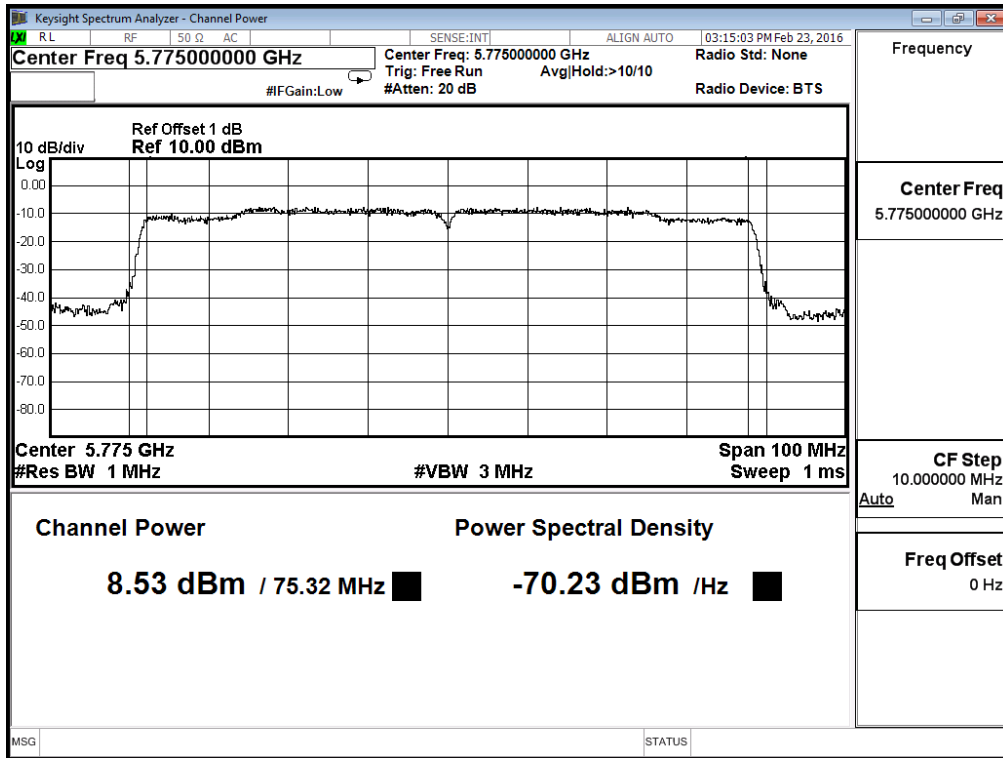

4. Peak Power Spectral Density

4.1. Test Equipment

	Equipment	Manufacturer	Model No./Serial No.	Last Cal.
	Spectrum Analyzer	R&S	FSP40 / 100170	Jun., 2015
	Spectrum Analyzer	Agilent	E4407B / US39440758	Jun., 2015
X	Spectrum Analyzer	Agilent	N9010A / MY48030495	Apr, 2015

Note:

1. All equipments are calibrated with traceable calibrations. Each calibration is traceable to the national or international standards.
2. The test instruments marked with “X” are used to measure the final test results.

4.2. Test Setup

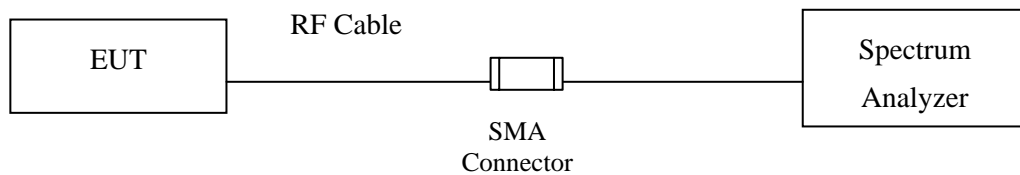

4.3. Limits

- (1) For the band 5.15-5.25 GHz,
 - (i) For an outdoor access point operating in the band 5.15-5.25 GHz, the maximum power spectral density shall not exceed 17 dBm in any 1 megahertz band. If transmitting antennas of directional gain greater than 6 dBi are used, the maximum power spectral density shall be reduced by the amount in dB that the directional gain of the antenna exceeds 6 dBi.
 - (ii) For an indoor access point operating in the band 5.15-5.25 GHz, the maximum power spectral density shall not exceed 17 dBm in any 1 megahertz band. If transmitting antennas of directional gain greater than 6 dBi are used, the maximum power spectral density shall be reduced by the amount in dB that the directional gain of the antenna exceeds 6 dBi.
 - (iii) For fixed point-to-point access points operating in the band 5.15-5.25 GHz, the maximum conducted output power over the frequency band of operation shall not exceed 1 W. Fixed point-to-point U-NII devices may employ antennas with directional gain up to 23 dBi without any corresponding reduction in the maximum conducted output power or maximum power spectral density. For fixed point-to-point transmitters that employ a directional antenna gain greater than 23 dBi, a 1 dB reduction in maximum conducted output power and maximum power spectral density is required for each 1 dB of antenna gain in excess of 23 dBi. Fixed, point-to-point operations exclude the use of point-to-multipoint systems, omnidirectional applications, and multiple collocated transmitters transmitting the same information. The operator of the U-NII device, or if the

equipment is professionally installed, the installer, is responsible for ensuring that systems employing high gain directional antennas are used exclusively for fixed, point-to-point operations. (iv) For mobile and portable client devices in the 5.15-5.25 GHz band, the maximum power spectral density shall not exceed 11 dBm in any 1 megahertz band. If transmitting antennas of directional gain greater than 6 dBi are used, the maximum power spectral density shall be reduced by the amount in dB that the directional gain of the antenna exceeds 6 dBi.+

- (2) For the 5.25-5.35 GHz and 5.47-5.725 GHz bands, the maximum power spectral density shall not exceed 11 dBm in any 1 megahertz band. If transmitting antennas of directional gain greater than 6 dBi are used, the maximum power spectral density shall be reduced by the amount in dB that the directional gain of the antenna exceeds 6 dBi.
- (3) For the band 5.725-5.85 GHz, the maximum power spectral density shall not exceed 30 dBm in any 500-kHz band. If transmitting antennas of directional gain greater than 6 dBi are used, the maximum power spectral density shall be reduced by the amount in dB that the directional gain of the antenna exceeds 6 dBi. However, fixed point-to-point UNII devices operating in this band may employ transmitting antennas with directional gain greater than 6 dBi without any corresponding reduction in transmitter conducted power. Fixed, point-to-point operations exclude the use of point-to-multipoint systems, omnidirectional applications, and multiple collocated transmitters transmitting the same information. The operator of the U-NII device, or if the equipment is professionally installed, the installer, is responsible for ensuring that systems employing high gain directional antennas are used exclusively for fixed, point-to-point operations.

4.4. Test Procedure

The EUT was setup to ANSI C63.10, 2013; tested to UNII test procedure of FCC KDB-789033 for compliance to FCC 47CFR Subpart E requirements.

The Peak Power Spectral Density using KDB 789033 section F) procedure, Create an average power spectrum for the EUT operating mode being tested by following the instructions in section E)2) for measuring maximum conducted output power using a spectrum analyzer.

SA-1 method is selected to run the test.

For the band 5.725-5.85 GHz, Scale the observed power level to an equivalent value in 500 kHz by adjusting (increase) the measured power by a bandwidth correction factor (BWCF) where $BWCF = 10\log(500\text{ kHz}/100\text{ kHz}) = 6.98\text{ dB}$.

4.5. Uncertainty

± 1.27 dB

4.6. Test Result of Peak Power Spectral Density

Product : Medical Cart Computer
 Test Item : Peak Power Spectral Density
 Test Site : No.3 OATS
 Test Mode : Mode 1: Transmit (802.11a-6Mbps) (19''+22''+24'')

Channel Number	Frequency (MHz)	Data Rate (Mbps)	Measurement Level (dBm)	Required Limit (dBm)	Result
36	5180	6	1.170	11	Pass
44	5220	6	3.280	11	Pass
48	5240	6	3.260	11	Pass
52	5260	6	3.800	11	Pass
60	5300	6	3.160	11	Pass
64	5320	6	0.350	11	Pass
100	5500	6	-0.150	11	Pass
116	5580	6	1.740	11	Pass
140	5700	6	-0.450	11	Pass

Channel Number	Frequency (MHz)	Data Rate (Mbps)	PPSD (dBm)	BWCF (dB)	Total PPSD (dBm)	Required Limit (dBm)	Result
149	5745	HT8	-6.800	6.980	0.180	<30	Pass
157	5785	HT8	-6.190	6.980	0.790	<30	Pass
165	5825	HT8	-6.230	6.980	0.750	<30	Pass

Channel 36:

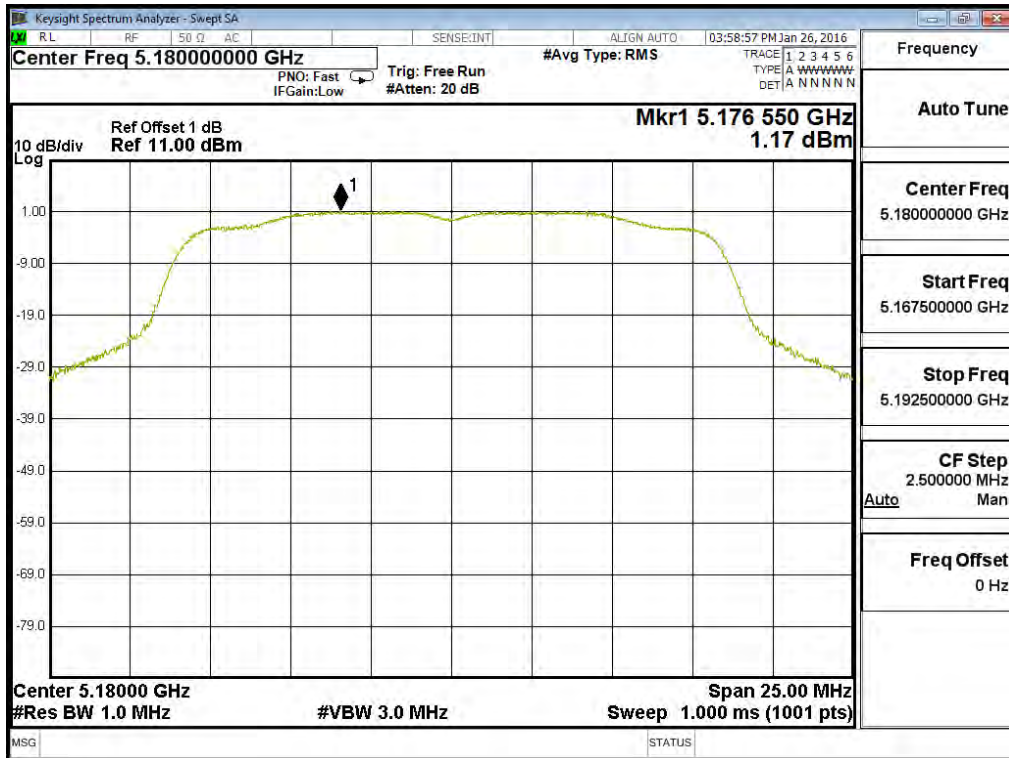

Channel 44:

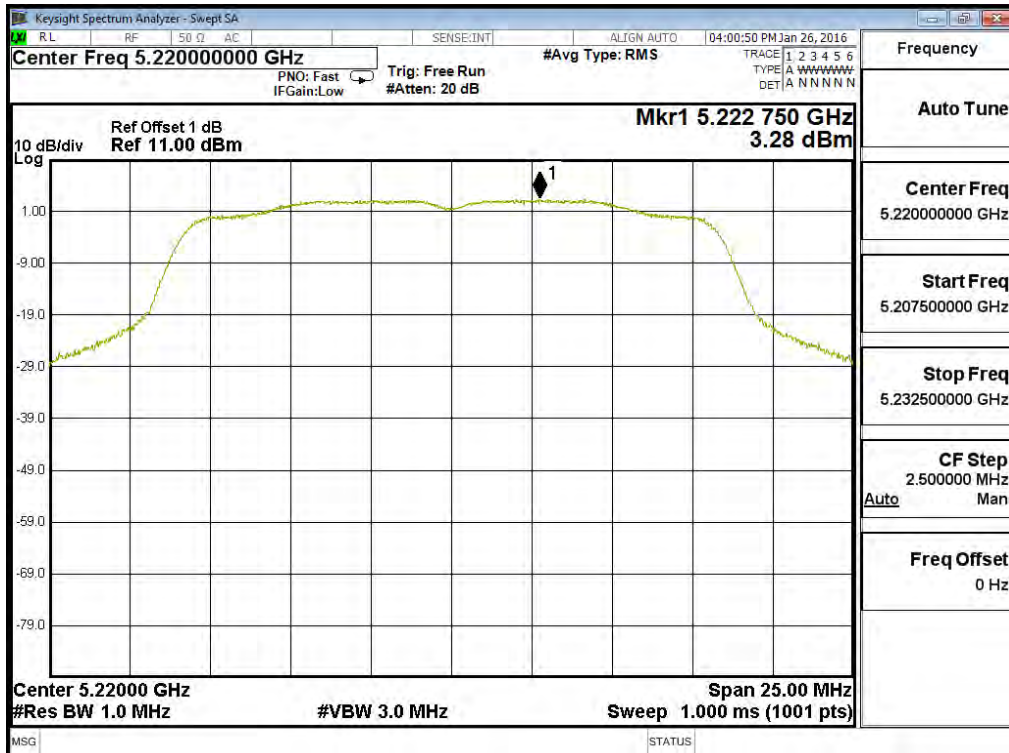

Channel 48:

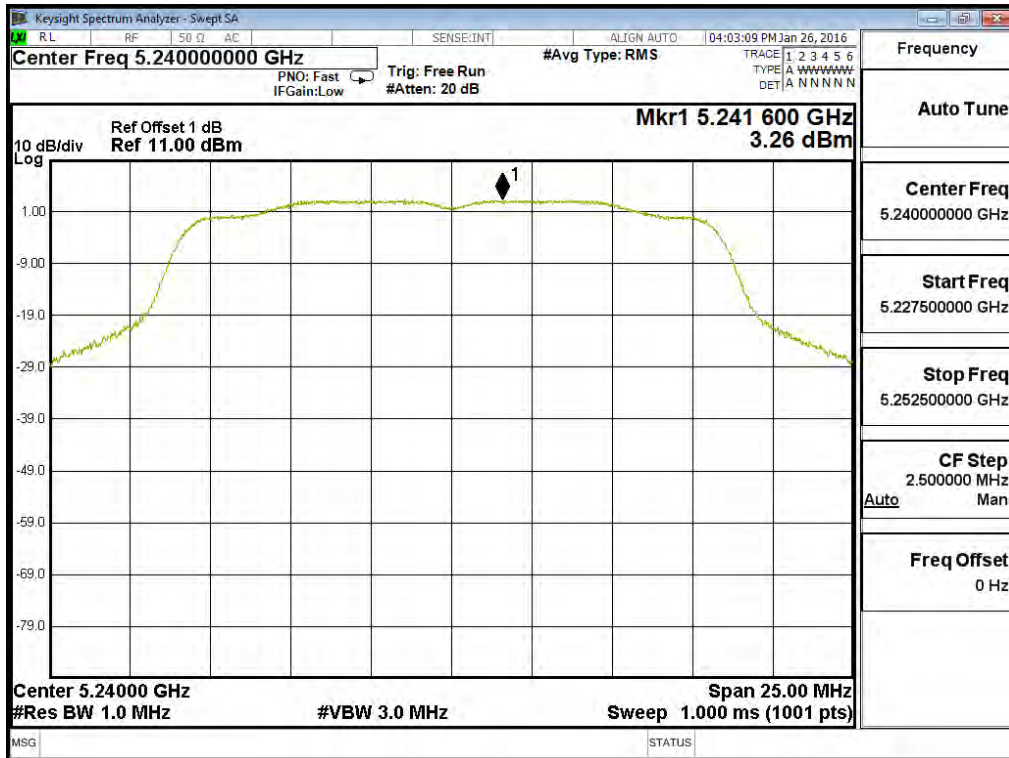

Channel 52:

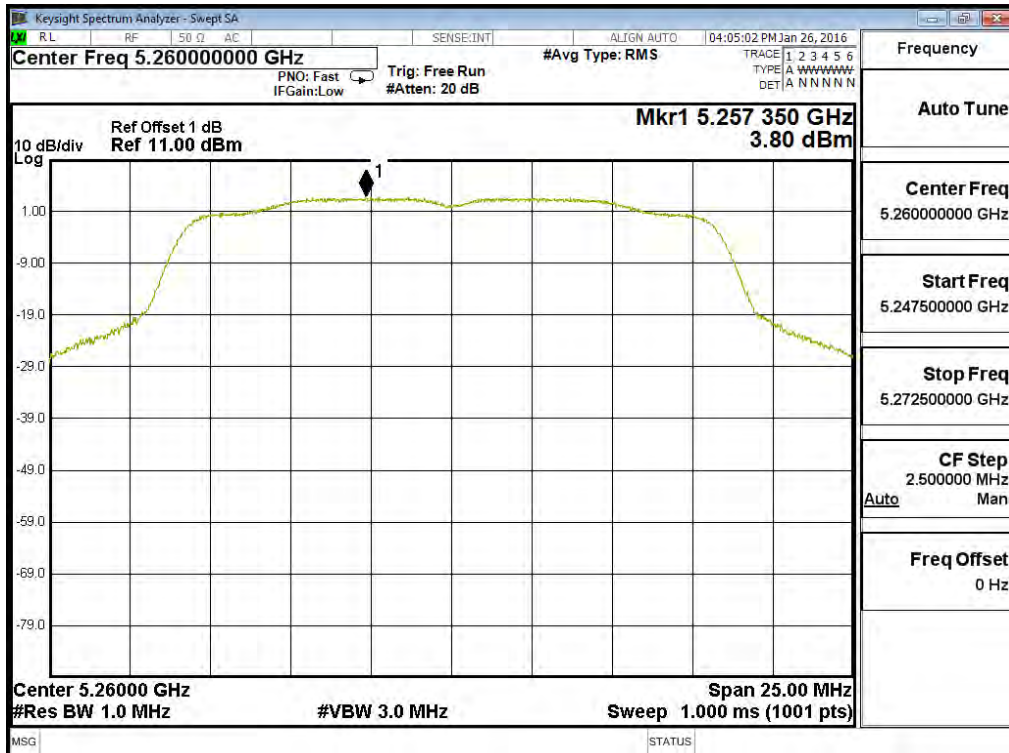

Channel 60:

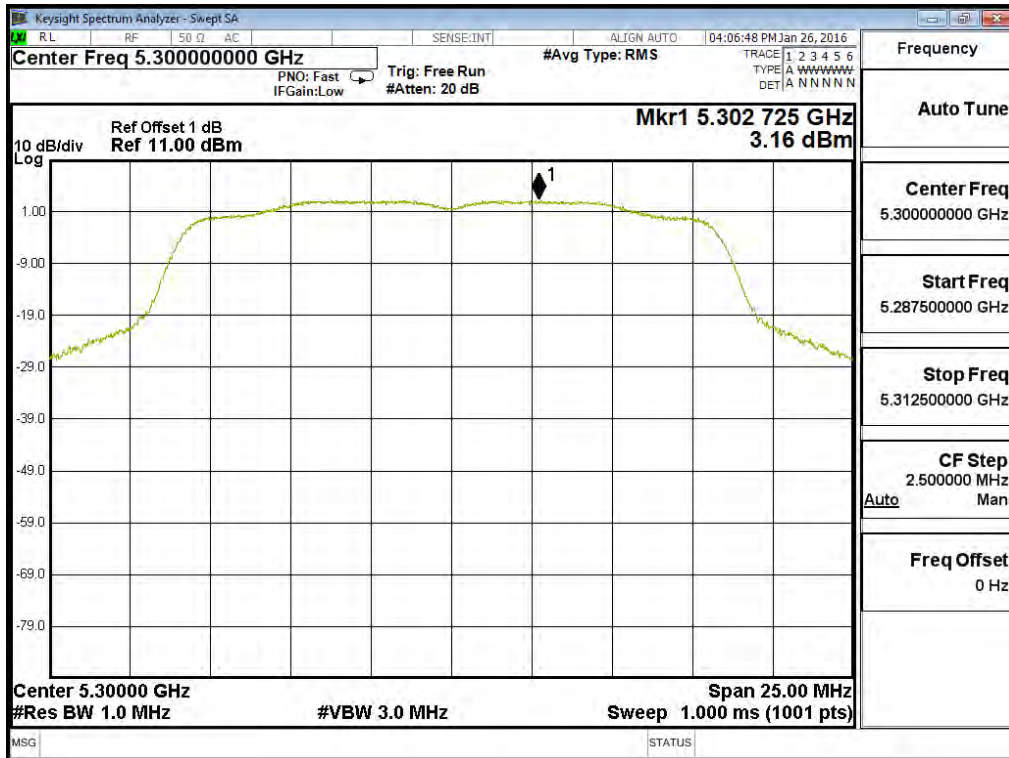

Channel 64:

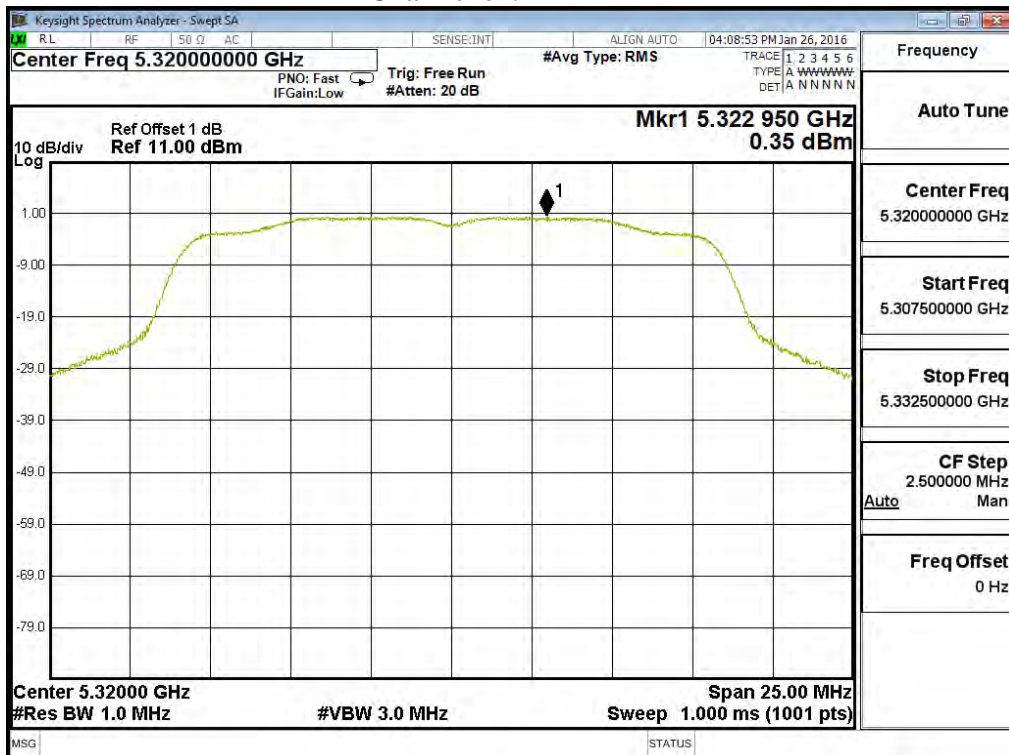

Channel 100:

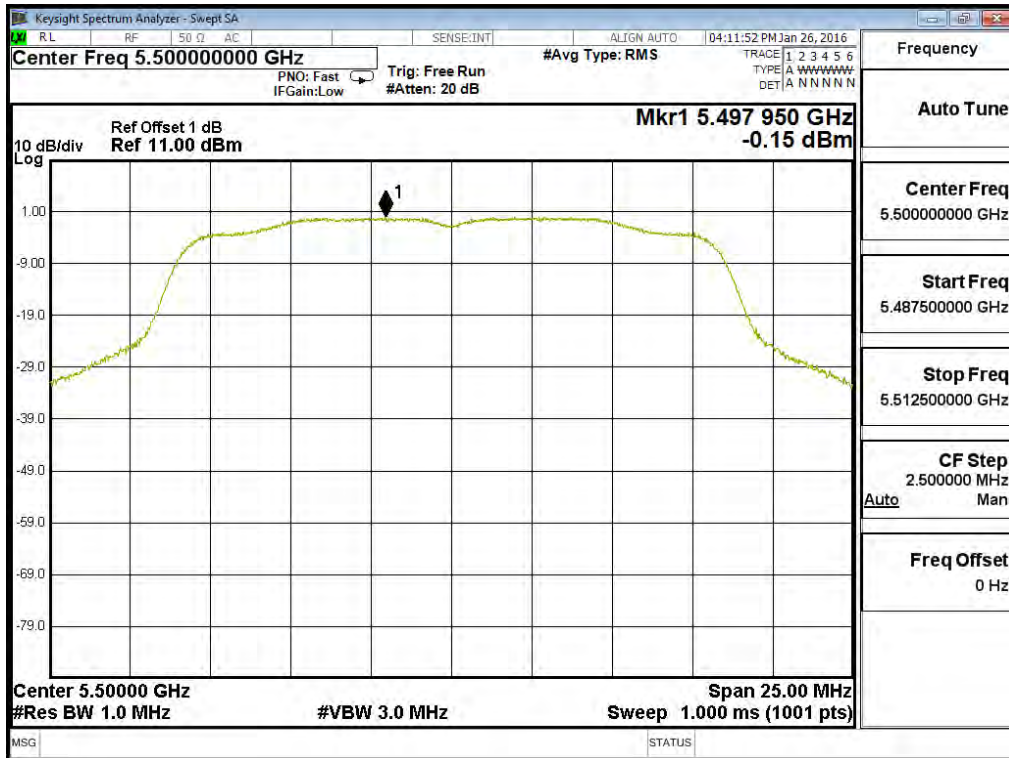

Channel 116:

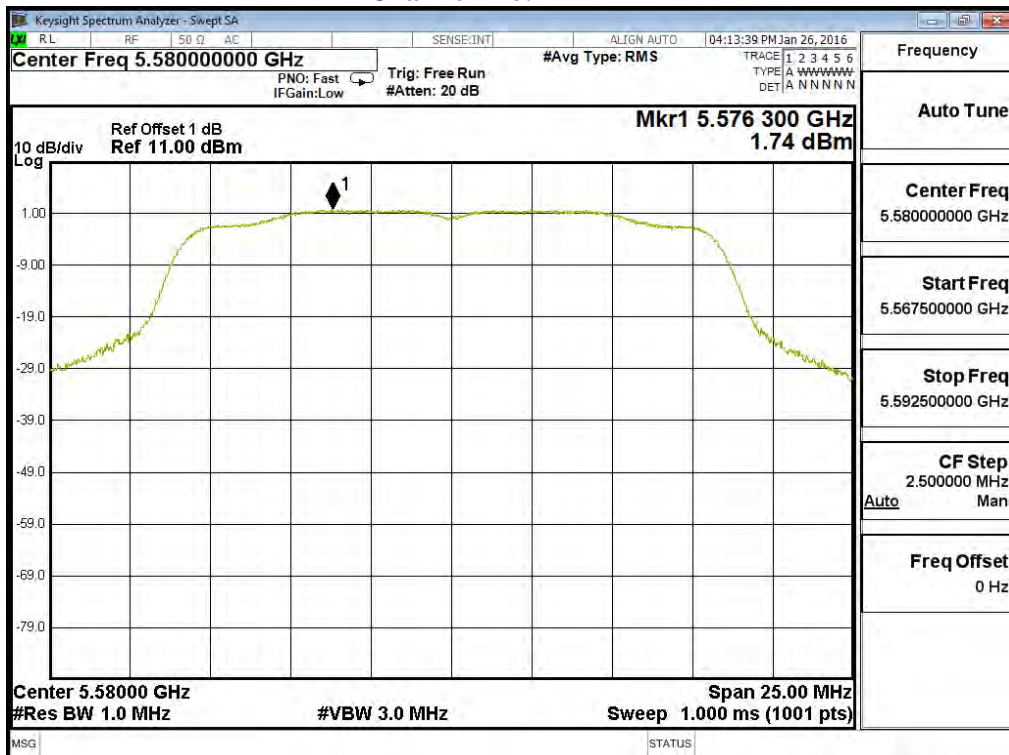

Channel 140:

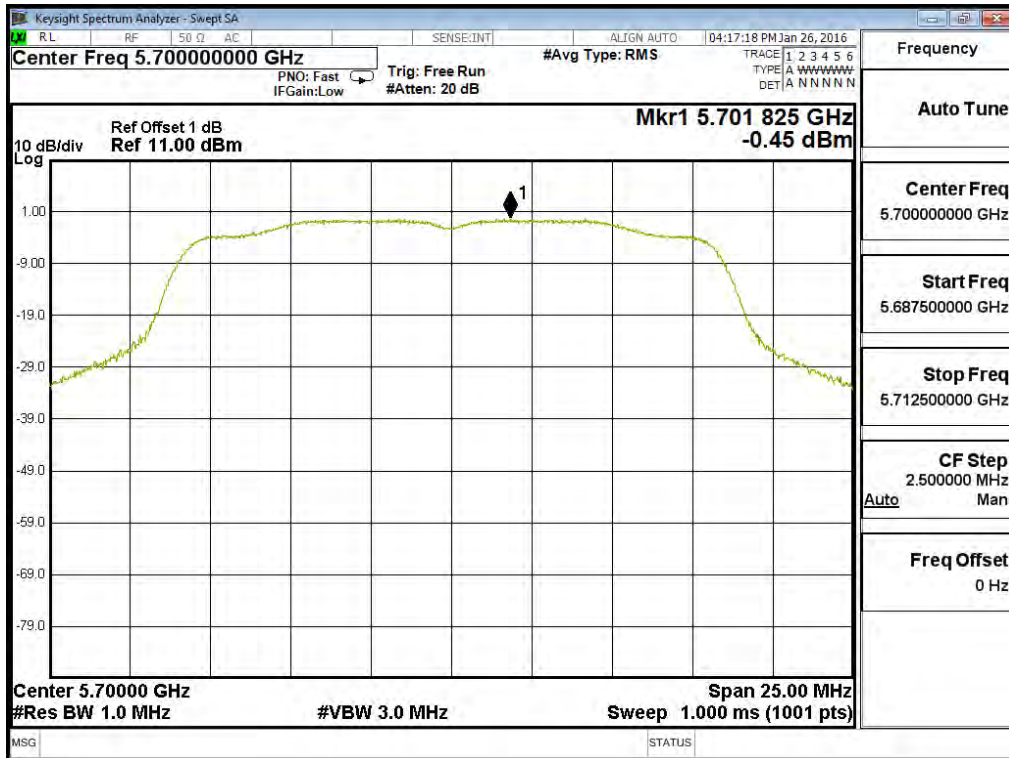

Channel 149

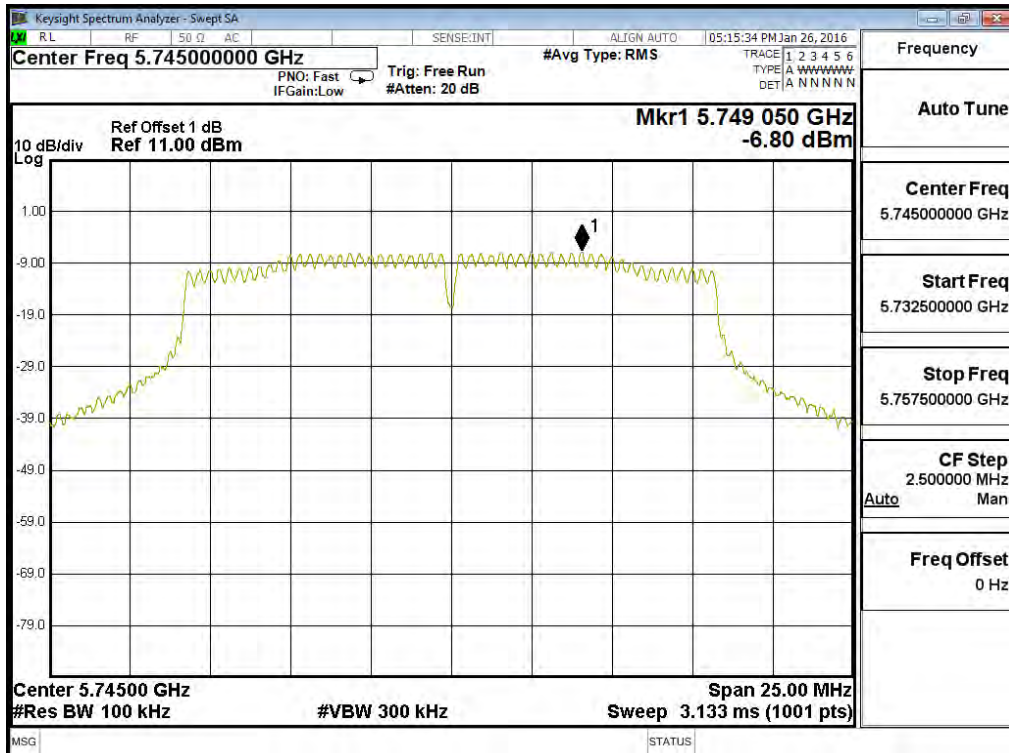

Channel 157

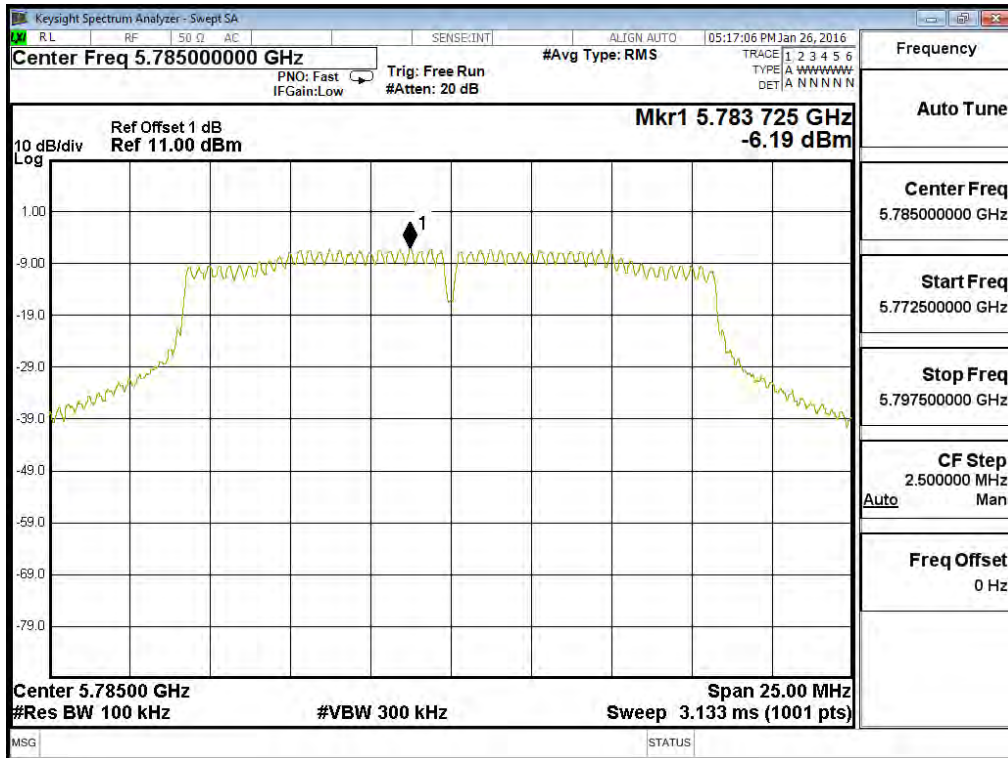

Channel 165

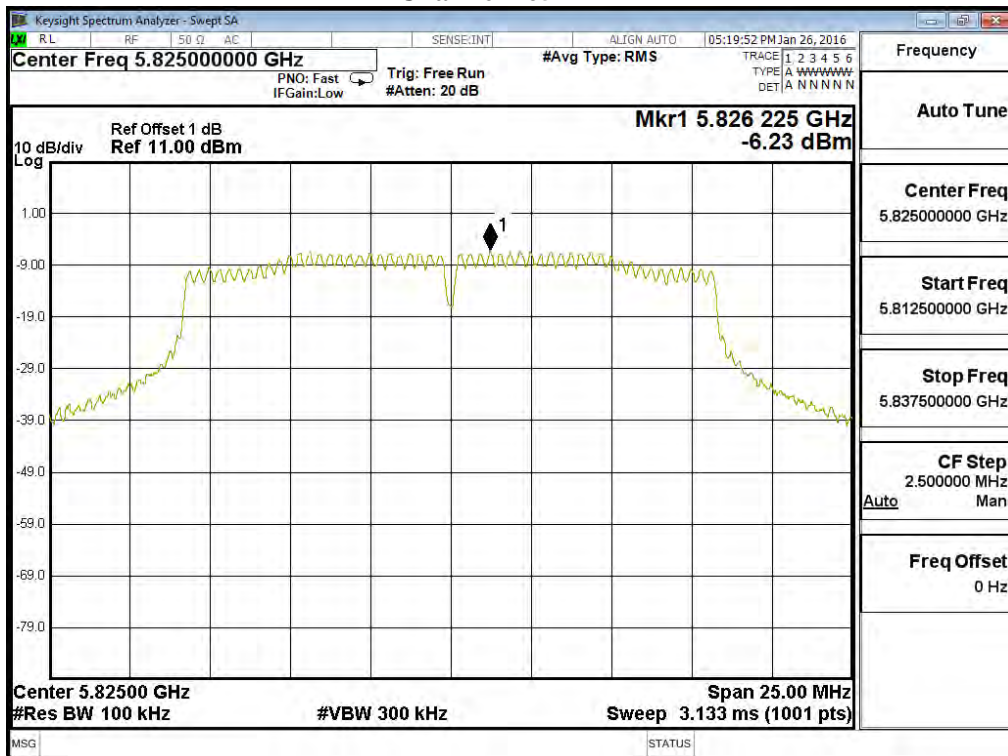

Product : Medical Cart Computer
 Test Item : Peak Power Spectral Density
 Test Site : No.3 OATS
 Test Mode : Mode 2: Transmit (802.11n-20BW 14.4Mbps) (19''+22''+24'')

Channel Number	Frequency (MHz)	Chain	PPSD (dBm)	Total PPSD (dBm)	Required Limit (dBm)	Result
36	5180	A	-3.740	-0.730	11	Pass
		B	-1.890	1.120	11	Pass
44	5220	A	-3.140	-0.130	11	Pass
		B	-1.900	1.110	11	Pass
48	5240	A	-3.030	-0.020	11	Pass
		B	-1.470	1.540	11	Pass
52	5260	A	-1.020	1.990	11	Pass
		B	0.060	3.070	11	Pass
60	5300	A	-1.200	1.810	11	Pass
		B	-0.540	2.470	11	Pass
64	5320	A	-2.910	0.100	11	Pass
		B	-2.520	0.490	11	Pass
100	5500	A	-3.820	-0.810	11	Pass
		B	-3.980	-0.970	11	Pass
116	5580	A	-1.200	1.810	11	Pass
		B	-1.690	1.320	11	Pass
140	5700	A	-3.670	-0.660	11	Pass
		B	-3.830	-0.820	11	Pass

Channel Number	Frequency (MHz)	Chain	PPSD (dBm)	BWCF (dB)	Total PPSD (dBm) ₁	Required Limit (dBm)	Result
149	5745	A	-10.220	6.980	-0.230	<30	Pass
		B	-10.500	6.980	-0.510	<30	Pass
157	5785	A	-9.980	6.980	0.010	<30	Pass
		B	-9.890	6.980	0.100	<30	Pass
165	5825	A	-9.410	6.980	0.580	<30	Pass
		B	-9.060	6.980	0.930	<30	Pass

Note: The quantity $10 \cdot \log 2$ (two antennas) is added to the spectrum peak value according to document 662911 D01.

Channel 36 – Chain A

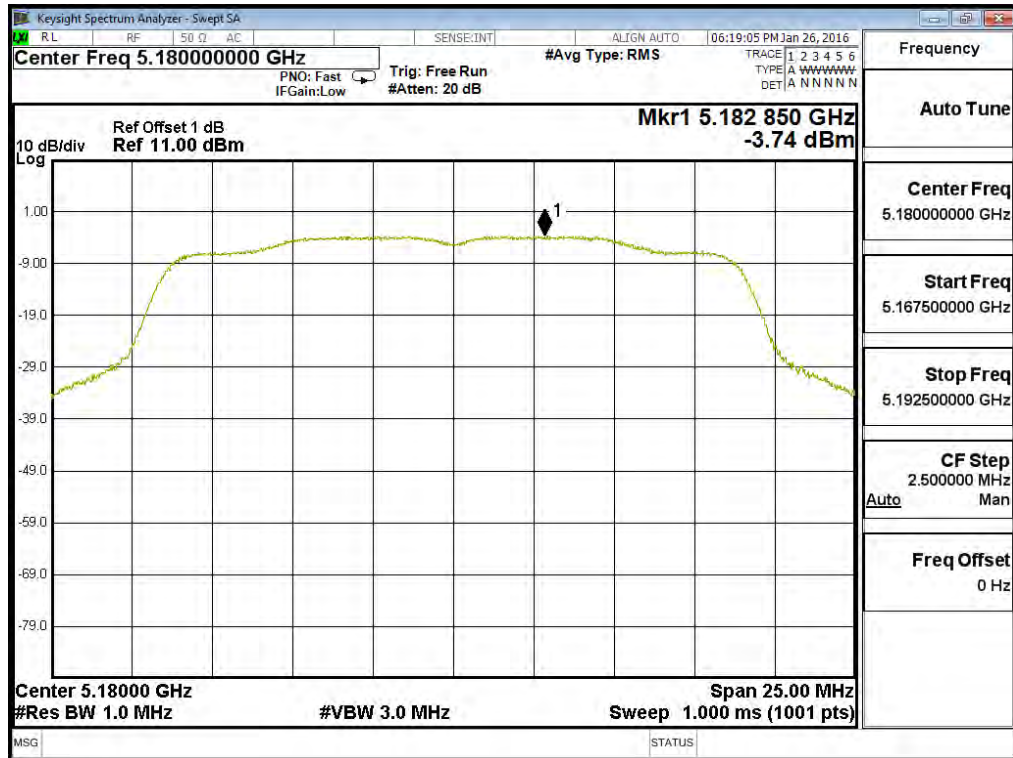

Channel 44 – Chain A

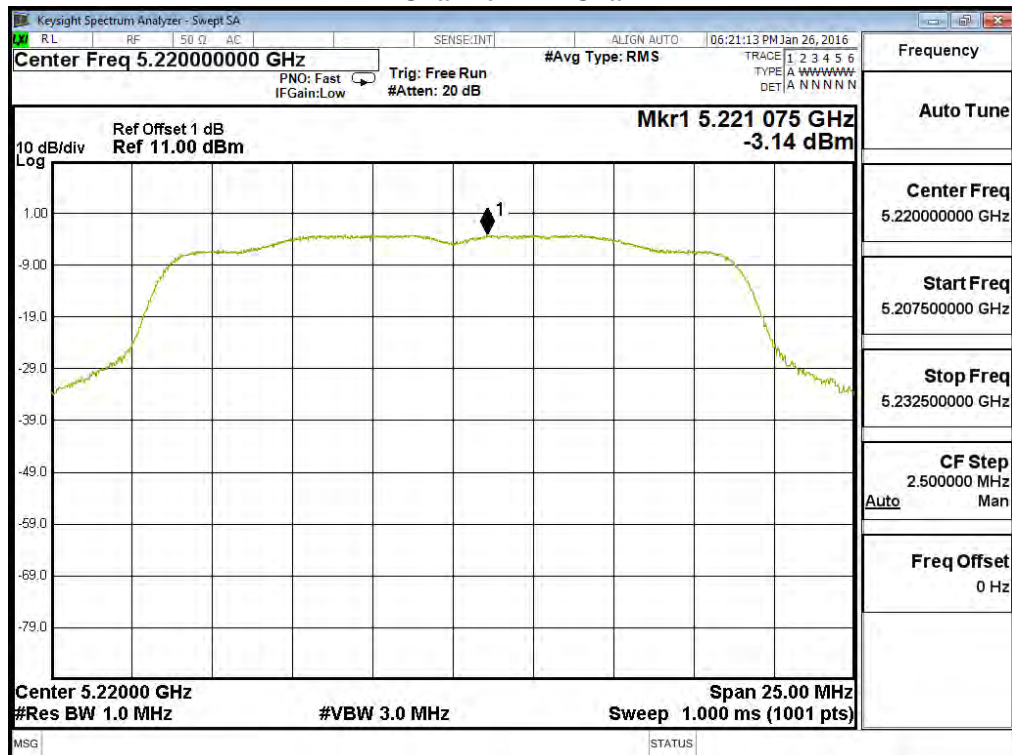

Channel 48 – Chain A

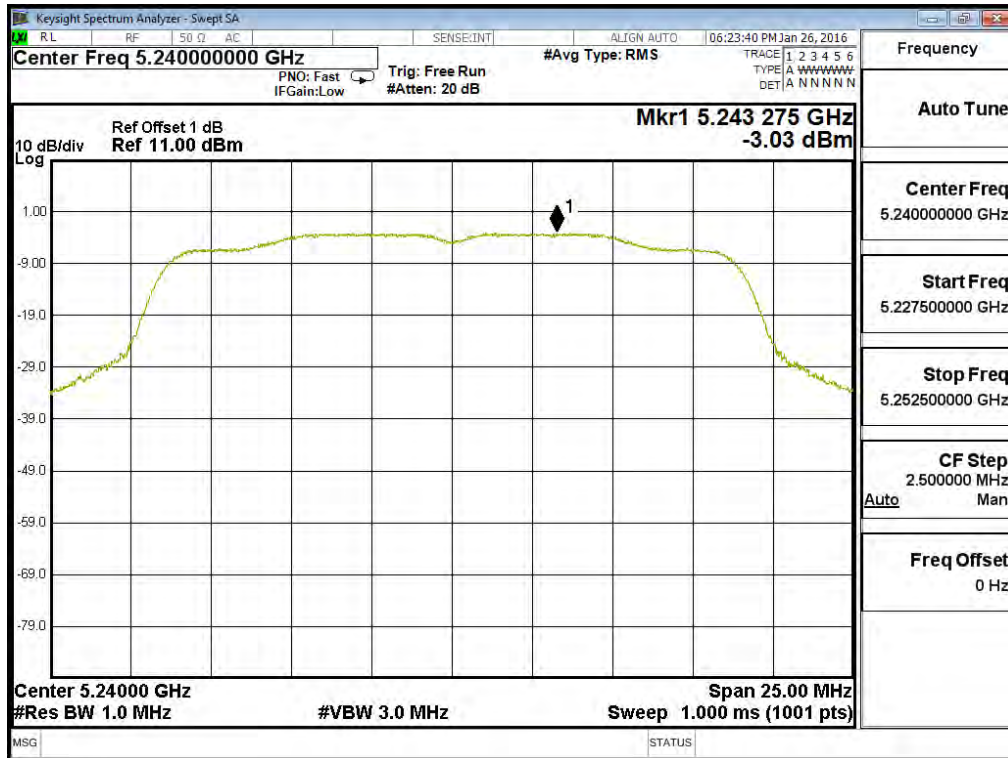

Channel 52 – Chain A

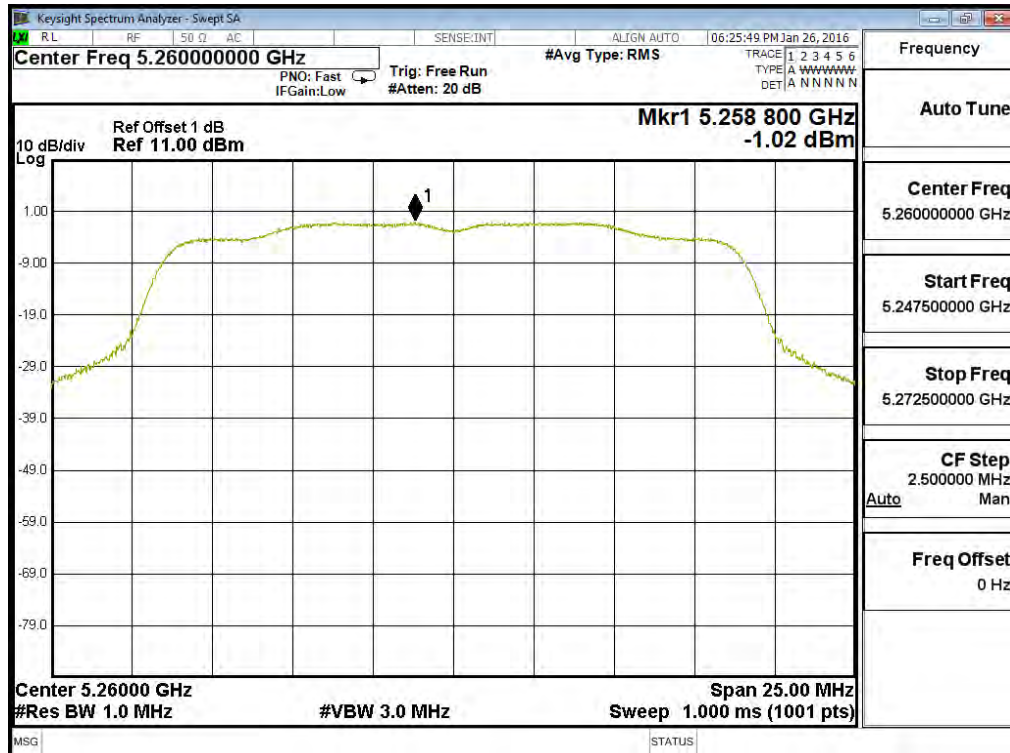

Channel 60 – Chain A

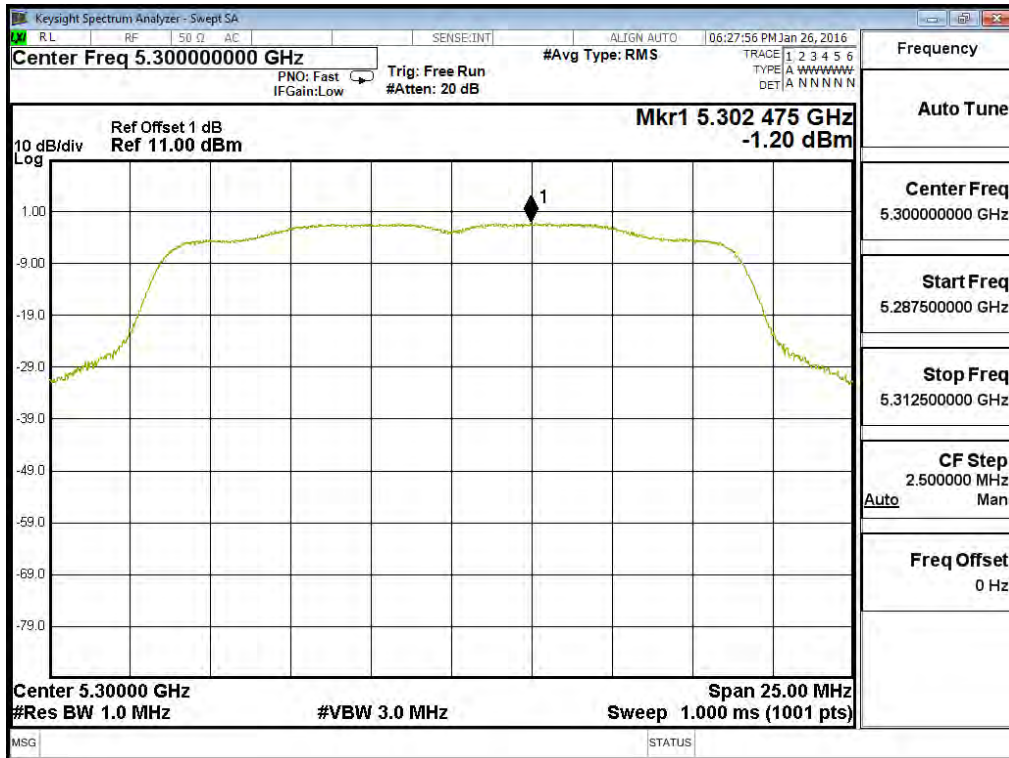

Channel 64 – Chain A

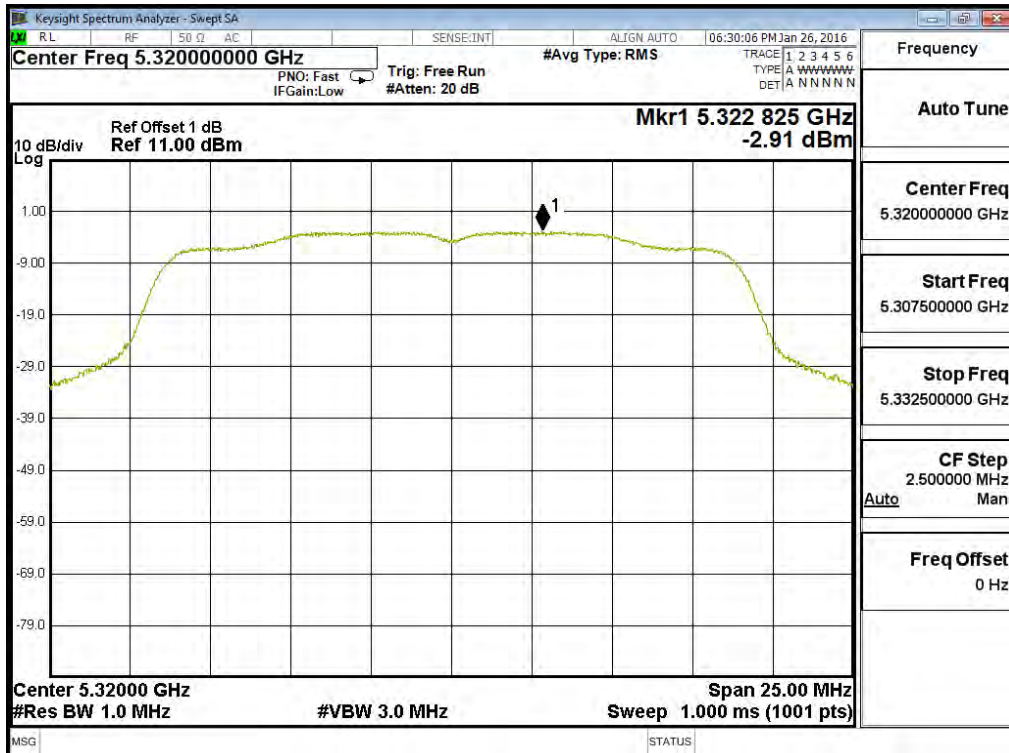

Channel 100 – Chain A

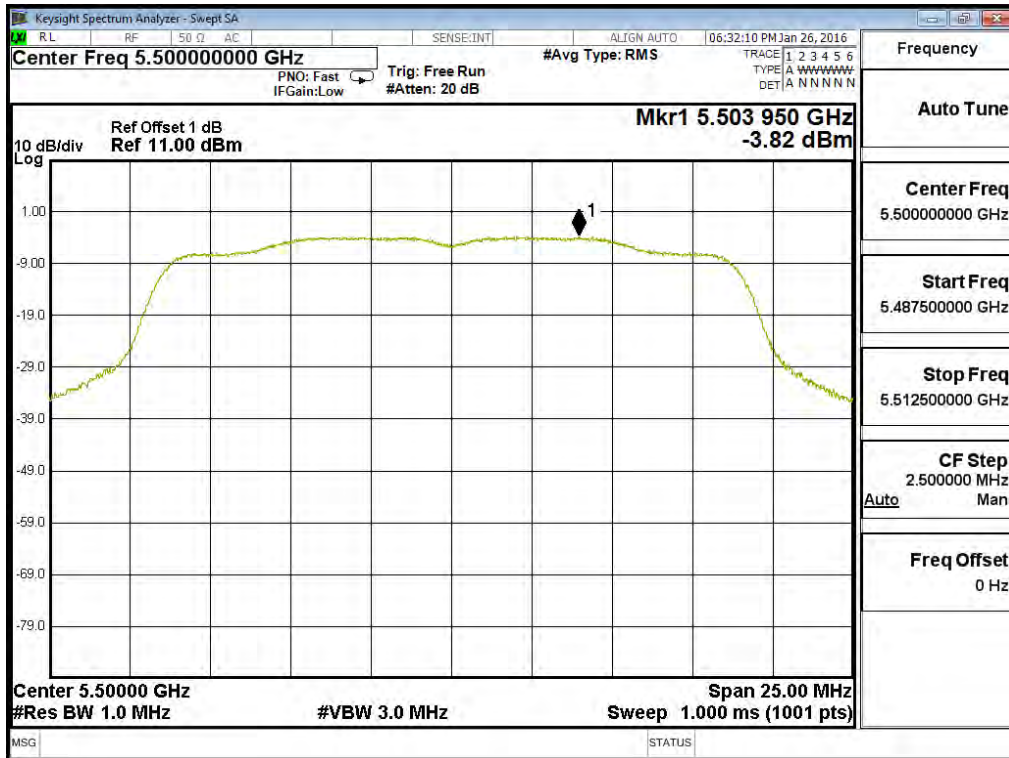

Channel 116 – Chain A

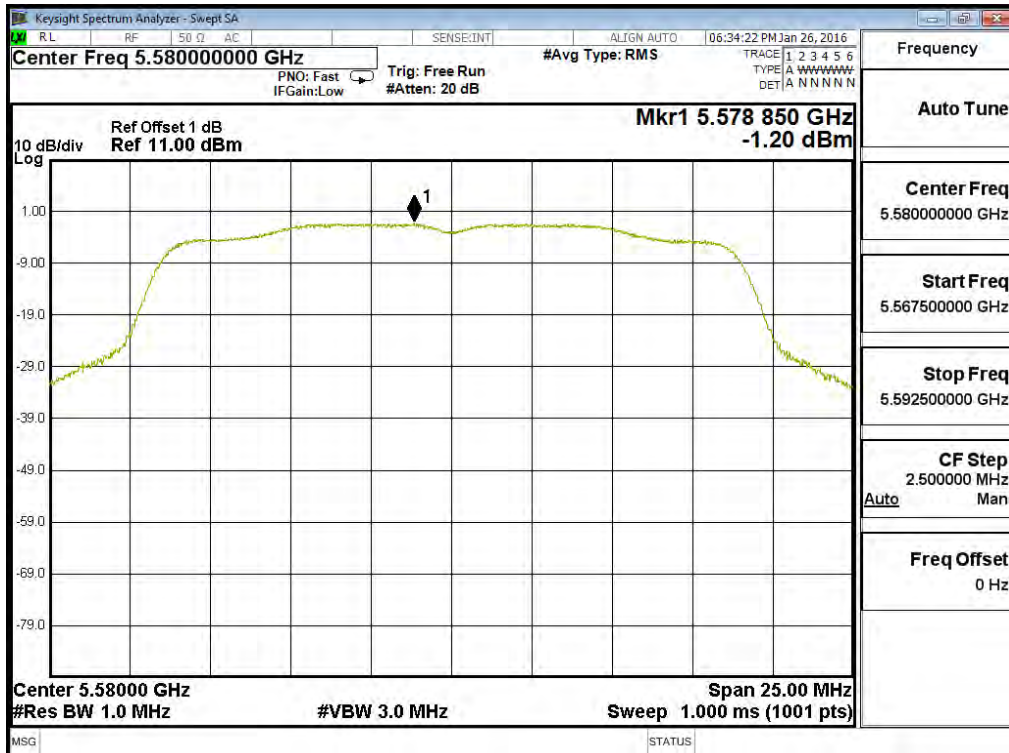

Channel 140 – Chain A

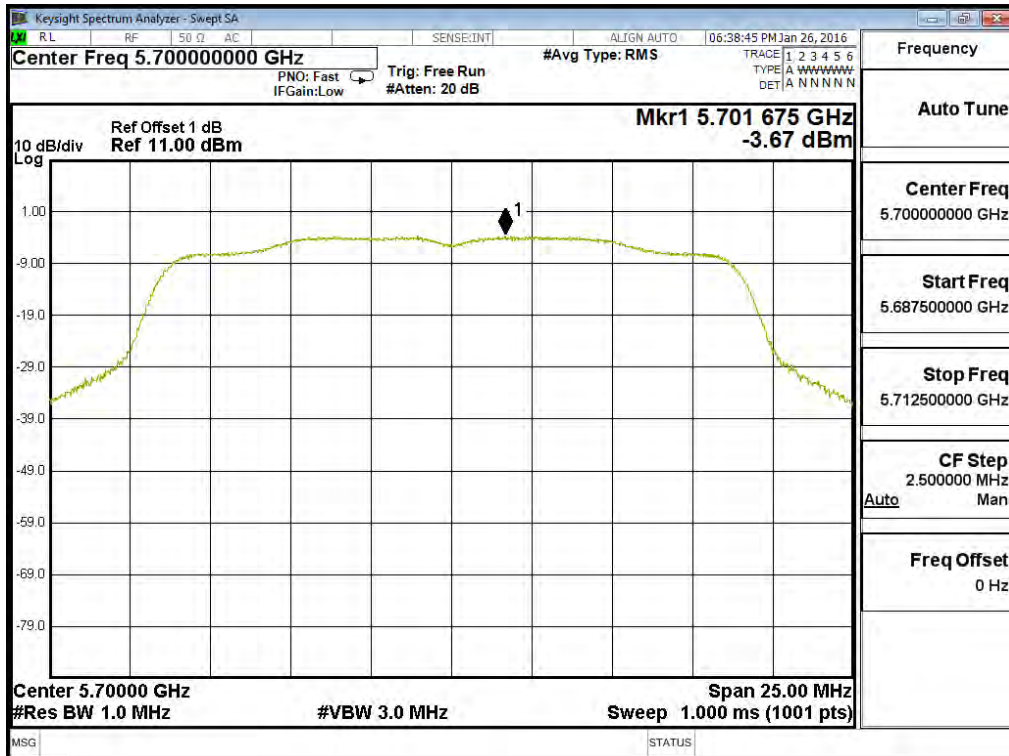

.Channel 149 – Chain A

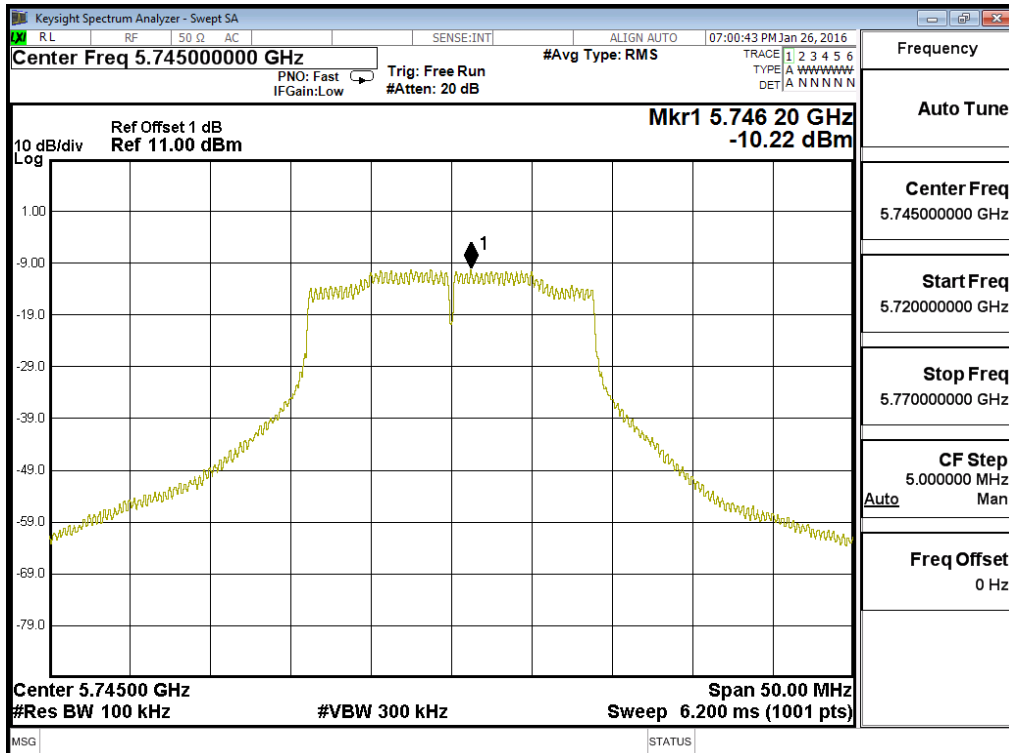

Channel 157 – Chain A

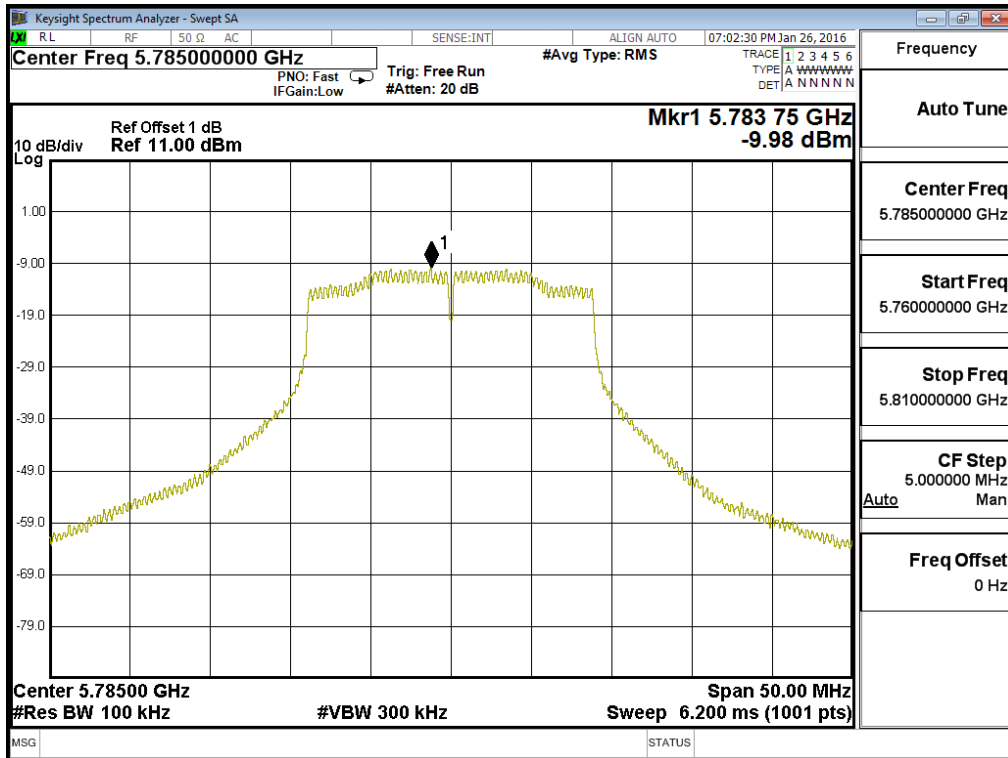

Channel 165 – Chain A

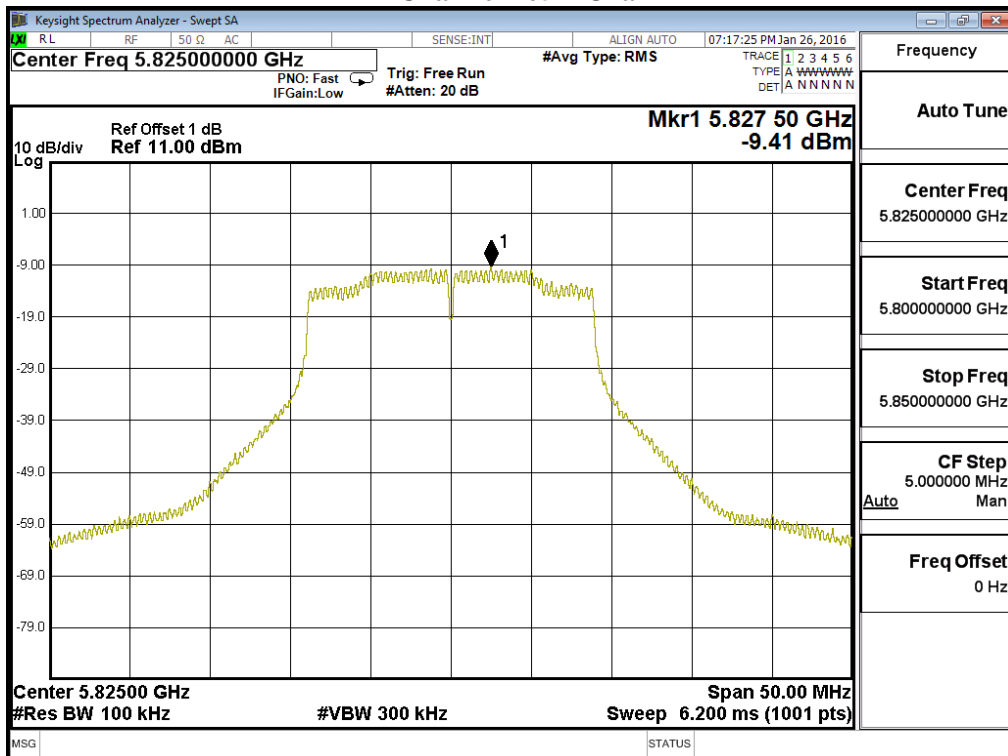

Channel 36 – Chain B

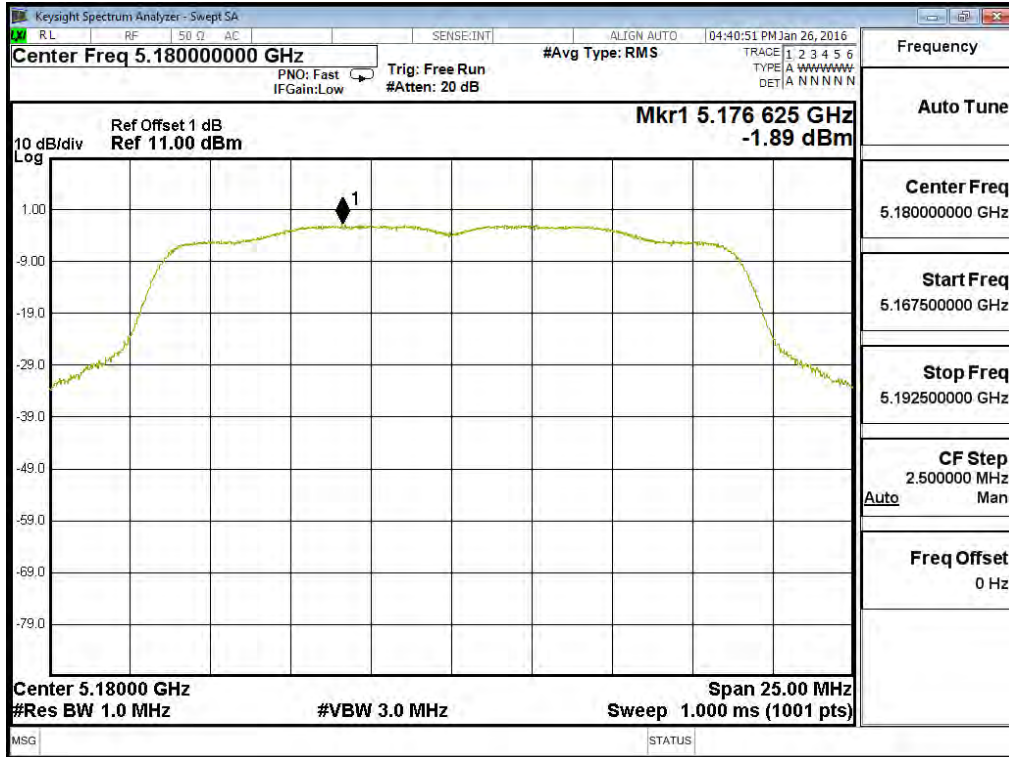

Channel 44 – Chain B

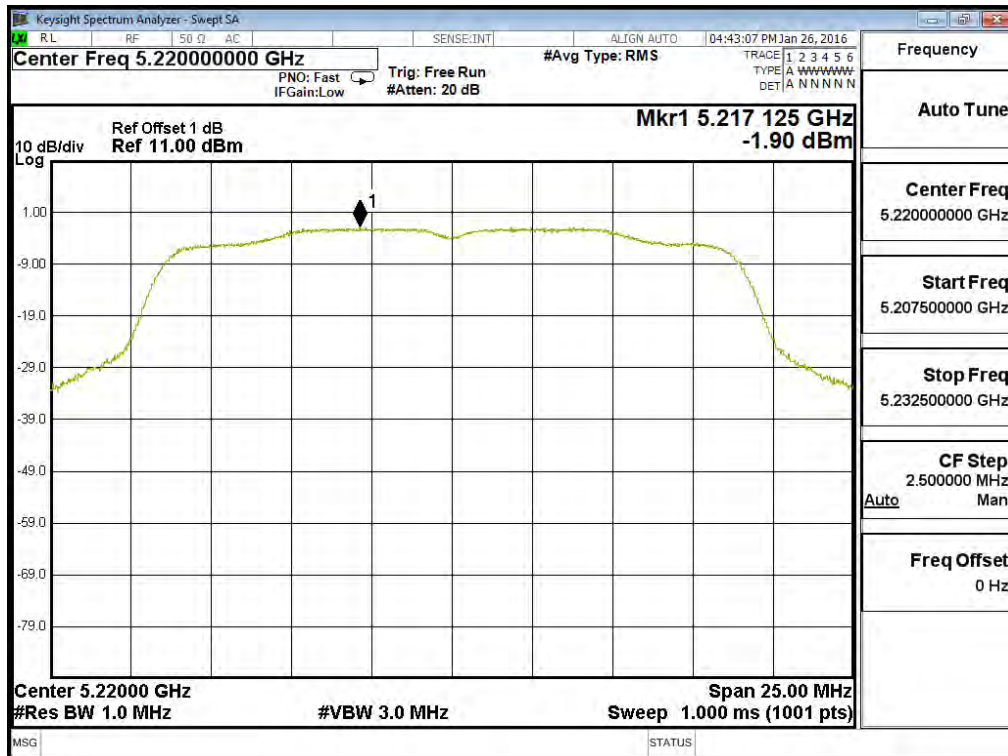

Channel 48 – Chain B

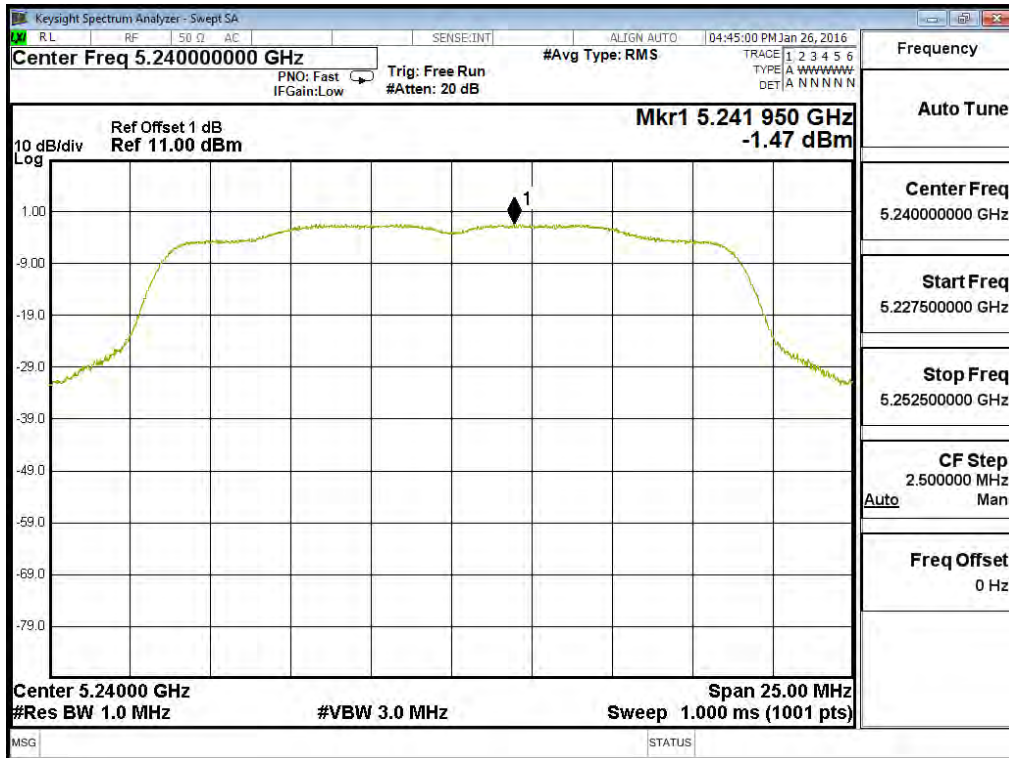

Channel 52 – Chain B

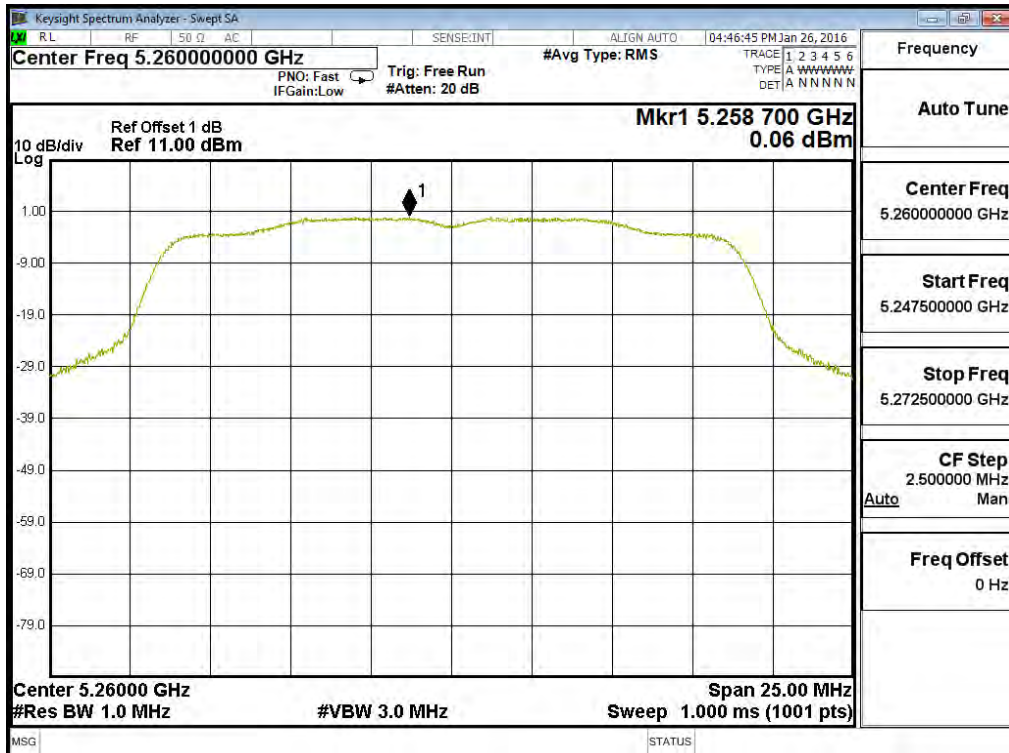

Channel 60 – Chain B

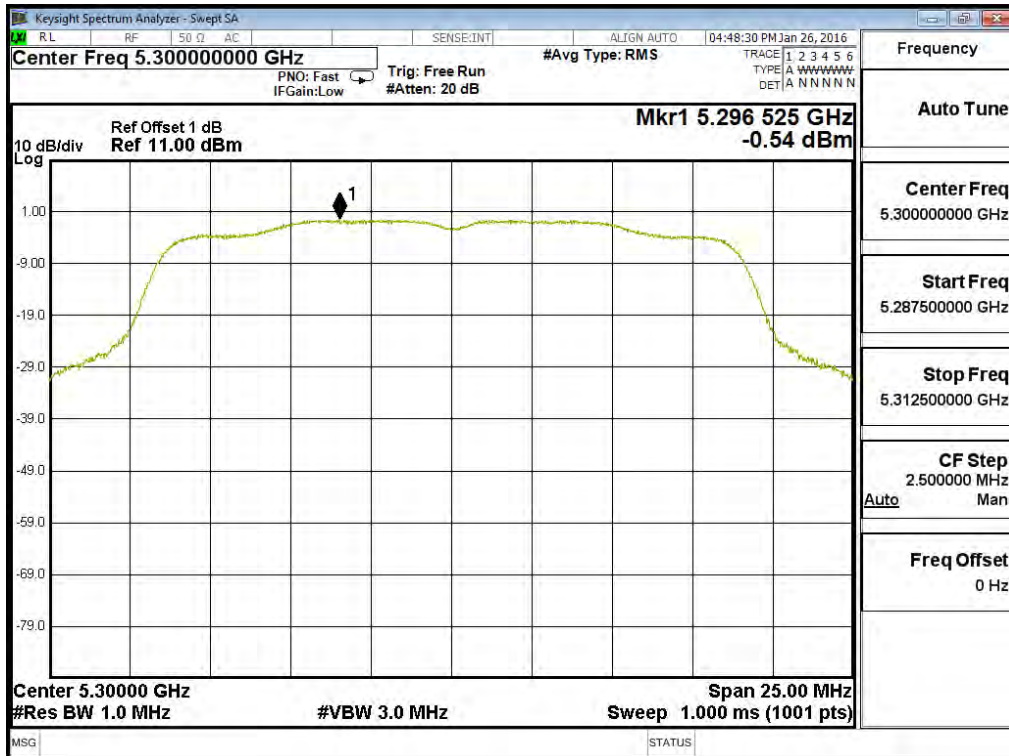

Channel 64 – Chain B

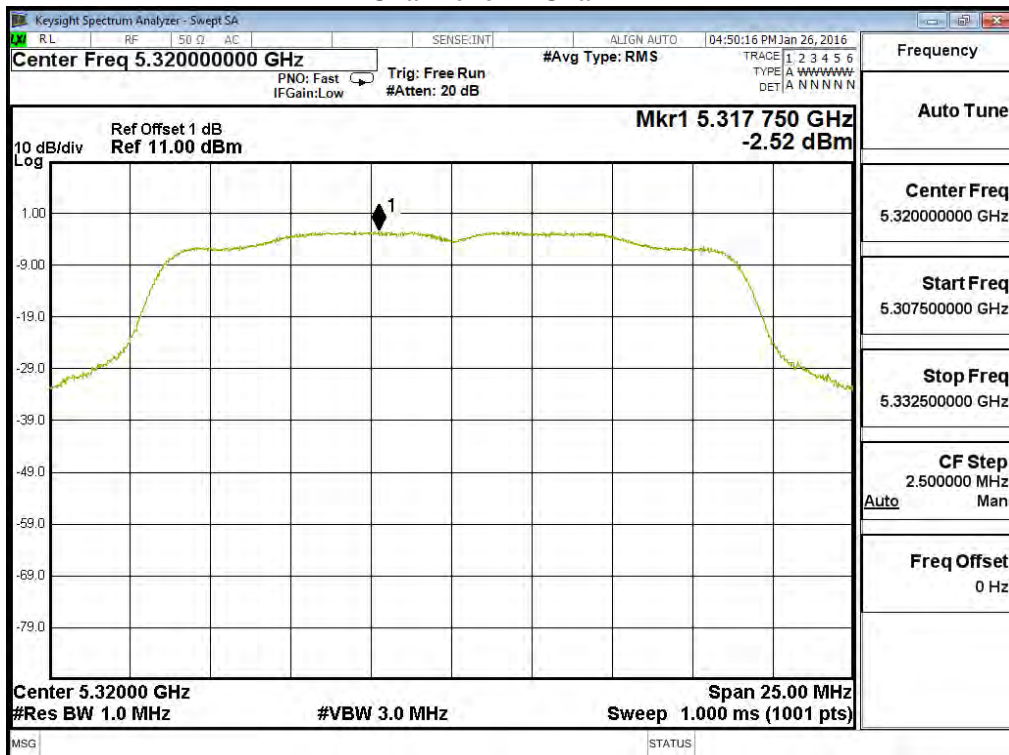

Channel 100 – Chain B

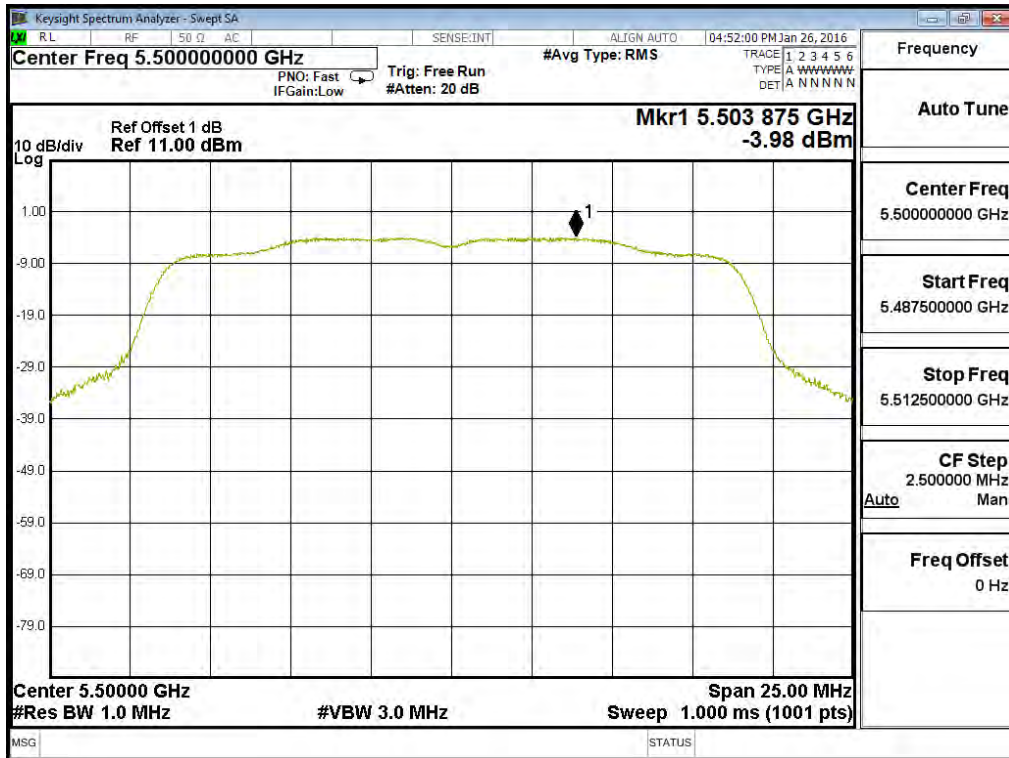

Channel 116 – Chain B

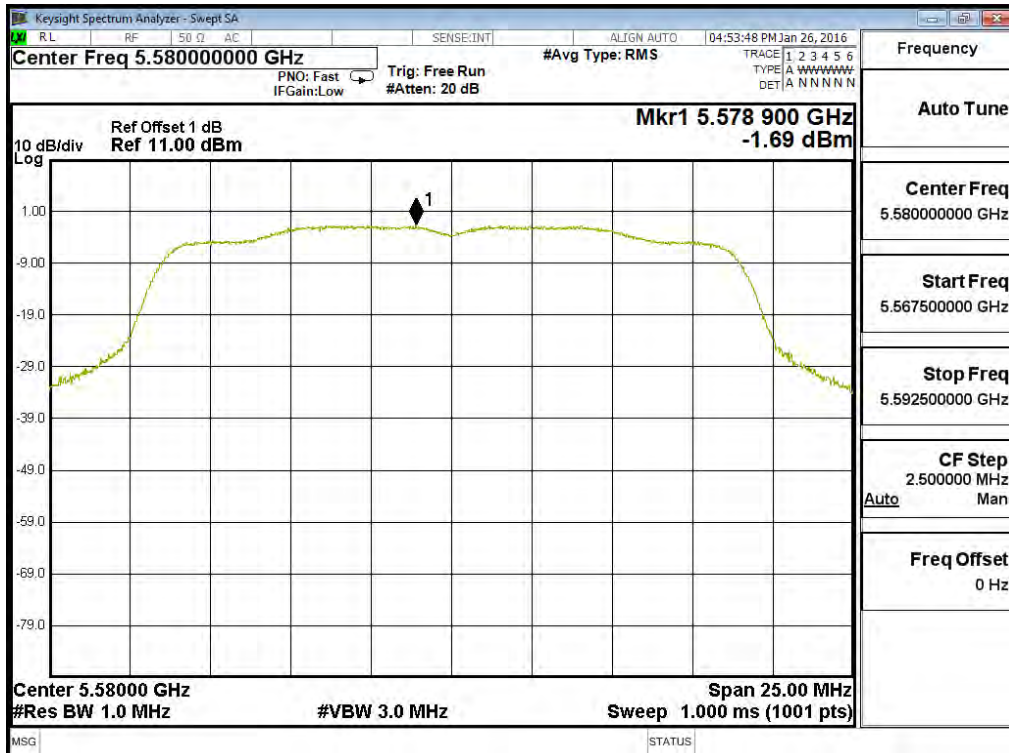

Channel 140 – Chain B

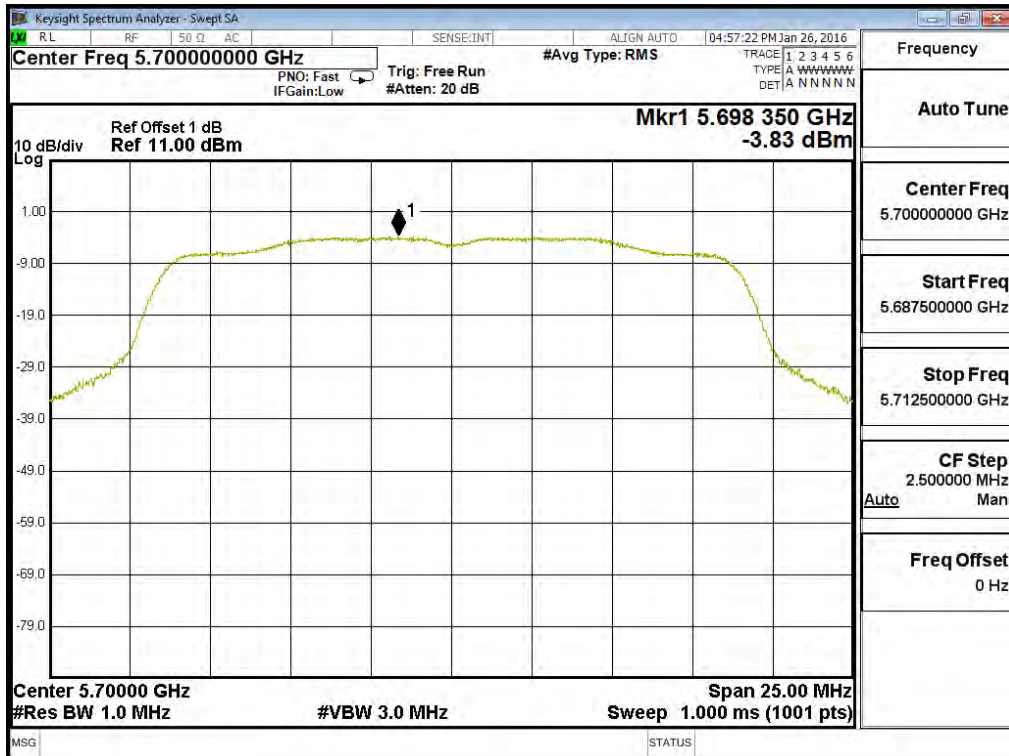

Channel 149 – Chain B

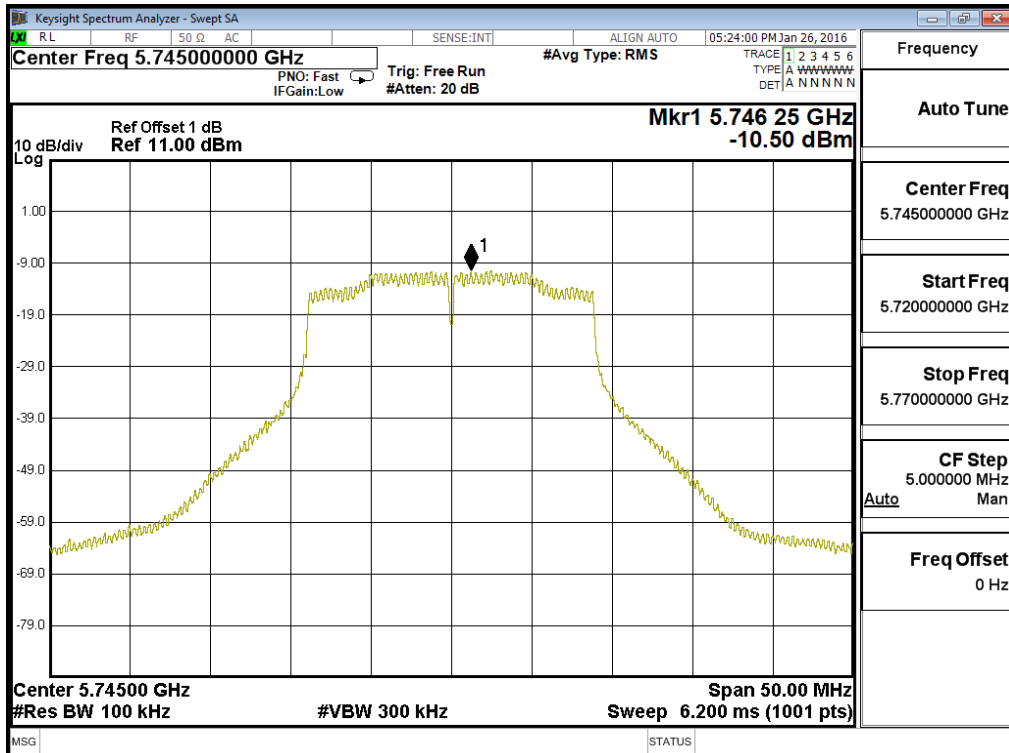

Channel 157 – Chain B

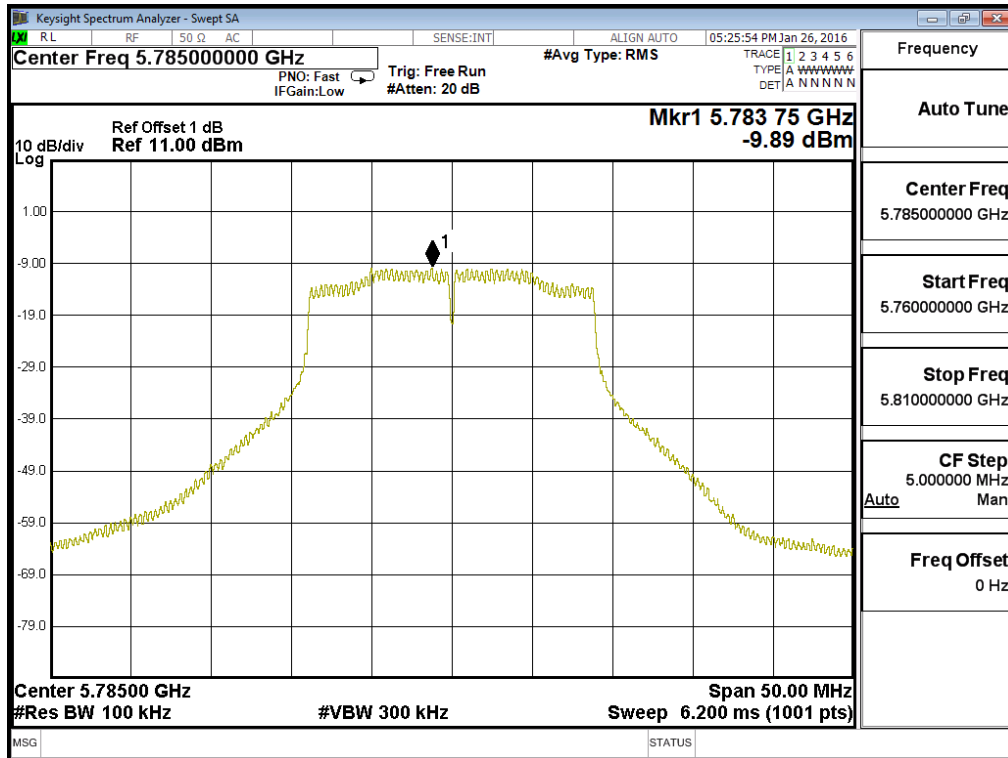

Channel 165 – Chain B

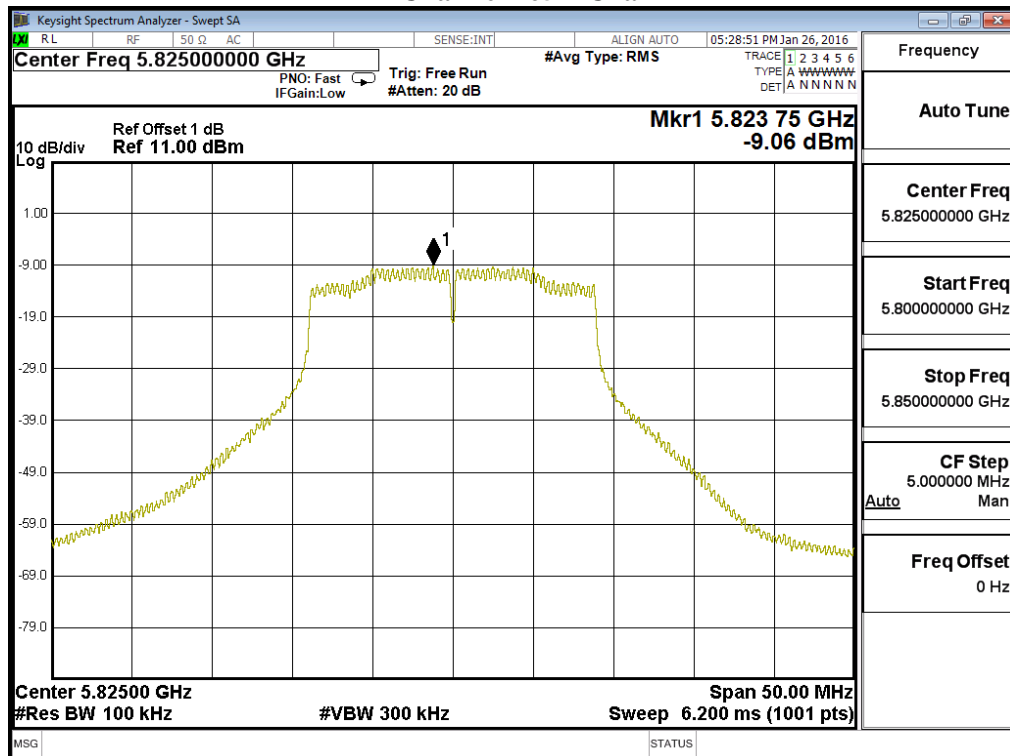

Product : Medical Cart Computer
 Test Item : Peak Power Spectral Density
 Test Site : No.3 OATS
 Test Mode : Mode 3: Transmit (802.11n-40BW 30Mbps) (19''+22''+24'')

Channel Number	Frequency (MHz)	Chain	PPSD (dBm)	Total PPSD (dBm) ¹	Required Limit (dBm)	Result
38	5190	A	-7.690	-4.680	11	Pass
		B	-6.650	-3.640	11	Pass
46	5230	A	-4.520	-1.510	11	Pass
		B	-3.140	-0.130	11	Pass
54	5270	A	-4.920	-1.910	11	Pass
		B	-3.600	-0.590	11	Pass
62	5310	A	-6.370	-3.360	11	Pass
		B	-5.650	-2.640	11	Pass
102	5510	A	-6.260	-3.250	11	Pass
		B	-6.910	-3.900	11	Pass
110	5550	A	-3.970	-0.960	11	Pass
		B	-4.420	-1.410	11	Pass
134	5670	A	-4.790	-1.780	11	Pass
		B	-4.380	-1.370	11	Pass

Channel Number	Frequency (MHz)	Chain	PPSD (dBm)	BWCF (dB)	Total PPSD (dBm) ¹	Required Limit (dBm)	Result
151	5755	A	-11.960	6.980	-1.970	<30	Pass
		B	-12.330	6.980	-2.340	<30	Pass
159	5795	A	-12.330	6.980	-2.340	<30	Pass
		B	-12.230	6.980	-2.240	<30	Pass

Note: The quantity 10*log 2 (two antennas) is added to the spectrum peak value according to document 662911 D01.

Channel 38 – Chain A

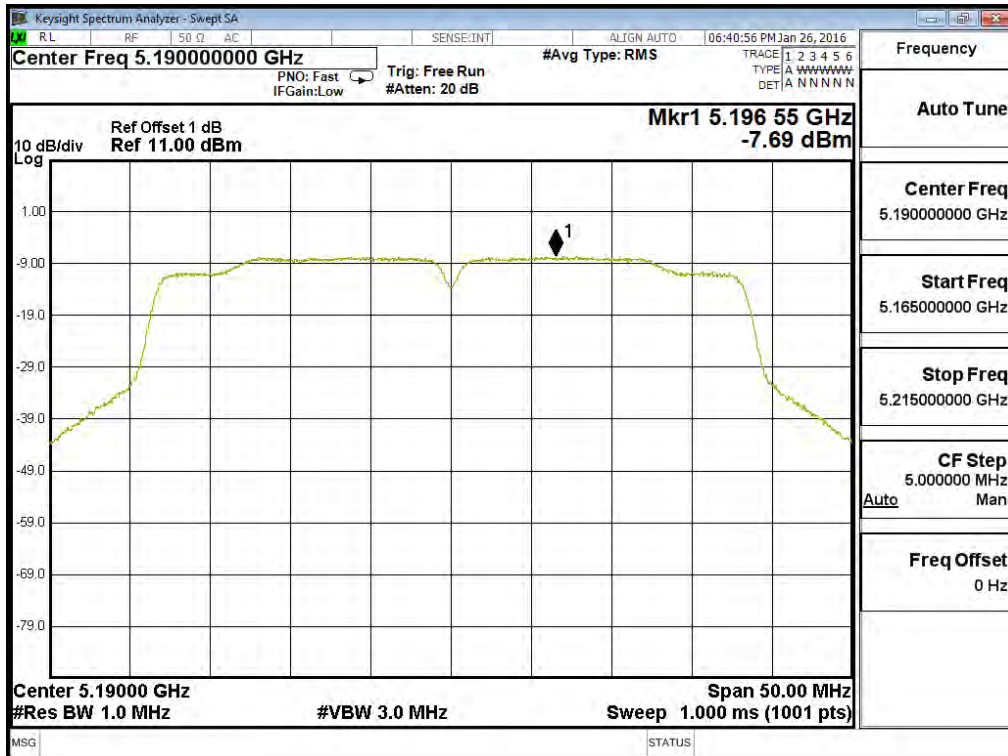

Channel 46 – Chain A

